

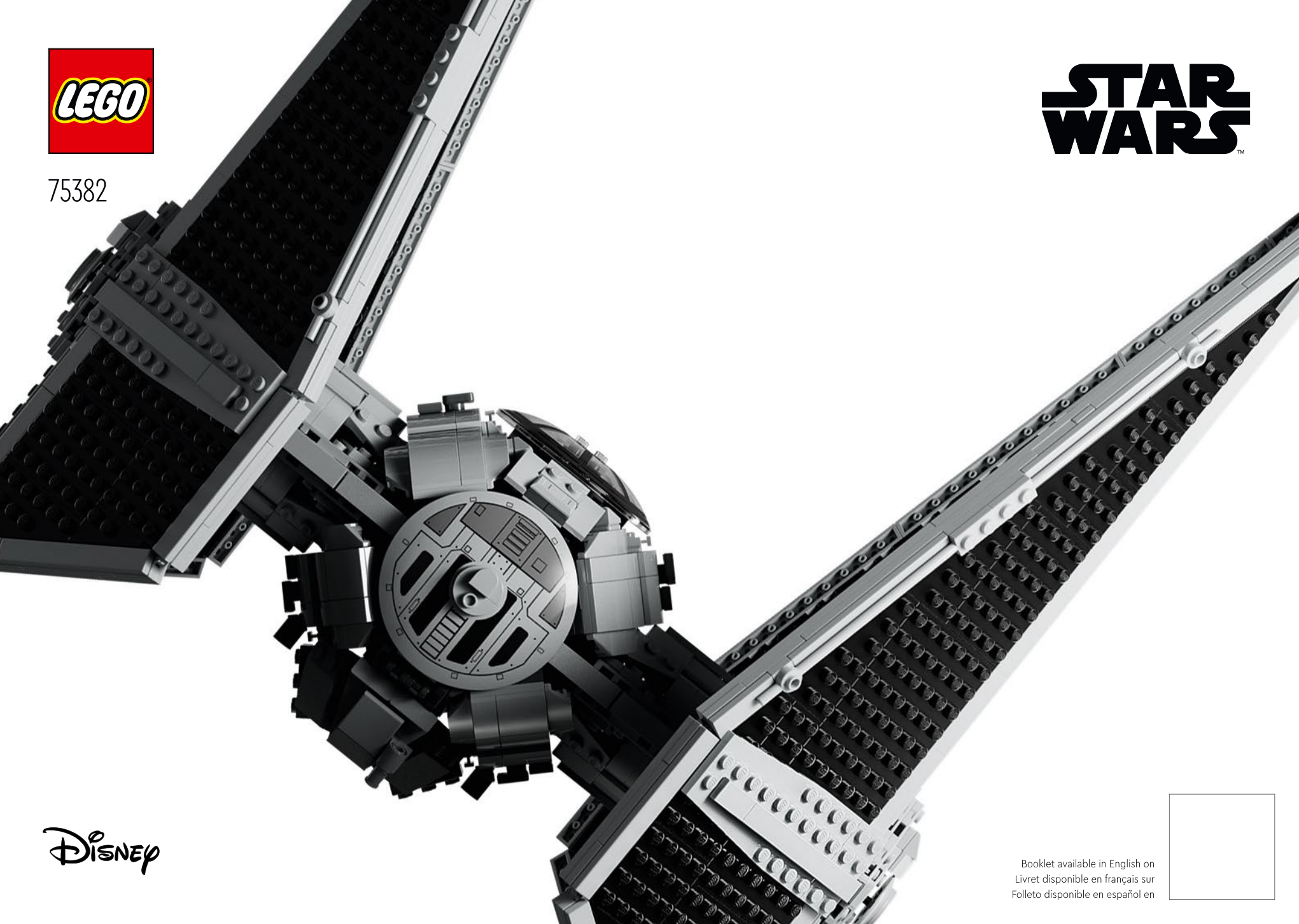

75382

**STAR  
WARS**<sup>™</sup>



**Disney**

Booklet available in English on  
Livret disponible en français sur  
Folleto disponible en español en

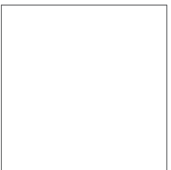



## WE'RE MAKING OUR PACKAGING MORE SUSTAINABLE

We're transitioning from single-use plastic to paper-based packaging. As we progress, you may find a mix of paper and plastic in our boxes.

## NOUS RENDONS NOS EMBALLAGES PLUS DURABLES

Nous passons des emballages en plastique à usage unique aux emballages à base de papier. Durant la transition, vous pourriez trouver un mélange de papier et de plastique dans nos boîtes.

## QUEREMOS HACER MÁS SUSTENTABLES NUESTROS MATERIALES DE EMBALAJE

Estamos cambiando las bolsas de plástico desechables por bolsas con base de papel. Conforme avanzamos en este propósito, puedes encontrar una mezcla de papel y de plástico en nuestras cajas.

[LEGO.com/sustainable-packaging](https://LEGO.com/sustainable-packaging)





# BUILDER



Apple and the Apple logo are trademarks of Apple Inc., registered in the U.S. and other countries and regions. App Store is a service mark of Apple Inc. Google Play and the Google Play logo are trademarks of Google LLC. Tencent and the Tencent logo are trademarks of Tencent Inc.

LEGO.com/devicecheck



LEGO® Builder



# A RARE GEM IN THE ULTIMATE COLLECTOR SERIES

When the first *Star Wars* movies were released, fans were awestruck by the high level of detail and authentic looks of the starship fleets in this intriguing galaxy. Rugged or pristine, they often have as much personality as the live characters. Ever since the first LEGO® *Star Wars*™ sets were released in 1999, we have shared that love of the saga with fans of all ages and recreated its starships and vehicles in various scales. Rebel or Imperial, we keep every set as authentic-looking and detailed as possible.

The TIE Interceptor, infamous for its role in the Battle of Endor, was released as part of our first Ultimate Collector Series in 2000. It became an instant fan favorite. To celebrate our 25<sup>th</sup> anniversary, we're relaunching it in a new and even more detailed version.

Enjoy building!



**Jens Kronvold Frederiksen**  
Creative Director, LEGO® *Star Wars*™





## UNE PERLE RARE DANS LA SÉRIE DE COLLECTION SUPRÊME

À la sortie des premiers films de *Star Wars*, les amateurs ont été époustoufflés par le niveau de détail et d'authenticité des flottes de vaisseaux de cette galaxie fascinante. Robustes ou immaculés, ils ont souvent autant de personnalité que les personnages vivants. Depuis le lancement des premiers ensembles LEGO® *Star Wars*™ en 1999, nous avons partagé cet amour de la saga avec des passionnés de tous âges et recréé ses vaisseaux et ses véhicules à différentes échelles. Qu'il s'agisse des forces rebelles ou impériales, nous veillons à ce que chaque ensemble soit aussi authentique et détaillé que possible.

L'intercepteur TIE, célèbre pour son rôle dans la bataille d'Endor, a été lancé dans le cadre de notre première Série de collection suprême en 2000. Il a immédiatement conquis les amateurs. Pour célébrer notre 25<sup>e</sup> anniversaire, nous le relançons dans une nouvelle version encore plus détaillée.

Bonne construction !



**Jens Kronvold Frederiksen**  
Directeur de la création, LEGO® *Star Wars*™

## UNA RARA GEMA DE LA SERIE ULTIMATE COLLECTOR SERIES

Cuando se estrenaron las primeras películas de *Star Wars*, los fans quedaron sorprendidos por el gran nivel de detalle y el auténtico aspecto de las flotas de naves espaciales de esta enigmática galaxia. Desgastadas o impecables, con frecuencia tienen tanta personalidad como los personajes vivos. Desde el lanzamiento de los primeros sets LEGO® *Star Wars*™ en 1999, hemos compartido ese amor por la saga con fans de todas las edades, recreando sus naves espaciales y vehículos en diversas escalas. Ya sean rebeldes o imperiales, mantenemos el realismo de la apariencia y los detalles de cada set tanto como resulta técnicamente posible.

El Interceptor TIE, tristemente célebre por su papel en la batalla de Endor, salió a la venta como parte de la primera generación de sets de nuestra colección Ultimate Collector Series en 2000 y, de inmediato, se convirtió en un favorito de los fans. Para celebrar nuestro 25 aniversario, decidimos relanzarlo en una nueva versión aún más detallada.

¡Que disfrutes construyendo!



**Jens Kronvold Frederiksen**  
Coordinador creativo, LEGO® *Star Wars*™

# THE TIE INTERCEPTOR

Size matters not when it comes to the TIE Interceptor. At 7.7 meters/25 ft. 3 in., it is designed for maximum speed and agility in battle. Originally employed by Palpatine's Galactic Empire, the Interceptor is faster and more maneuverable than other TIE fighters of its time. A new dagger-shaped wing design with large solar panel areas provides the necessary additional power for the large twin ion engines. To enhance performance in battle, Imperial designers increased firepower with four Siemar Fleet Systems L-s9.3 laser cannons and mounts for optional extra laser cannons.

While the TIE Interceptor boasts impressive armament and power, other essential design features had lower priority. With no hyperdrive system, minimal armor and no deflector shield, its strength lies in numbers – and the skills of its pilots. During the Battle of Endor, a swarm of TIE Interceptors proved a formidable fleet for the Rebellion's A-wings in particular.

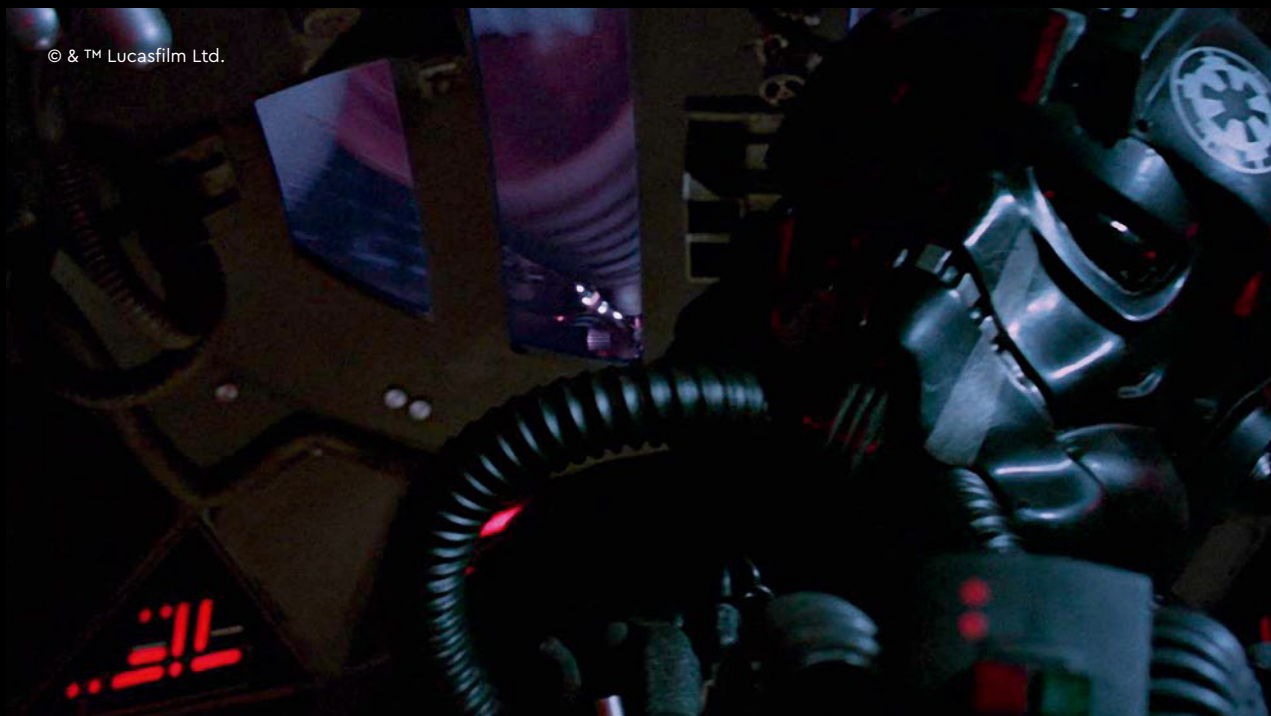
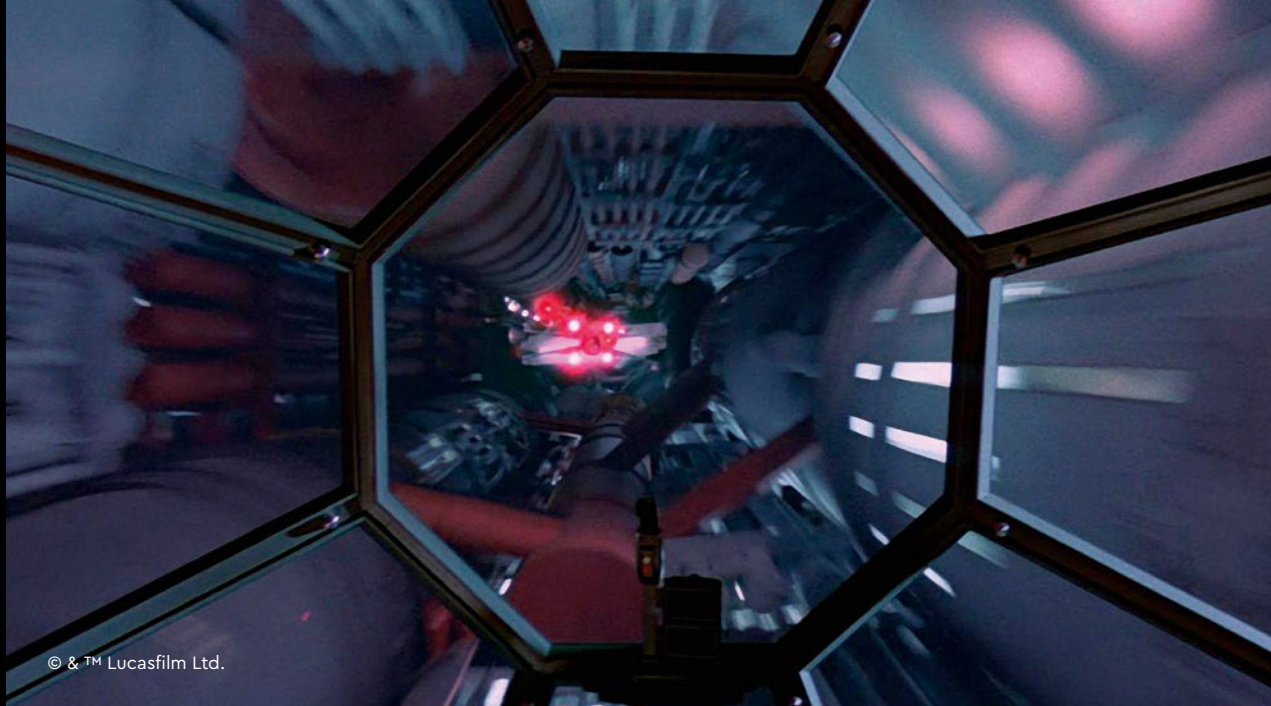
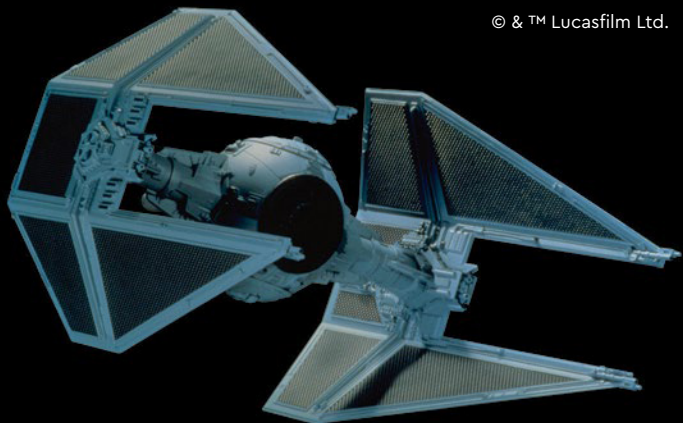



# L'INTERCEPTEUR TIE

Lorsqu'il est question de l'intercepteur TIE, la taille n'a pas d'importance. D'une longueur de 7,7 mètres, il est conçu pour offrir une vitesse et une agilité maximales au combat. Utilisé à l'origine par l'Empire galactique de Palpatine, l'intercepteur est plus rapide et plus maniable que les autres chasseurs TIE de l'époque. La nouvelle conception des ailes, avec de grands panneaux solaires pointus, fournit l'énergie supplémentaire nécessaire aux doubles moteurs ioniques. Pour une meilleure performance au combat, les concepteurs impériaux ont augmenté la puissance de feu avec quatre canons laser L-s9.3 conçus par les Systèmes de Flotte Sienar et des supports pour des canons laser supplémentaires.

L'intercepteur TIE est doté d'un armement et d'une puissance impressionnants, mais d'autres caractéristiques essentielles ont été sacrifiées. Avec un blindage minimal et sans hyperpropulseur ni bouclier déflecteur, l'intercepteur tire sa force dans le nombre ainsi que dans les compétences de ses pilotes. Lors de la bataille d'Endor, une nuée d'intercepteurs TIE s'est révélée être une flotte redoutable, particulièrement pour les chasseurs A-Wing de la Rébellion.

# EL INTERCEPTOR TIE

El tamaño no importa cuando se trata del Interceptor TIE. Con una longitud de 7,7 m, está diseñado para ser extremadamente veloz y maniobrable en combate. Utilizado originalmente por el Imperio Galáctico de Palpatine, el Interceptor supera en rapidez y agilidad a otros cazas TIE de su época. El novedoso diseño de las alas, con forma de daga y amplias zonas de celdas solares, proporciona la energía adicional necesaria para impulsar los grandes motores de iones gemelos. Para mejorar su desempeño en combate, los diseñadores del Imperio aumentaron su potencia de fuego con cuatro cañones láser L-s9.3 fabricados por Sistemas de Flota Sienar y soportes para cañones láser adicionales opcionales.

Si bien el Interceptor TIE destaca por su impresionante armamento y potencia, también es notable la poca prioridad que se dio a otras características esenciales en su diseño. Desprovisto de un sistema hiperpropulsor y escudo deflector, y con un blindaje mínimo, su fuerza reside en la superioridad numérica y la habilidad de sus pilotos. Durante la batalla de Endor, un enjambre de Interceptores TIE demostró ser una flota formidable, sobre todo frente a los A-wing de la Rebelión.

© & ™ Lucasfilm Ltd.



R. Young 97

# MEET THE MODEL DESIGNER

"In 1999, I began working on what would become the first LEGO® Star Wars™ Ultimate Collector Series version of the TIE Interceptor. This model is a redesigned version of the starship, hopefully with equal parts authenticity and engaging design, wrapped in a fun building experience!"

"The Interceptor's design and story are quite unique. If the Empire had not fallen in the Battle of Endor, this would have been the mass-produced successor to Darth Vader's TIE Advanced x1 prototype. The cutaway wing design means that (at least in the movie version), the starship is lighter and more aerodynamic. The pilot's lateral vision is improved compared to previous TIE models, giving the Imperial Navy an edge in star battles against the Rebels."

"The model is mounted on a stand with a 25<sup>th</sup>-anniversary plaque. The TIE Pilot minifigure with a new arm print is exclusive to this set. The miniature brick-built Mouse Droid is one we often see in Imperial and First Order hangars, bases and starships."



Design Master Henrik Andersen's first LEGO® Star Wars™ TIE Interceptor (7181) from 2000, and the new model (75382)  
Le premier intercepteur TIE LEGO® Star Wars™ (7181) du maître concepteur Henrik Andersen en 2000, ainsi que le nouveau modèle (75382)  
El primer Interceptor TIE (7181) LEGO® Star Wars™ creado por el maestro de diseño Henrik Andersen en 2000 y el nuevo modelo (75382).

**Henrik Andersen,**  
LEGO® Star Wars™  
Design Master





## RENCONTRE AVEC LE CONCEPTEUR DU MODÈLE

« En 1999, j'ai commencé à travailler sur ce qui allait devenir la première version LEGO® Star Wars™ Série de collection suprême de l'intercepteur TIE. Ce modèle est une version redessinée du vaisseau, offrant à la fois authenticité et conception attrayante pour une expérience de construction gratifiante.

La conception et l'histoire de l'intercepteur sont tout à fait uniques. Si l'Empire n'était pas tombé lors de la bataille d'Endor, ce modèle aurait été le successeur en série du prototype TIE Avancé x1 de Darth Vader. La conception des ailes en coupe signifie que le vaisseau est plus léger et plus aérodynamique (du moins dans la version cinématographique). La vision latérale du pilote est améliorée par rapport aux modèles de TIE précédents, ce qui donne à la marine impériale un avantage dans les batailles stellaires contre les Rebelles.

Le modèle est monté sur un socle avec une plaque du 25<sup>e</sup> anniversaire. La figurine de pilote de TIE avec un nouveau bras imprimé est exclusive à cet ensemble. Le petit droïde souris est souvent aperçu dans les hangars, les bases et les vaisseaux de l'Empire et du Premier Ordre. »

**Henrik Andersen,**  
maître concepteur  
LEGO® Star Wars™

## CONOCE AL MODELISTA

"Fue en 1999 cuando empecé a trabajar en lo que se convertiría en la primera versión LEGO® Star Wars™ Ultimate Collector Series del Interceptor TIE. Espero que este modelo rediseñado de la icónica nave espacial logre reproducir la autenticidad y el atractivo del primer set, así como su divertida experiencia de construcción!".

"El diseño y la historia del Interceptor son muy singulares en muchos sentidos. Si el Imperio no hubiera caído en la batalla de Endor, este habría sido el sucesor producido en serie del TIE Avanzado X1, cuyo prototipo puso a prueba el mismísimo Darth Vader. El diseño con alas cortadas hace que la nave espacial (al menos la versión que pudimos ver en la pantalla grande) sea más ligera y aerodinámica. La visión lateral del piloto mejora en comparación con los modelos anteriores del caza TIE, lo que da a la Naval Imperial una ventaja en las batallas espaciales contra los rebeldes".

"El modelo se monta sobre una base con una placa conmemorativa del 25 aniversario. La minifigura del piloto de caza TIE, con novedosas impresiones en los brazos, es exclusiva de este set. El droïde ratón en miniatura construido con bricks es una imagen frecuente en hangares, bases y naves espaciales imperiales y de la Primera Orden".

**Henrik Andersen,**  
maestro de diseño de  
LEGO® Star Wars™

# INNOVATIVE IMPERIAL DESIGN

- Behind the transparisteel viewport is a fully equipped cockpit with features characteristic of the TIE-fighter-class starships
- Open the top hatch to see the pilot's seat
- Detailed octagonal engine section with inside greebling
- Unique new LEGO® building techniques were used to achieve a more authentic replica of the sphere-shaped exterior, compared to previous LEGO TIE fighters
- Train wheel elements in a new gray color represent the wing struts
- Angled hinges and 32 new 2x4 sloped elements without studs were used to frame the bent-wing solar wings
- The two shovels representing the advanced targeting sensors were also featured in the original UCS model from 2000 – the first time a special element was used for a purpose other than its original use
- Whereas TIE Fighters have twin chin-mounted lasers, the TIE Interceptor's four wingtip blaster cannons are attached to its solar arrays
- The rear of the wings is densely constructed, and the wingtips are slightly more hollow to ensure optimal weight distribution



STAR  
WARS

TIE Interceptor

Manufacturer:  
Affiliation:  
Length:  
Max Acceleration:  
Engine:  
Weapons:

Senior Fleet Systems  
Galactic Empire  
72 m  
4,040 G  
SFS P-15-A turbolaser engine  
4 L-r7.3 laser cannons

25  
YEARS OF  
STAR WARS



## UNE CONCEPTION IMPÉRIALE NOVATRICE

- Derrière une fenêtre en transparent se trouve un habitacle entièrement équipé avec des caractéristiques propres aux vaisseaux de la classe TIE.
- Ouvrez la trappe supérieure pour voir le siège du pilote.
- Une section de moteur octogonale détaillée, avec des détails ornementaux à l'intérieur.
- De nouvelles techniques de construction LEGO® uniques ont été utilisées pour reproduire plus fidèlement l'extérieur sphérique des chasseurs TIE LEGO.
- Les éléments de roue du train dans une nouvelle couleur grise représentent les montants de l'aile.
- Des charnières angulaires et 32 nouveaux éléments 2x4 inclinés sans montants ont été utilisés pour structurer les ailes solaires en forme d'ailes courbées.
- Les deux pelles représentant les capteurs de ciblage avancés figuraient également dans le modèle original de la Série de collection suprême de 2000. C'était la première fois qu'un élément spécial était utilisé à d'autres fins que celles pour lesquelles il avait été conçu.
- Alors que les chasseurs TIE sont équipés de deux lasers montés sur le menton, les quatre canons blasters des intercepteurs TIE sont fixés aux panneaux solaires aux bouts des ailes.
- L'arrière des ailes est densément construit et les extrémités des ailes sont légèrement plus creuses afin d'assurer une répartition optimale du poids.

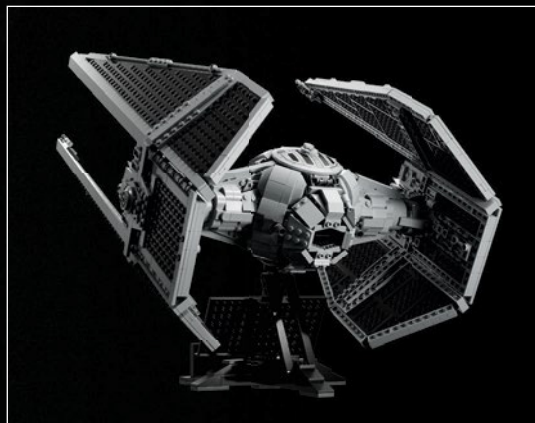

## INNOVADOR DISEÑO IMPERIAL

- Detrás de la ventanilla de Transpariacero hay una cabina totalmente equipada con elementos característicos de los cazas estelares TIE.
- La escotilla superior se abre para contemplar el asiento del piloto.
- En el interior de la detallada sección octagonal del motor se aprecia el uso de la técnica de sobrecarga.
- Se utilizaron nuevas y exclusivas técnicas de construcción con LEGO® para reproducir el exterior esférico con aún más autenticidad que en los modelos LEGO de cazas TIE del pasado.
- Los soportes de las alas se recrean mediante elementos que representan ruedas de tren en un nuevo tono de gris.
- Se utilizaron bisagras en ángulo y 32 nuevos elementos inclinados 2x4 sin espigas para enmarcar las alas facetadas con celdas solares.
- Las dos palas que representan los sensores avanzados de seguimiento de objetivos también aparecían en el modelo UCS original de 2000; este hecho marcó la primera vez que se utilizó un elemento especial para un fin distinto de su uso original.
- Mientras que los cazas TIE cuentan con dos rayos láser instalados por debajo de la línea de la ventanilla, el Interceptor TIE cuenta con cuatro cañones bláster fijados a sus paneles solares.
- A diferencia de las puntas de las alas, que son más huecas, la parte posterior de estas cuenta con una alta densidad de elementos a fin de garantizar una distribución óptima del peso.





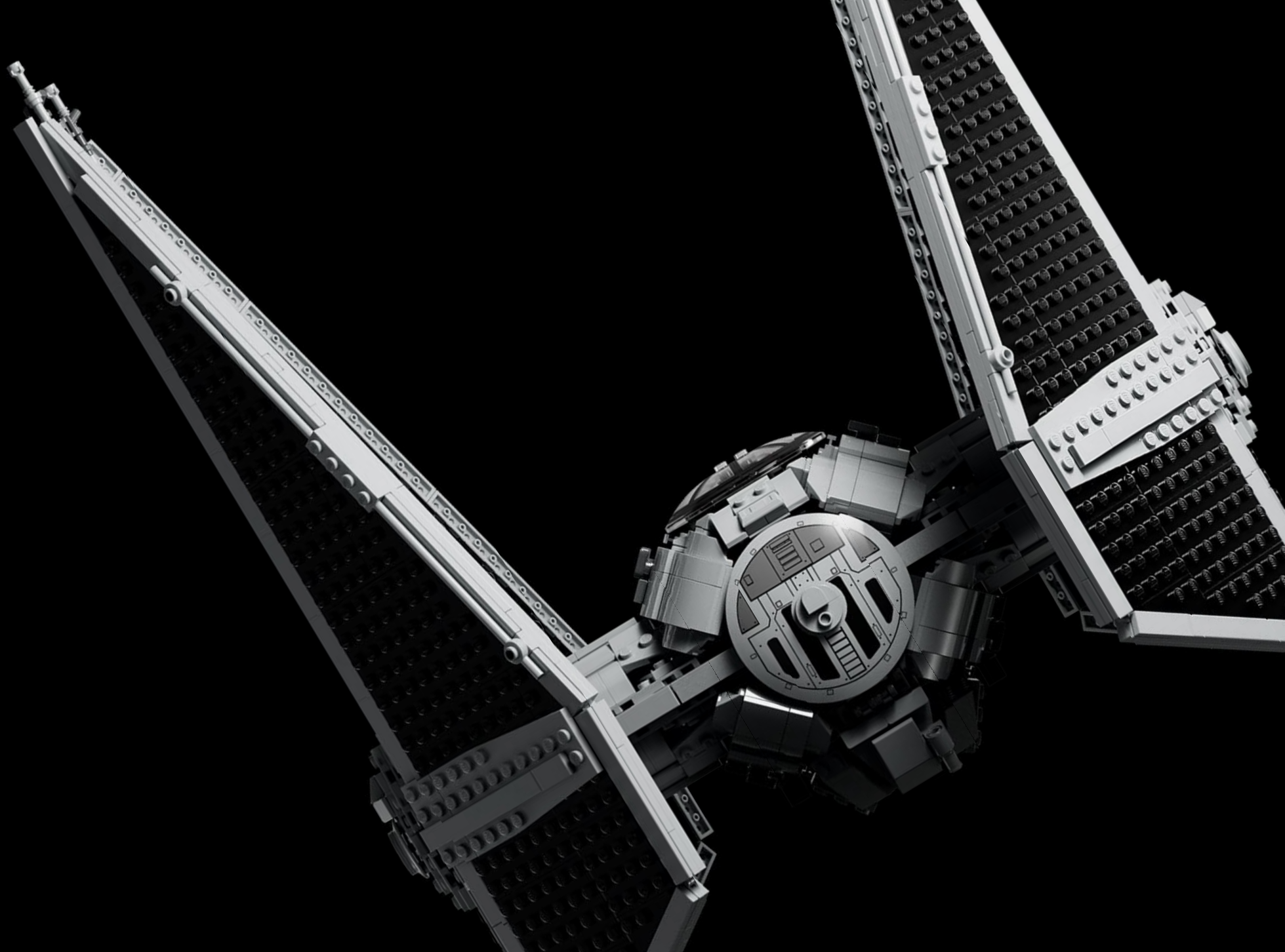



Join the 25<sup>th</sup> Anniversary  
at [LEGO.com/LSW-25](http://LEGO.com/LSW-25)

**25**  
ANS DE  
LEGO® STAR WARS™



**25**  
AÑOS DE  
LEGO® STAR WARS™



**STAR  
WARS™**

© & ™ Lucasfilm Ltd.

Participez au 25<sup>e</sup> anniversaire  
sur [LEGO.com/LSW-25](http://LEGO.com/LSW-25)

Participa en el 25 aniversario  
en [LEGO.com/LSW-25](http://LEGO.com/LSW-25)



## The ultimate insider's guide

Deluxe book package with collectible prints

## Le guide suprême pour les Insiders

Livre de luxe avec affiches à collectionner

## La guía total para auténticos entusiastas

Edición de lujo en estuche con láminas coleccionables

[LEGO.com/LSW25Book](http://LEGO.com/LSW25Book)



# STAR WARS

© & TM Lucasfilm Ltd.

NOUVEAUTÉS  
DE JUILLET

LANZAMIENTO  
EN JULIO

25  
ANS DE  
LEGO STAR WARS

25  
AÑOS DE  
LEGO STAR WARS

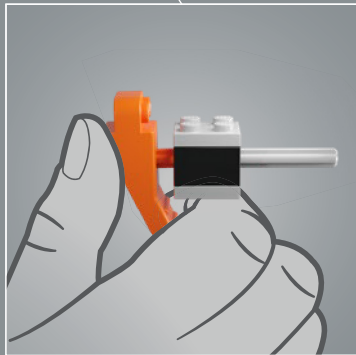
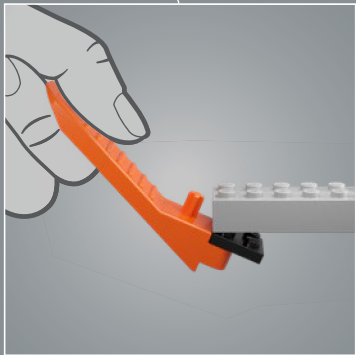
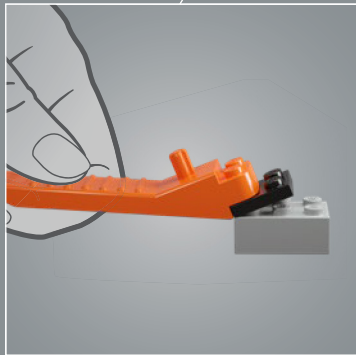
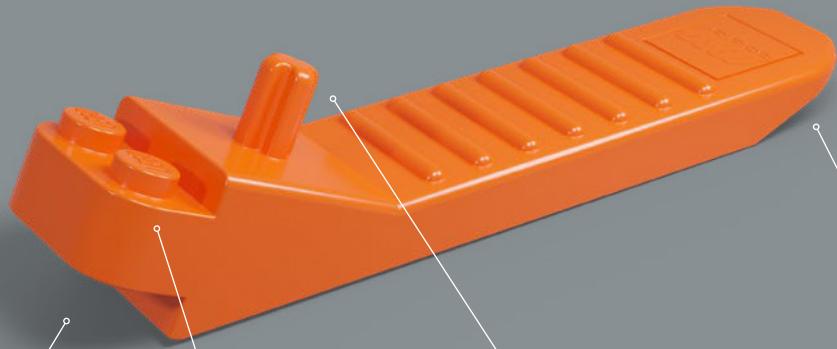



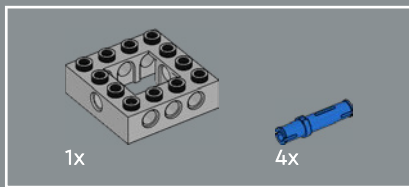

1

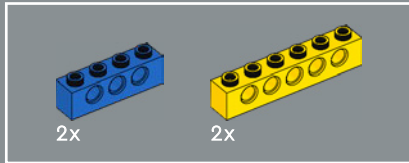
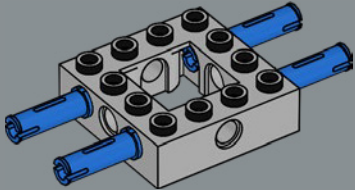

2

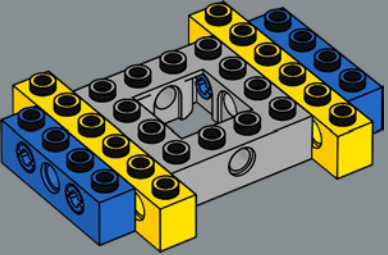

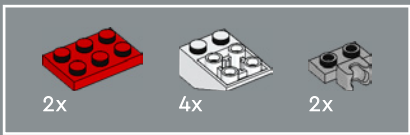

3

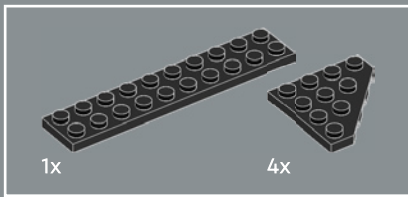
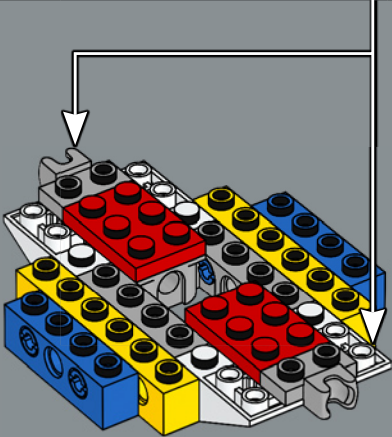
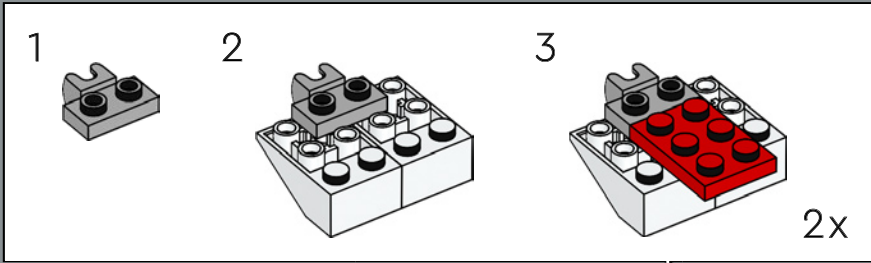

4

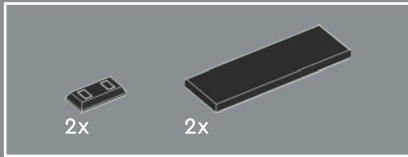
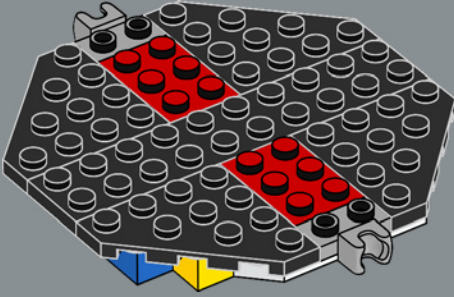

5

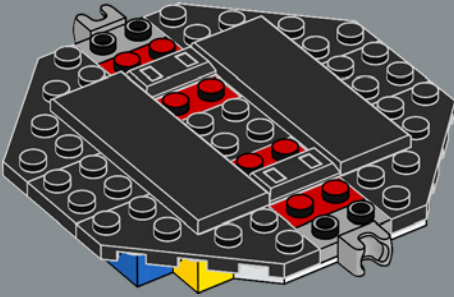





6

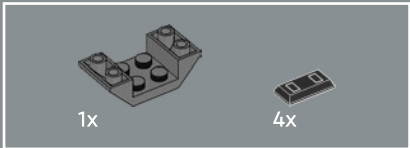
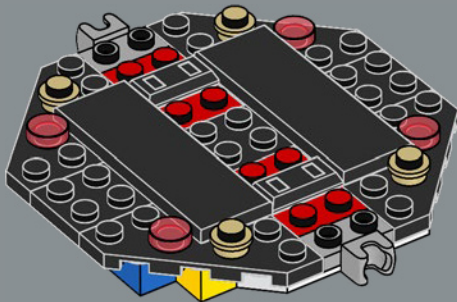

7

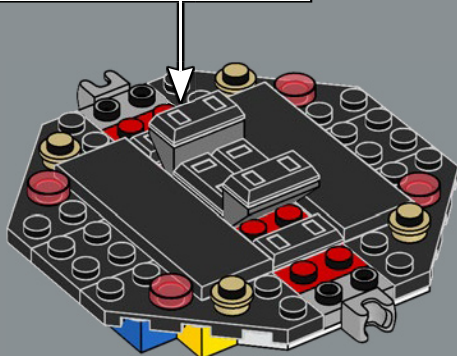
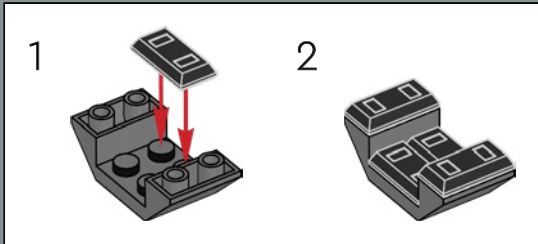

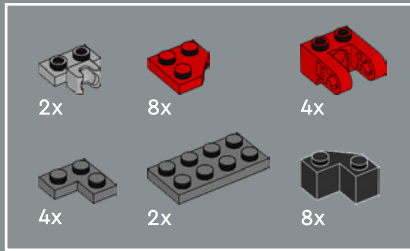
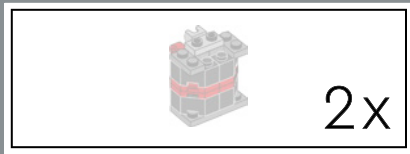

8

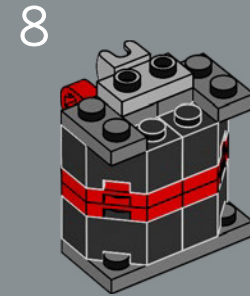
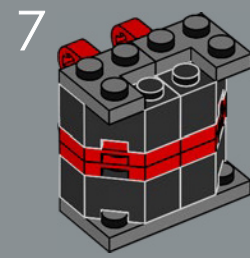
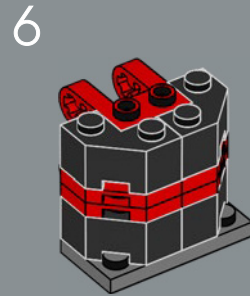
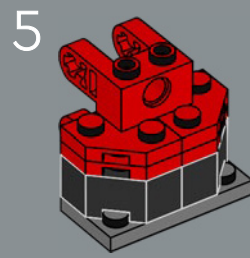
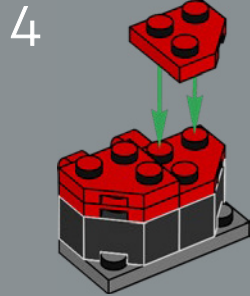
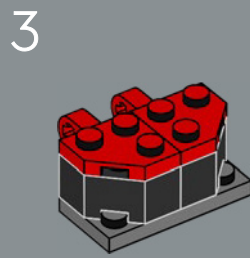
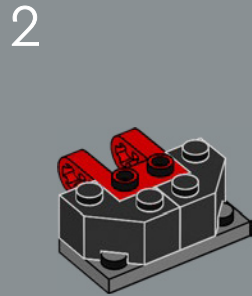
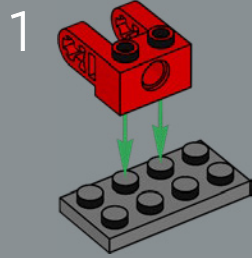

2x

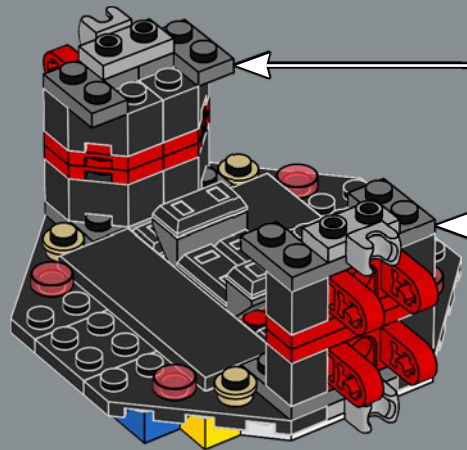



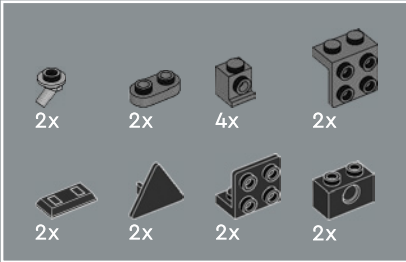
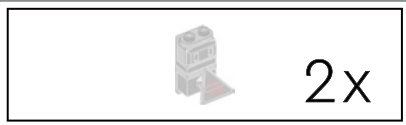

9

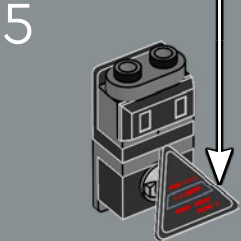
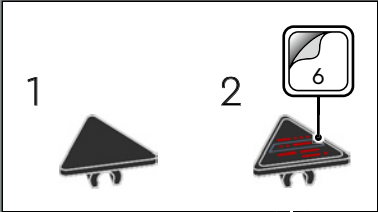
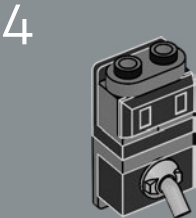
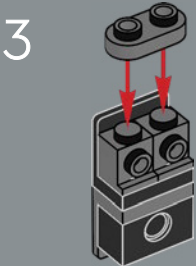
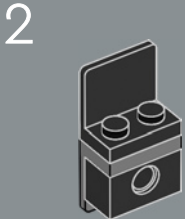
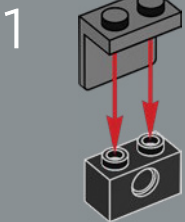

2x

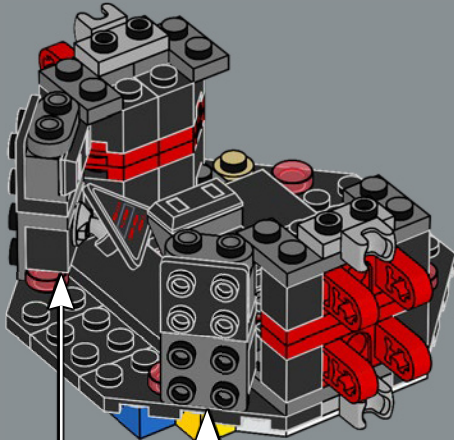



2x

10

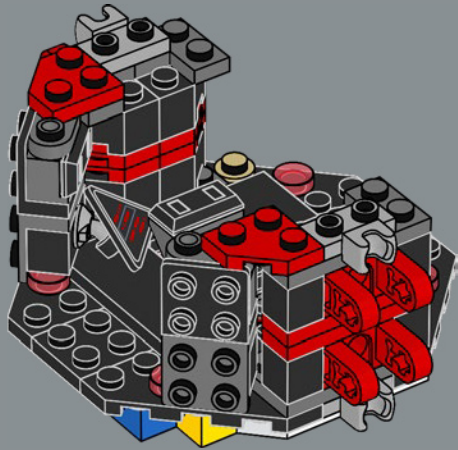

1x



1x



1x



1x

11

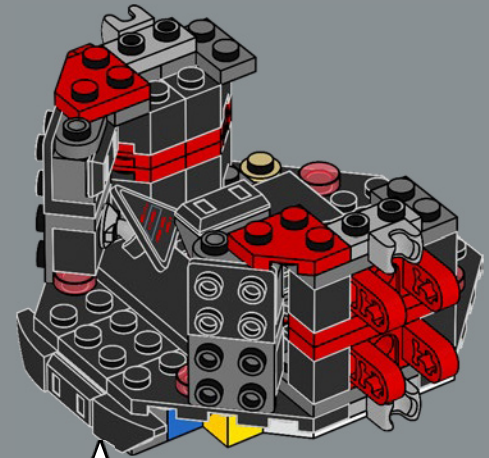

1

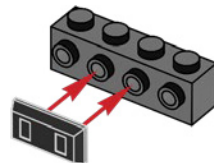

2

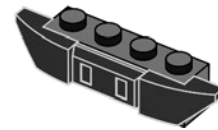



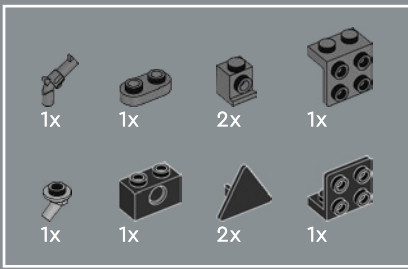

12

1

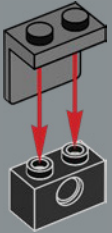

2

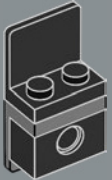

3

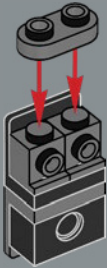

4

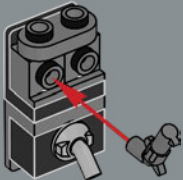

5



6

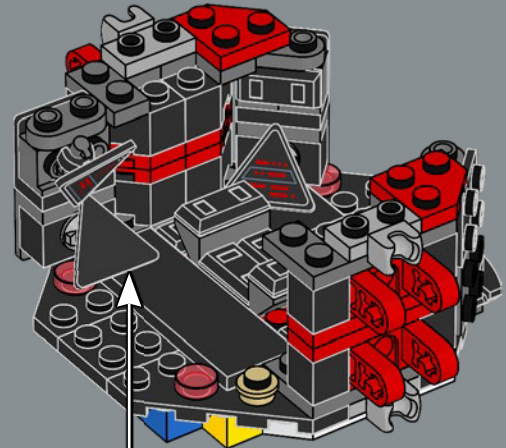
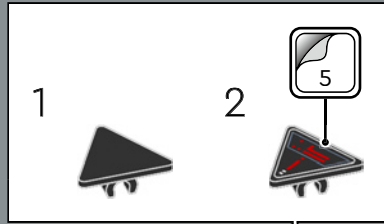

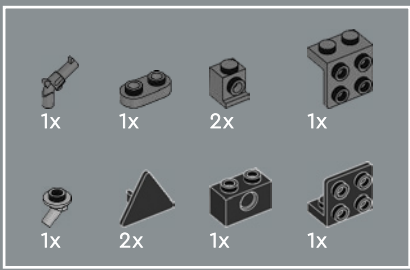

# 13

1

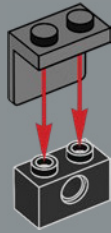

2

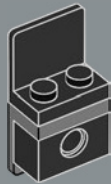

3

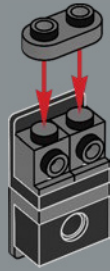

4

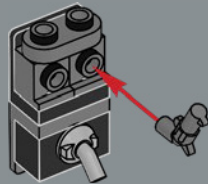

5

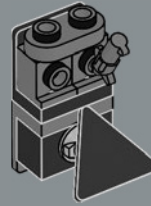

6

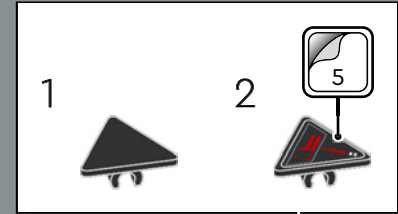



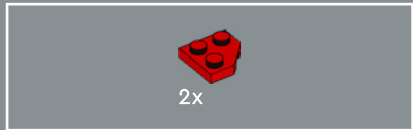

14

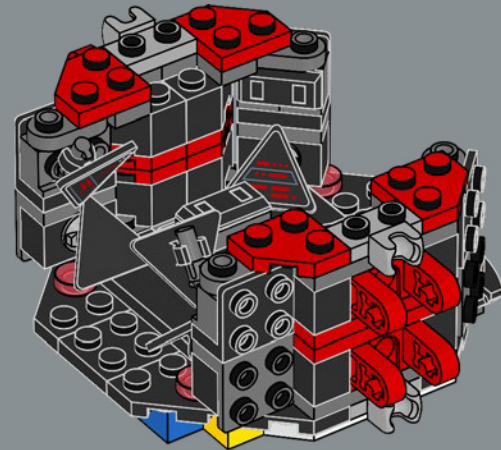
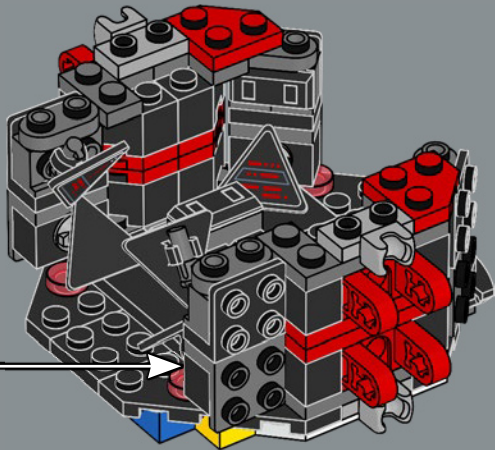

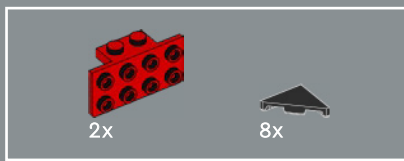

15

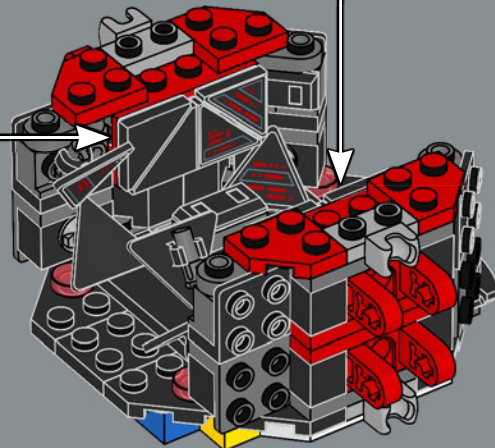
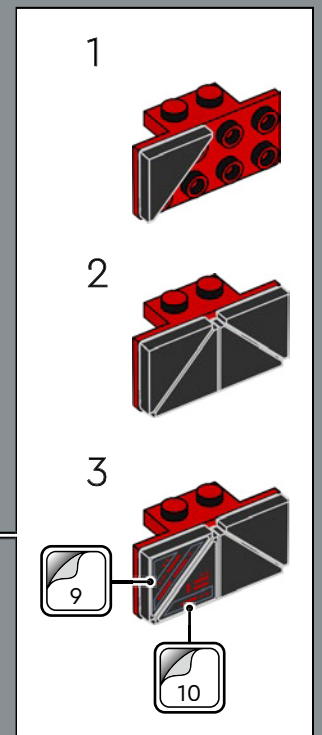
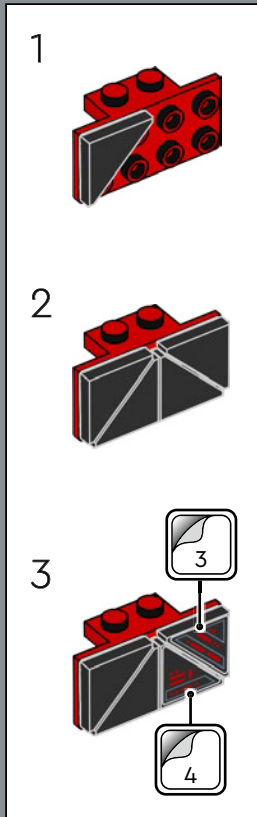



16

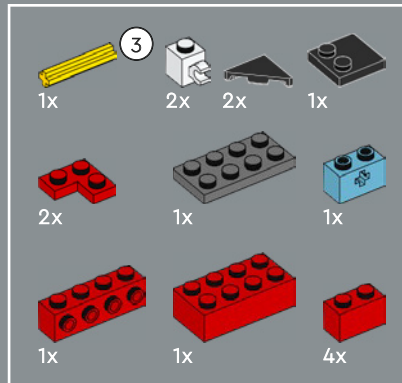
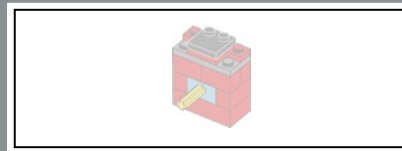
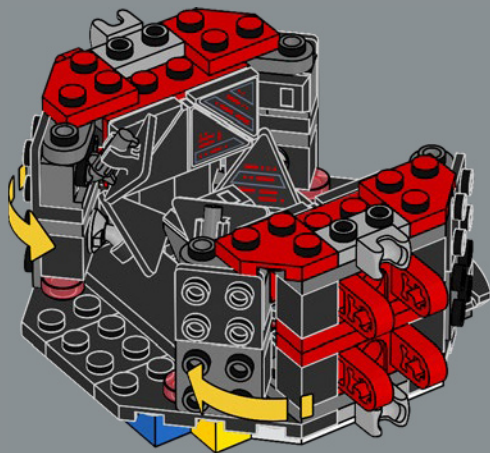

17

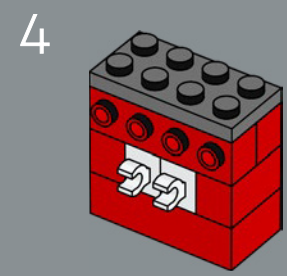
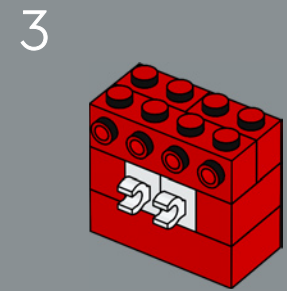
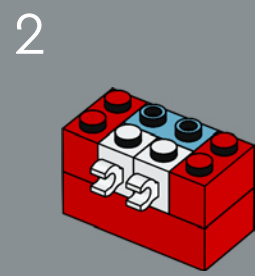
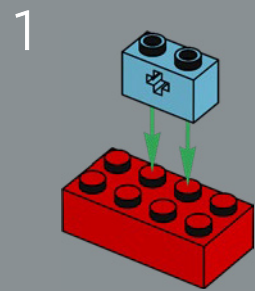

5

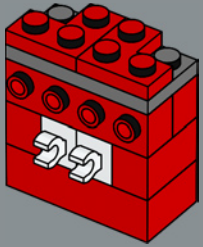

7

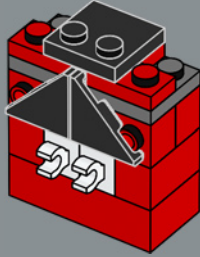

6

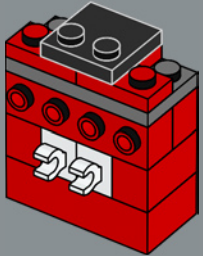

8

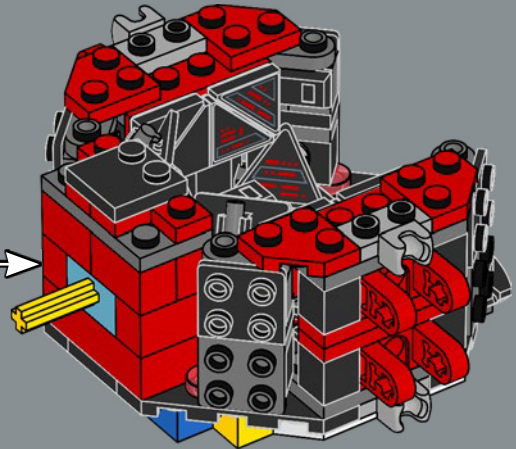
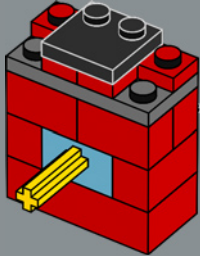

 ③ 1:1

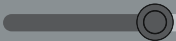



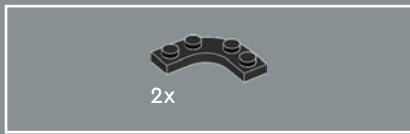

18

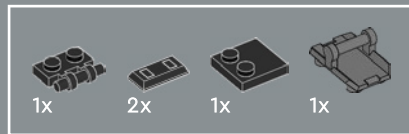
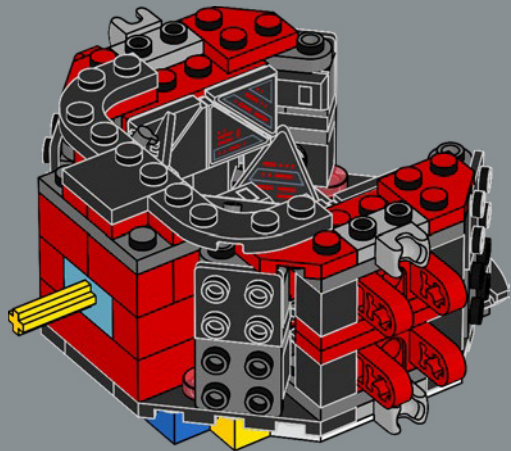

19

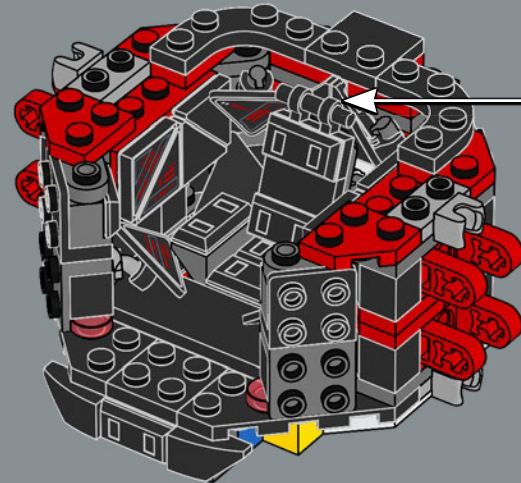
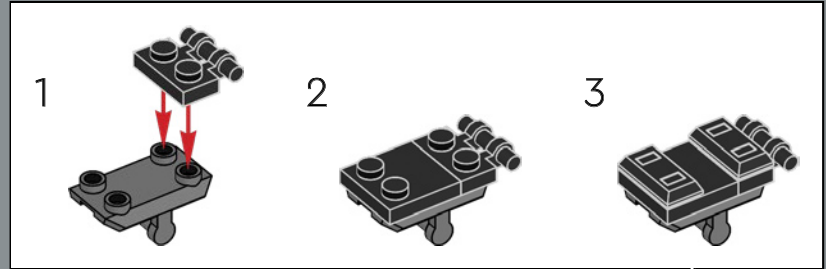



20

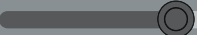
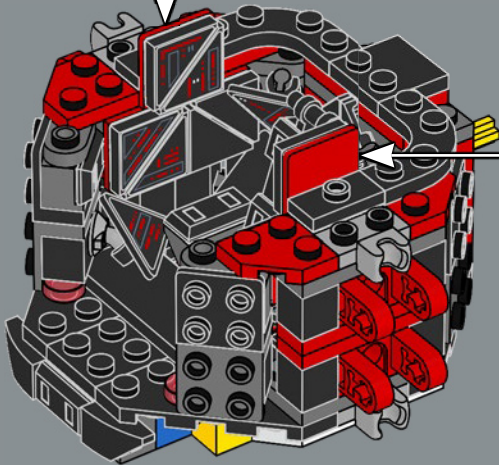
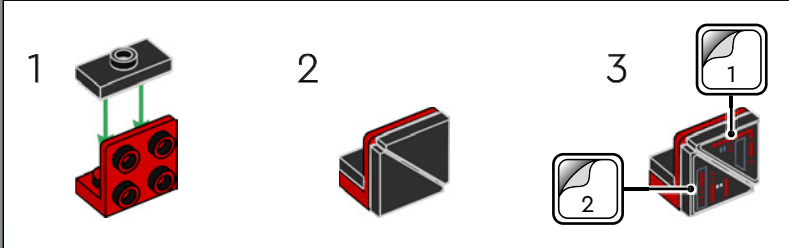
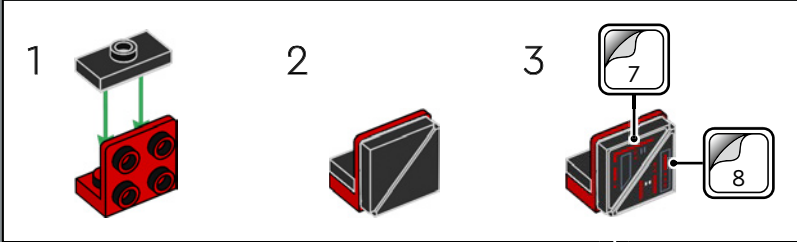

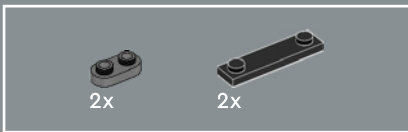

21

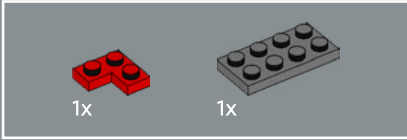
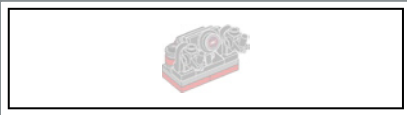
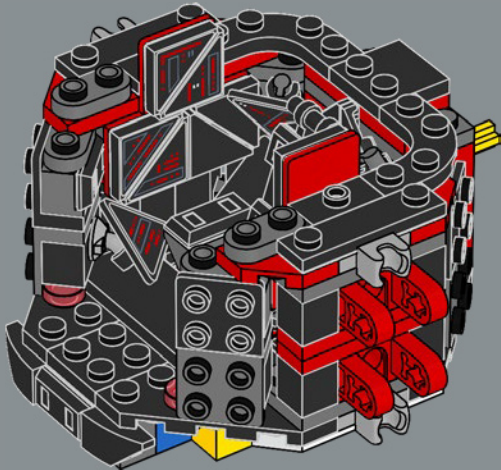

22

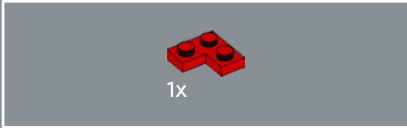
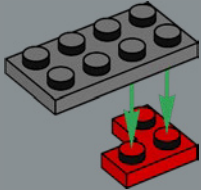

23

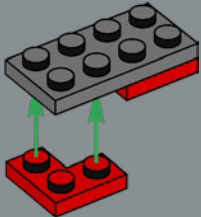





1x

24



2x

1x

25

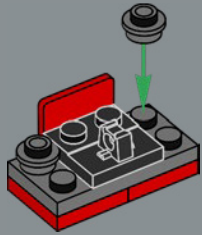

1x



2x

27

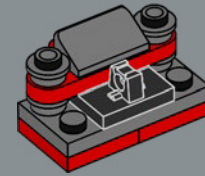

2x

28

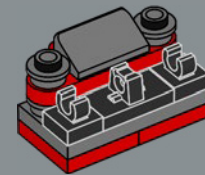

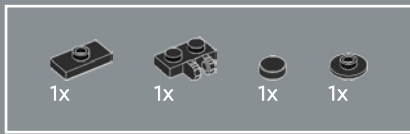

29

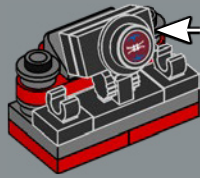
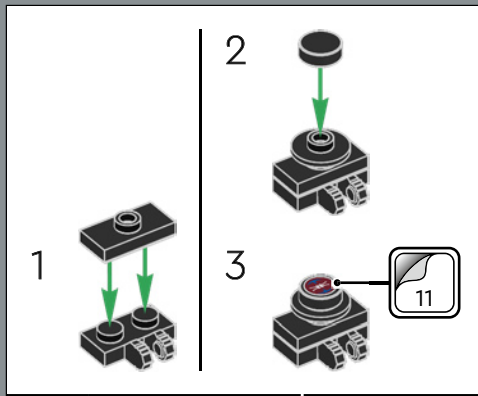

30

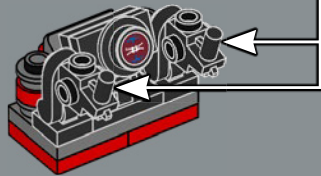
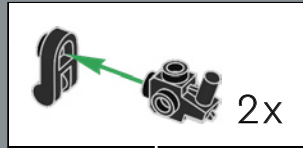

31

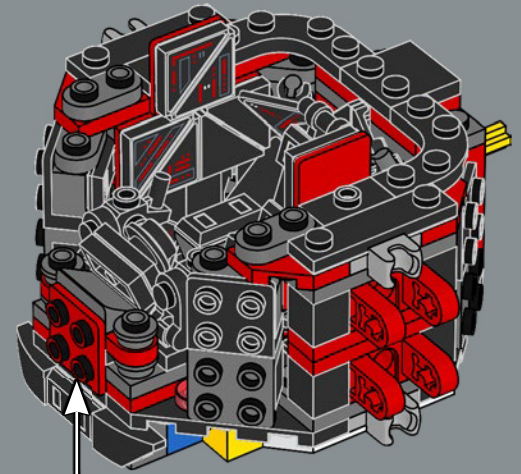

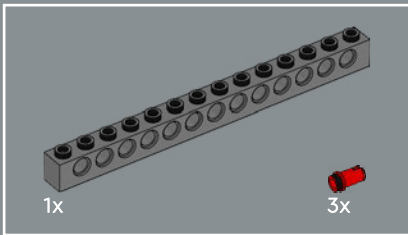
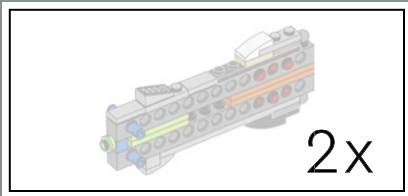

32

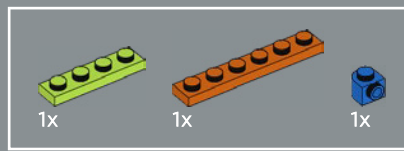
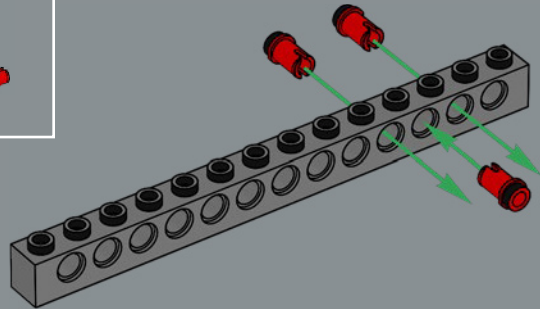

33

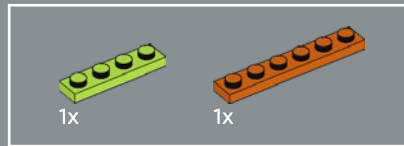
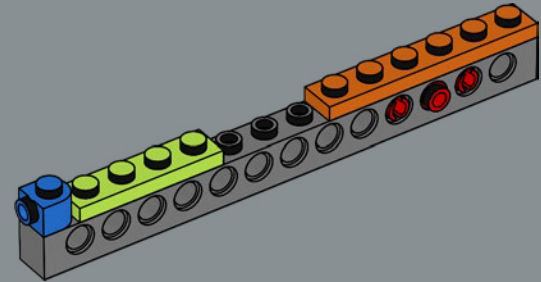

34

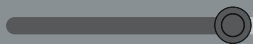
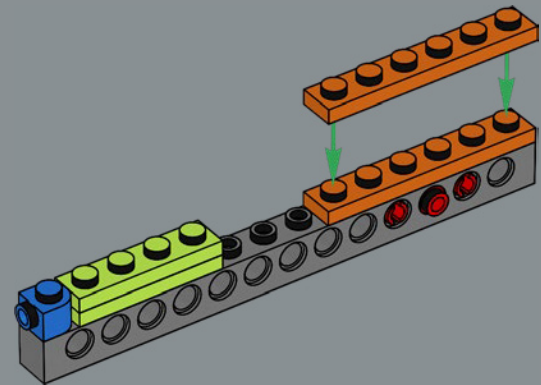



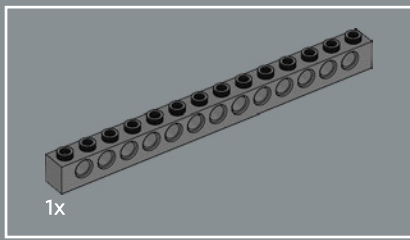

35

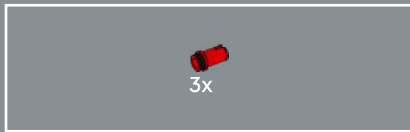
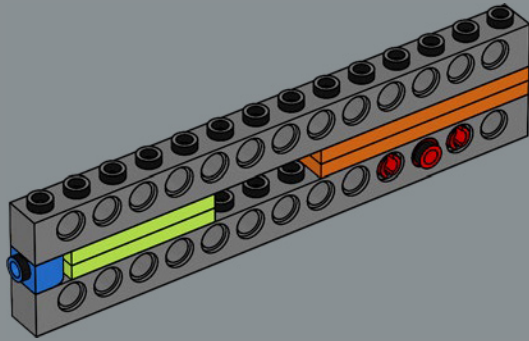

36

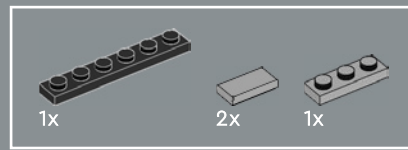
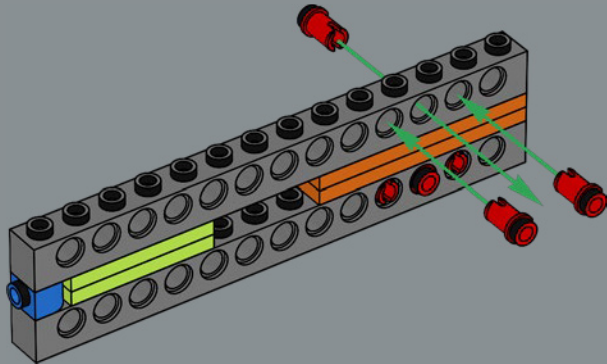

37

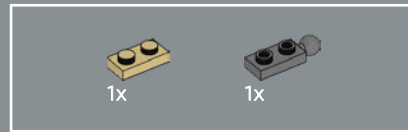
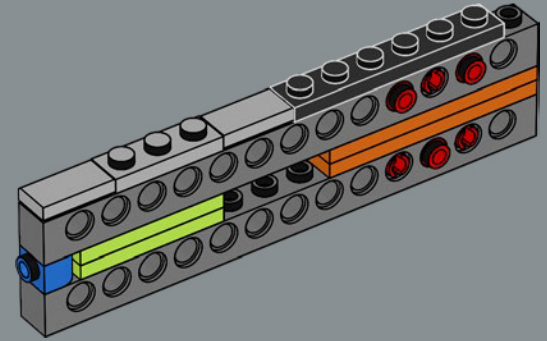

38

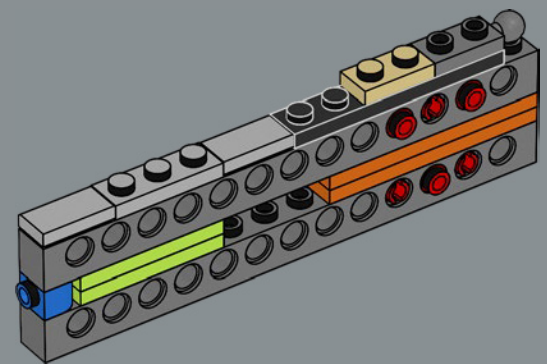

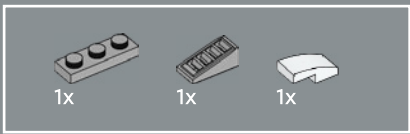

39

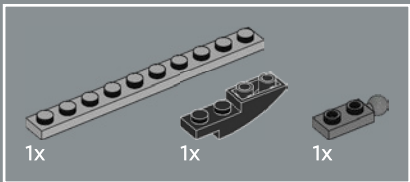
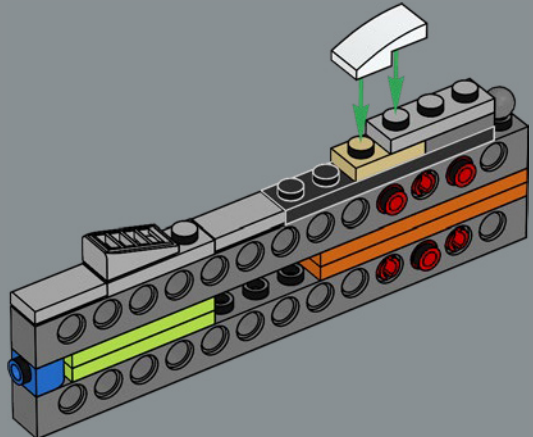

40

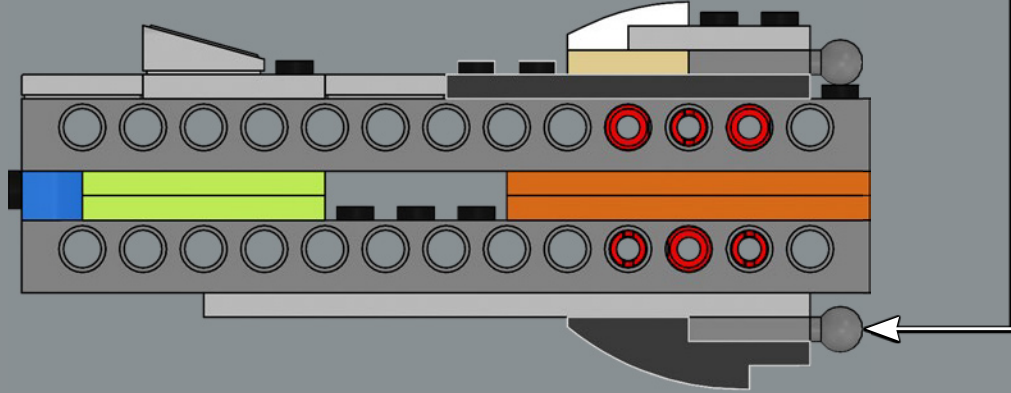
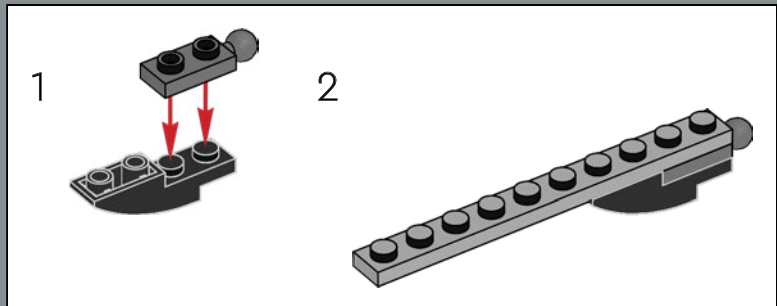

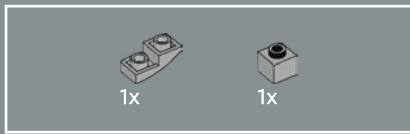

41

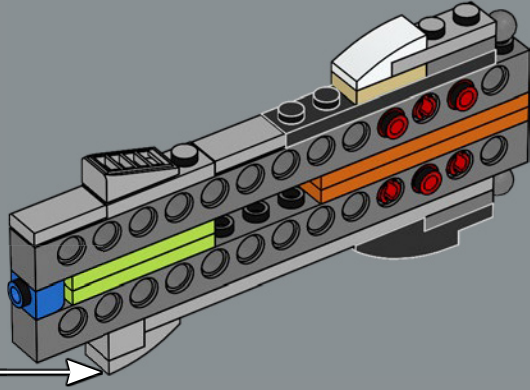
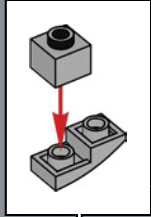

42

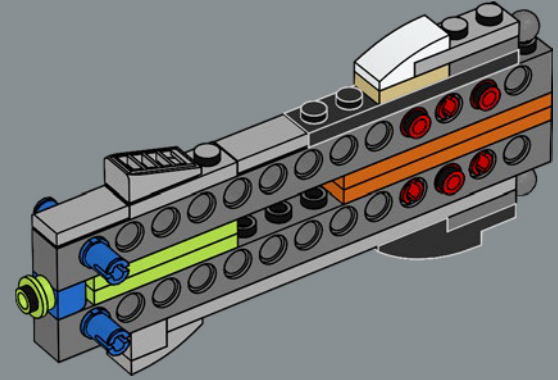

2x

43

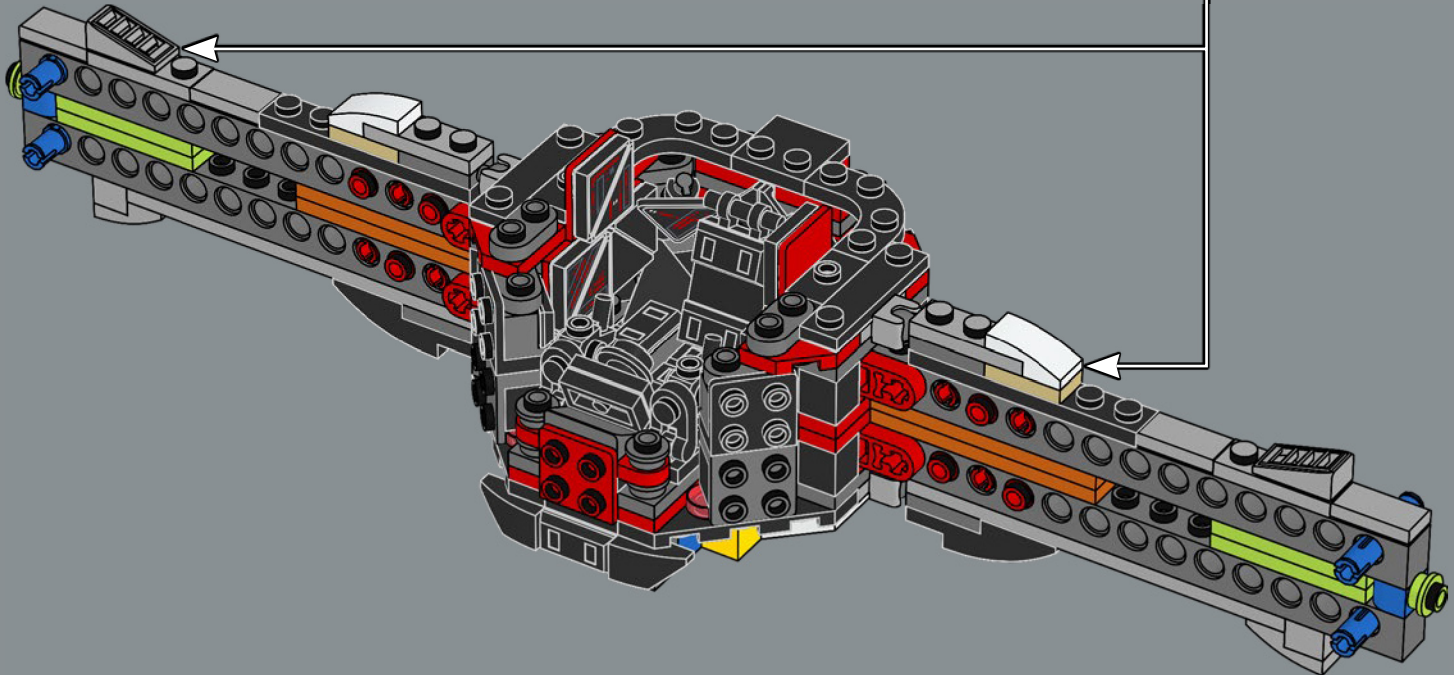



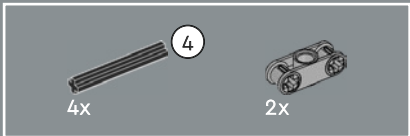

44

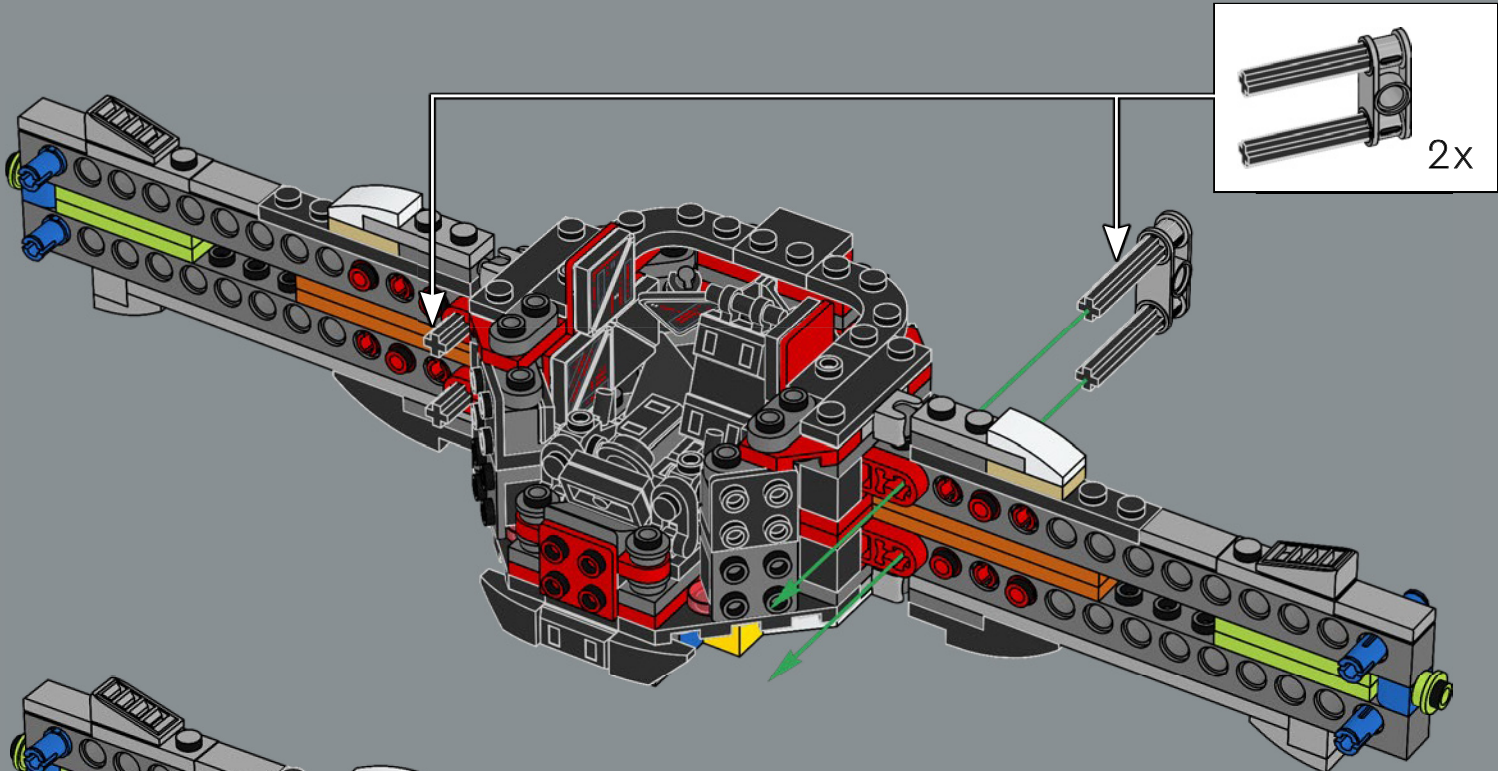

45

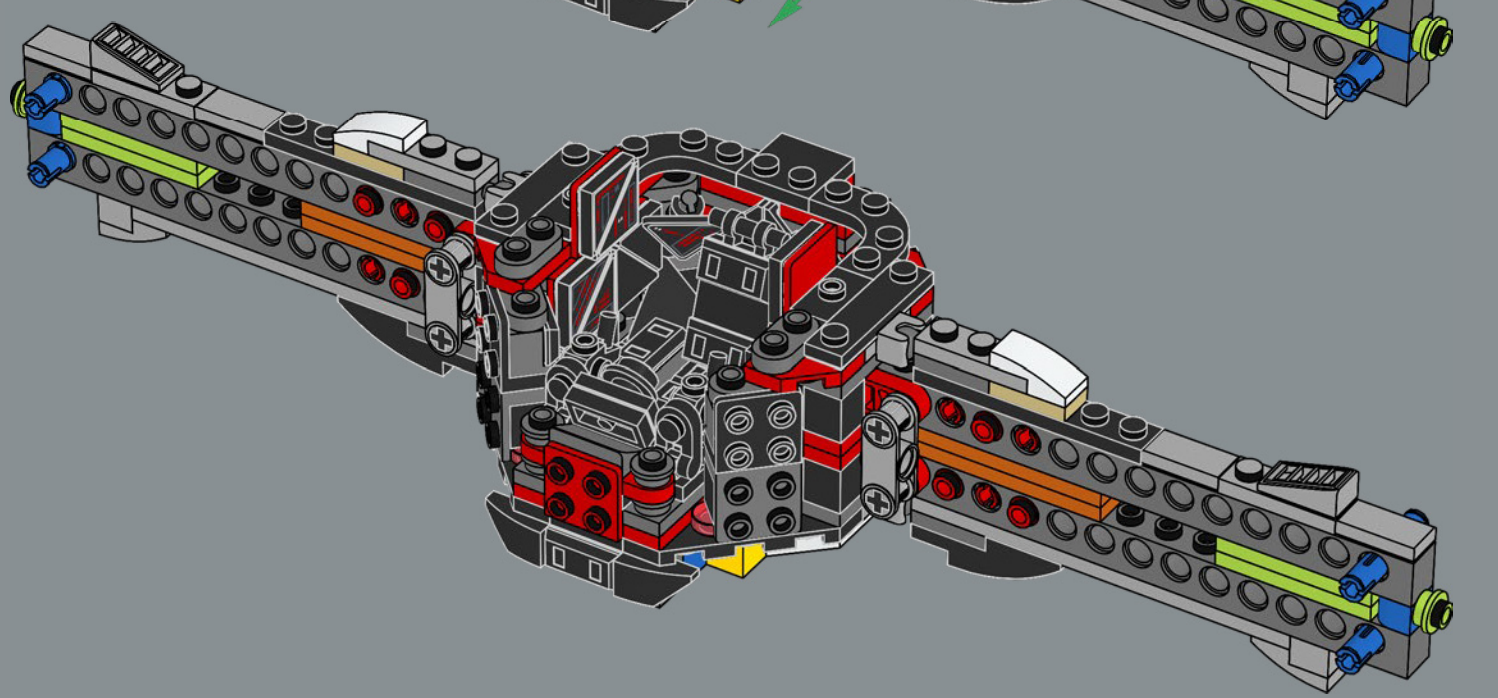

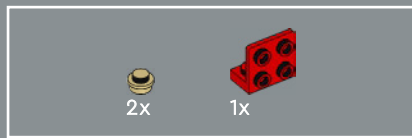

46

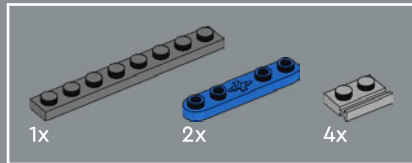
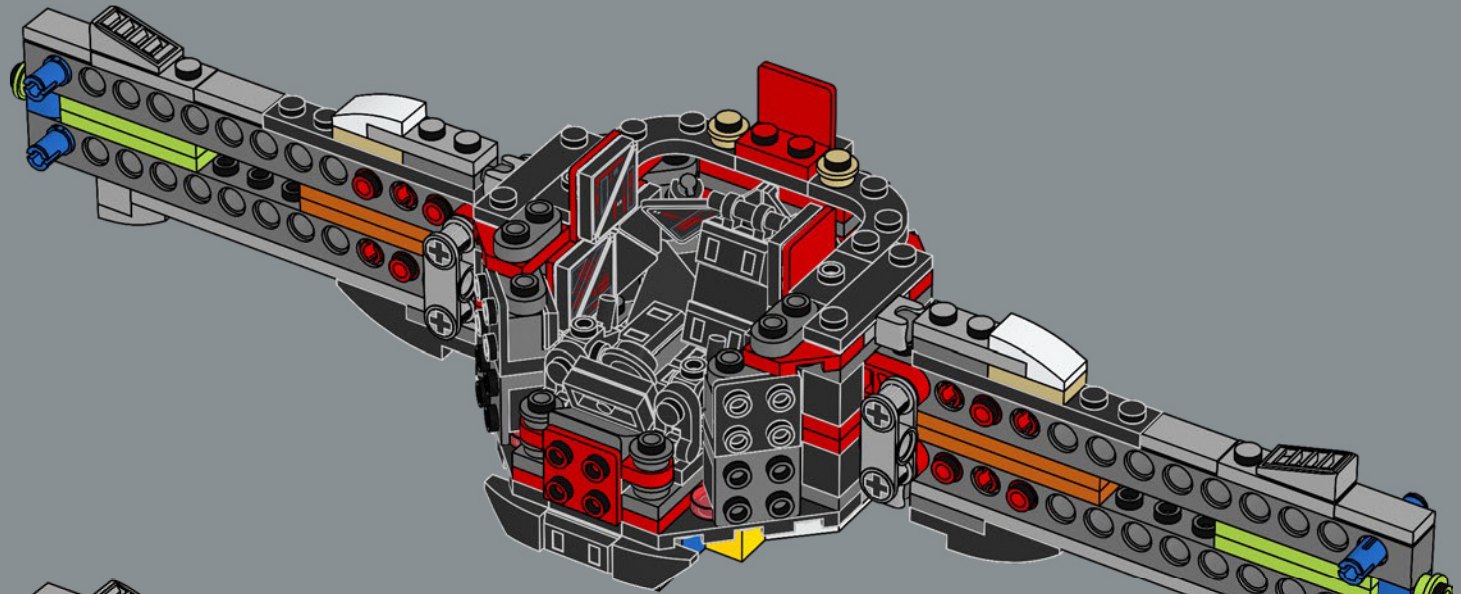

47

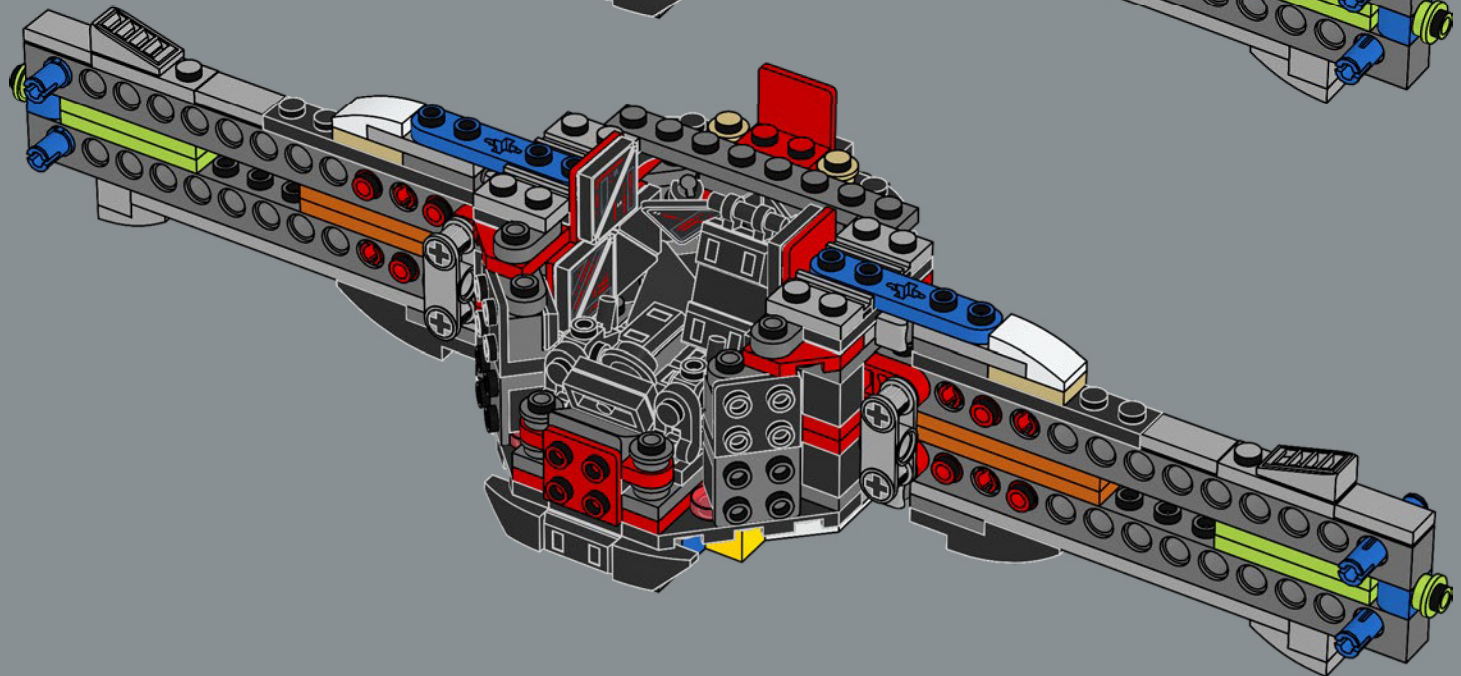





48

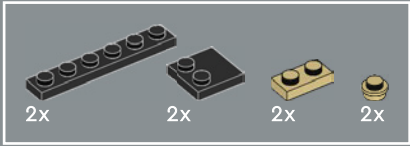
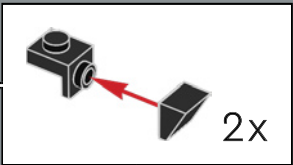
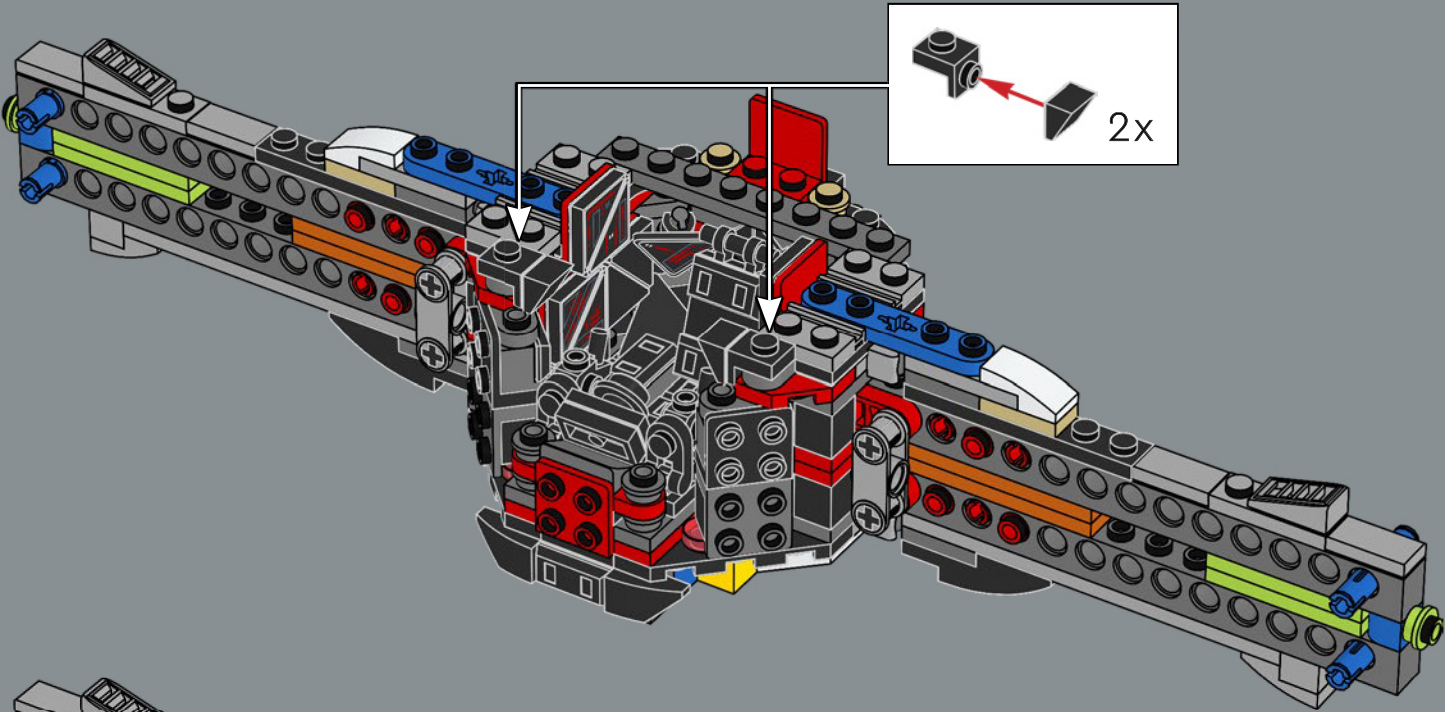

49

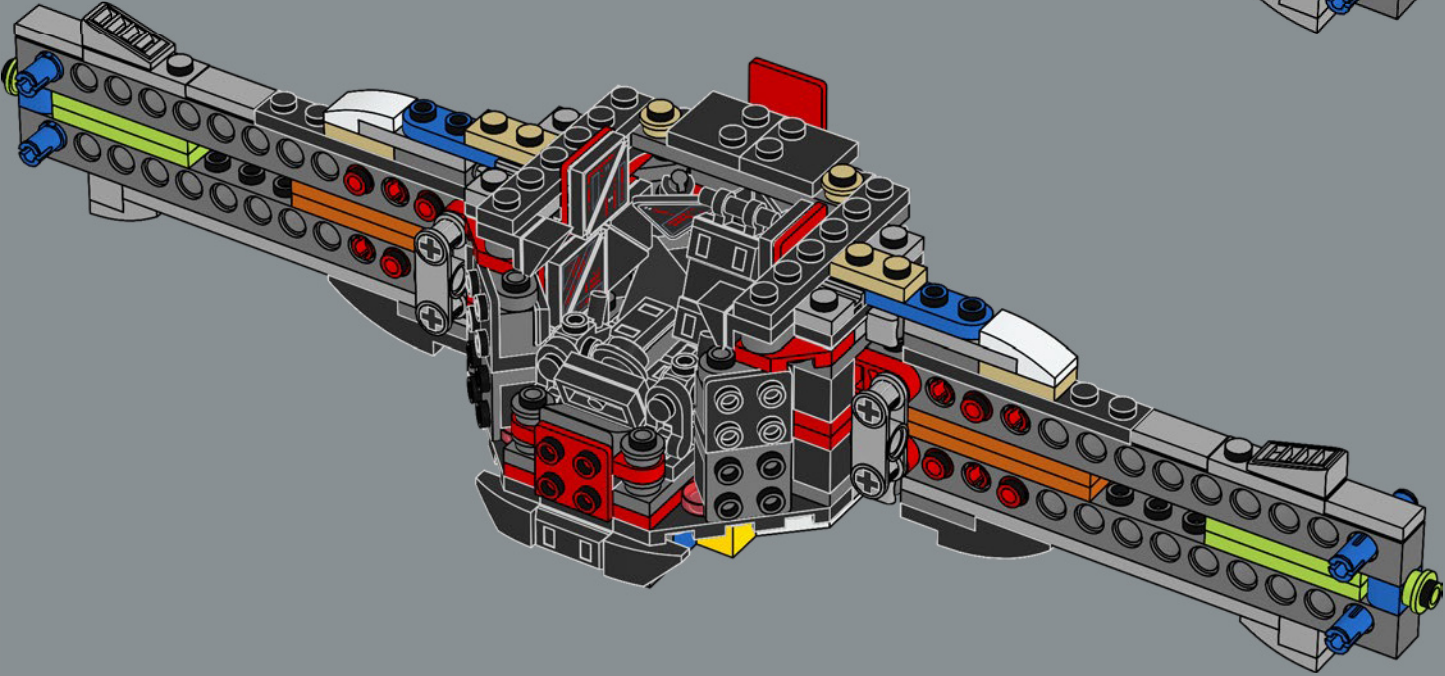



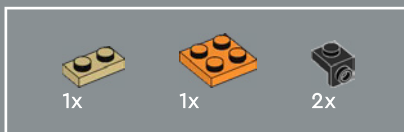

50

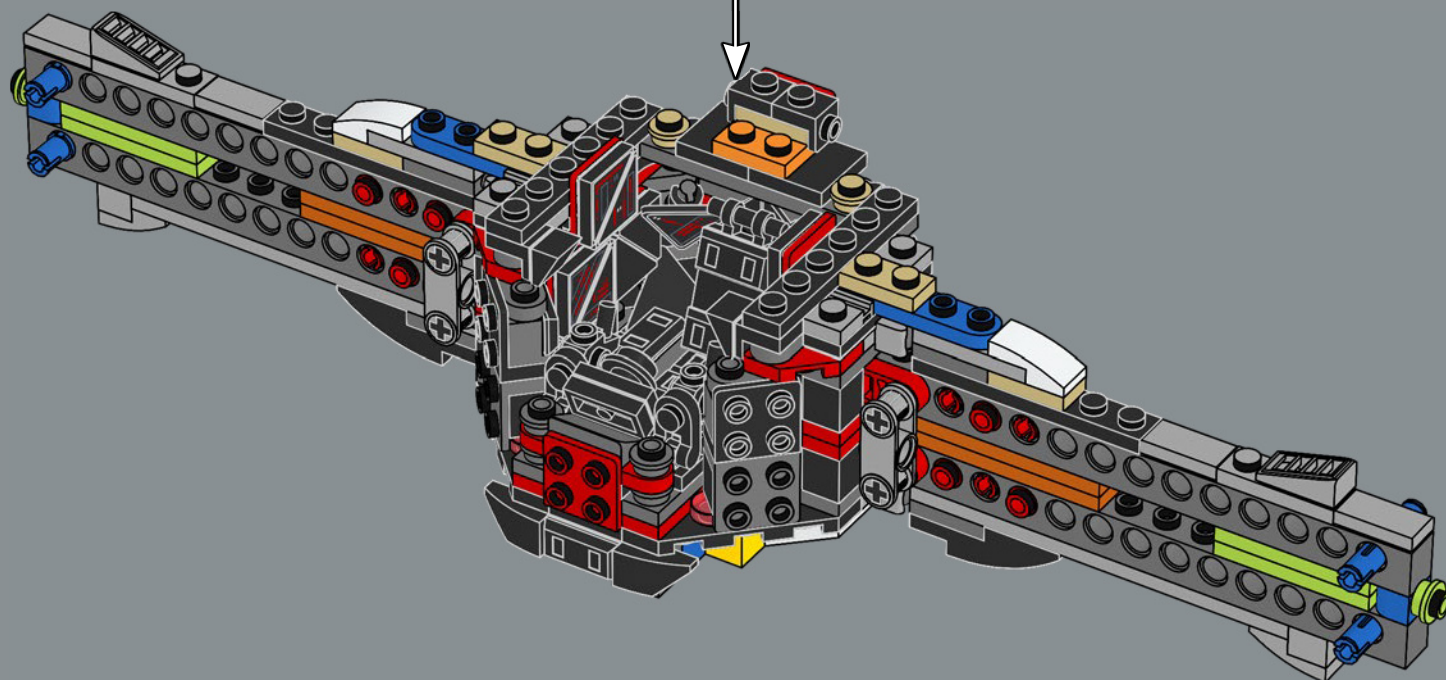
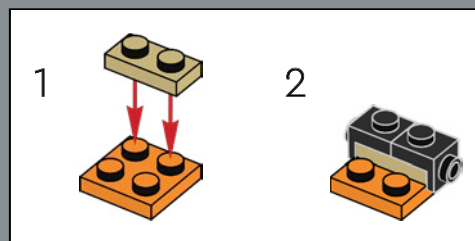

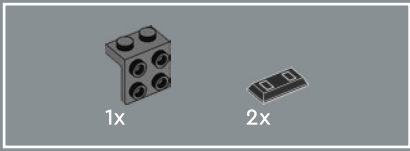

51

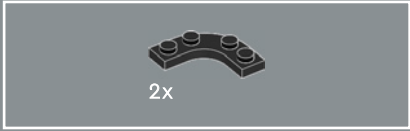
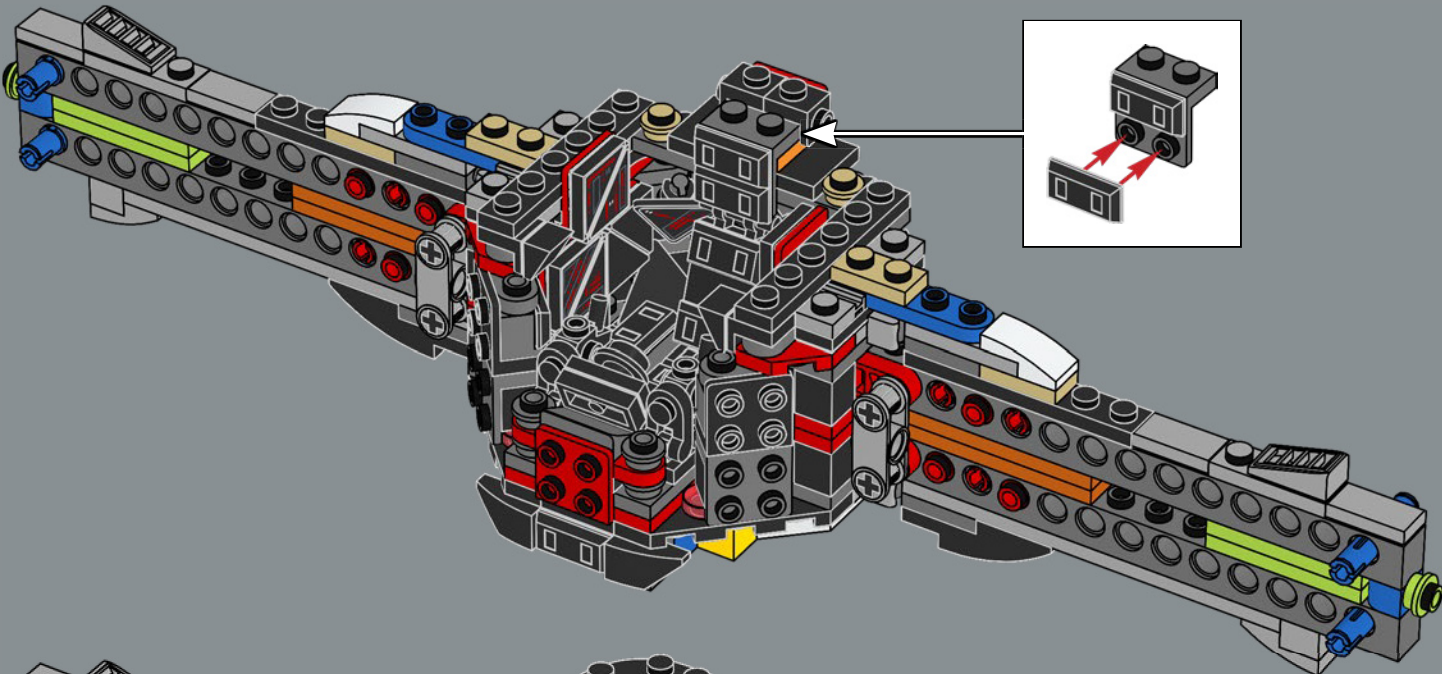

52

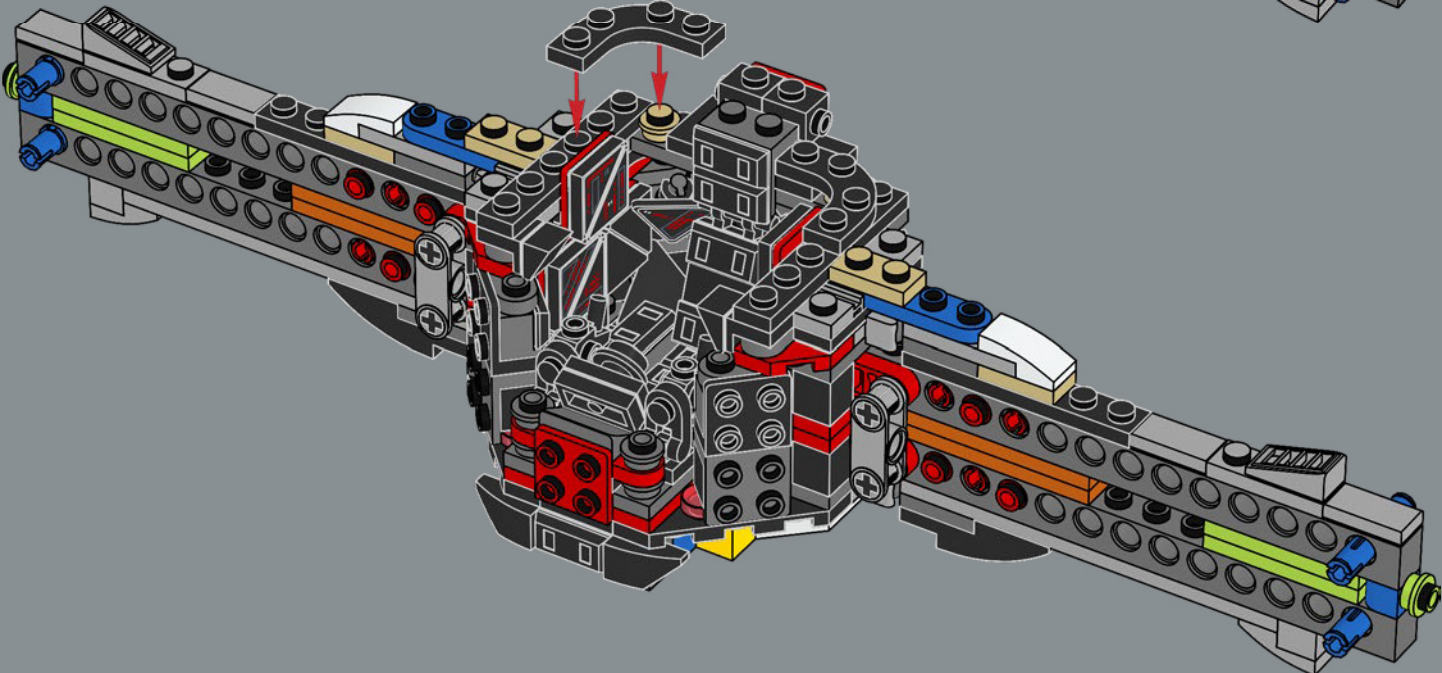





53

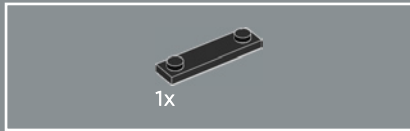
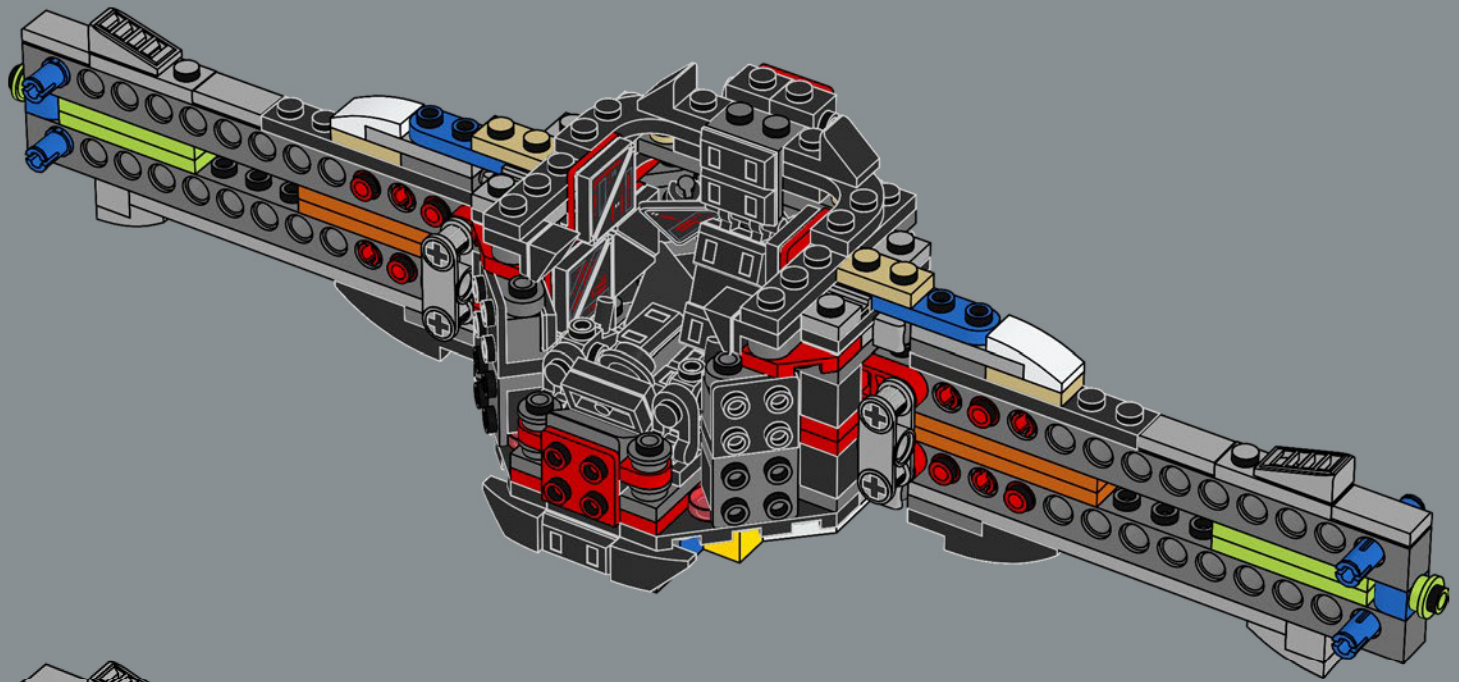

54

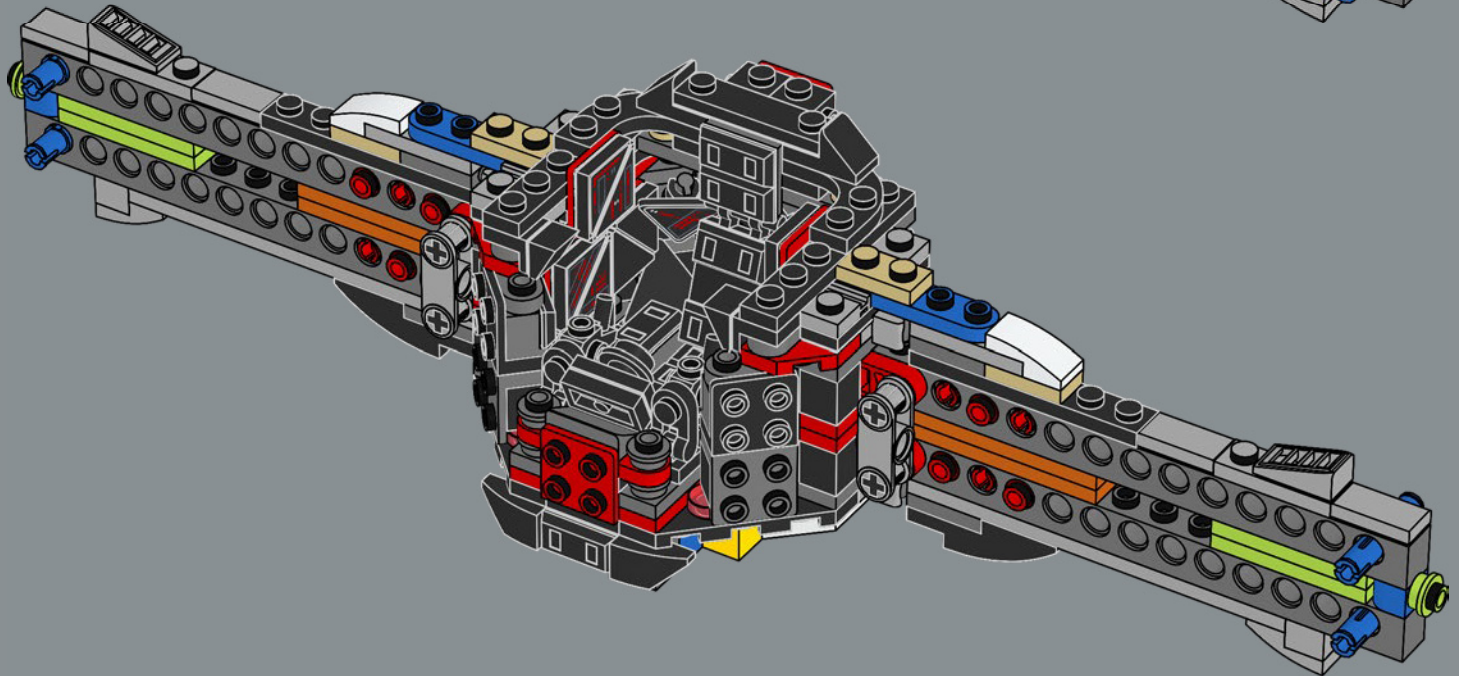



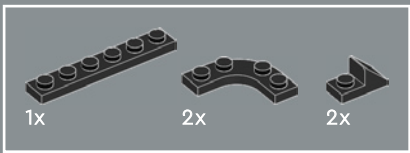

55

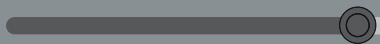
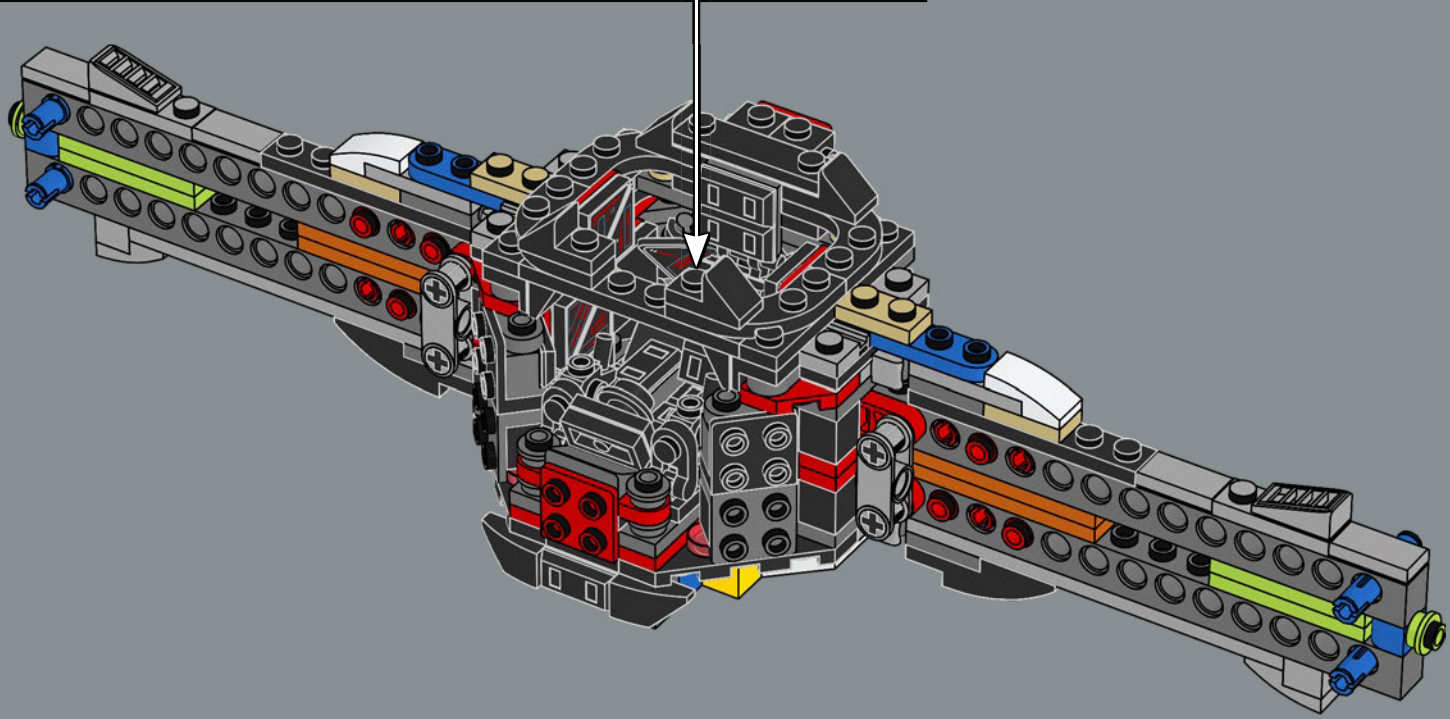
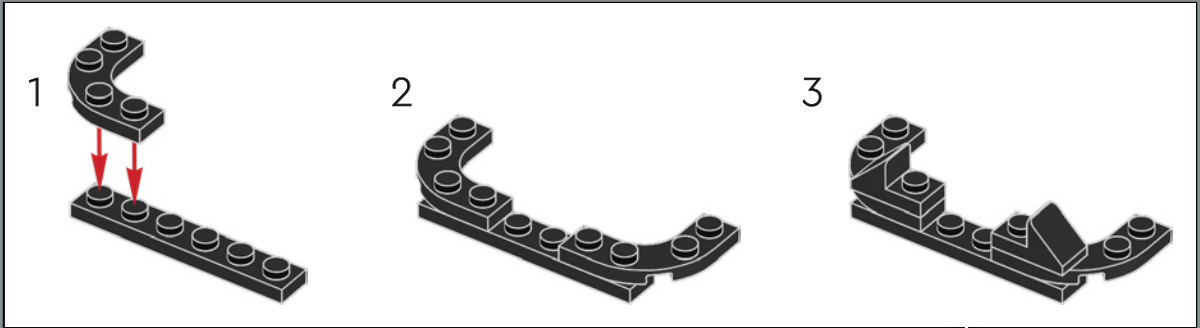



56

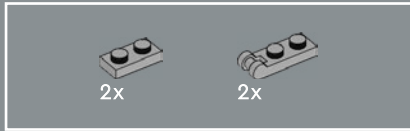
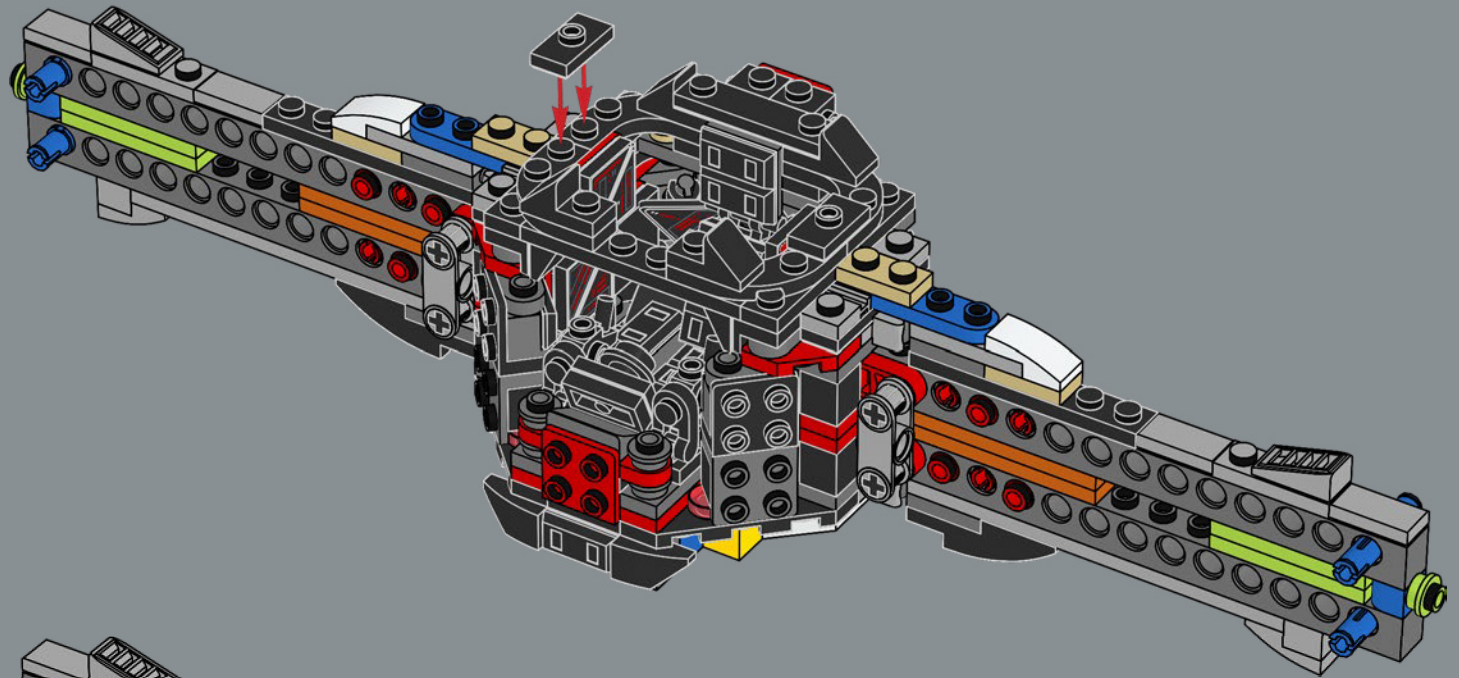

57

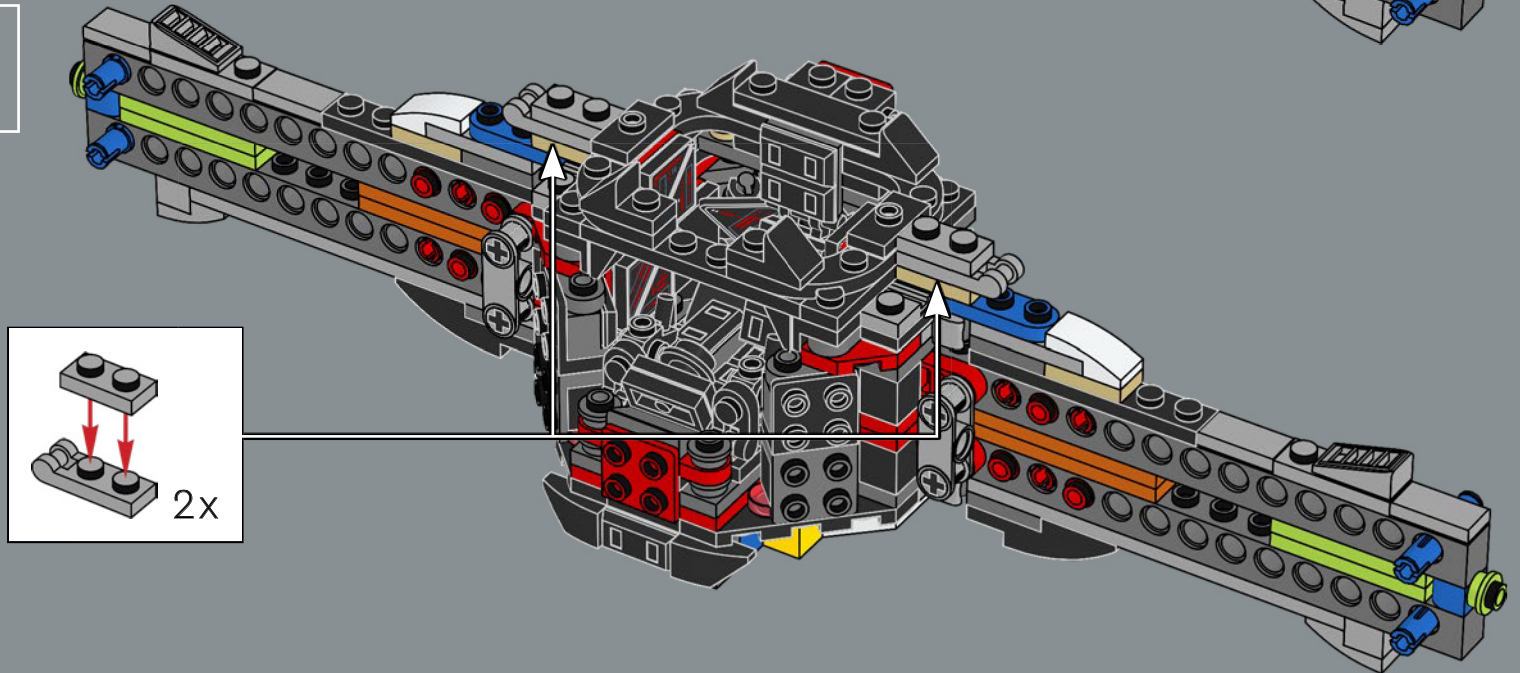

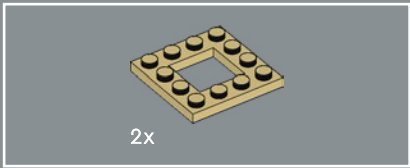

58

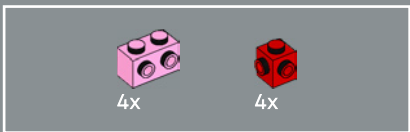
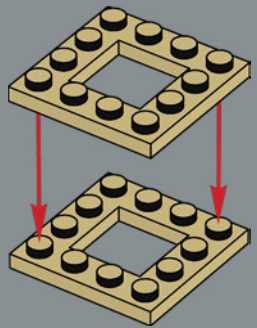

59

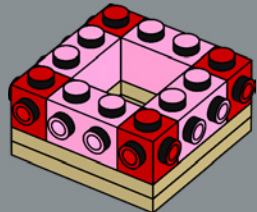

60

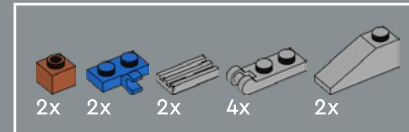
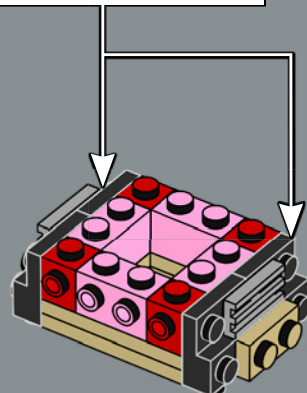
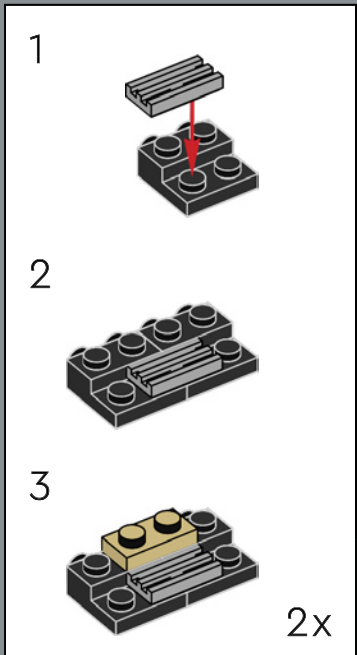

61

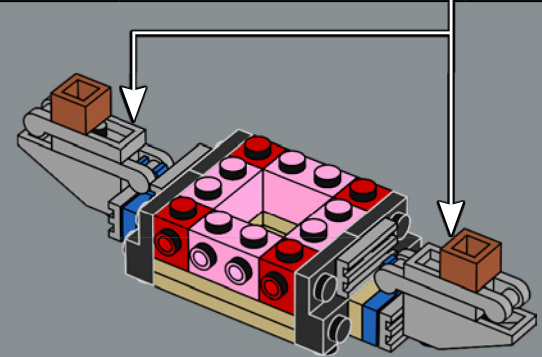
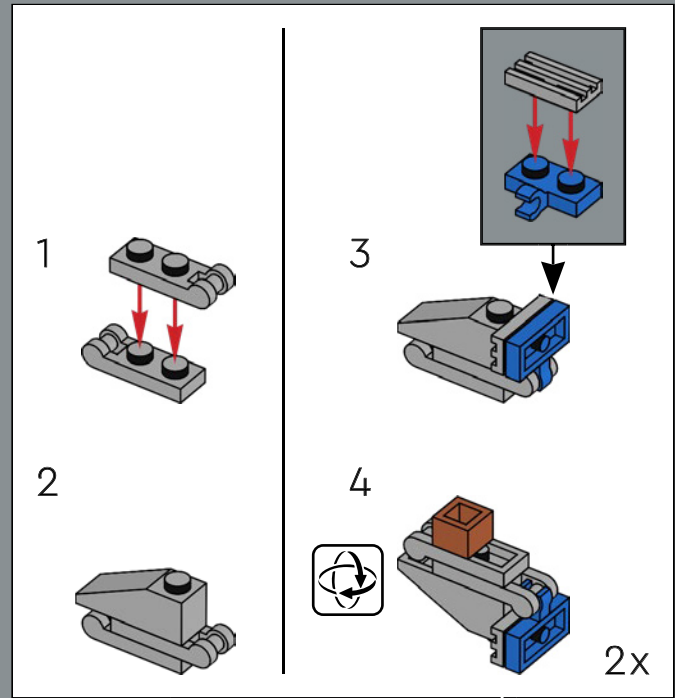



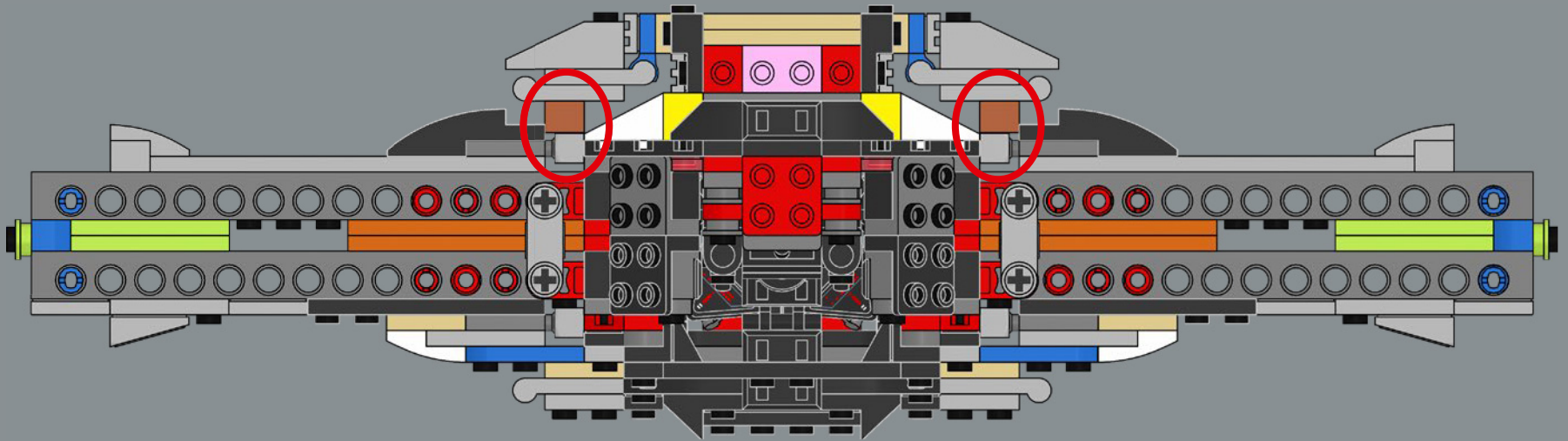
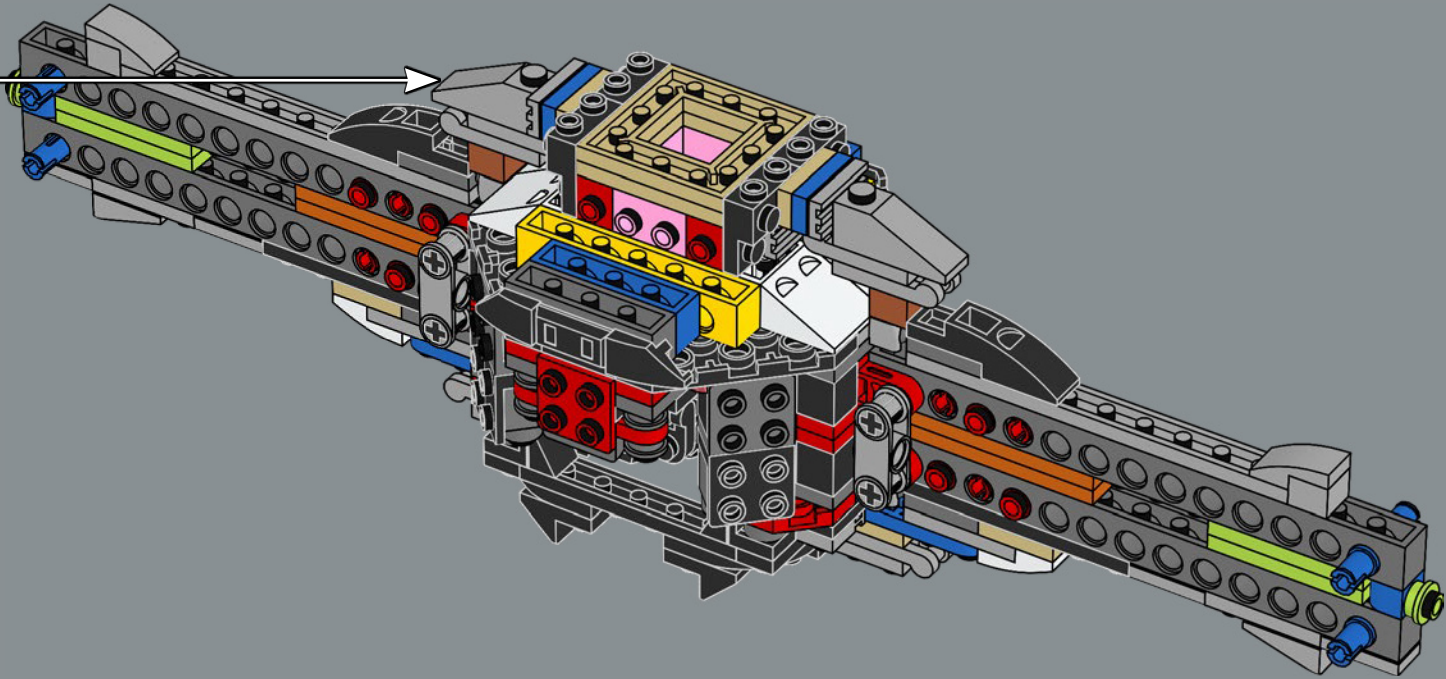



63

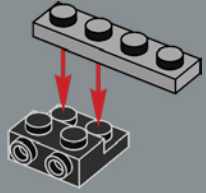

64

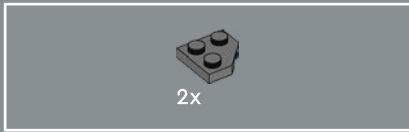
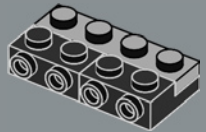

65

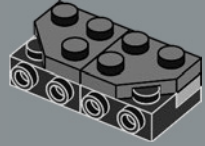

66

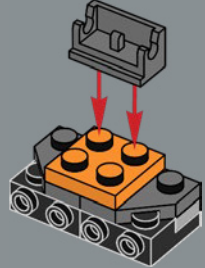

67

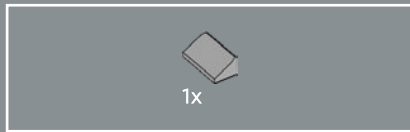

68

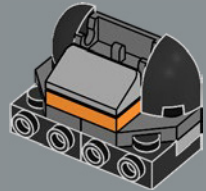

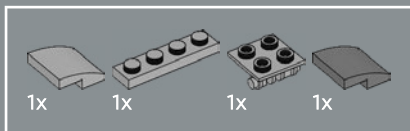

69

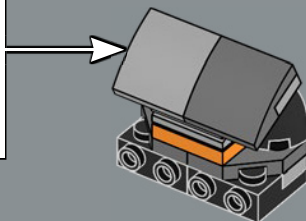
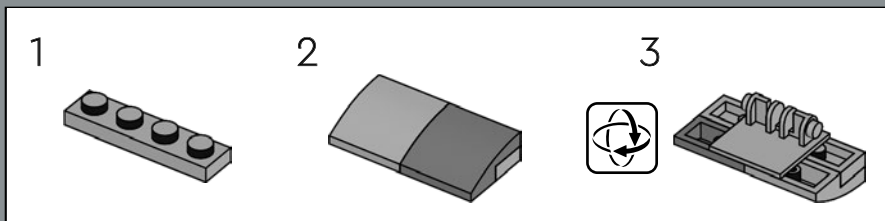

70

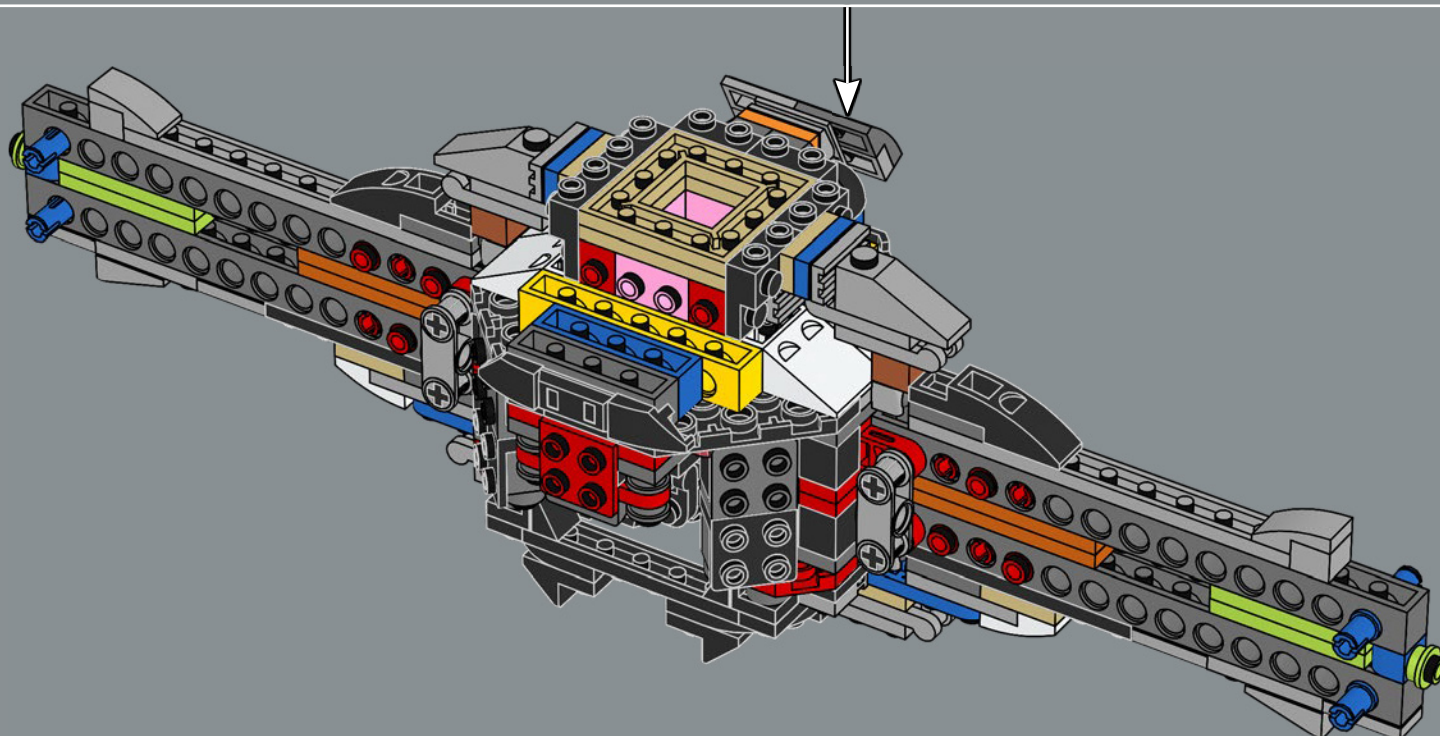



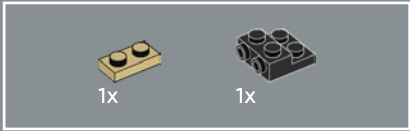
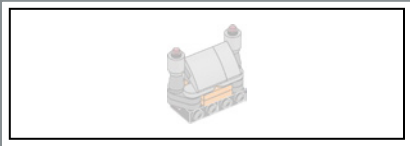

71

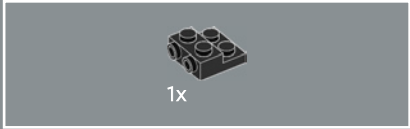
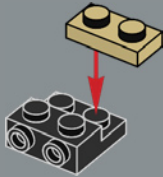

72

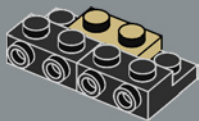

73

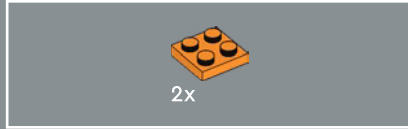
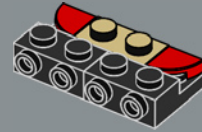

74

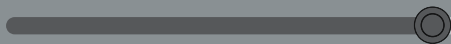
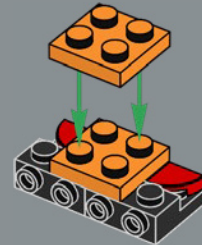

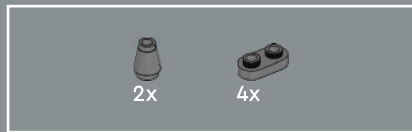

75

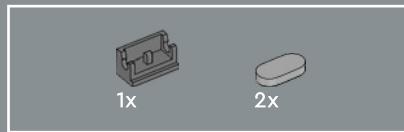
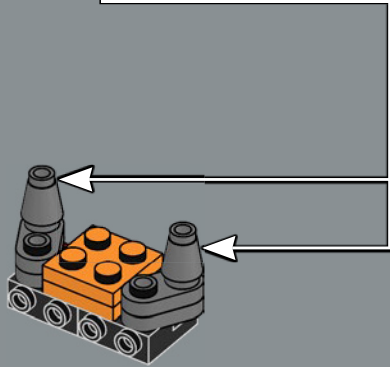
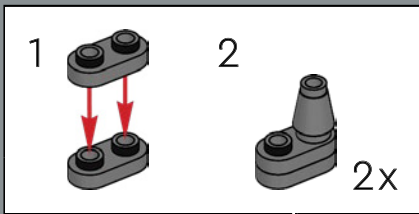

77

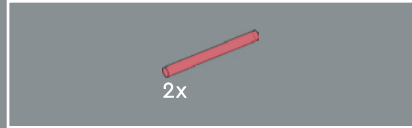
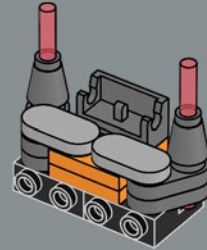

76

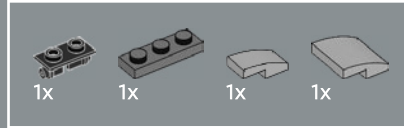
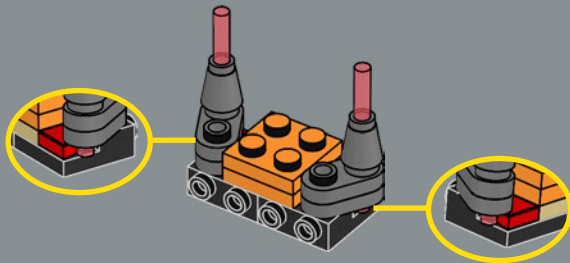

78

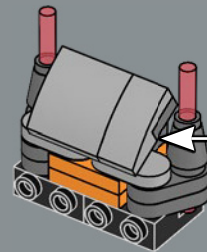
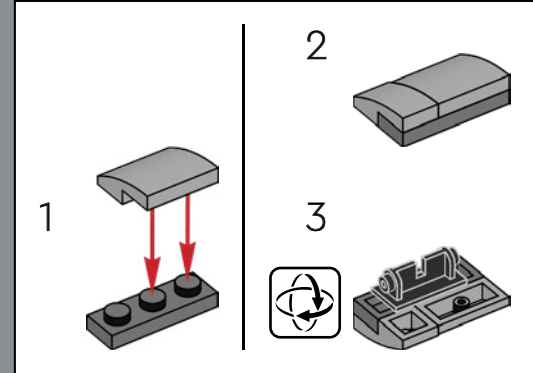



2x

79

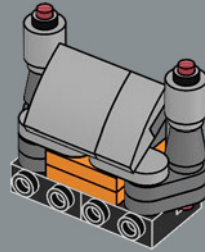

80

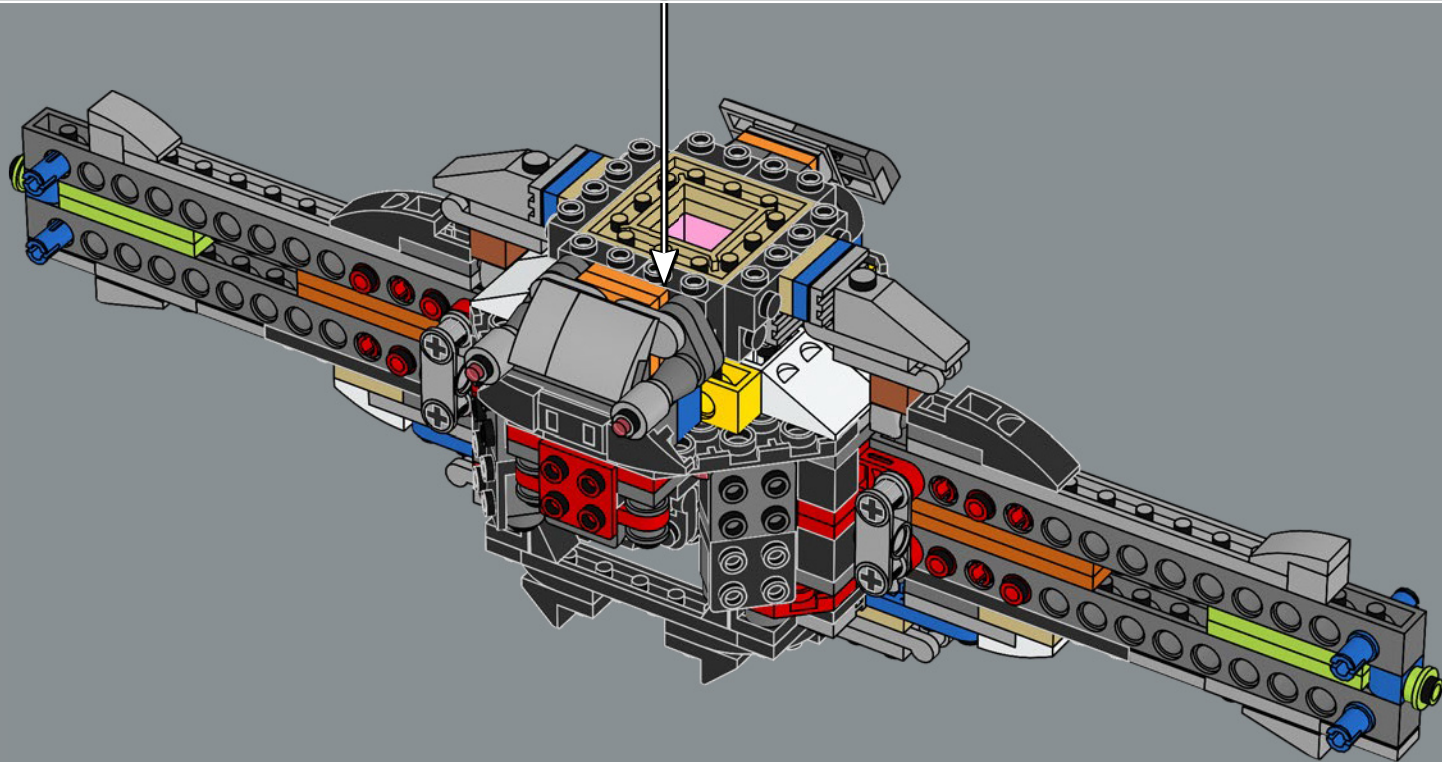



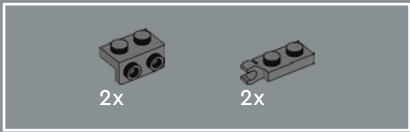

81

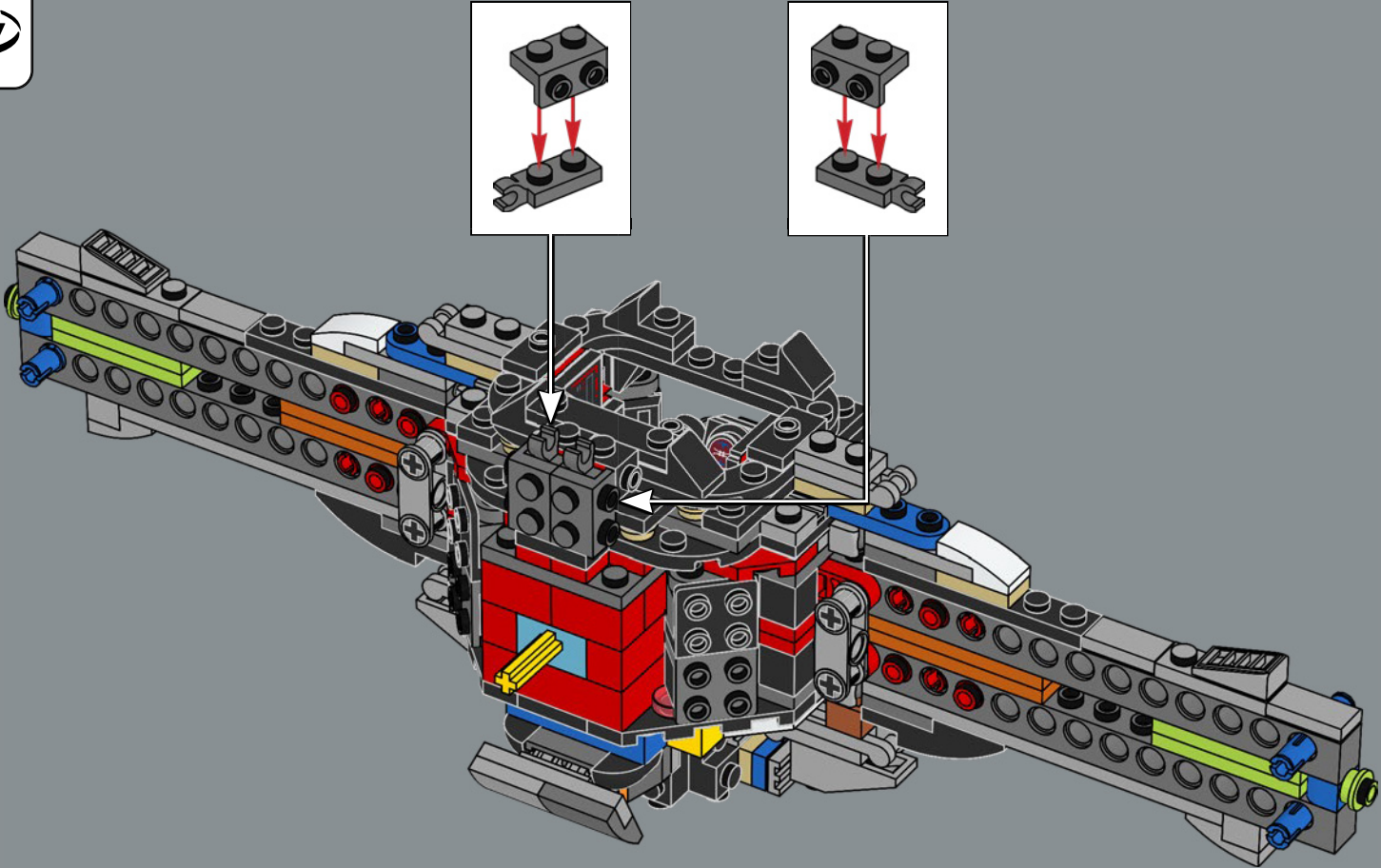

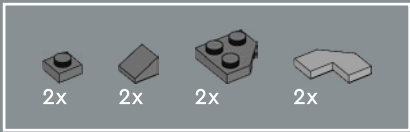

82

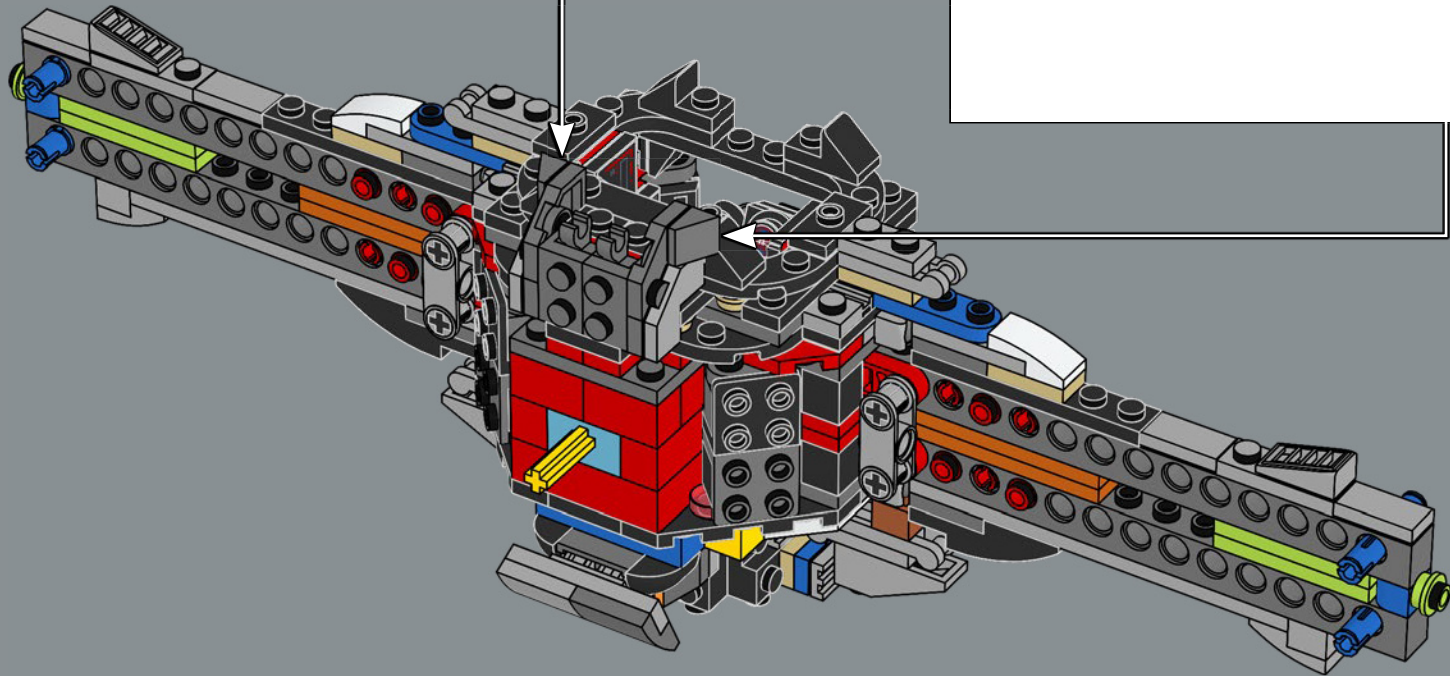
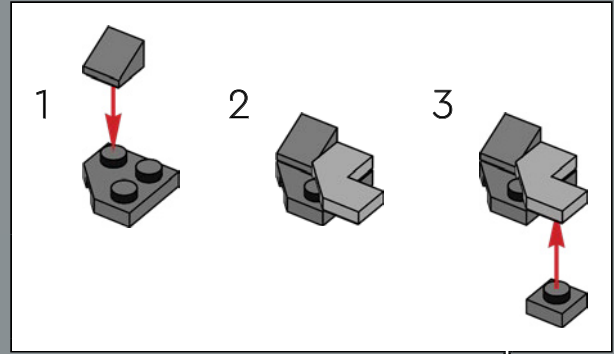
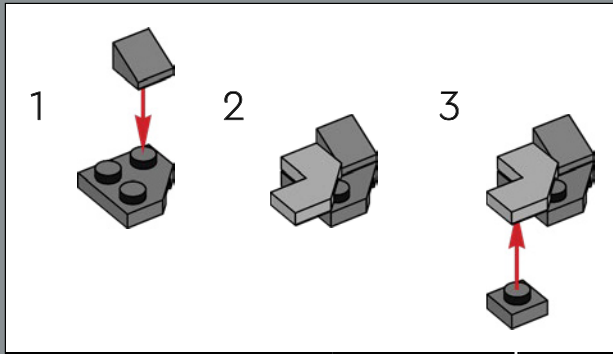

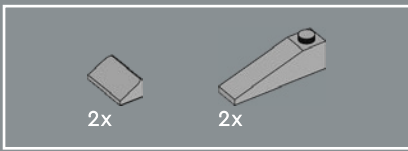

83

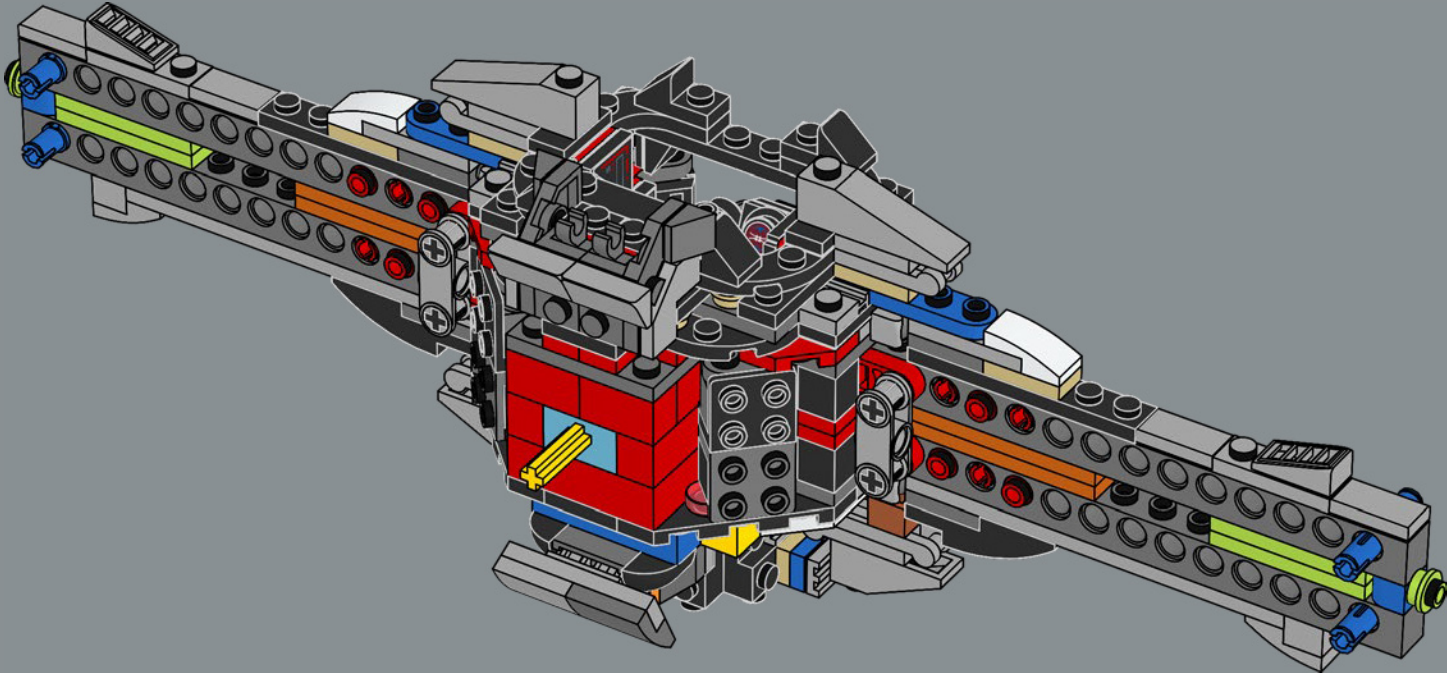





84

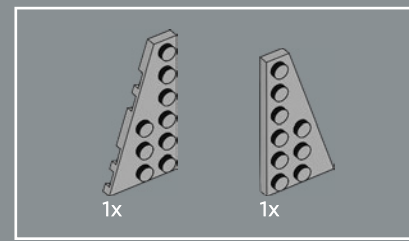
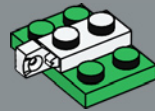

86

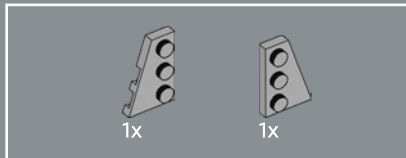
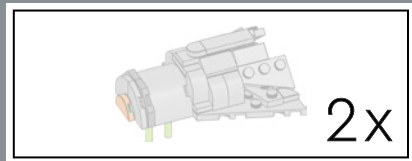
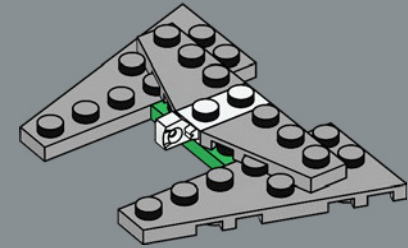

85

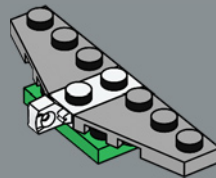

87

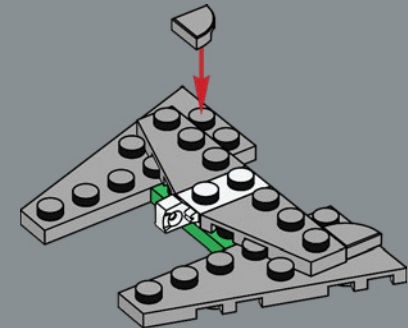

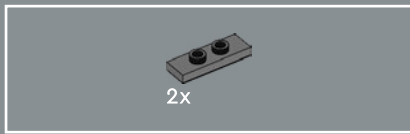

88

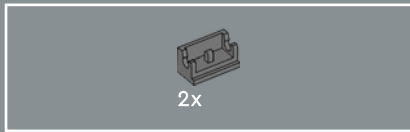
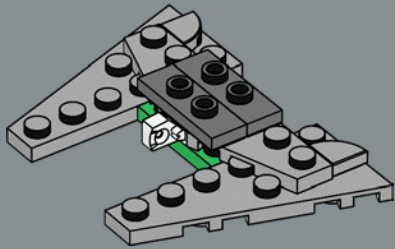

89

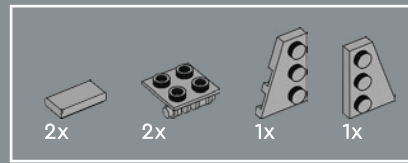
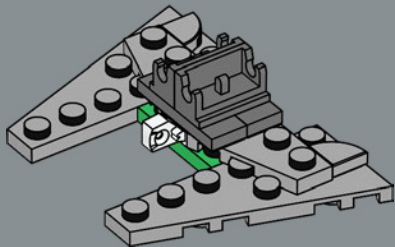

90

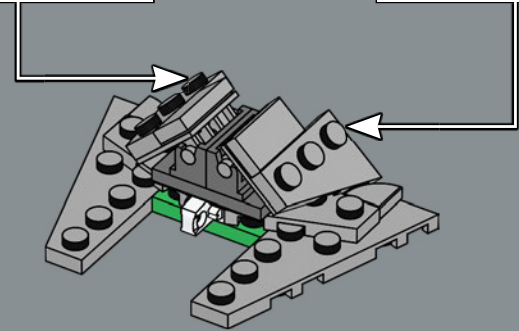
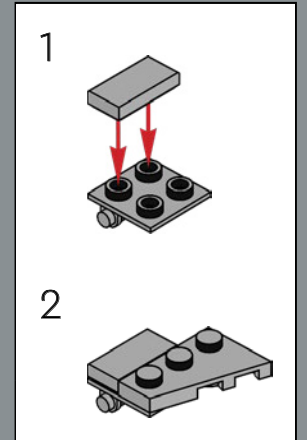
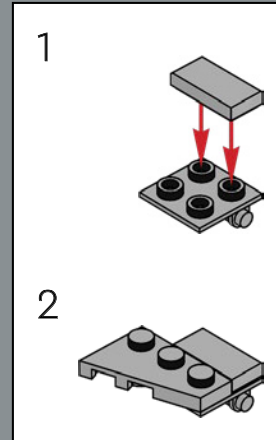



91

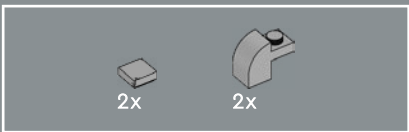
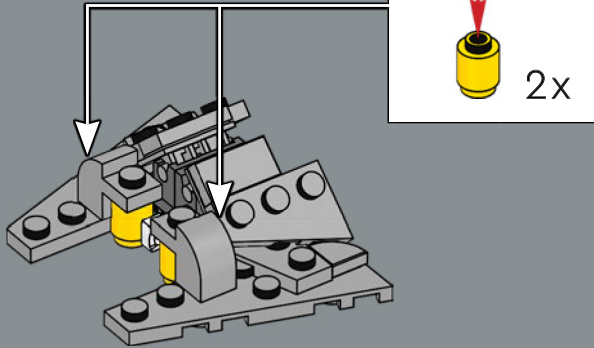

93

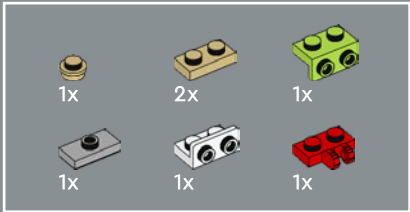
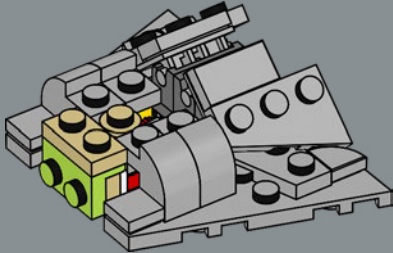

92

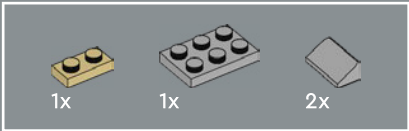
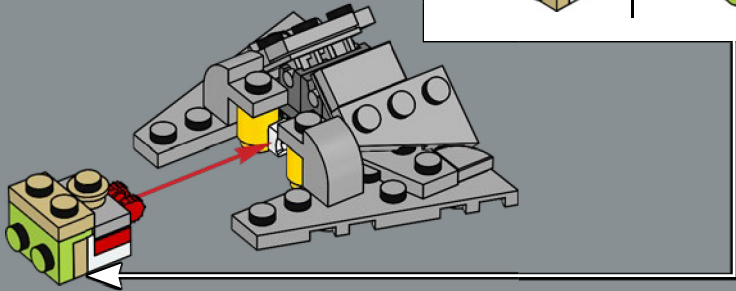
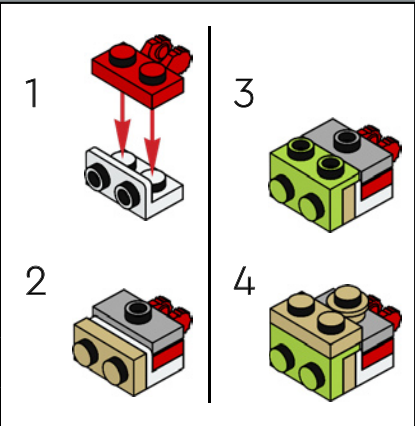

94

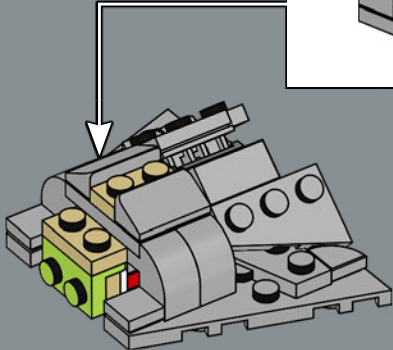
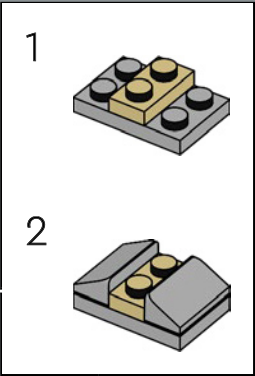





95

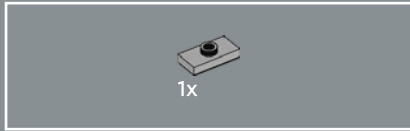
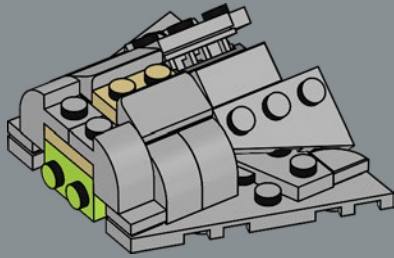

96

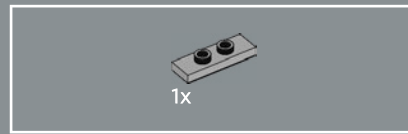
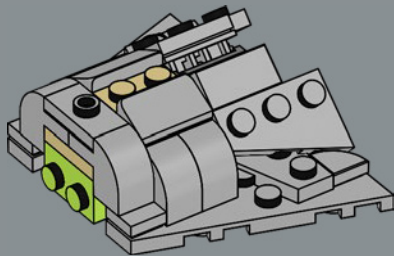

97

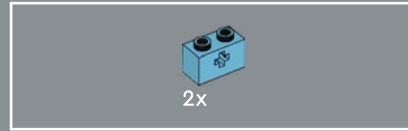
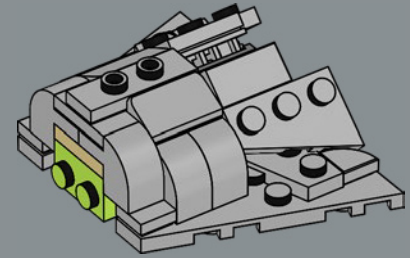

98

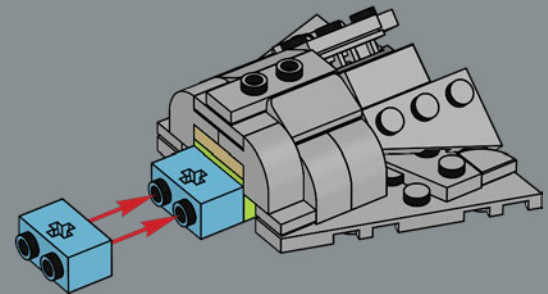

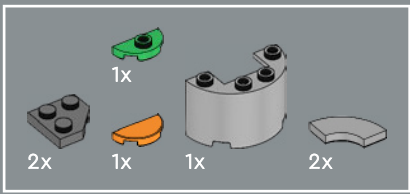

99

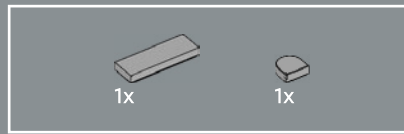
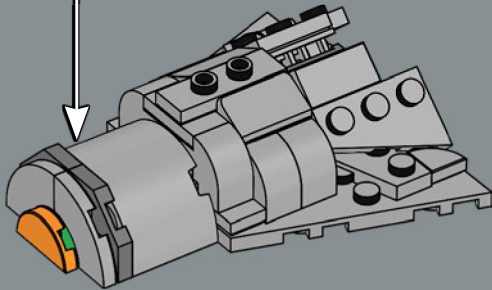
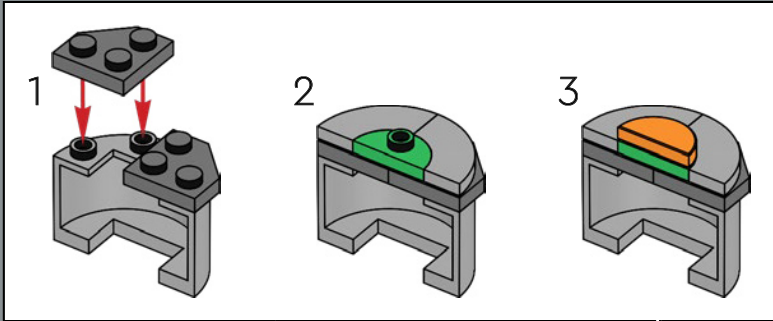

100

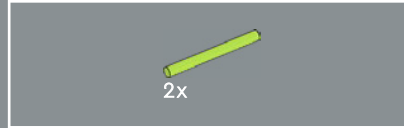
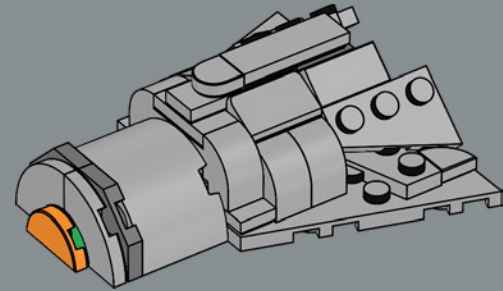

101

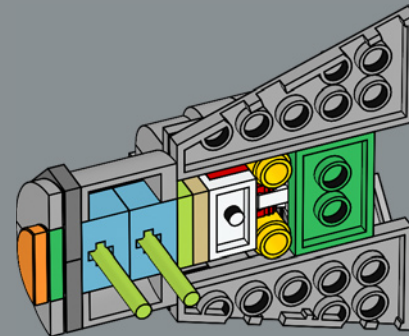

2x

102

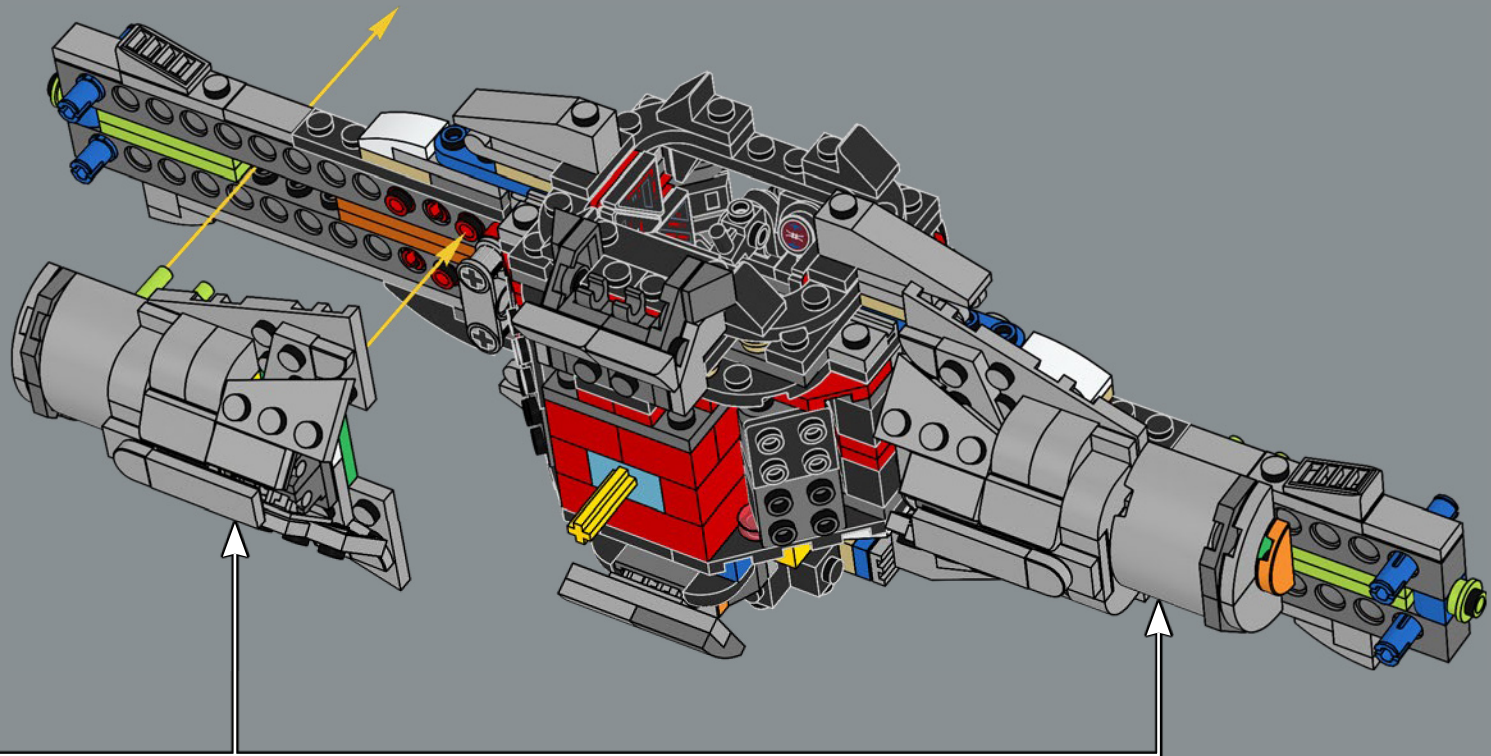





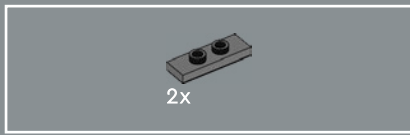

107

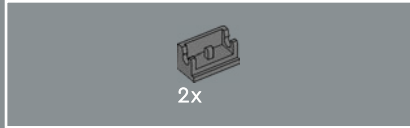
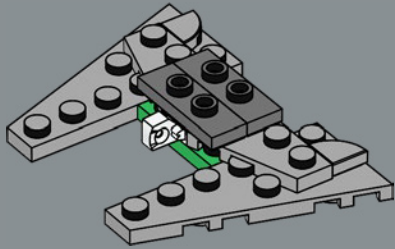

108

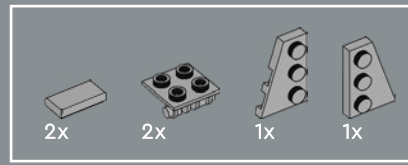
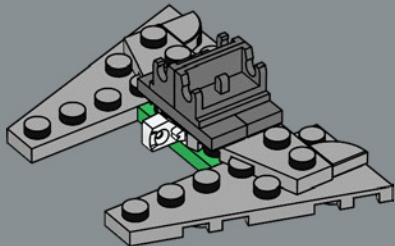

109

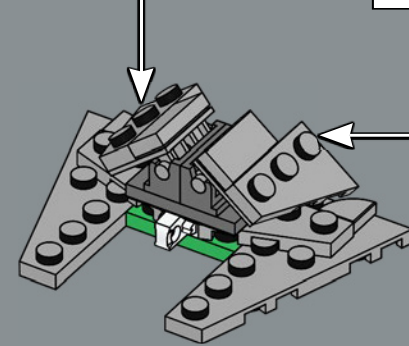
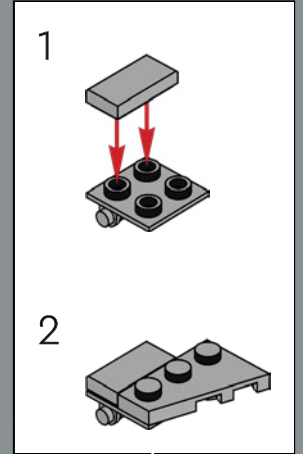
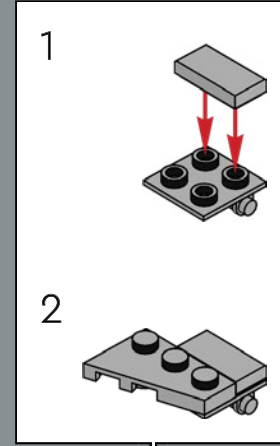



110

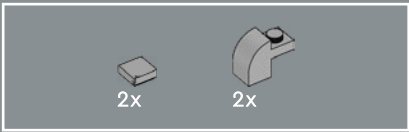
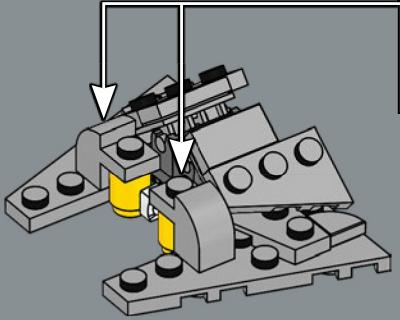
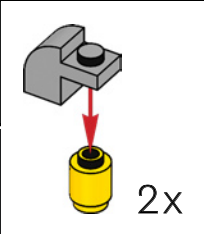

112

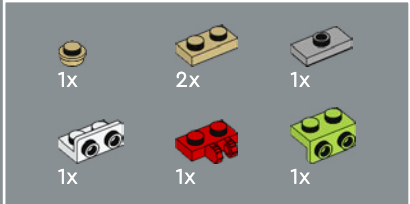
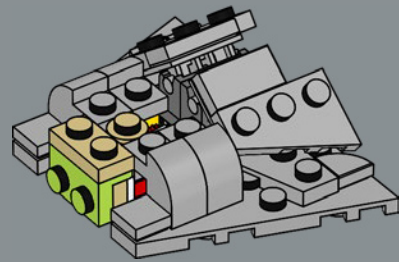

111

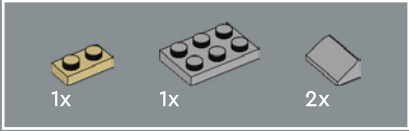
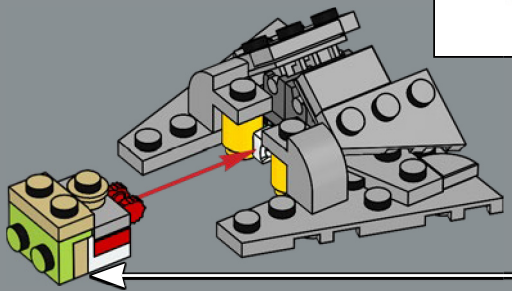
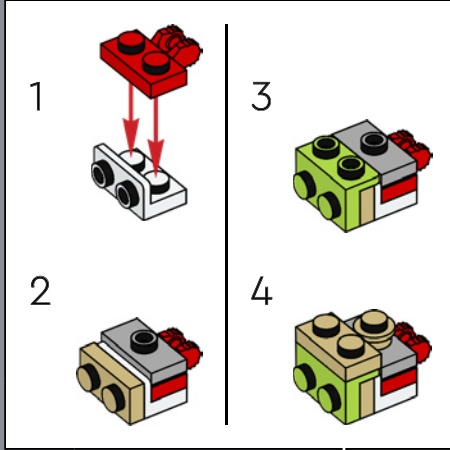

113

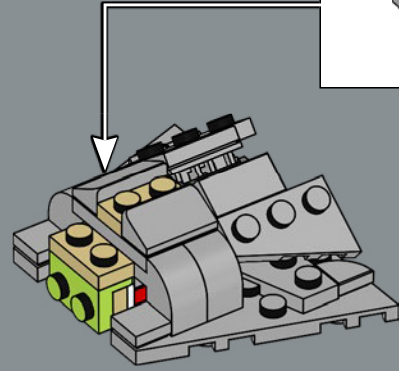
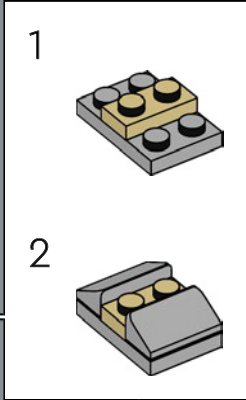





114

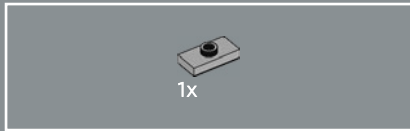
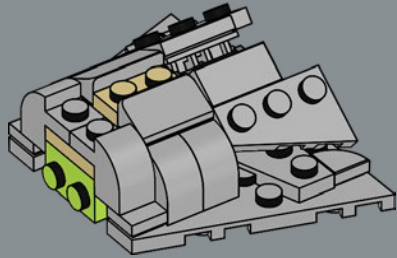

115

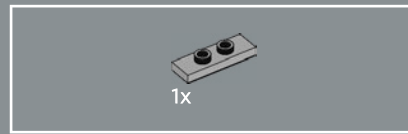
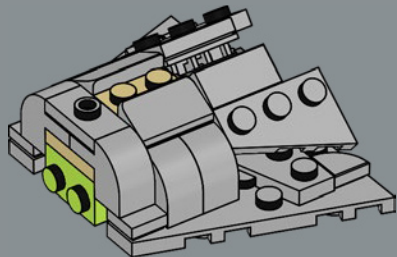

116

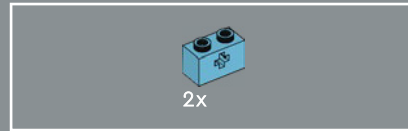
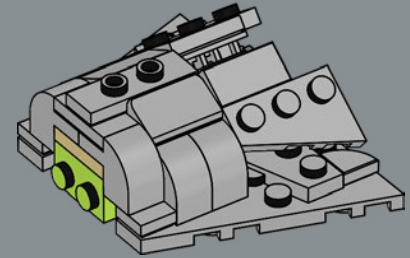

117

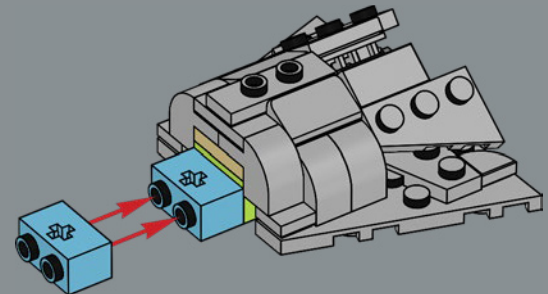

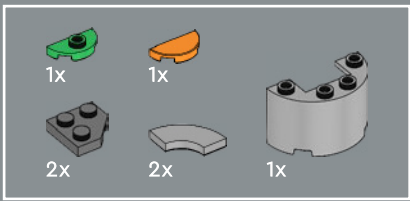

118

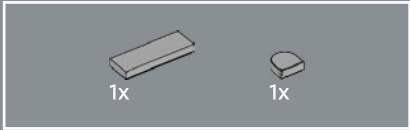
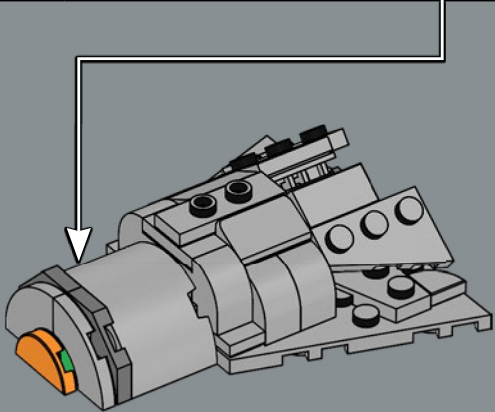
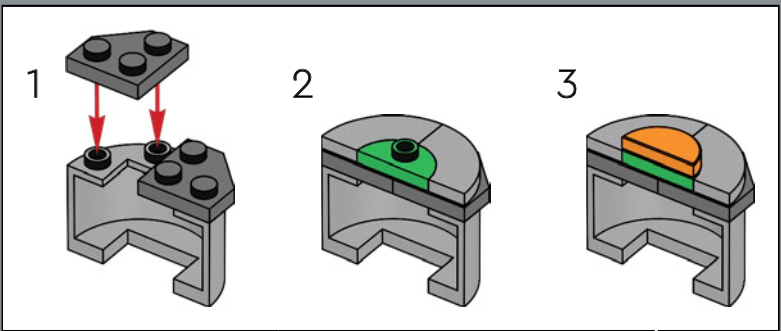

119

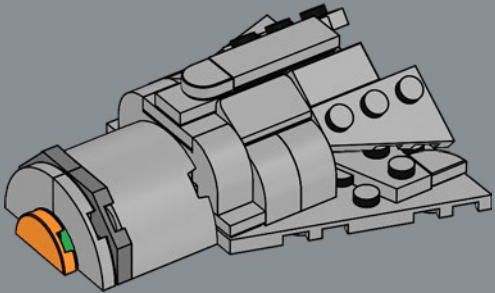

2x

120

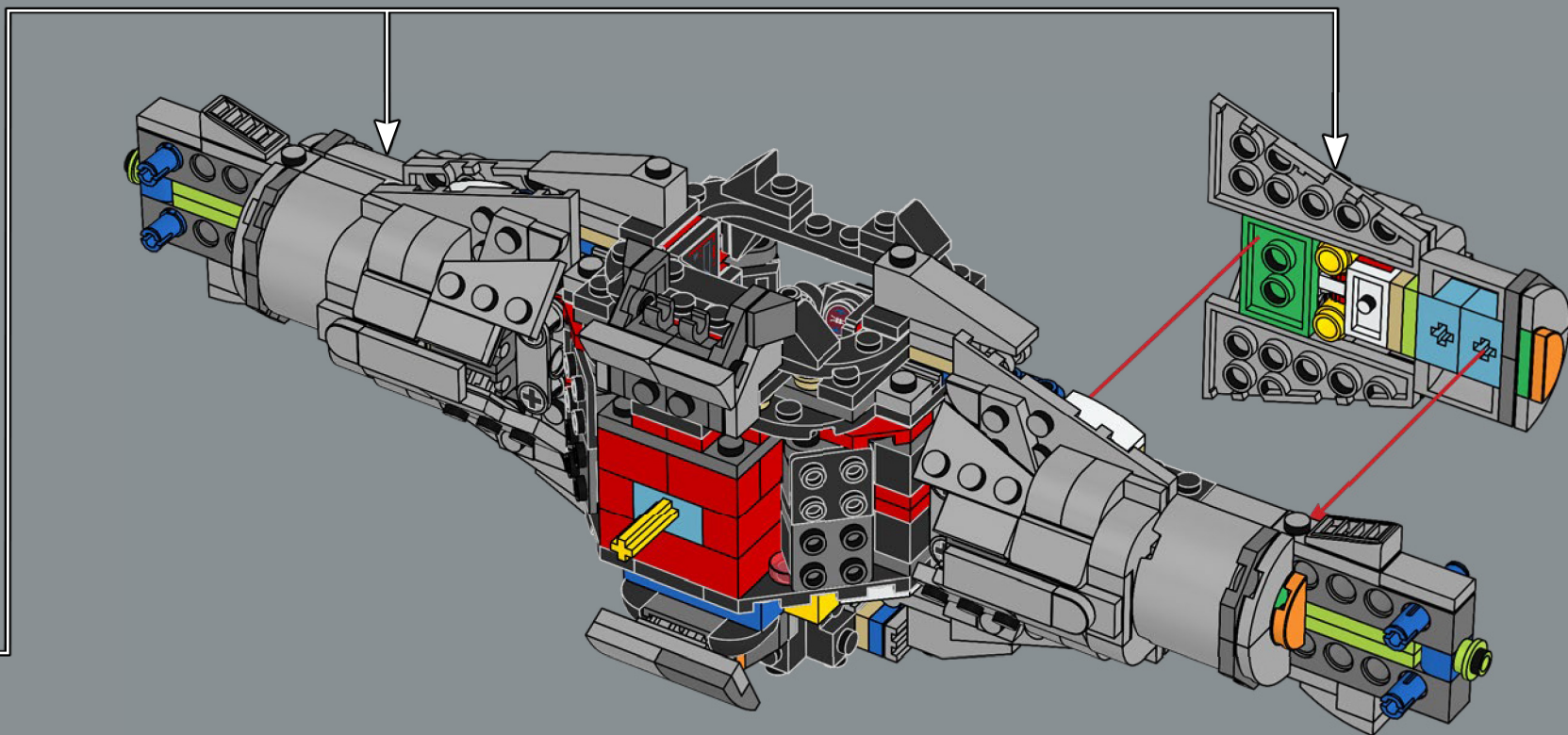

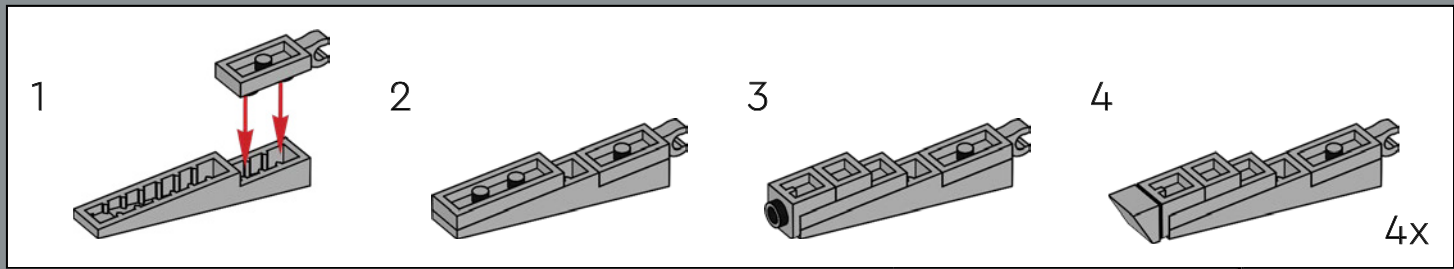
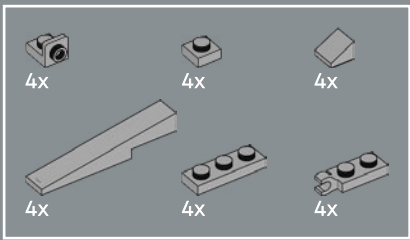

121

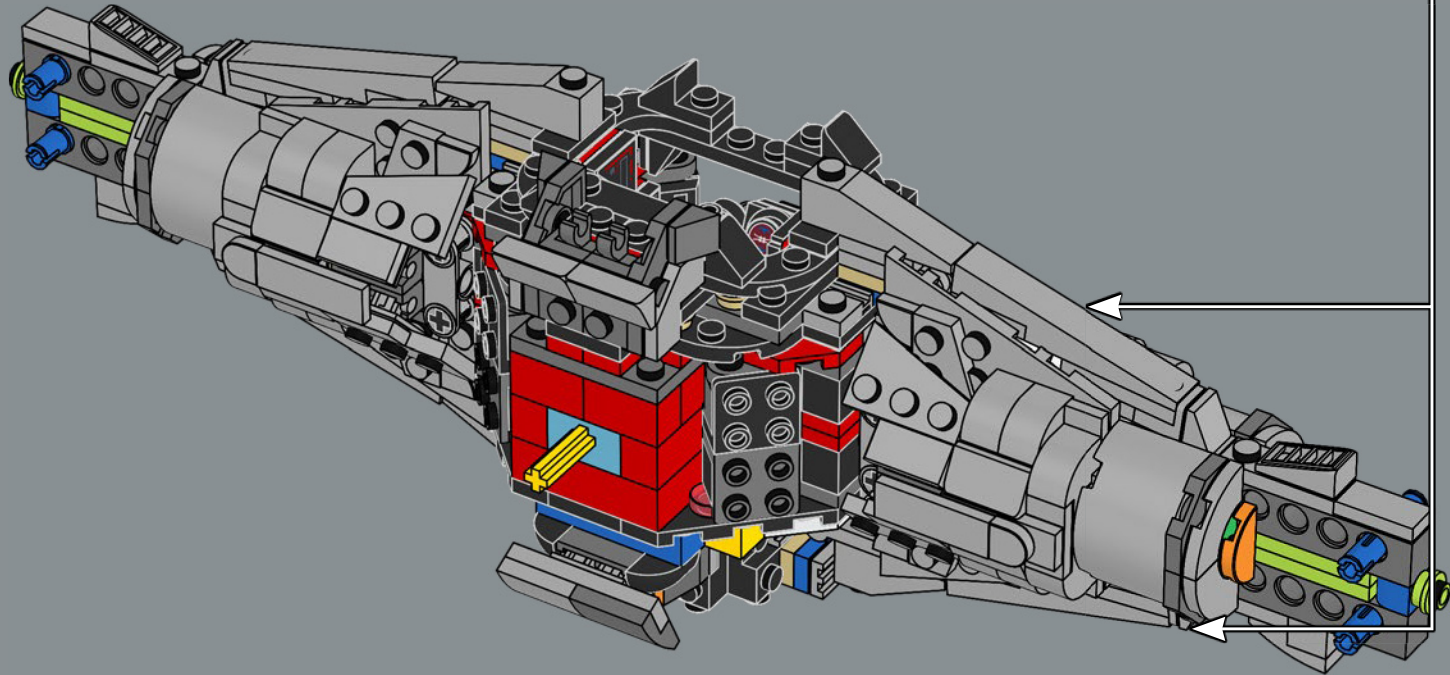







2x

125

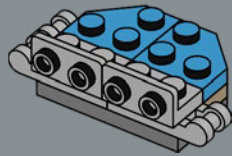

2x



3x

126

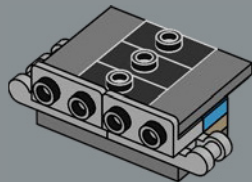

1x

127

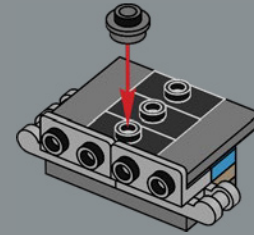

1x



2x

128

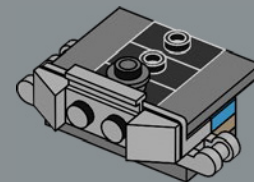

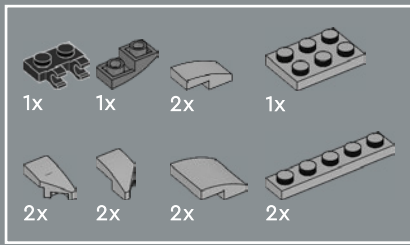

129

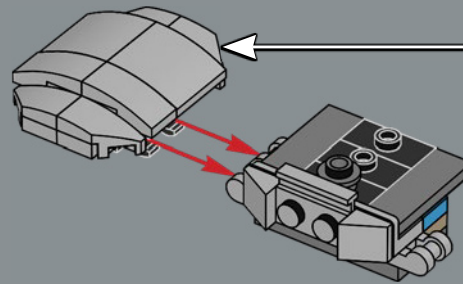
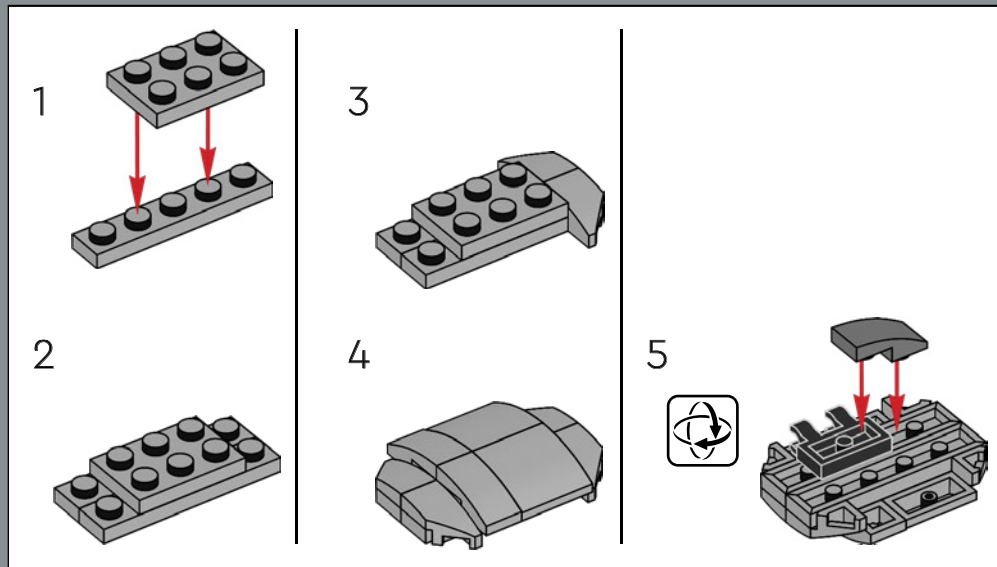

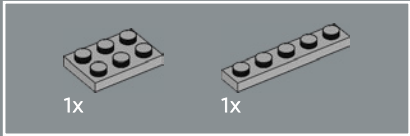

130

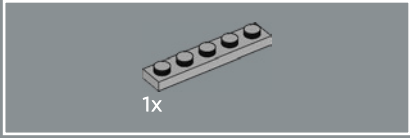
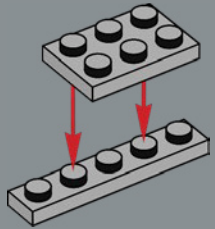

131

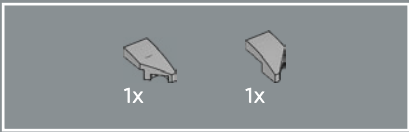
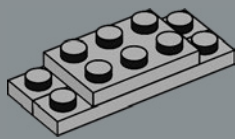

132

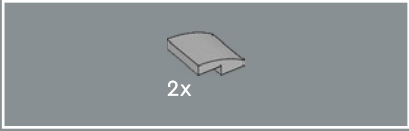
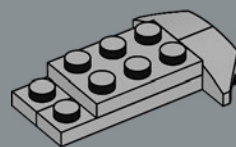

133

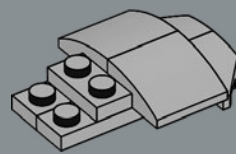



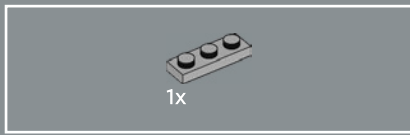

134

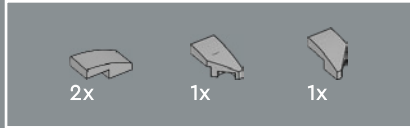
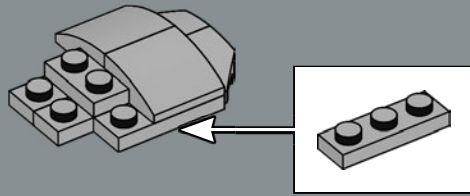

135

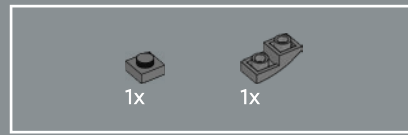
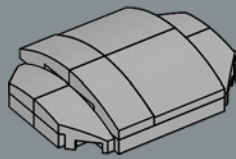

136

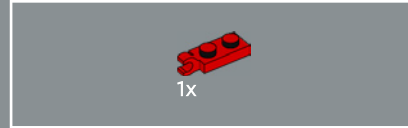
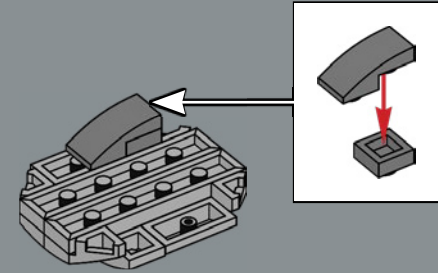

137

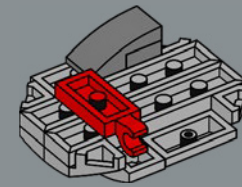

138

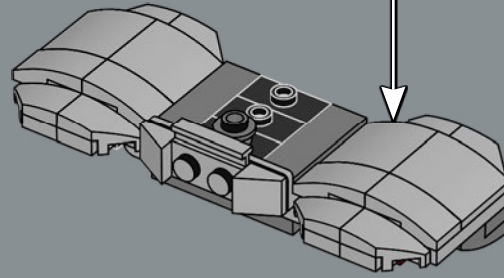

139

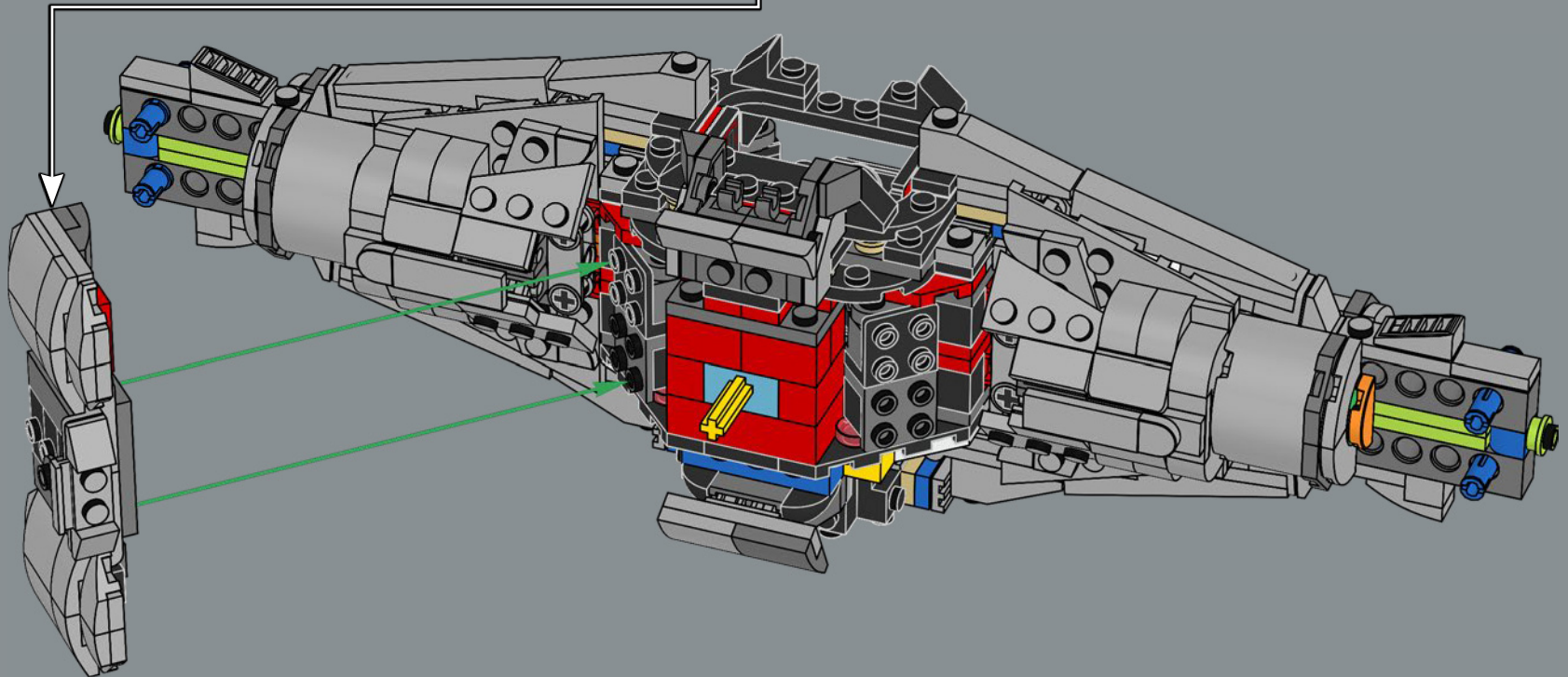

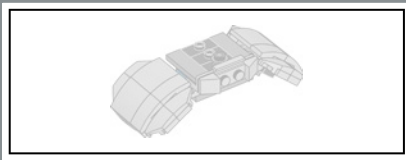

140

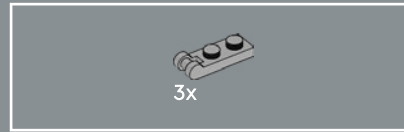
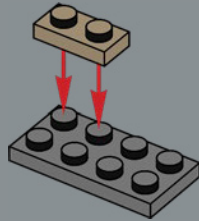

141

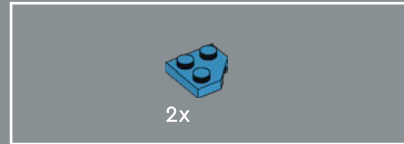
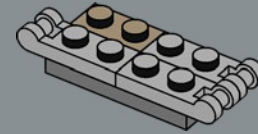

142

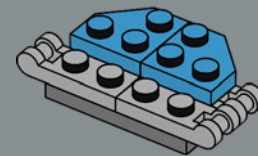



2x

143

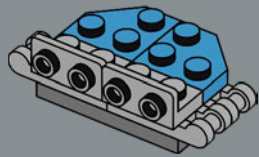

2x



3x

144

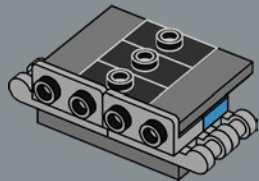

1x

145

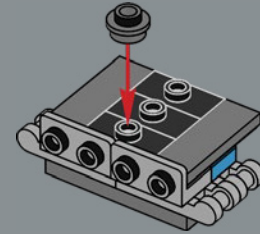

1x



2x

146

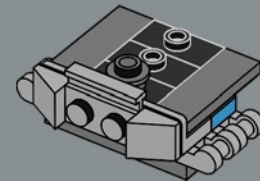



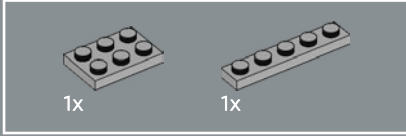
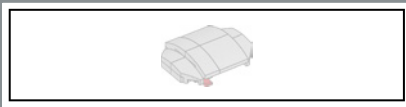

147

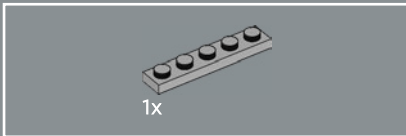
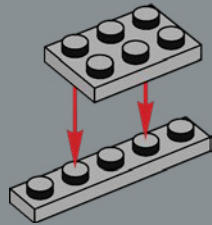

148

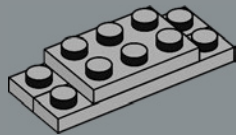

149

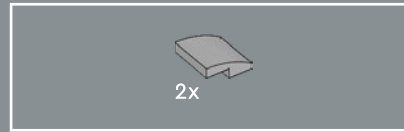
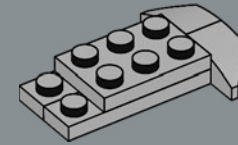

150

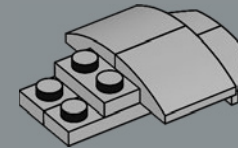

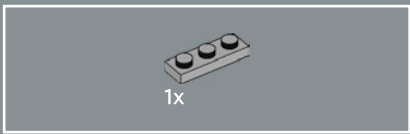

151

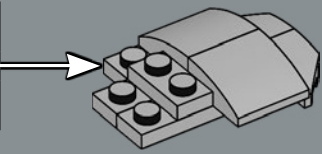
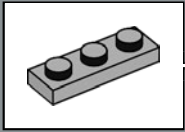

152

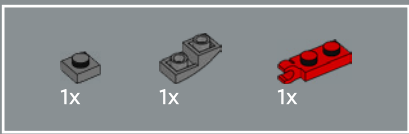
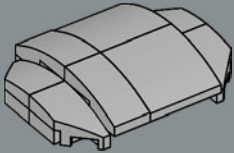

153

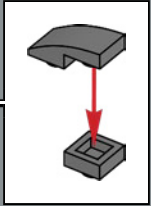
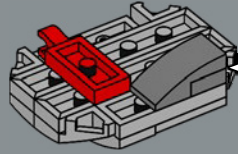

154

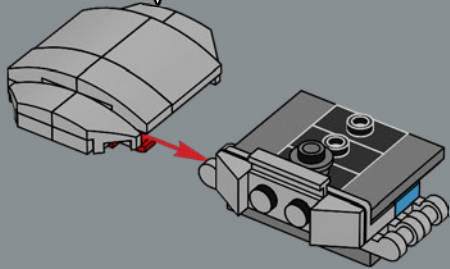

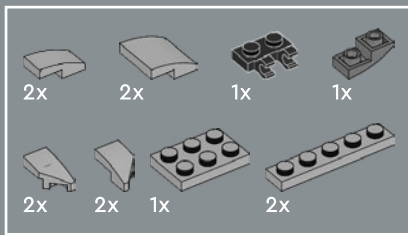

155

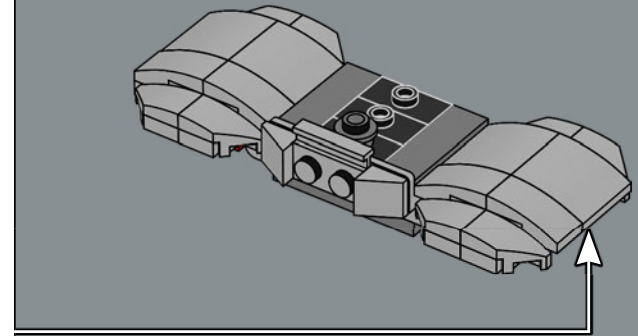
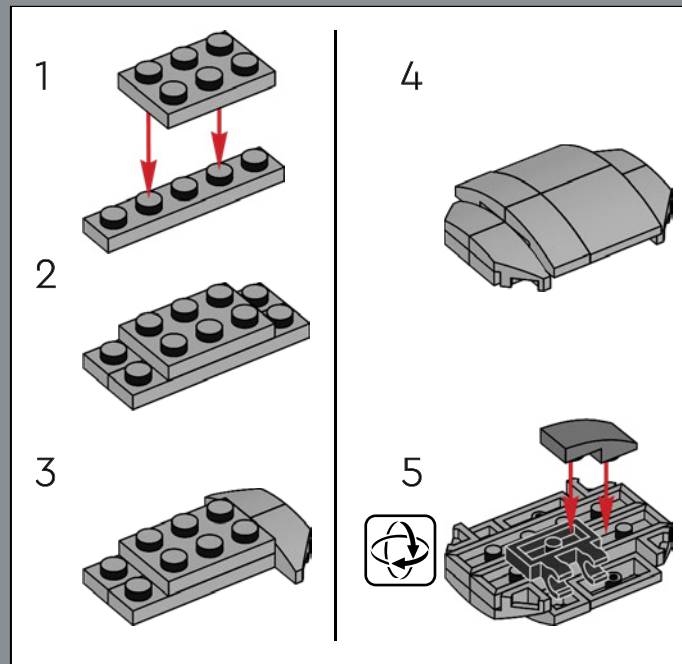

156

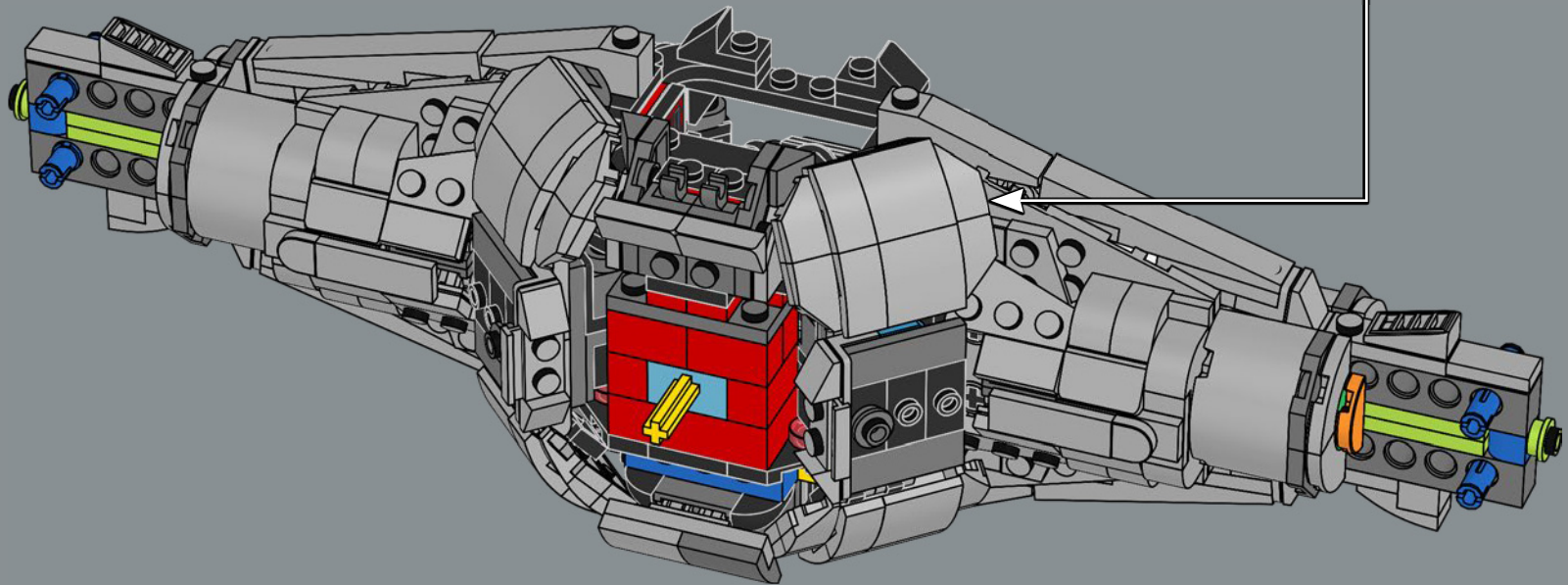

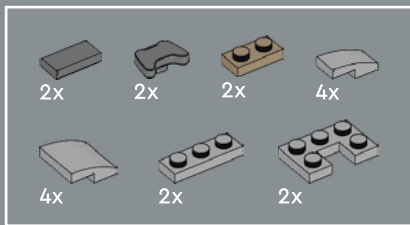

157

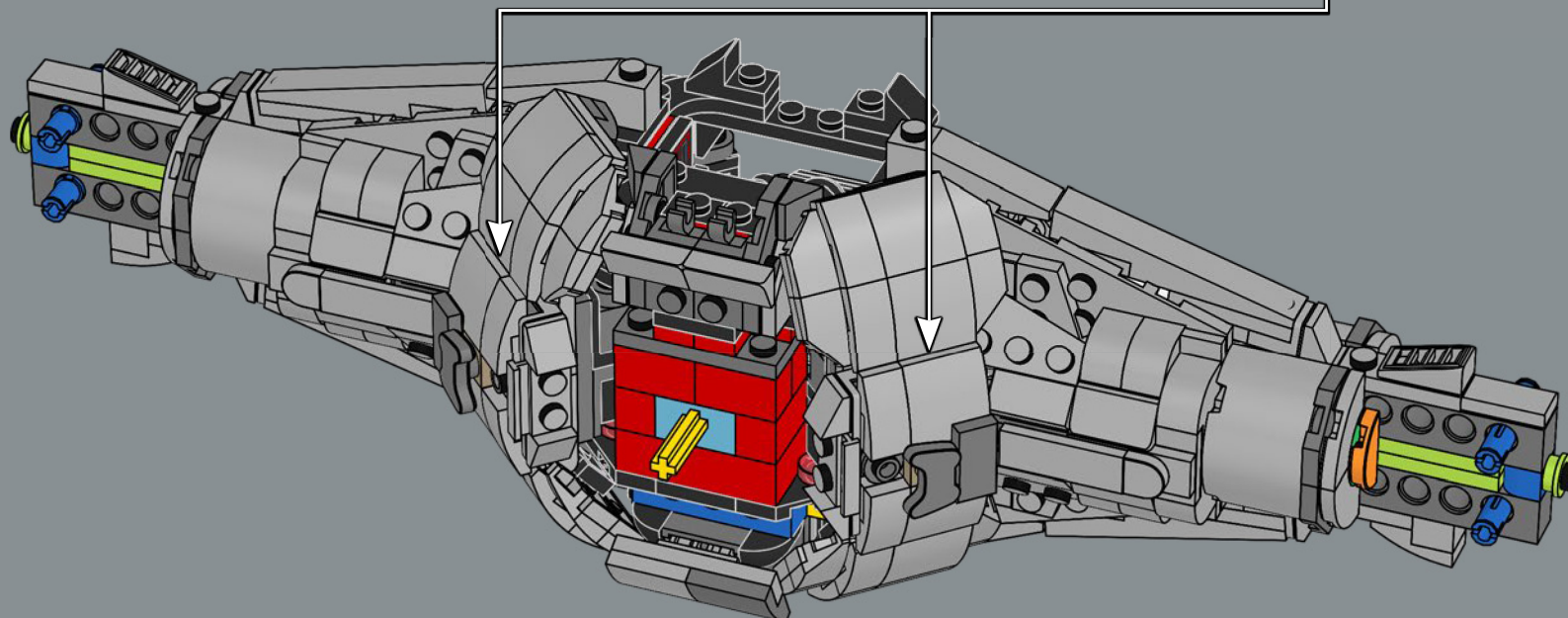
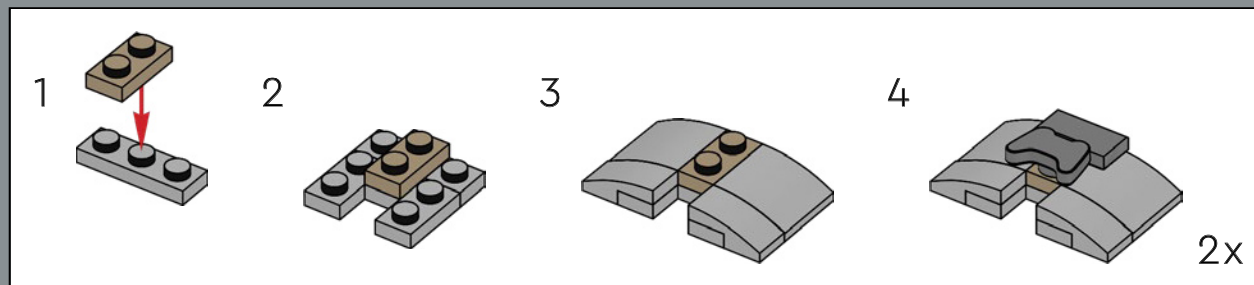



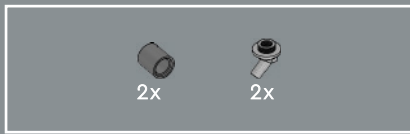

158

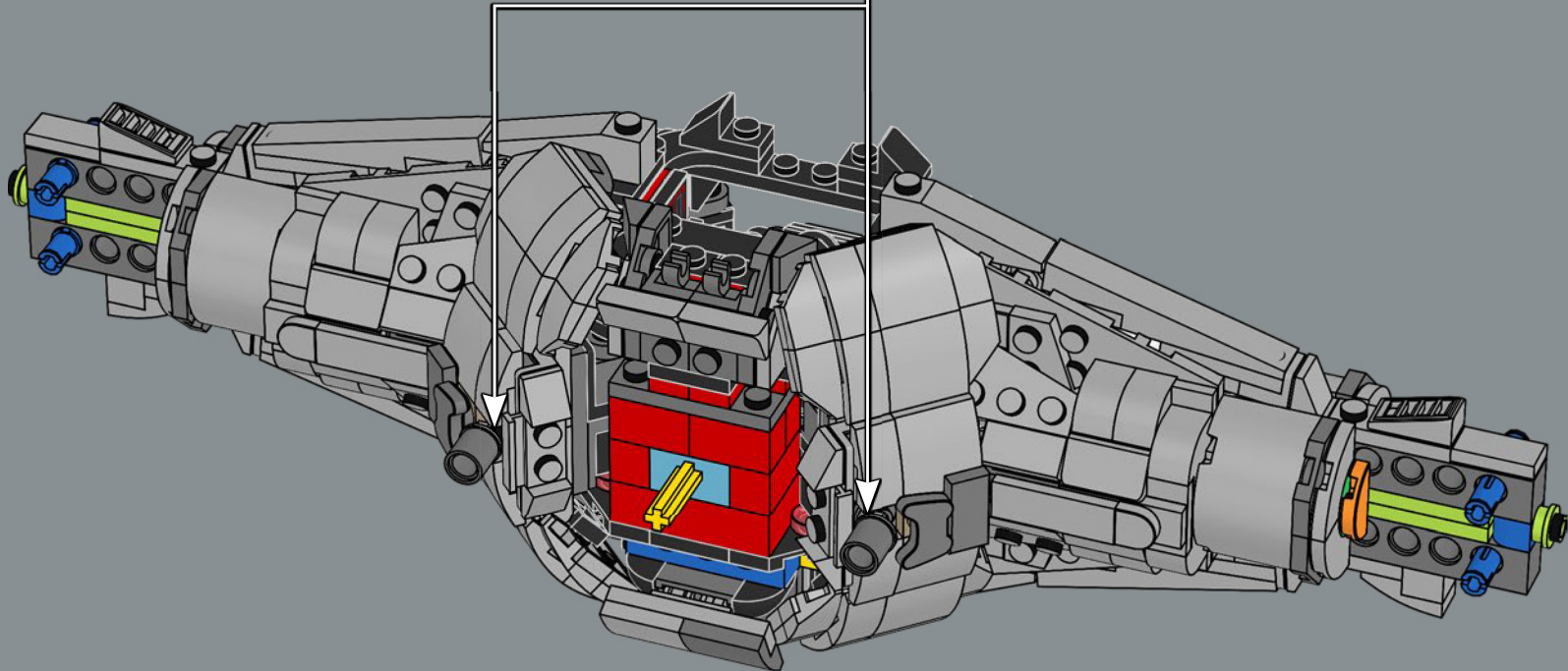
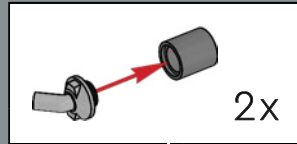



160

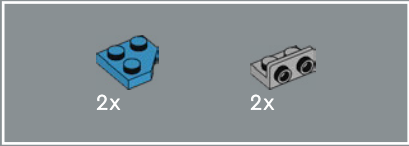
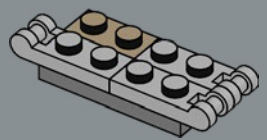

161

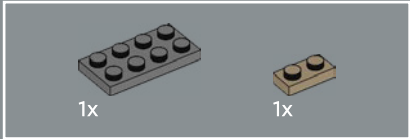
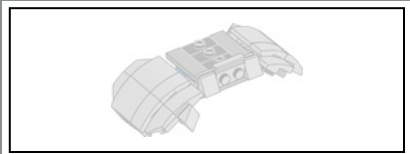
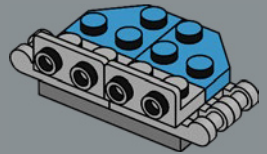

159

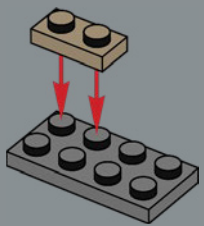

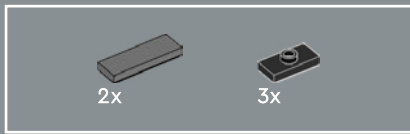

162

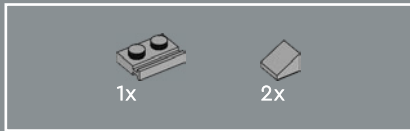
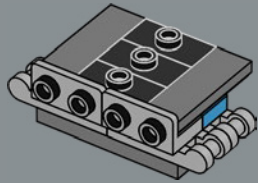

163

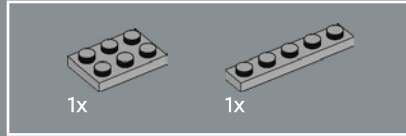
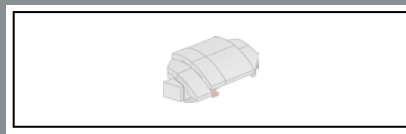
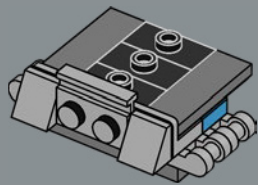

164

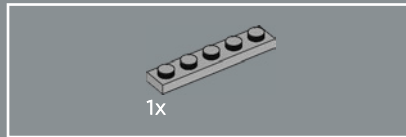
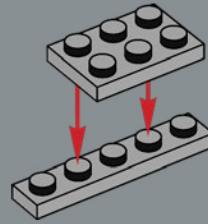

165

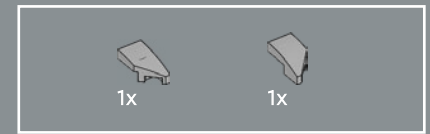
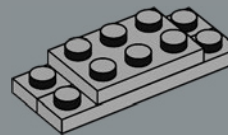

166

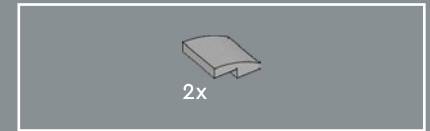
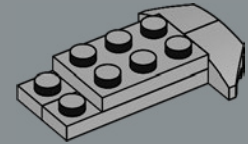

167

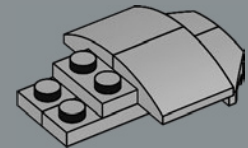

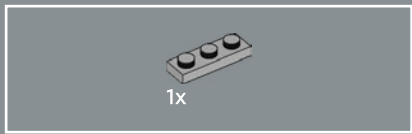

168

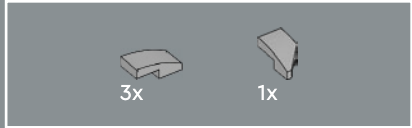
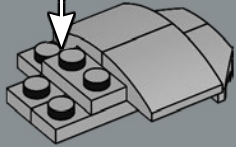
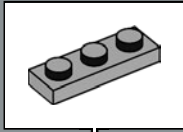

169

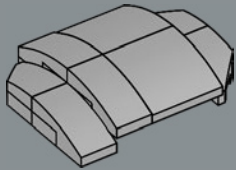

170

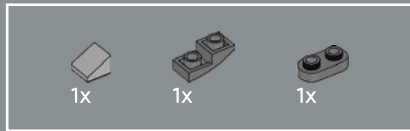
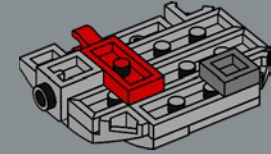

171

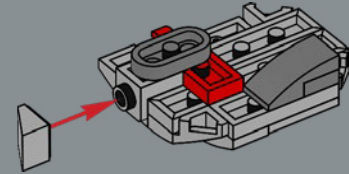

172

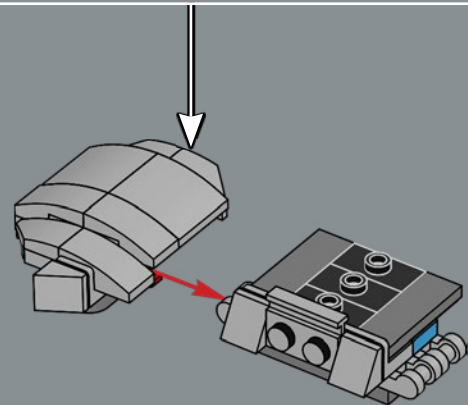



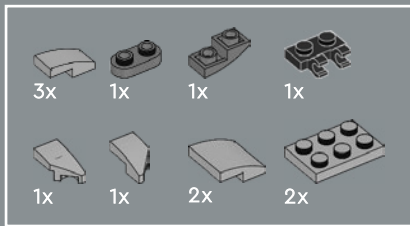

173

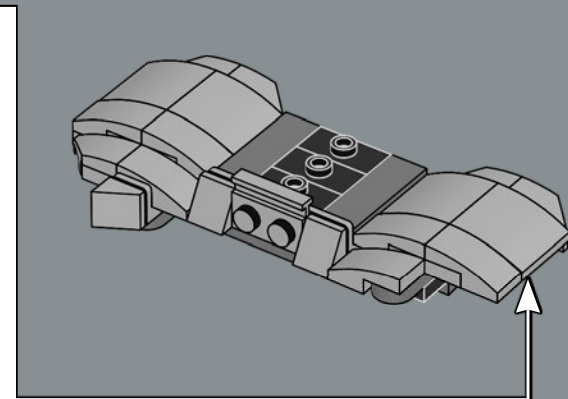
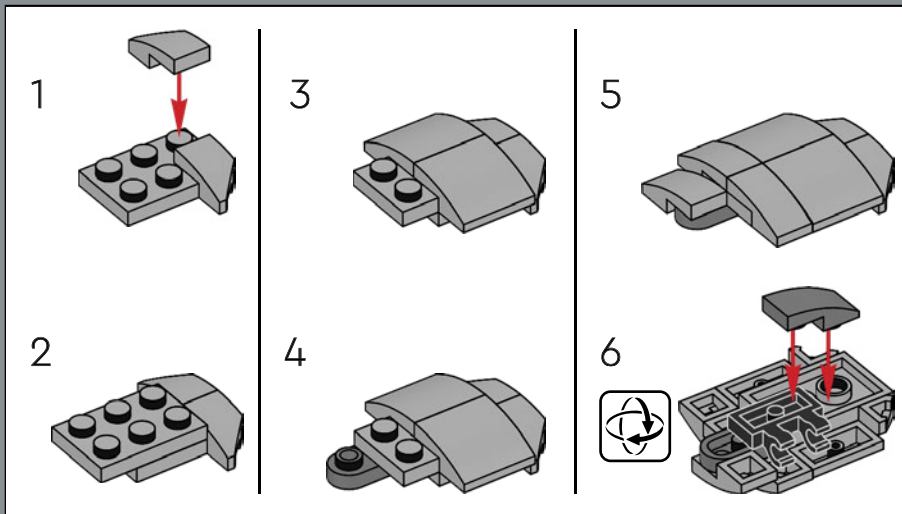

174

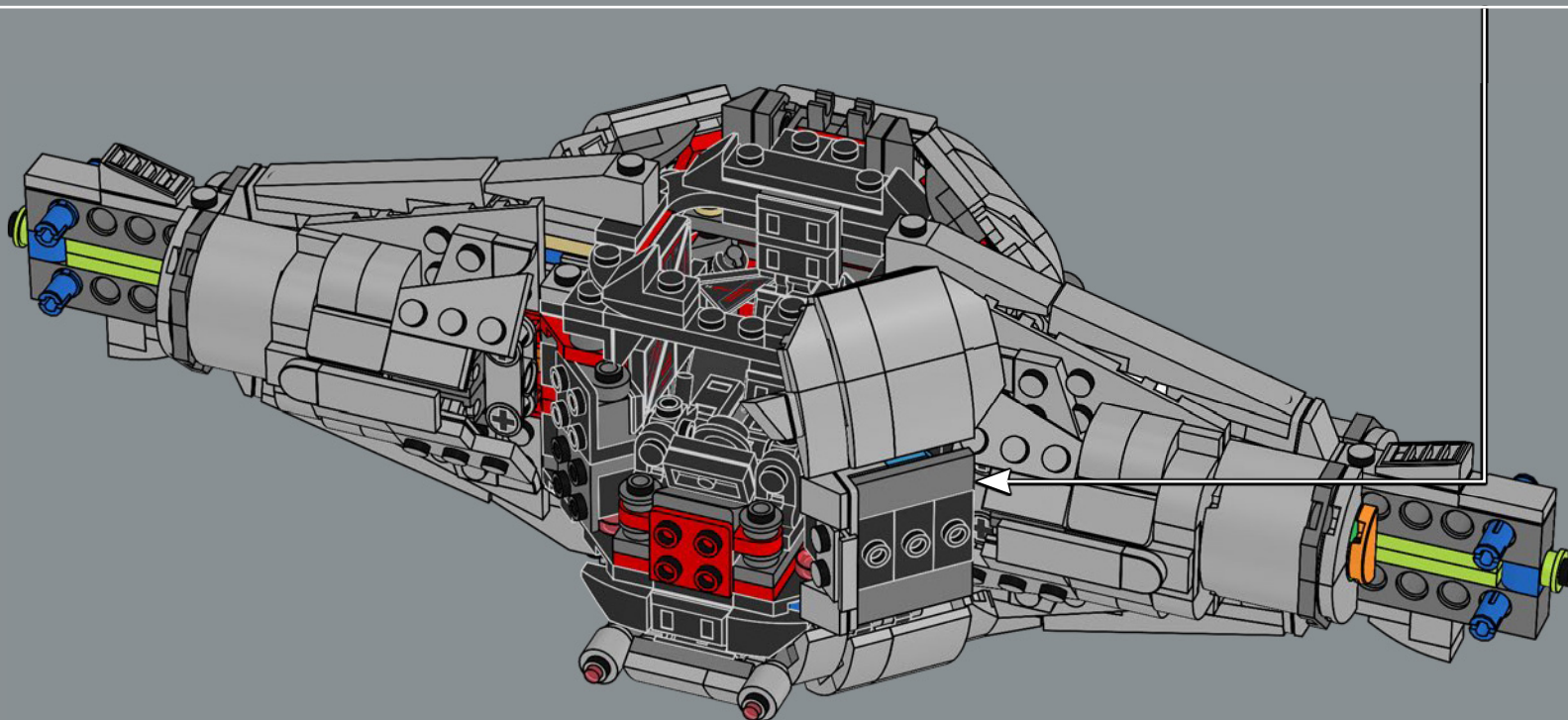

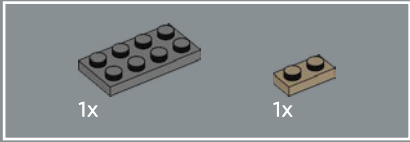
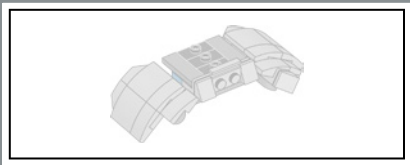

175

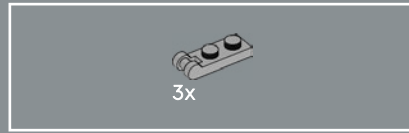
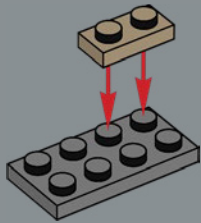

176

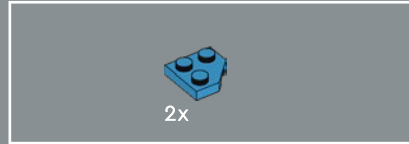
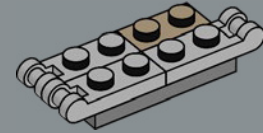

177

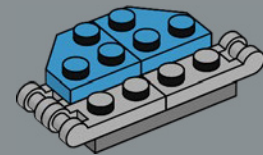



178

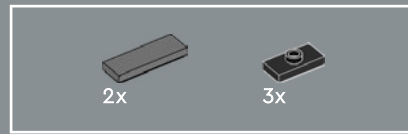
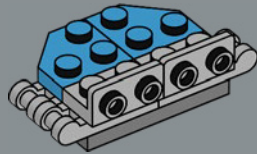

179

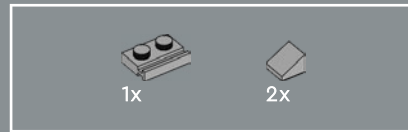
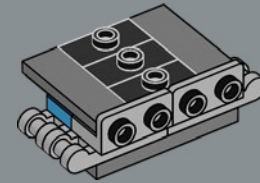

180

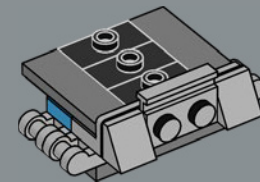





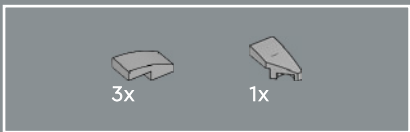

186

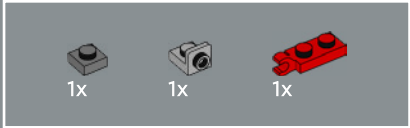
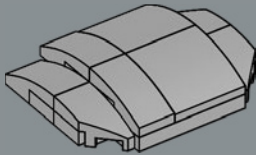

187

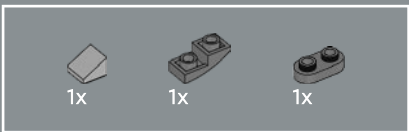
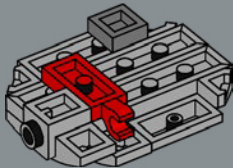

188

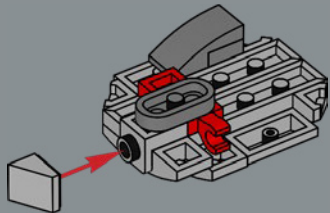

189

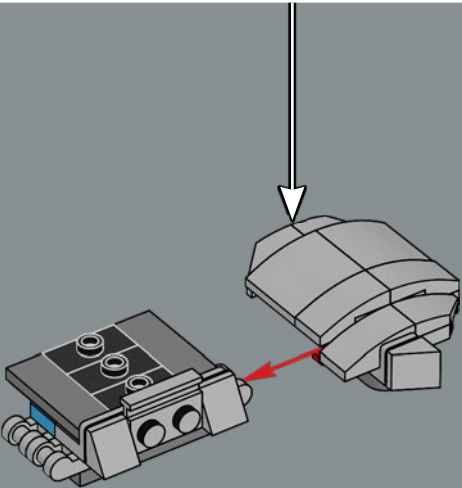

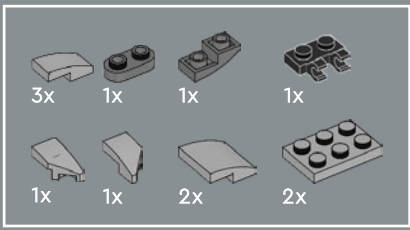

190

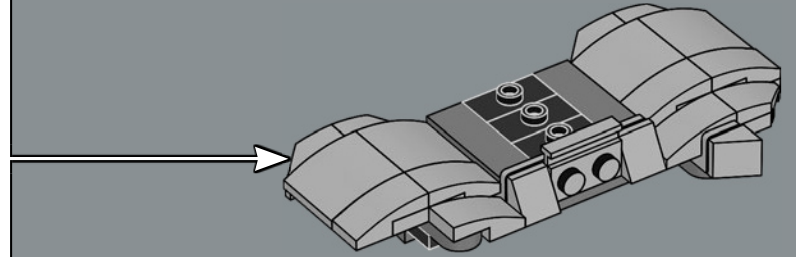
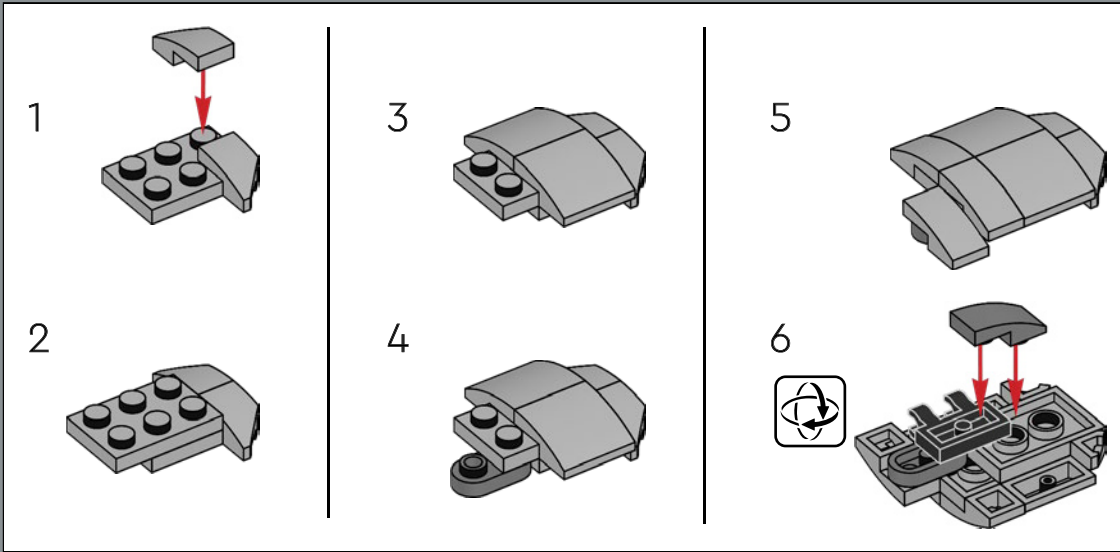

191

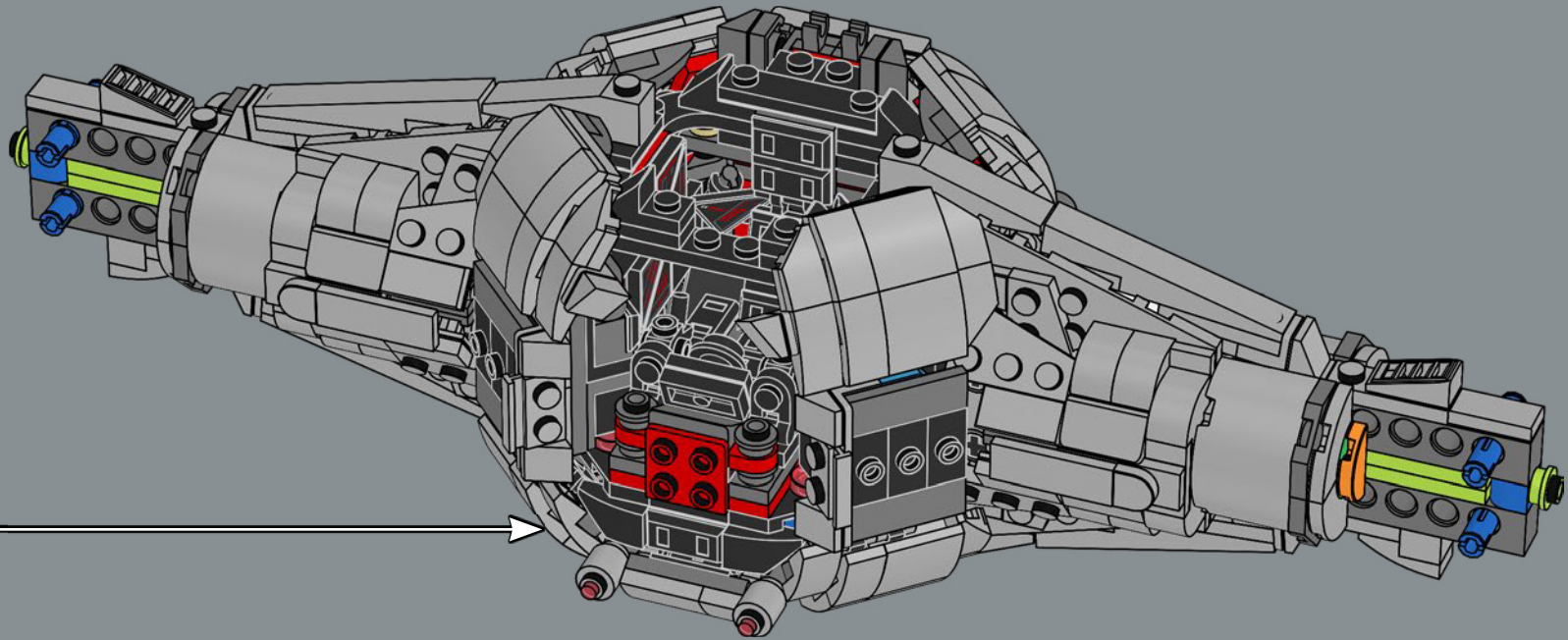

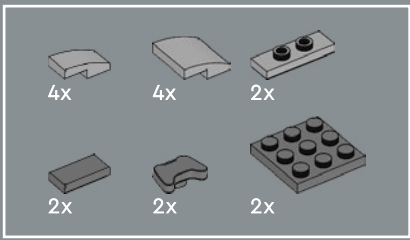

192

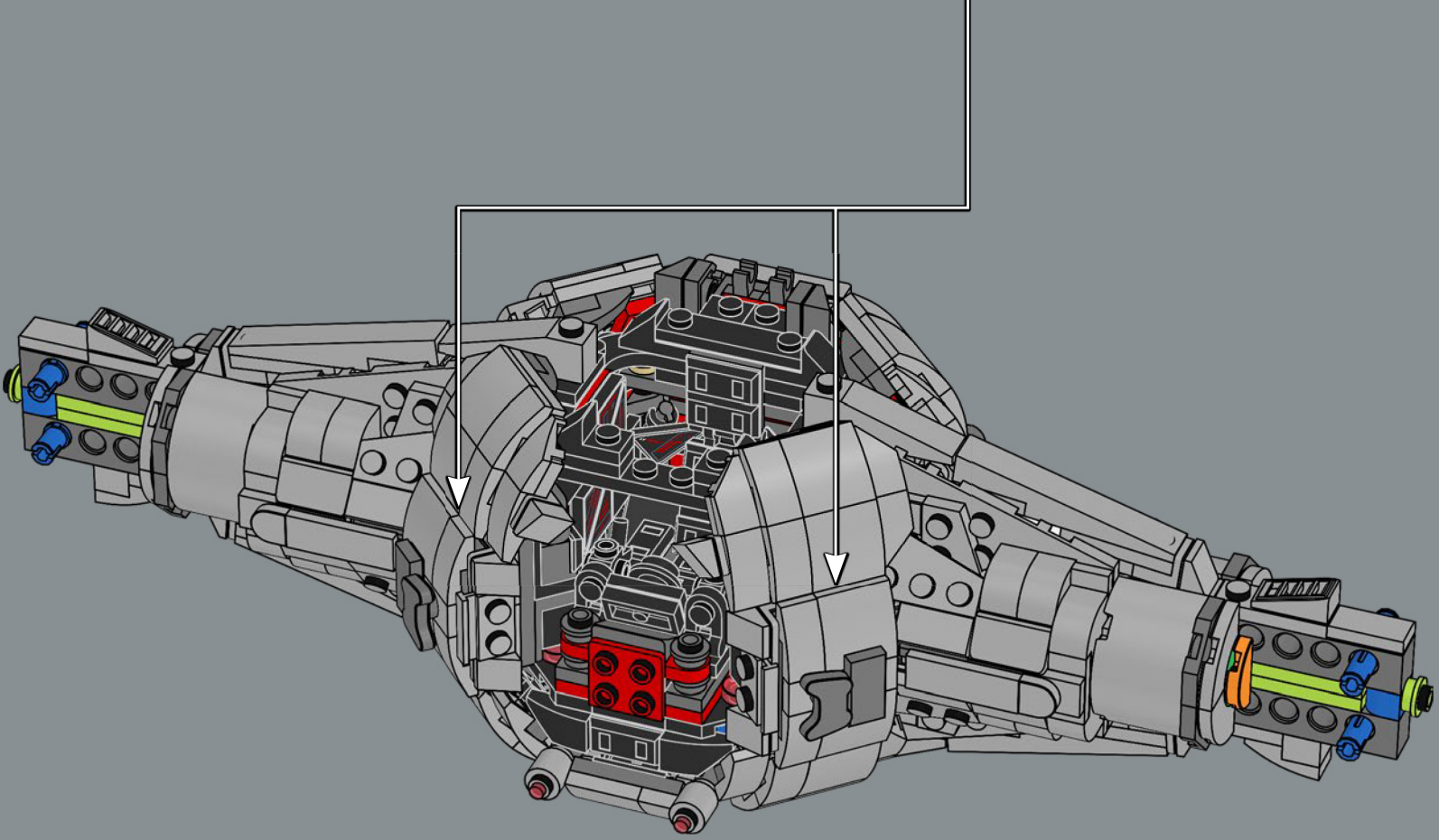
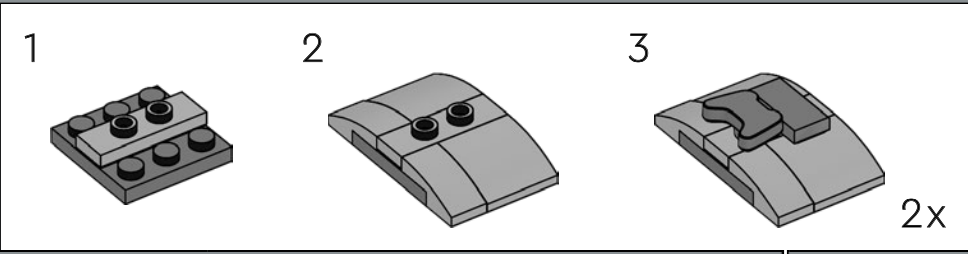





193

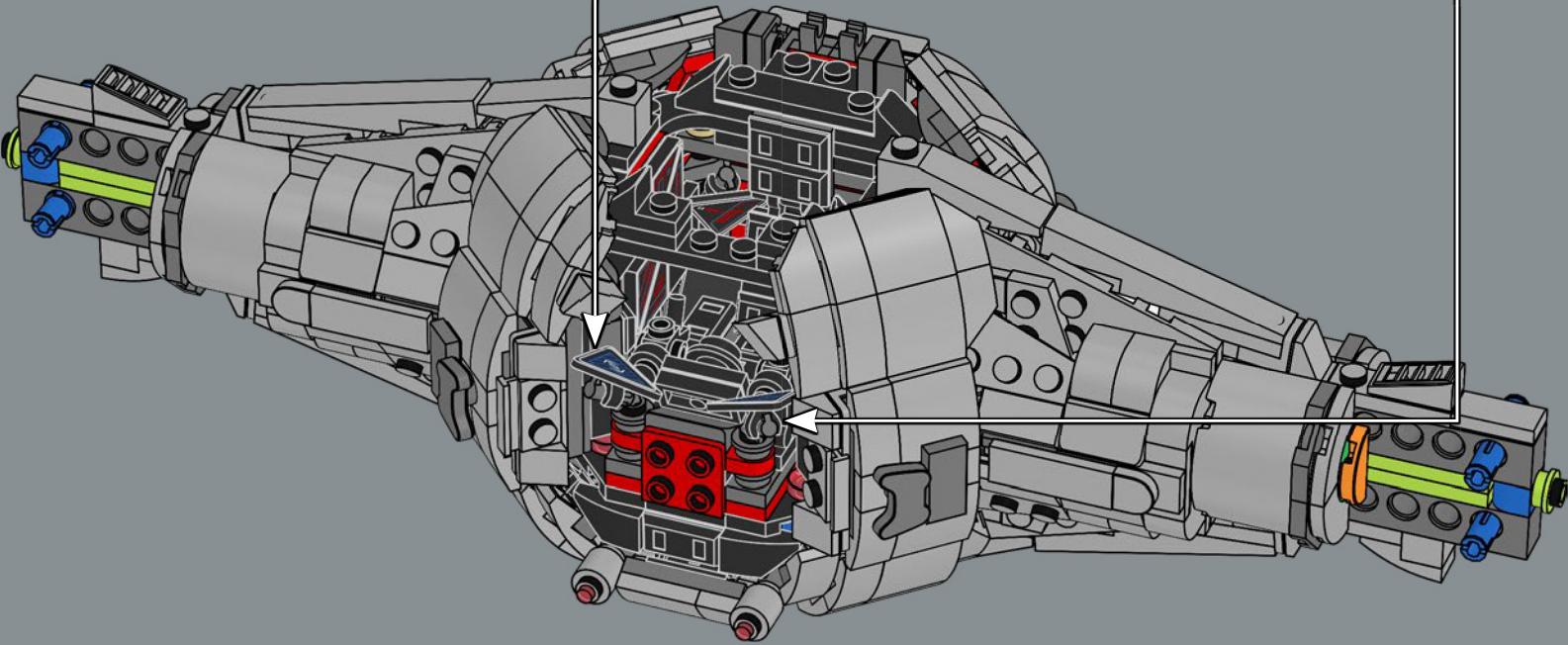
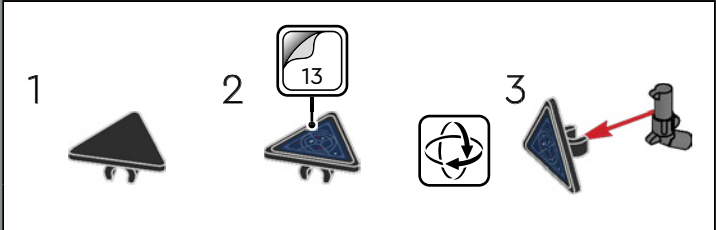
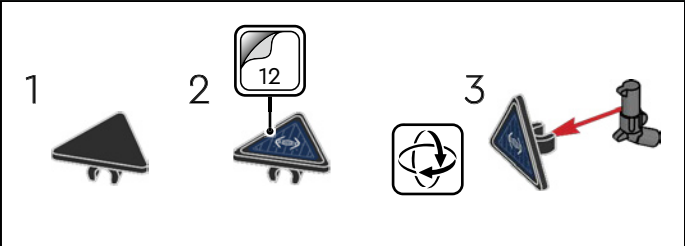

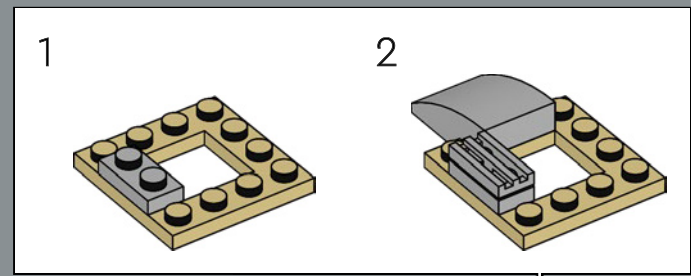
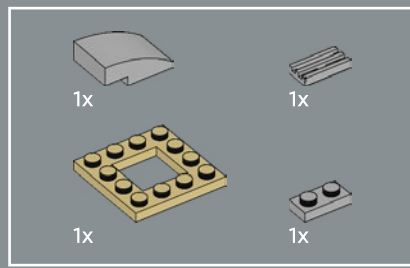

194

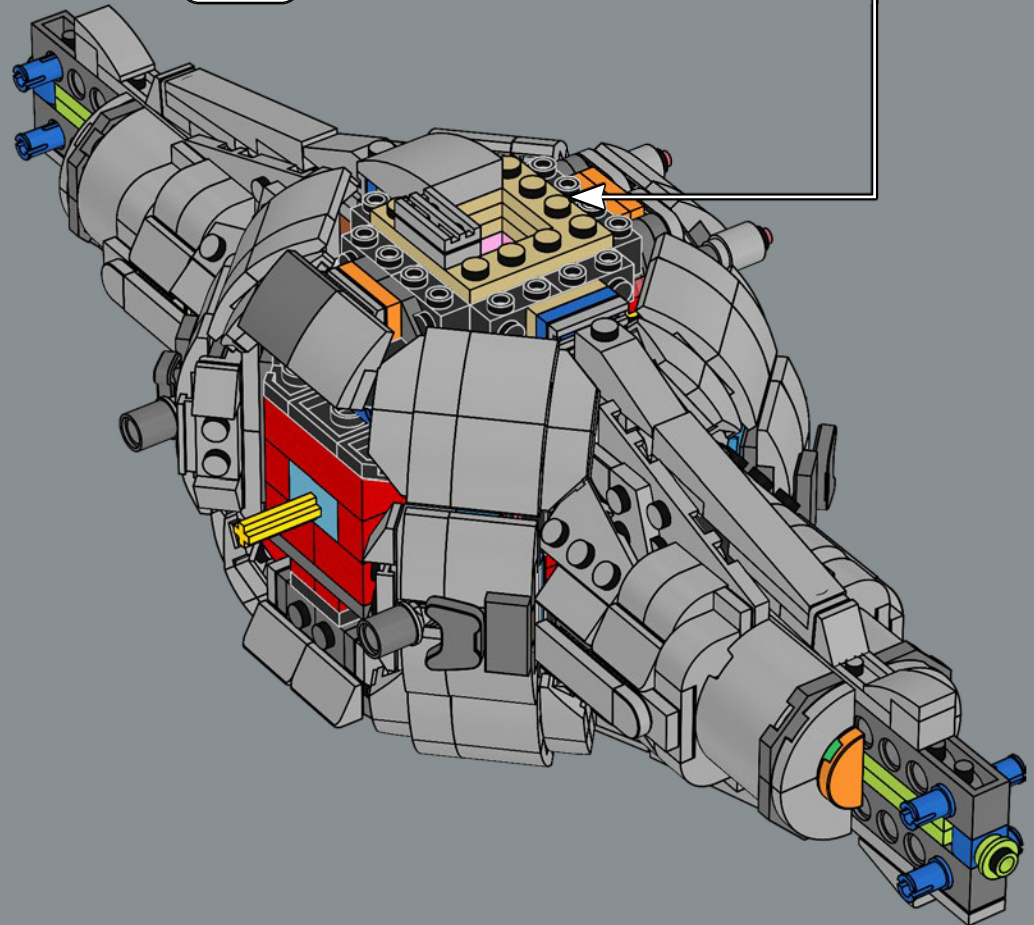

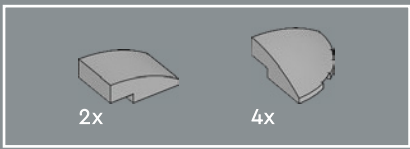

195

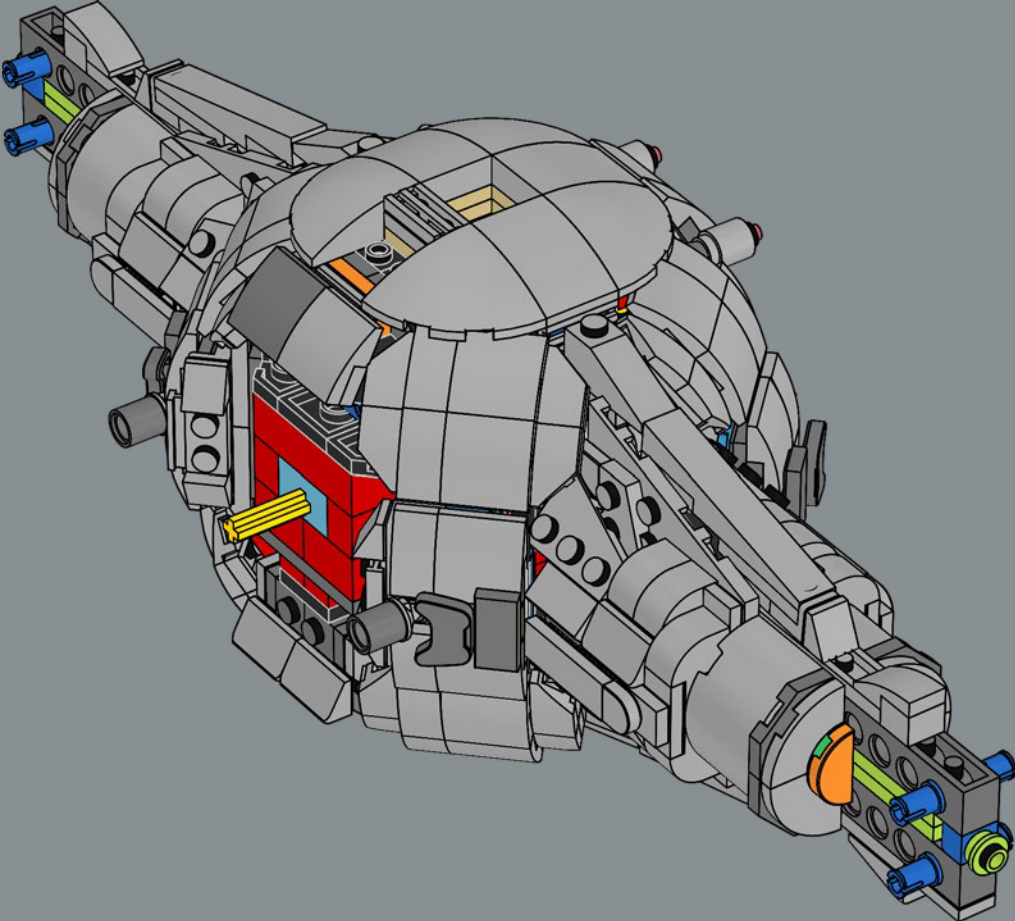

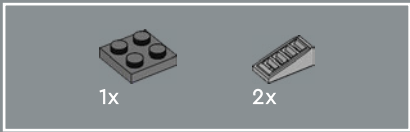

196

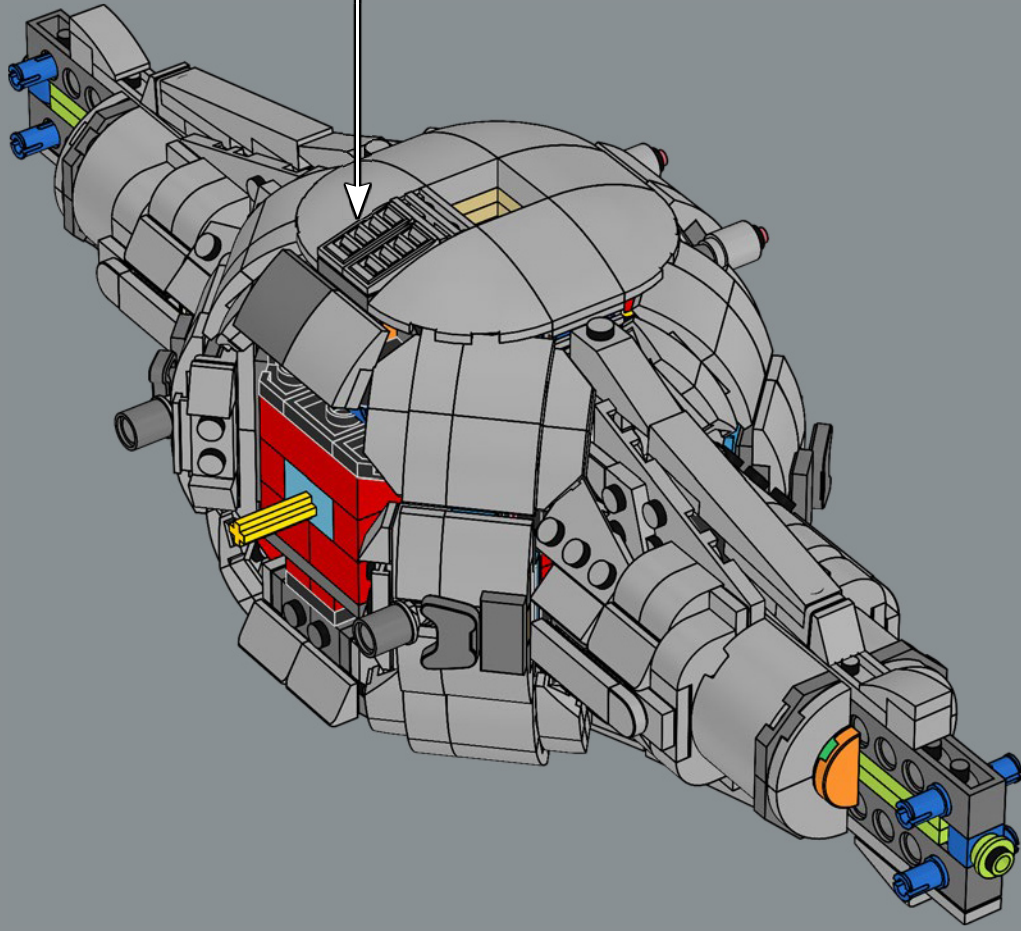
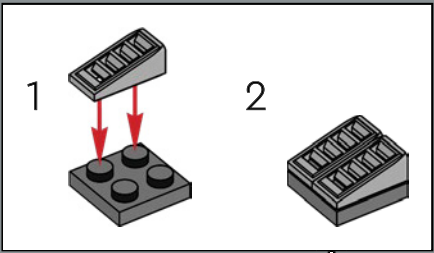



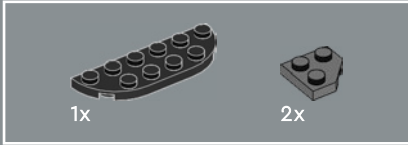

197

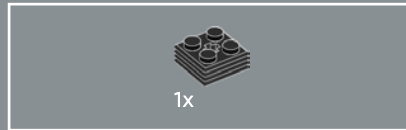
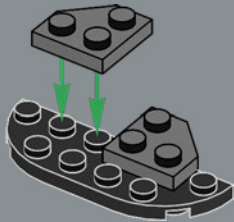

198

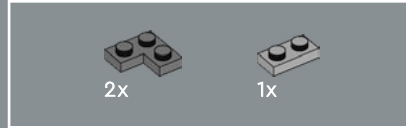
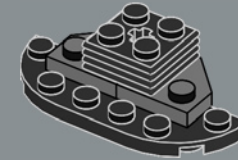

199

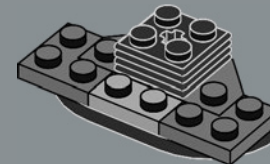

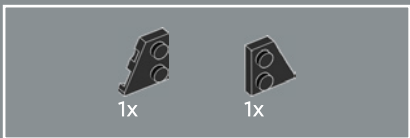

200

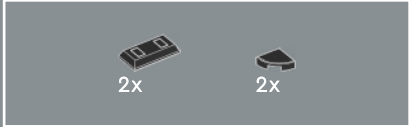
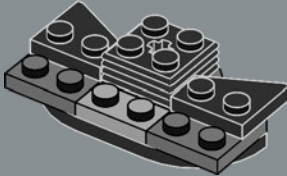

201

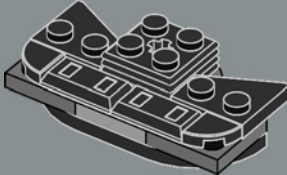

202

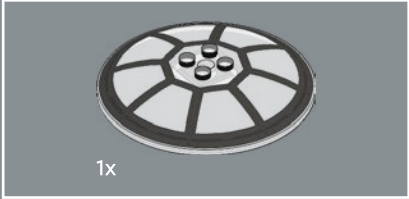
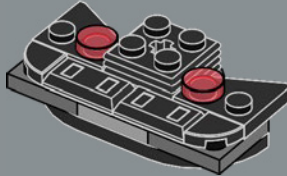

203



204

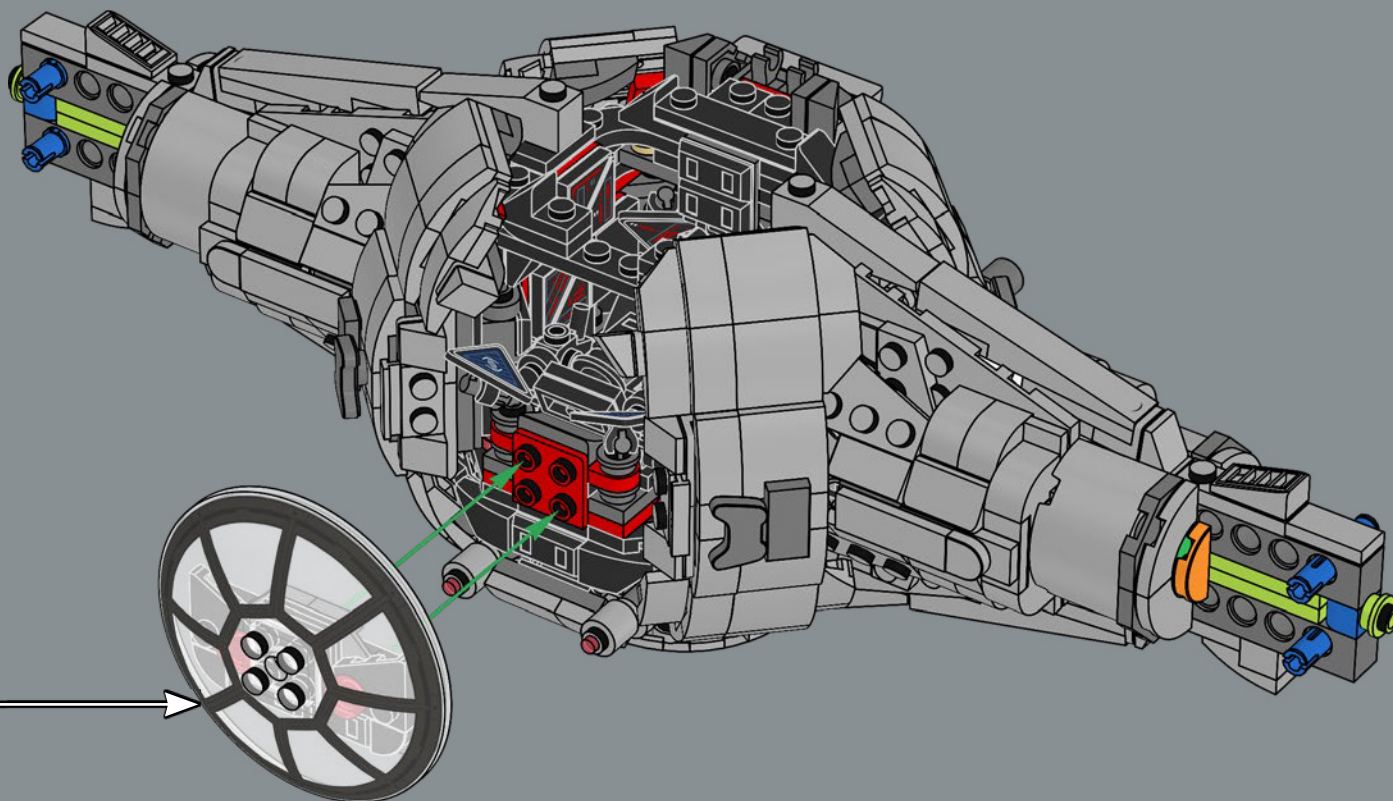



205

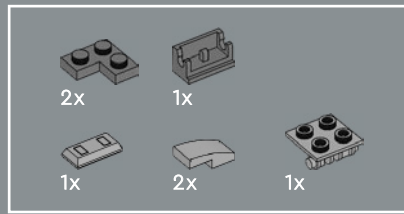
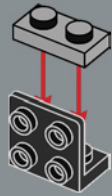

208

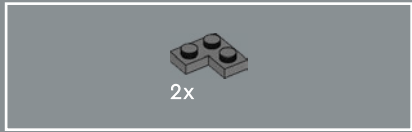

206

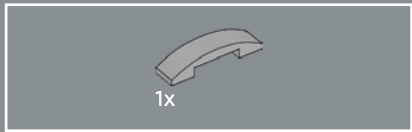
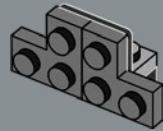

207

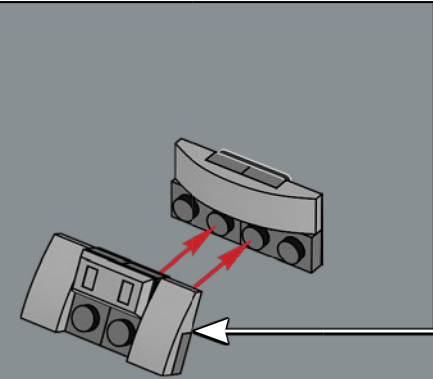
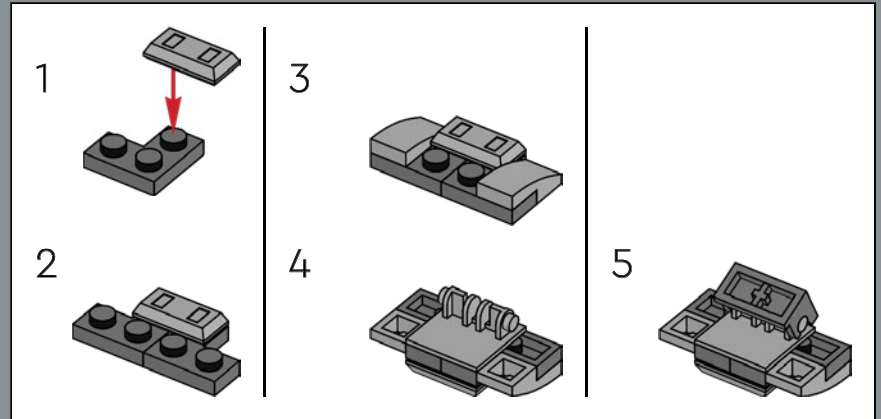
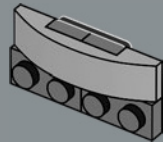



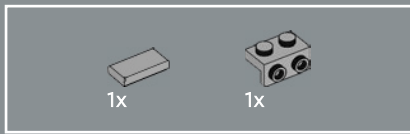

209

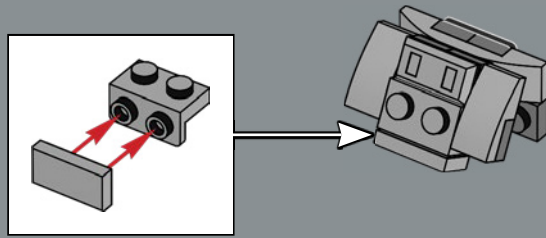

210

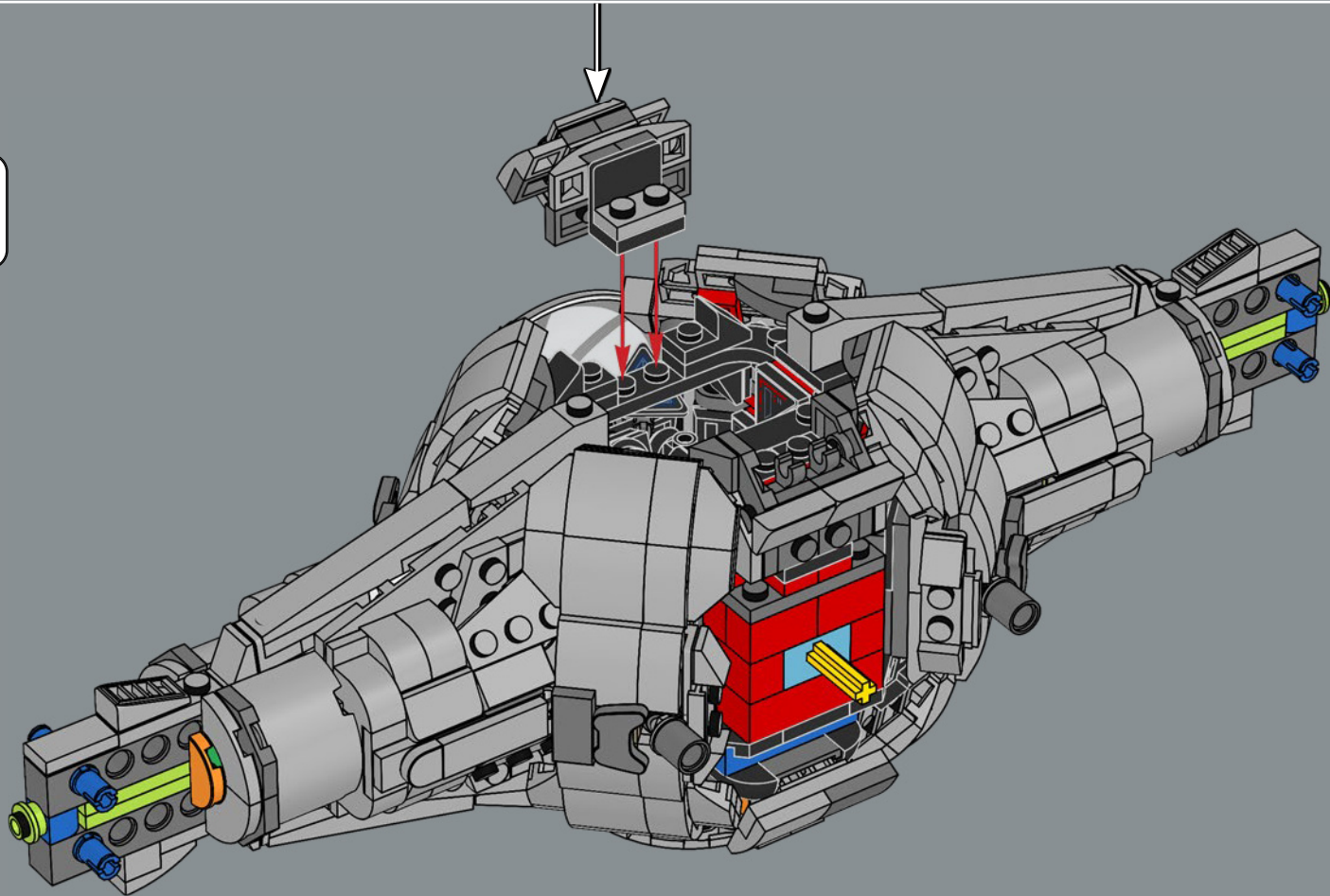

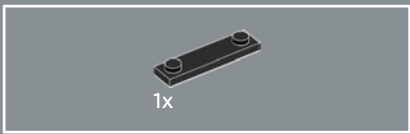

211

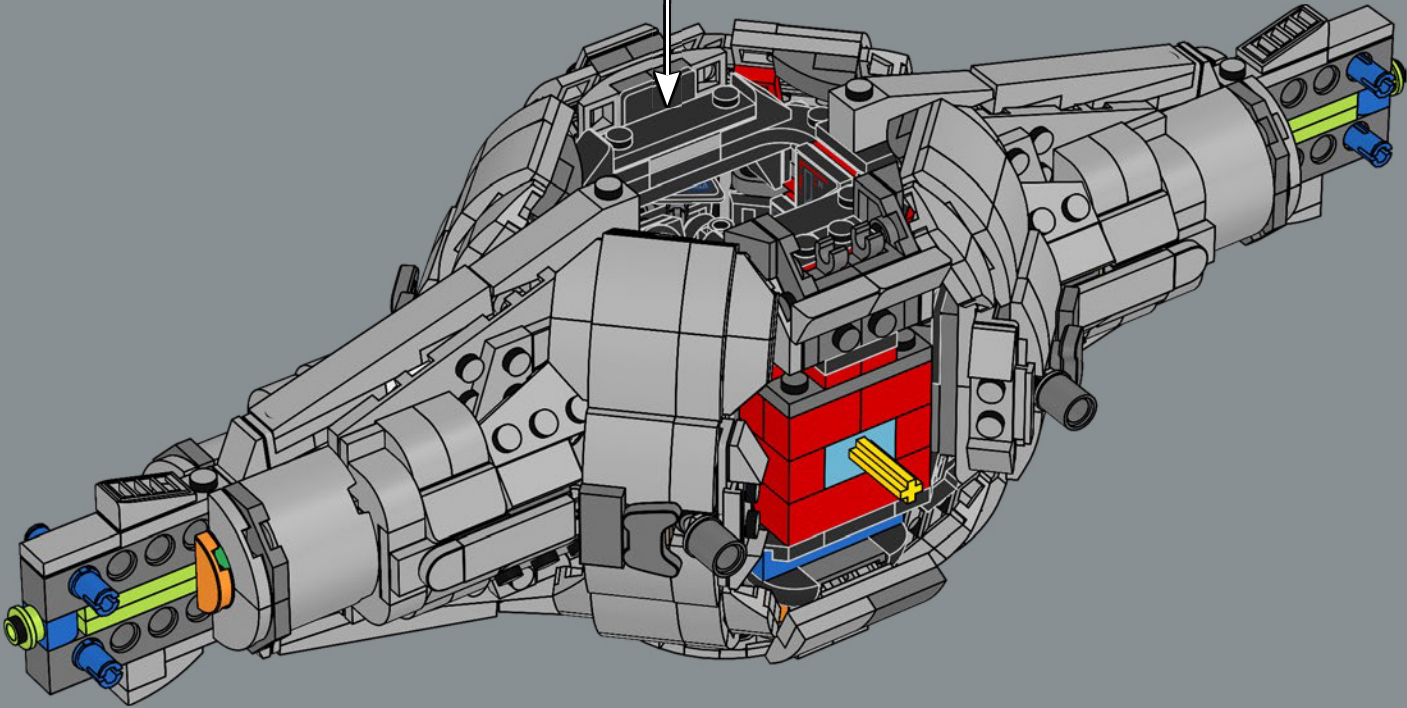
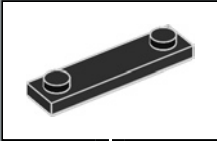





216

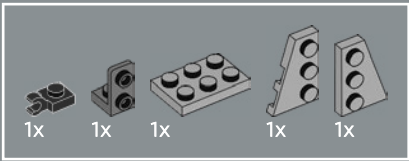
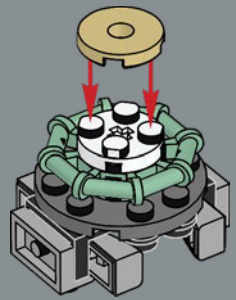

217

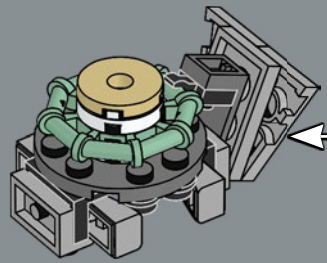
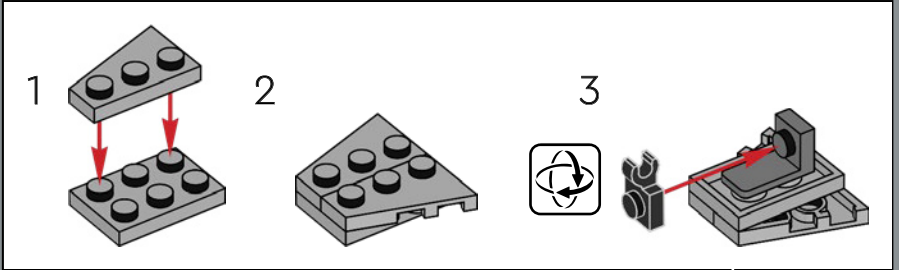



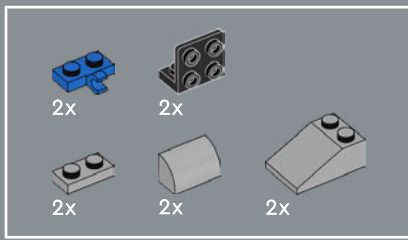

218

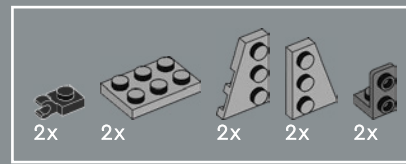
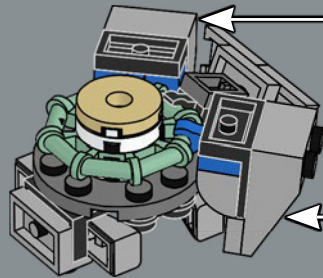
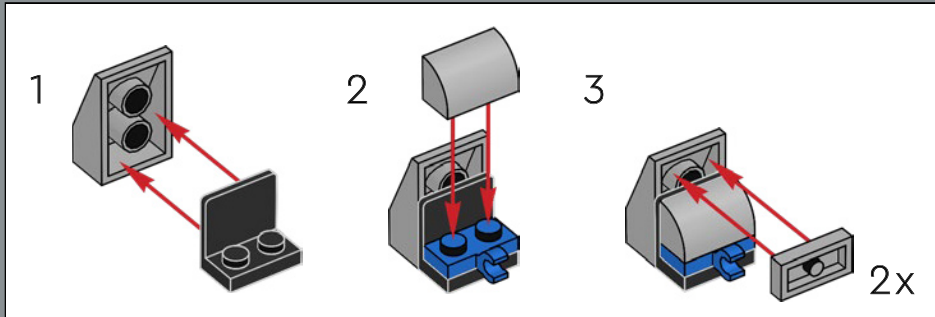

219

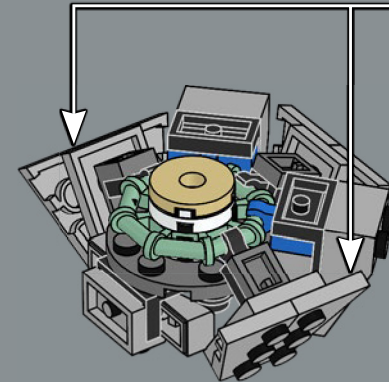
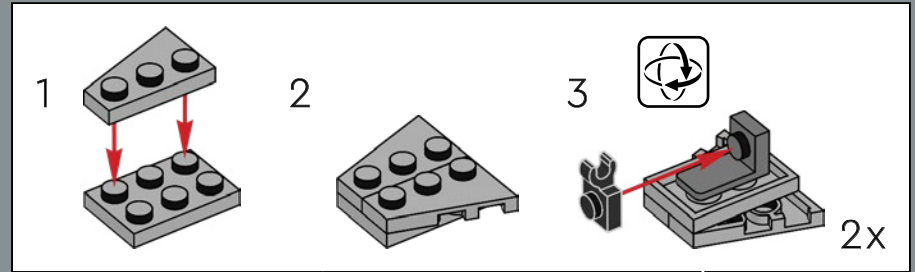

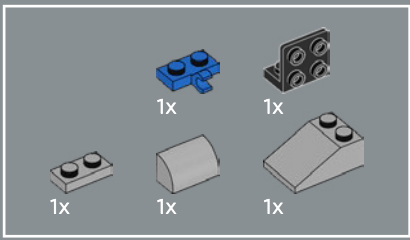

220

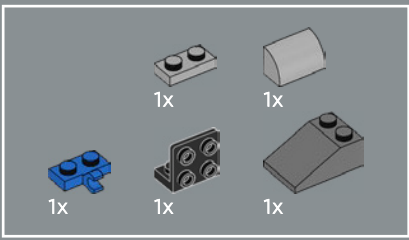
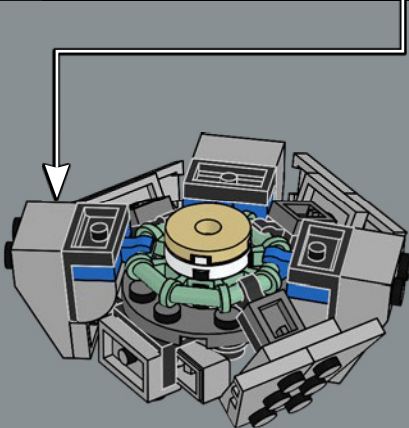
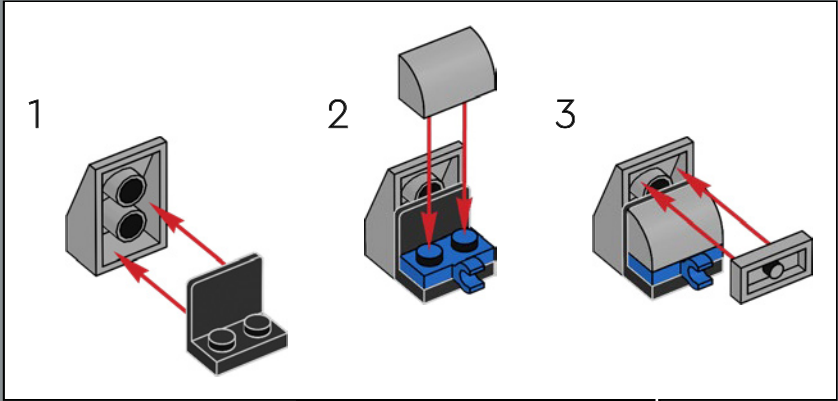

221

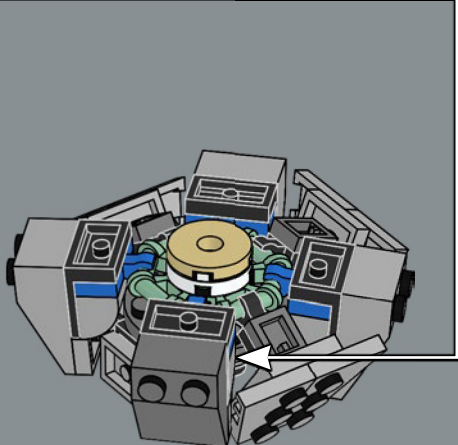
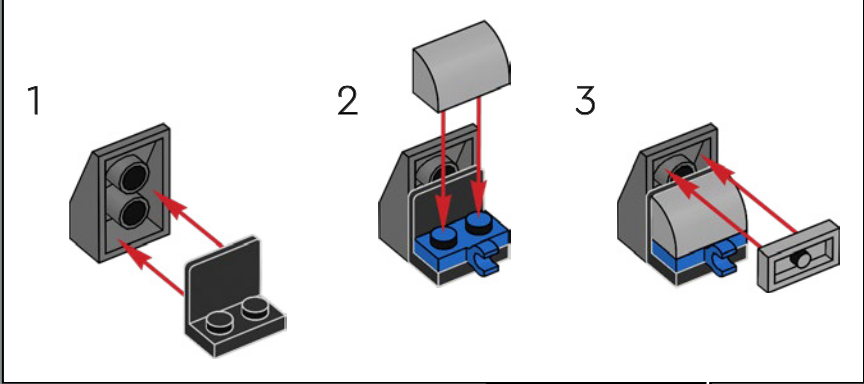

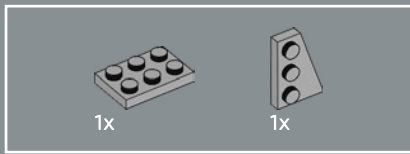

222

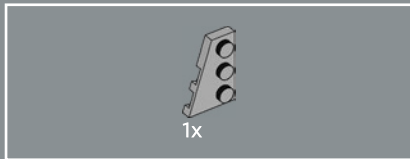
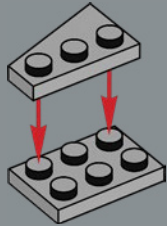

223

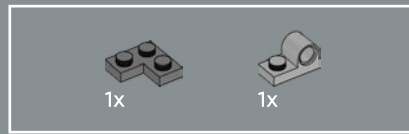
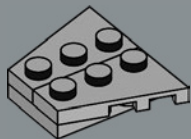

224

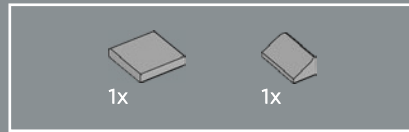
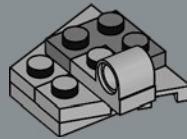

225

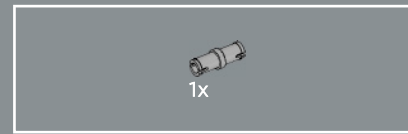
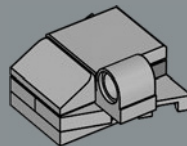

226

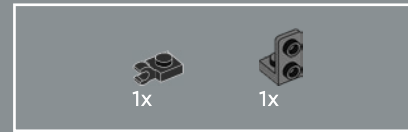
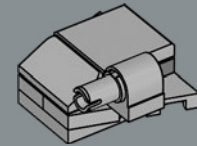

227

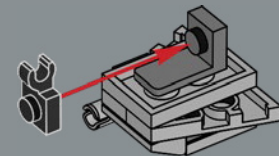

228

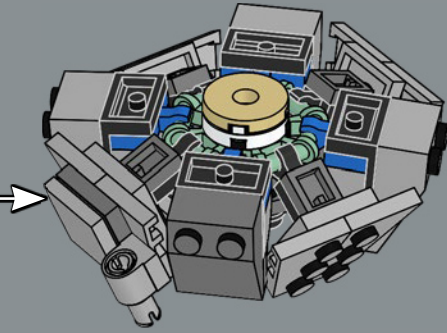

229

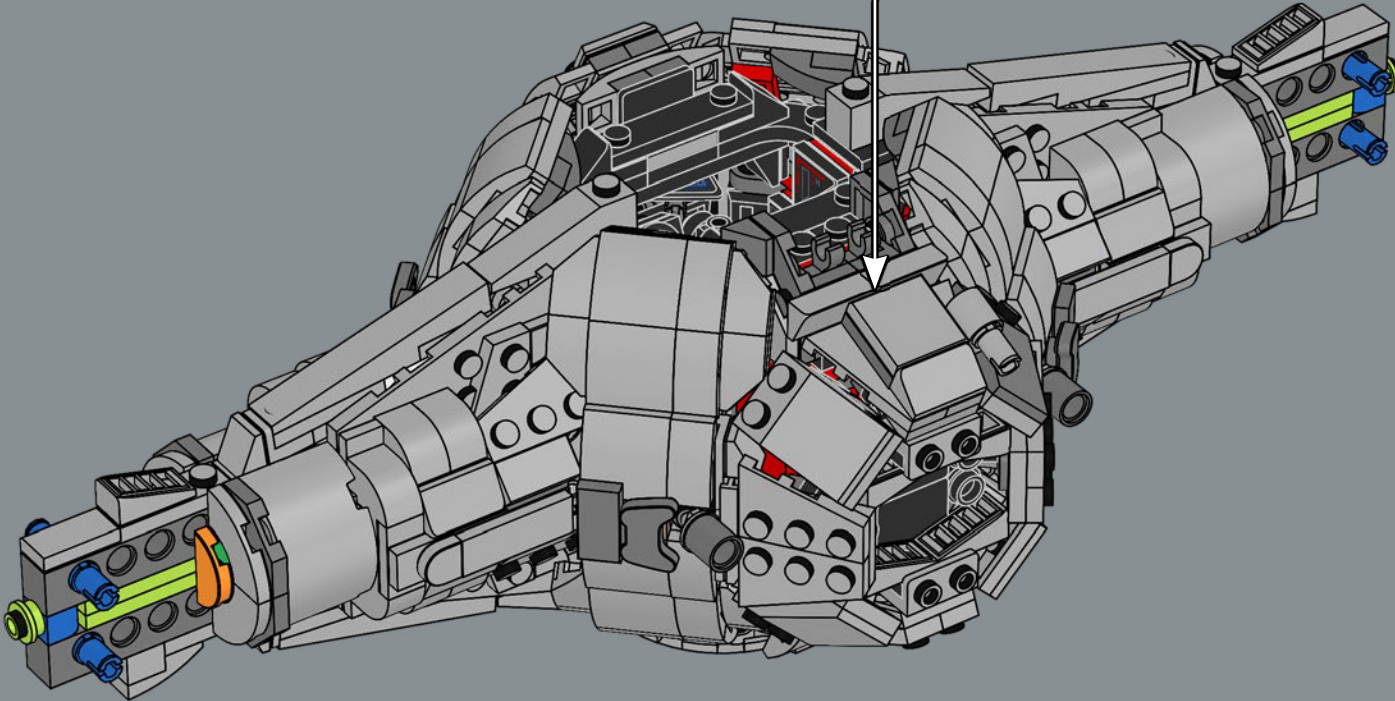



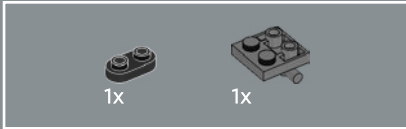

230

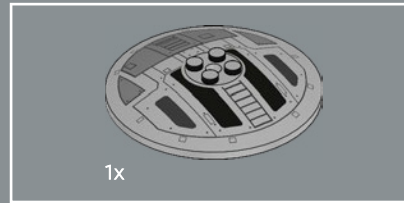
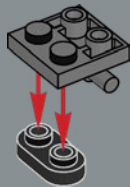

231

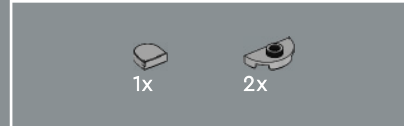
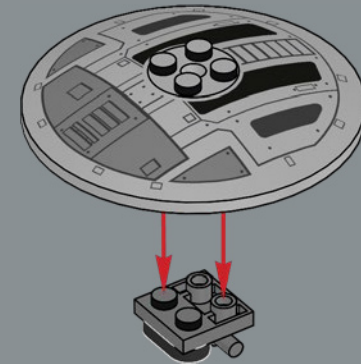

232

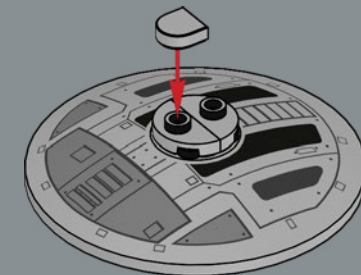

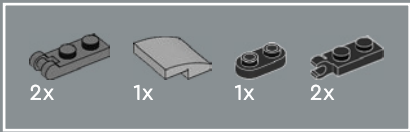

233

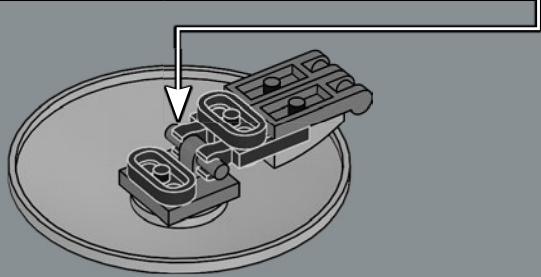
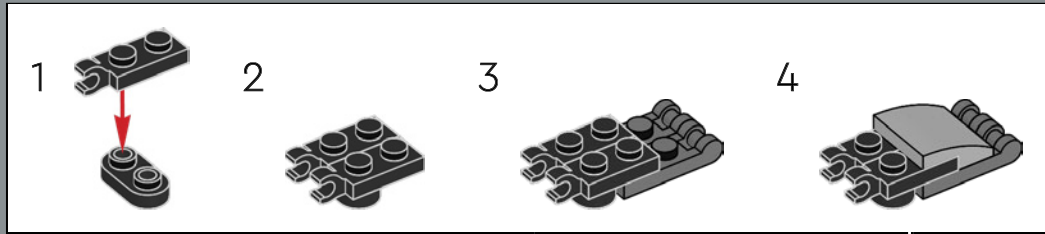

234

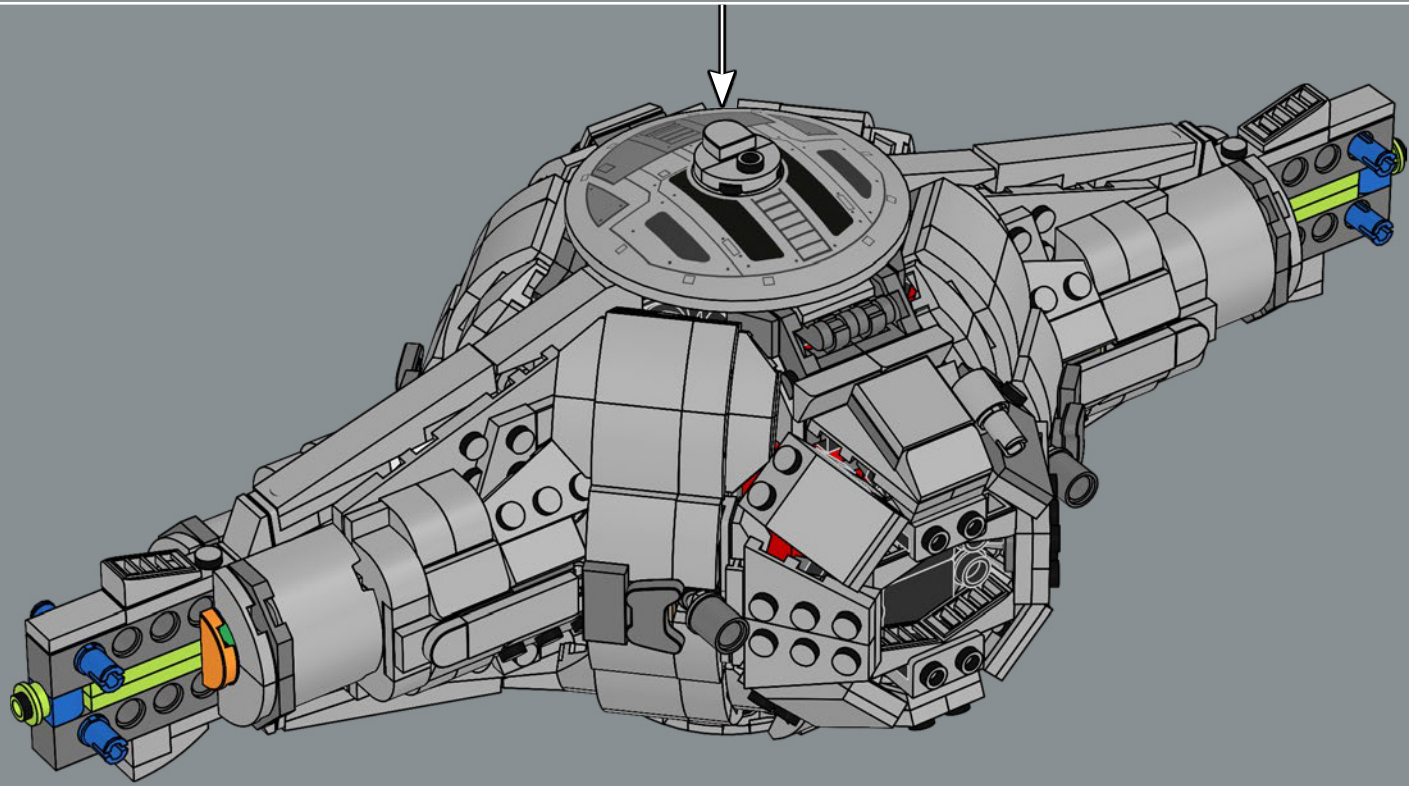

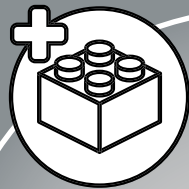

1x

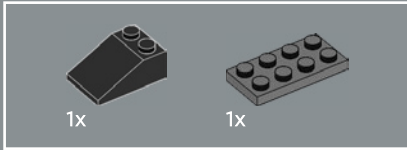
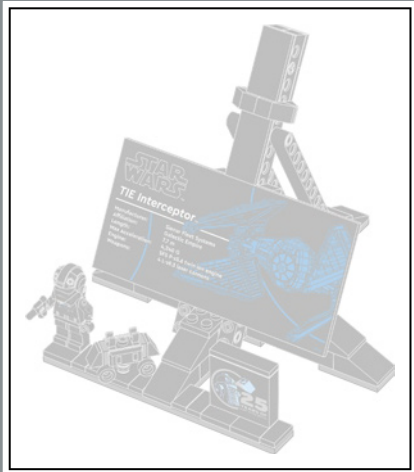

235

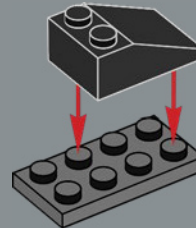

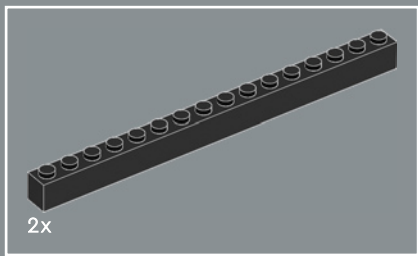

236

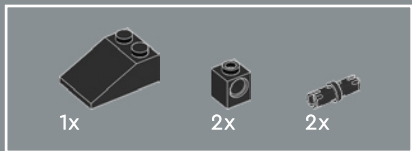
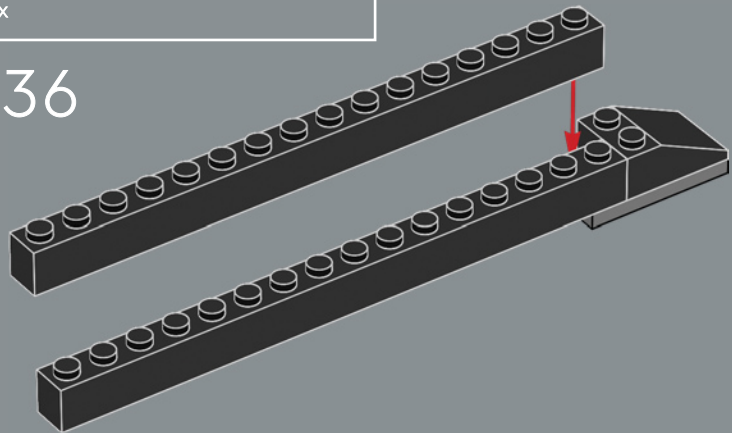

237

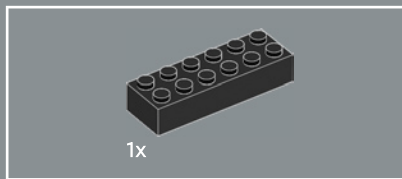
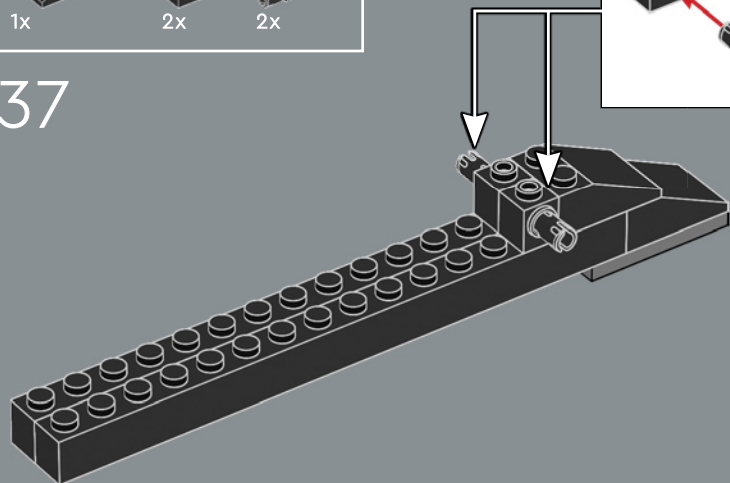

238

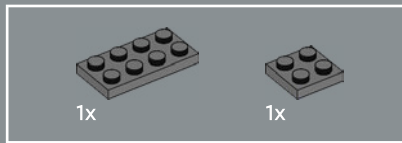
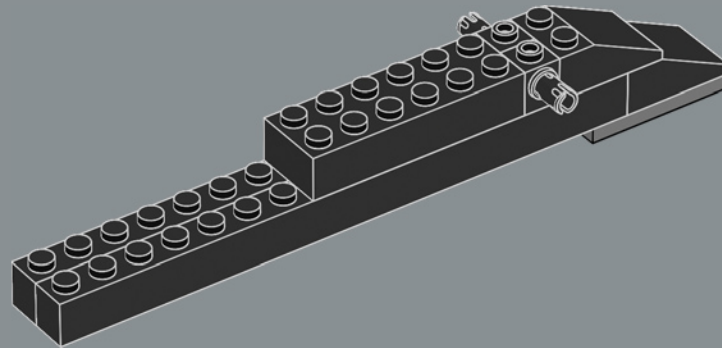

239

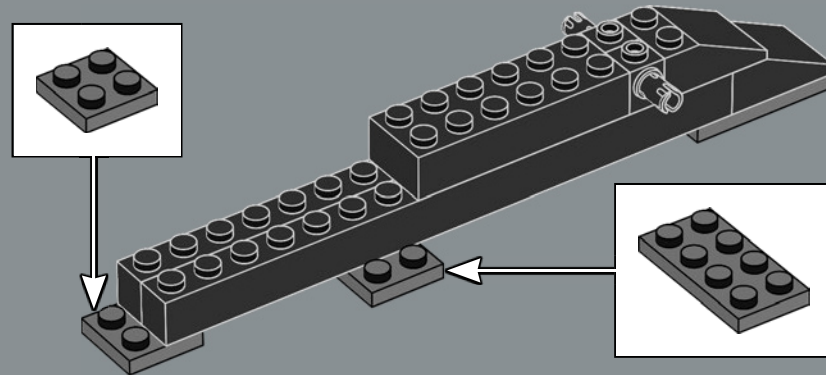



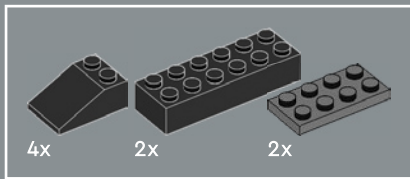

240

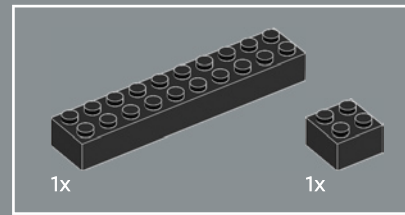
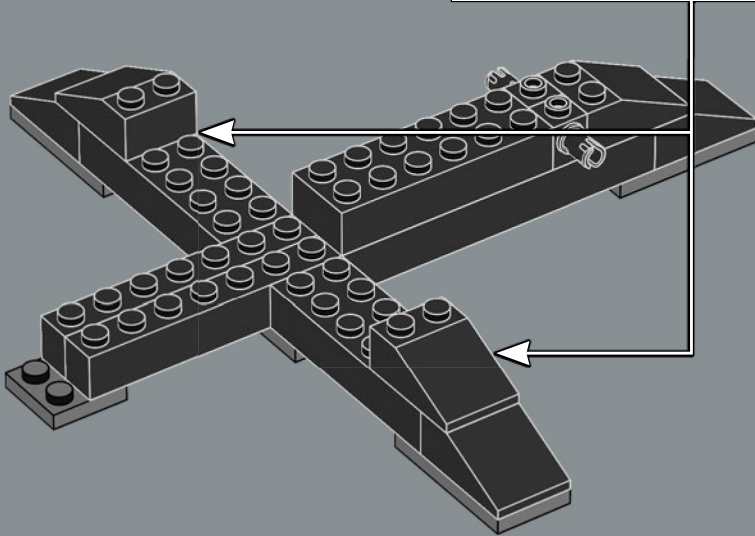
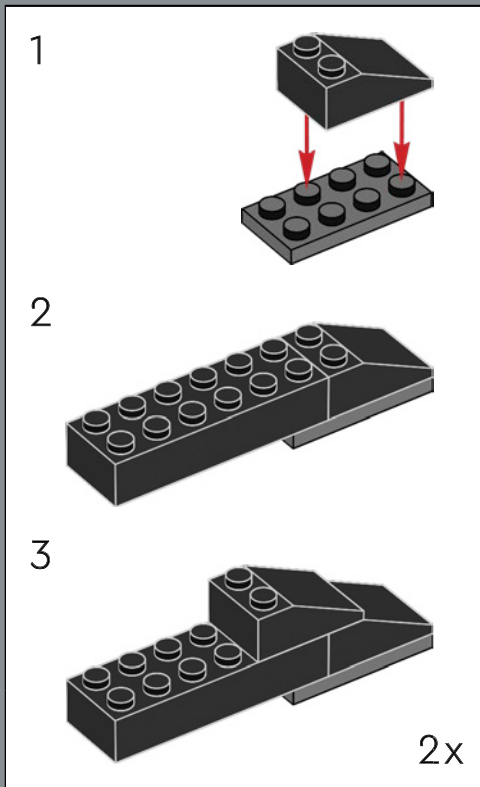

241

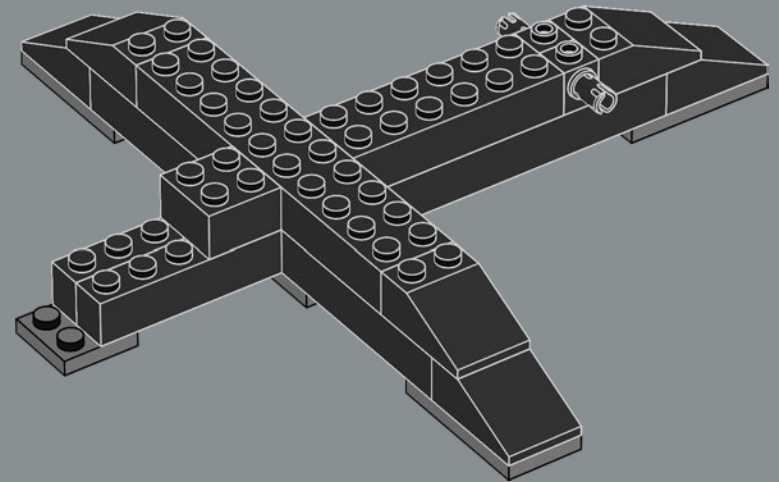

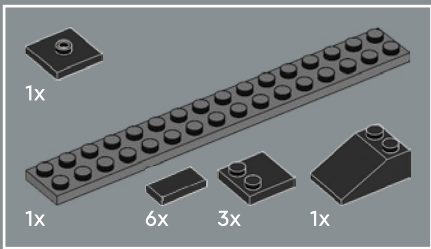

242

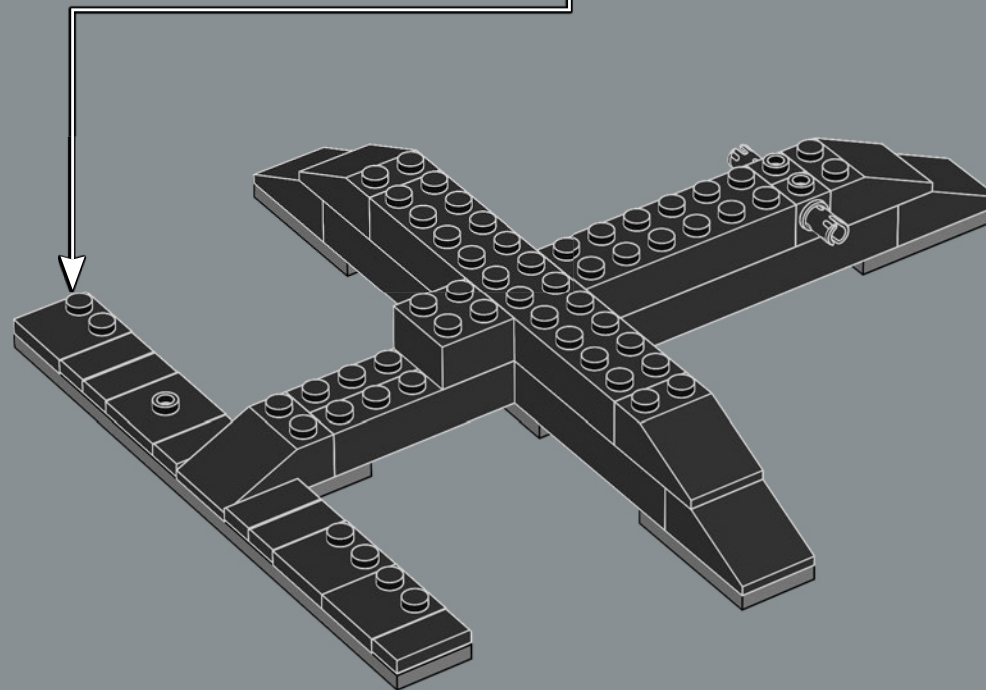
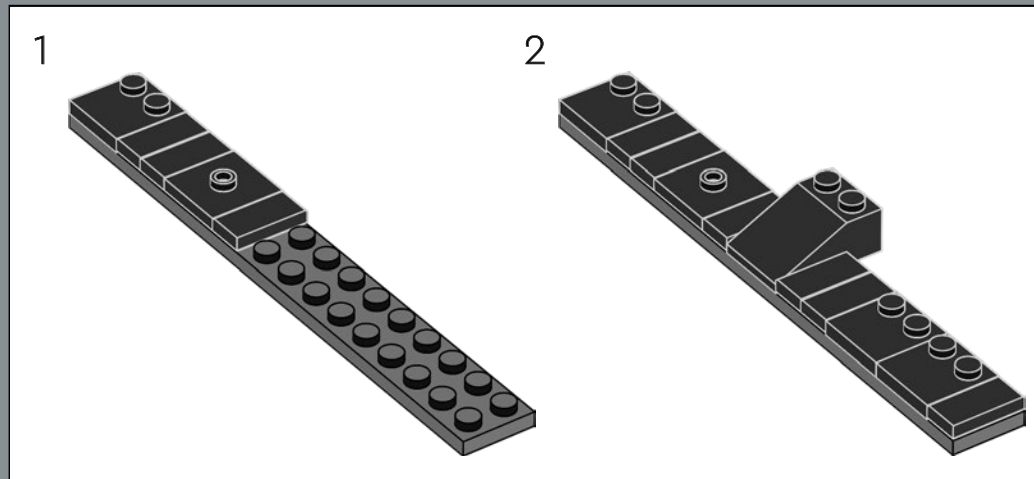

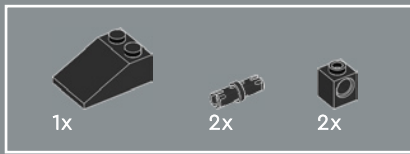

243

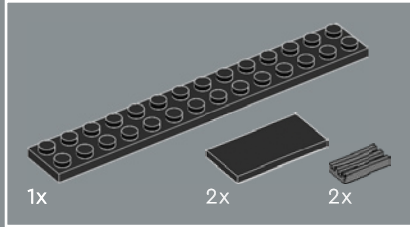
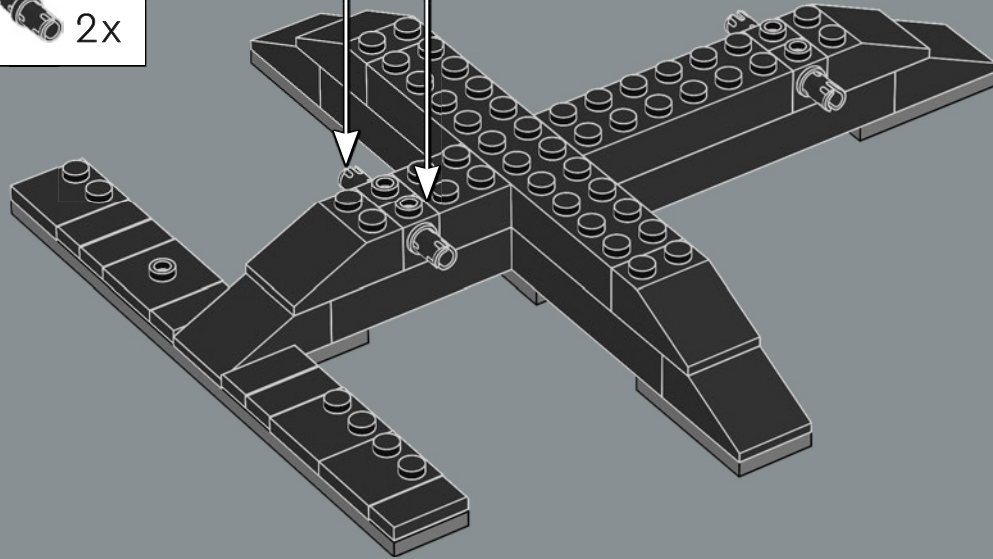
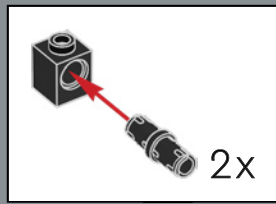

244

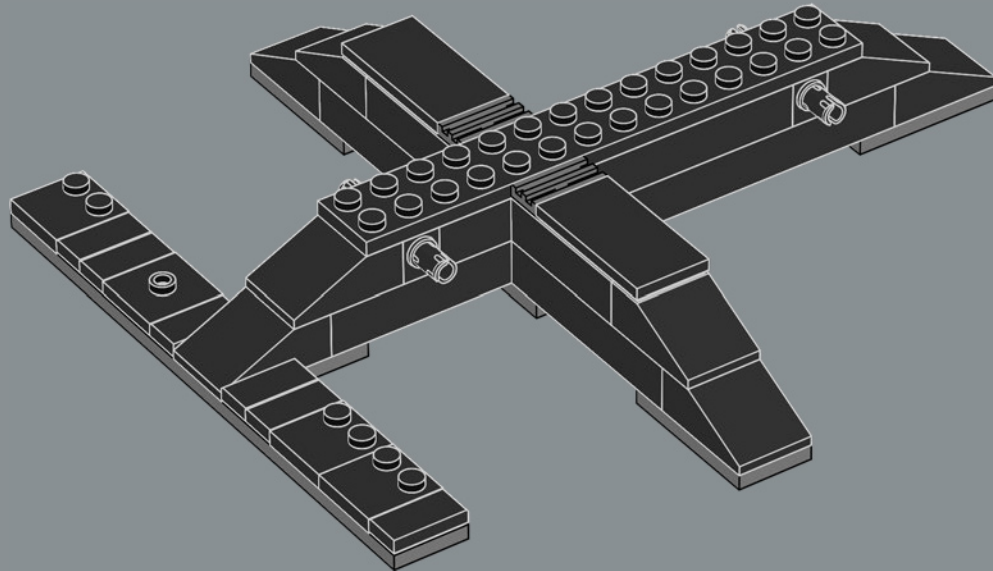

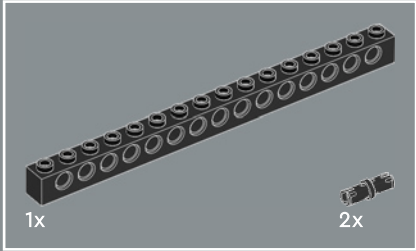
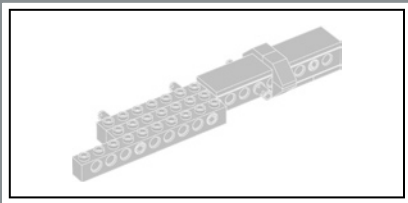

245

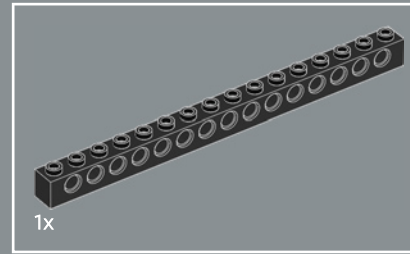
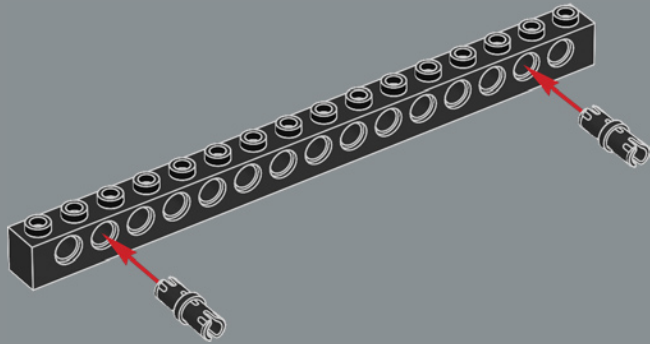

246

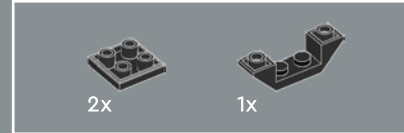
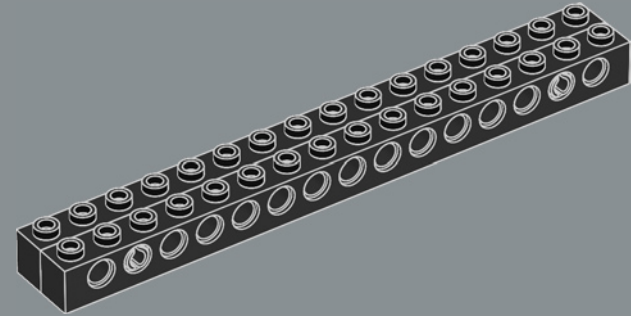

247

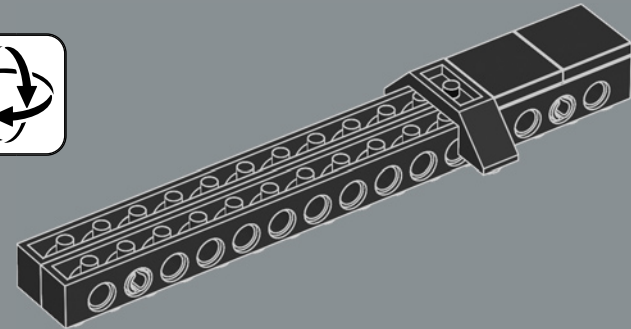
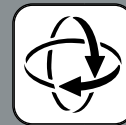



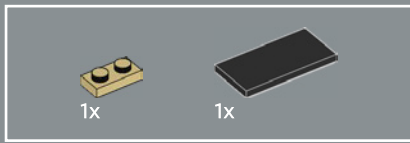

248

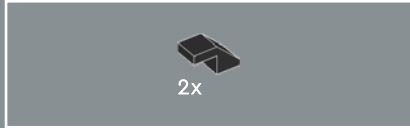
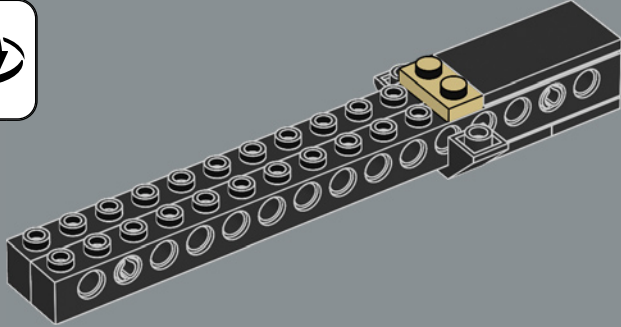

249

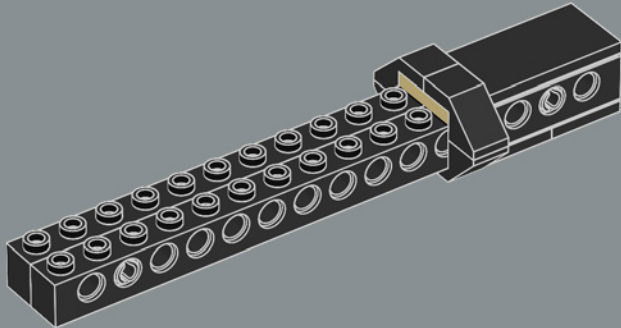

250

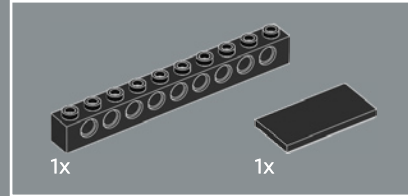
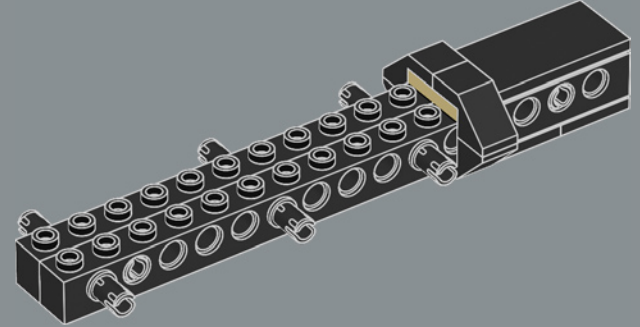

251

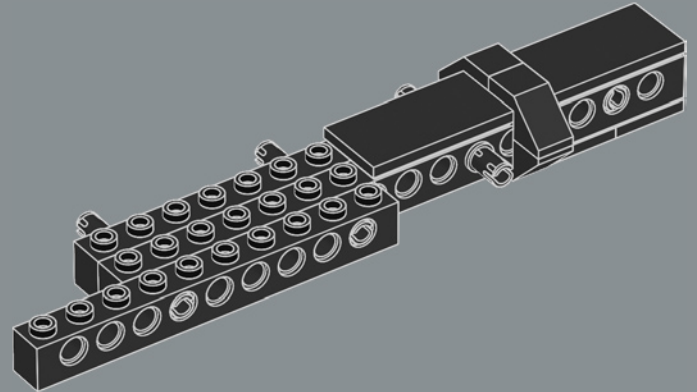

252

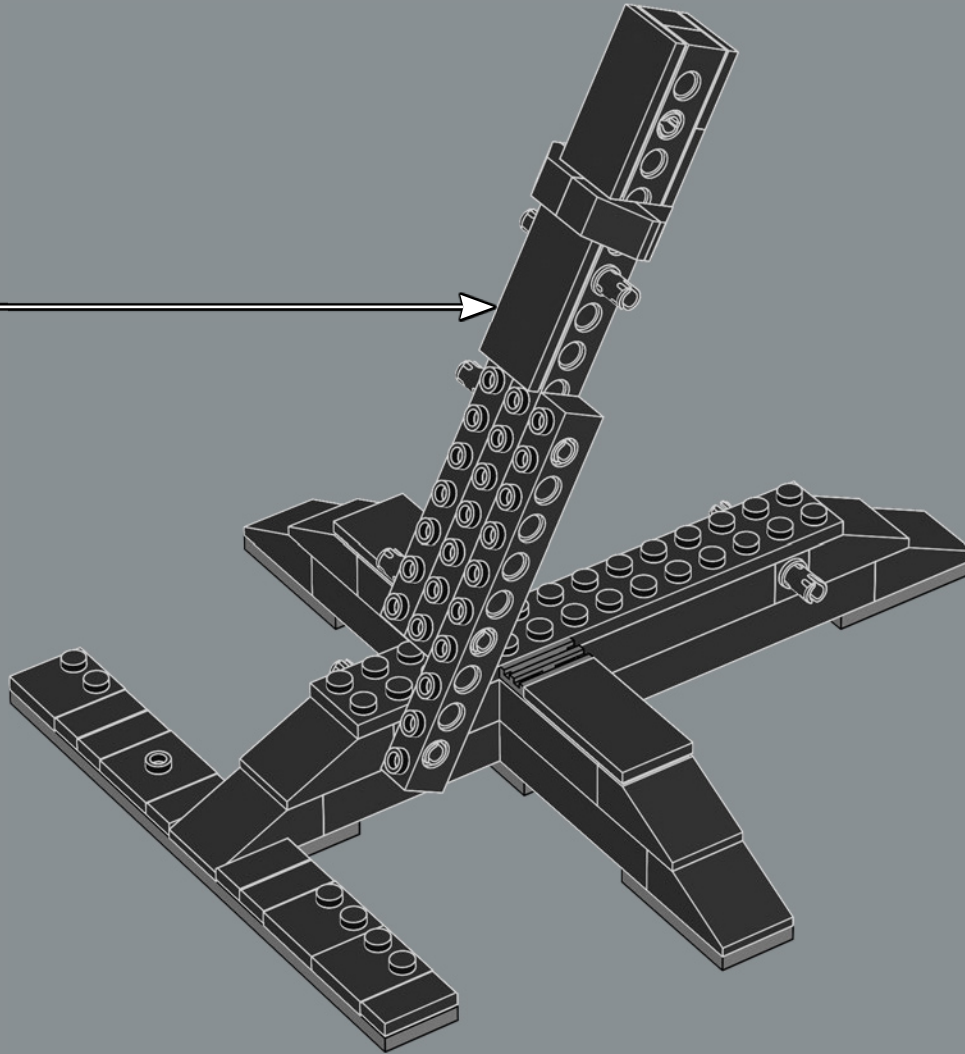

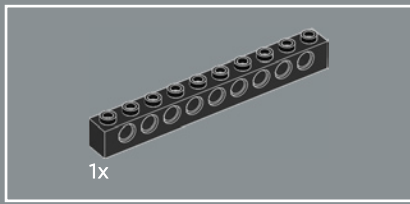

253

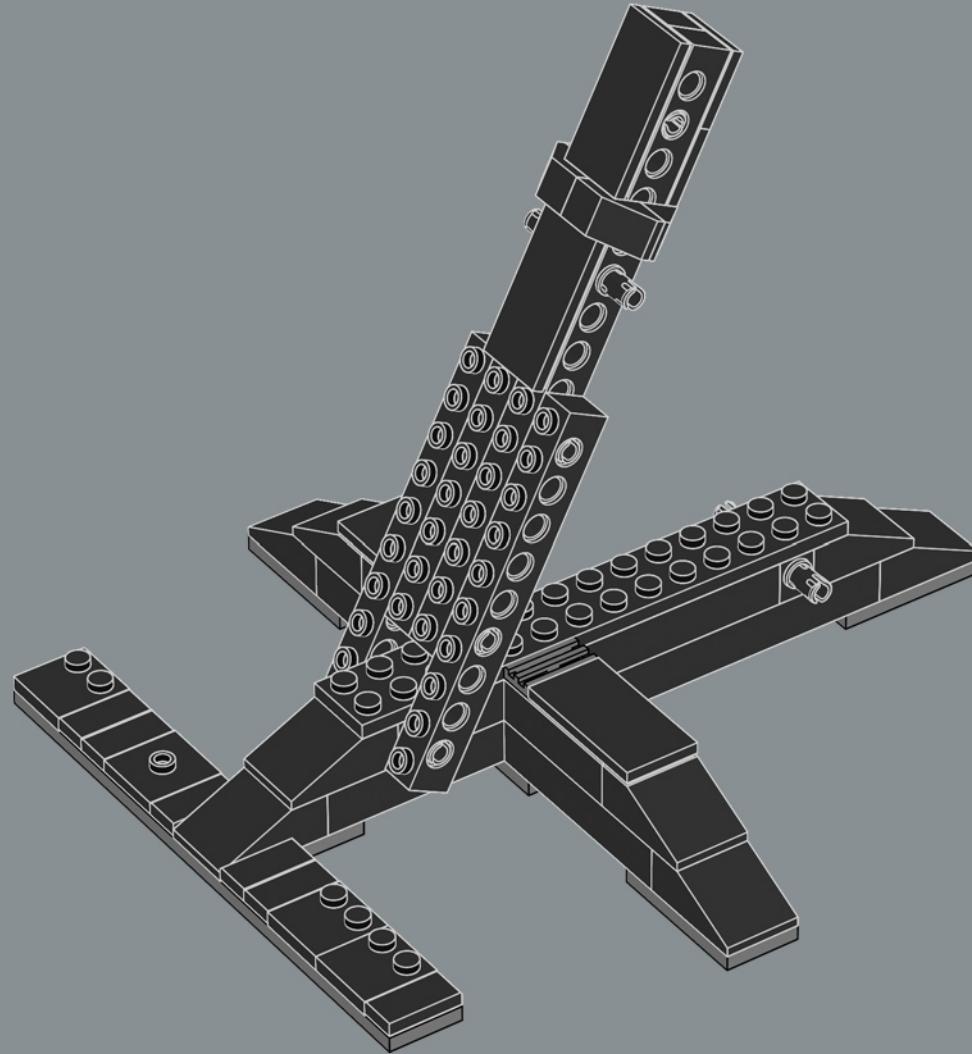

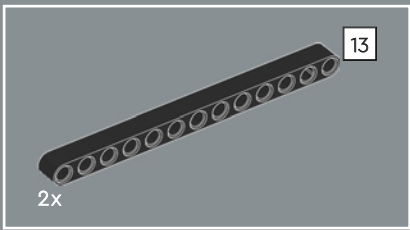

254

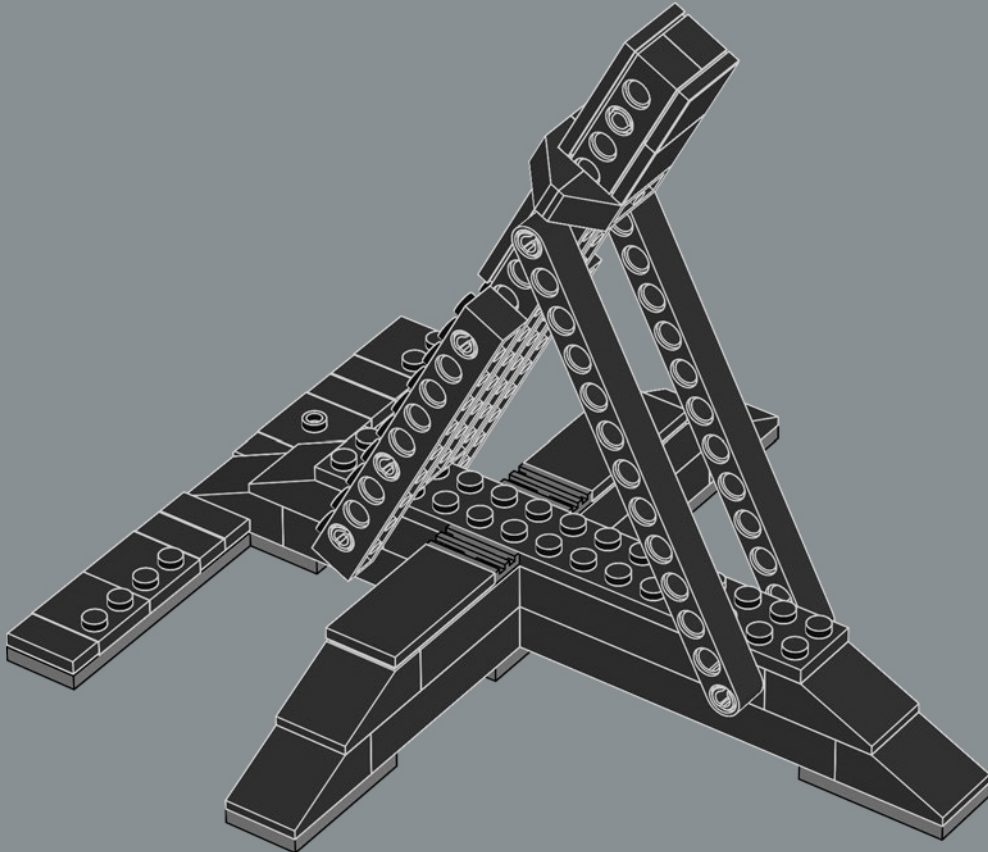





1x

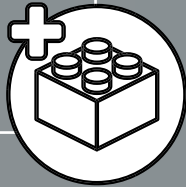

255

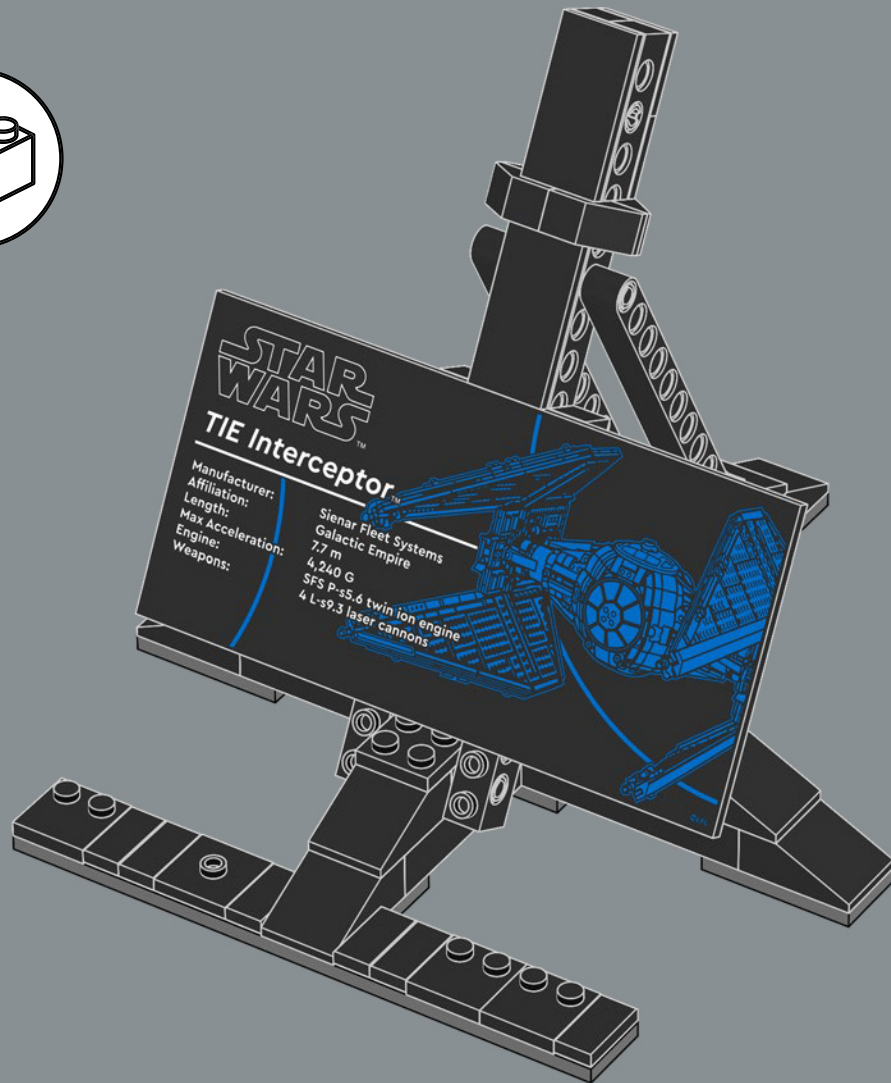

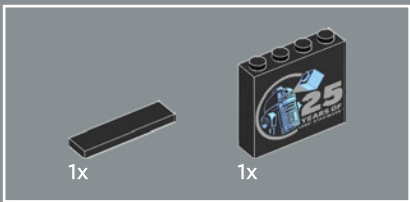

256

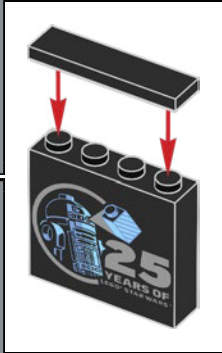
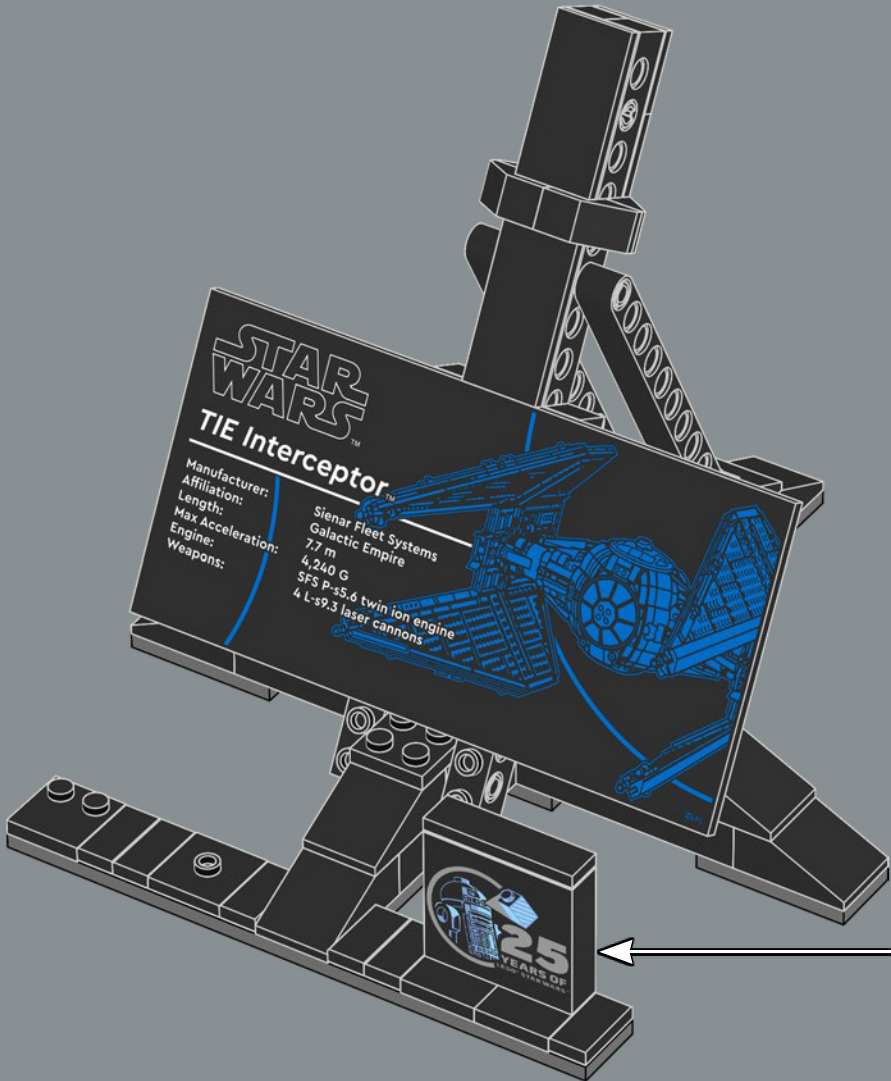

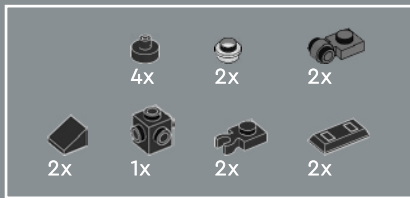

257

1

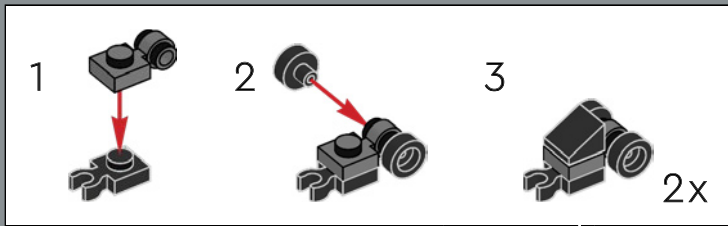

2

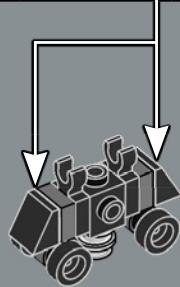

3

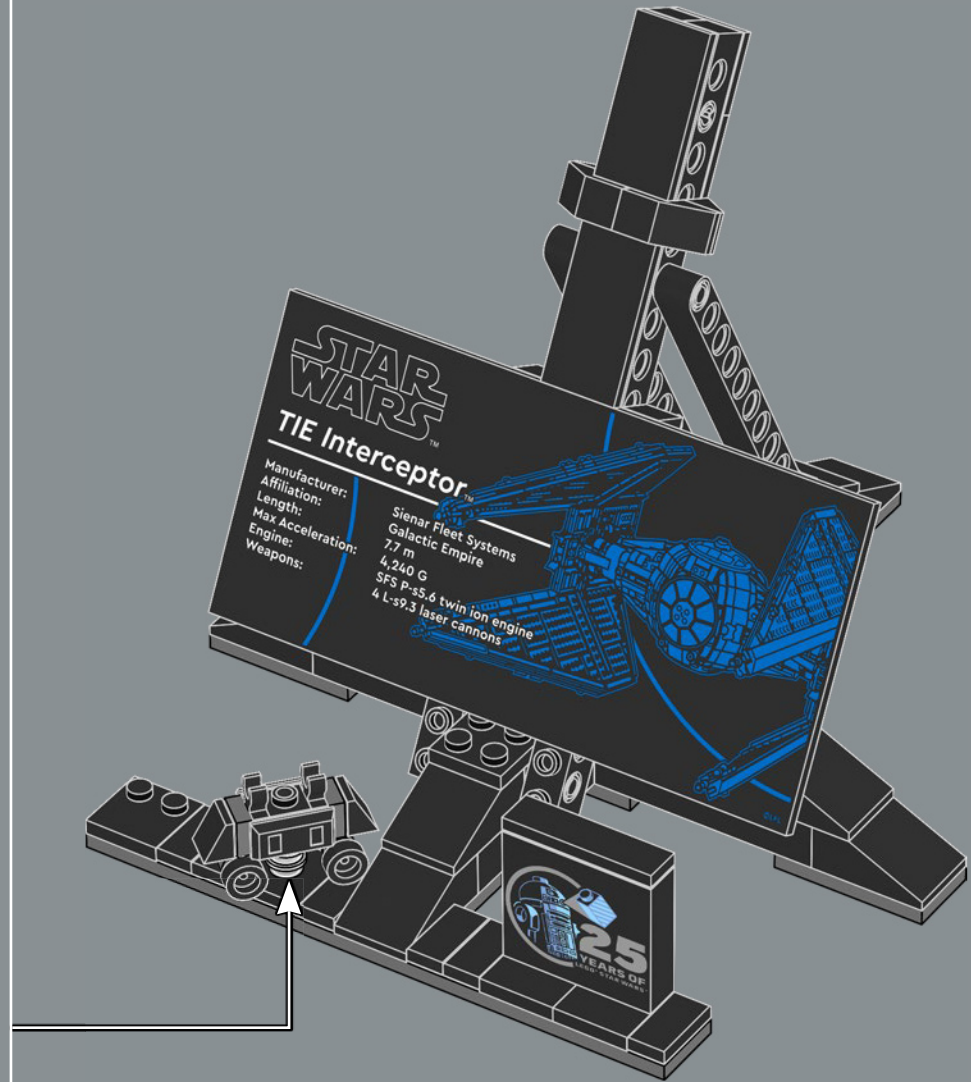
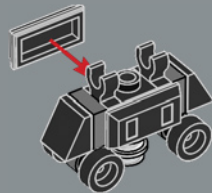

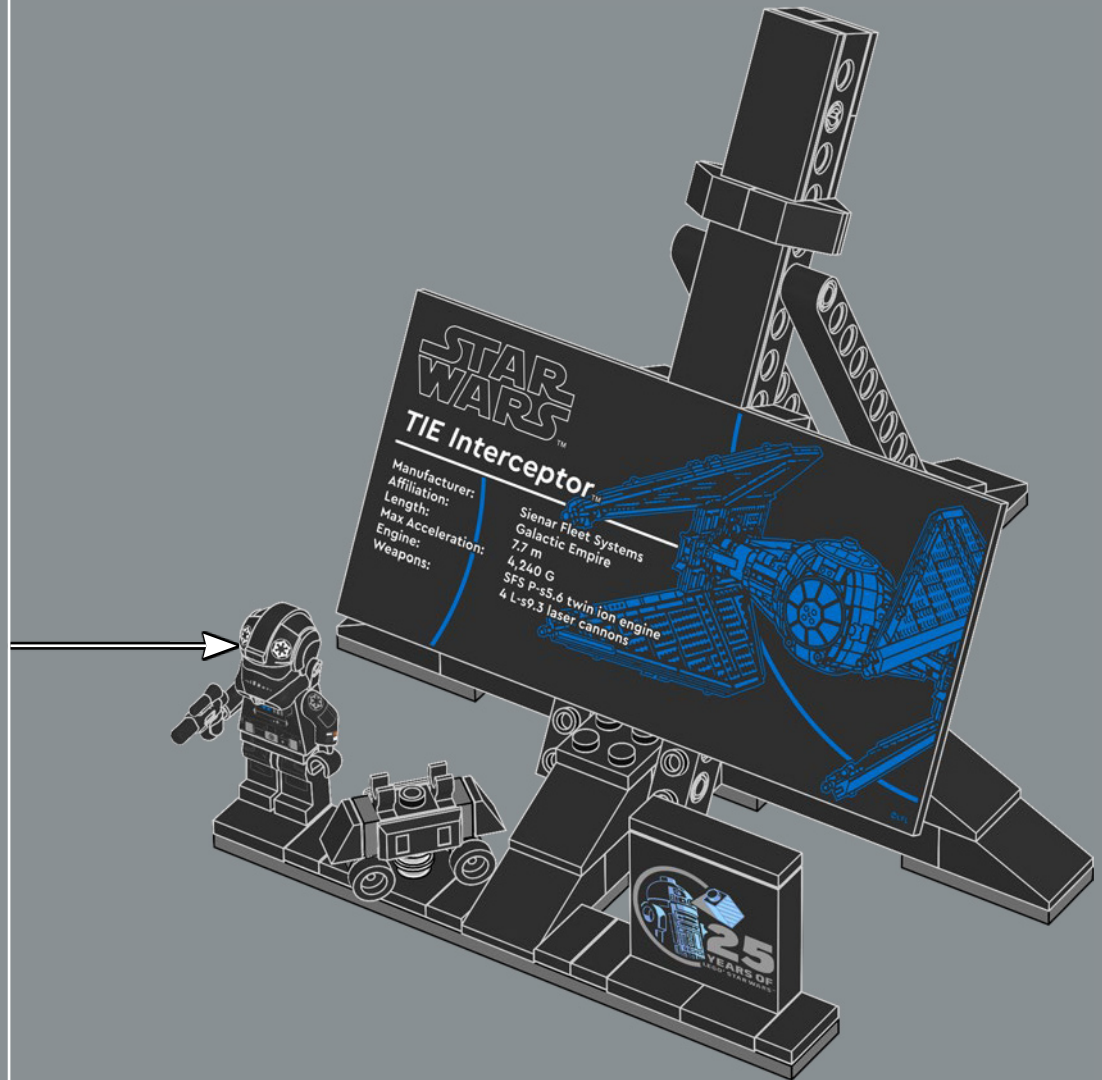
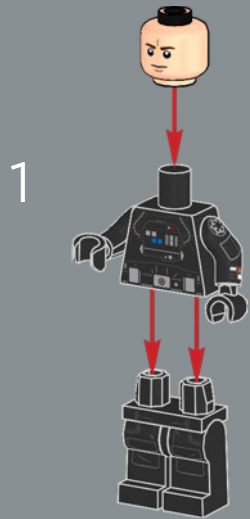



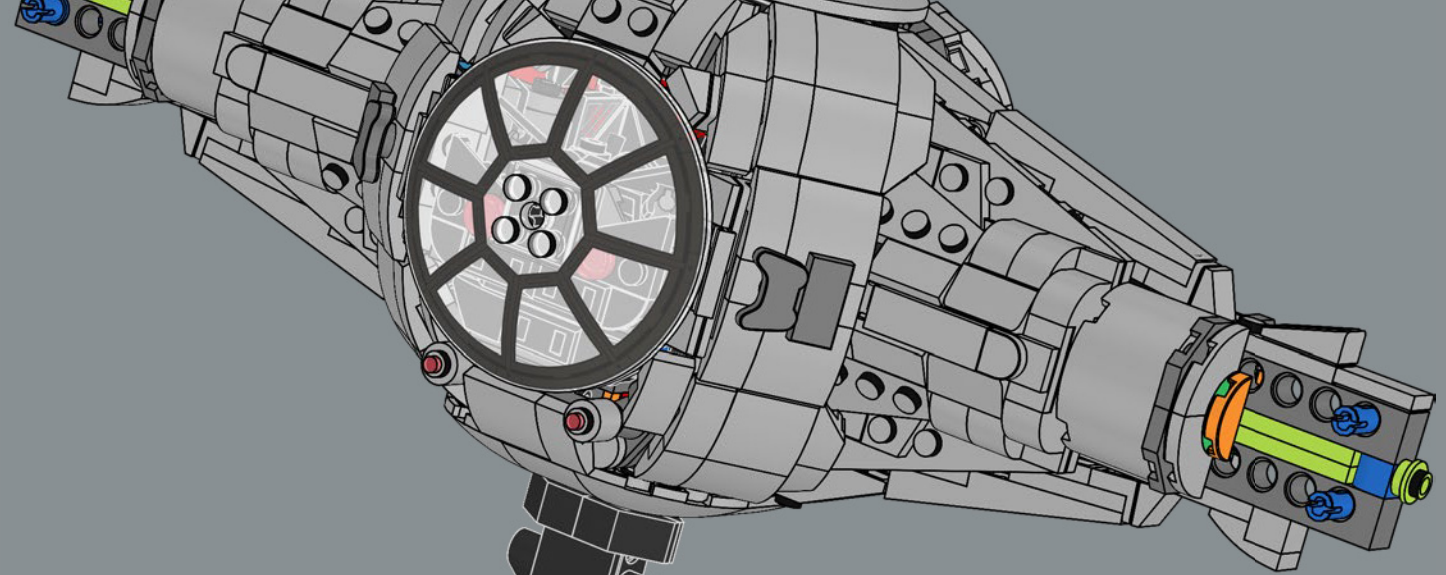

**STAR WARS**  
**TIE Interceptor™**

Manufacturer:	Siener Fleet Systems
Affiliation:	Galactic Empire
Length:	7.7 m
Max Acceleration:	4,240 G
Engine:	SFS P-s5.6 twin ion engine
Weapons:	4 L-s9.3 laser cannons

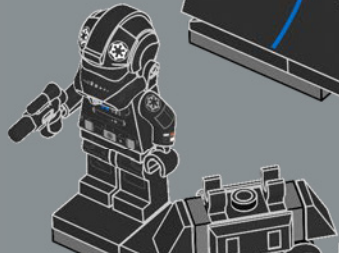

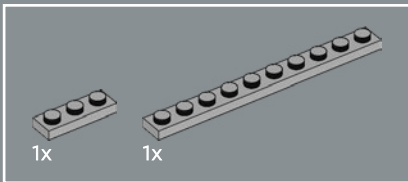
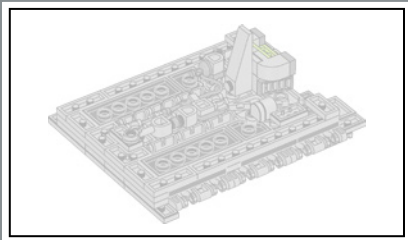

260

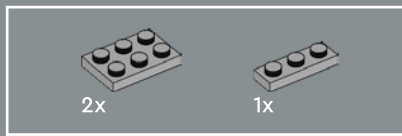
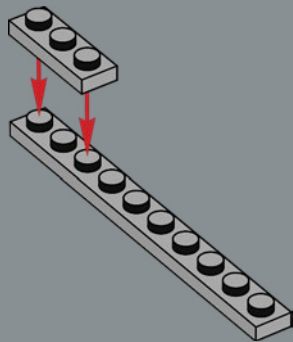

261

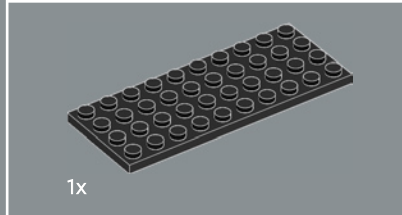
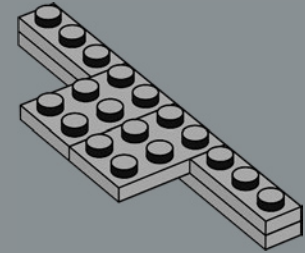

262

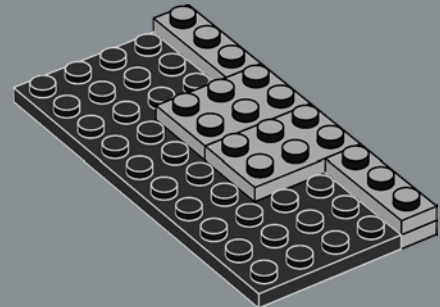

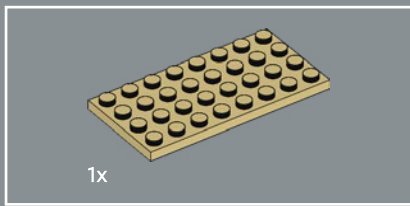

263

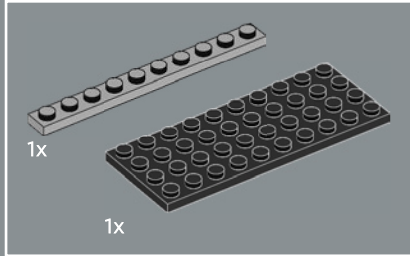
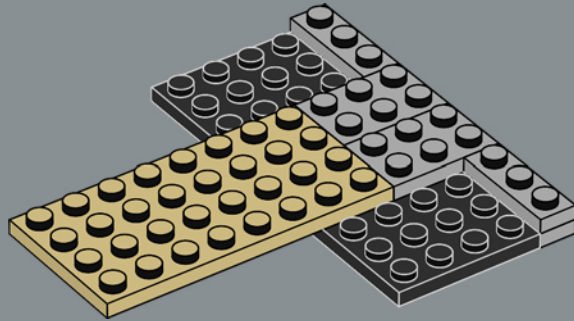

264

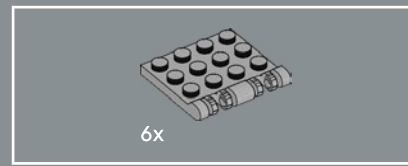
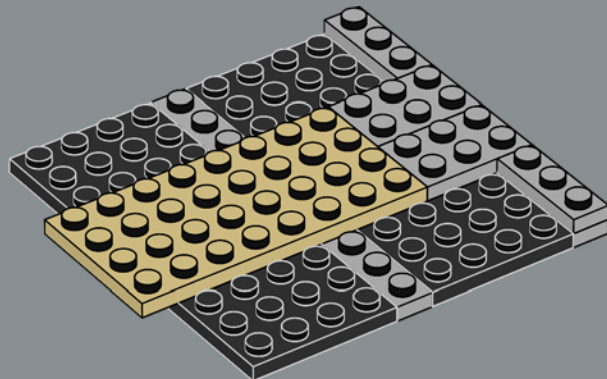

265

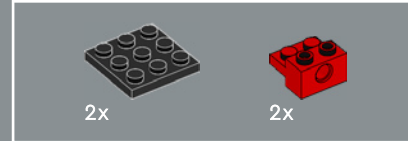
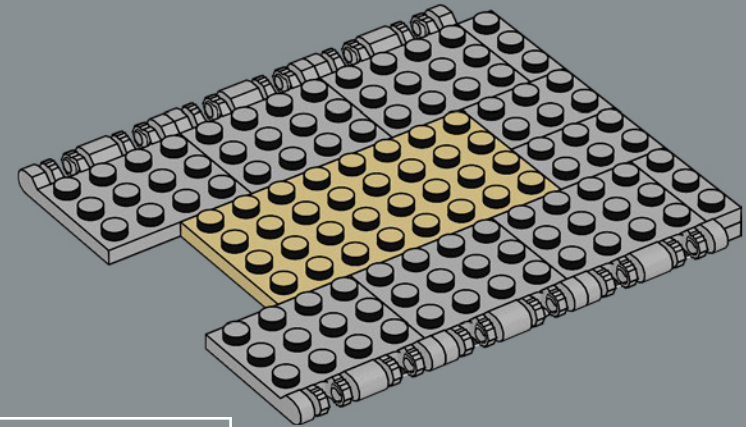

266

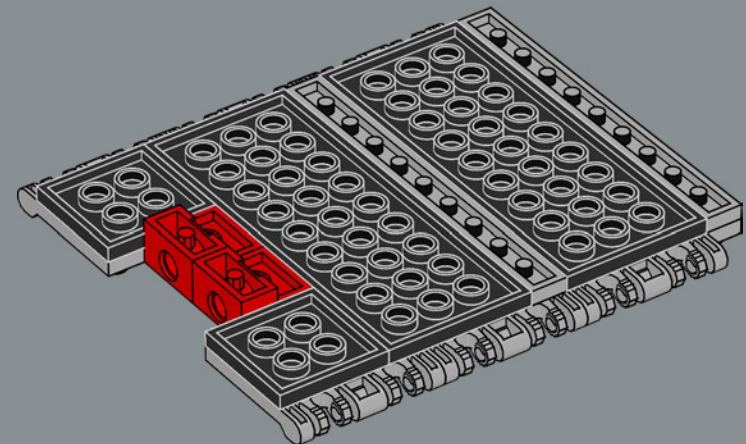





267

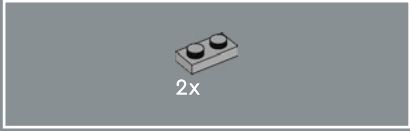
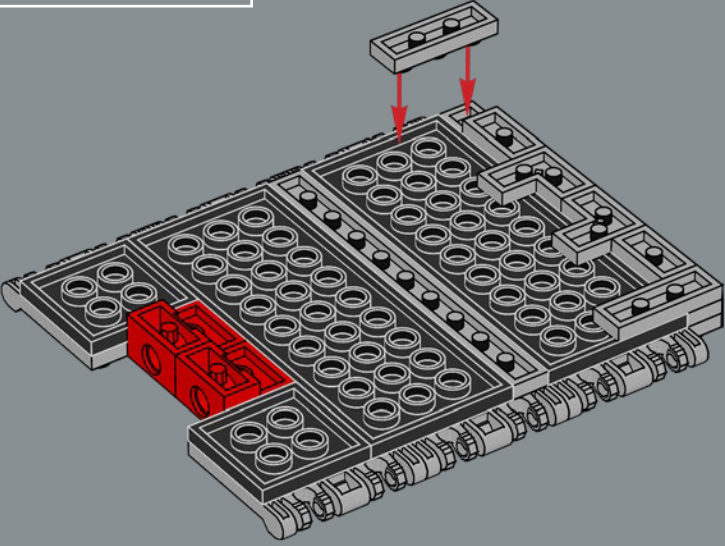

268

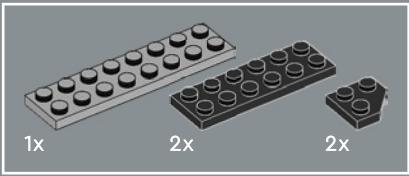
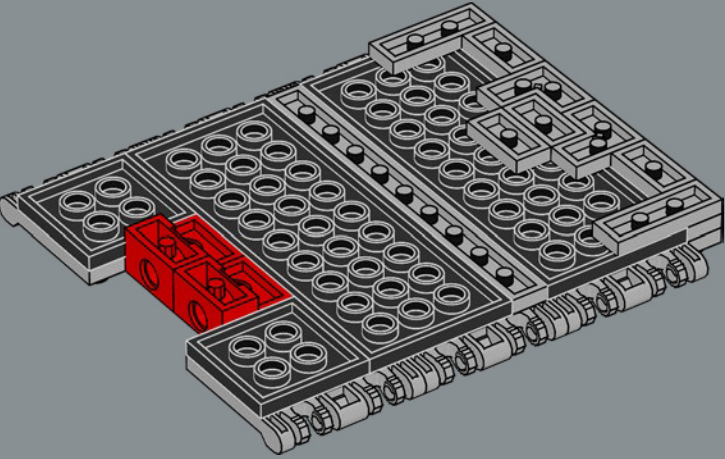

269

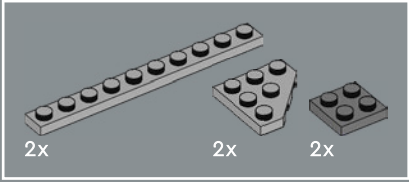
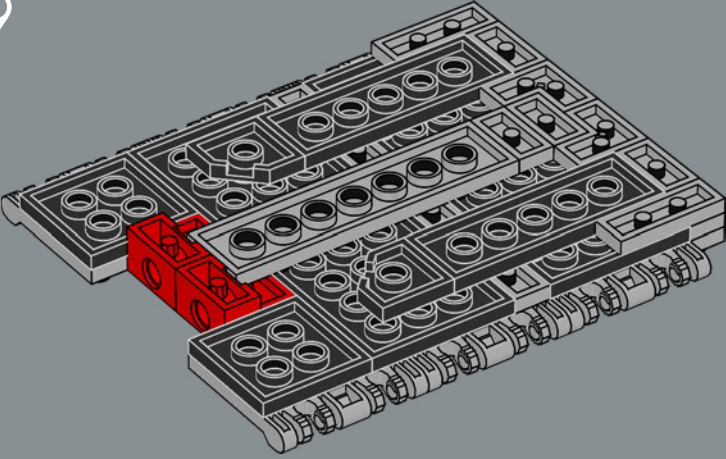

270

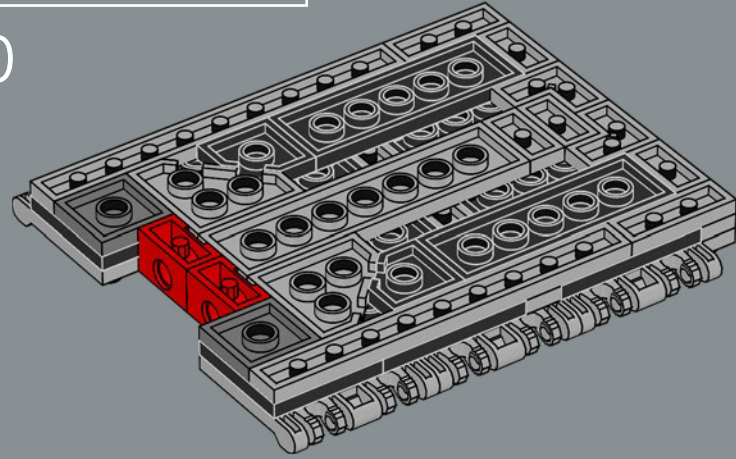



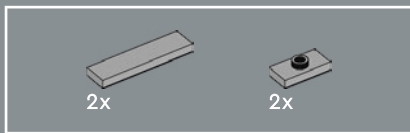

271

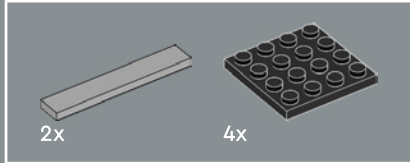
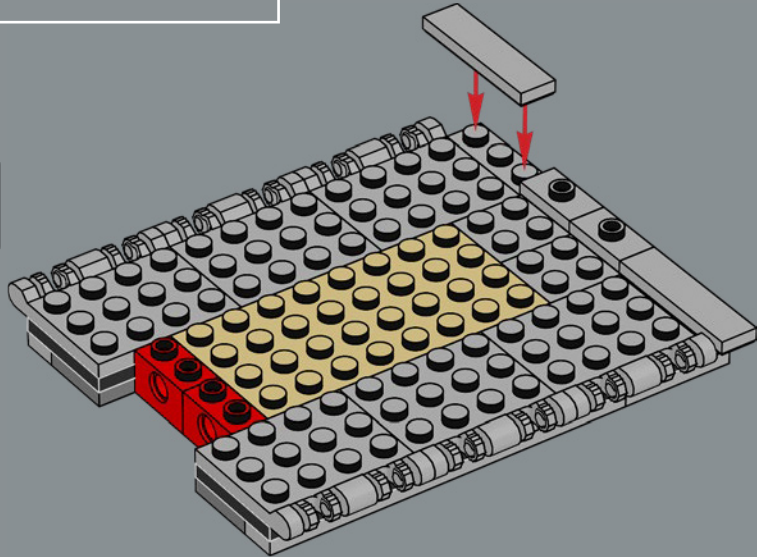

272

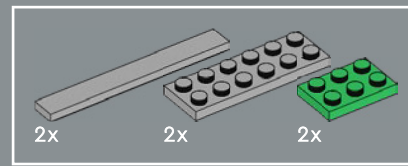
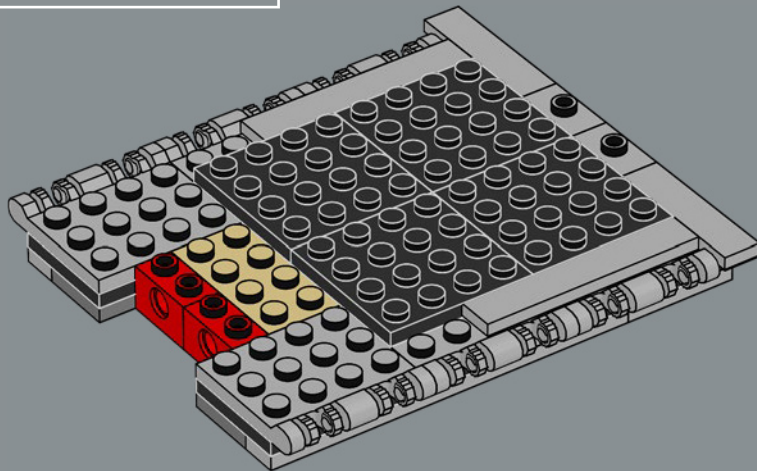

273

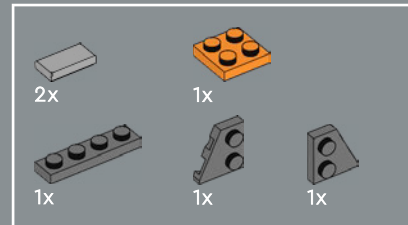
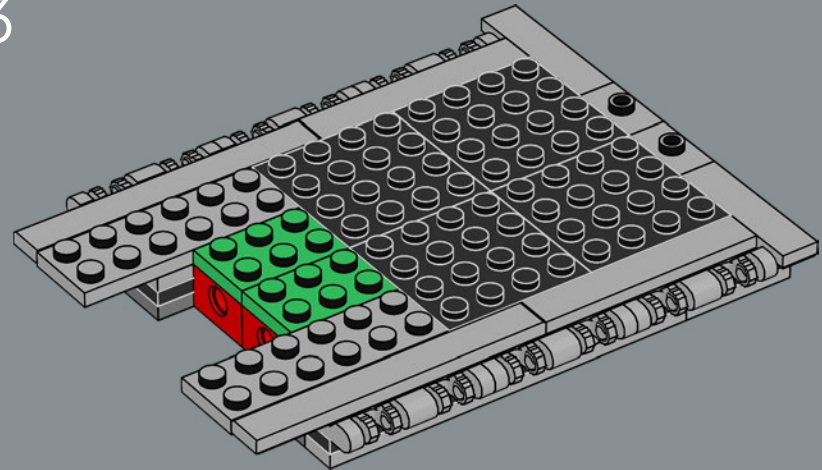

274

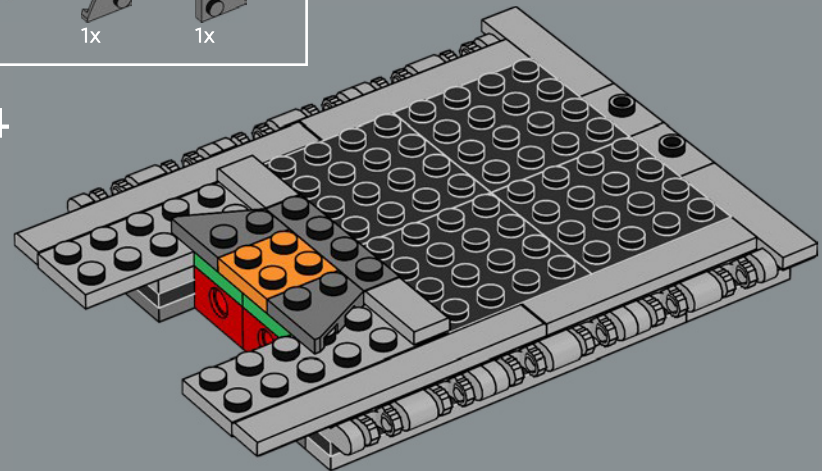

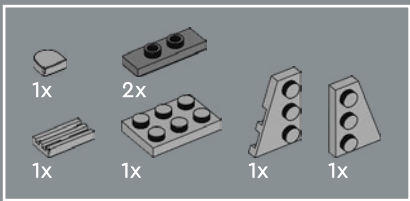

275

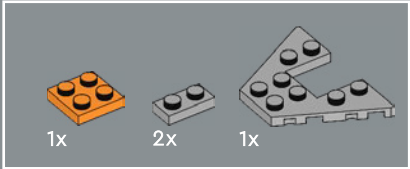
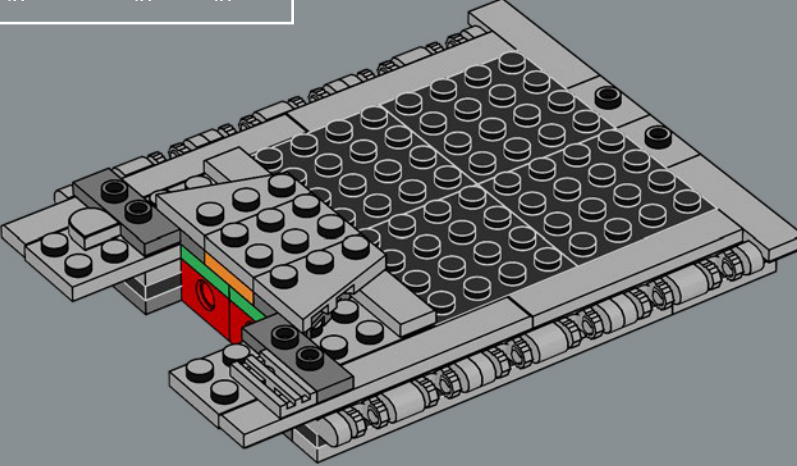

276

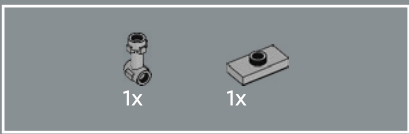
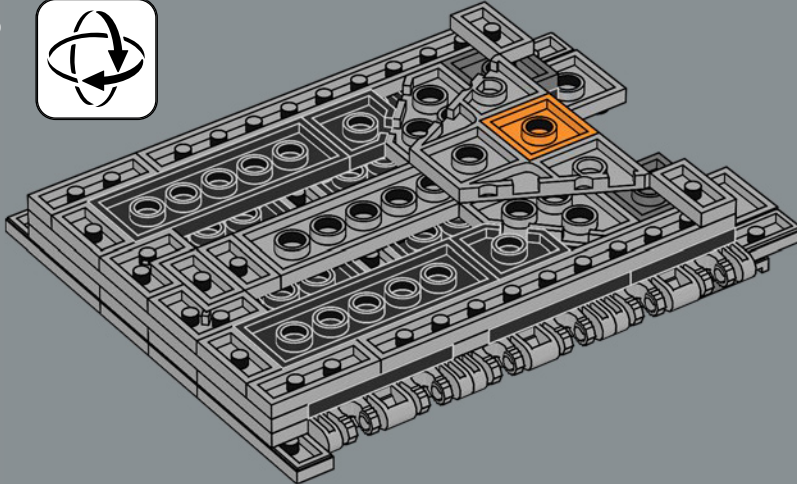

277

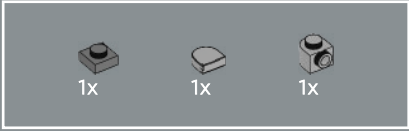
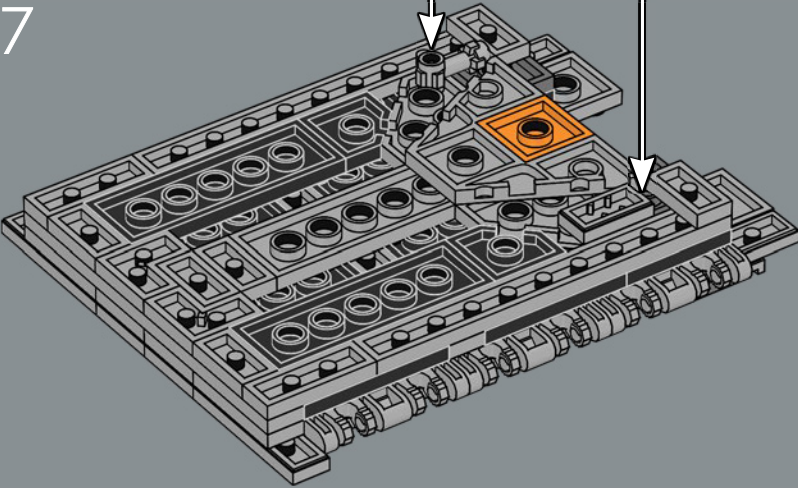
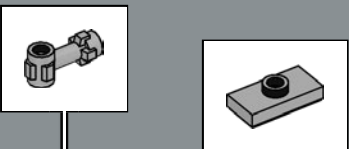

278

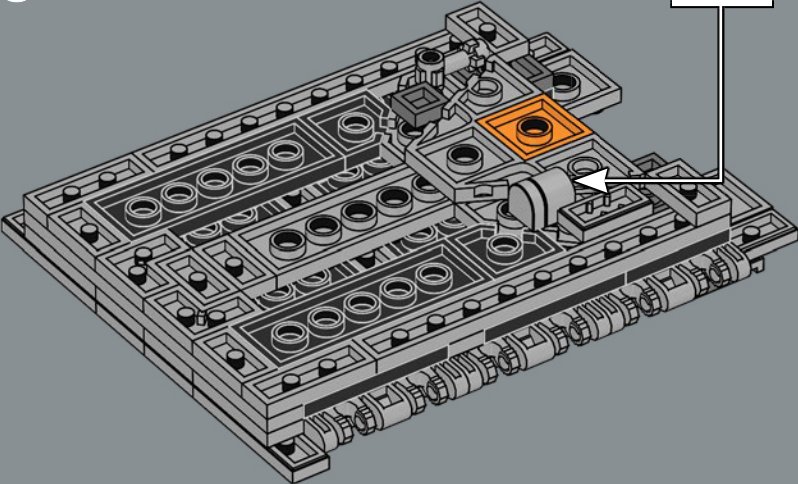
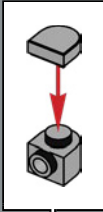



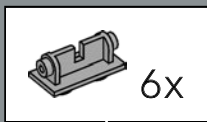
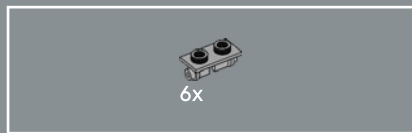

279

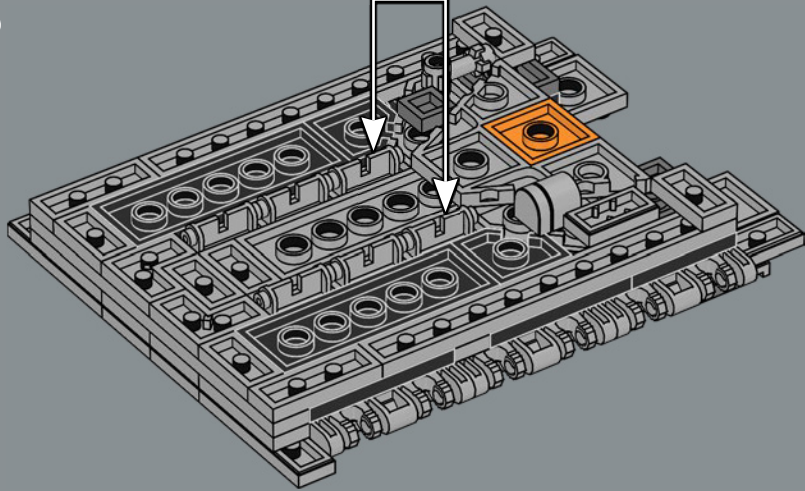

280

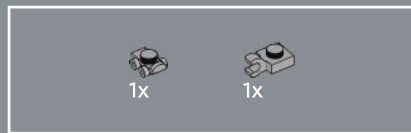
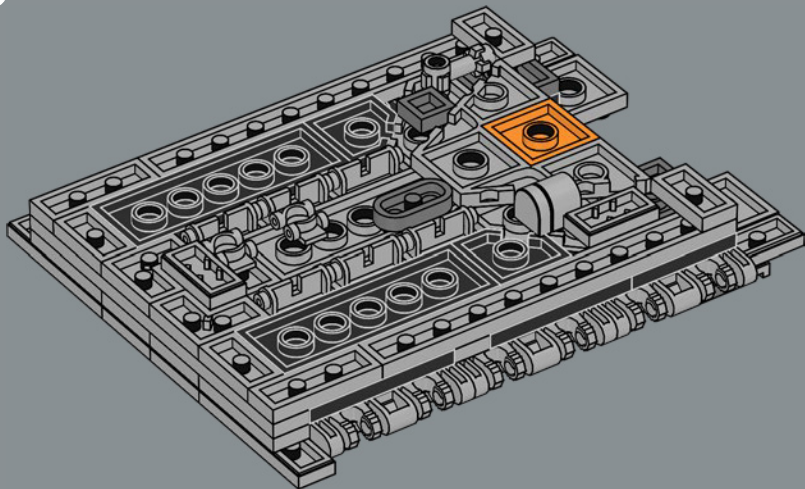

281

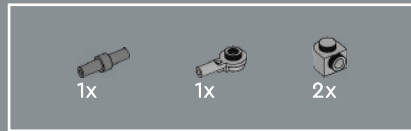
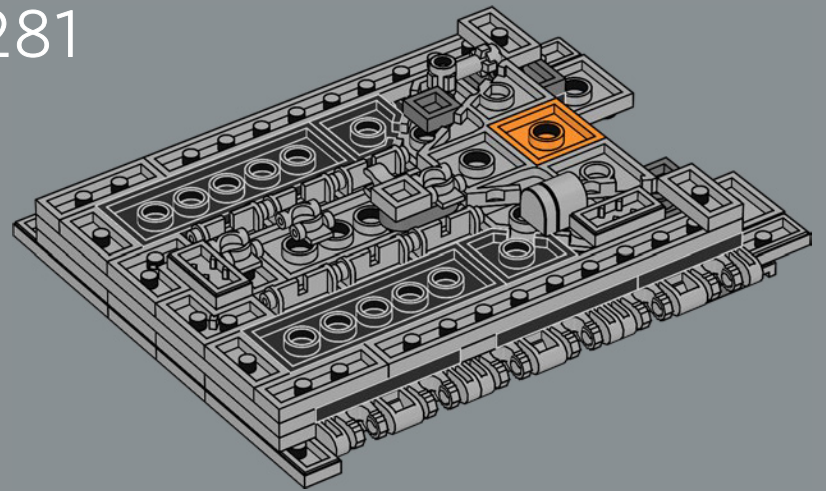

282

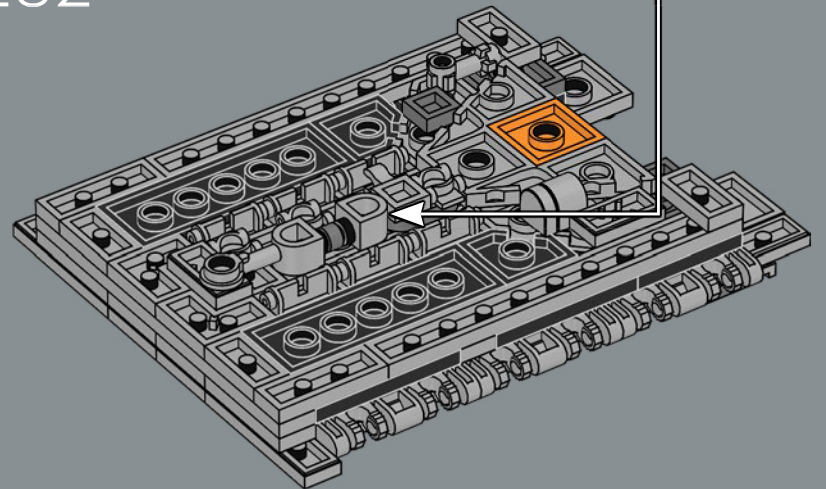
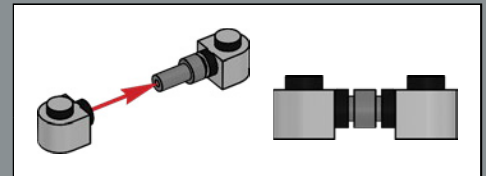



2x

283

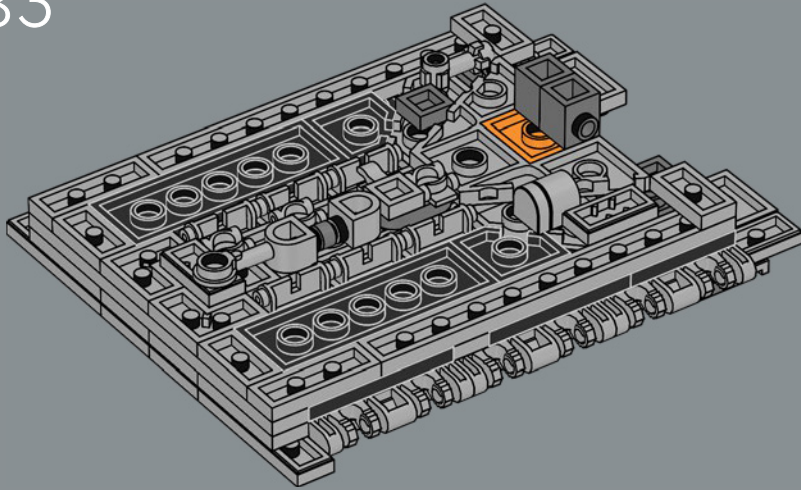

1x

284

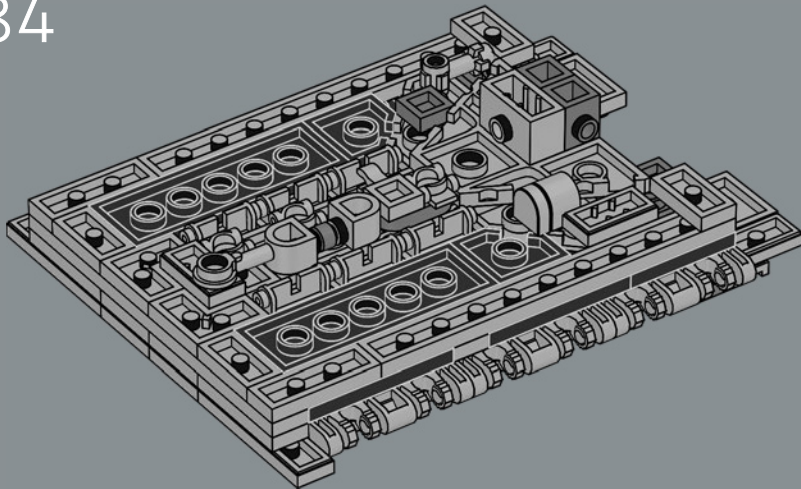

2x

285

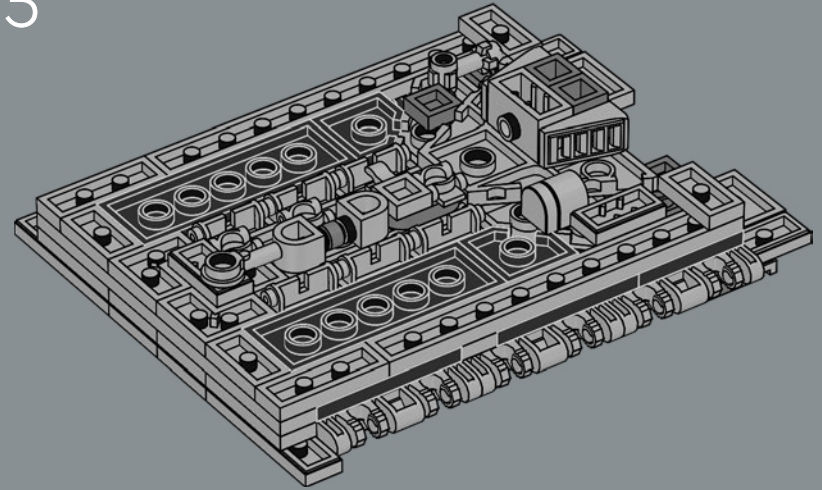

1x

286

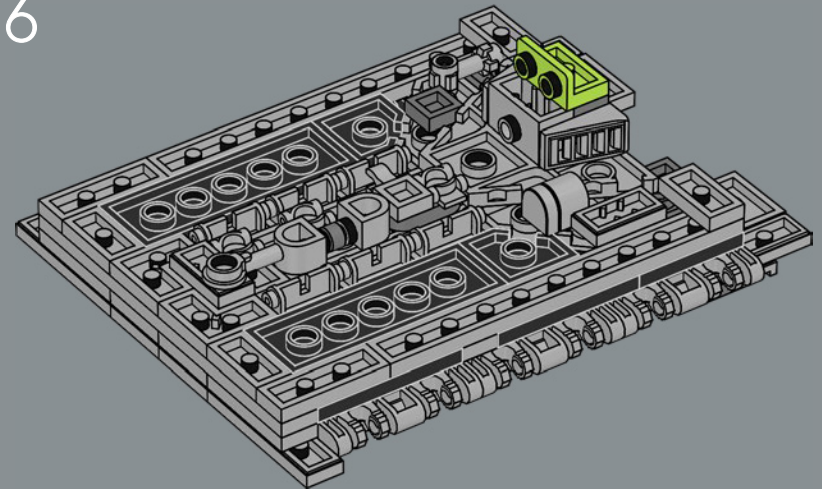



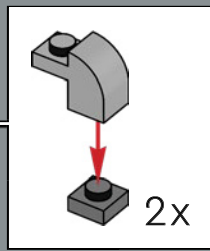
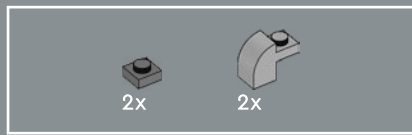

287

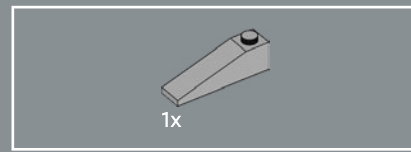
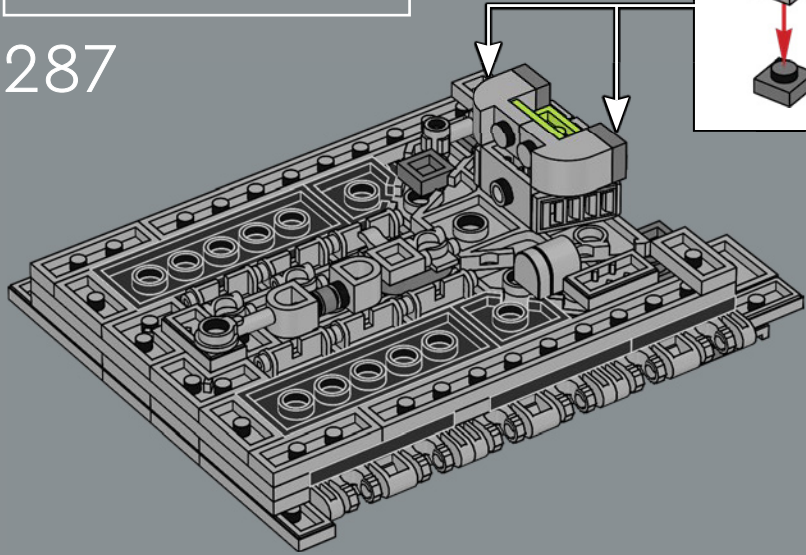

289

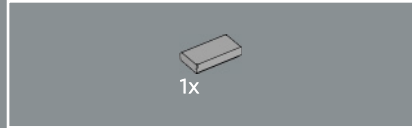
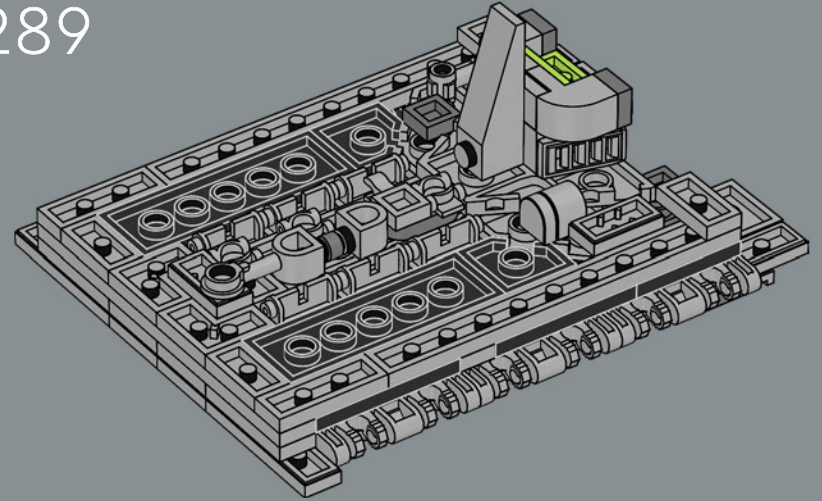

288

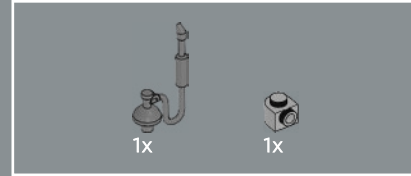
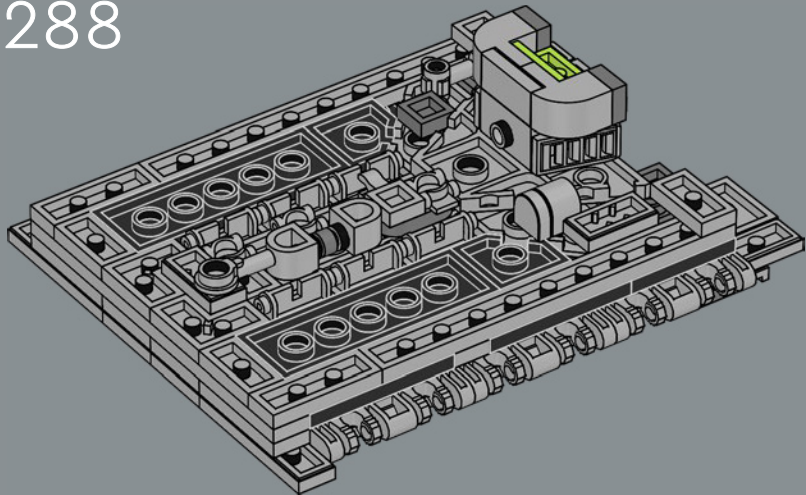

290

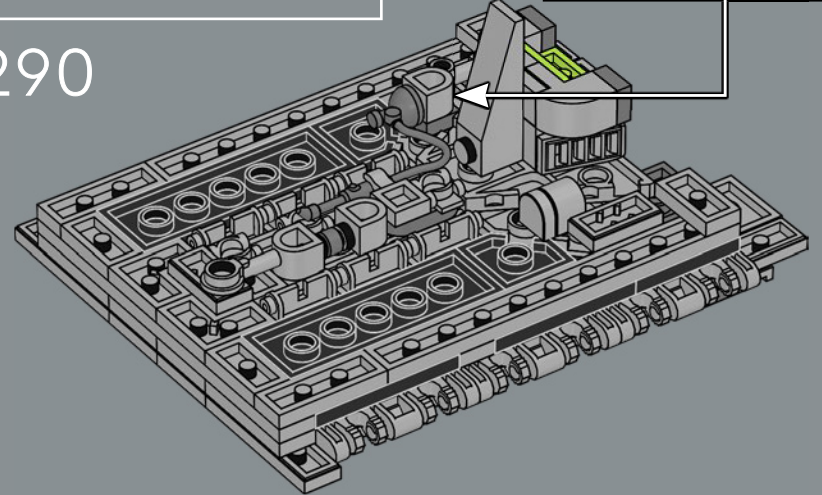
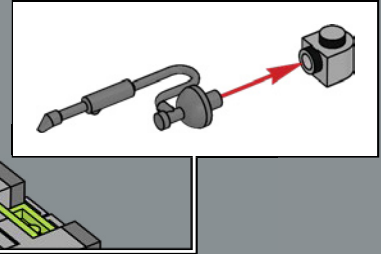

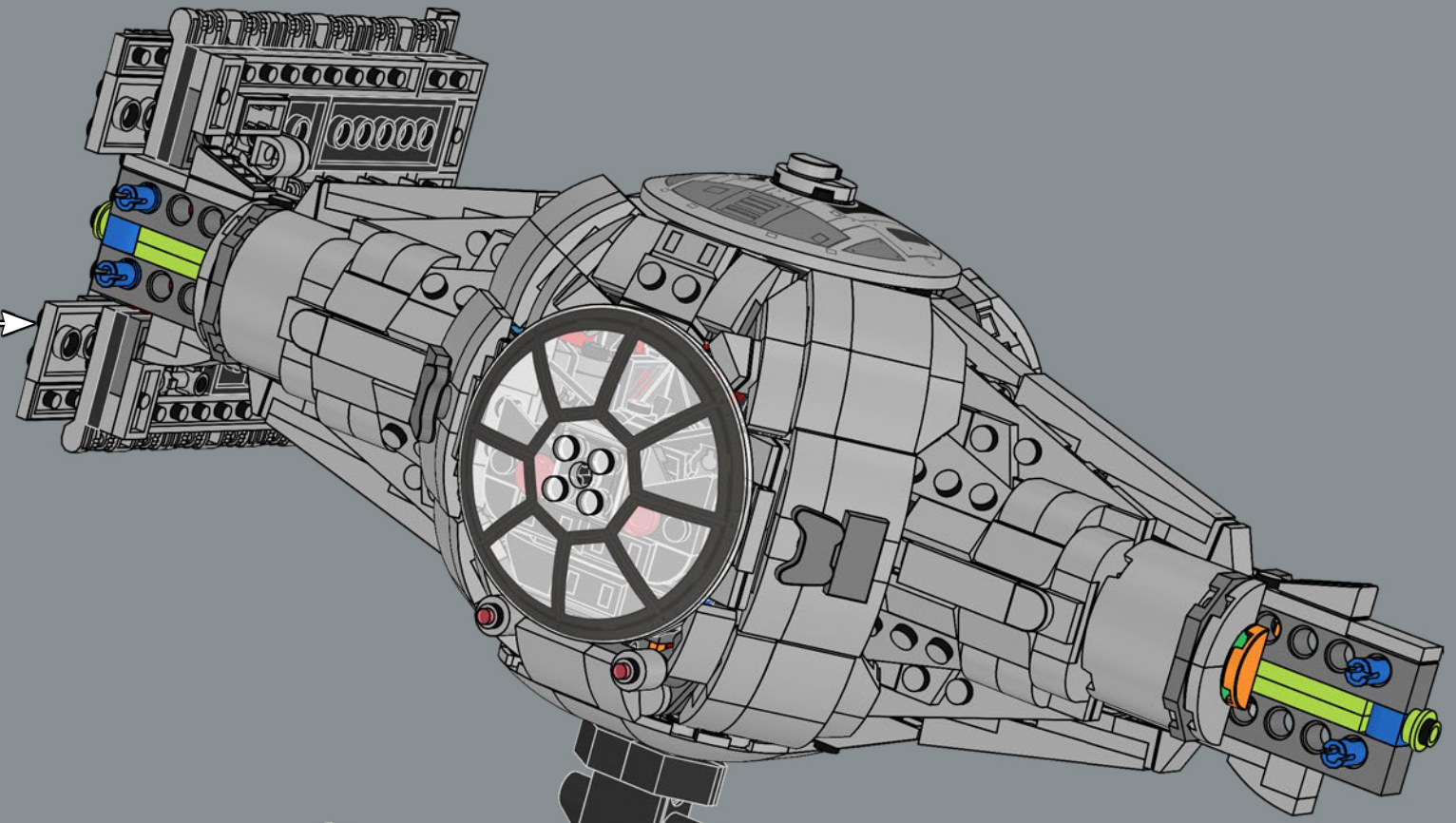

**STAR WARS**  
**TIE Interceptor™**

Manufacturer:	Siemar Fleet Systems
Affiliation:	Galactic Empire
Length:	7.7 m
Max Acceleration:	4,240 G
Engine:	SFS P-35.6 twin ion engine
Weapons:	4 L-39.3 laser cannons

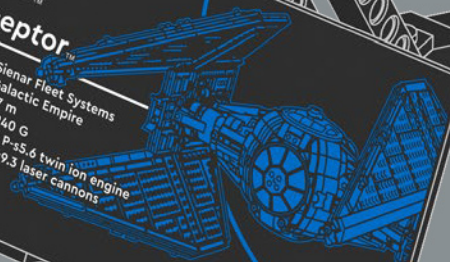

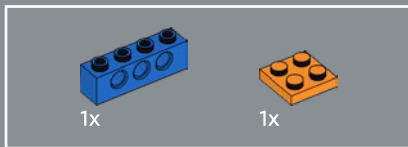
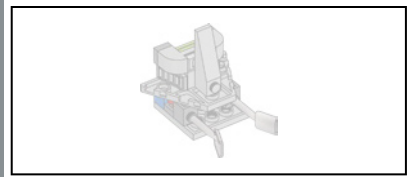

292

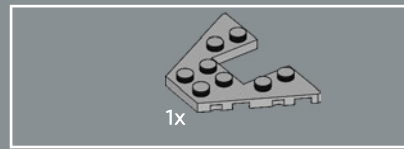
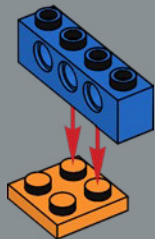

293

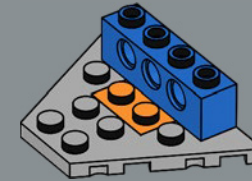

294

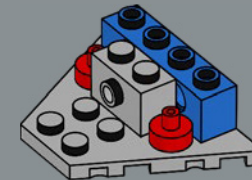

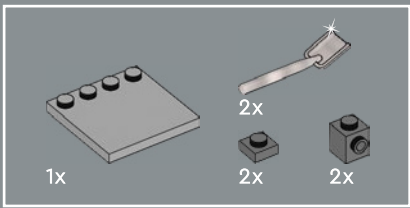

295

1

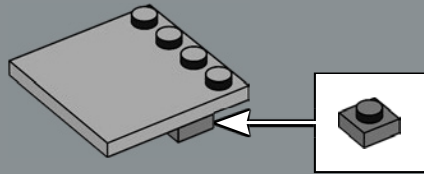

2

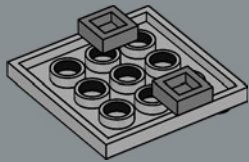

3

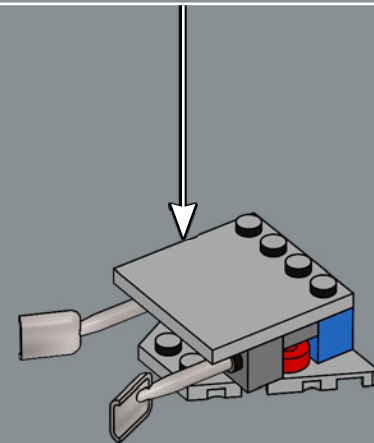
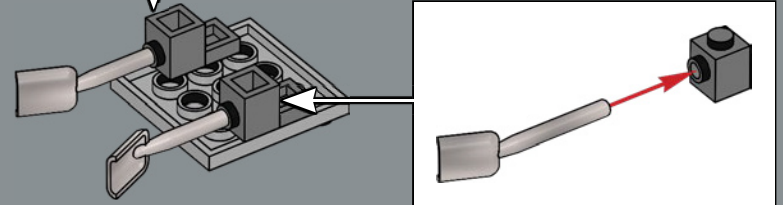
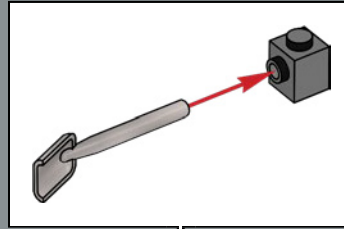





296

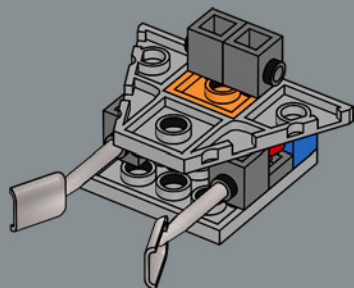

297

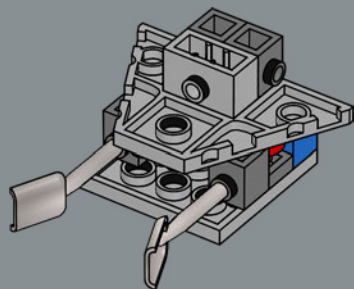

298

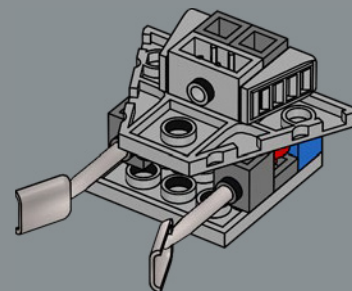

299

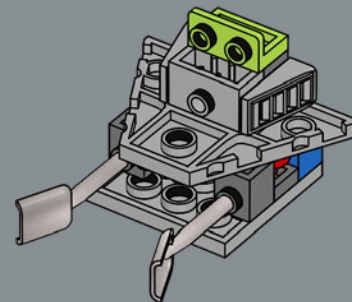

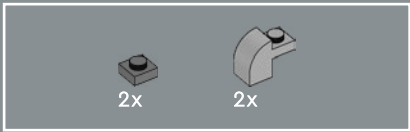

300

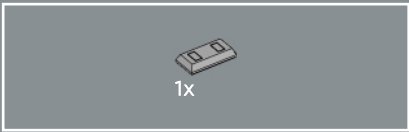
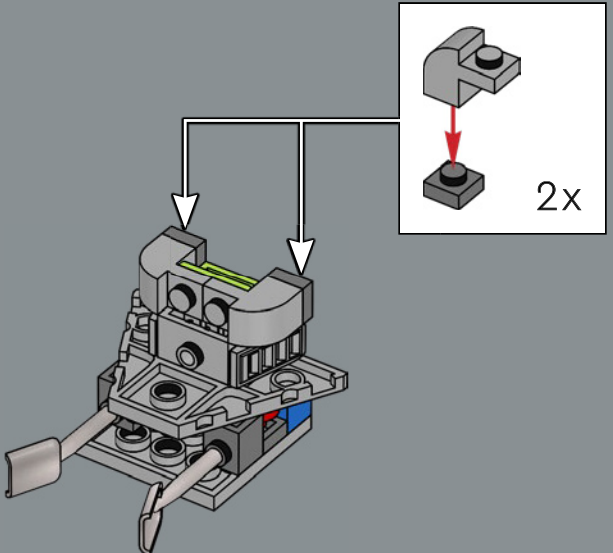

301

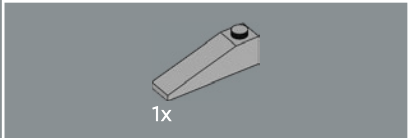
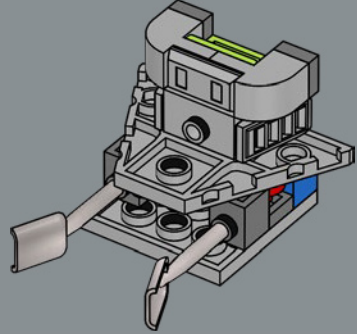

302

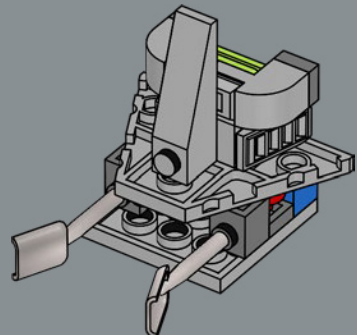

303

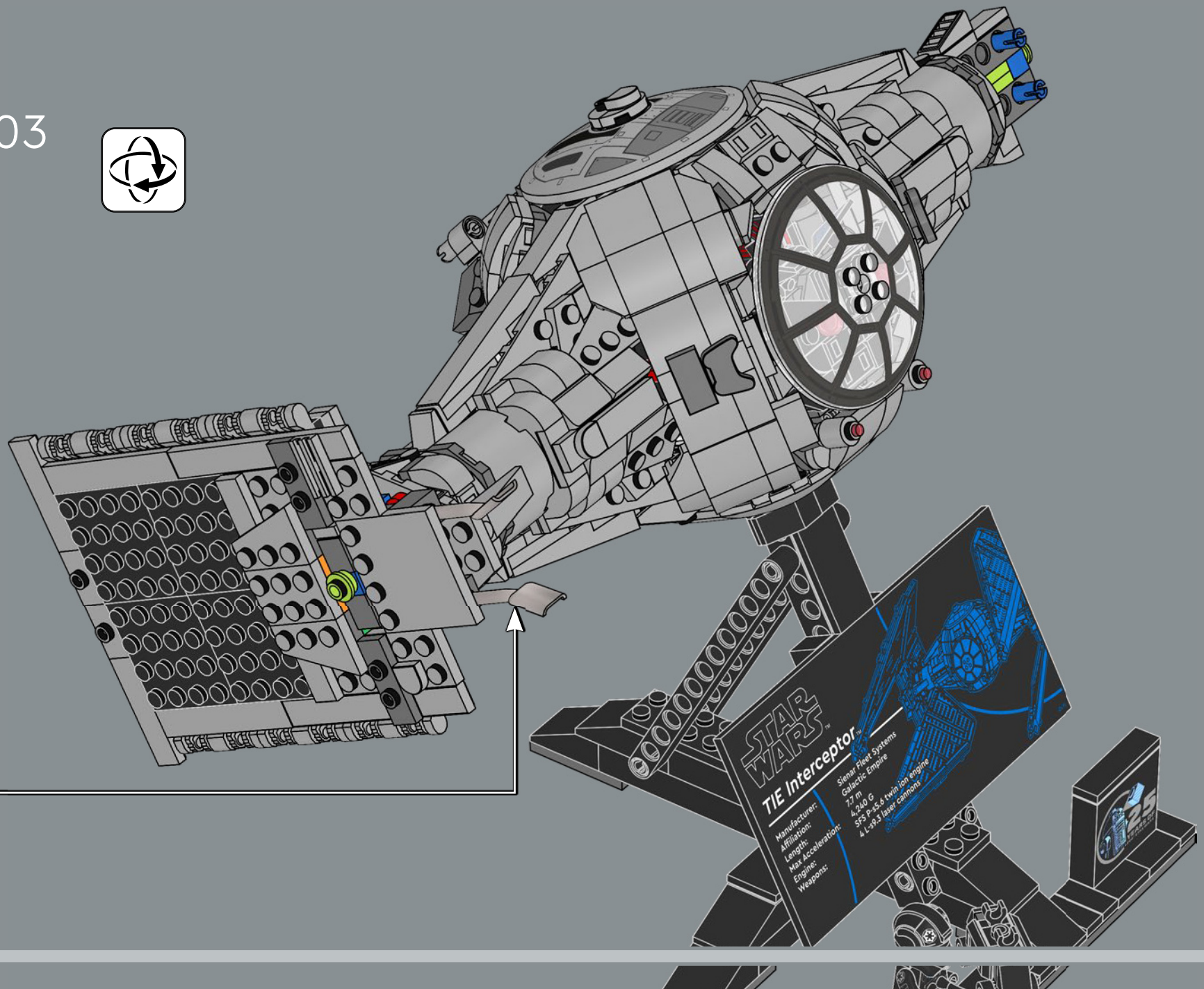

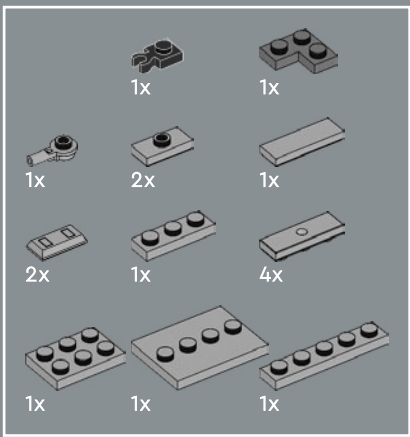

304

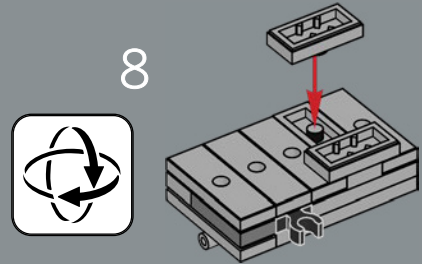
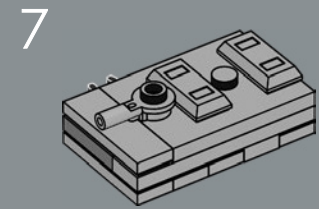
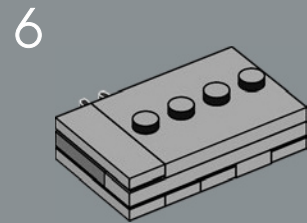
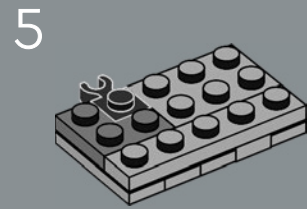
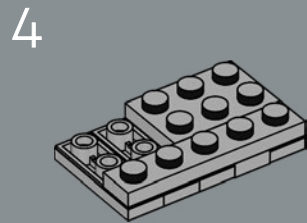
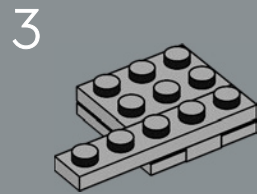
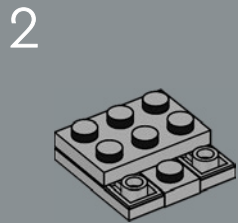
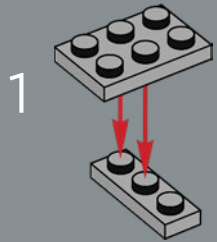



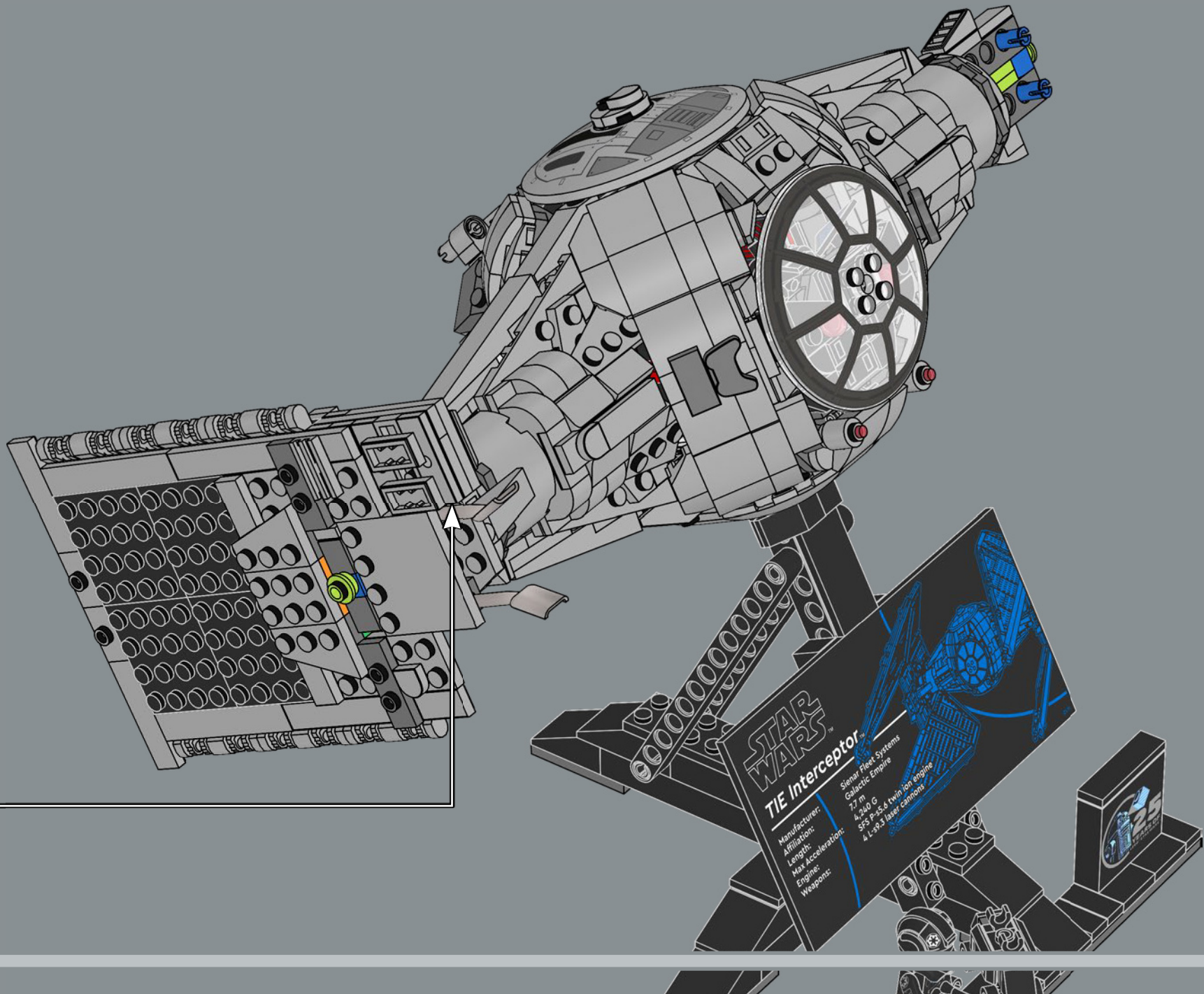

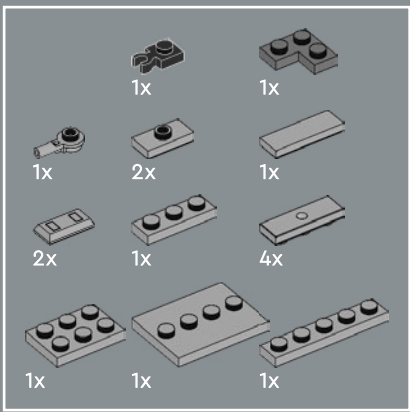

# 305

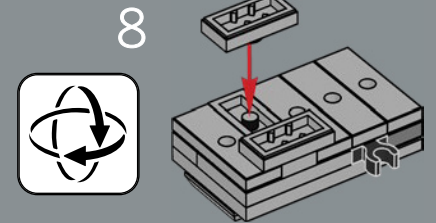
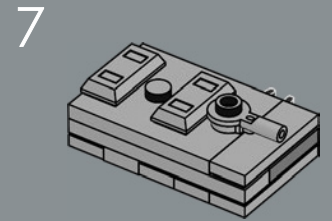
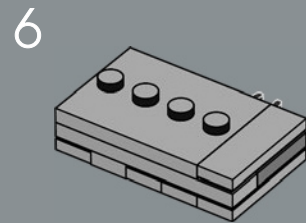
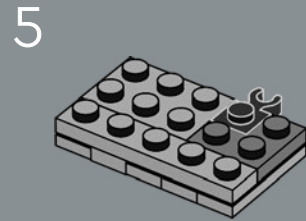
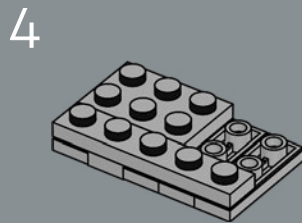
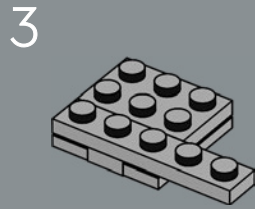
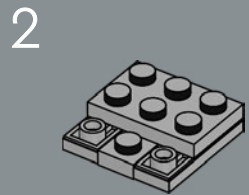
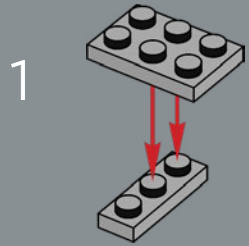

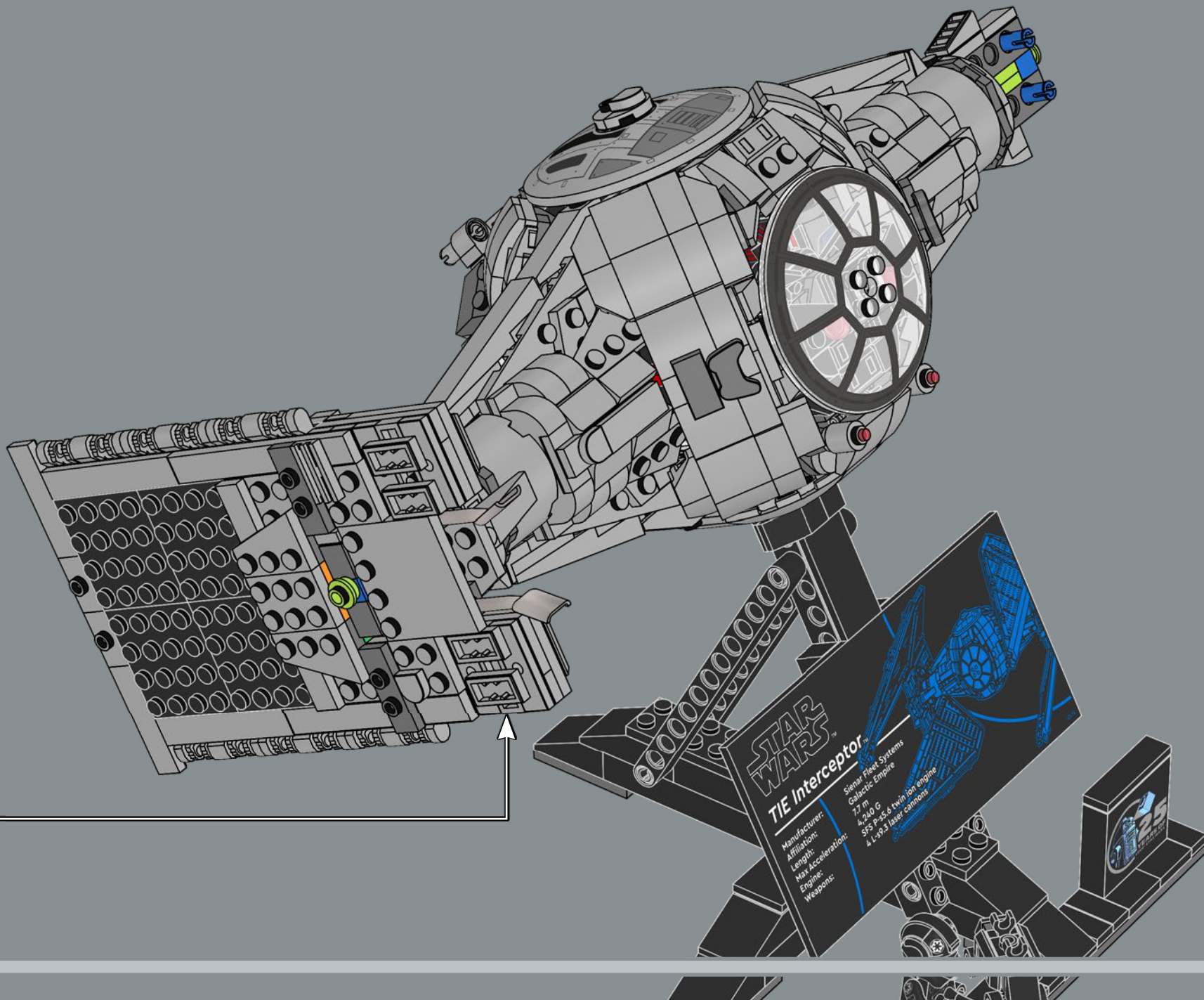

**STAR WARS**  
**TIE Interceptor™**

Manufacturer:  
Sienar Fleet Systems  
Affiliation:  
Galactic Empire  
Length:  
7.7 m  
Max. Acceleration:  
4,240 G  
Engine:  
SFS P-5S & twin ion engine  
Weapons:  
4 L-3R 3 laser cannons





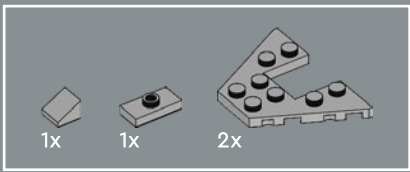

306

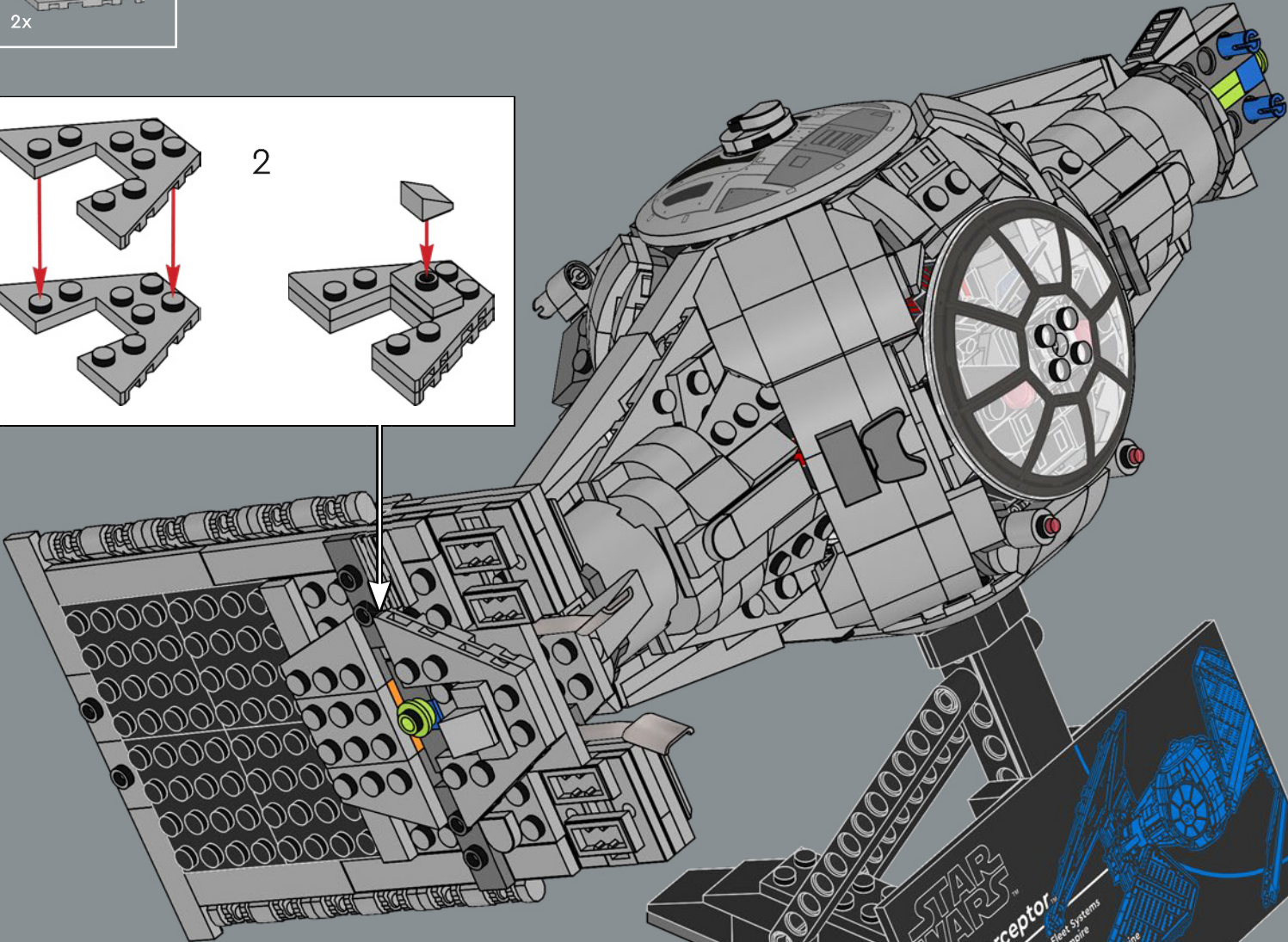
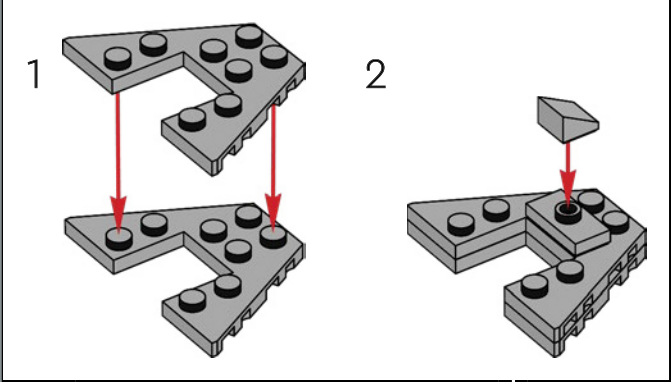



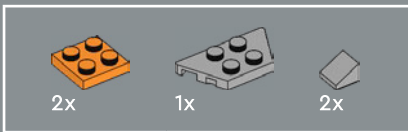

307

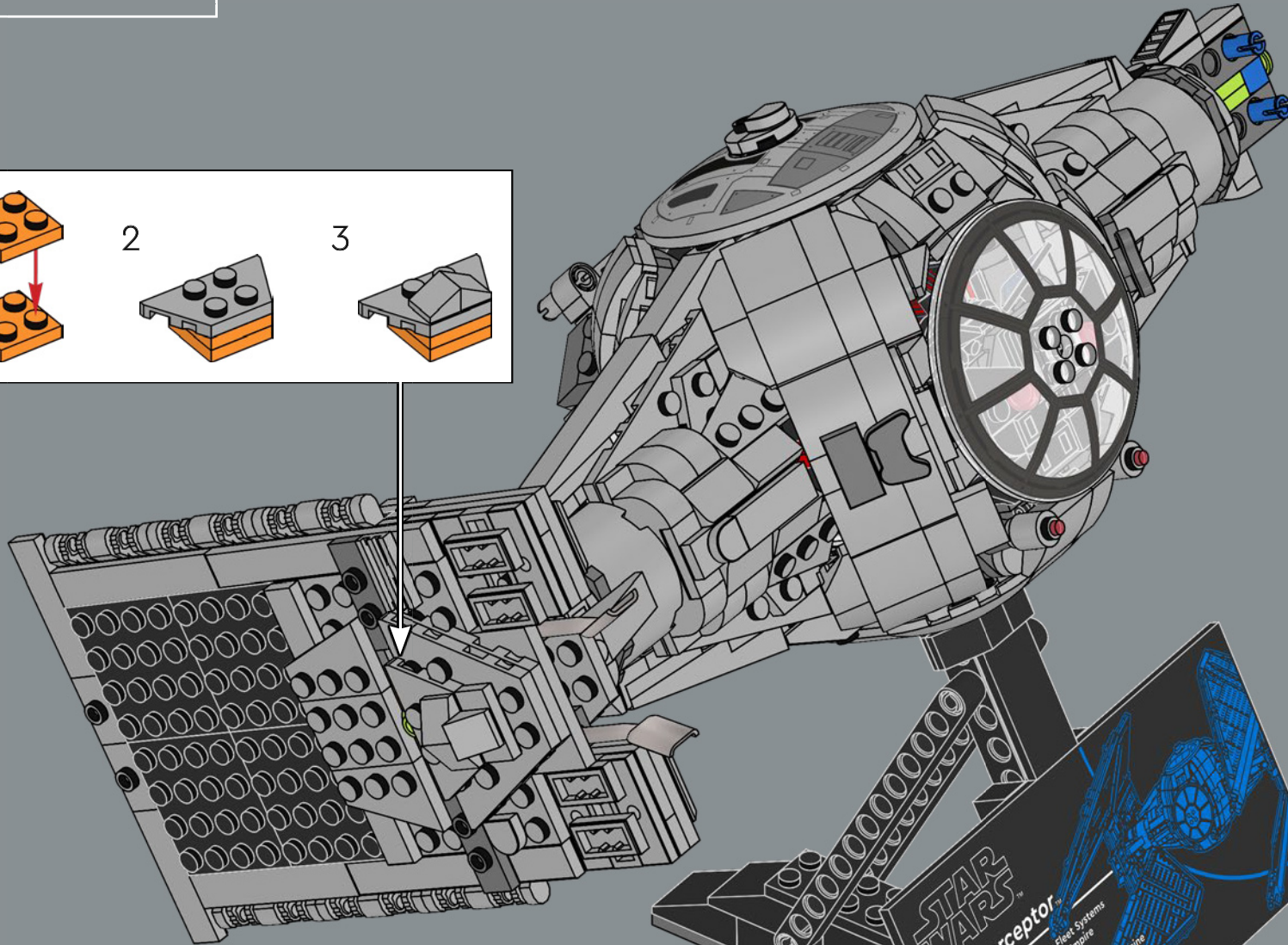
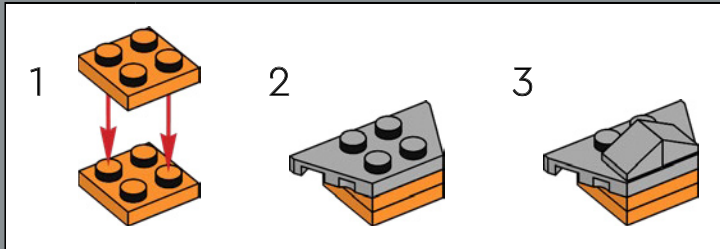

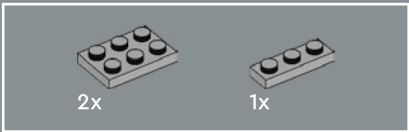

309

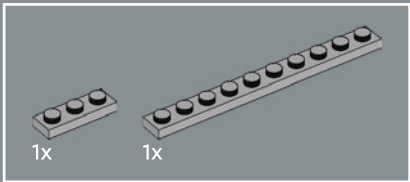
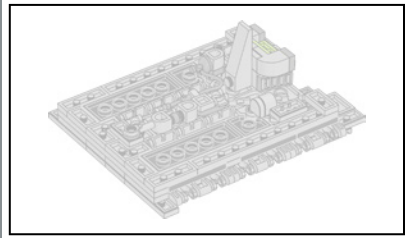
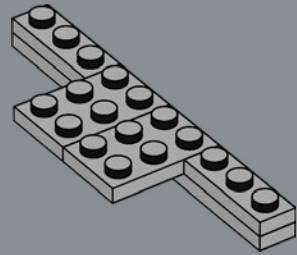

308

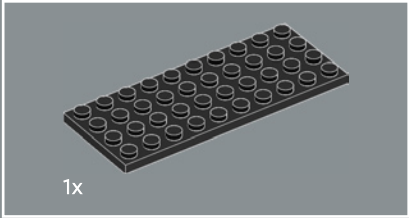
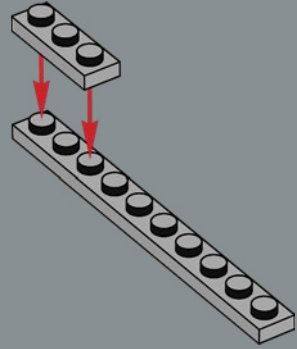

310

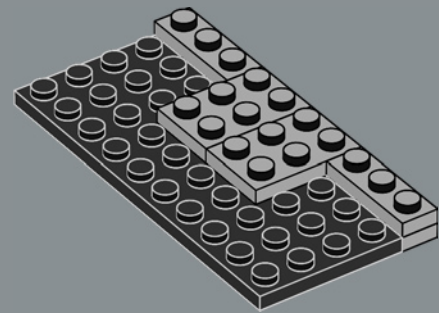

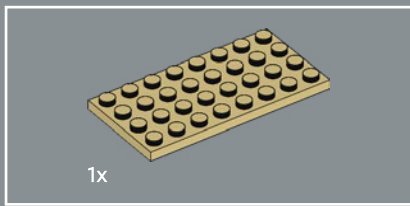

311

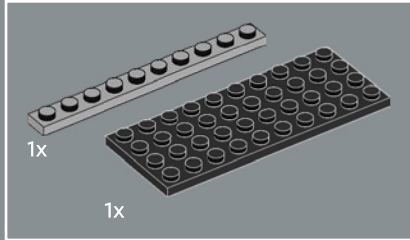
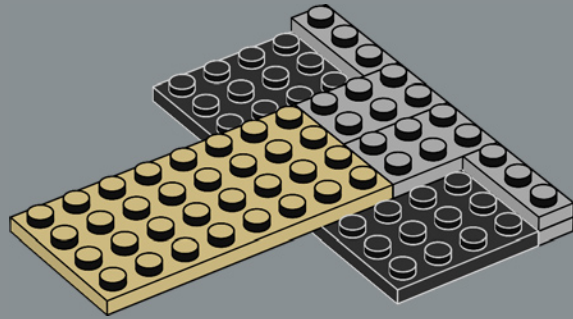

312

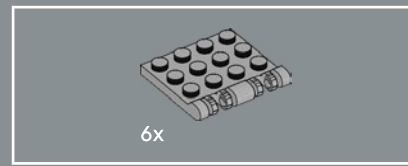
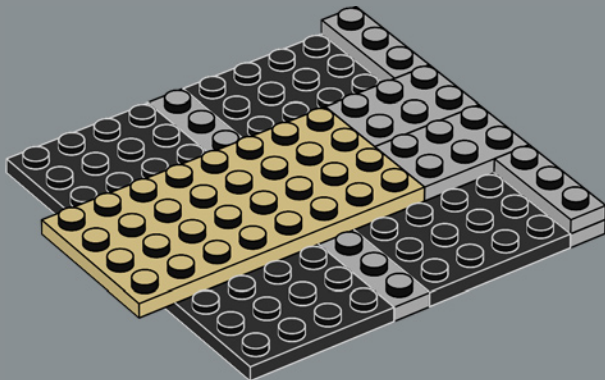

313

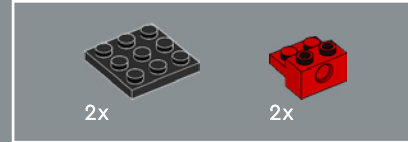
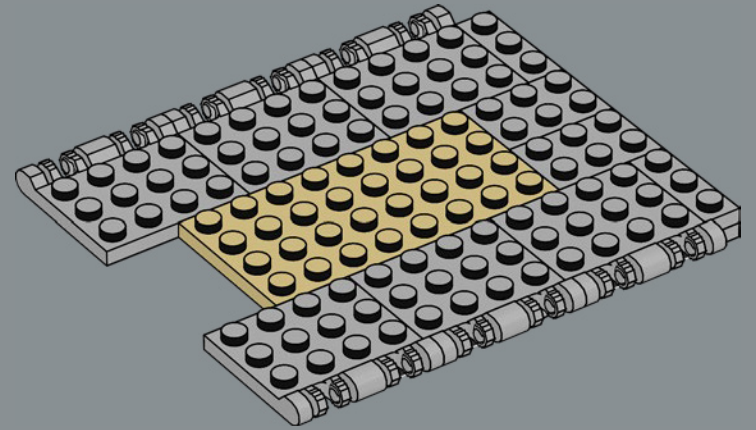

314

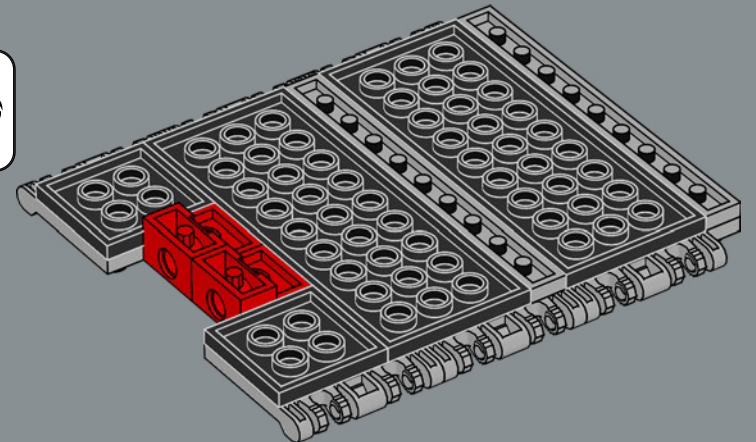



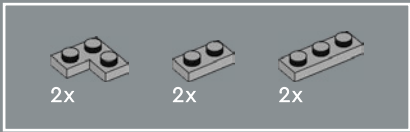

315

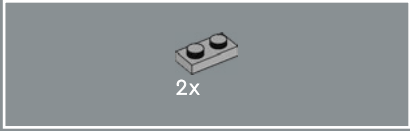
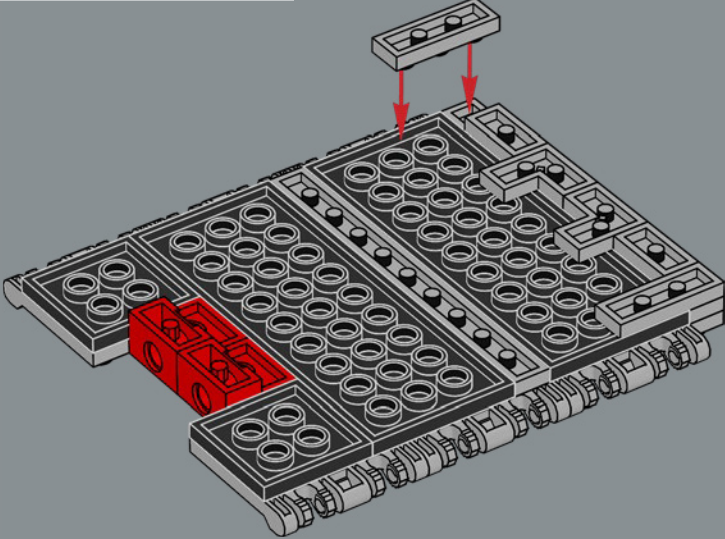

316

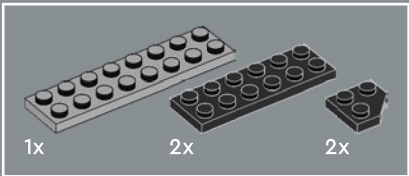
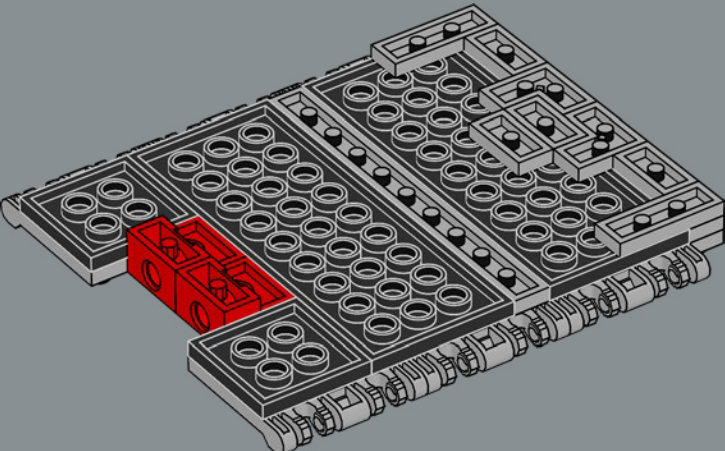

317

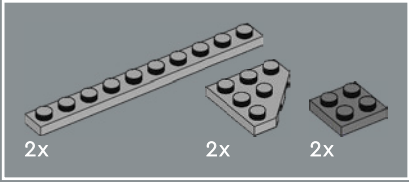
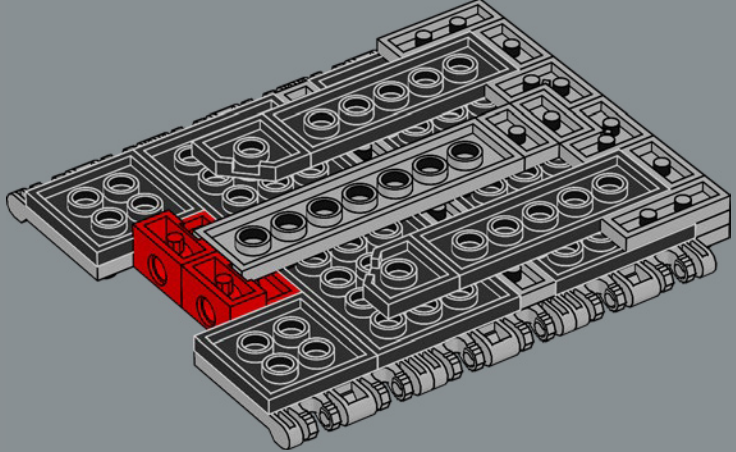

318

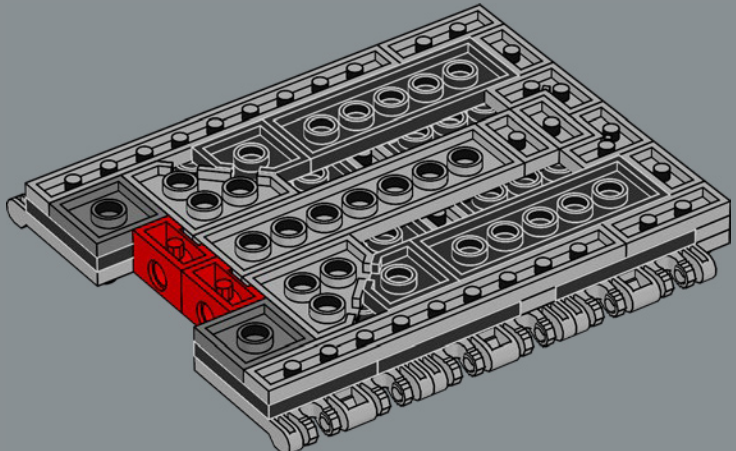



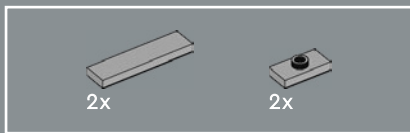

319

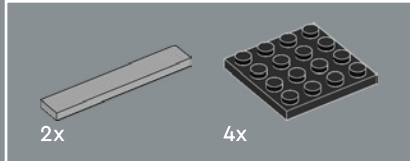
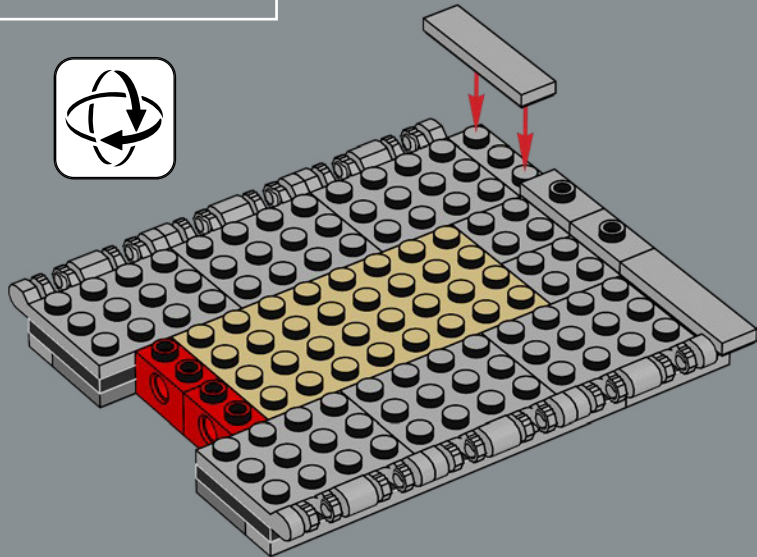

320

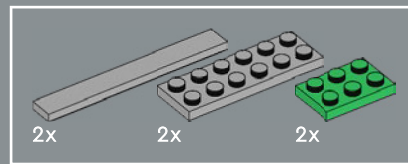
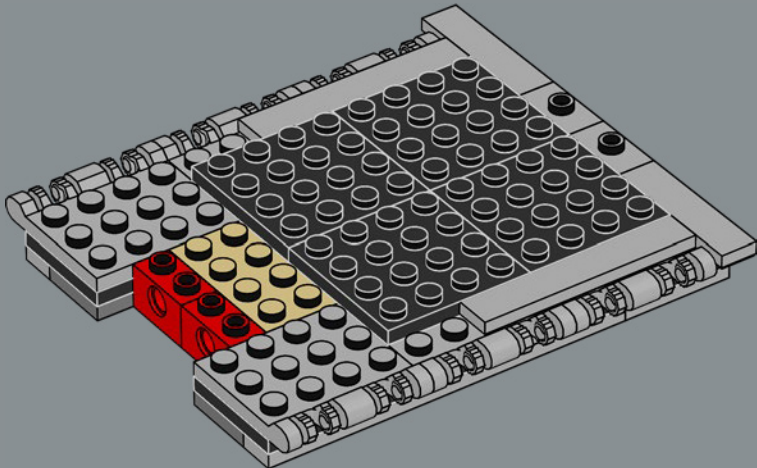

321

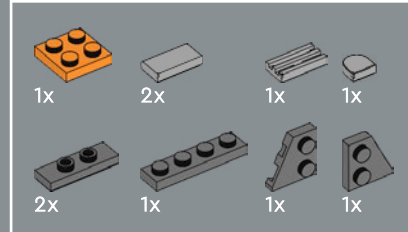
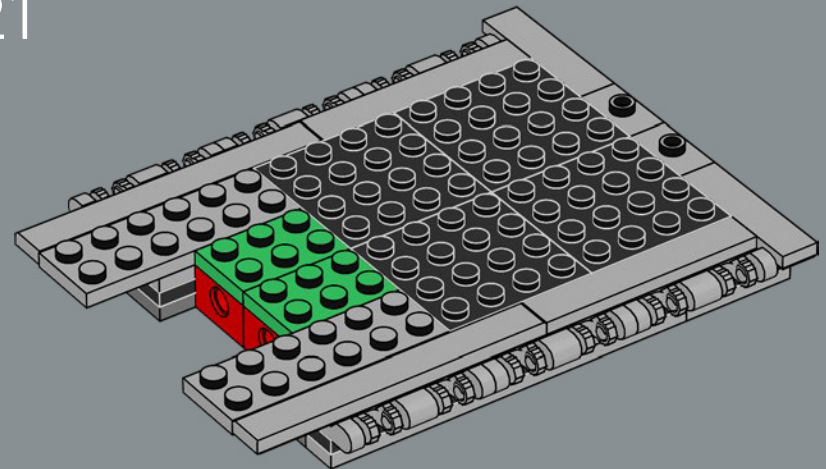

322

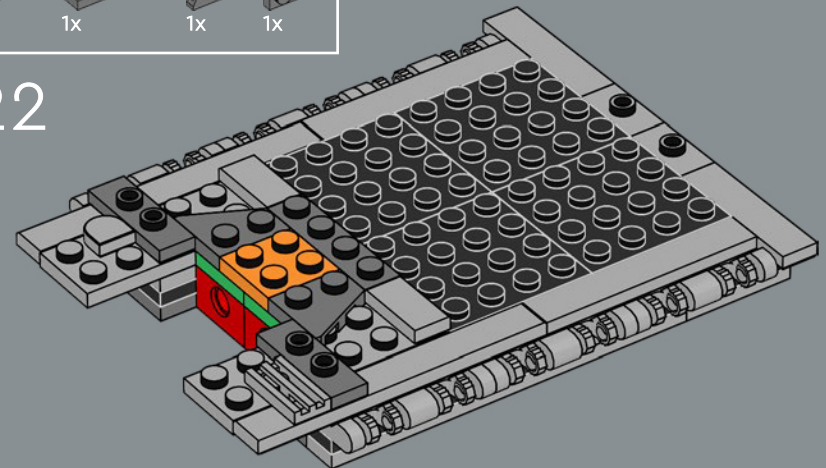

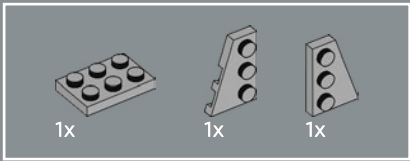

323

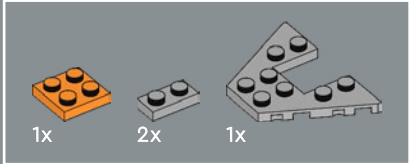
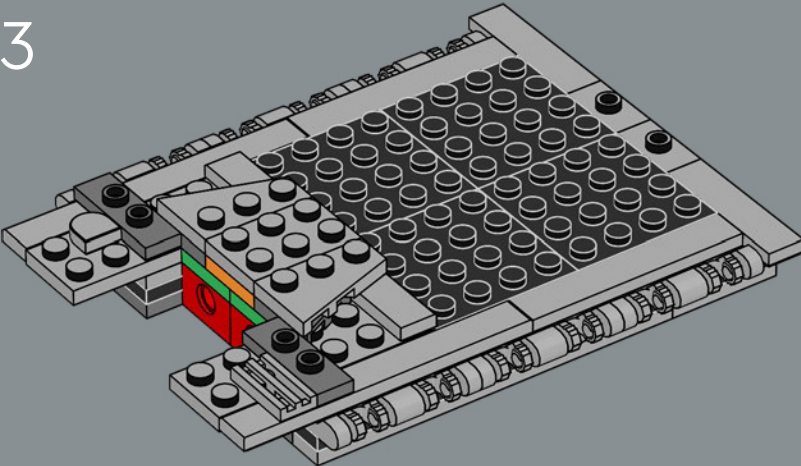

324

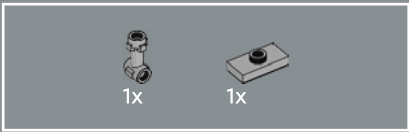
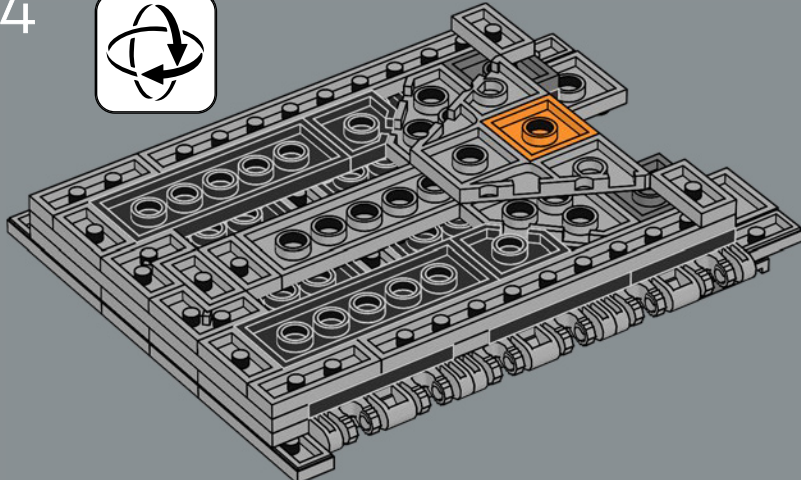

325

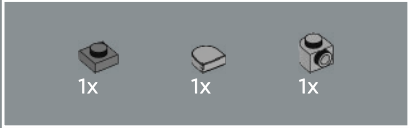
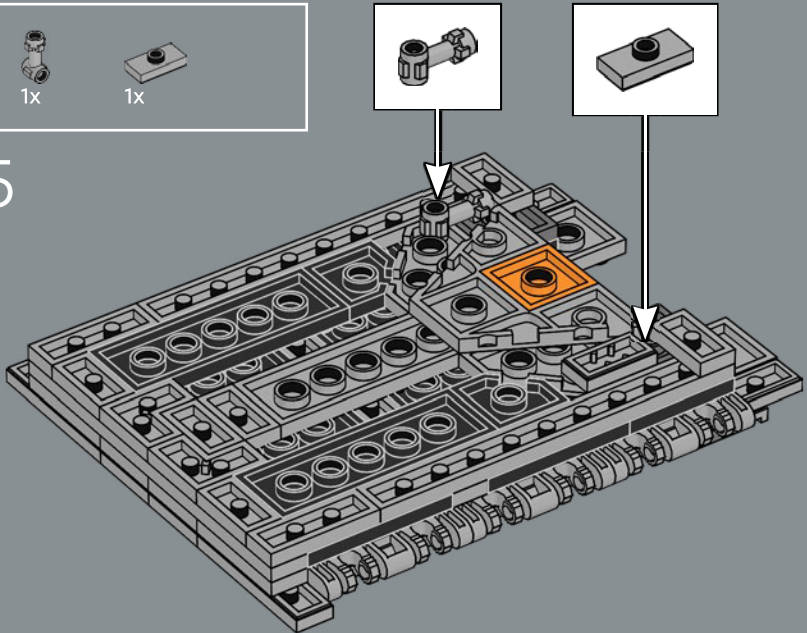

326

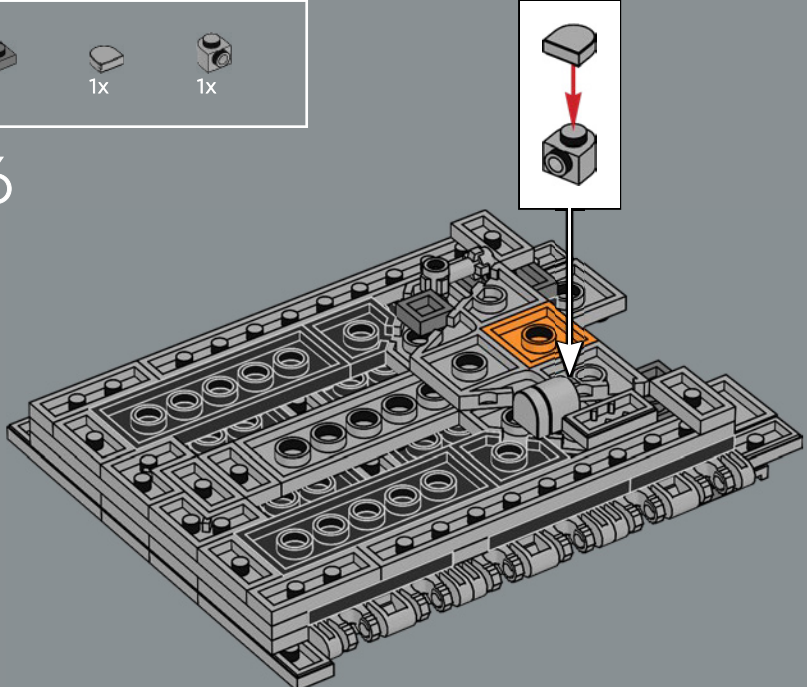



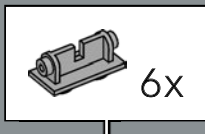

327

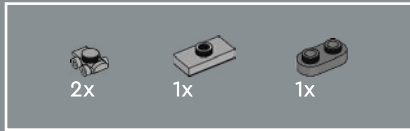
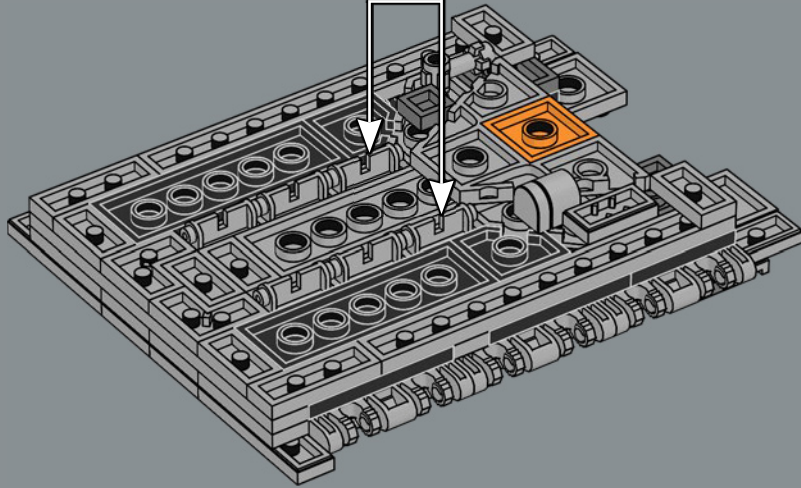

328

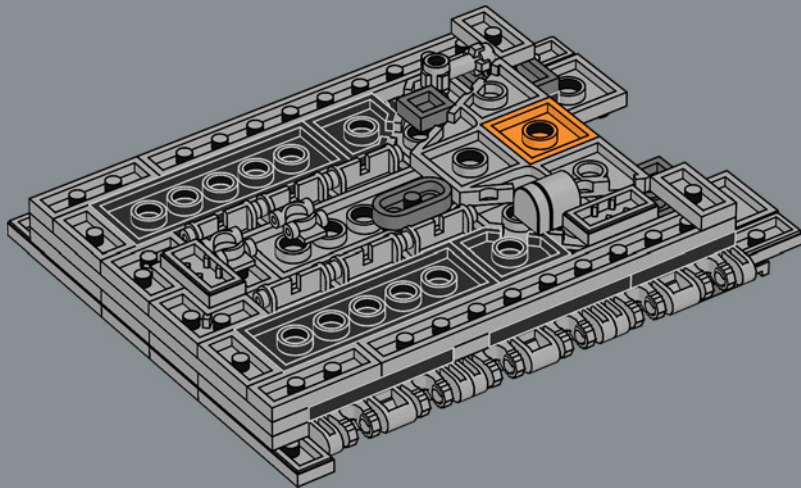

329

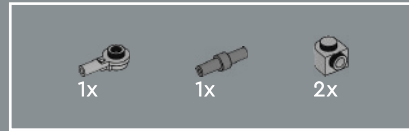
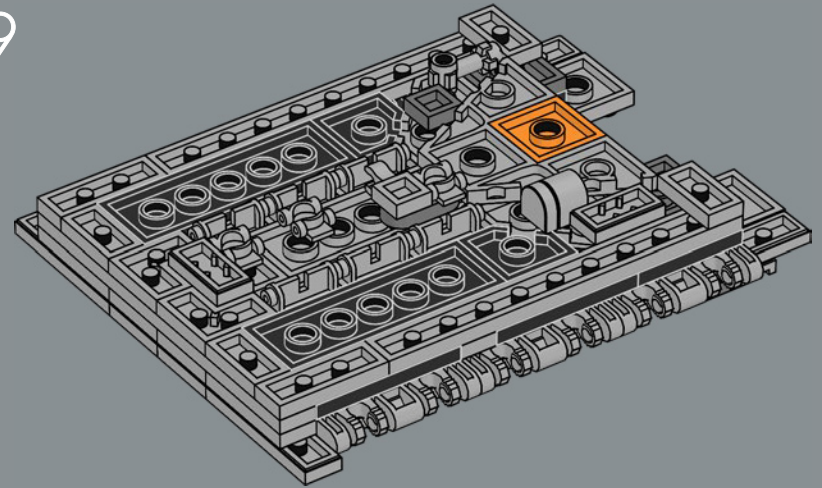

330

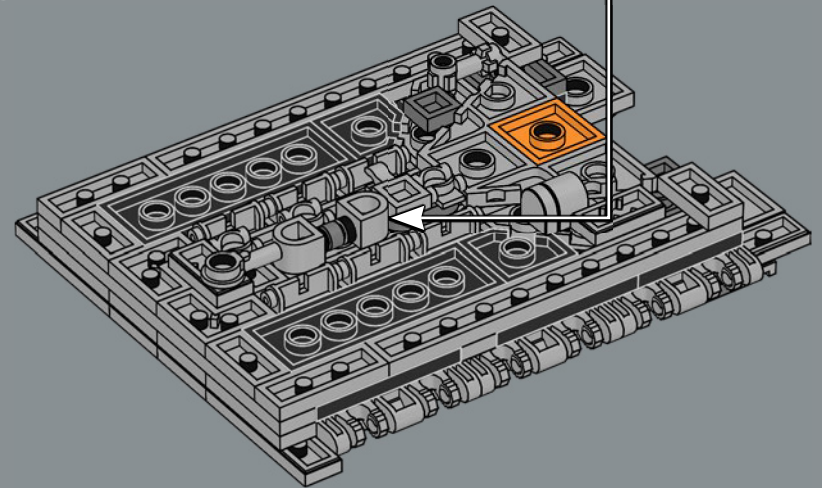
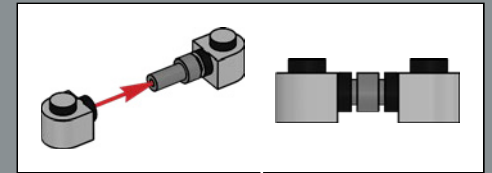



2x

331

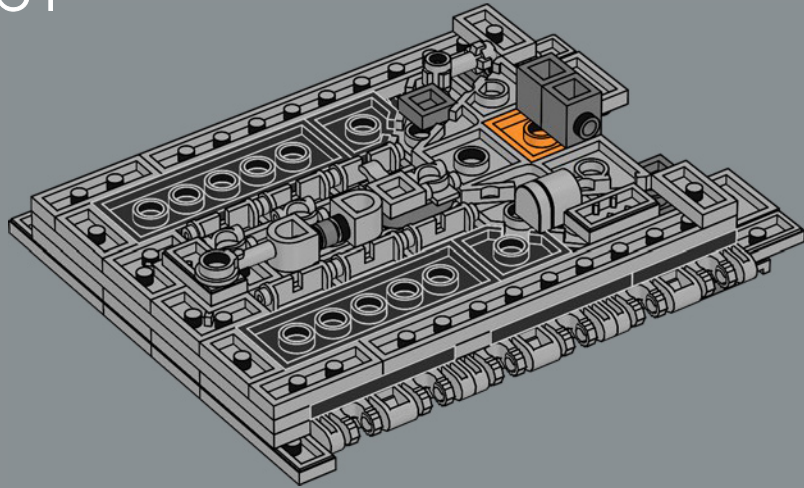

1x

332

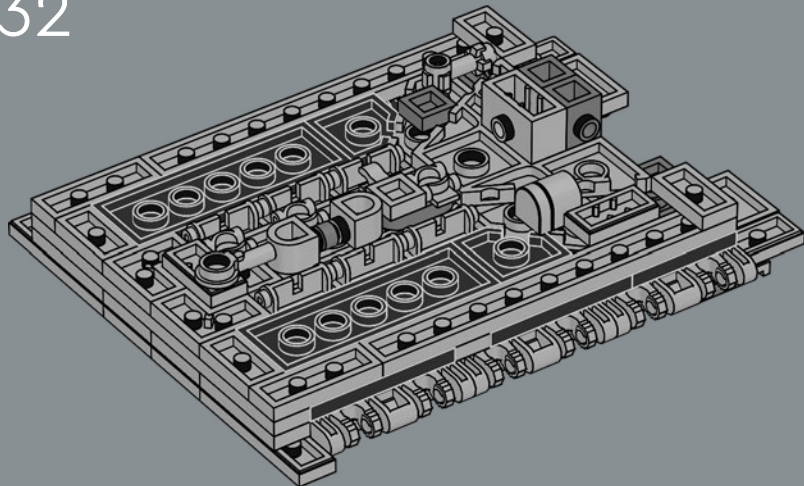

2x

333

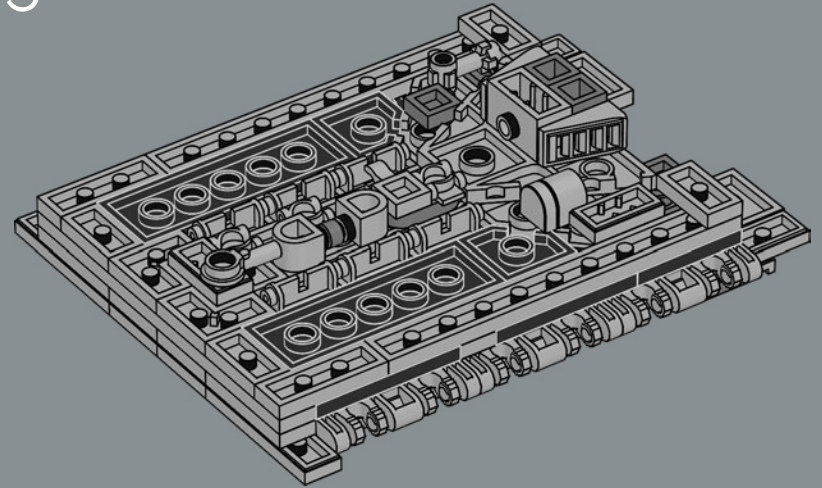

1x

334

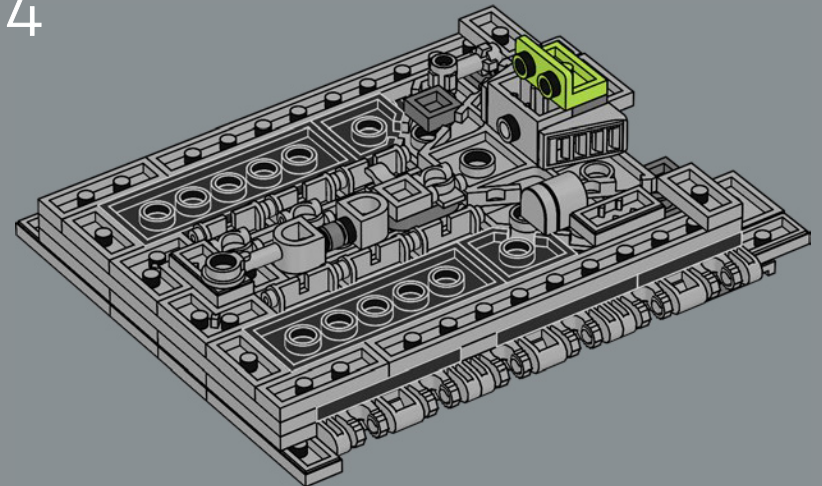



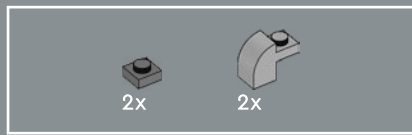

335

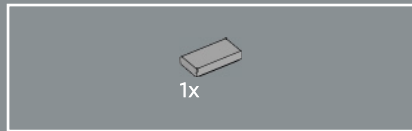
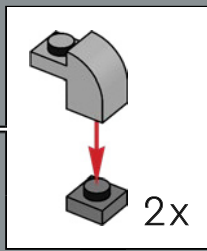
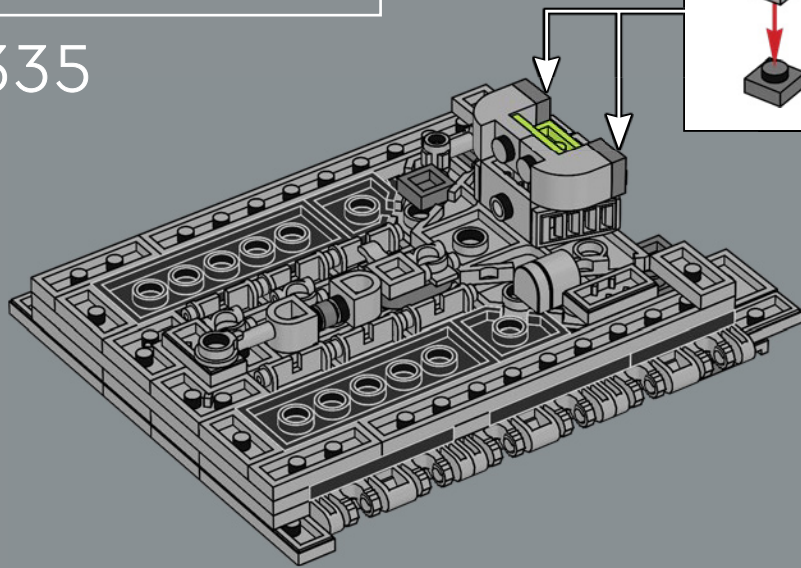

336

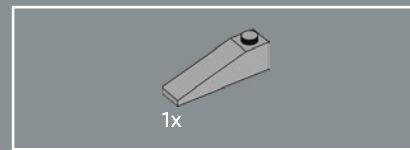
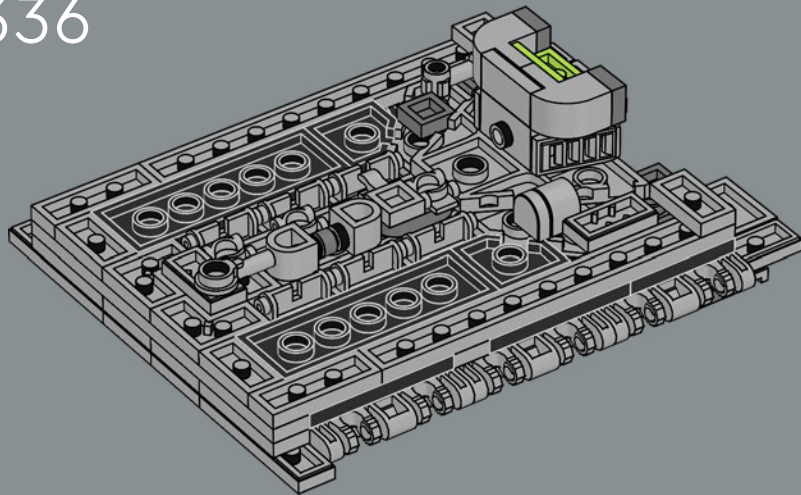

337

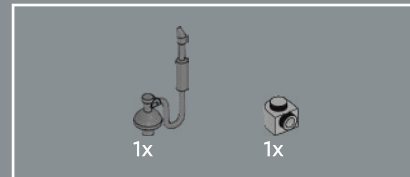
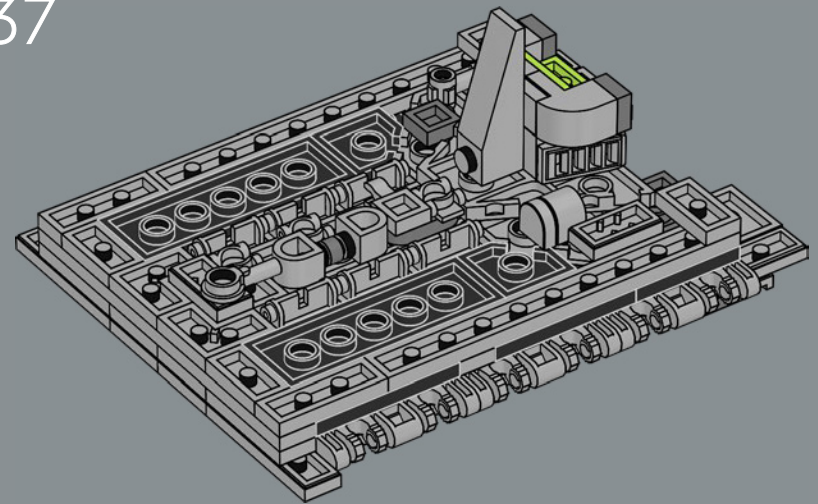

338

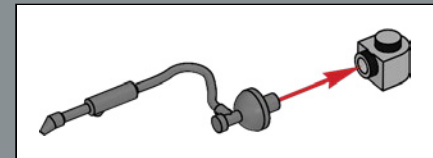
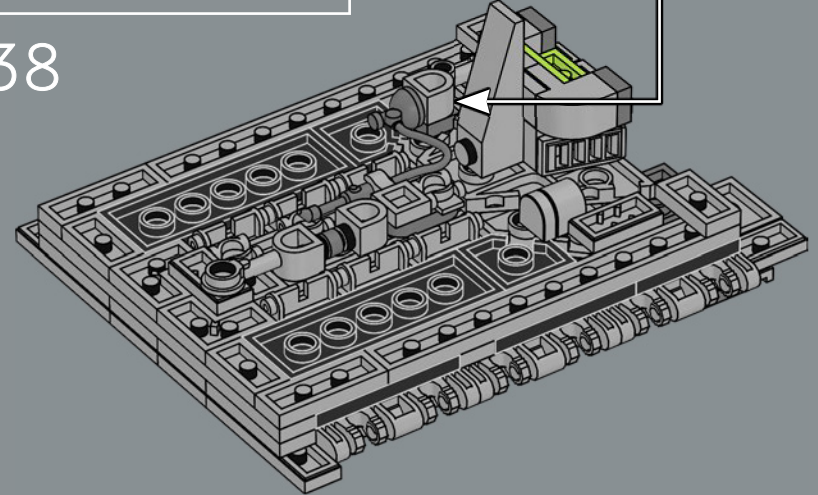

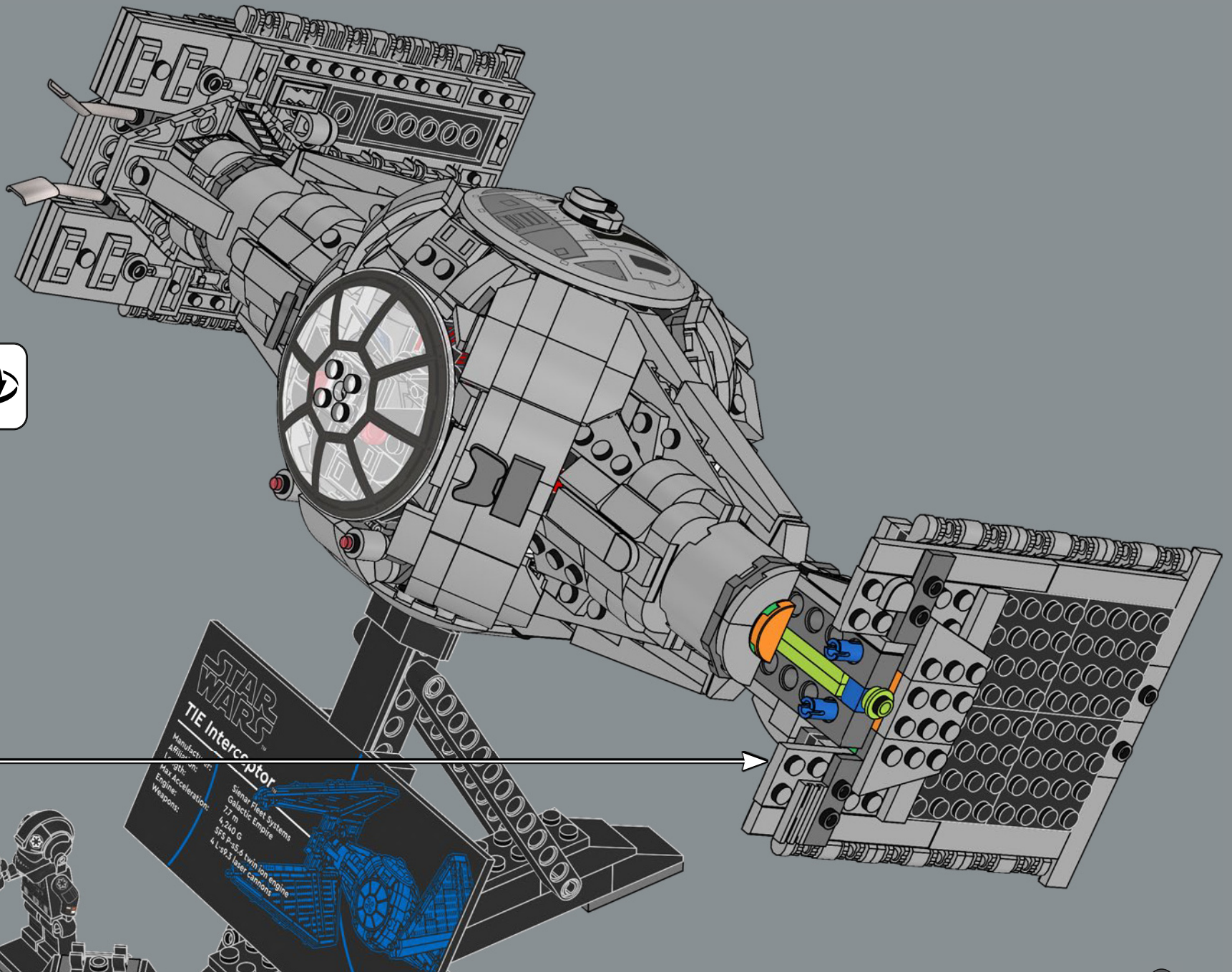

**STAR WARS**  
**TIE Interceptor**

Manufactured by: Sienar Fleet Systems  
Manufacturer: Galactic Empire  
Length: 7.7 m  
Engines: 4x P-30.6 twin ion engines  
Weapons: 4x L3P.3 laser cannons





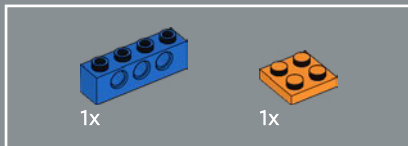
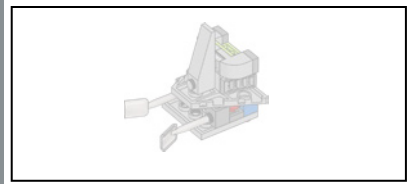

340

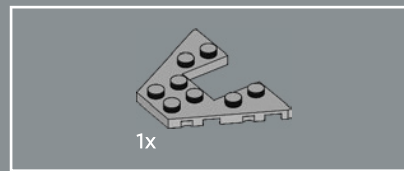
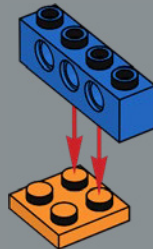

341

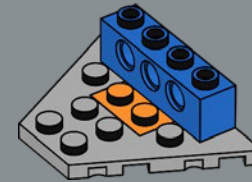

342

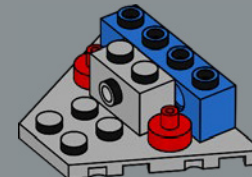

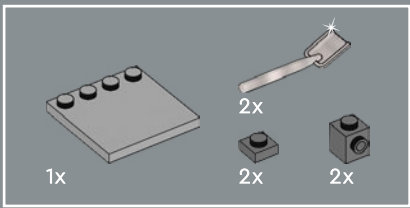

343

1

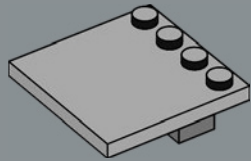

2

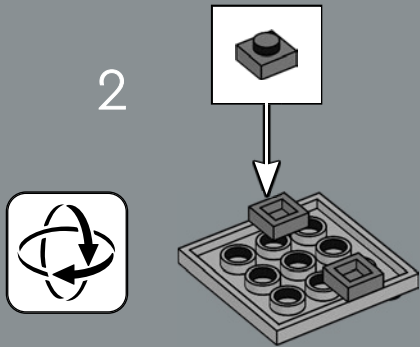

3

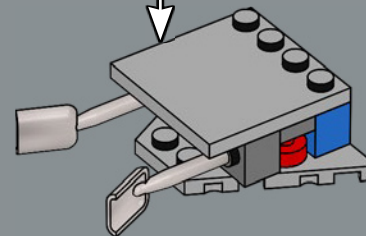
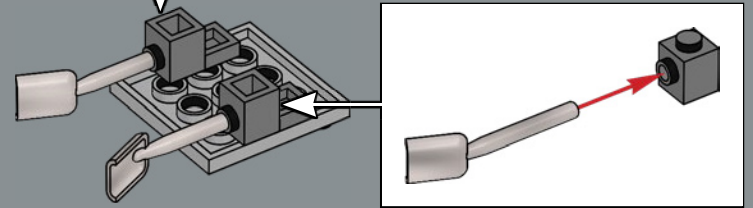
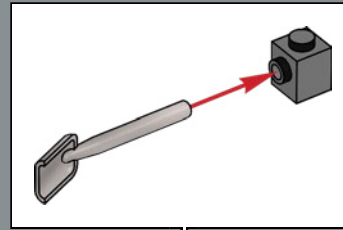





344

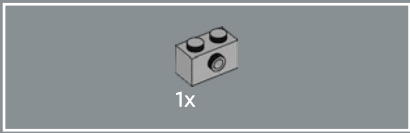
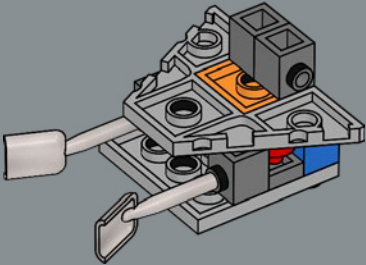

345

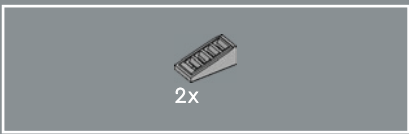
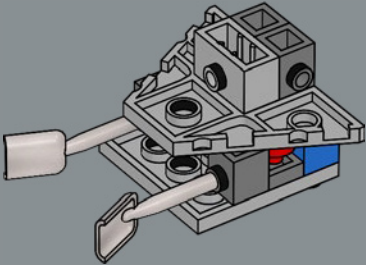

346

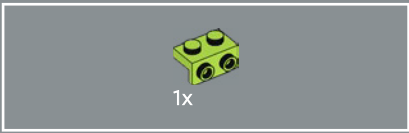
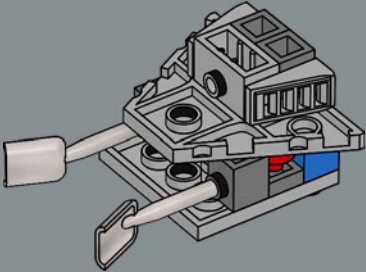

347

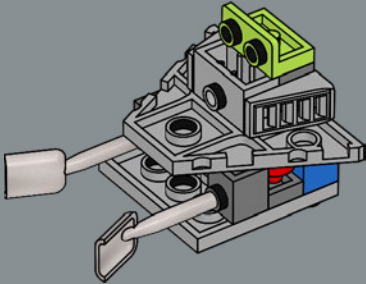

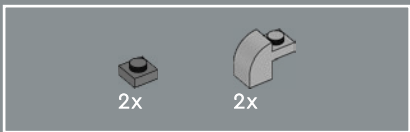

348

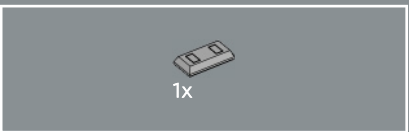
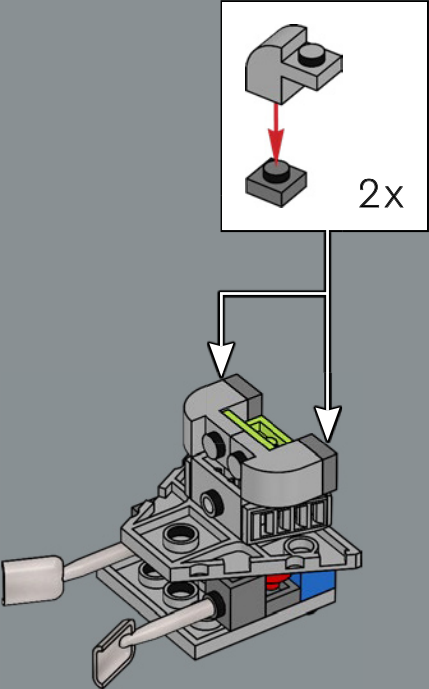

349

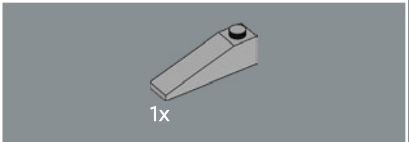
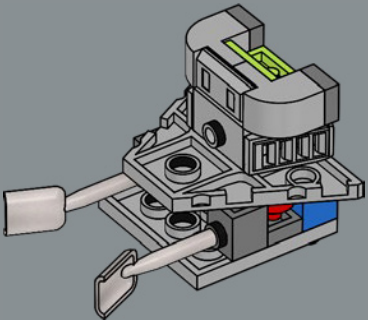

350

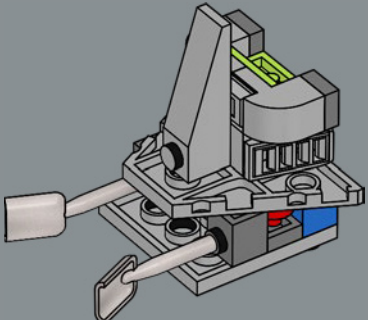

351

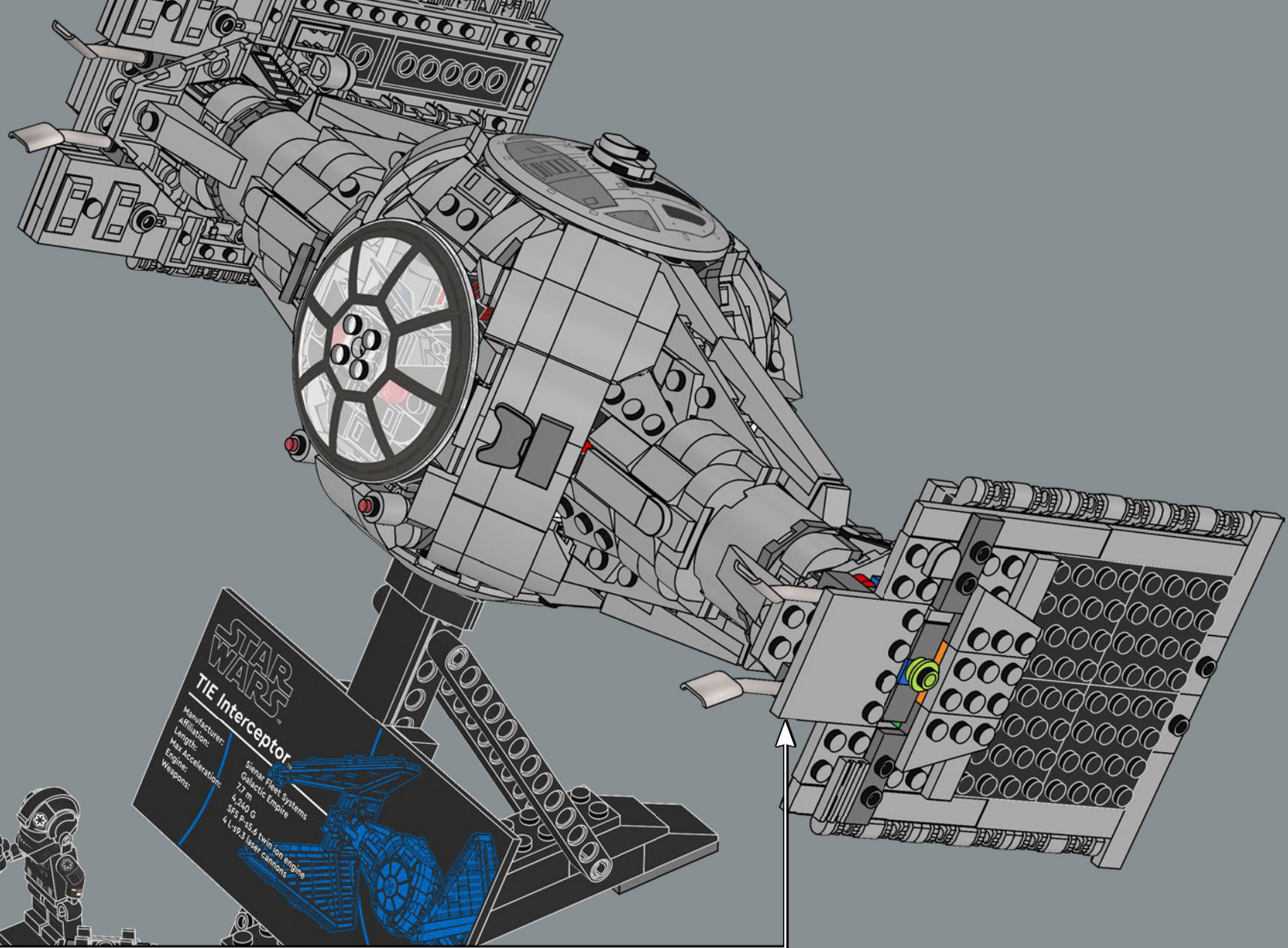

**STAR WARS**  
**TIE Interceptor**

Manufacturer: Sienar Fleet Systems  
Affiliation: Galactic Empire  
Length: 7.7 m  
Max Acceleration: 4,240 G  
Engine: SFS ps-5,4 twin ion engine  
Weapons: 4 LSP-3 laser cannons

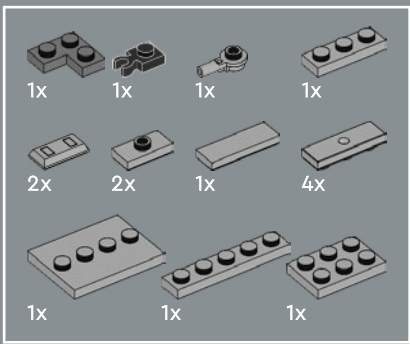

# 352

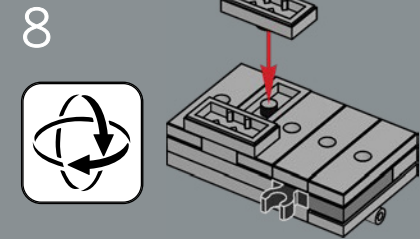
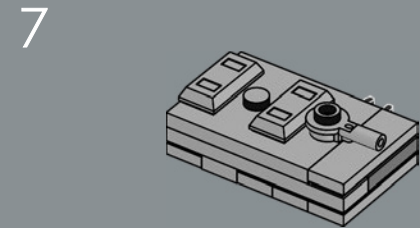
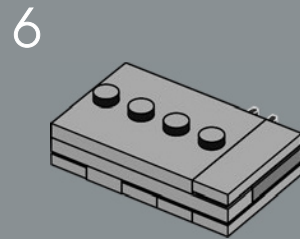
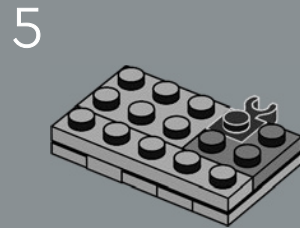
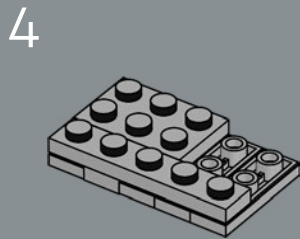
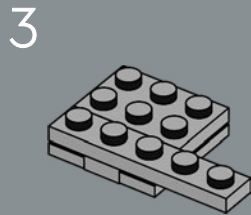
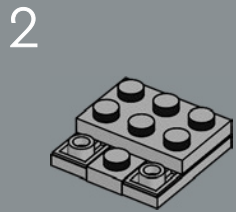
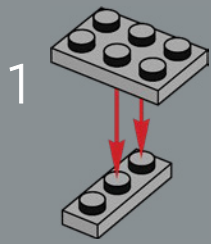



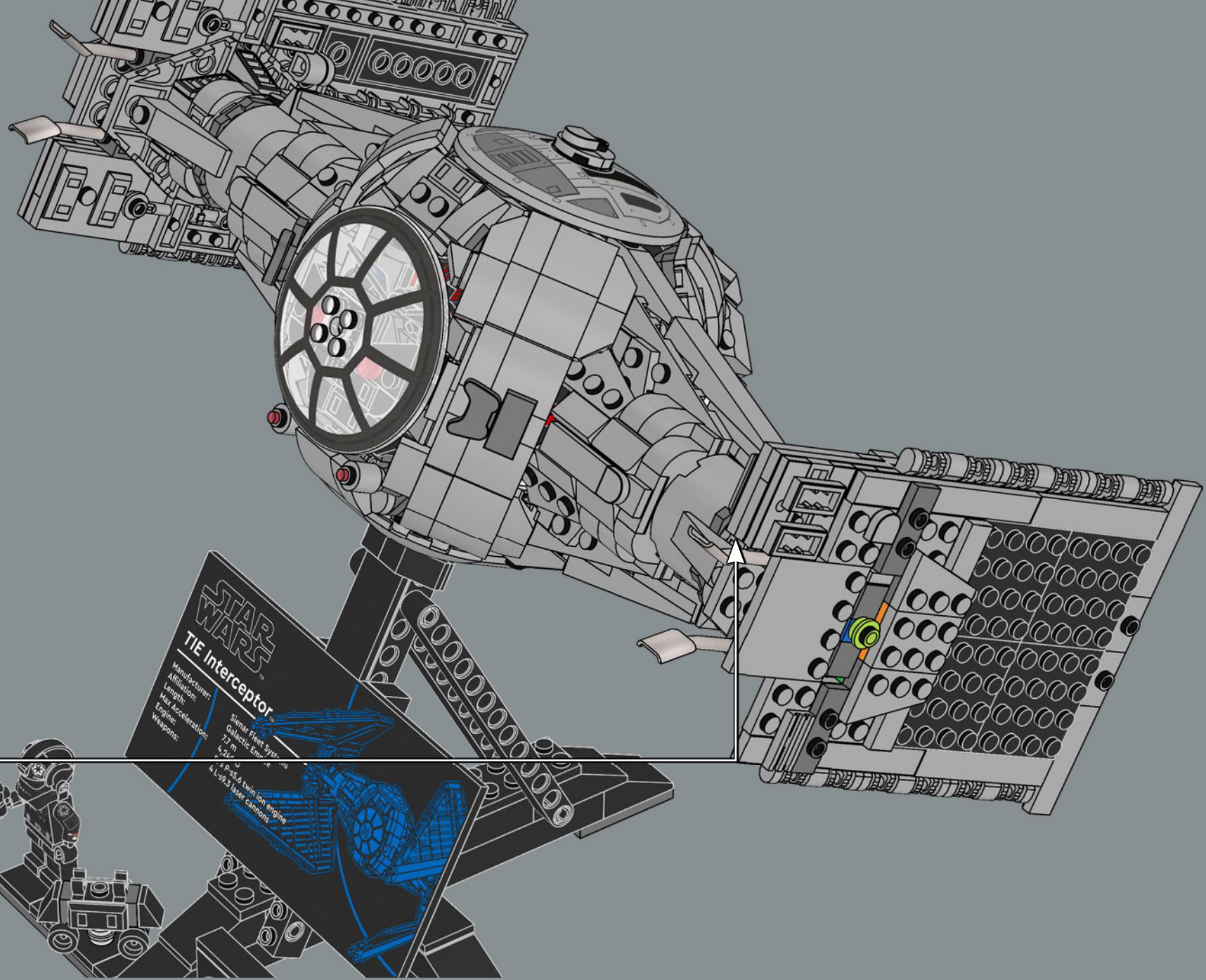

**STAR WARS**  
**TIE Interceptor**

Manufacturer:	Sienar Fleet Systems
Affiliation:	Galactic Empire
Length:	7.7 m
Max Acceleration:	4.2G
Engines:	2 P-25.5 twin ion engines
Weapons:	4 L-19.3 laser cannons

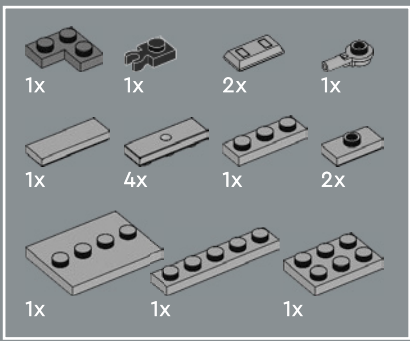

# 353

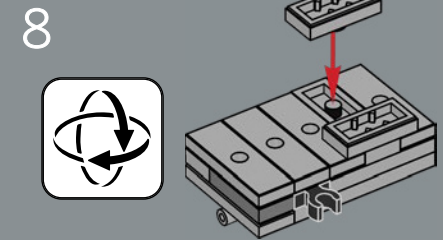
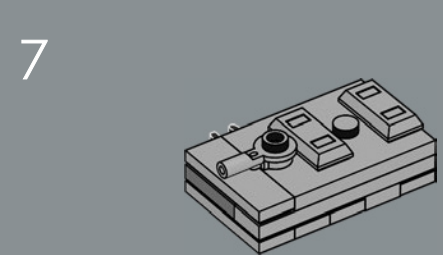
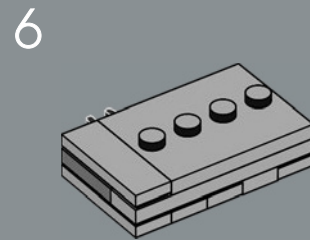
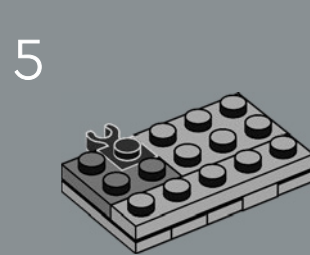
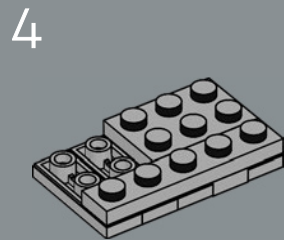
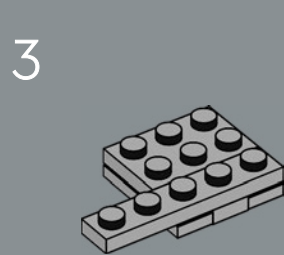
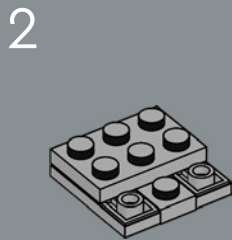
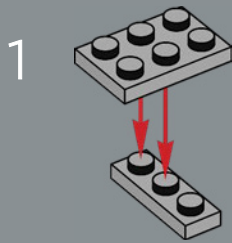



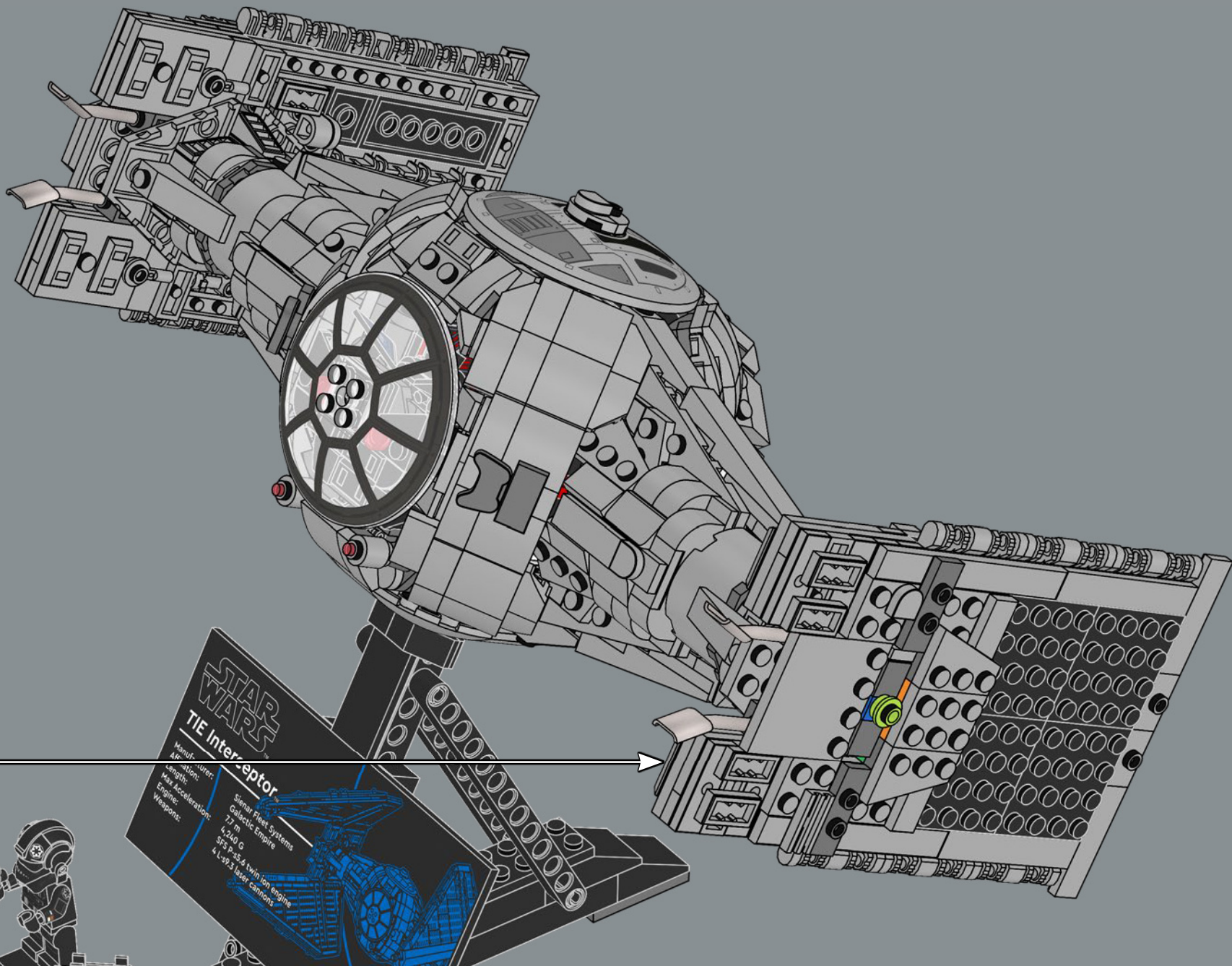

**STAR WARS**  
**TIE Interceptor™**

Manuf.: Sienar  
Alt.: Interceptor  
Length: 77 ft  
Max Acceleration: 4,240 G  
Engine: SFS P-5.4 Twin Ion engine  
Weapons: 4 L-29.3 laser cannons

Sienar Fleet Systems  
Galactic Empire  
4,240 G  
SFS P-5.4  
4 L-29.3 laser cannons

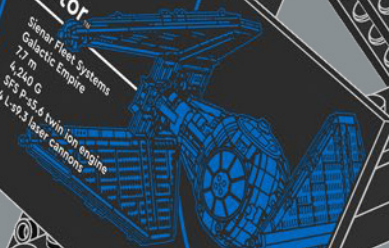

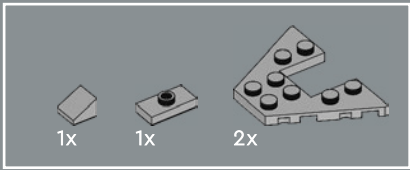

354

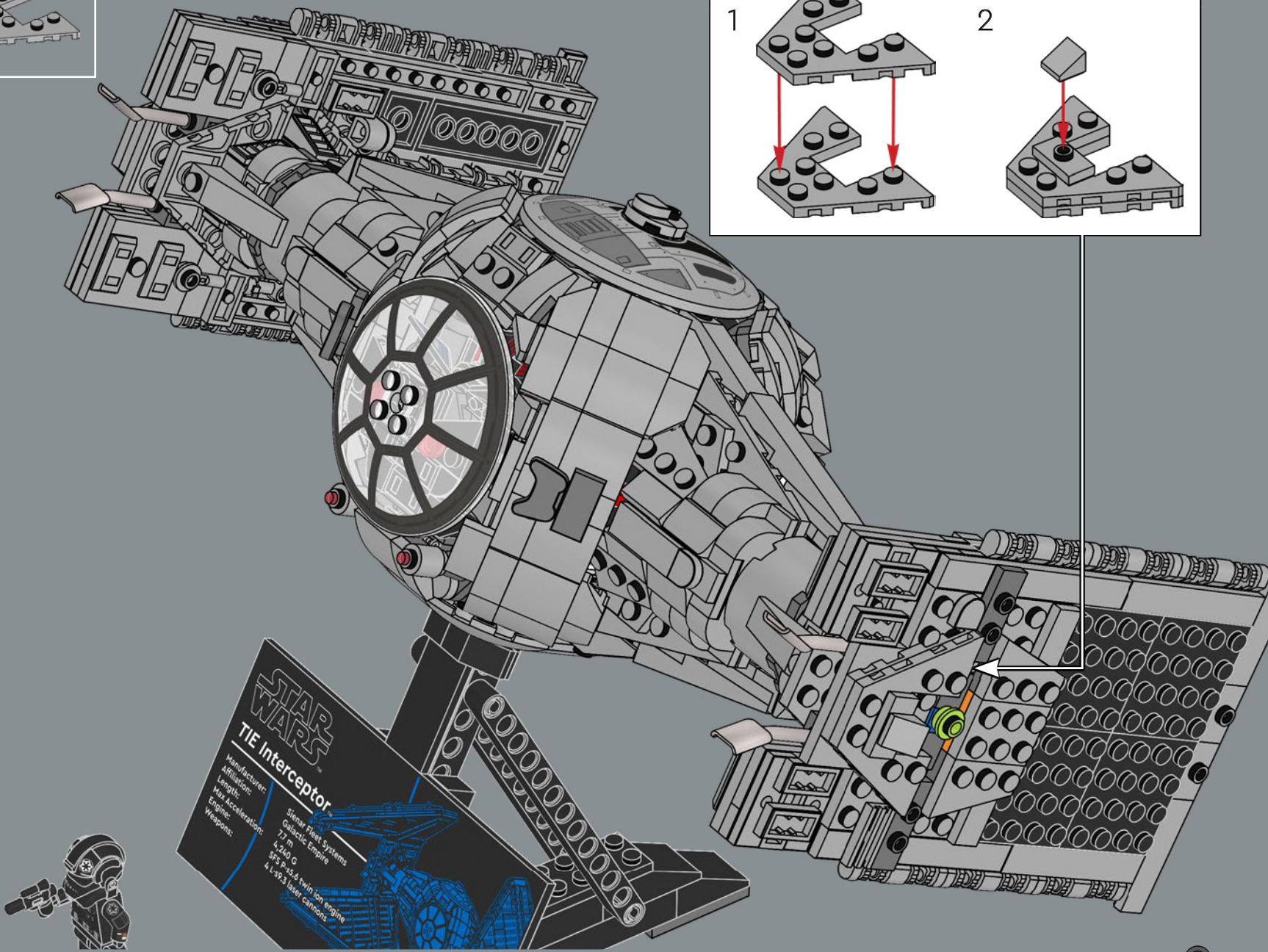
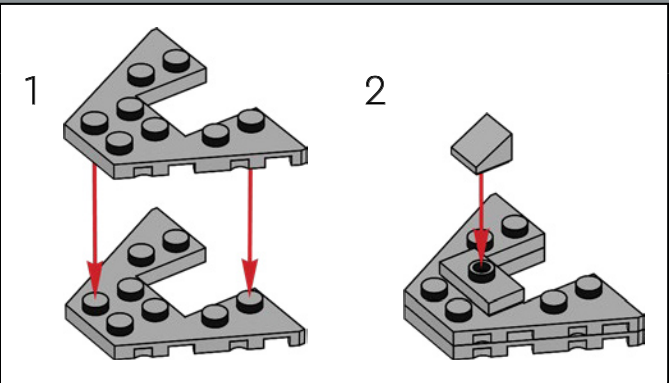

**STAR WARS™**  
**TIE Interceptor™**

Manufacturer:	Sienar Fleet Systems
Affiliation:	Galactic Empire
Length:	7.7 m
Max Acceleration:	4,240 G
Engine:	SP5 P-25.4 twin ion engine
Weapons:	4 L-9.3 laser cannons



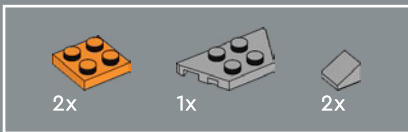

355

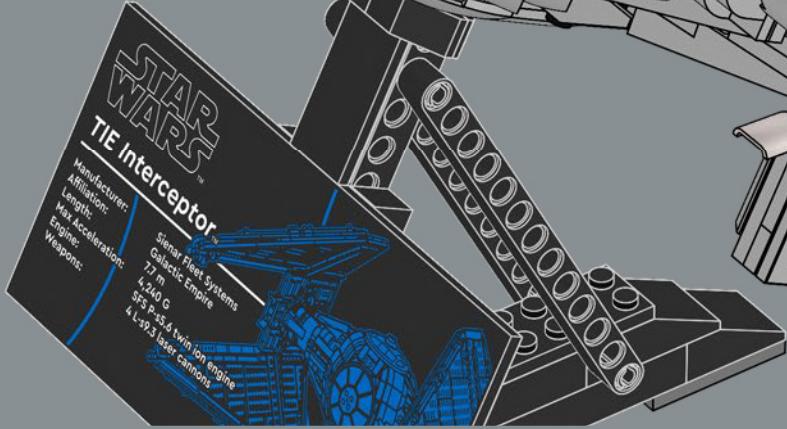
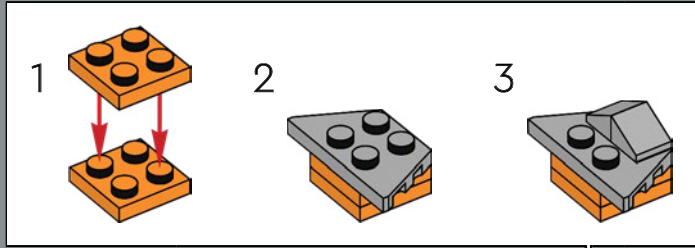
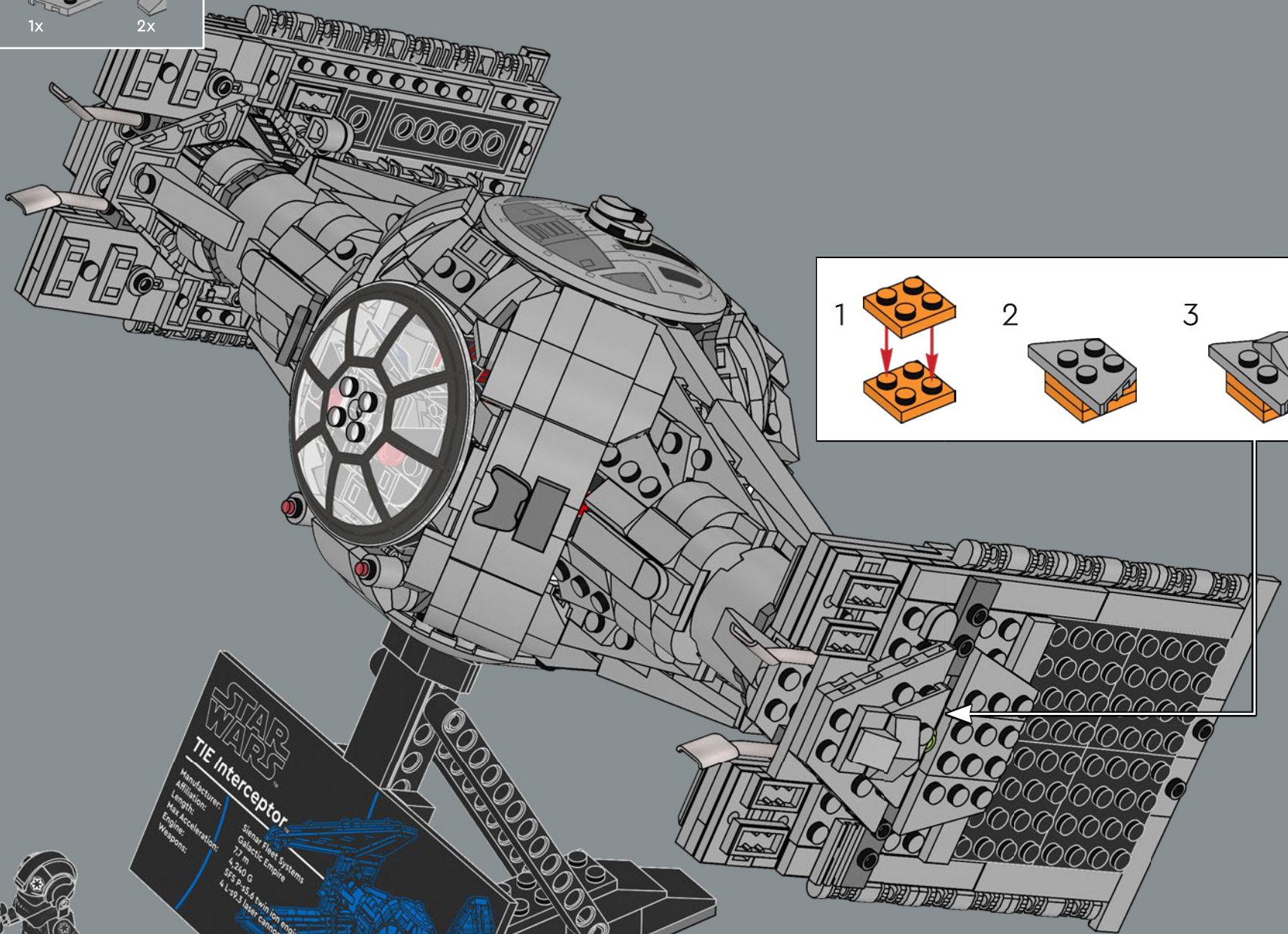

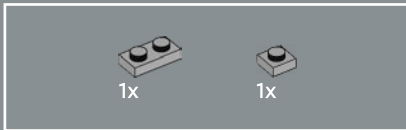
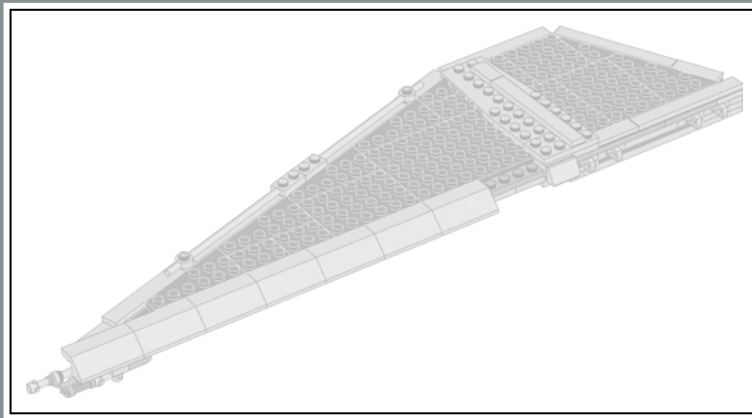

356

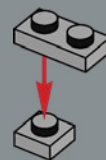

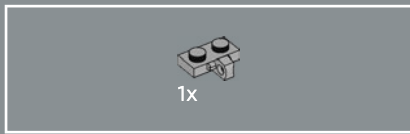

357

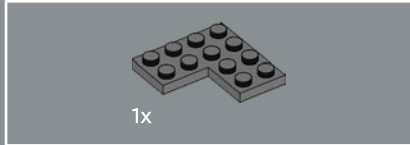
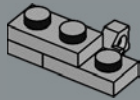

358

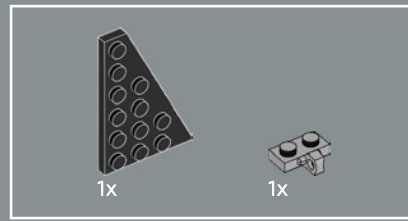
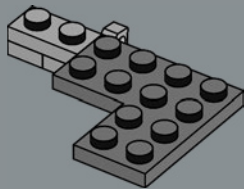

359

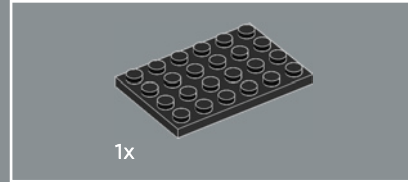
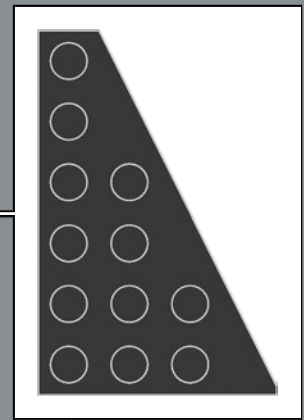
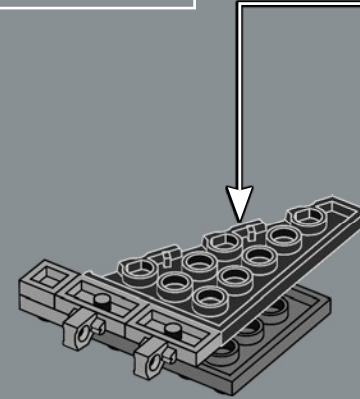
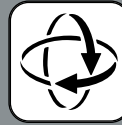

360

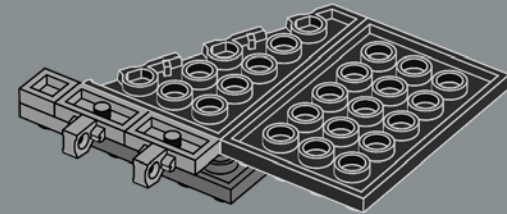

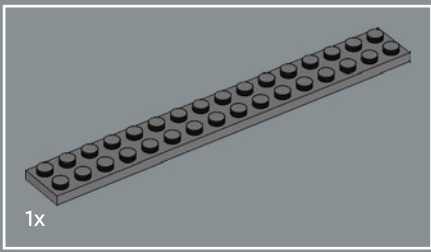

361

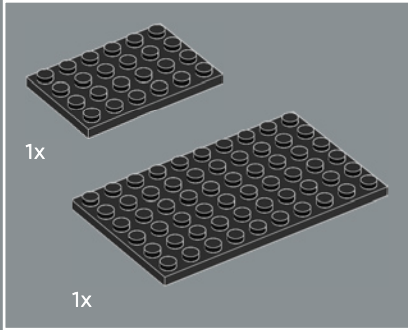
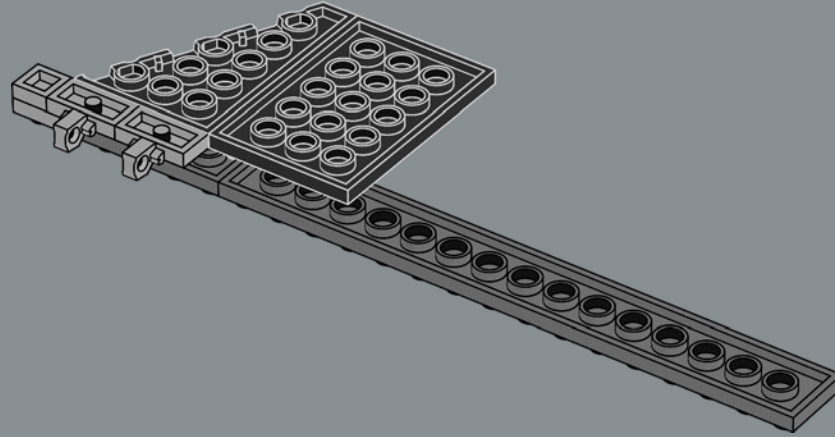

362

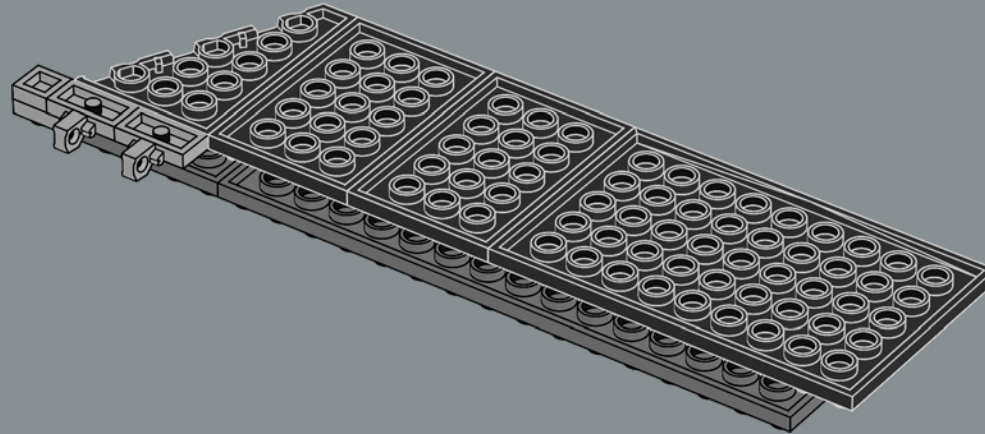



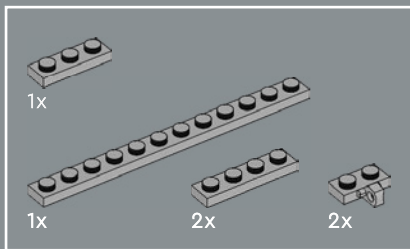

363

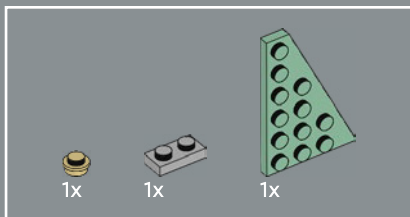
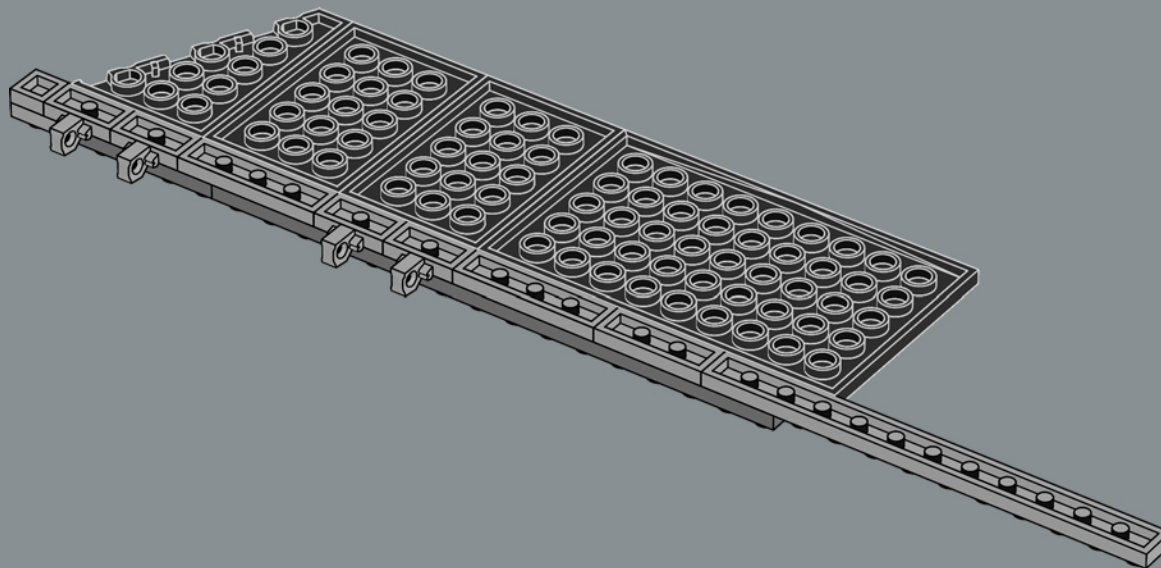

364

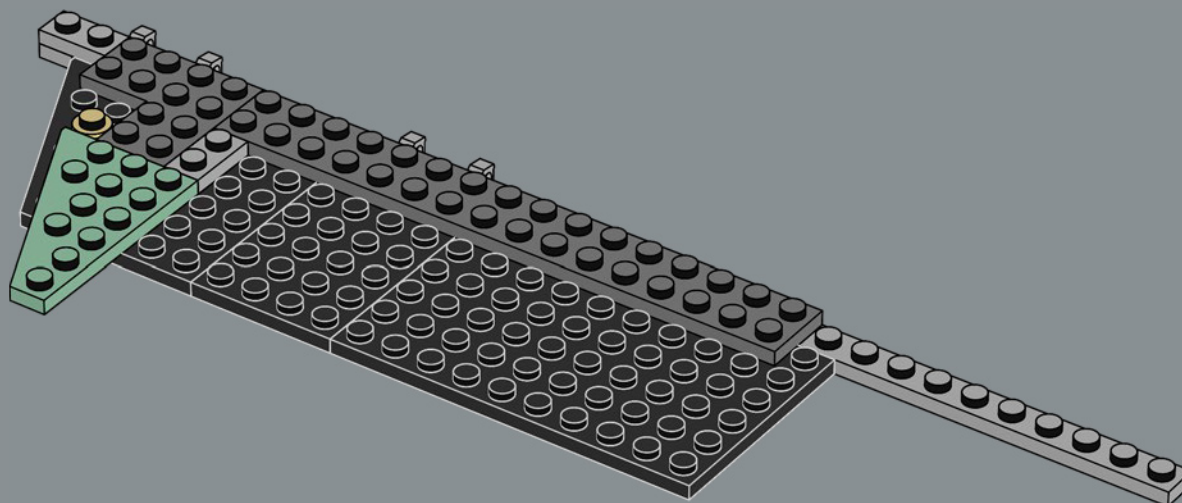

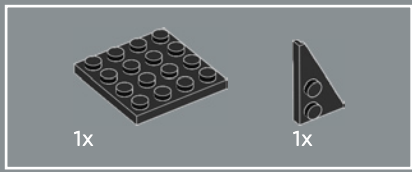

365

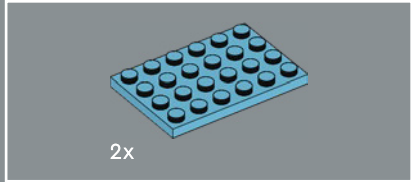
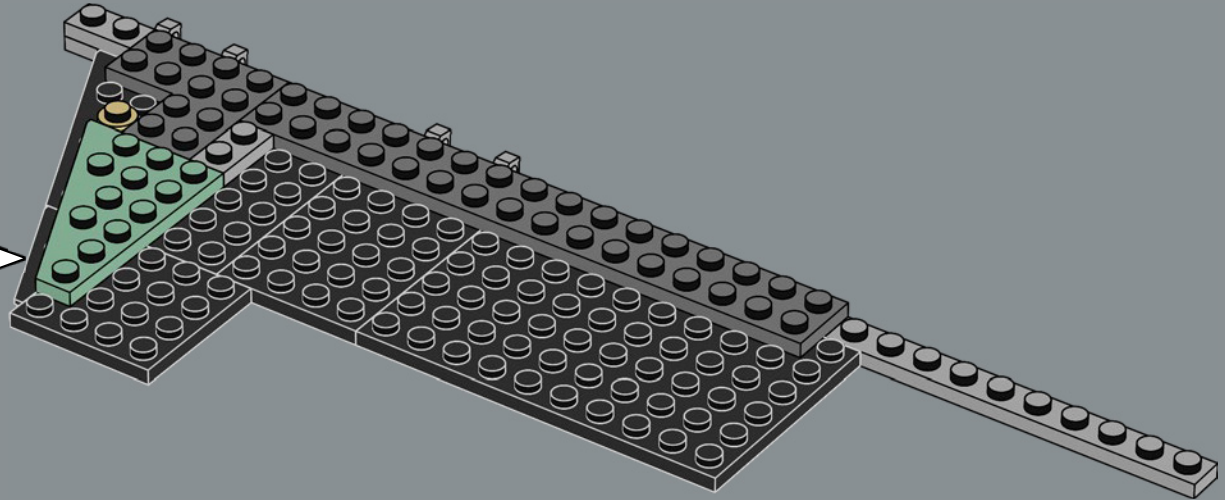
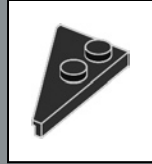

366

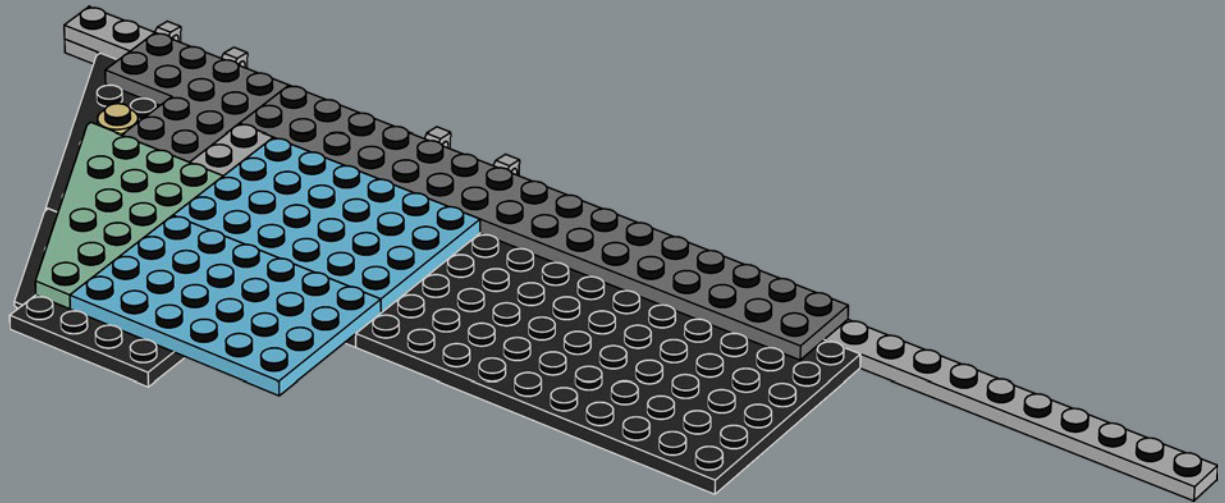

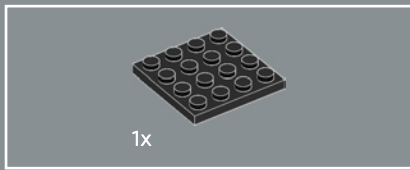

367

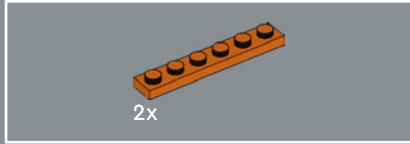
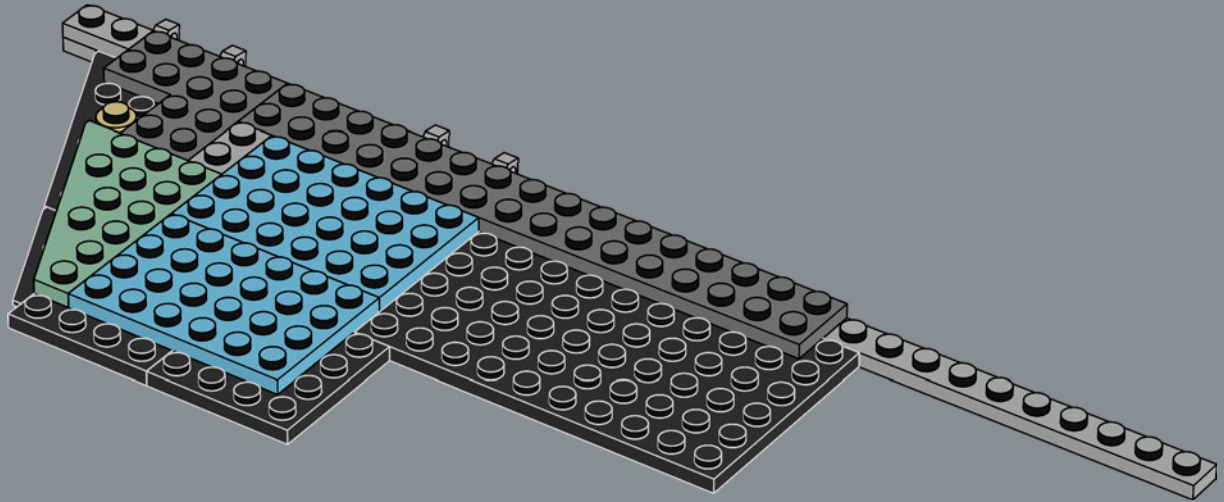

368

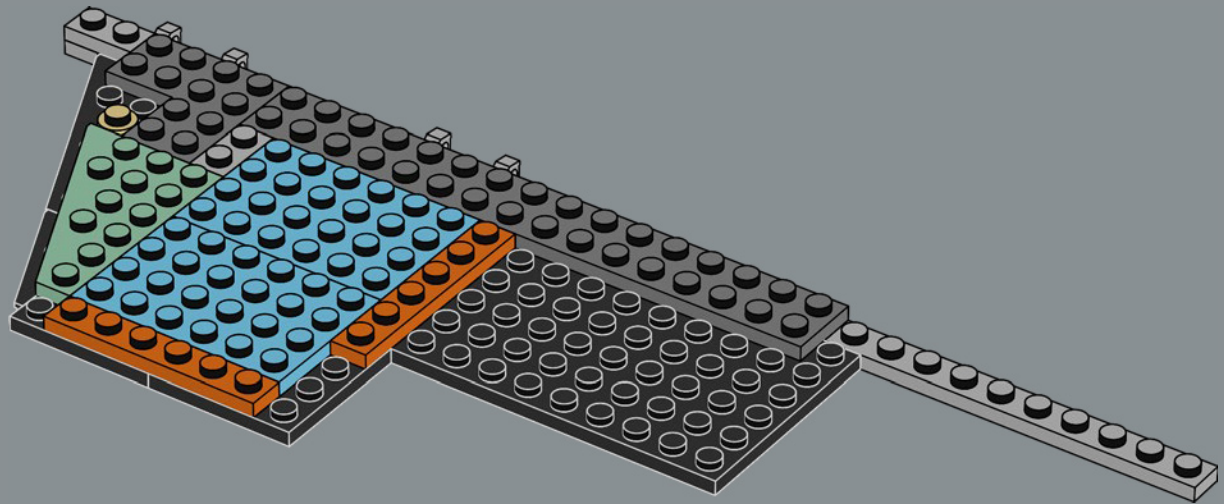

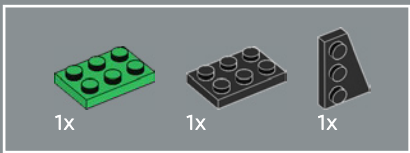

369

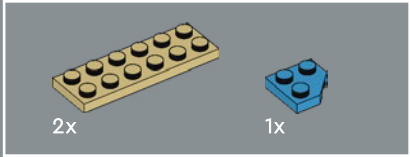
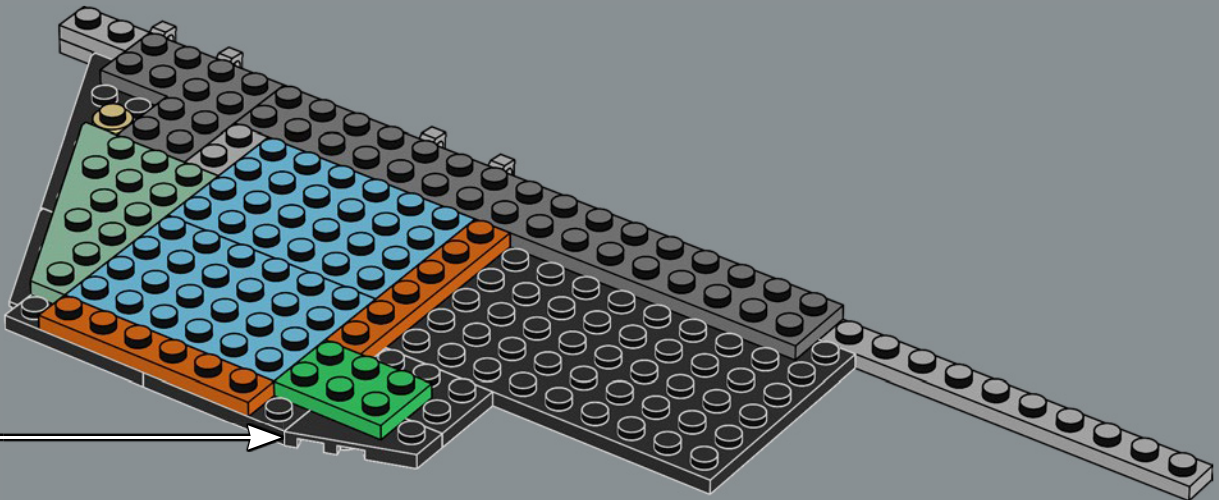
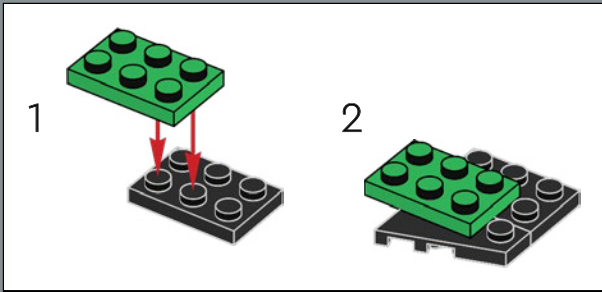

370





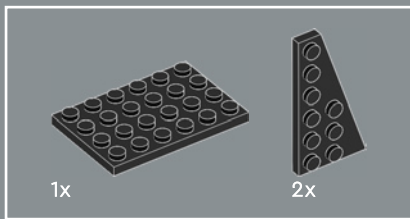

371

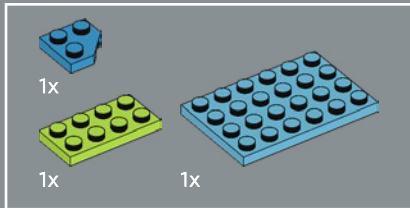
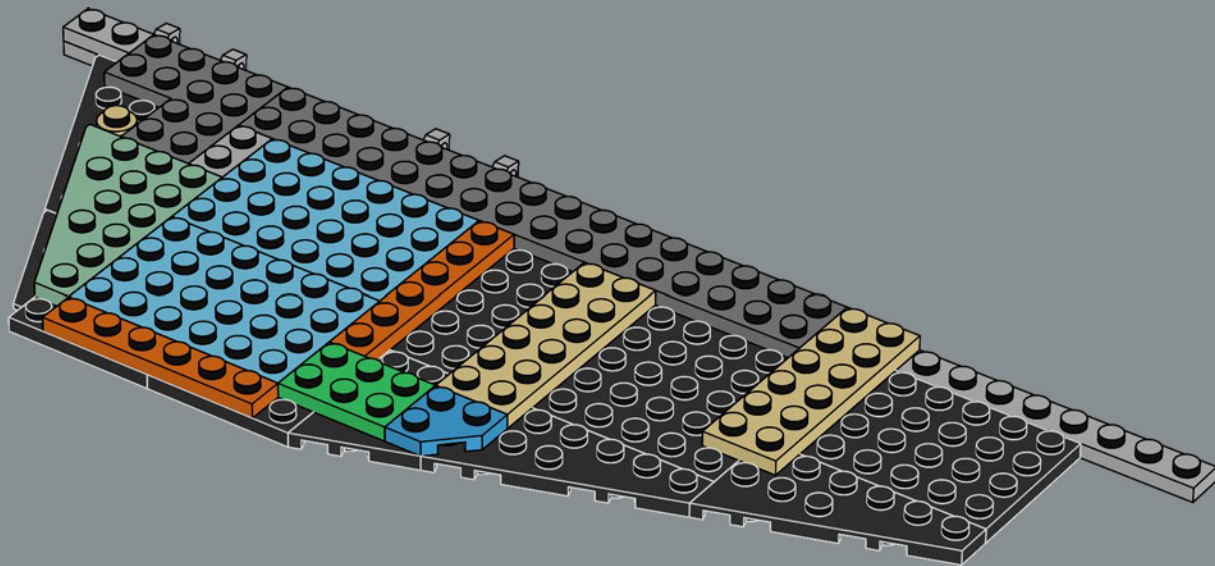

372

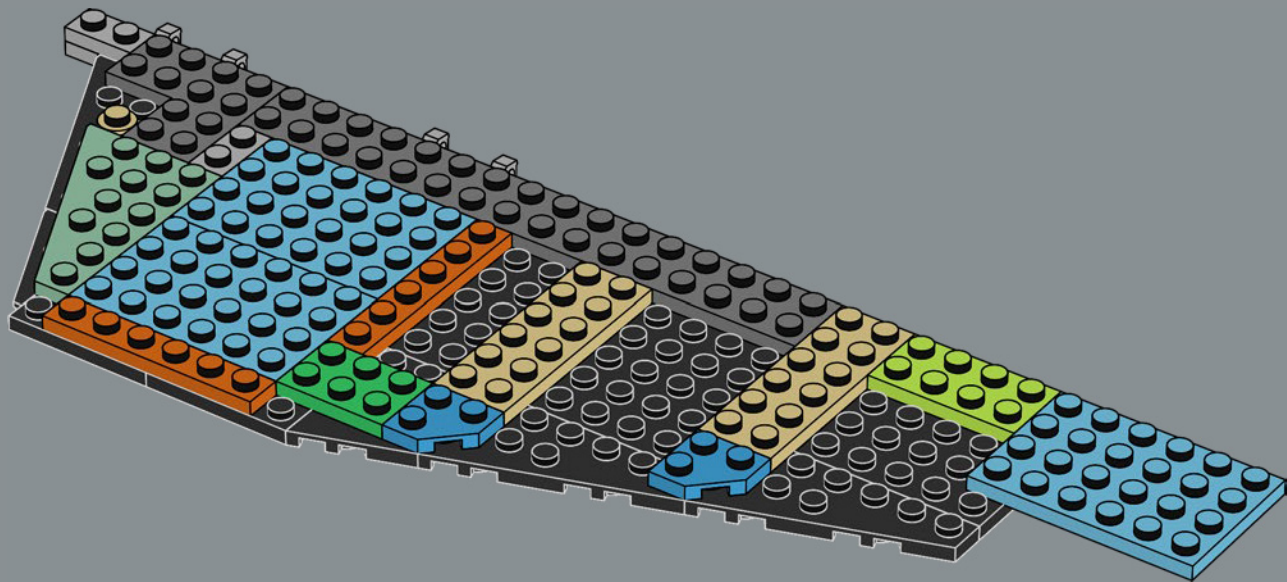

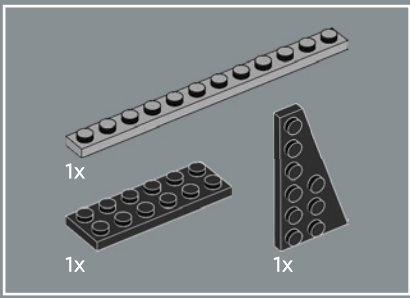

373

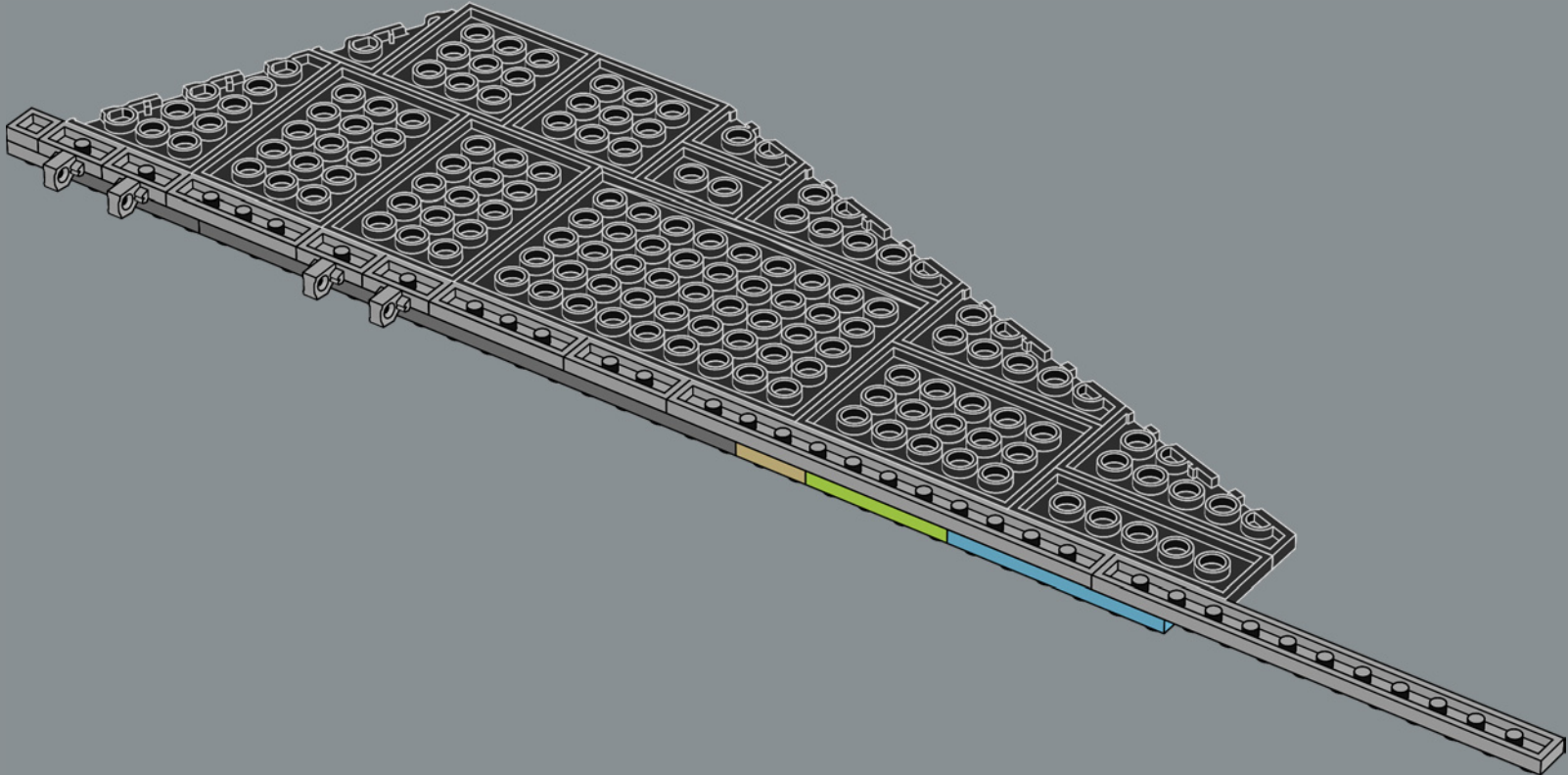

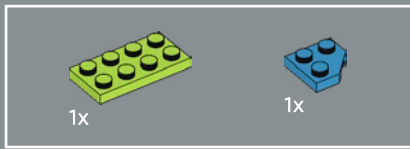

374

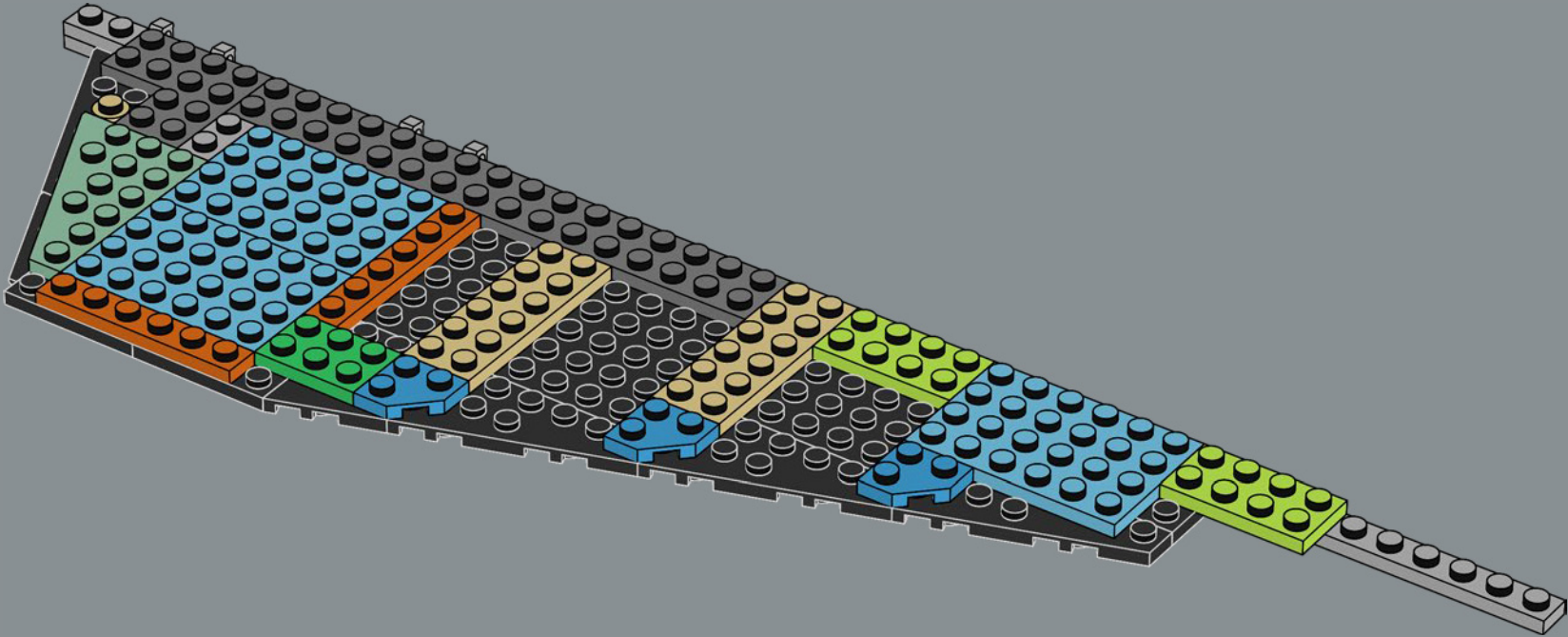

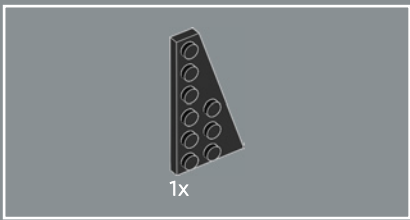

375

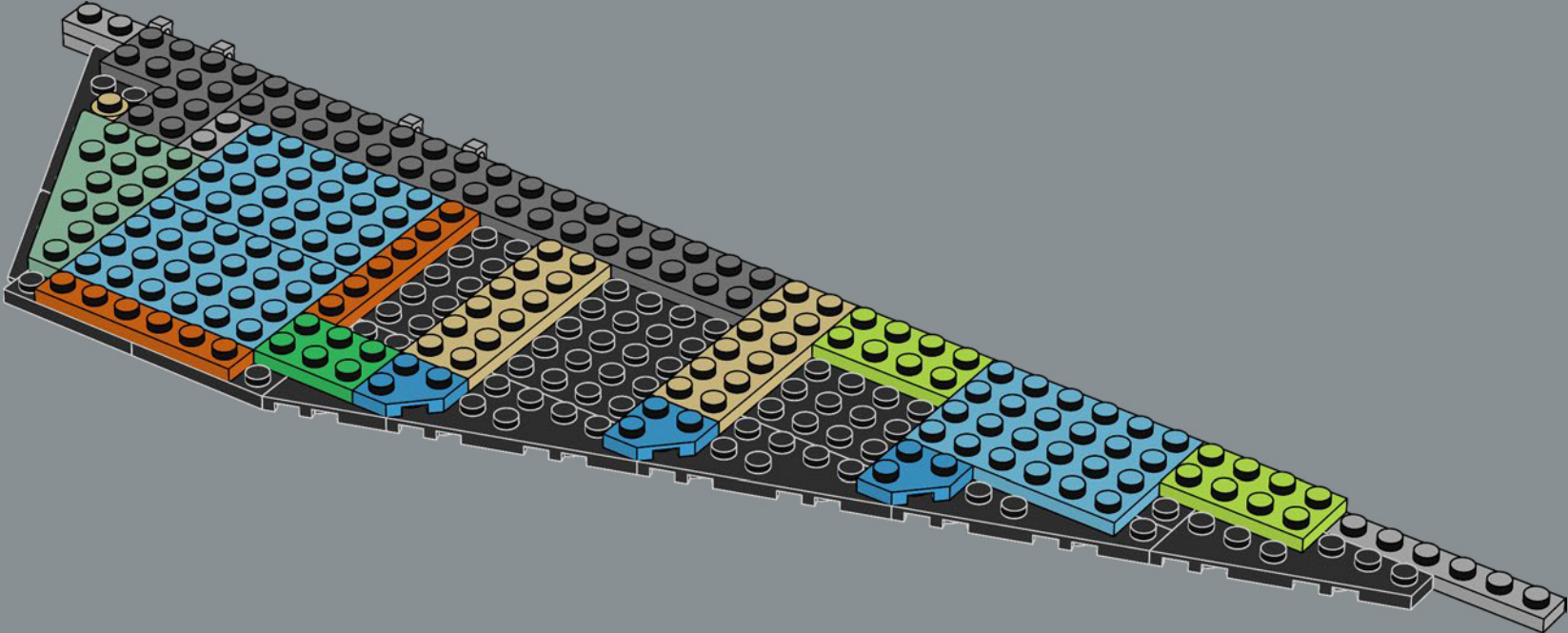



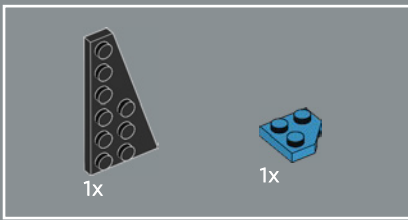

376

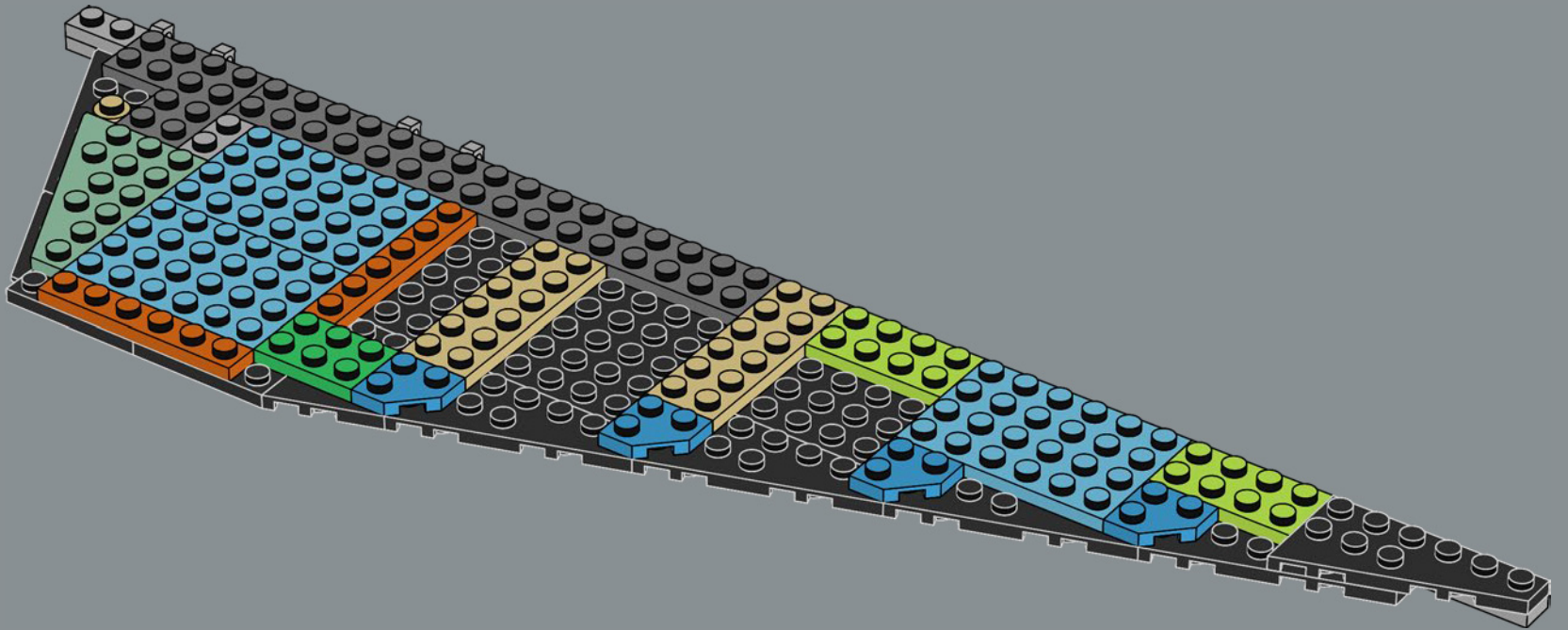

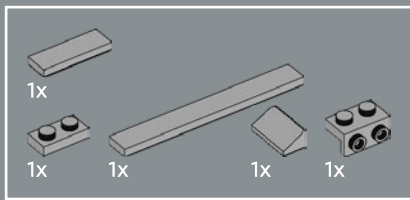

377

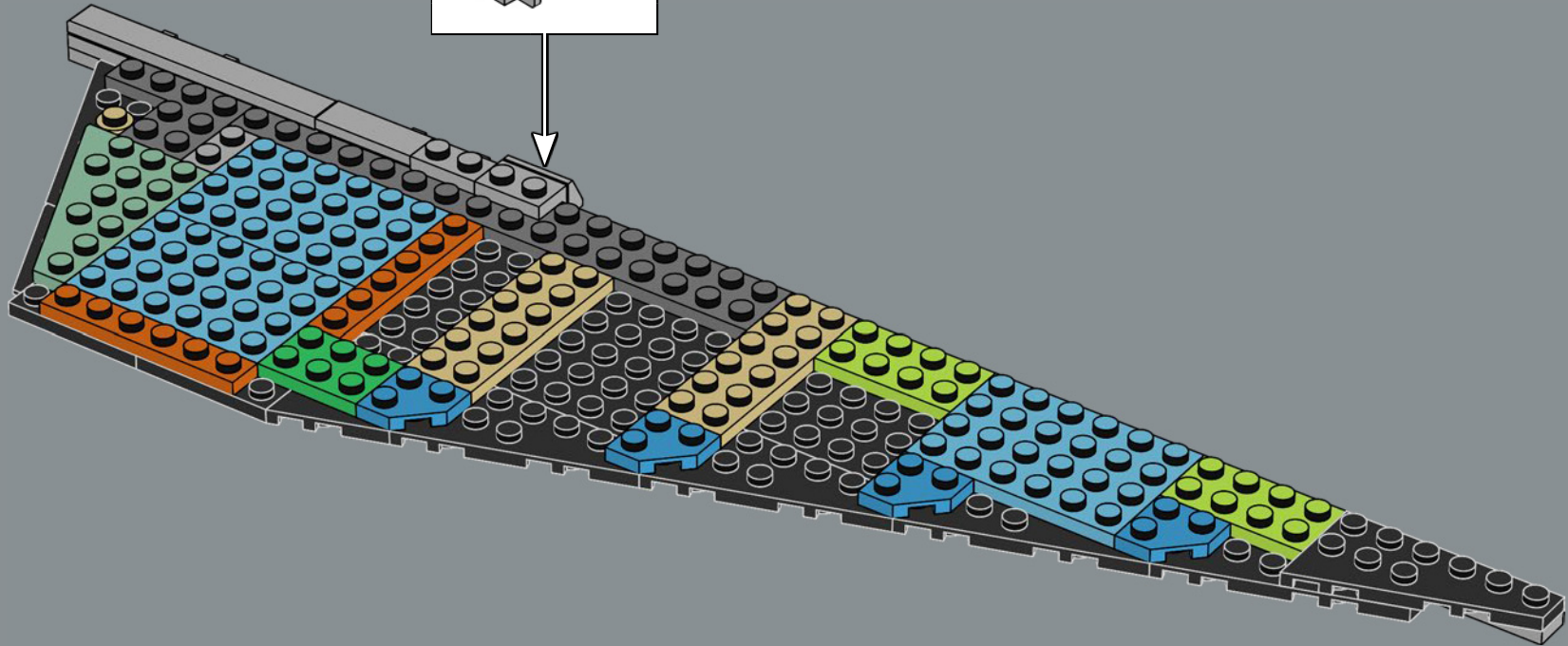
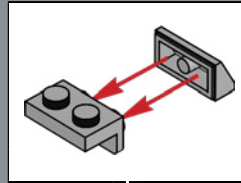

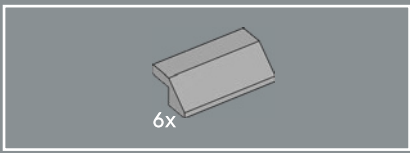

378

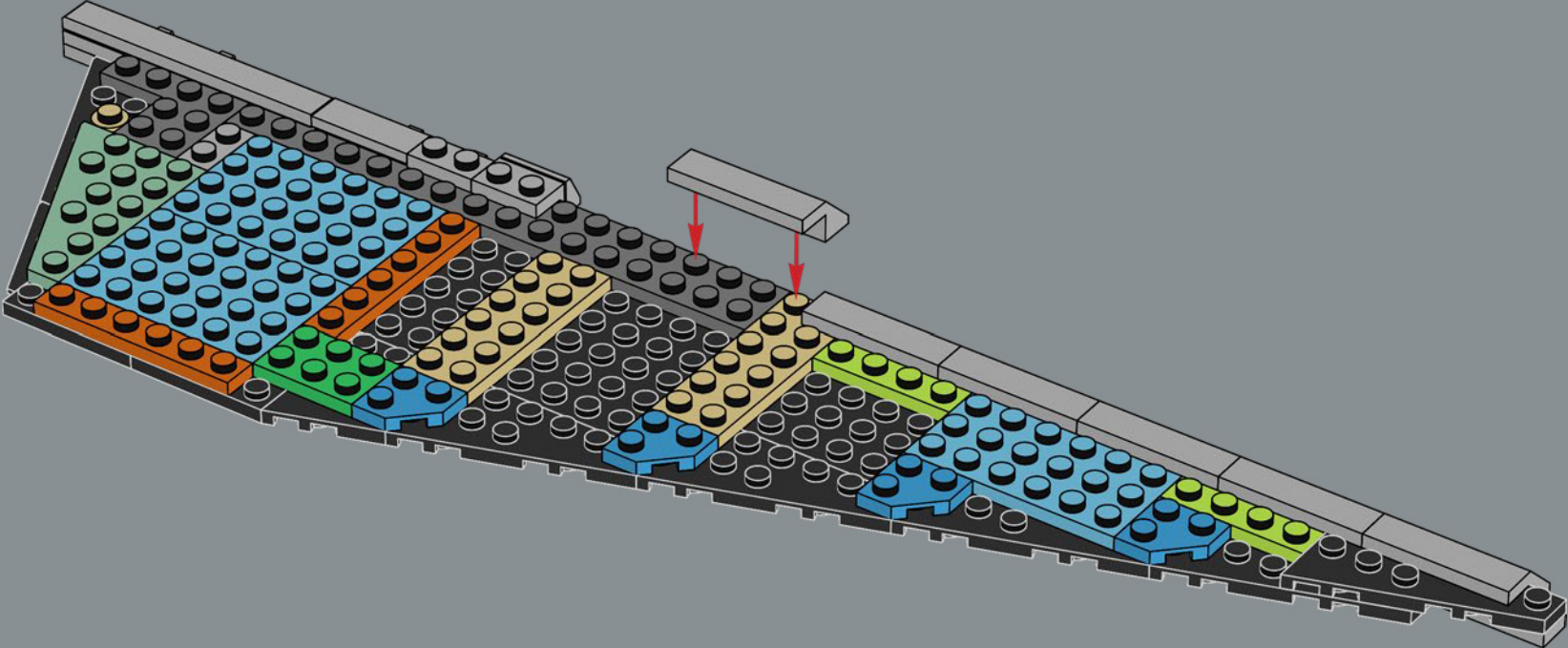

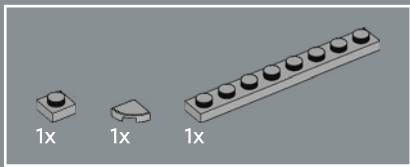

379

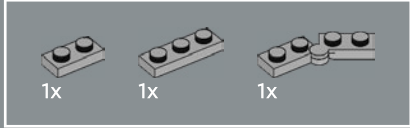
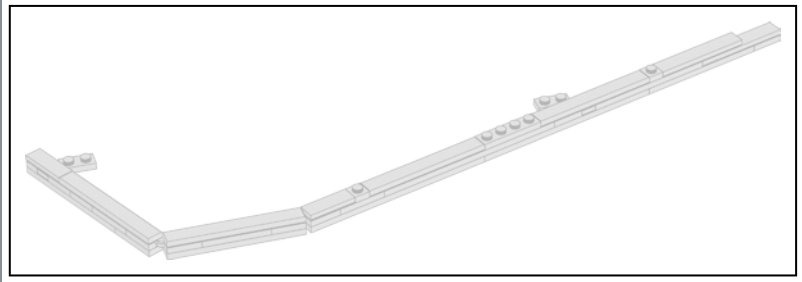
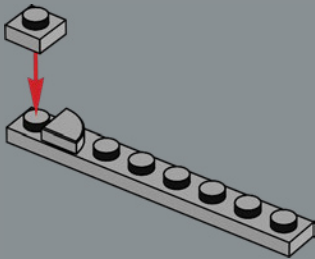

380

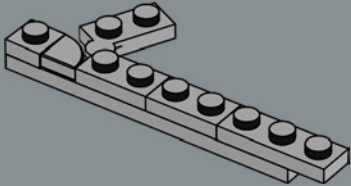



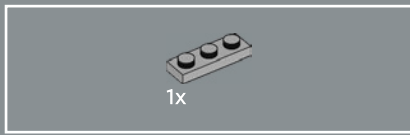

381

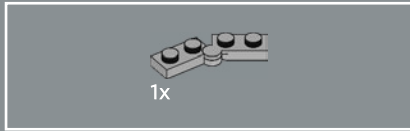
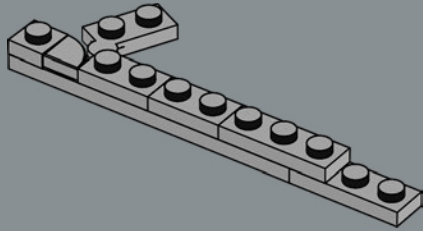

382

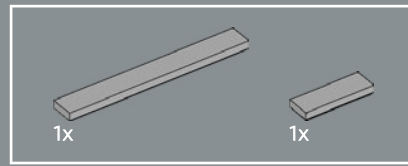
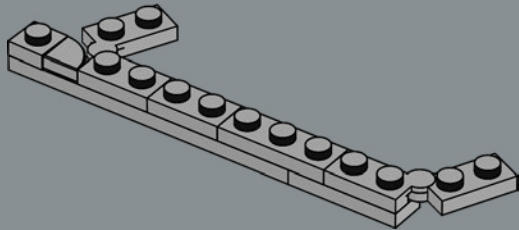

383

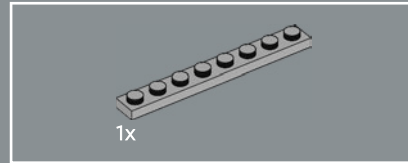
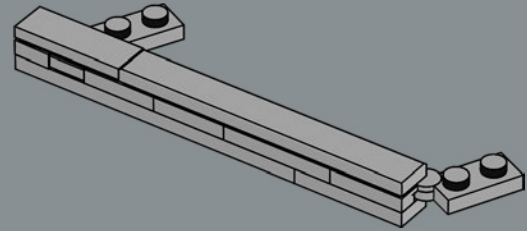

384

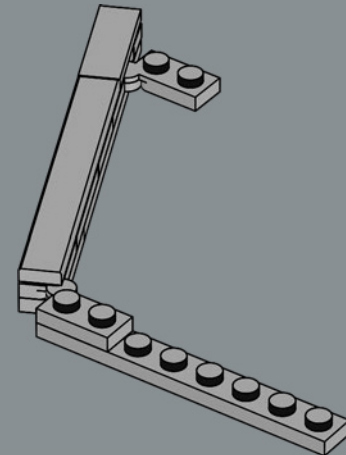

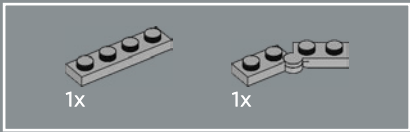

385

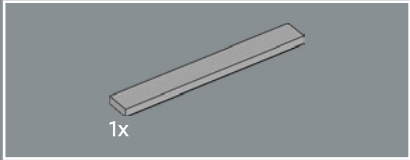
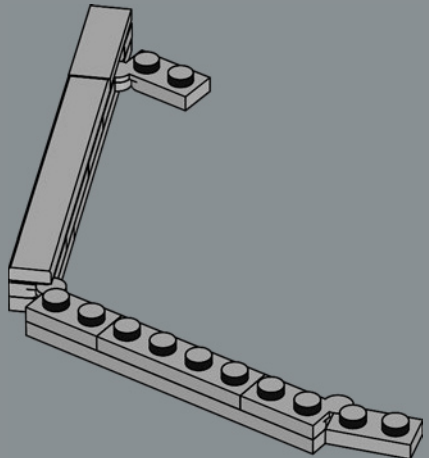

386

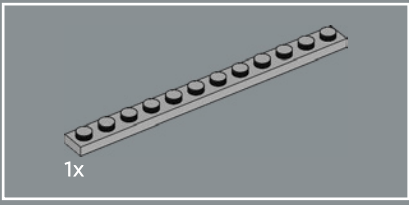
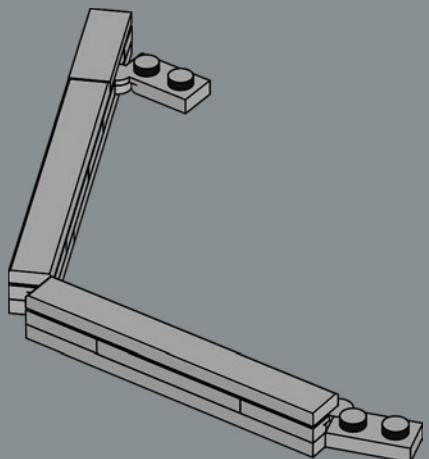

387

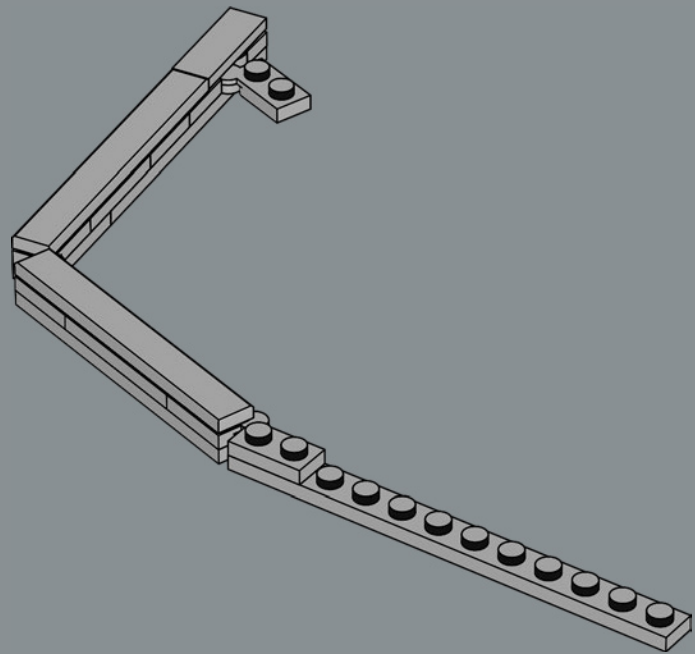

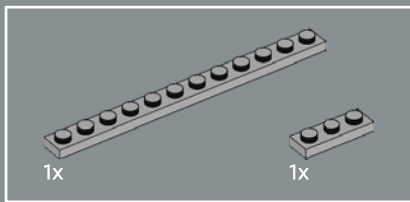

388

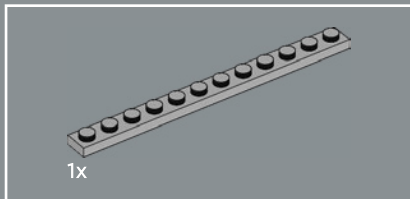
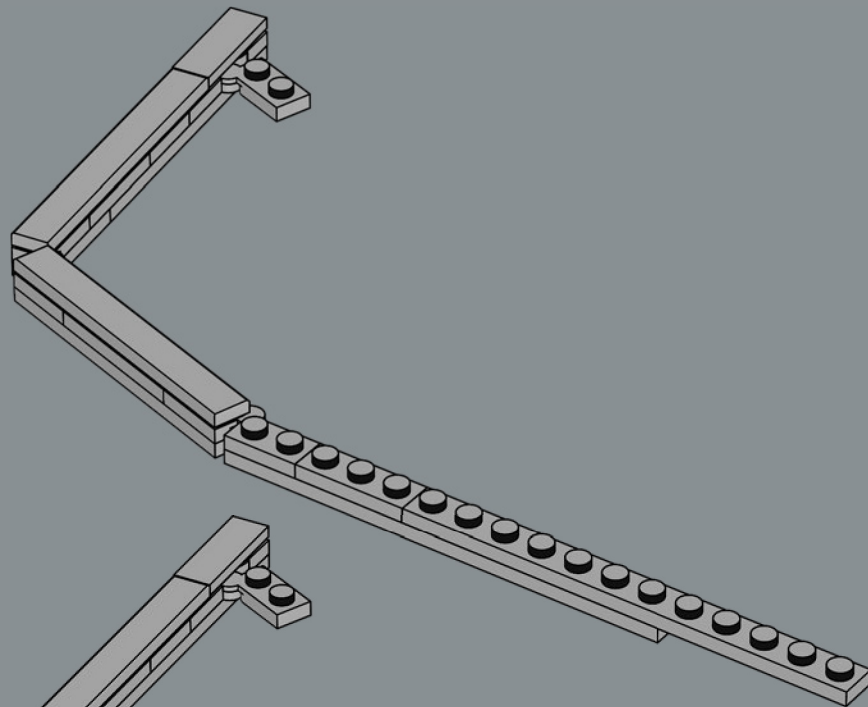

389

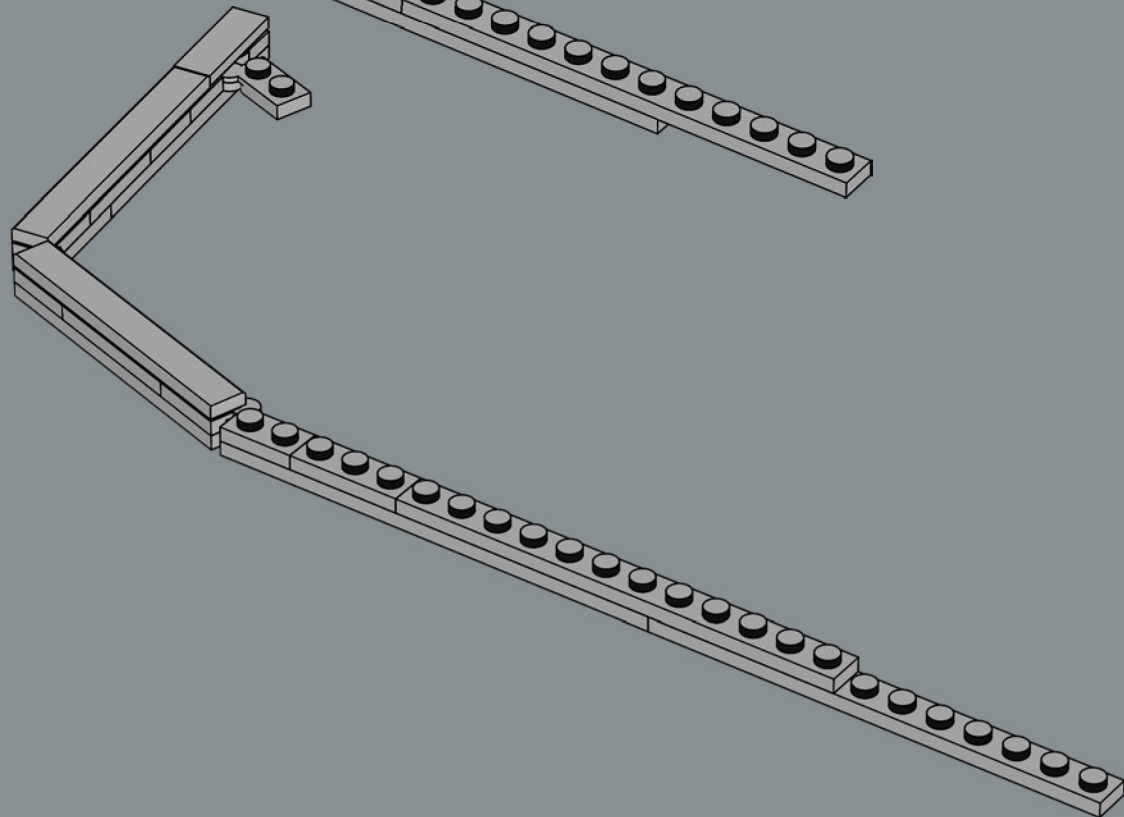

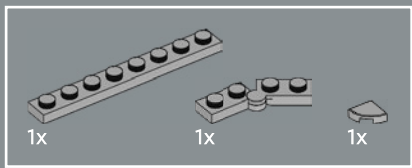

390

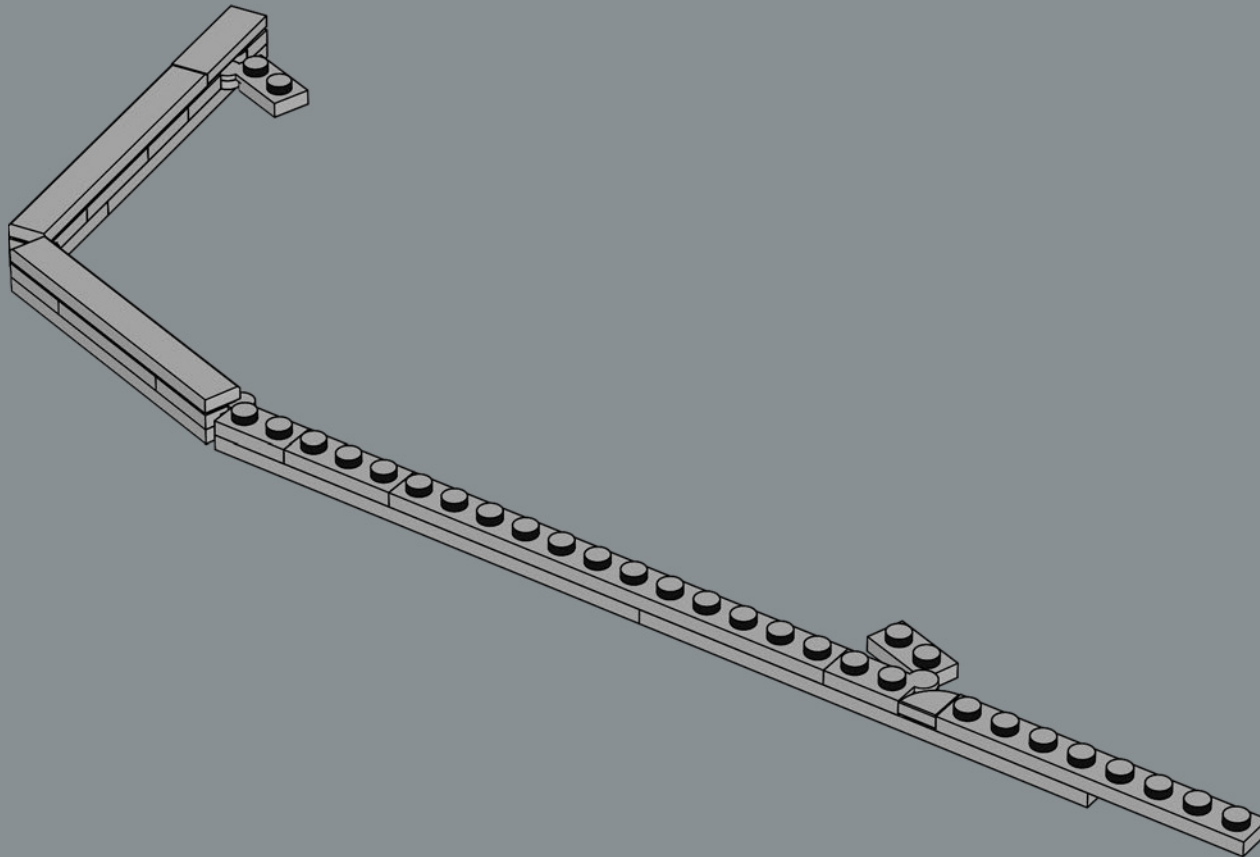



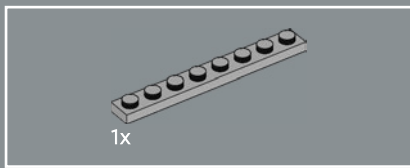

391

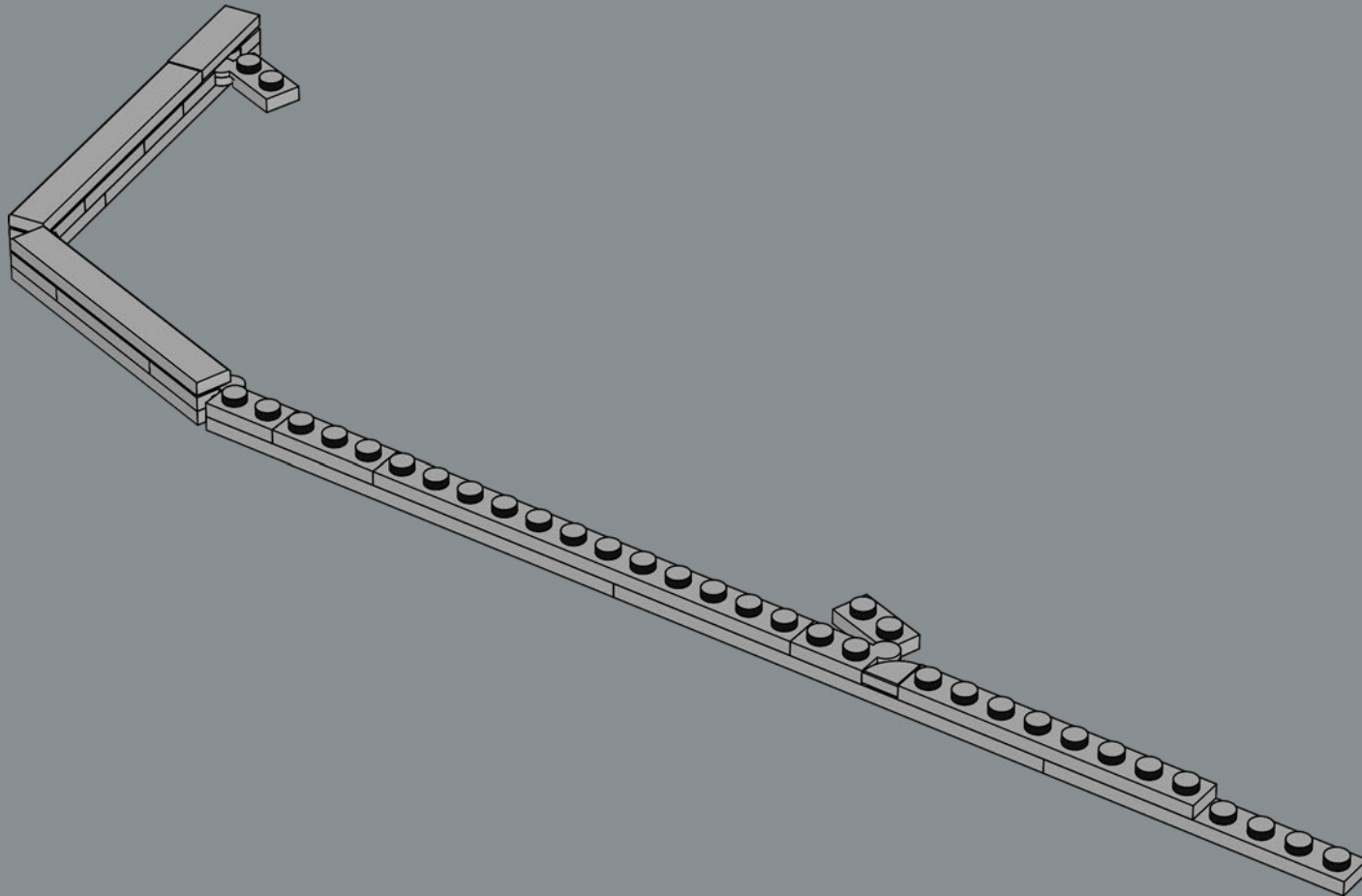

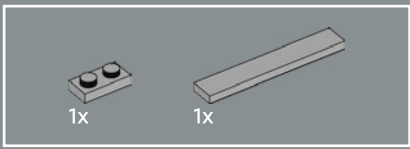

392

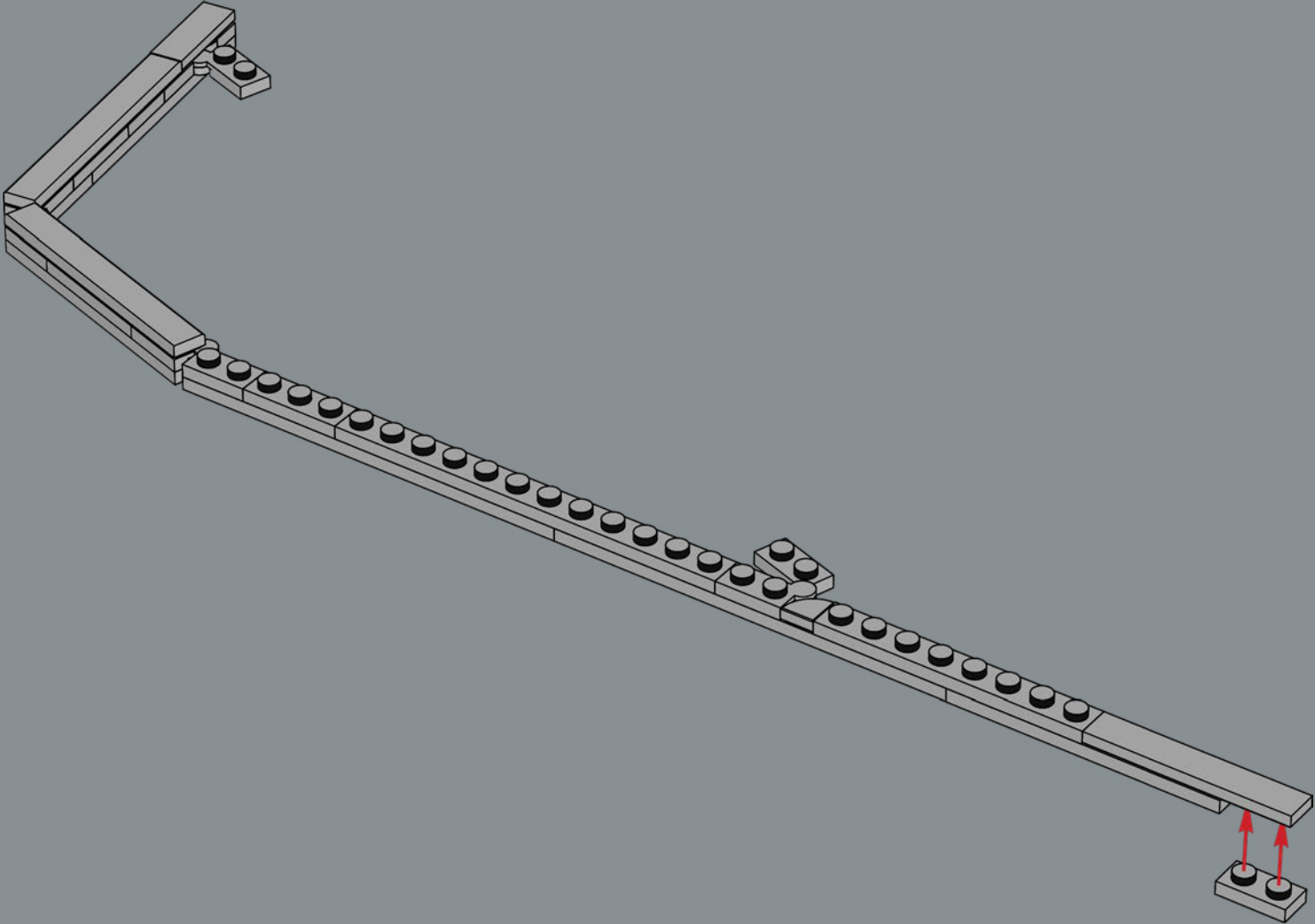

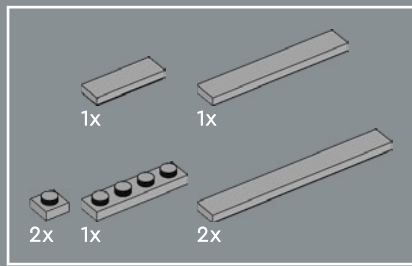

393

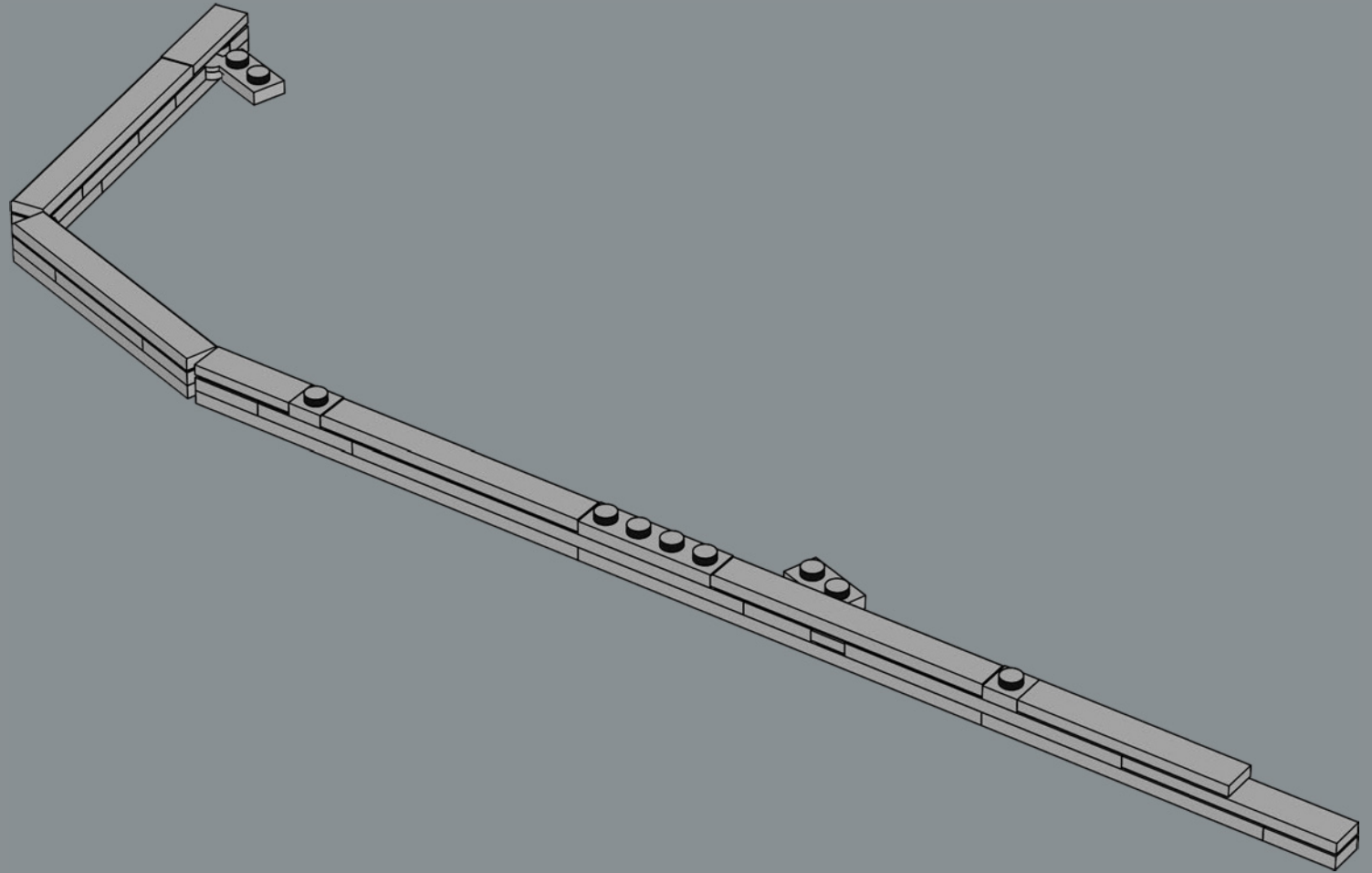

394

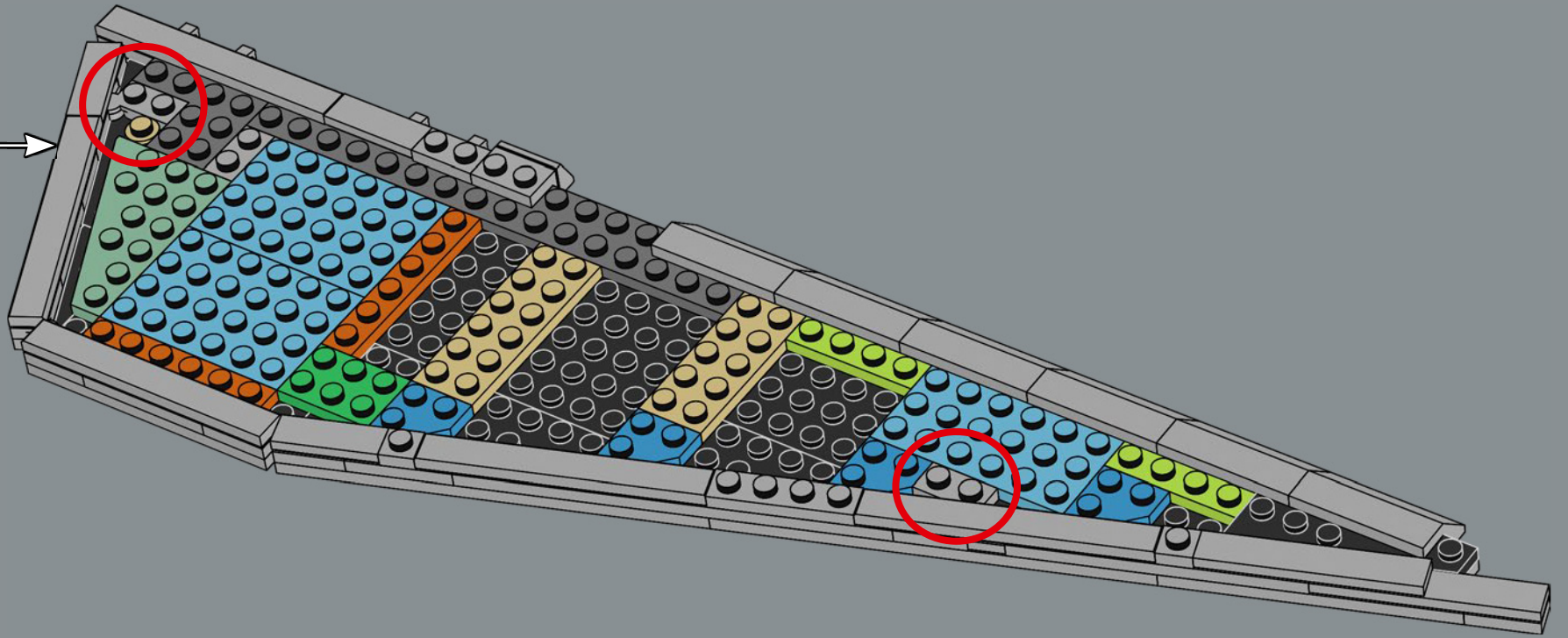



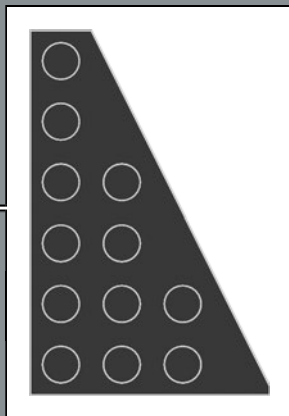
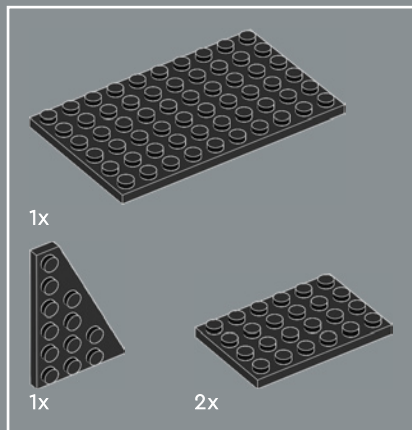

395

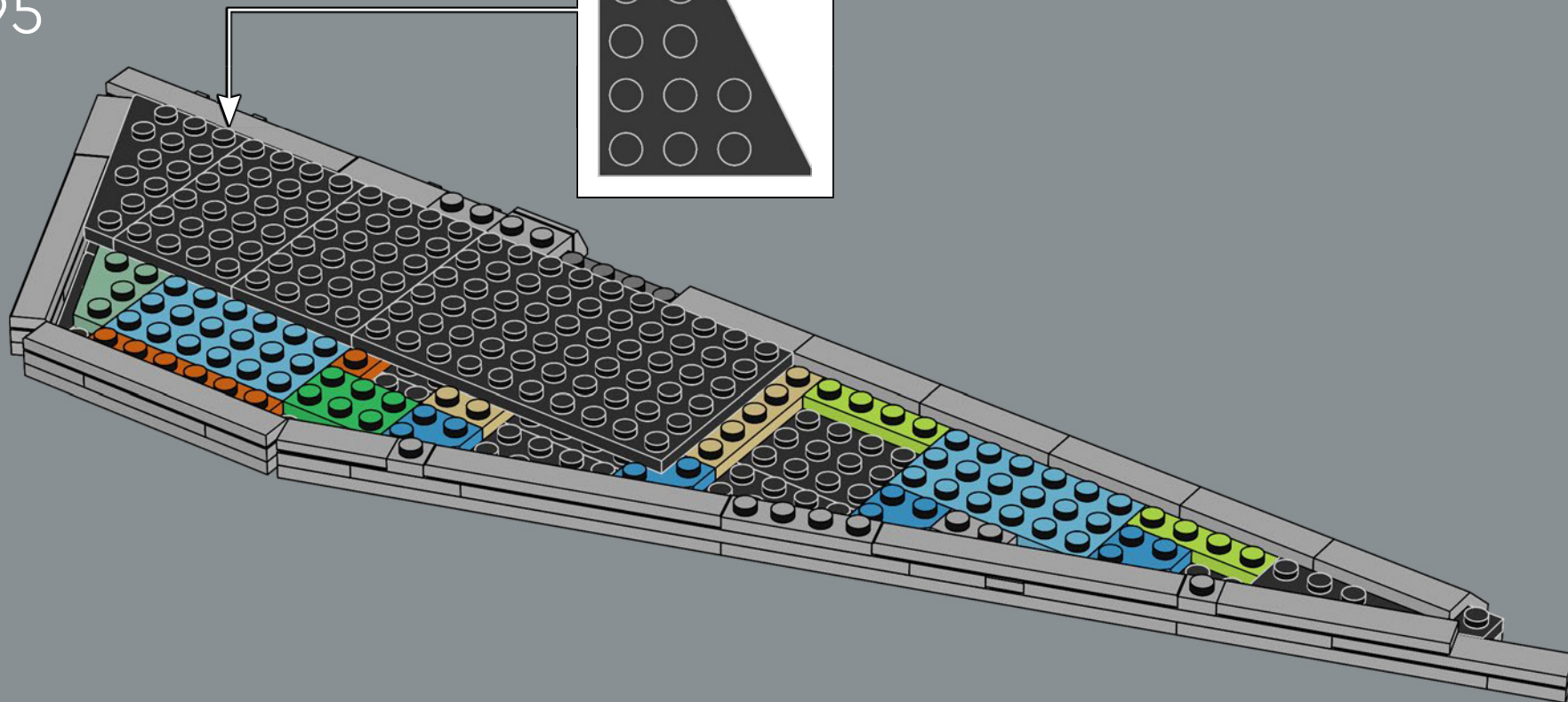

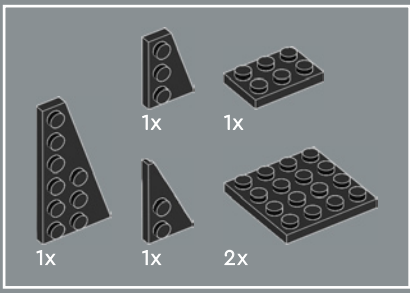

396

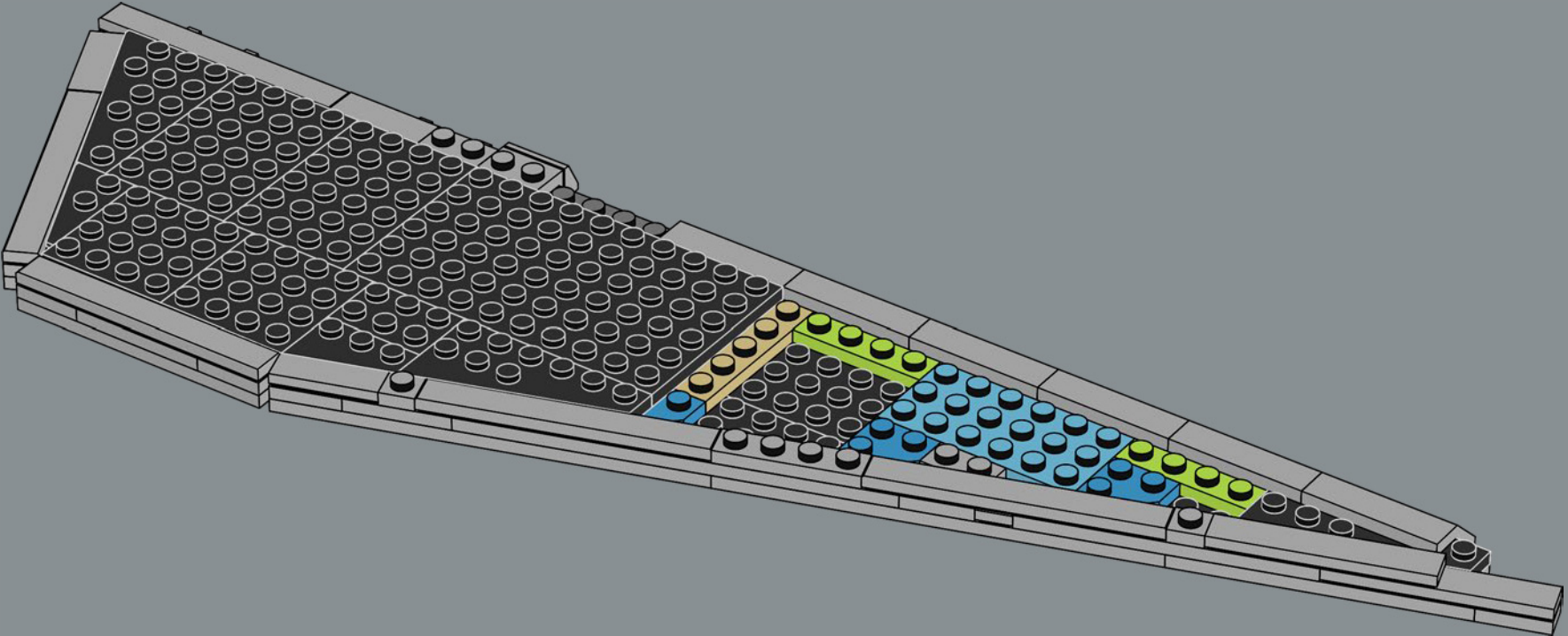

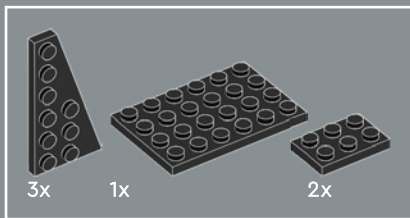

397

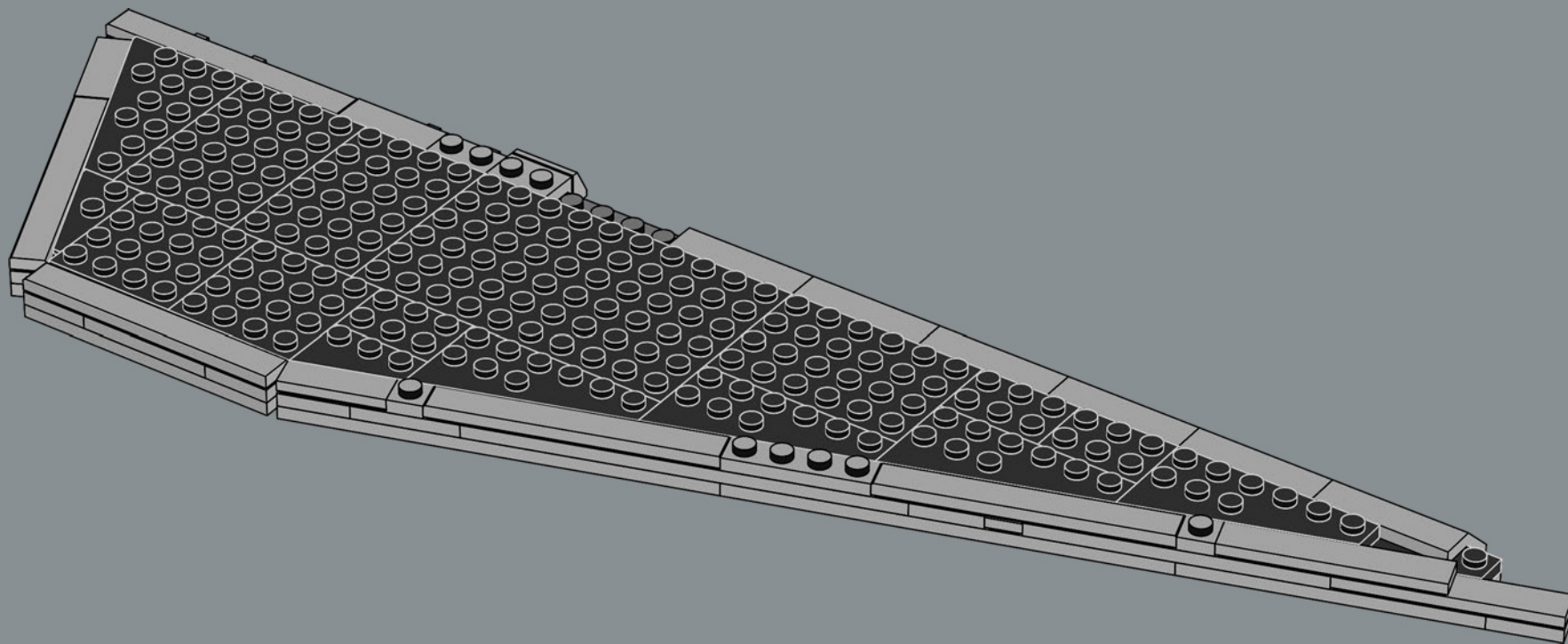

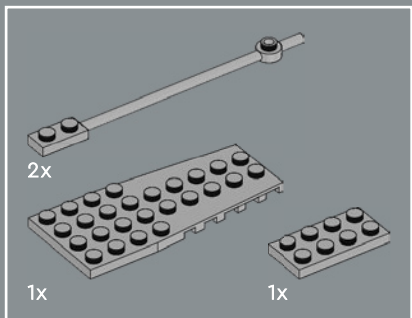

398

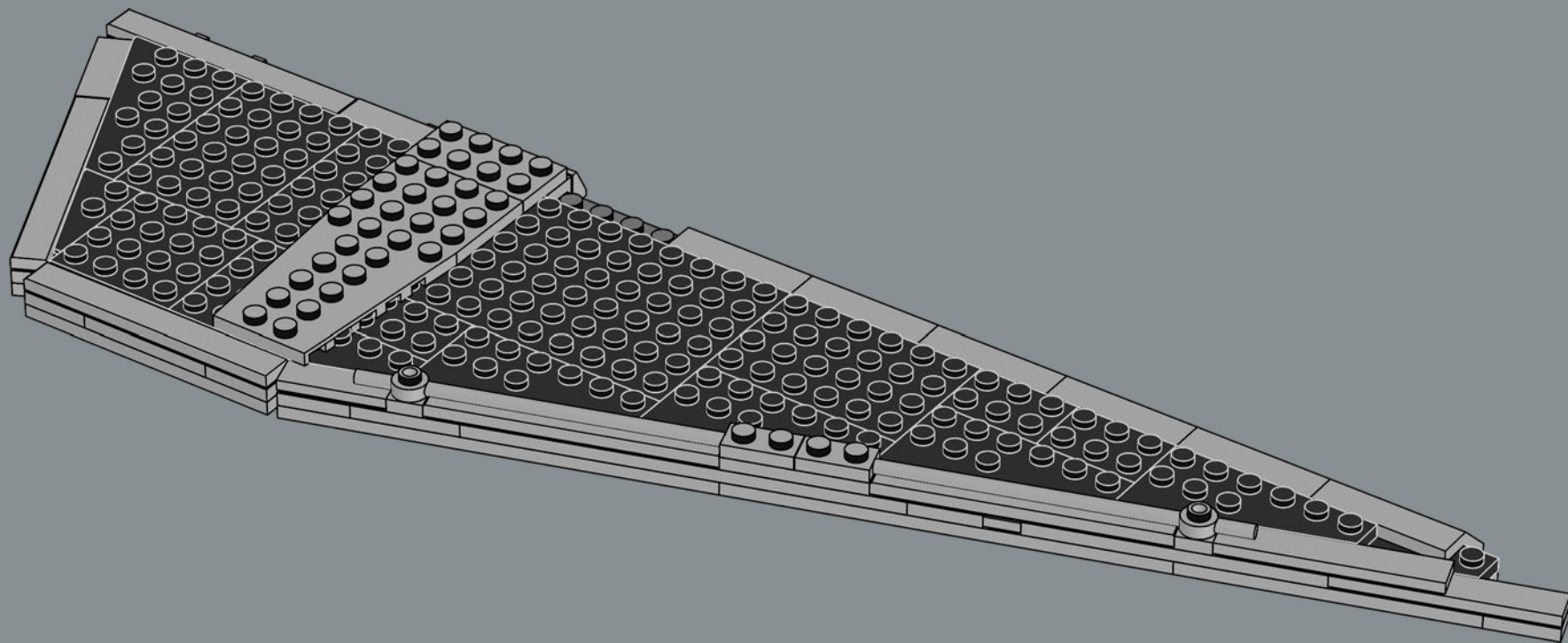



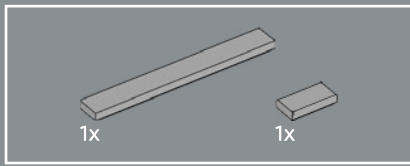

399

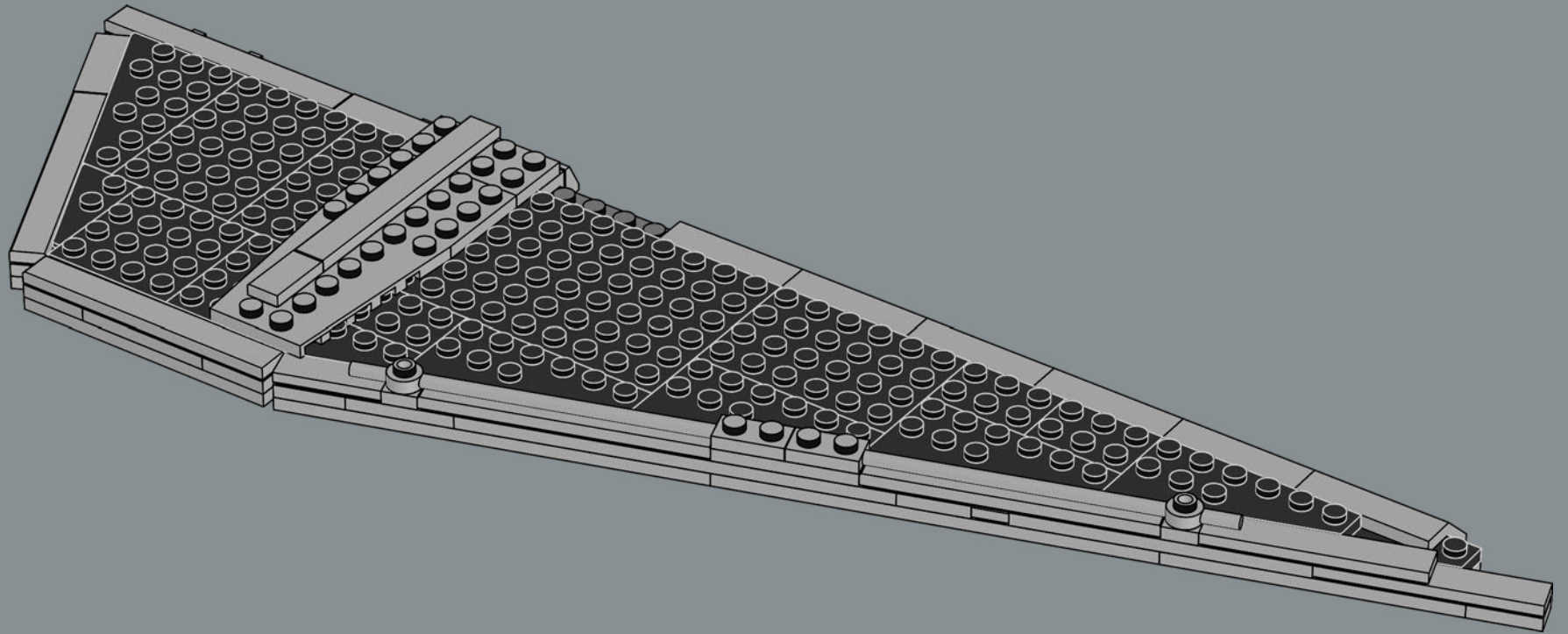

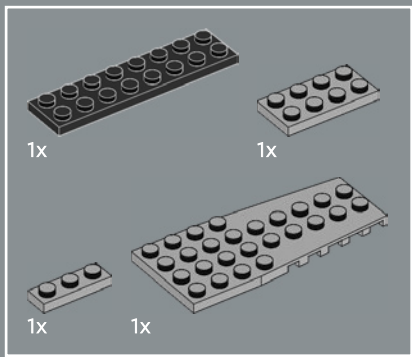

400

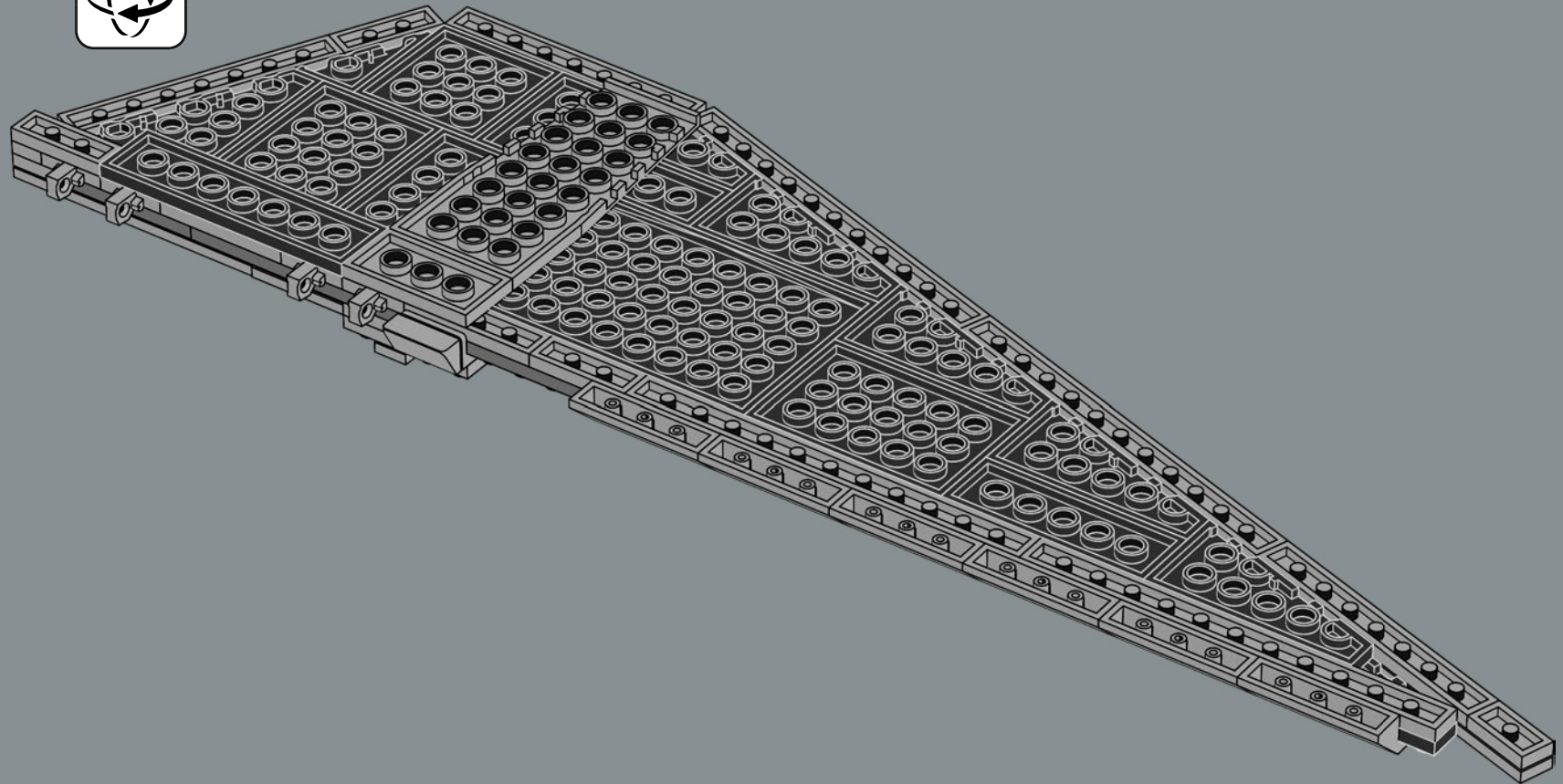

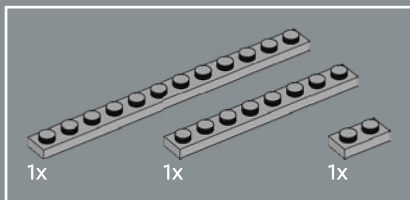

401

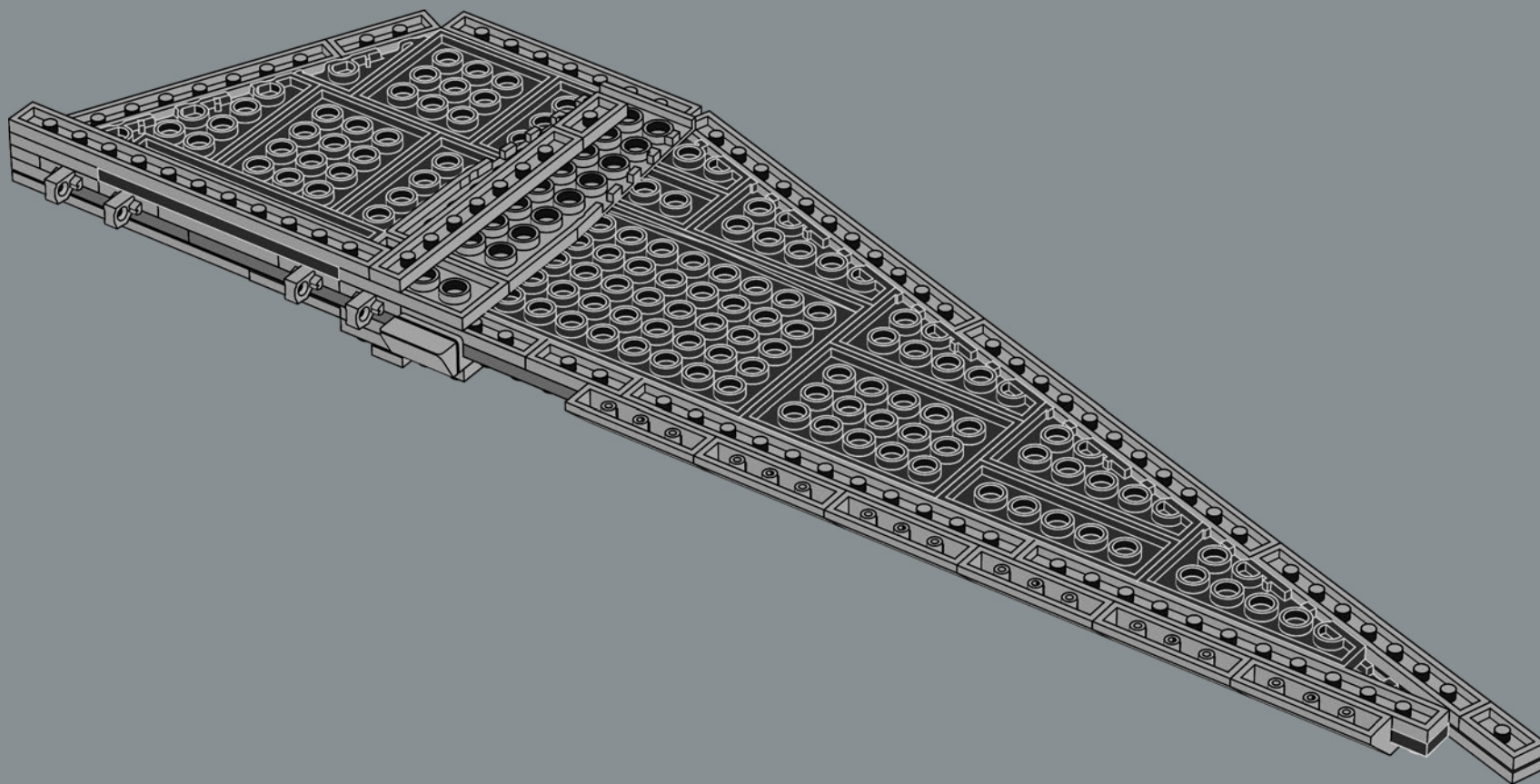

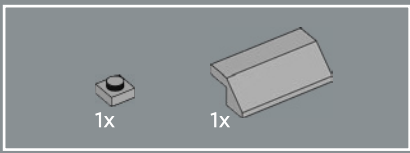

402

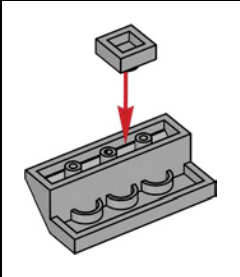
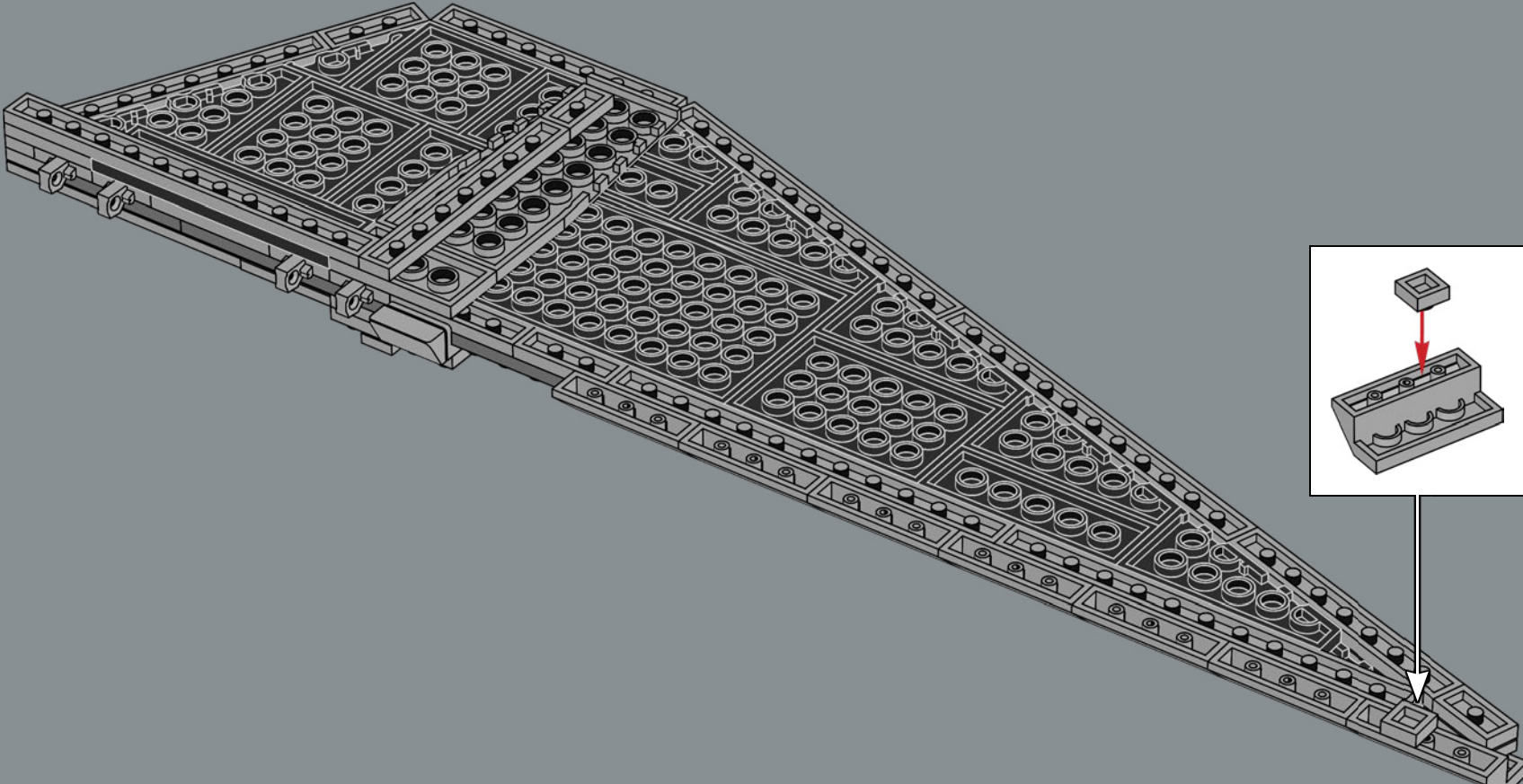



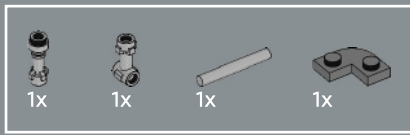

403

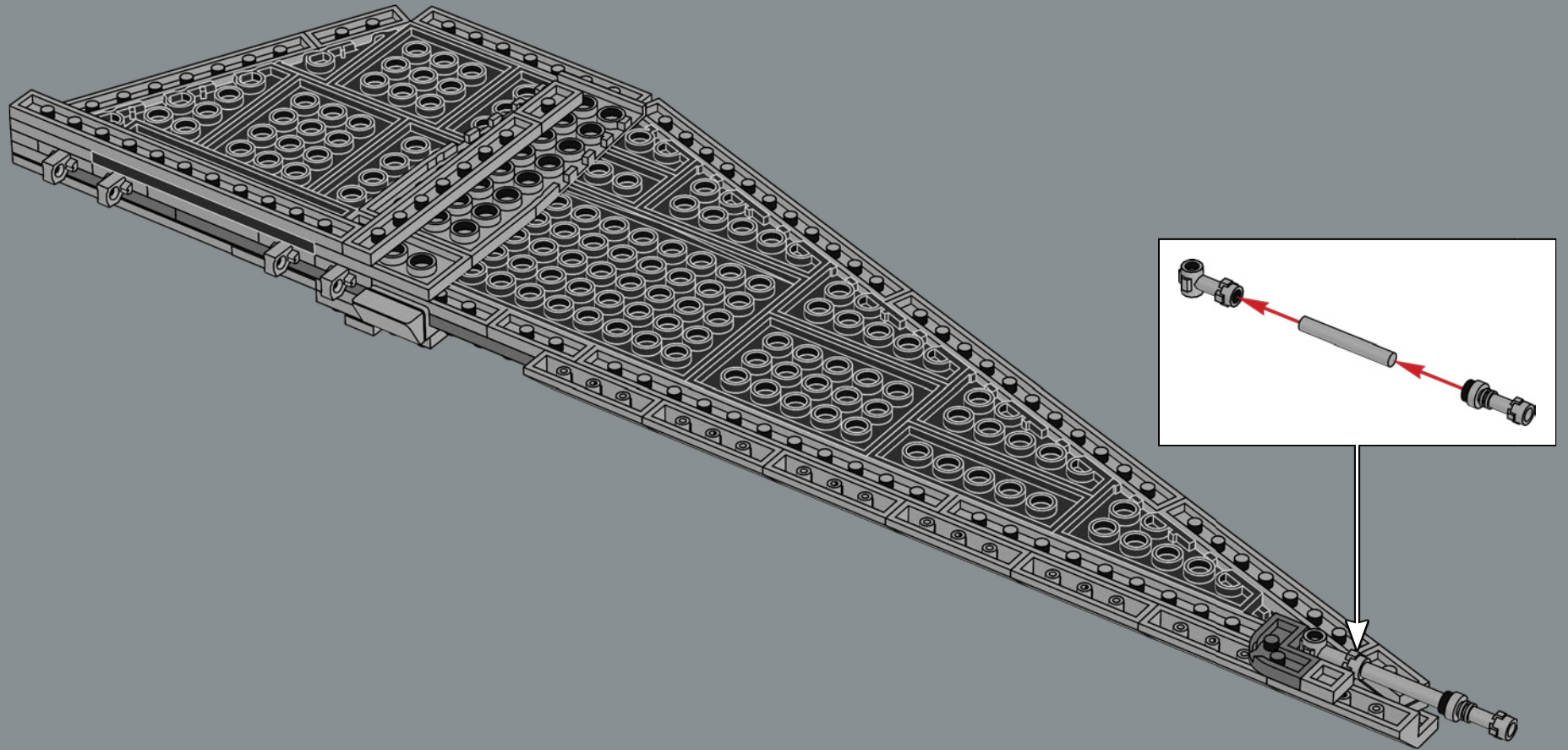



404

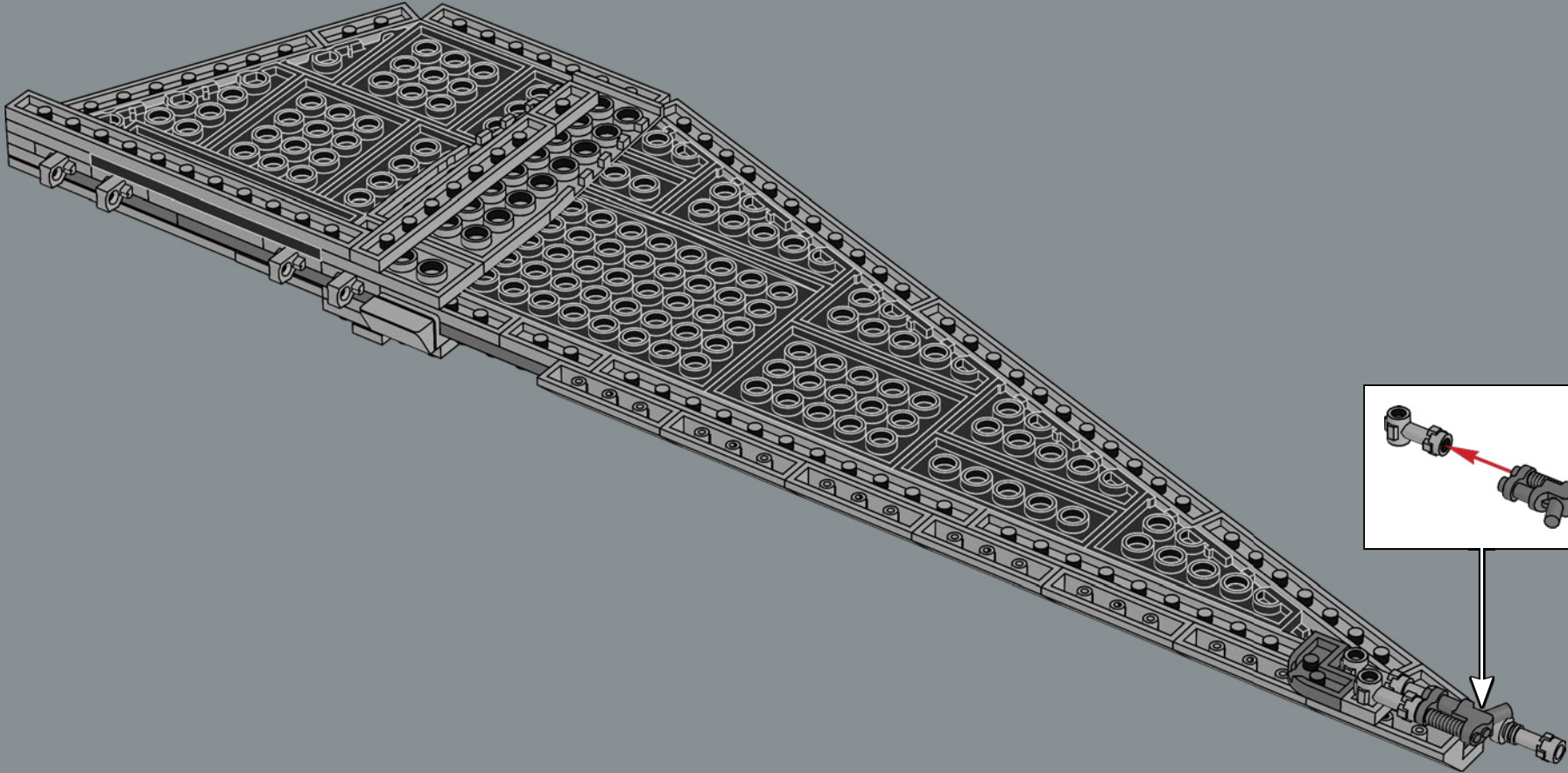



405

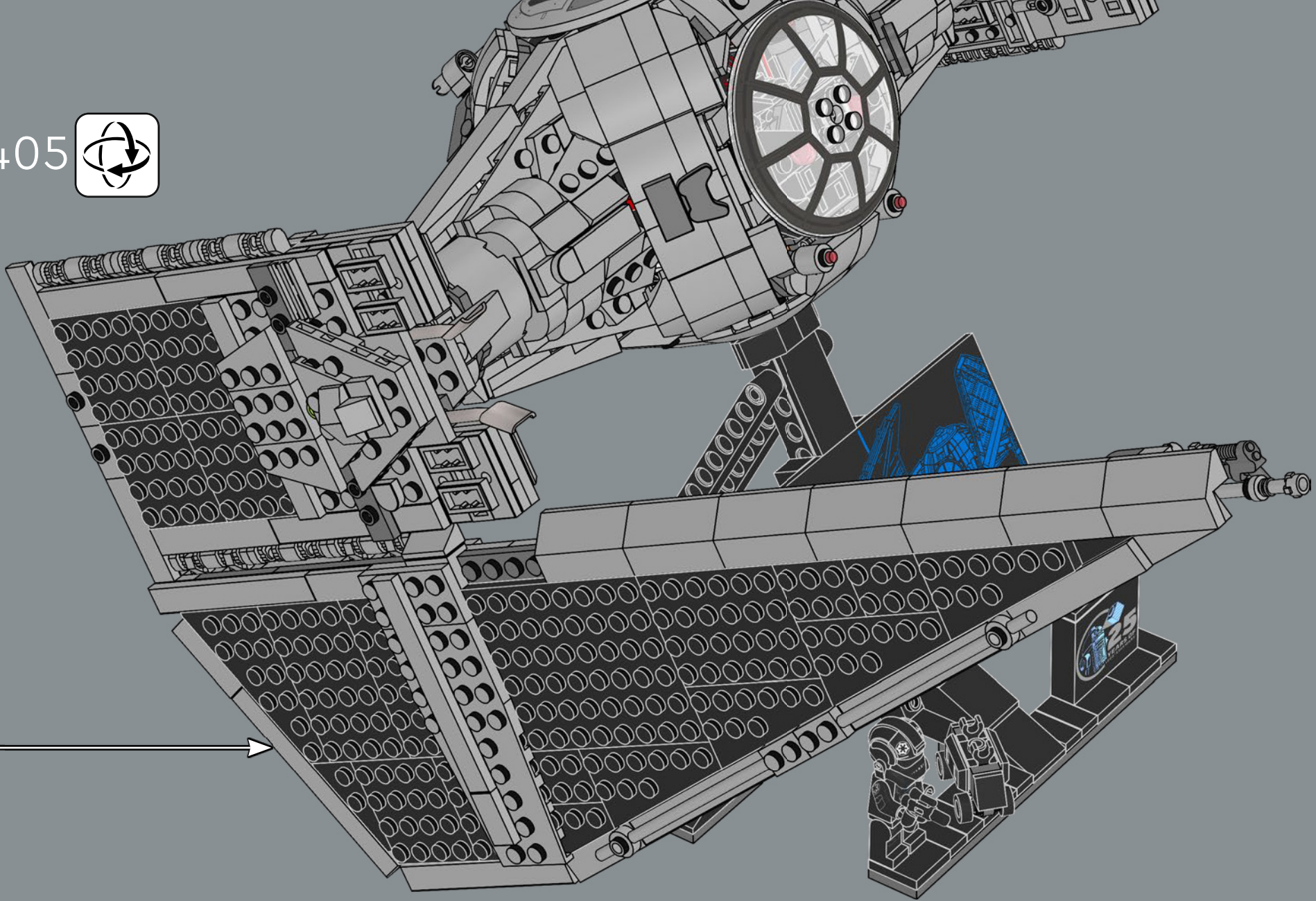



406

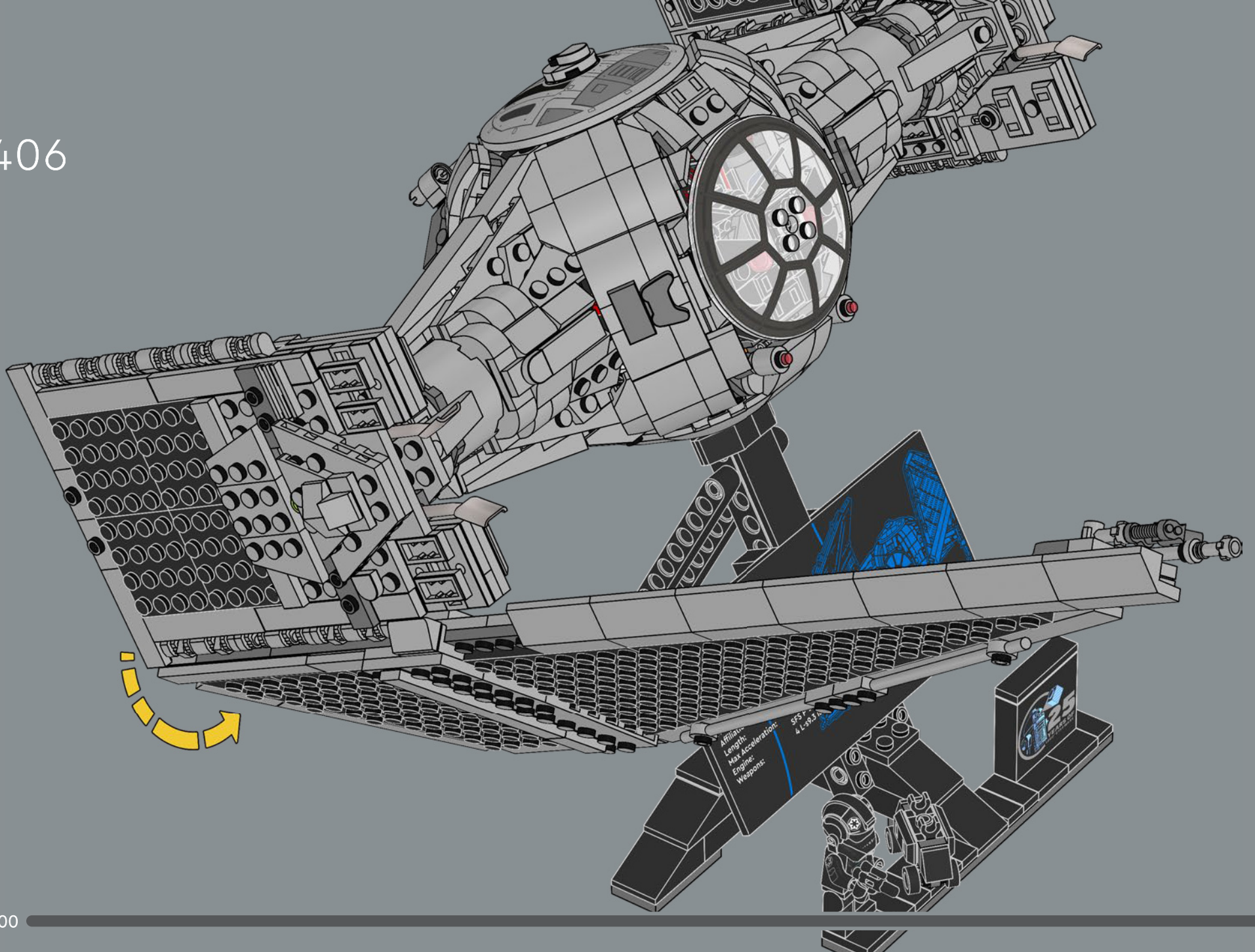



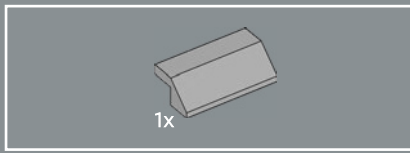

407

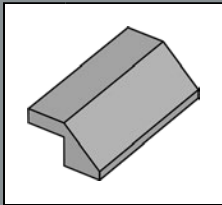
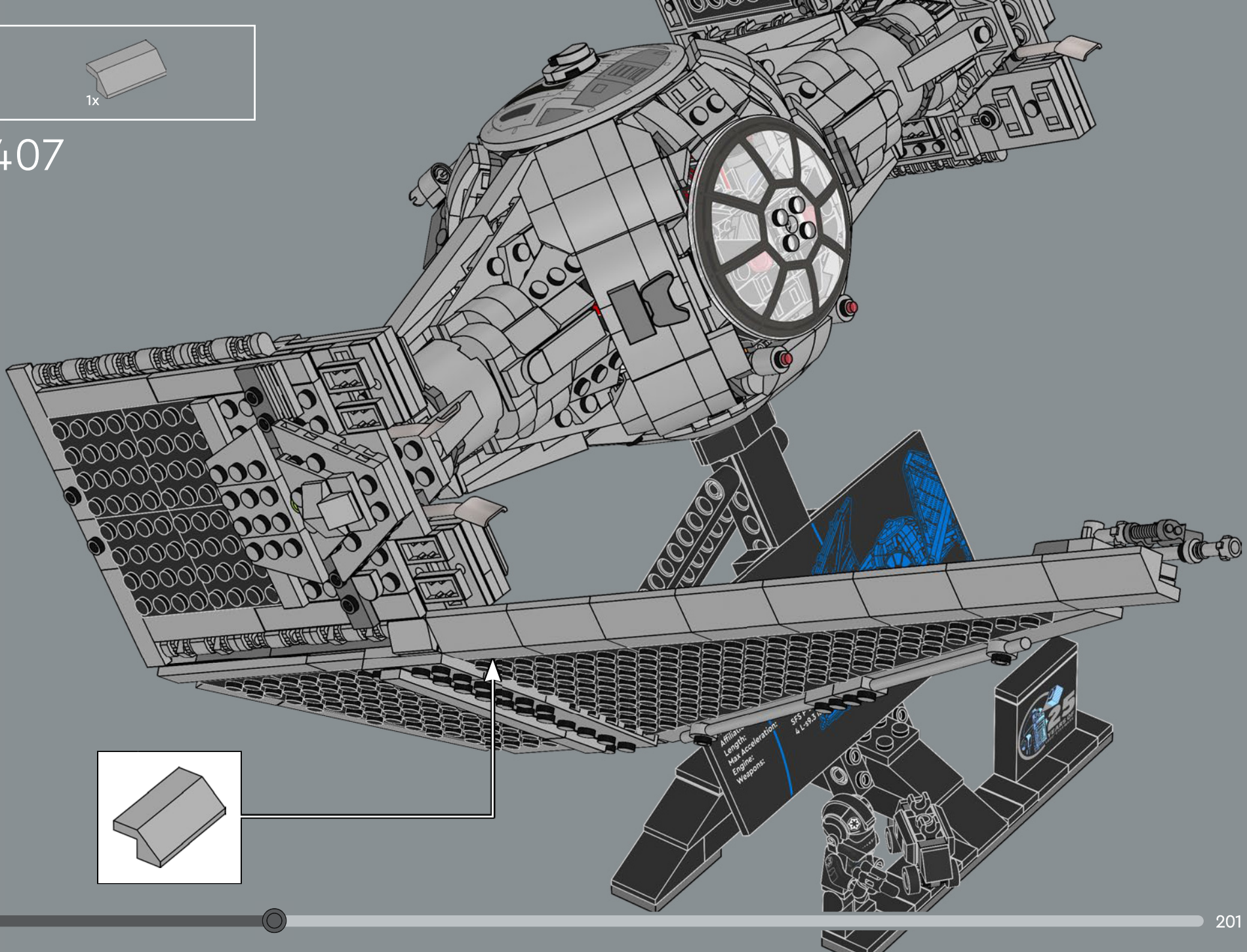

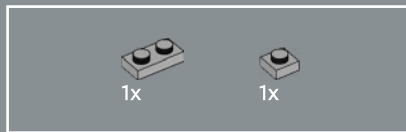
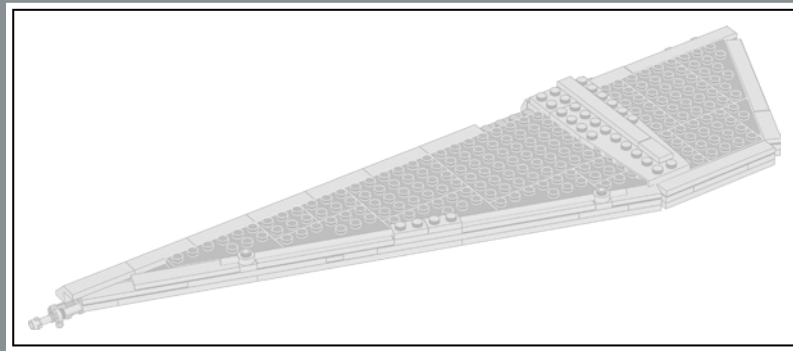

408

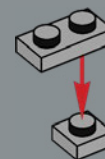

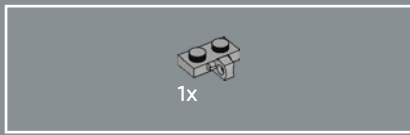

409

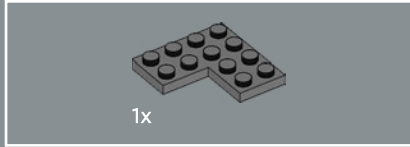
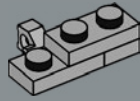

410

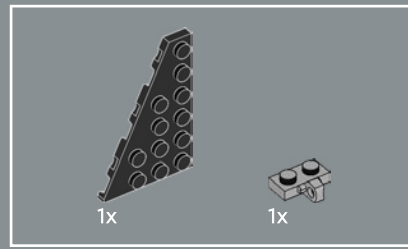
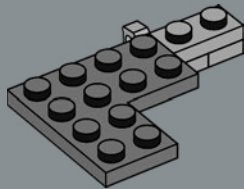

411

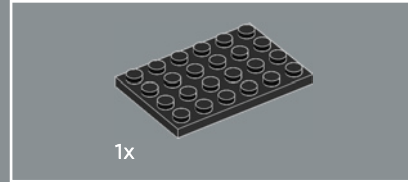
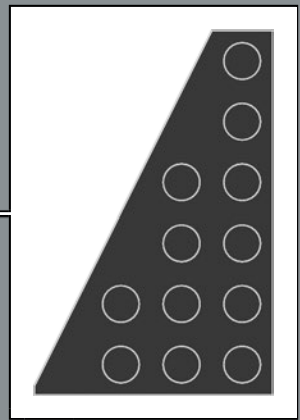
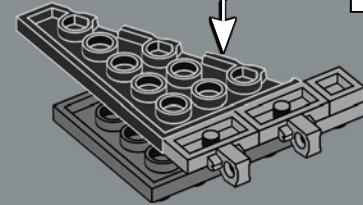

412

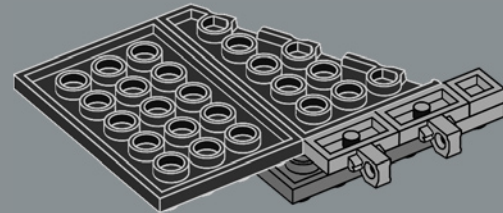

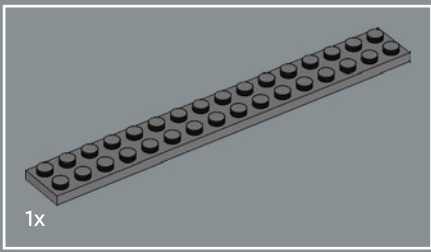

413

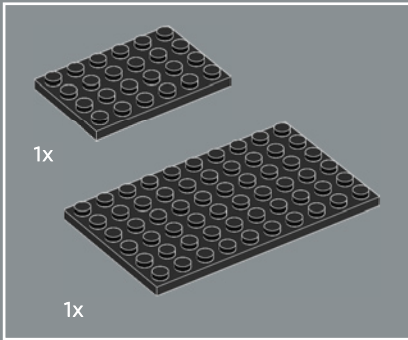
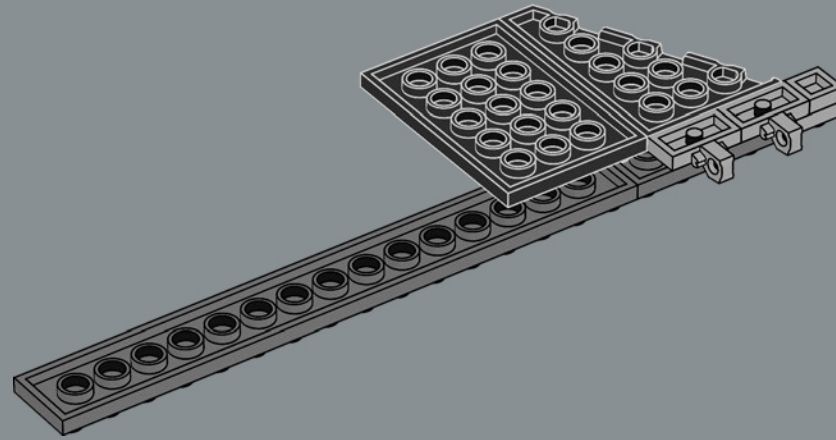

414

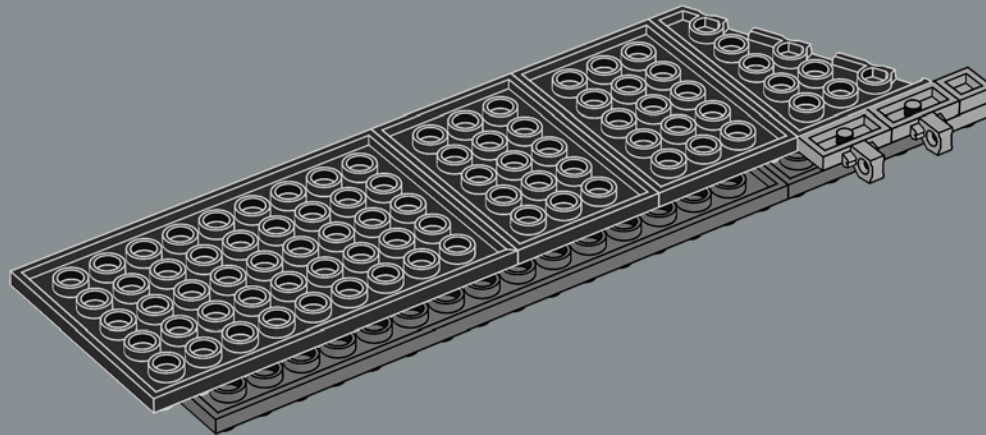



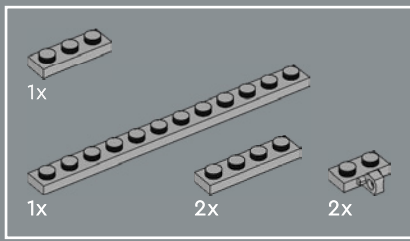

415

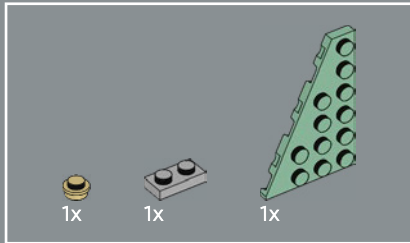
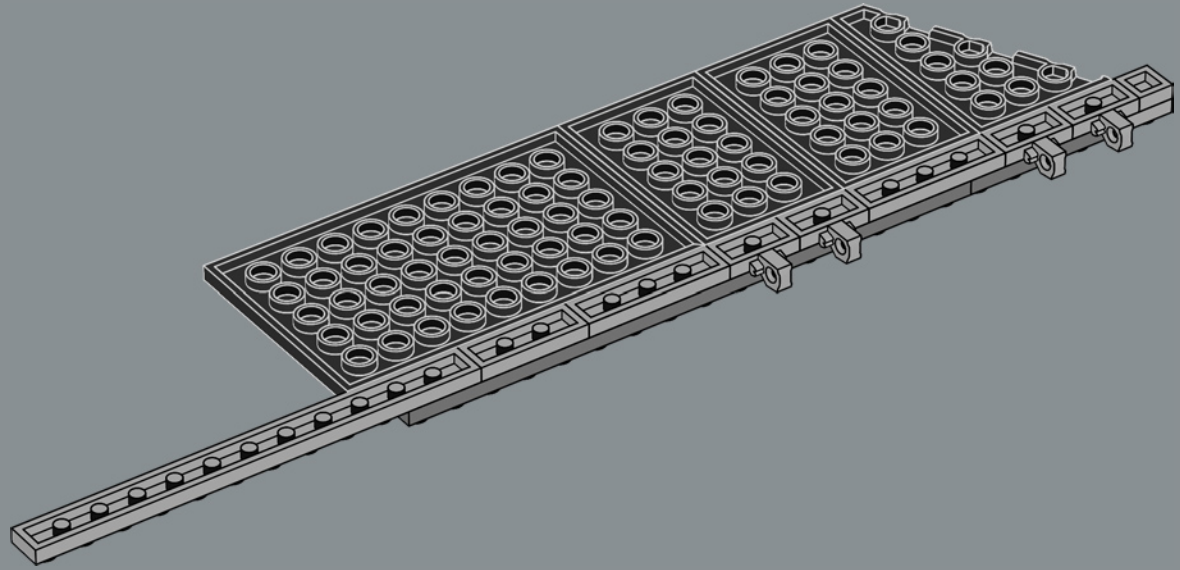

416

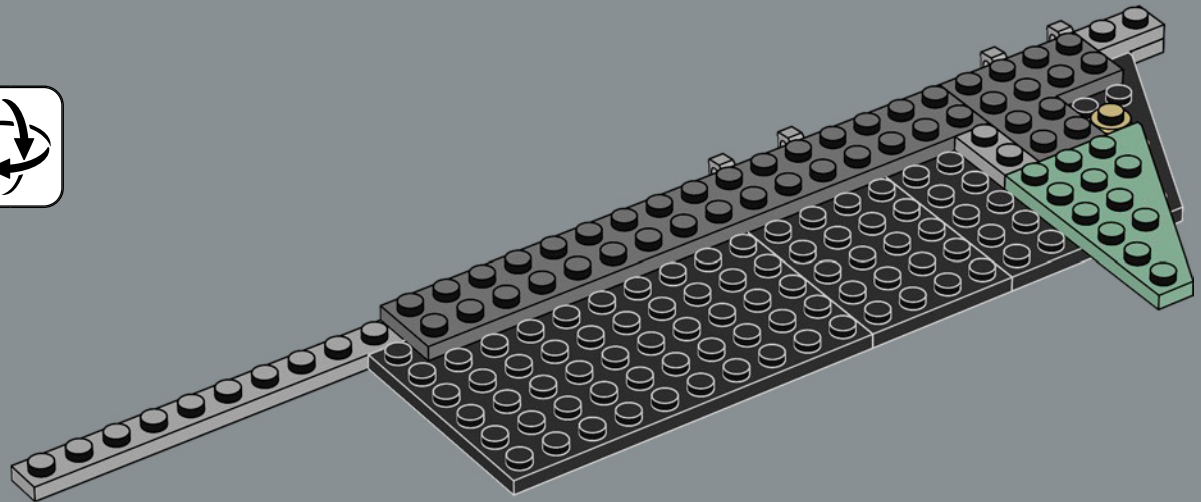

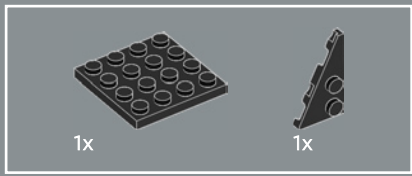

417

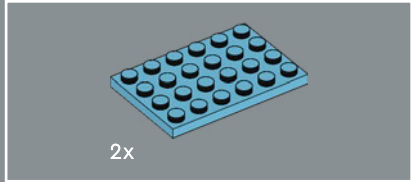
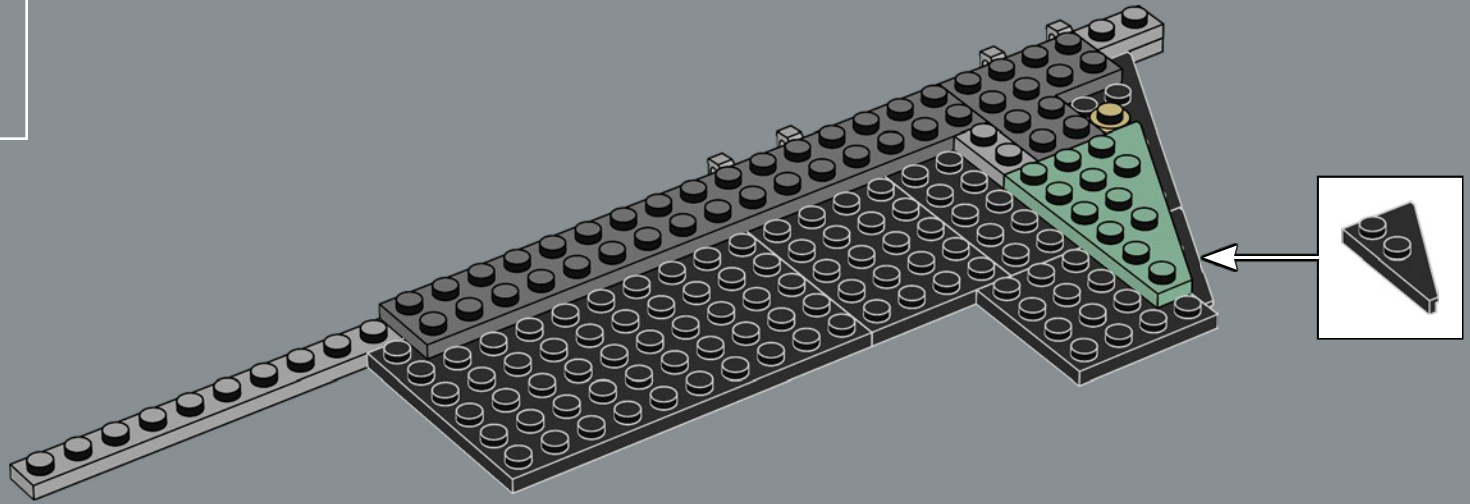

418

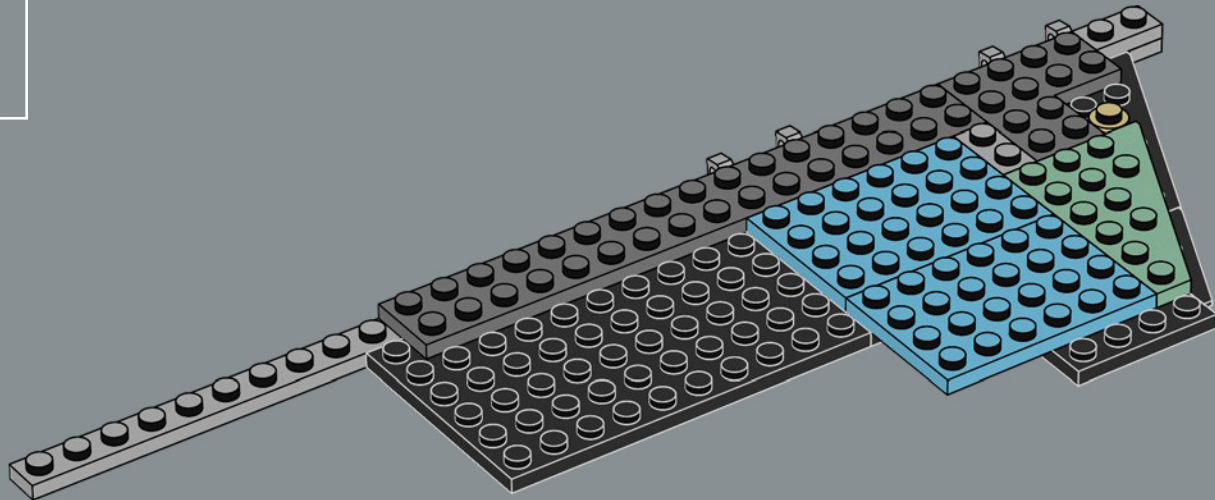

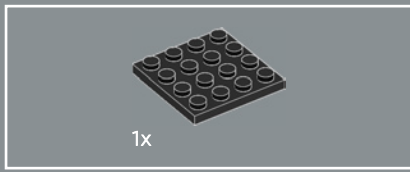

419

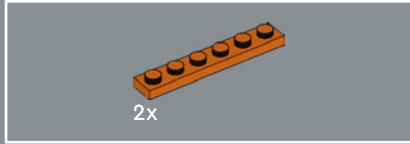
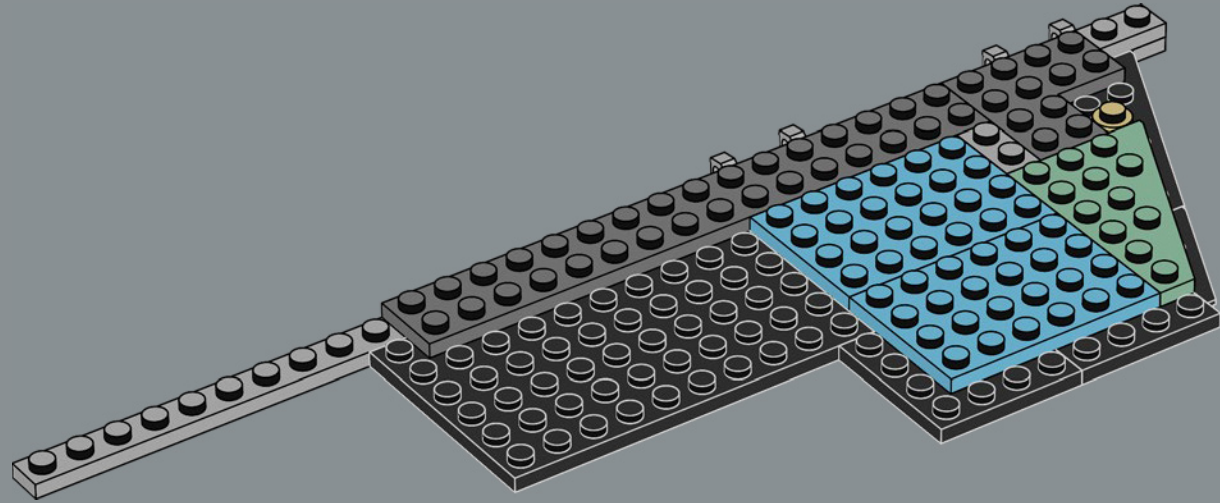

420

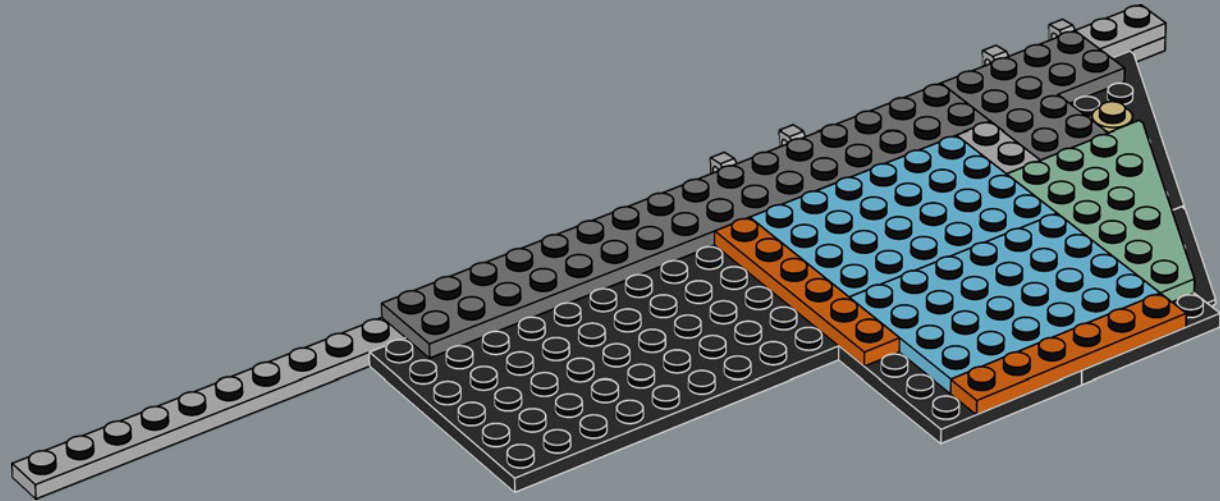

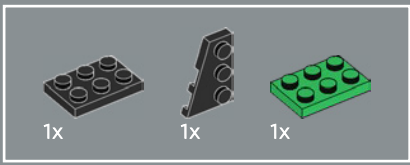

421

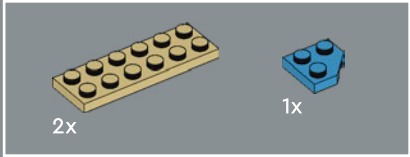
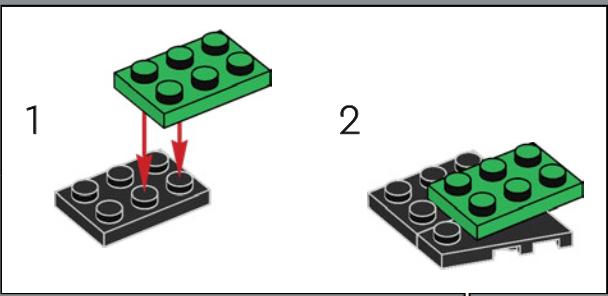
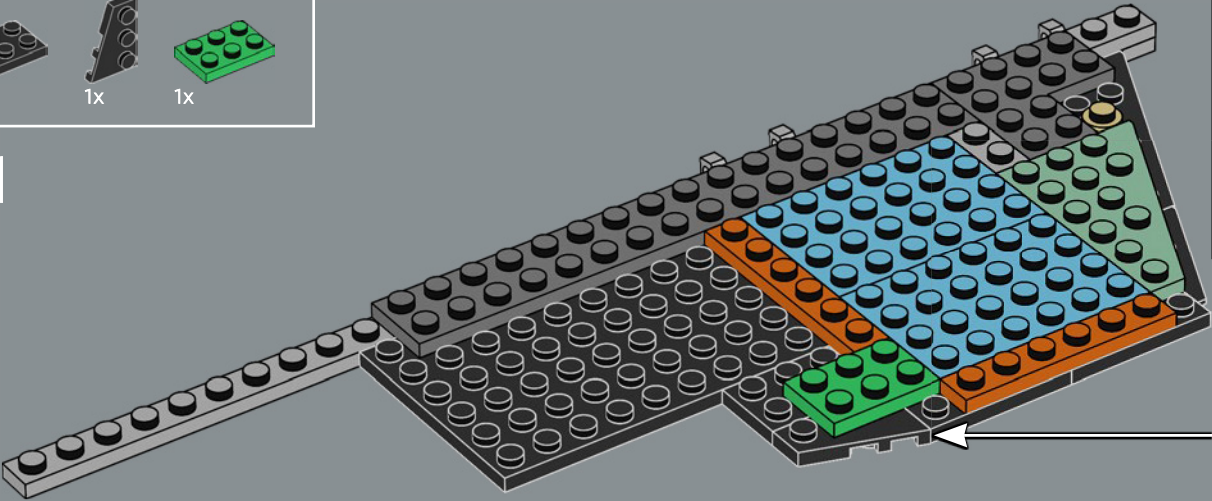

422

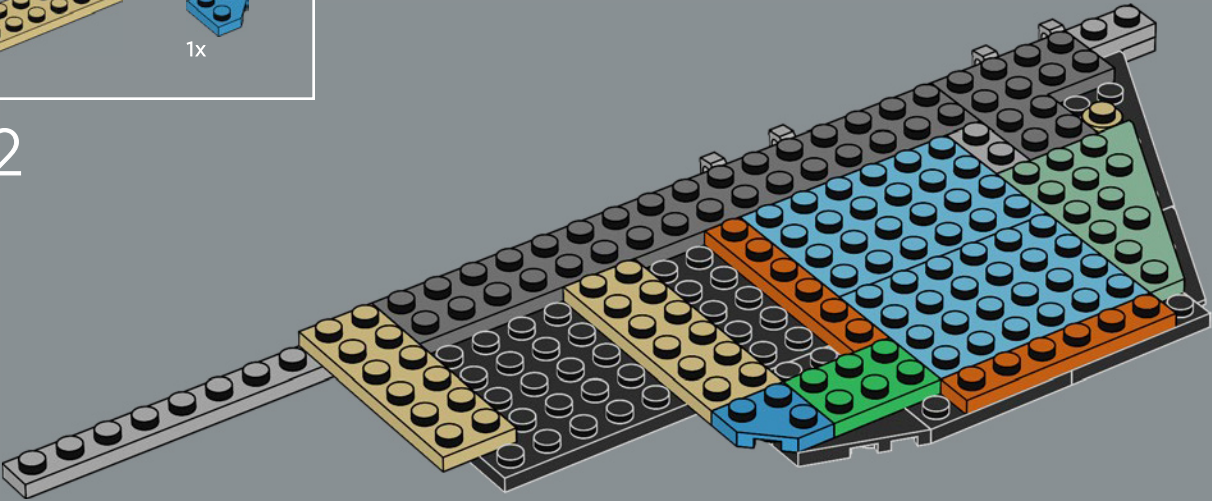



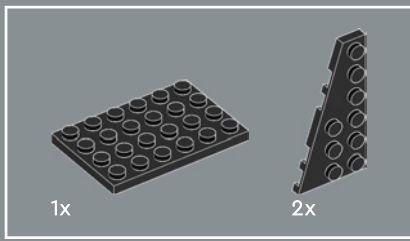

423

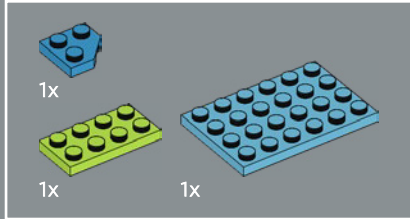
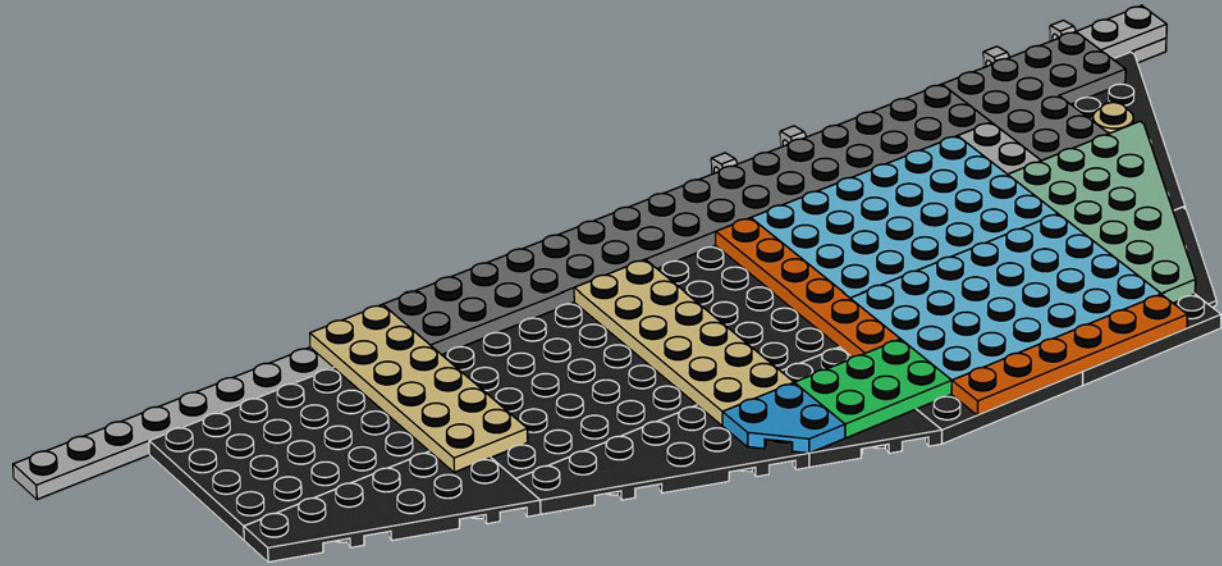

424

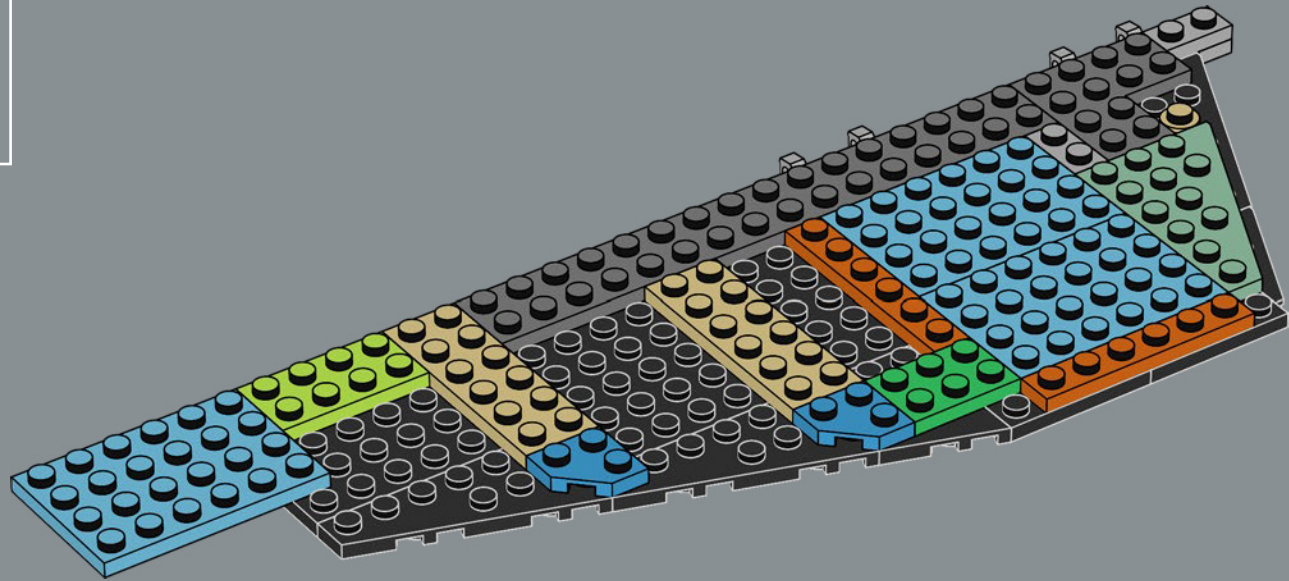

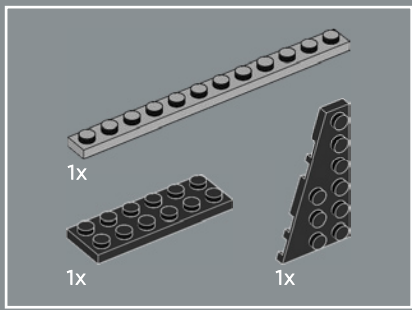

425

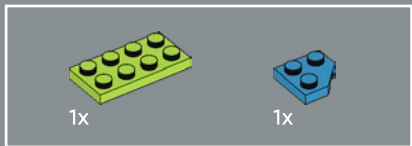
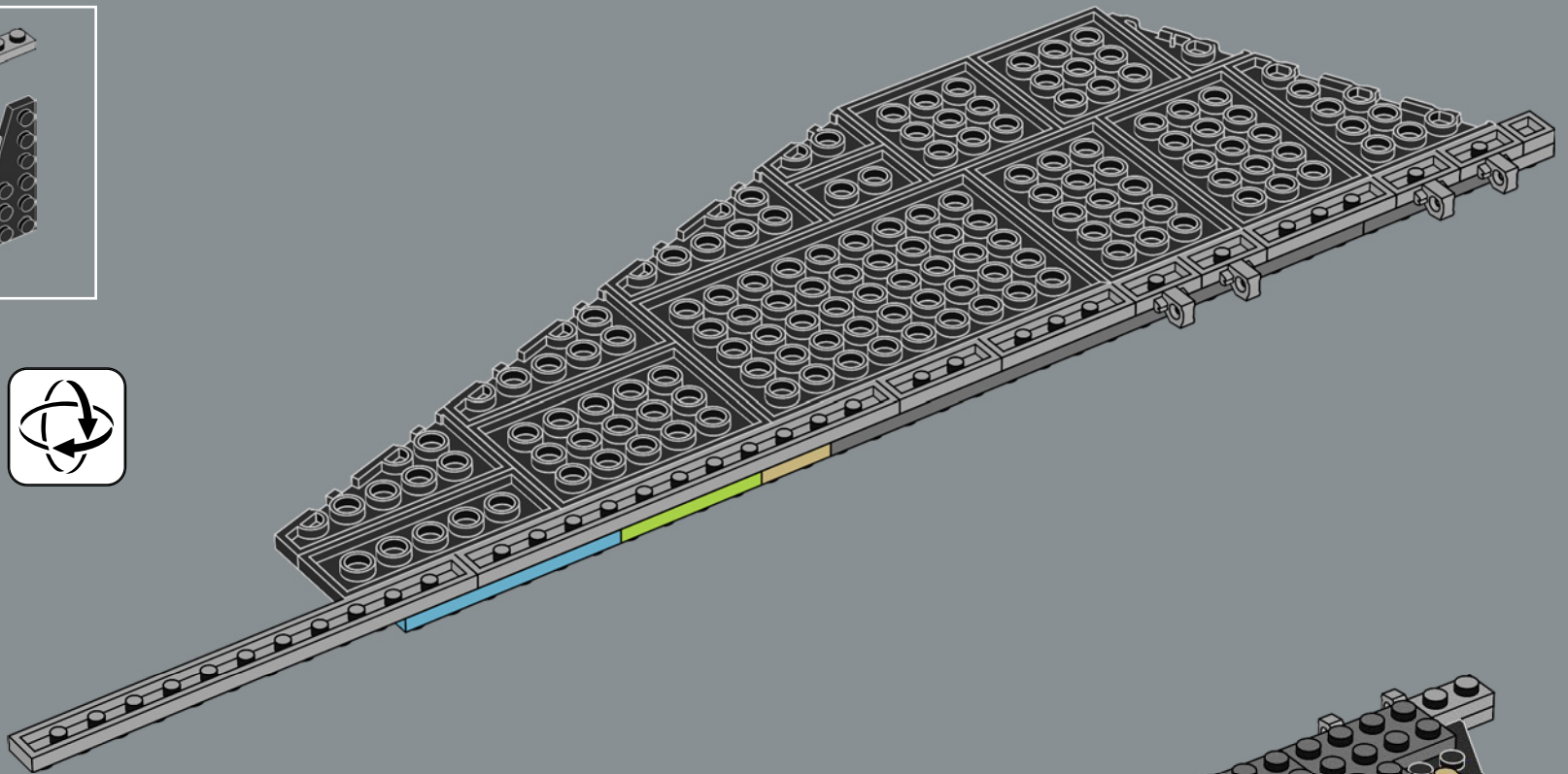

426

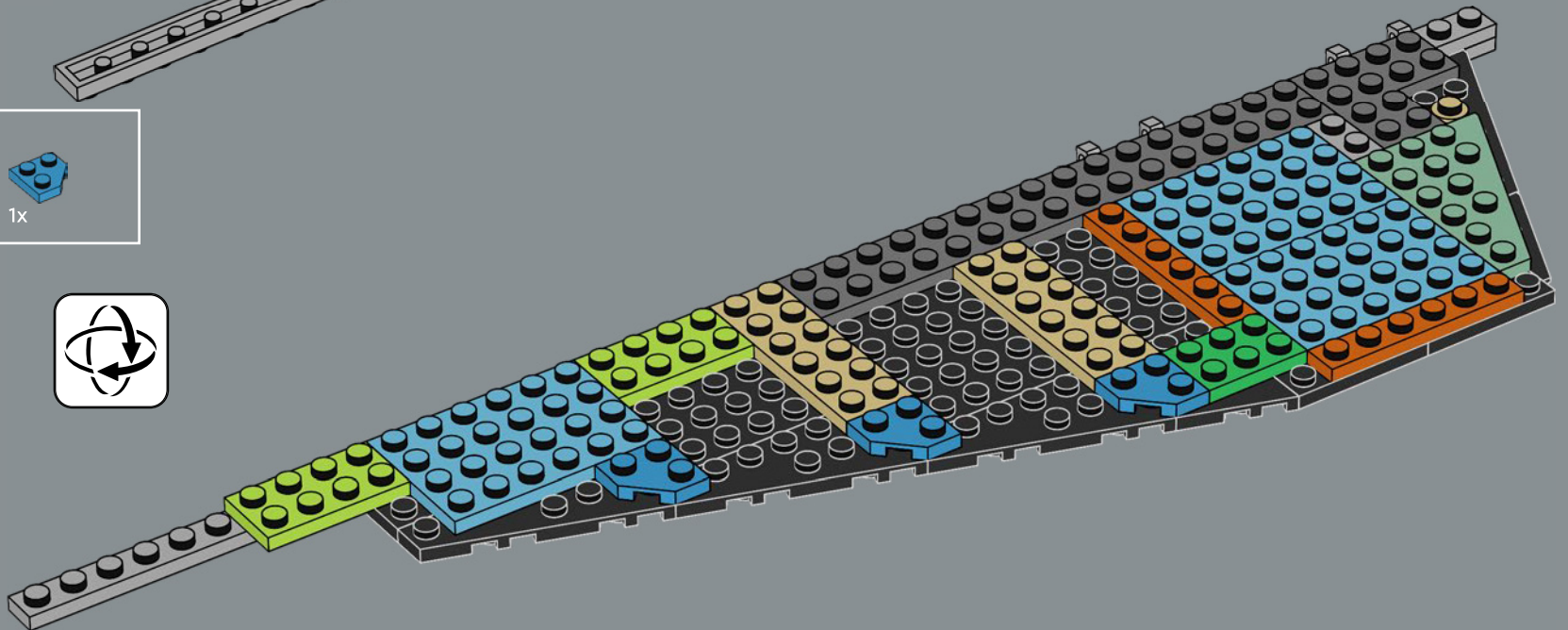



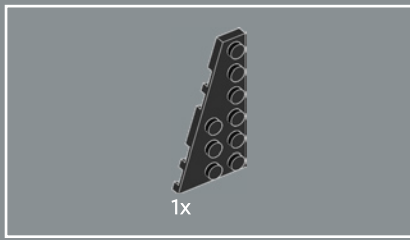

427

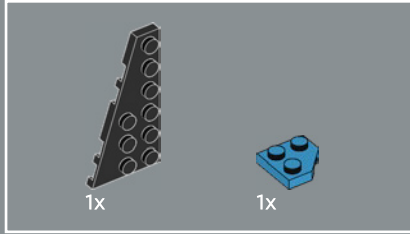
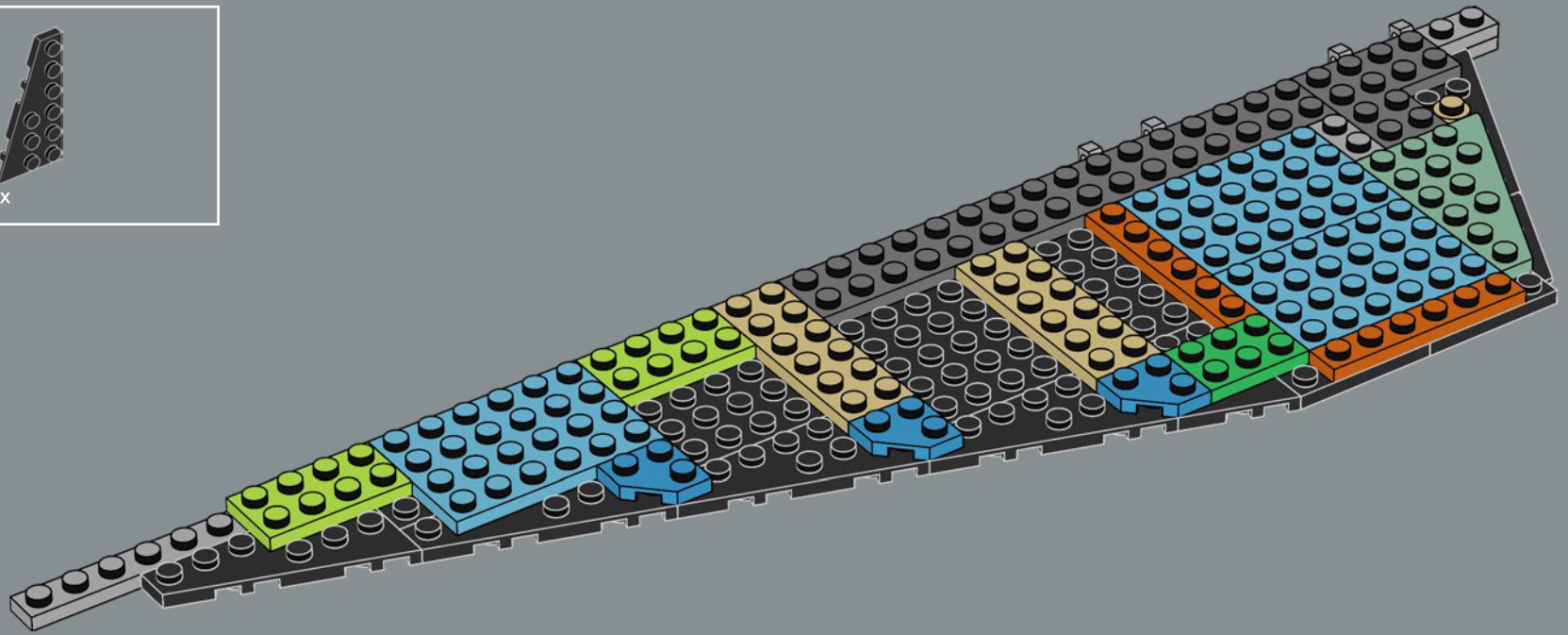

428

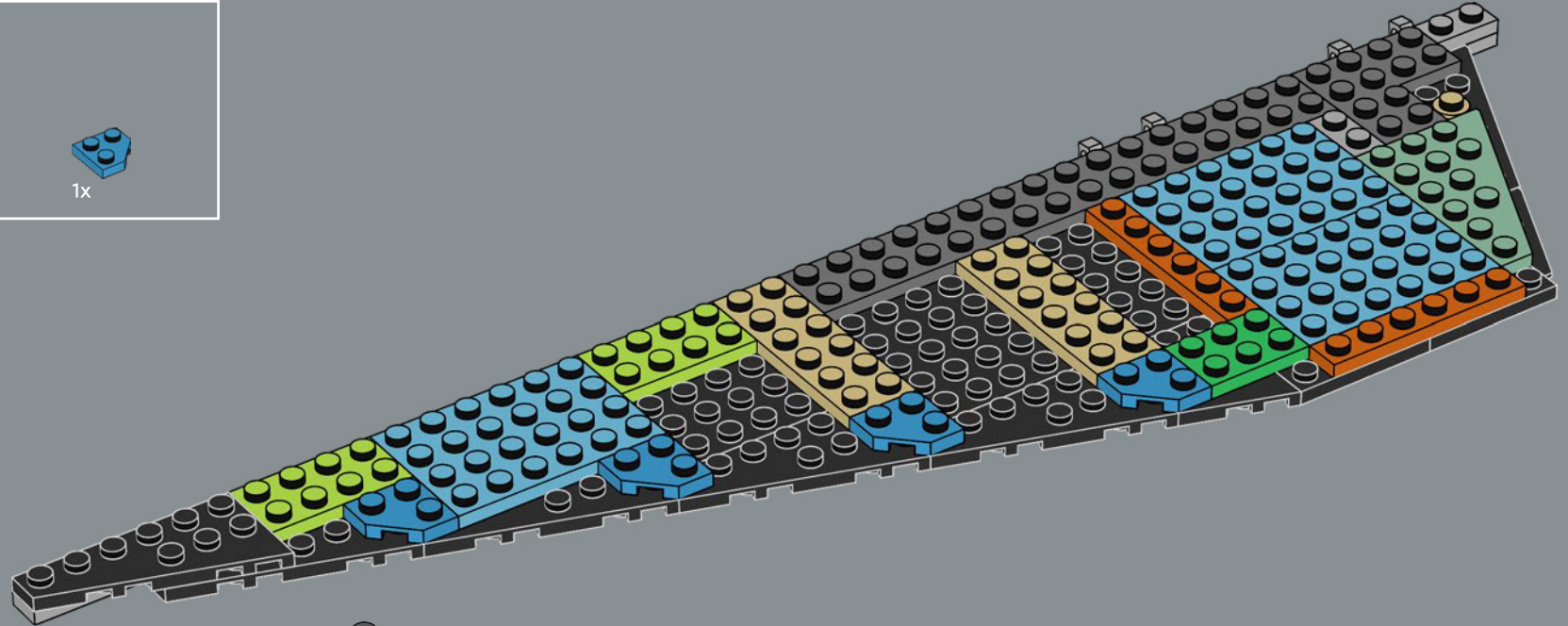

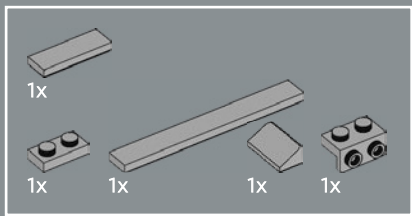

429

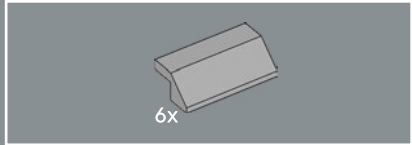
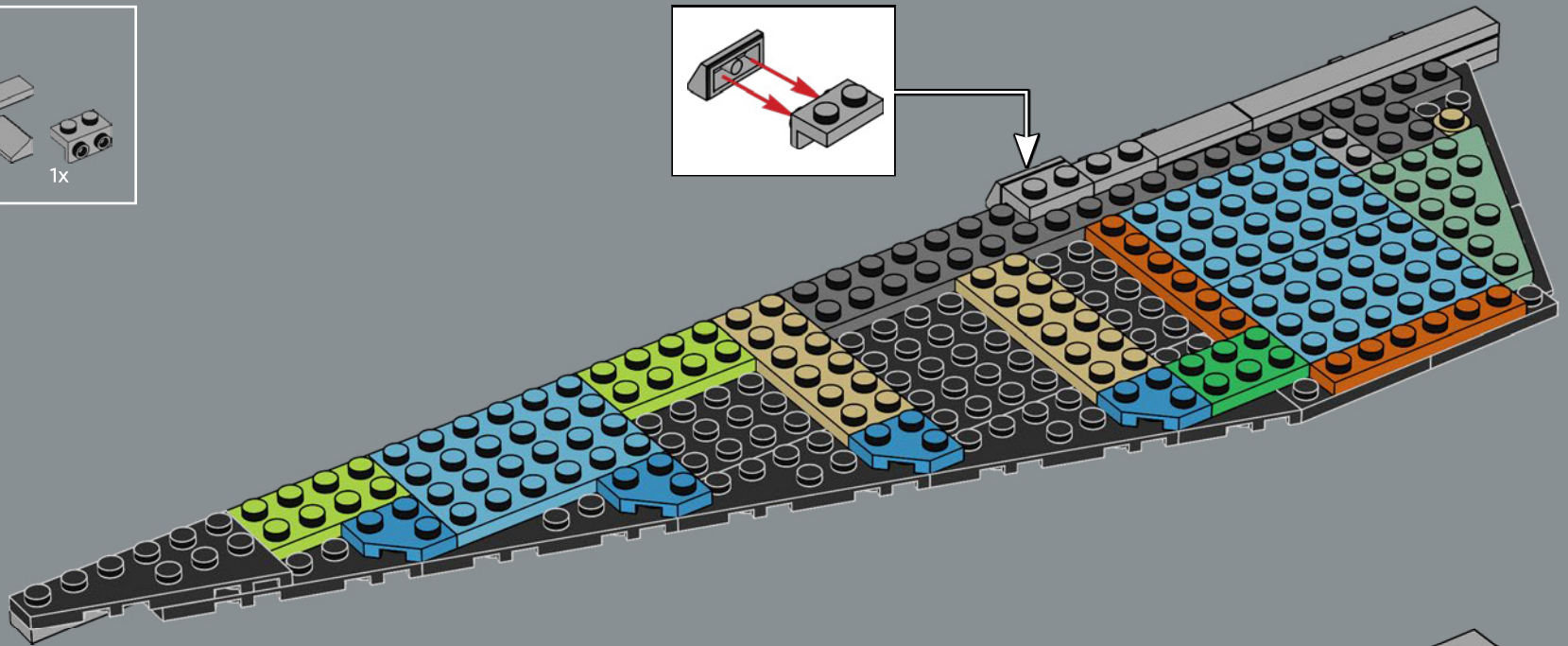
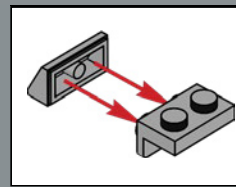

430

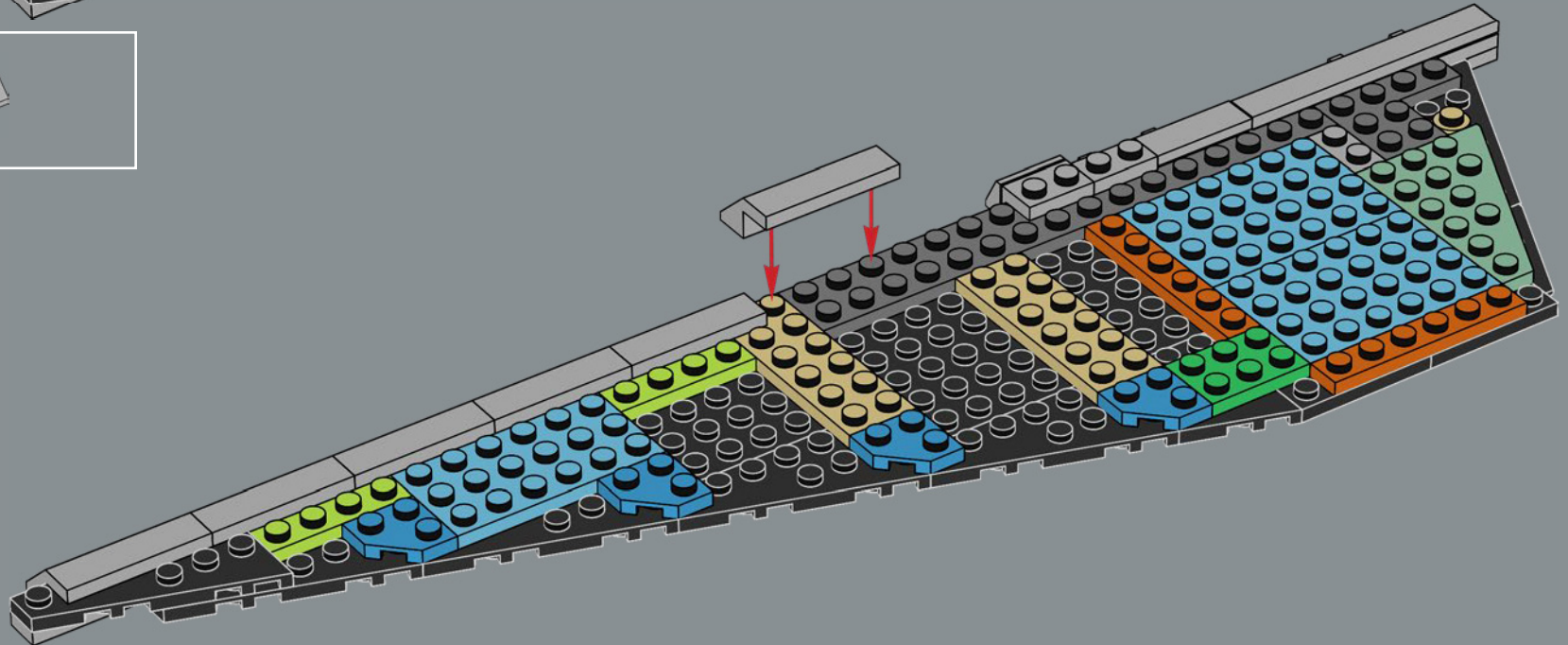



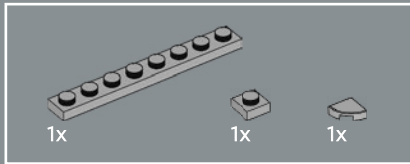
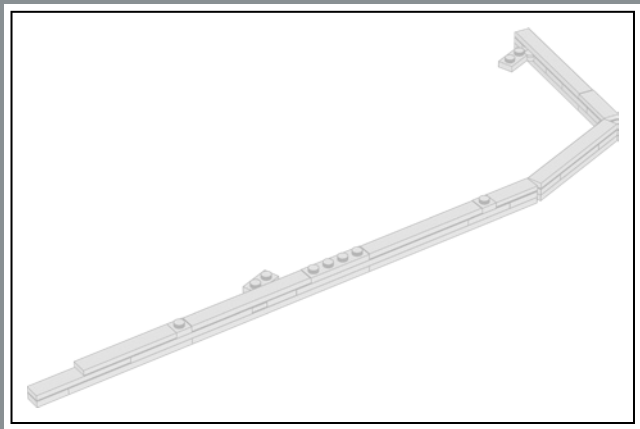

431

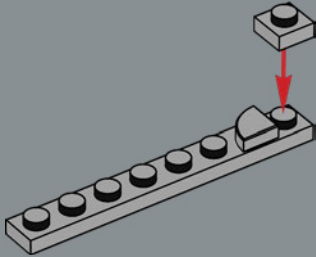

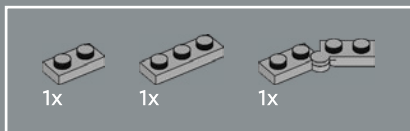

432

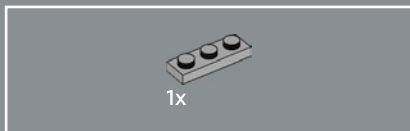
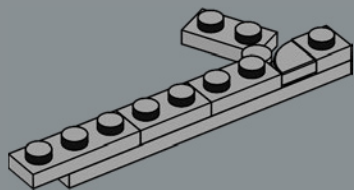

433

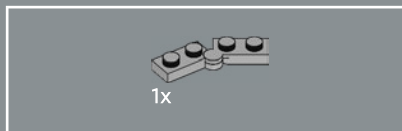
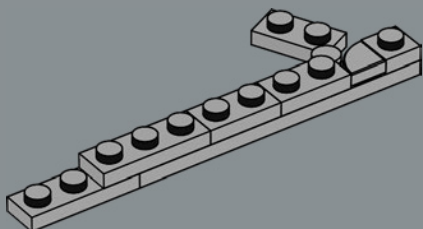

434

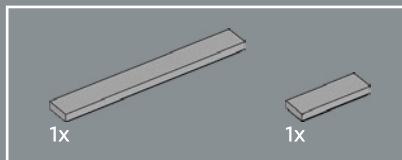
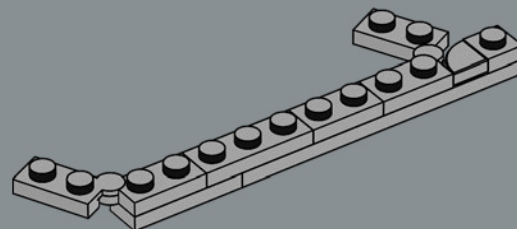

435

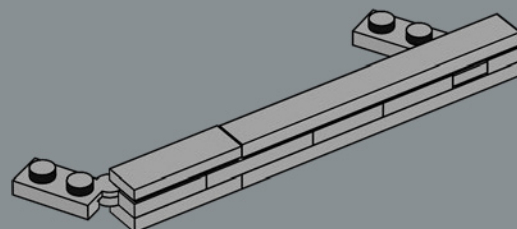

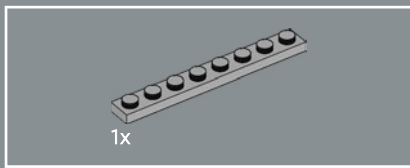

436

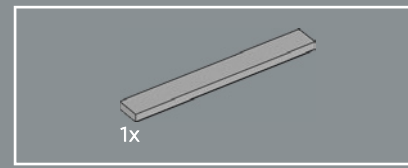
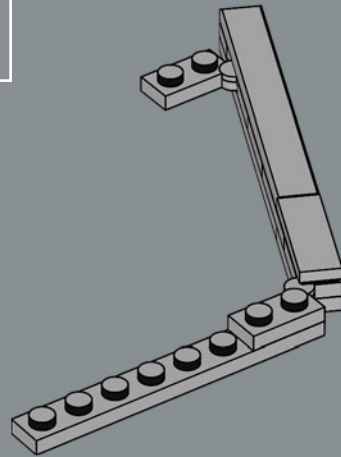

438

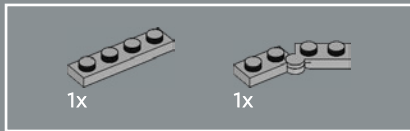
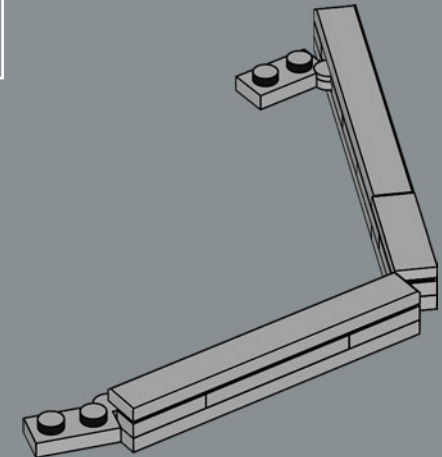

437

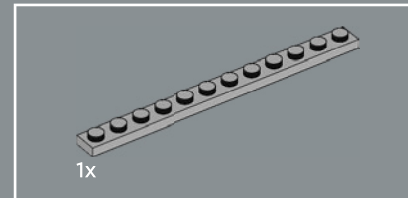
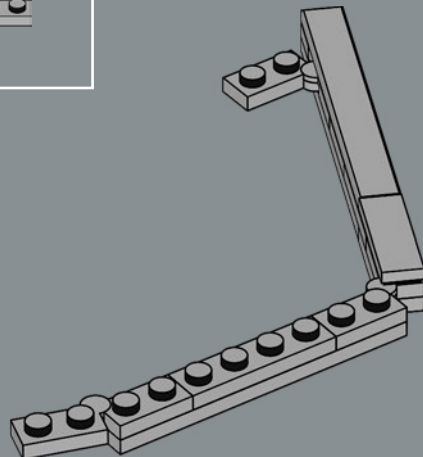

439

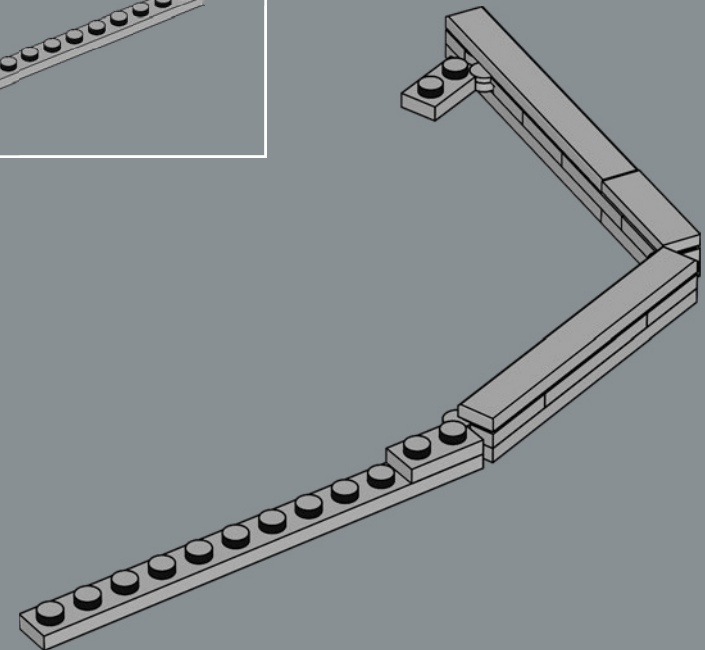

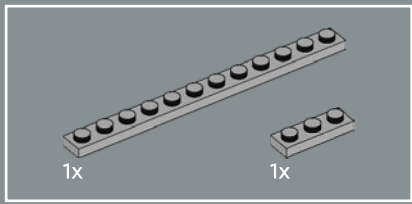

440

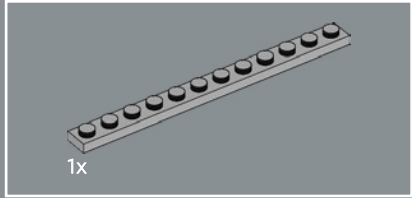
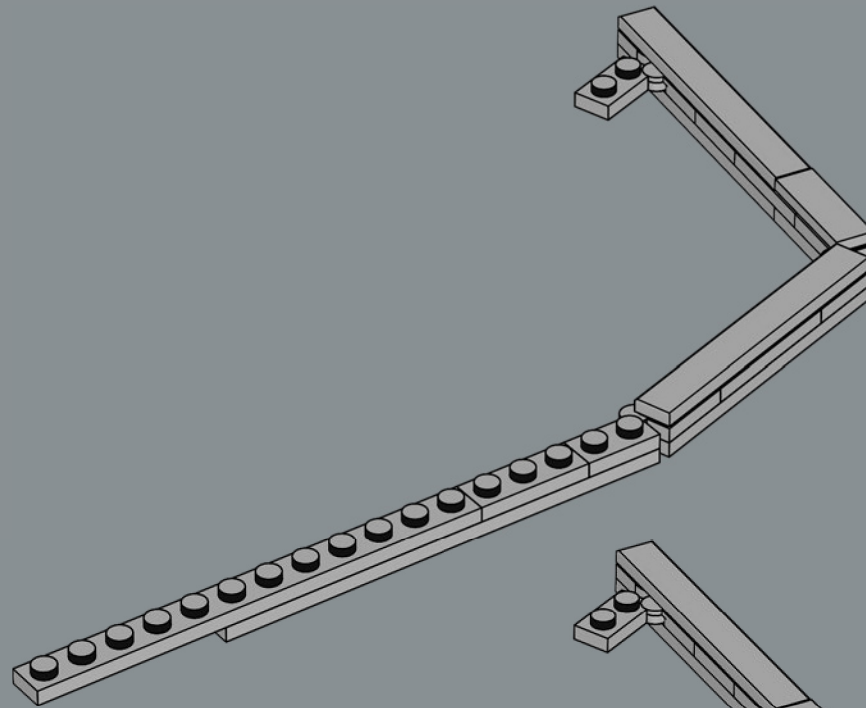

441

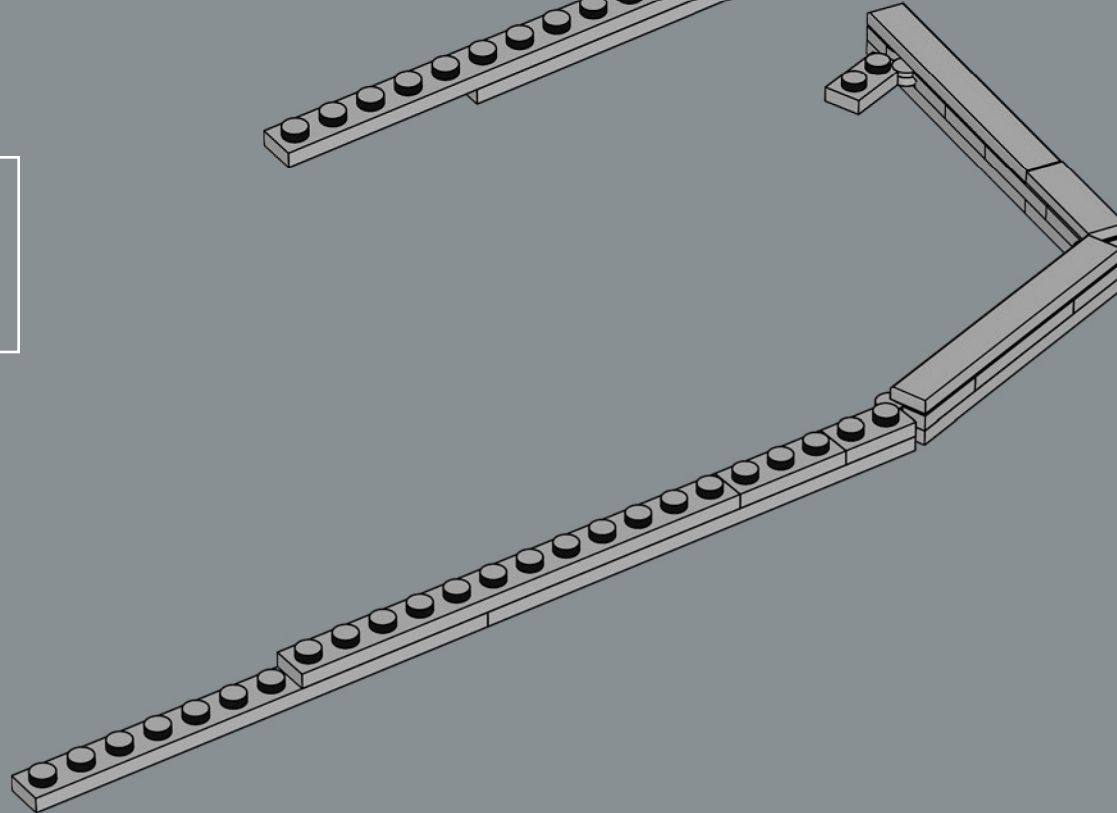



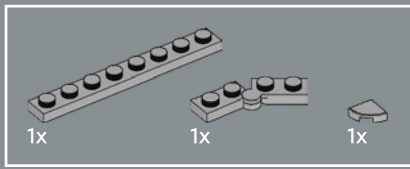

442

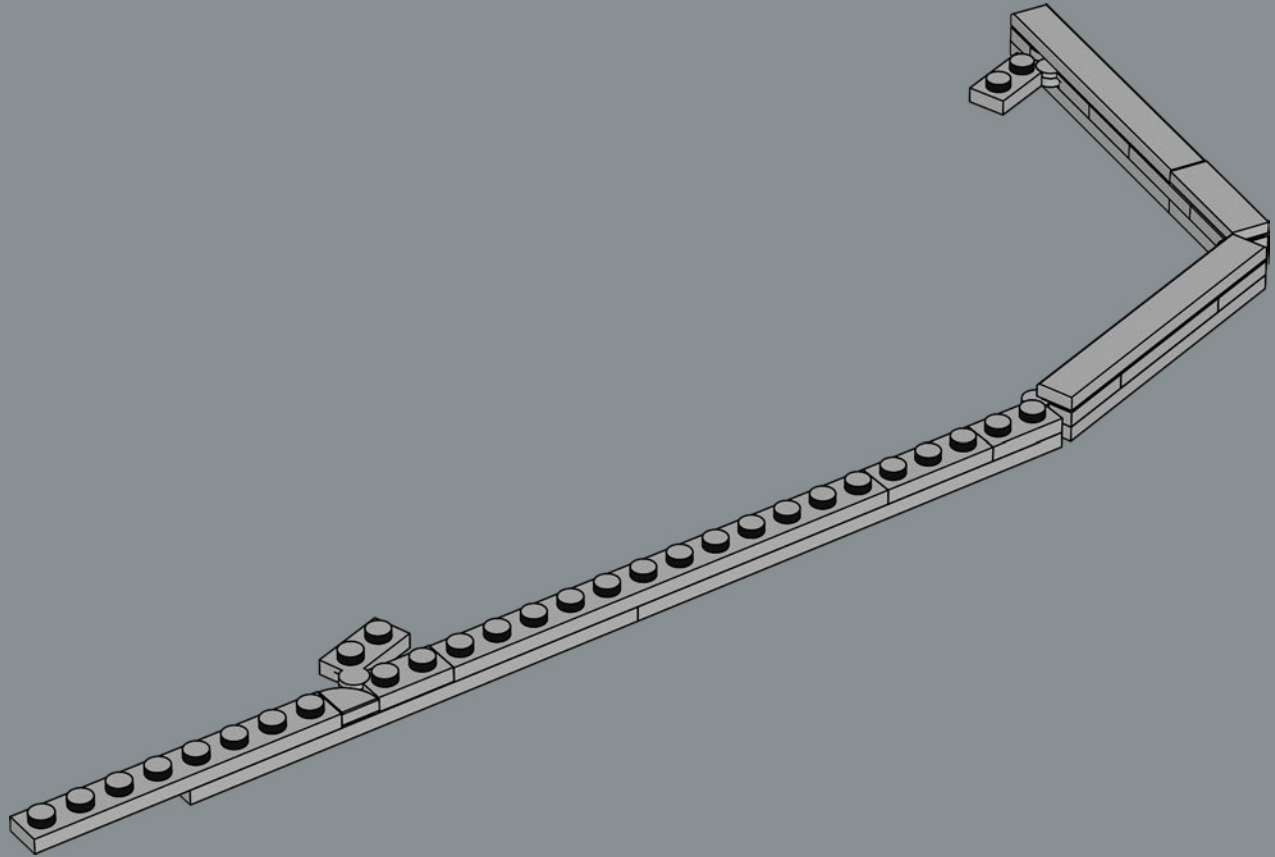

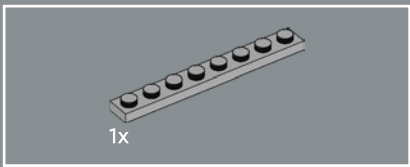

443

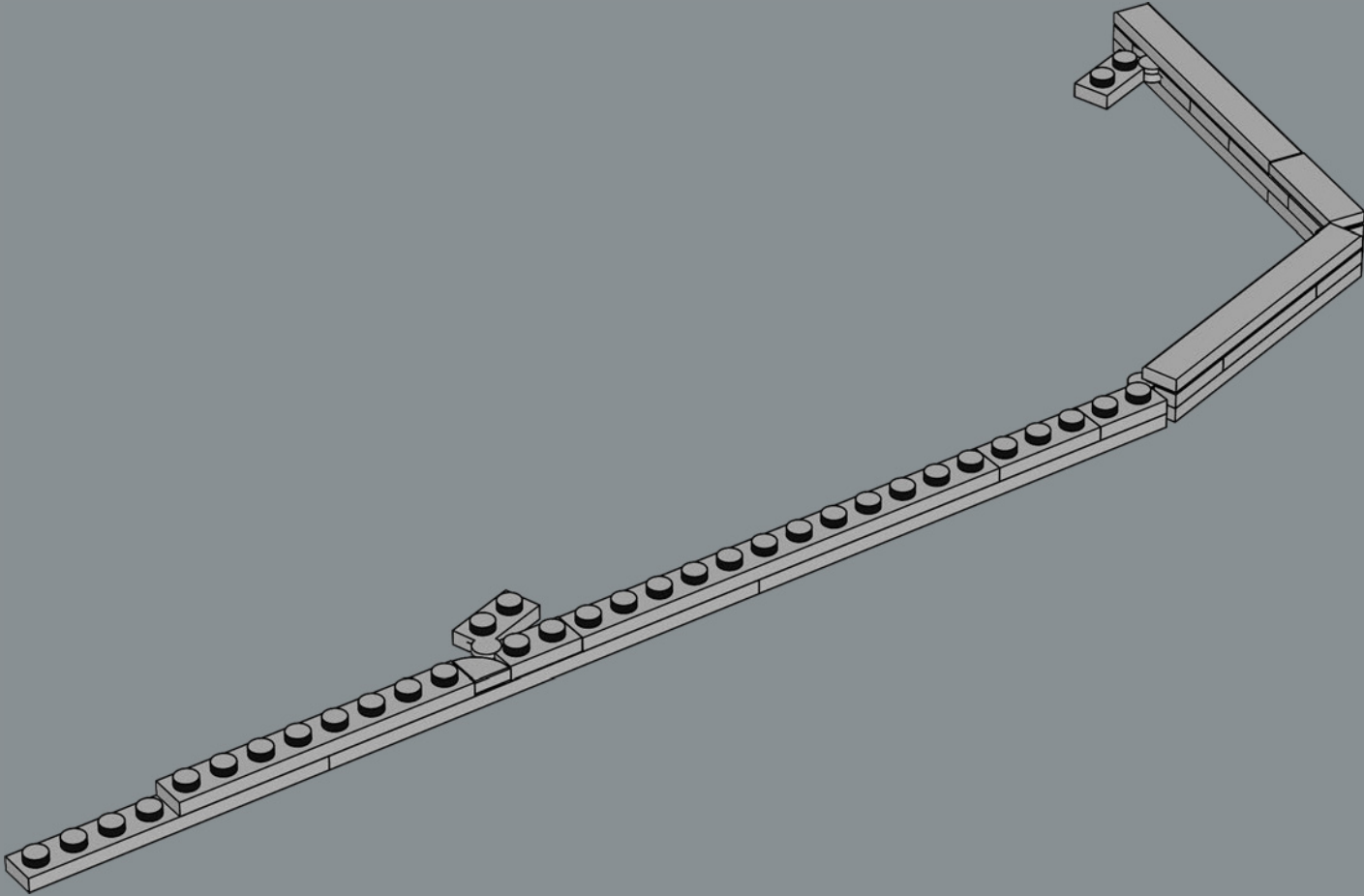

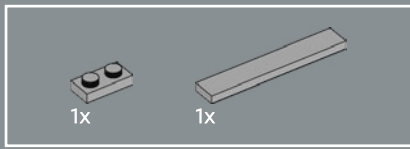

444

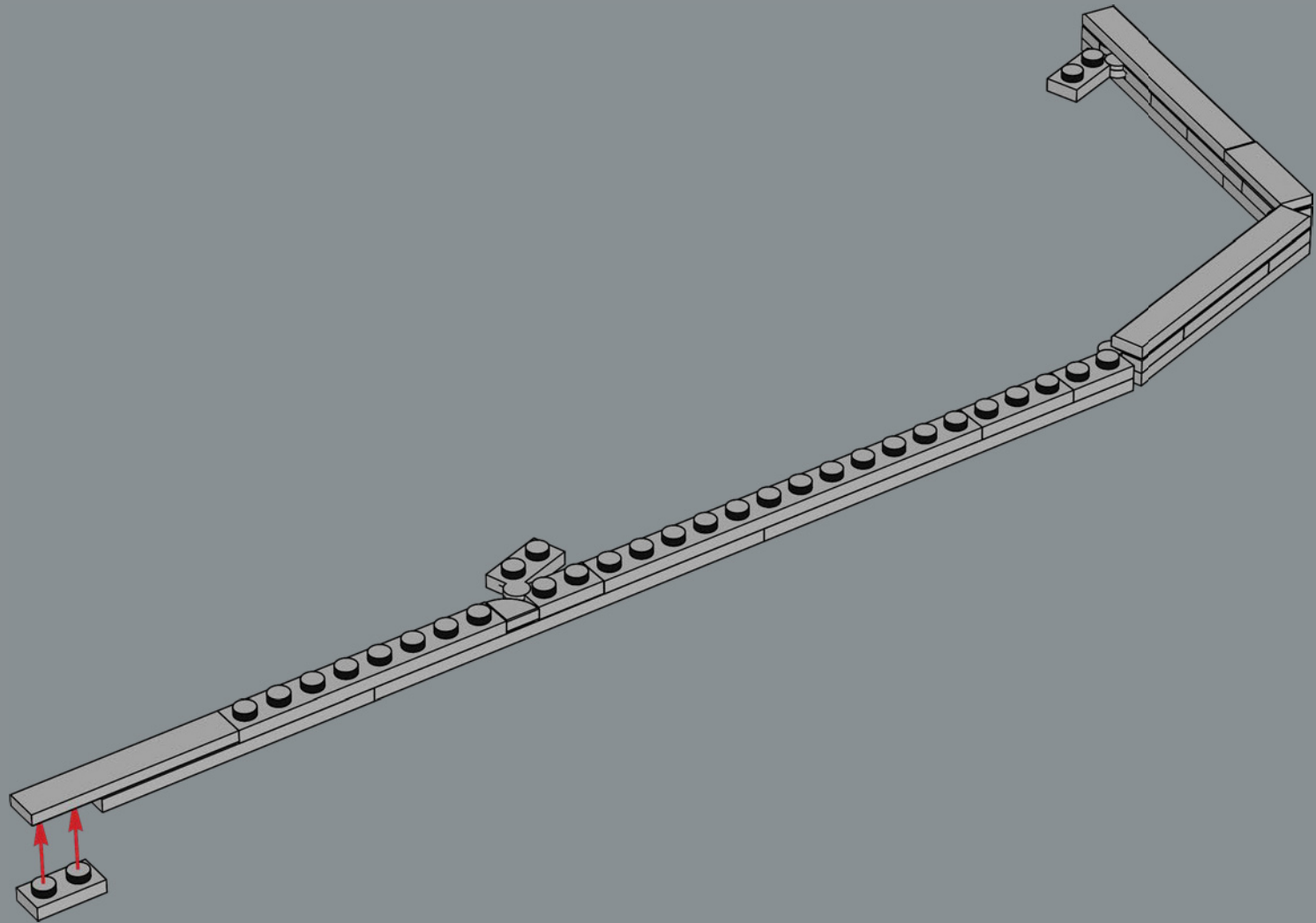

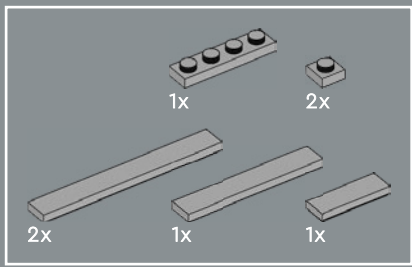

445

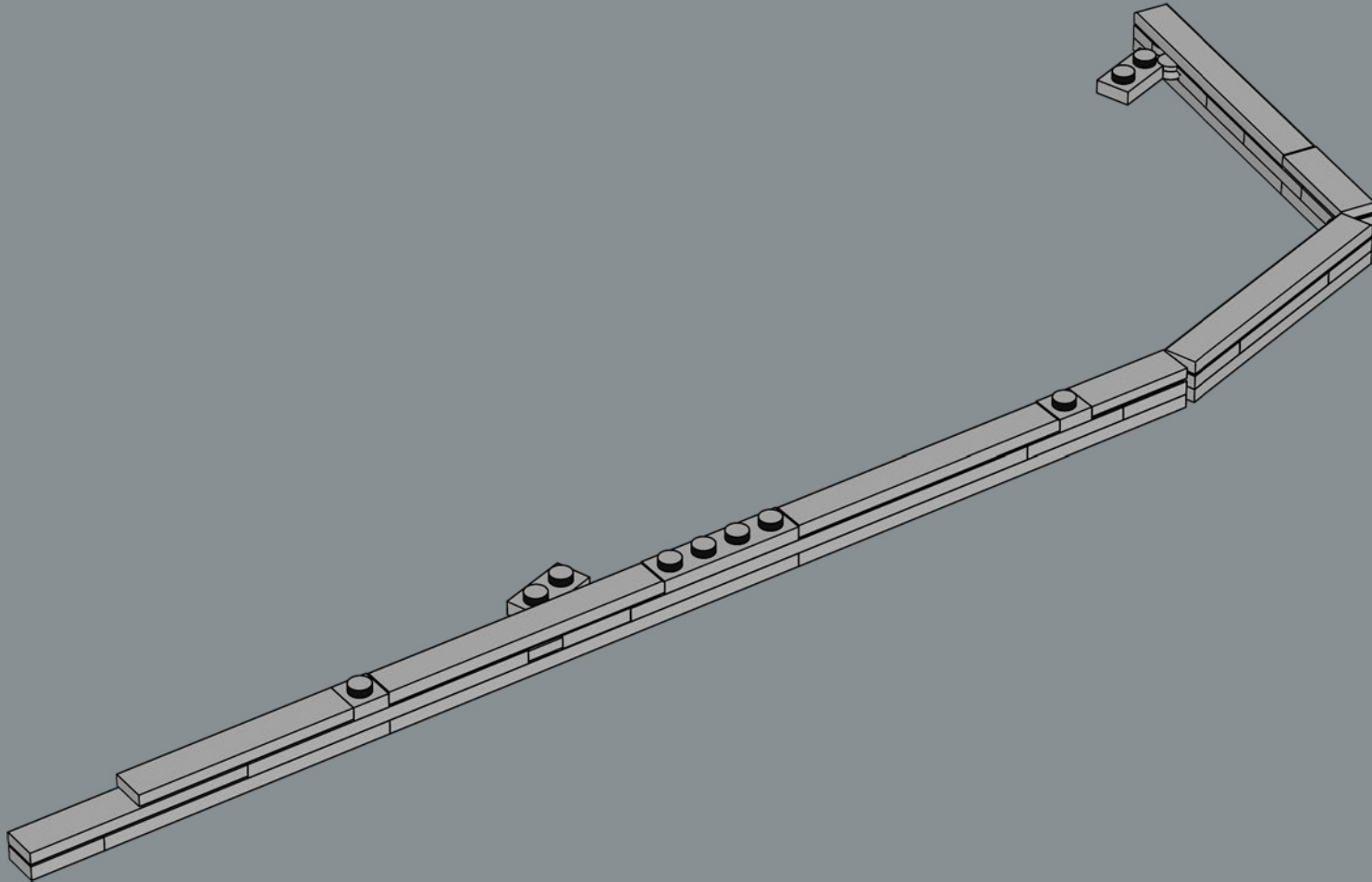



446

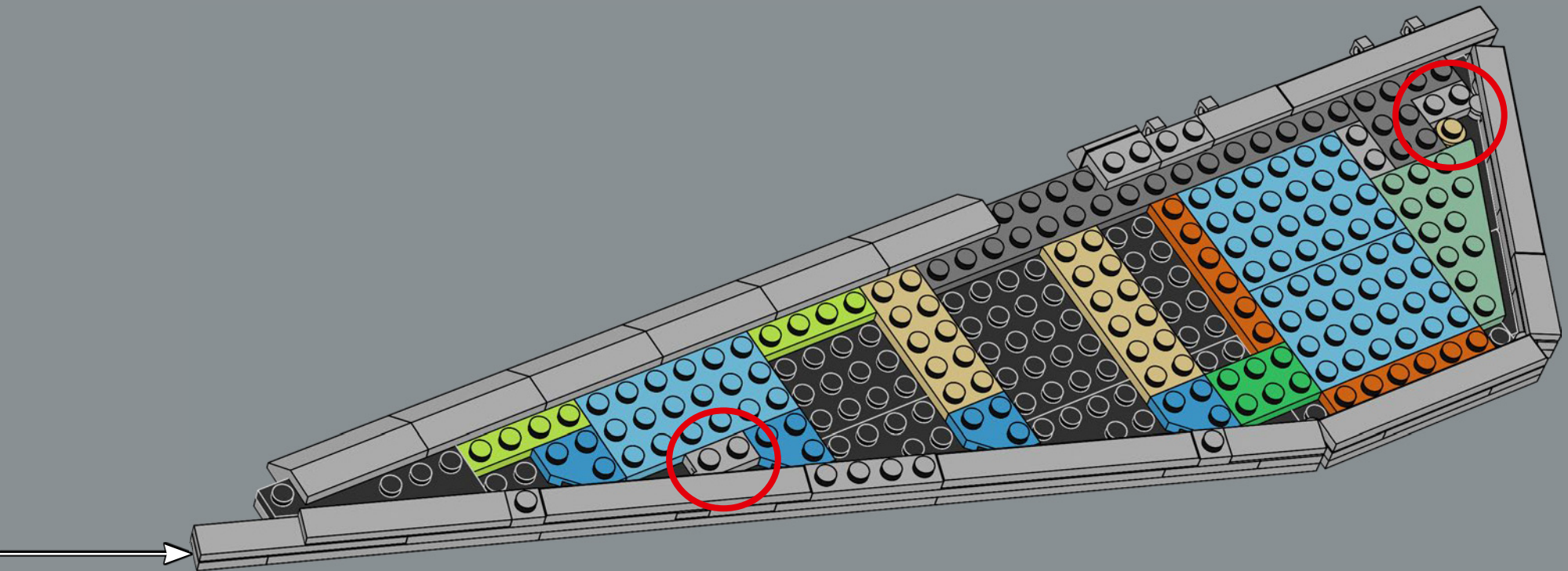

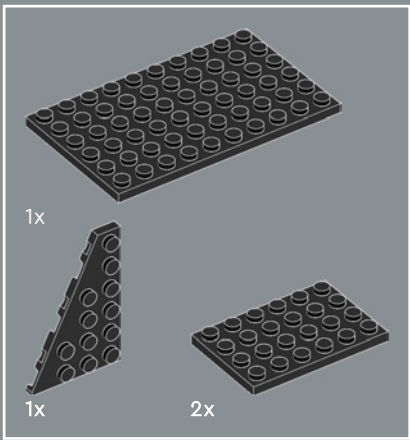

447

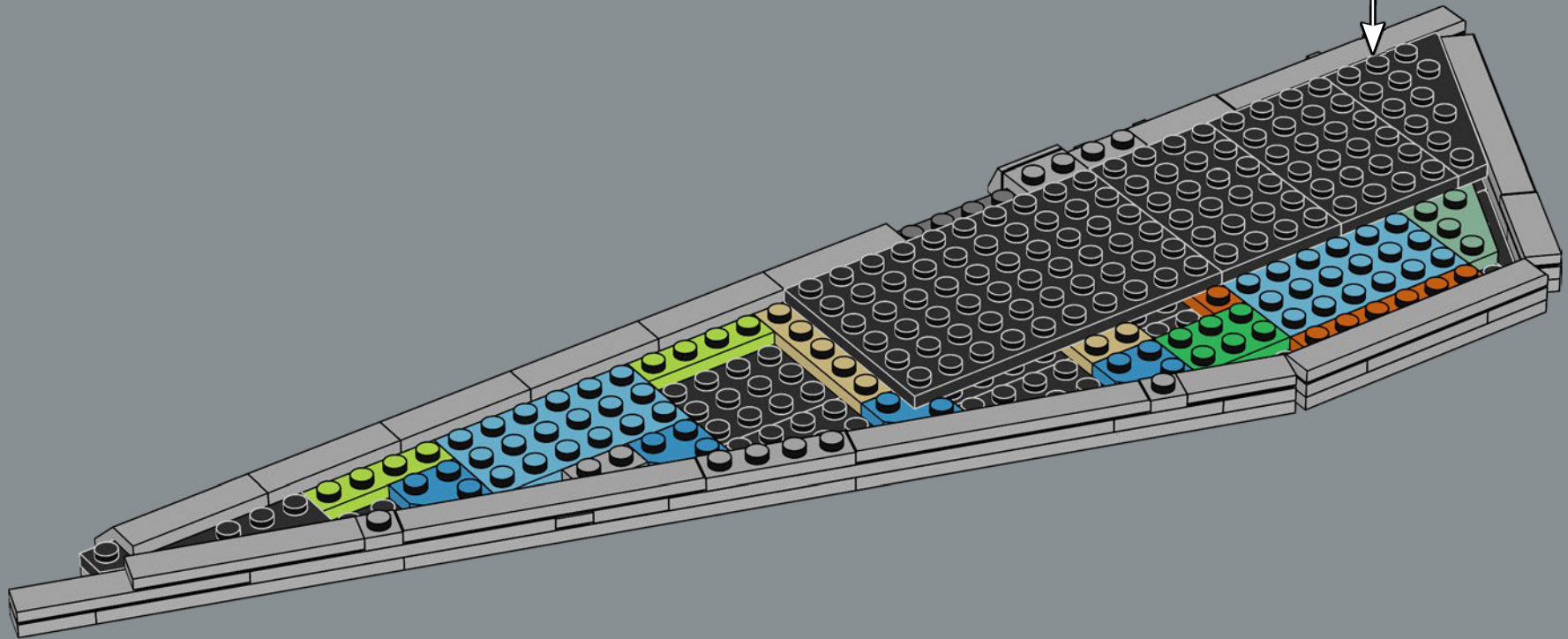
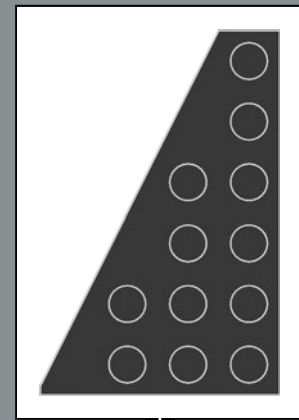

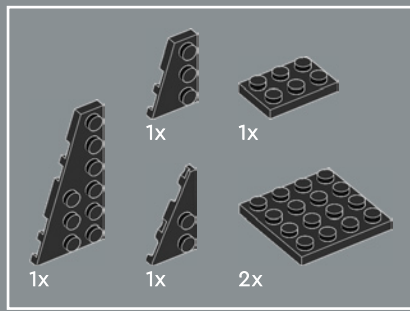

448

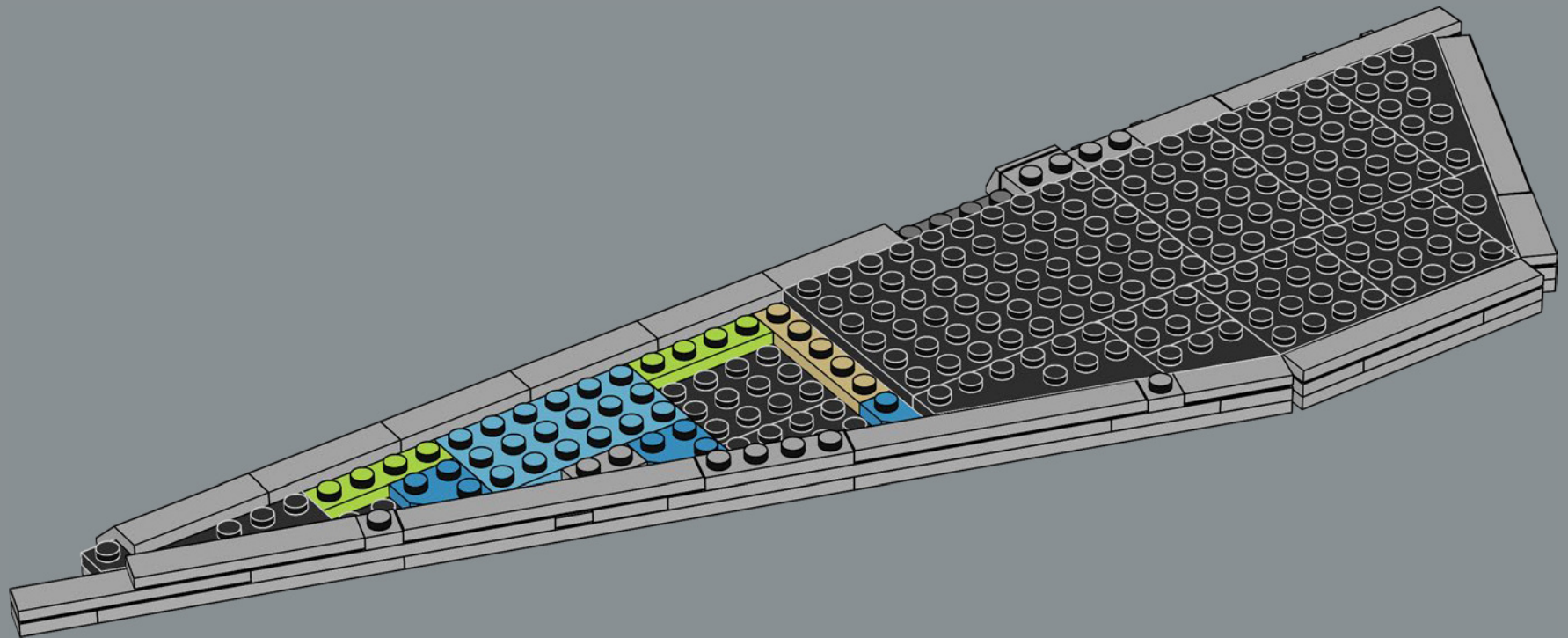

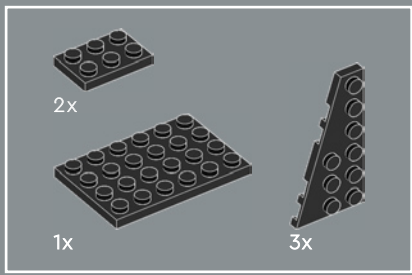

449

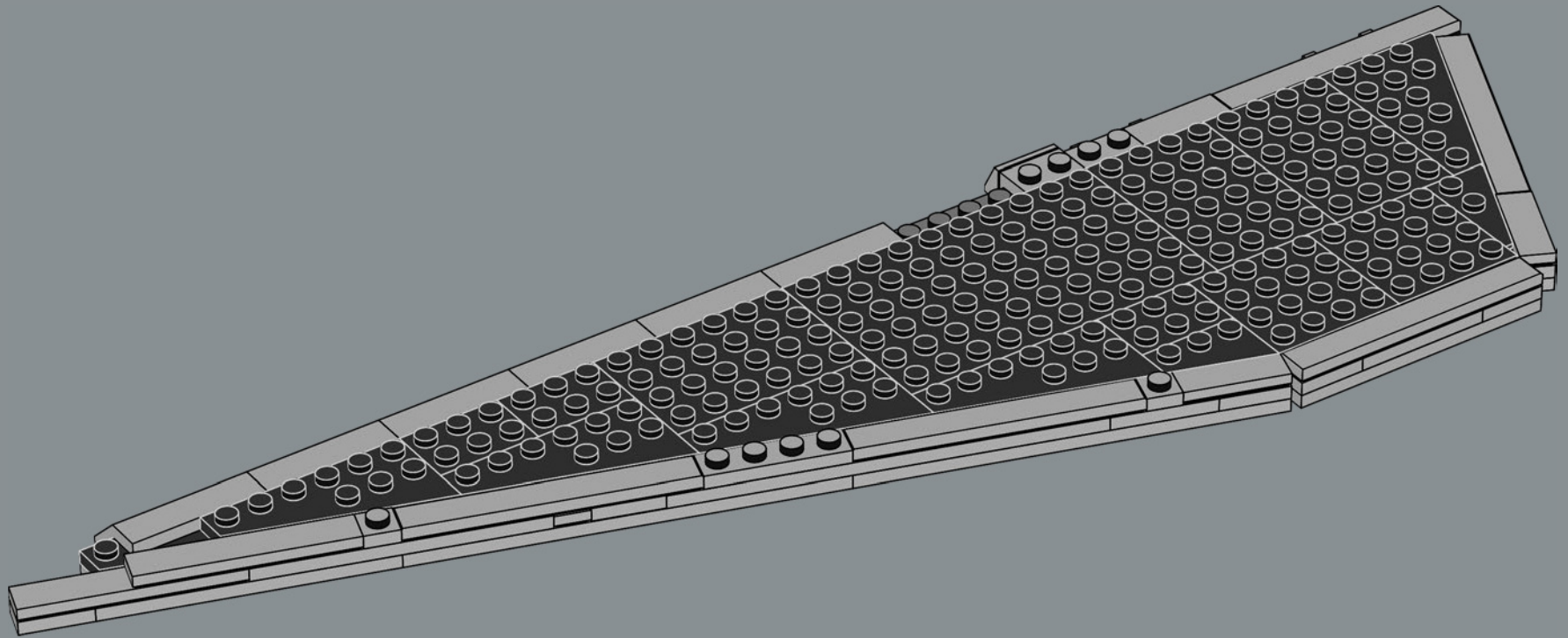



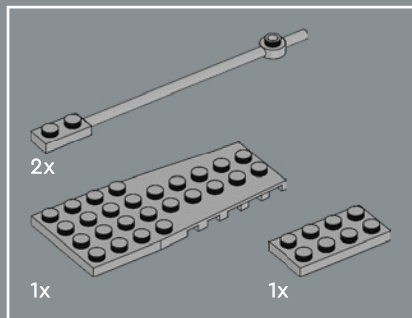

450

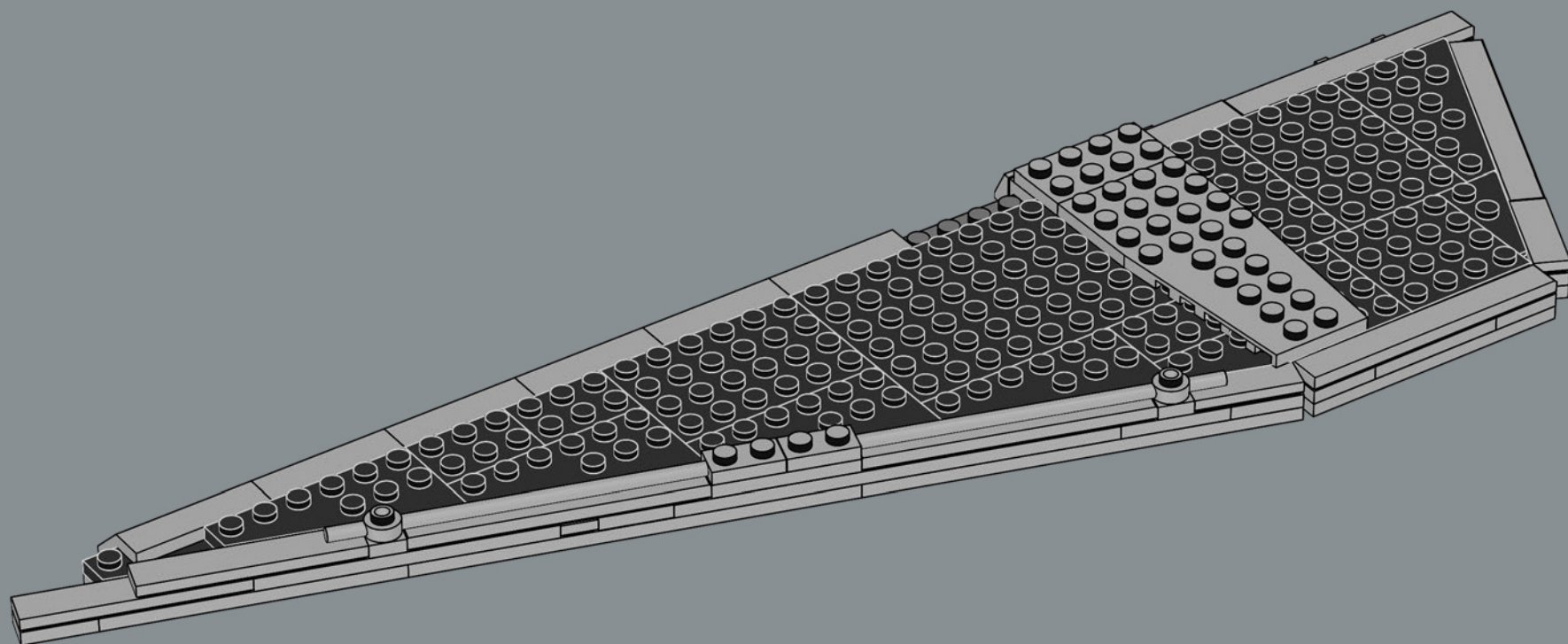



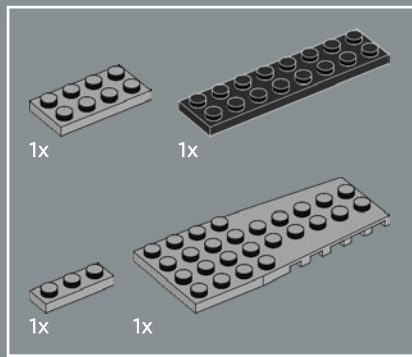

452

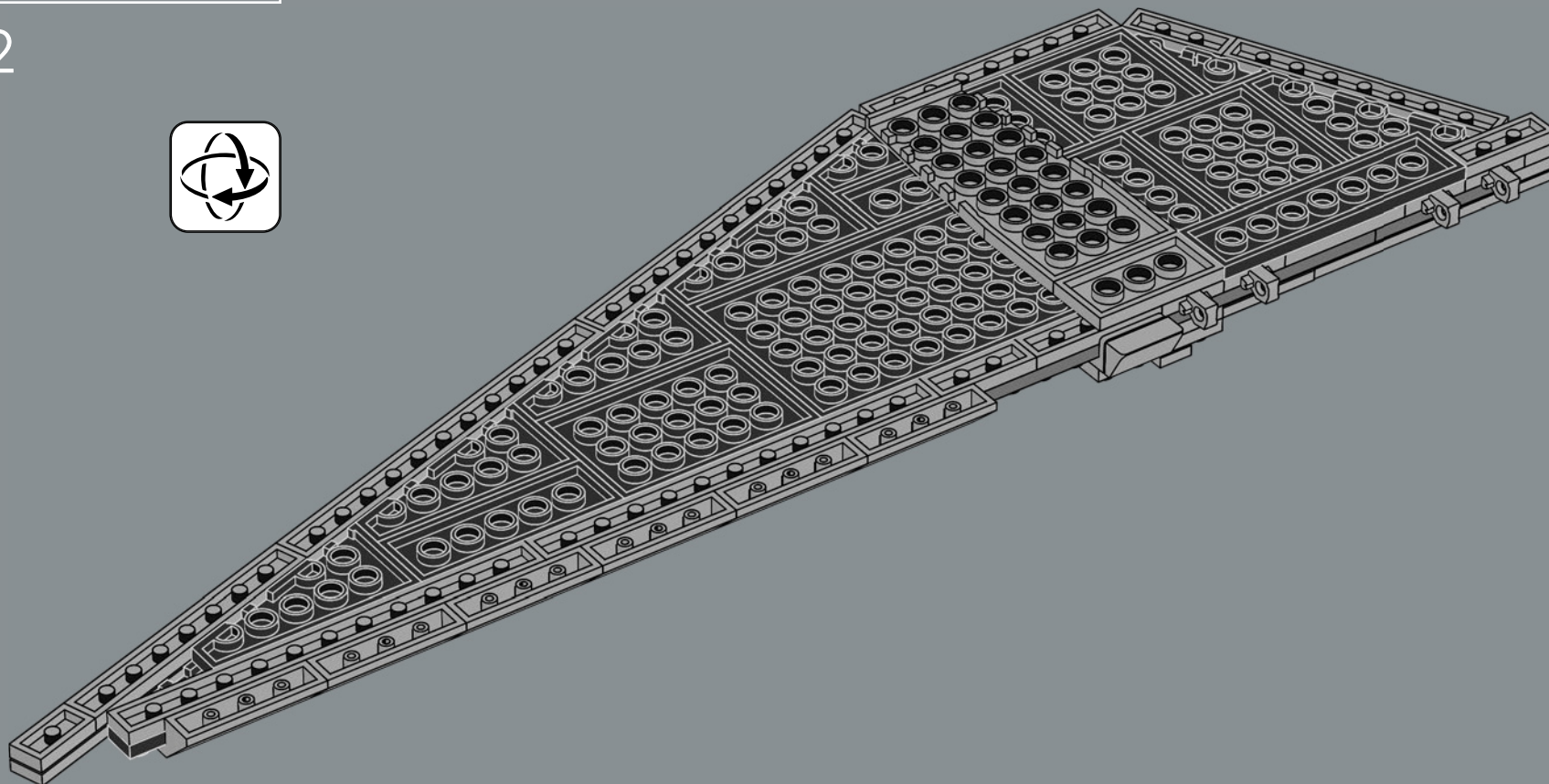

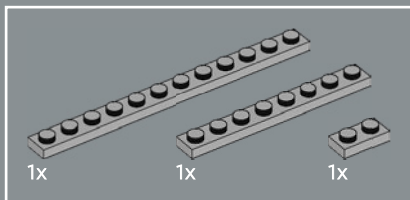

453

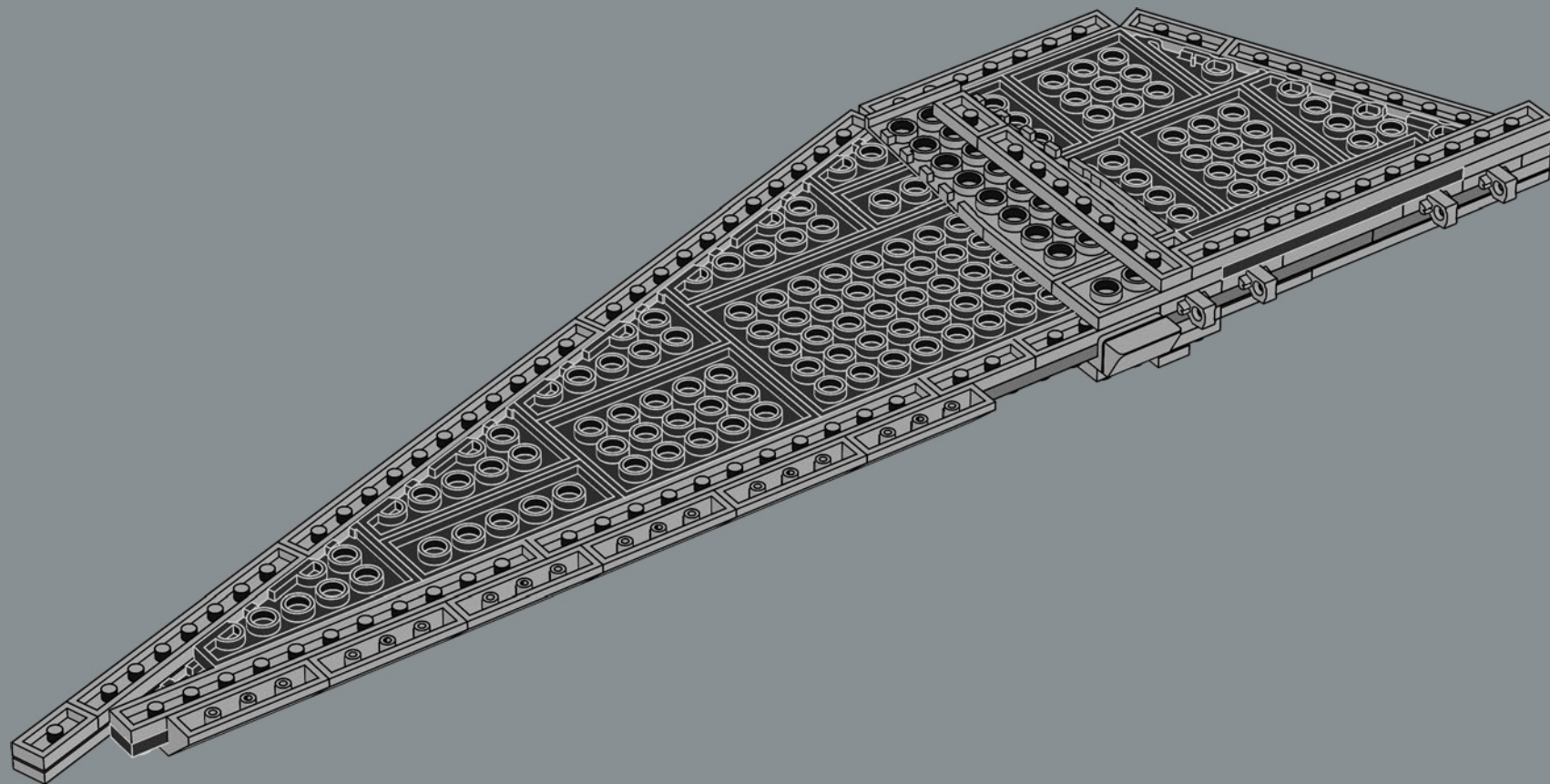



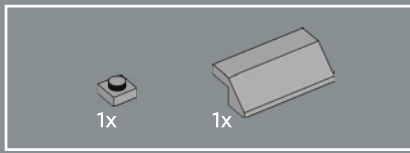

454

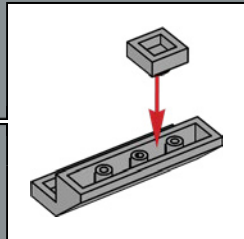
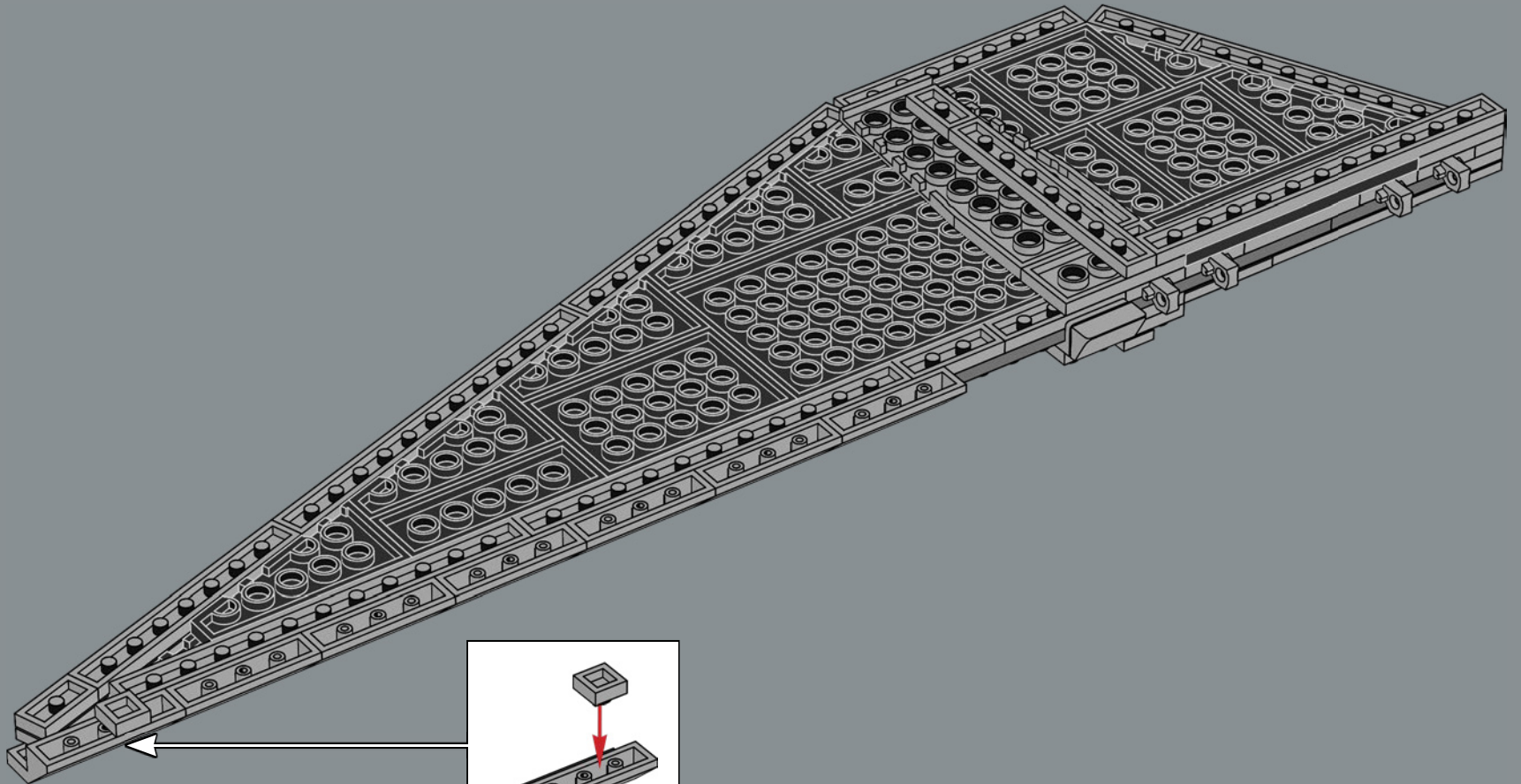

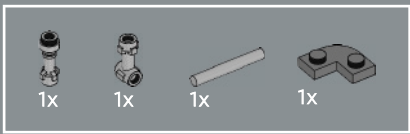

455

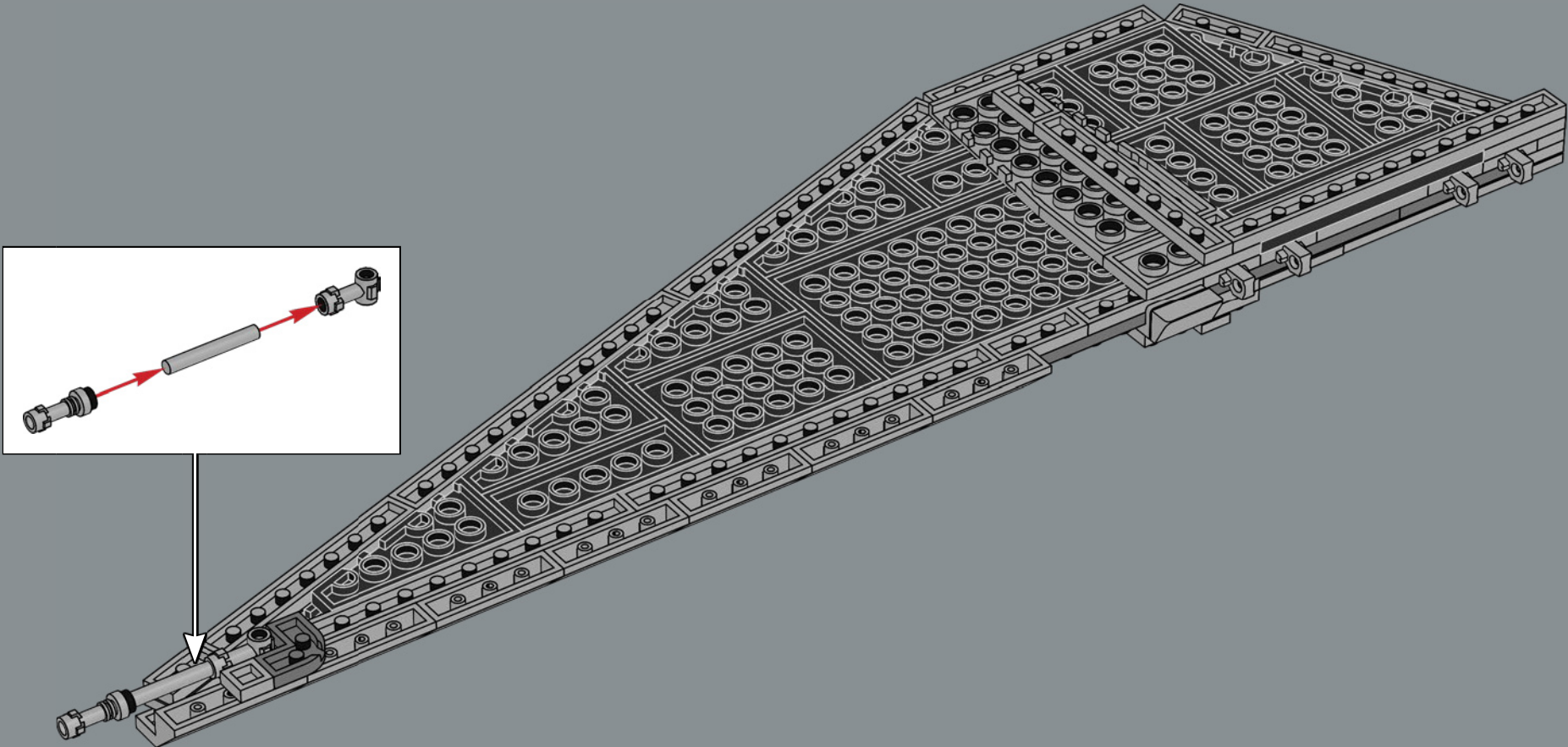



456

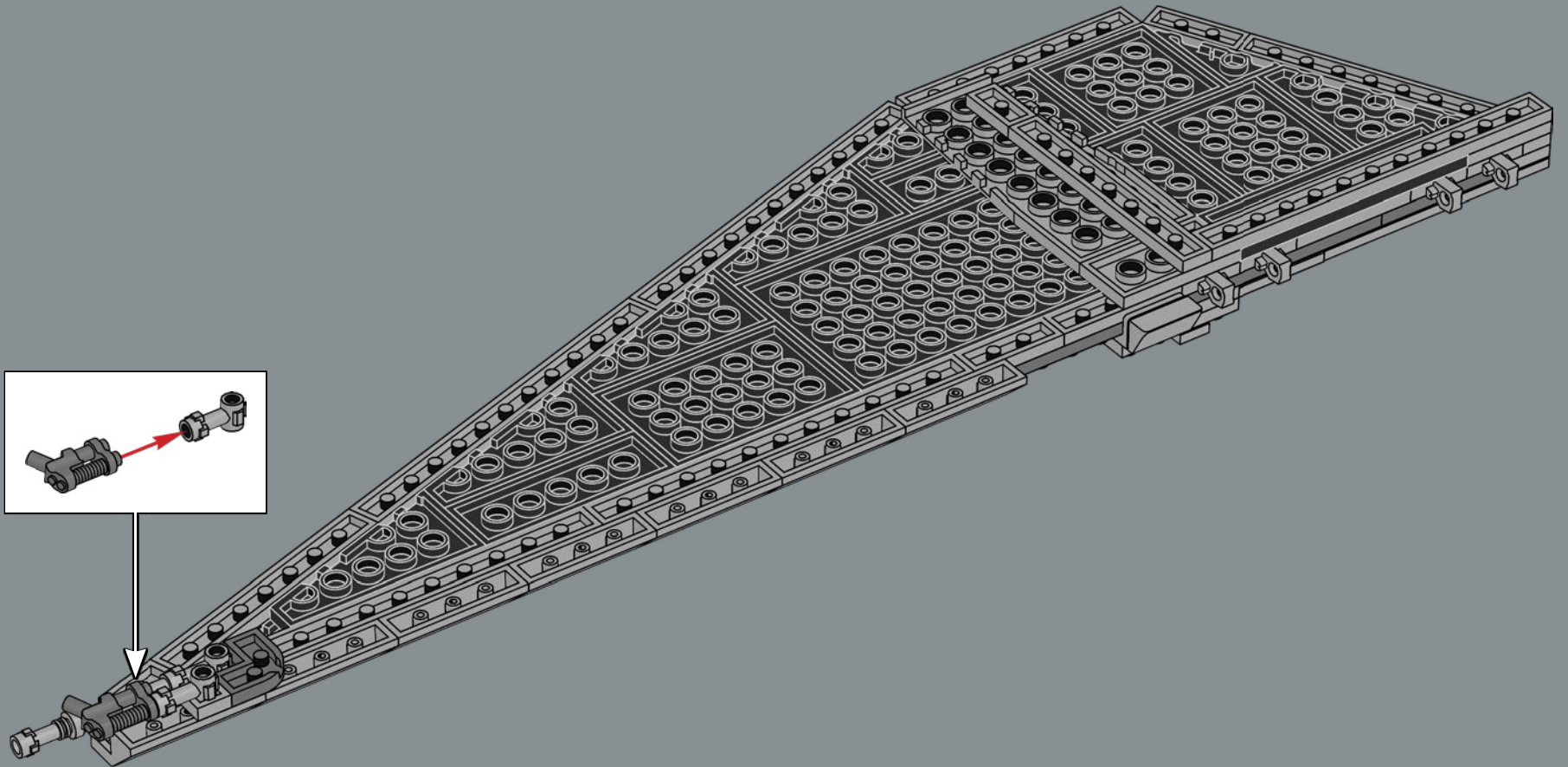



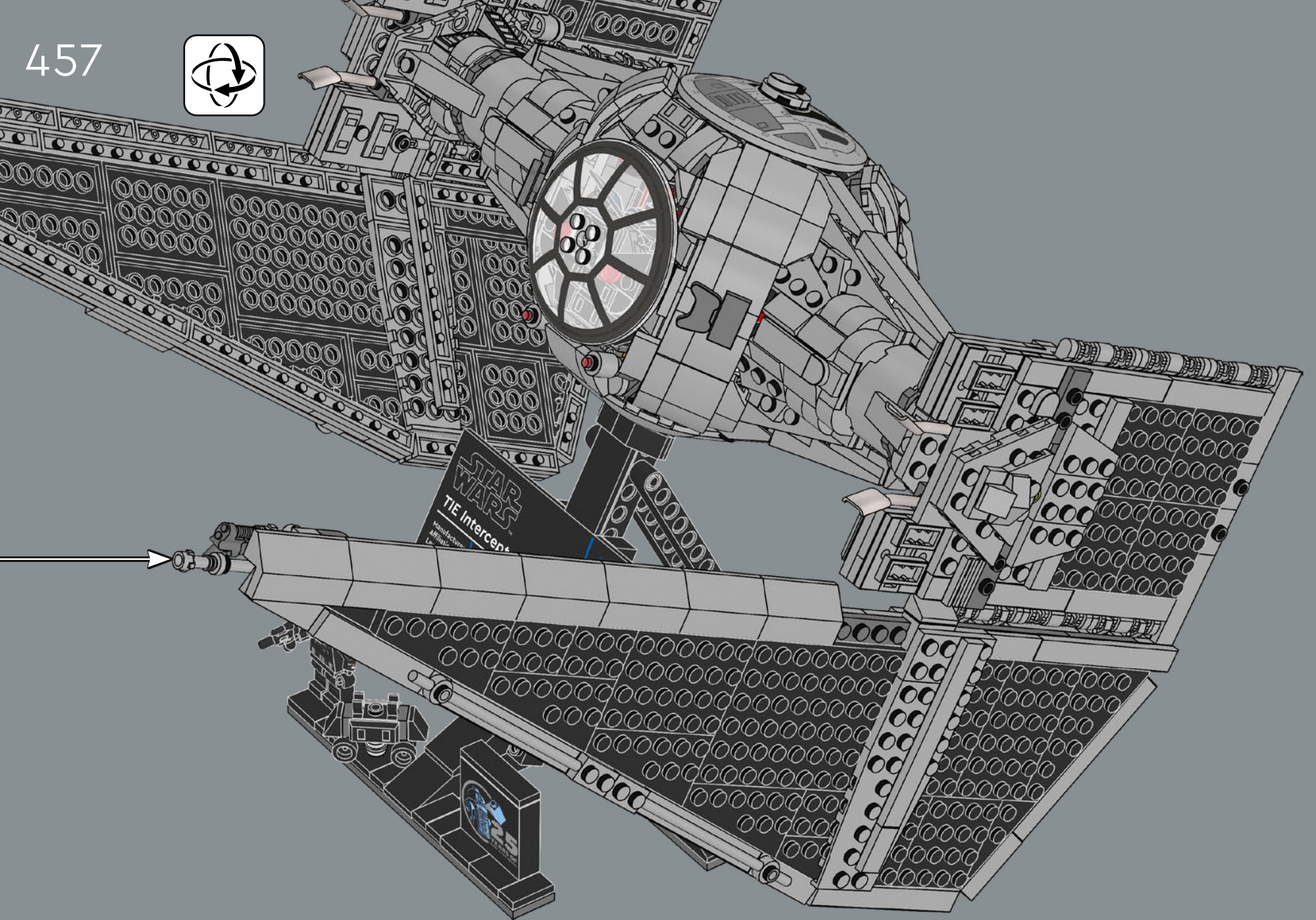



458

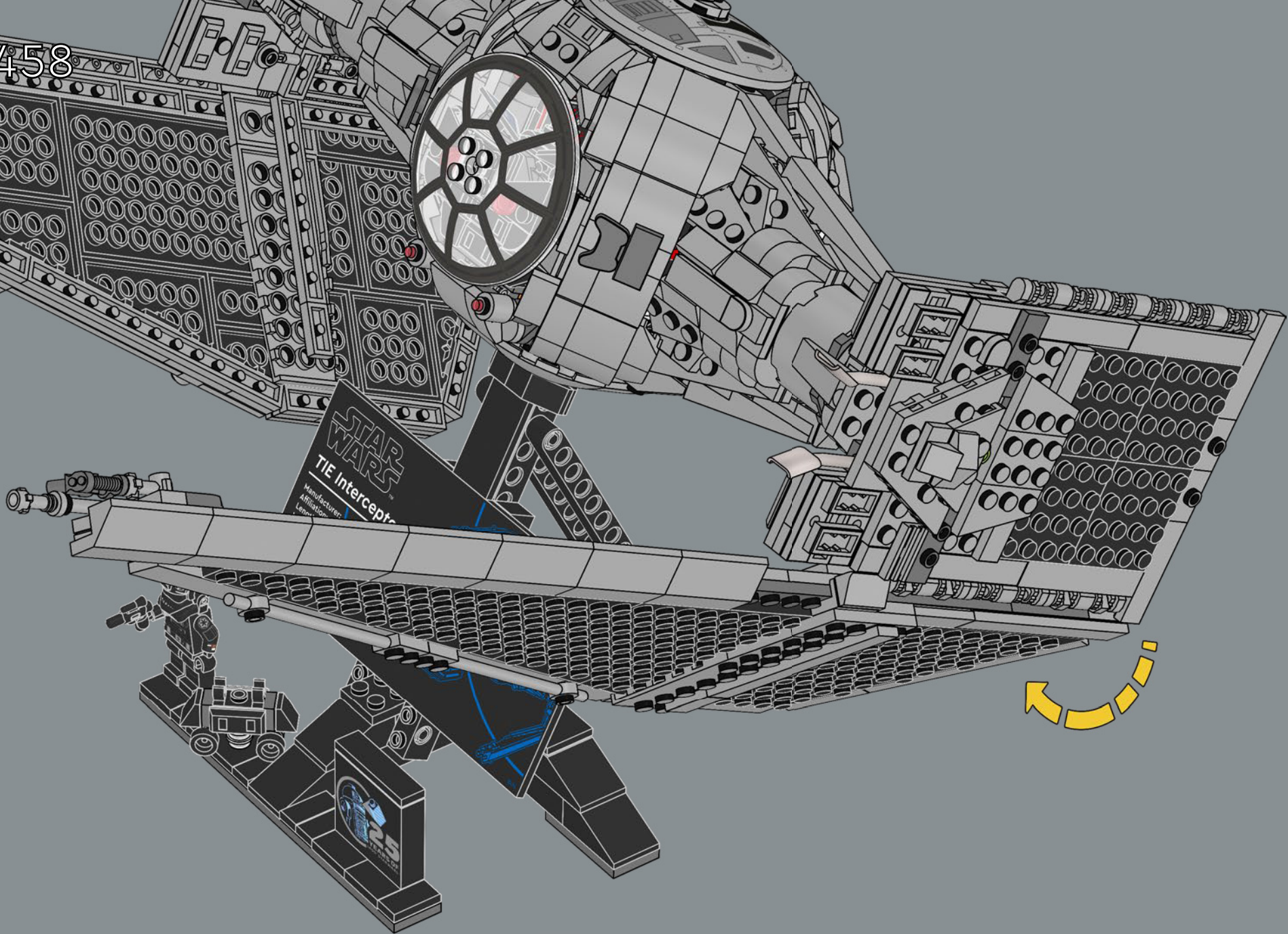



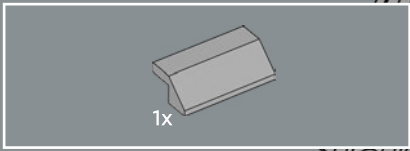

459

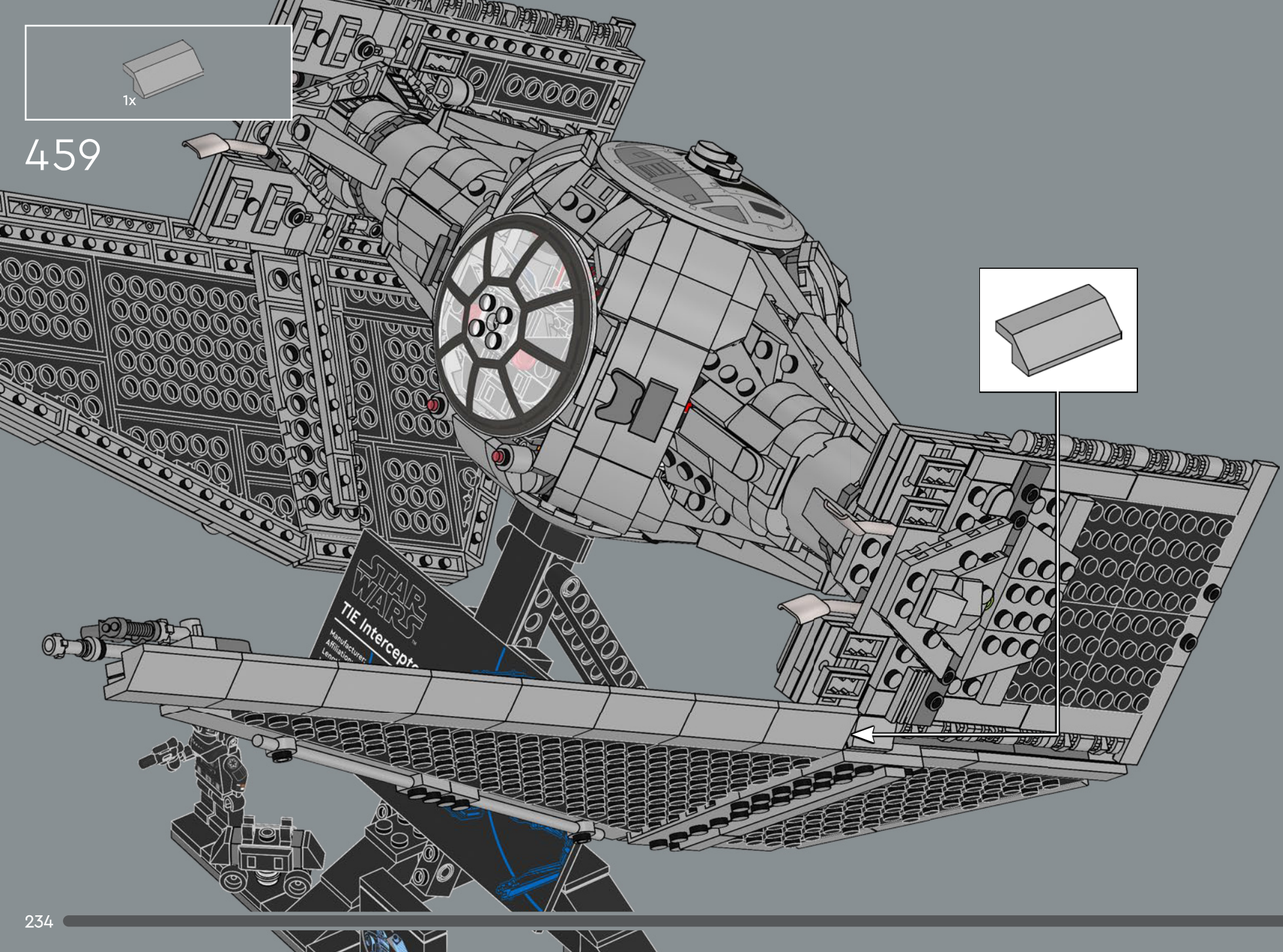
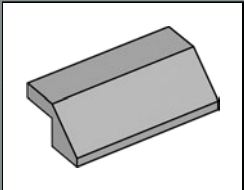

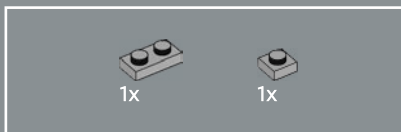
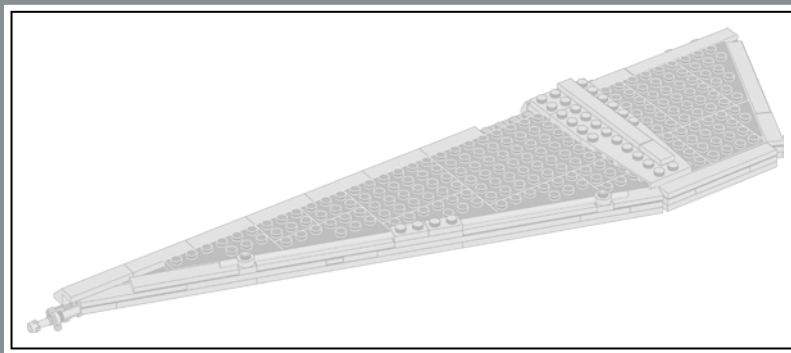

460

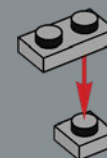



1x

461

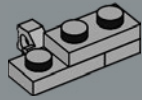

1x

462

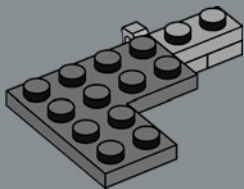

1x



1x

463

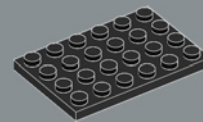
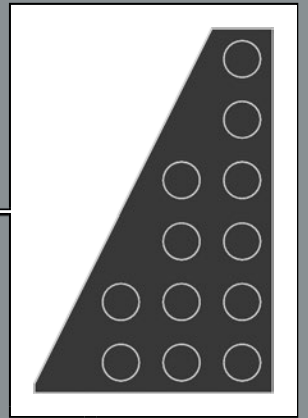
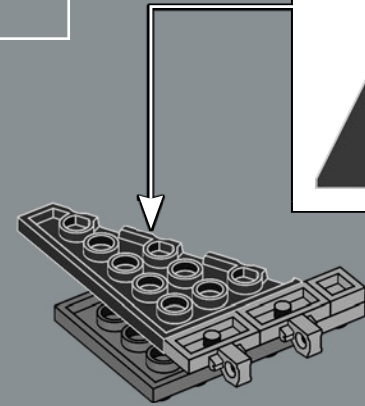

1x

464

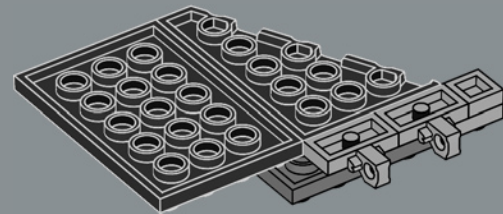



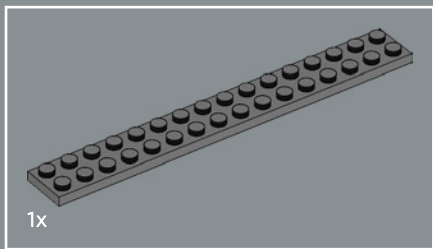

465

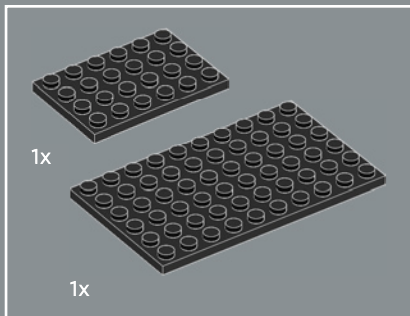
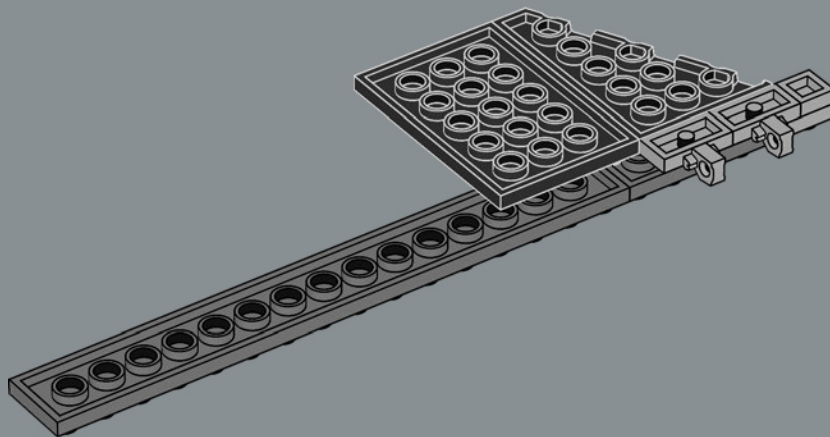

466

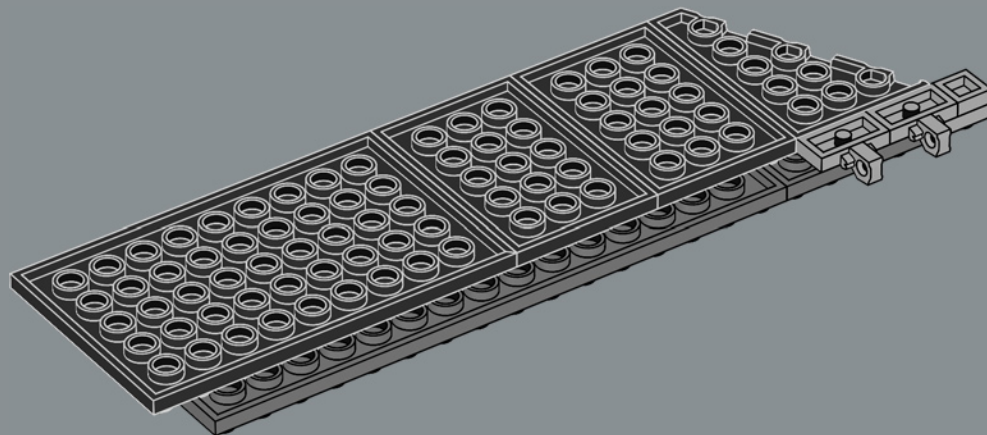

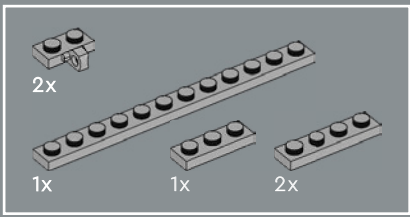

467

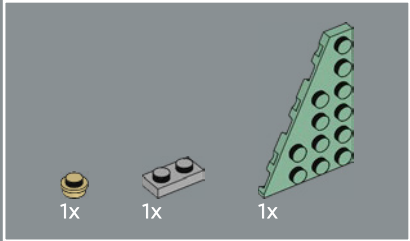
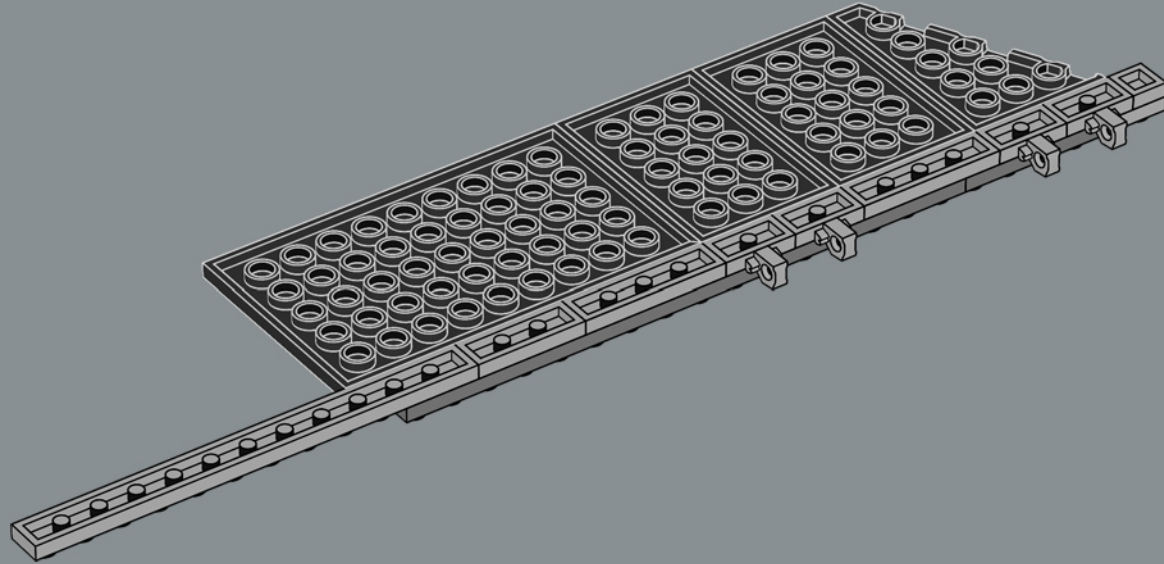

468

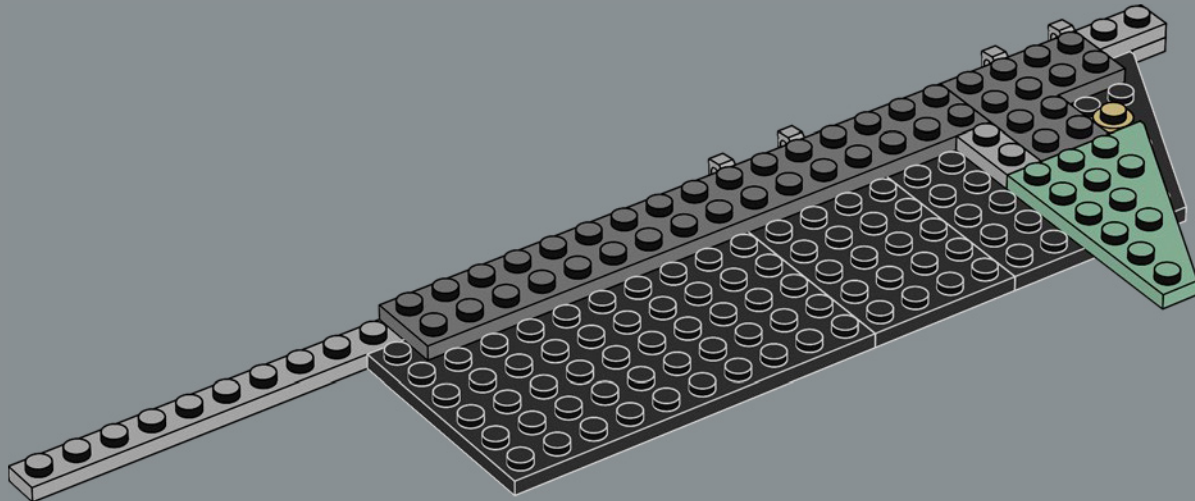

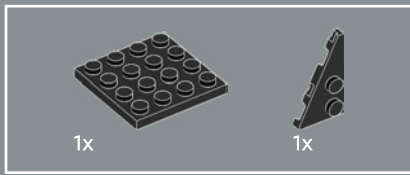

469

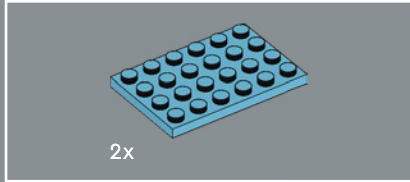
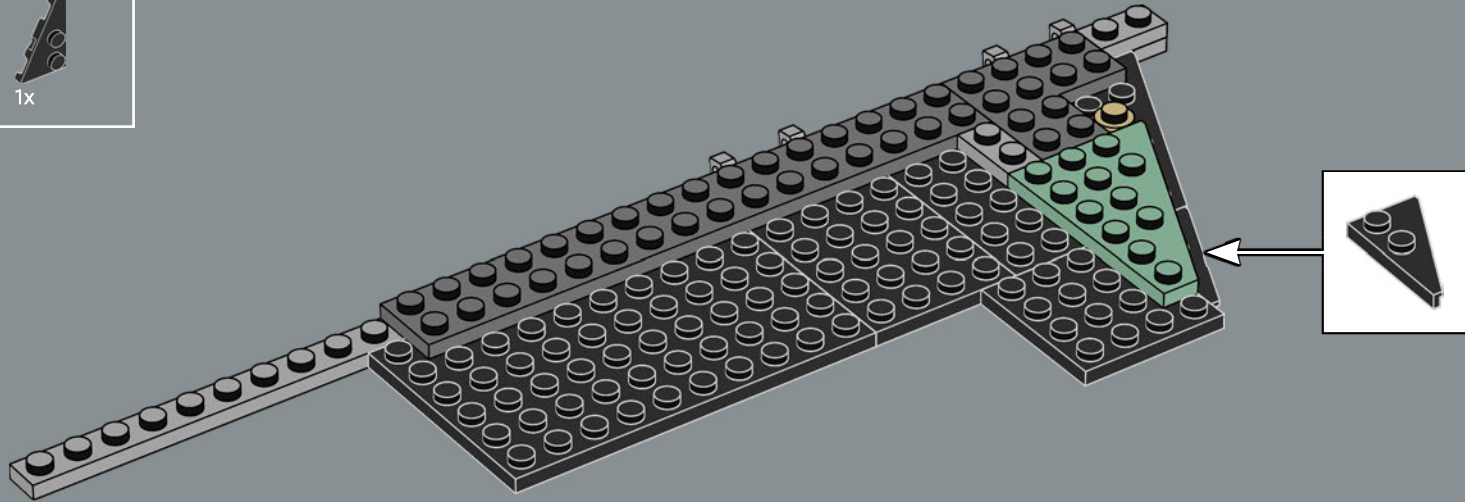

470

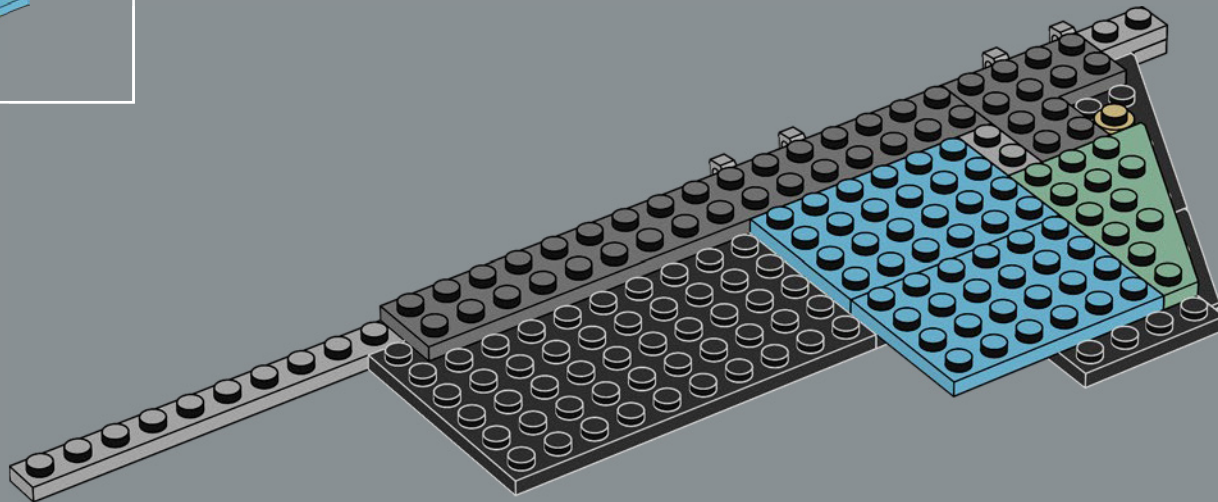

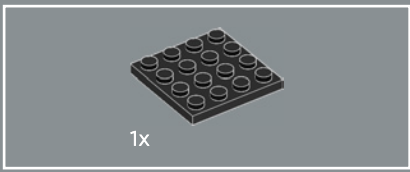

471

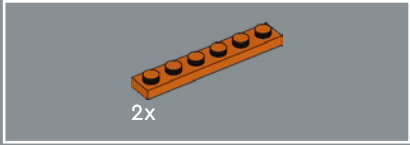
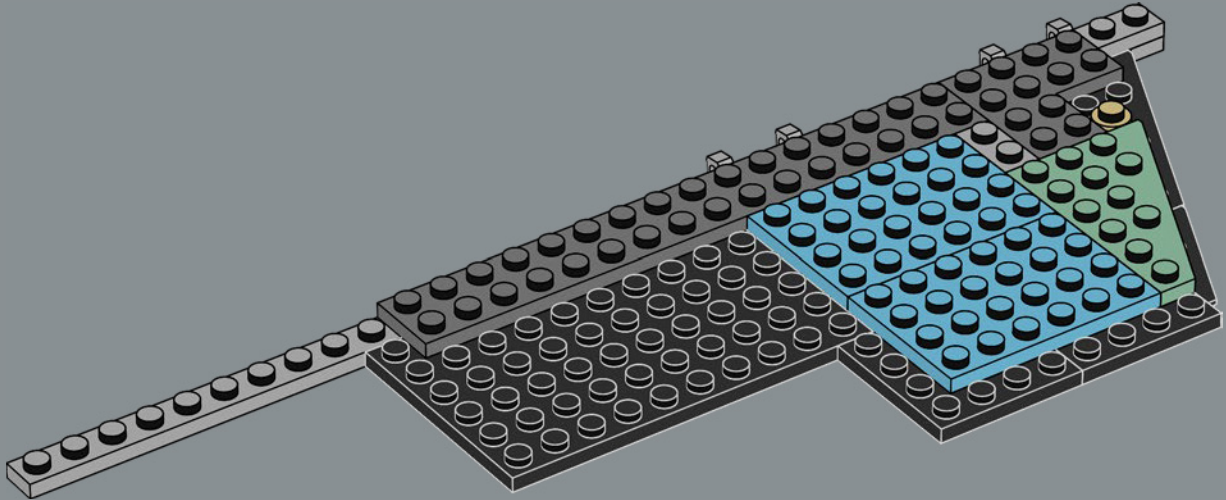

472

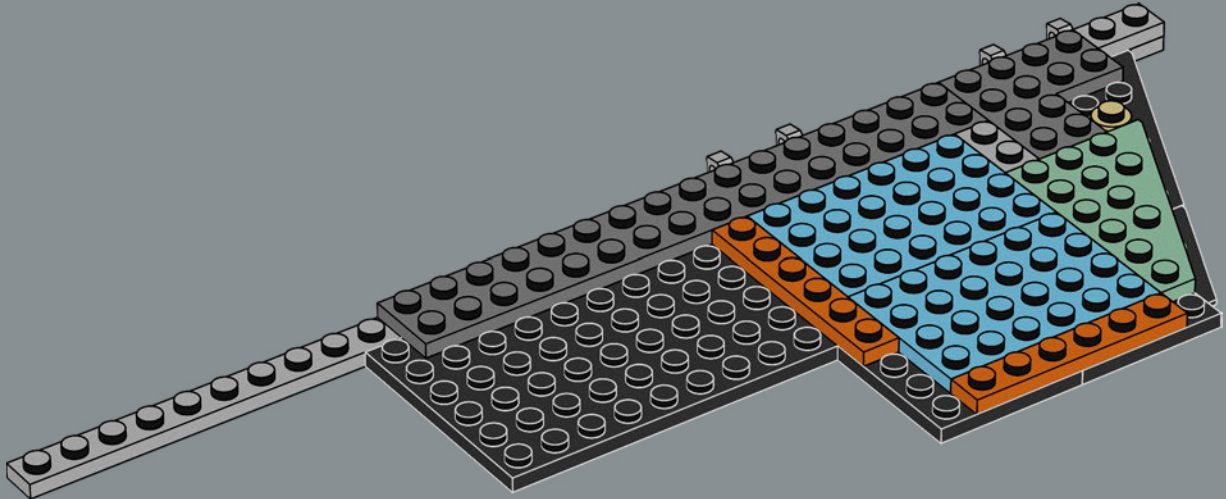



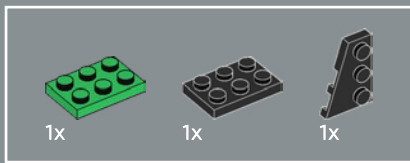

473

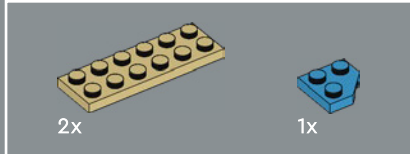
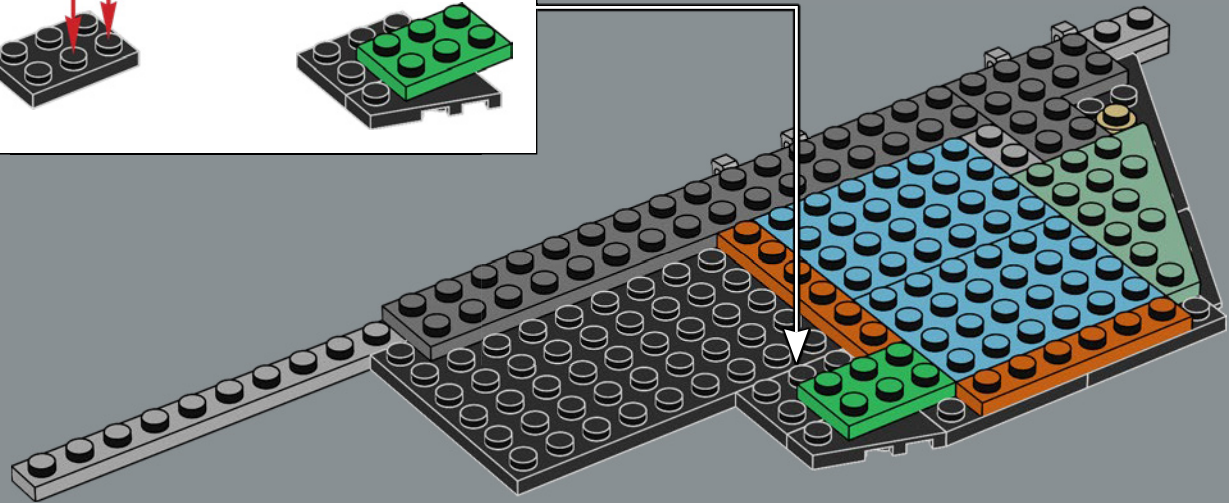
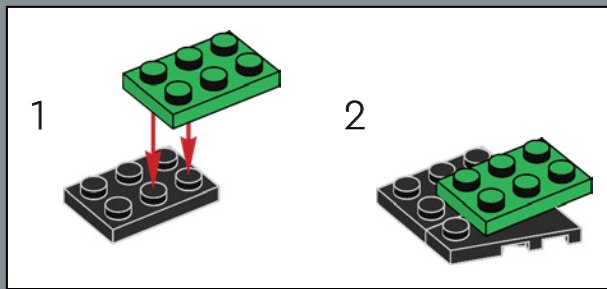

474

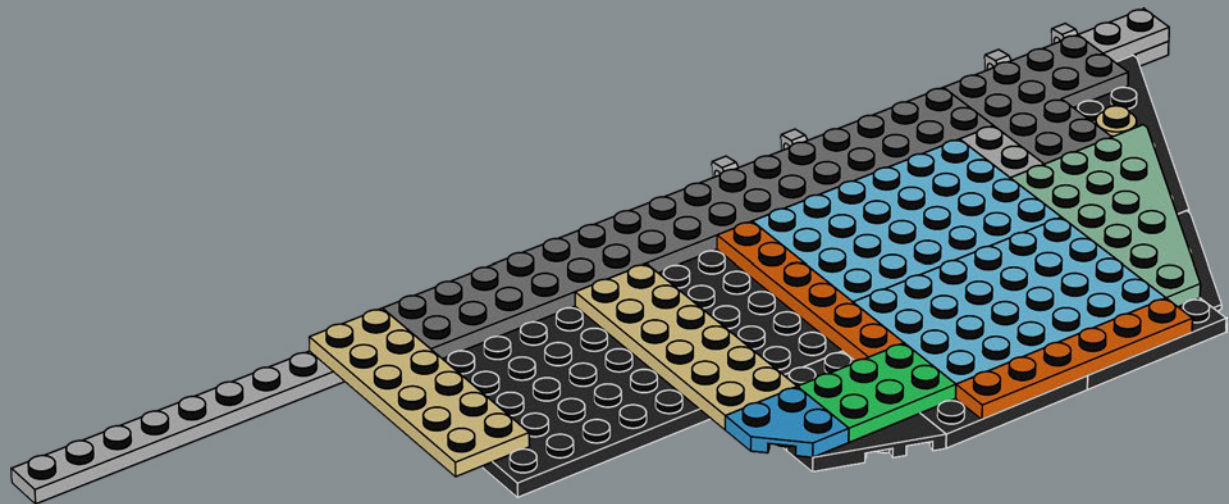

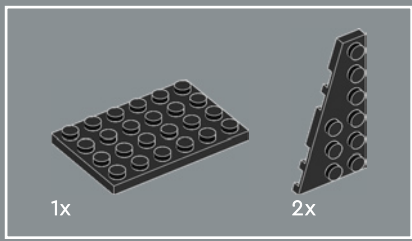

475

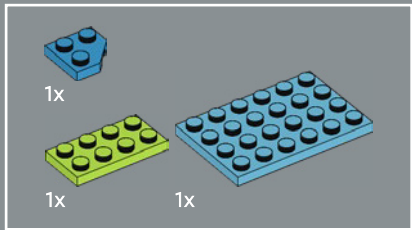
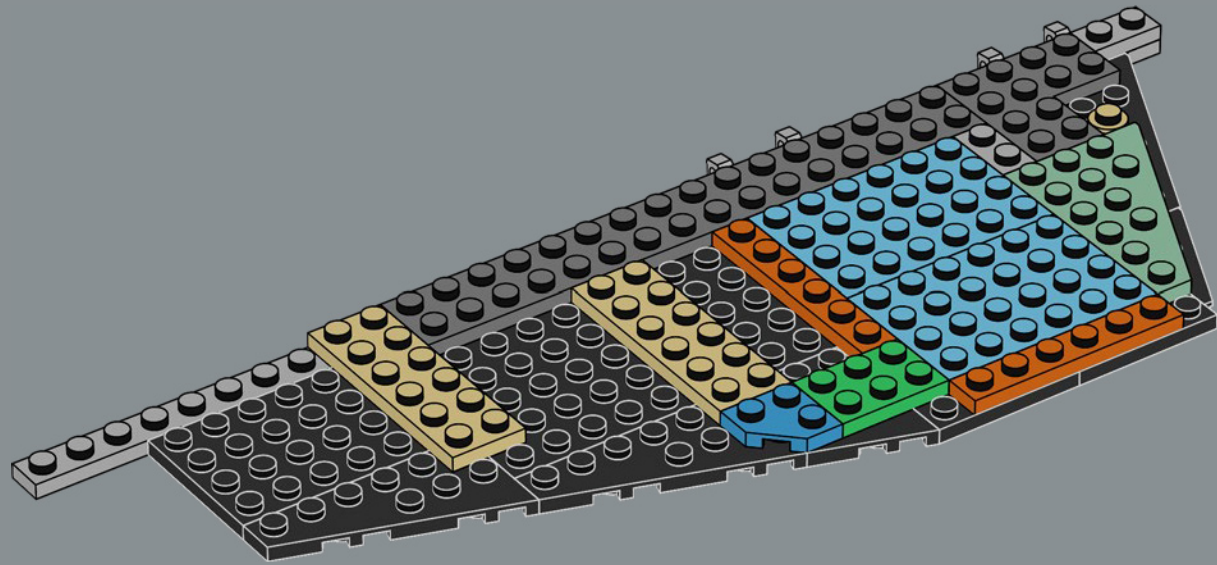

476

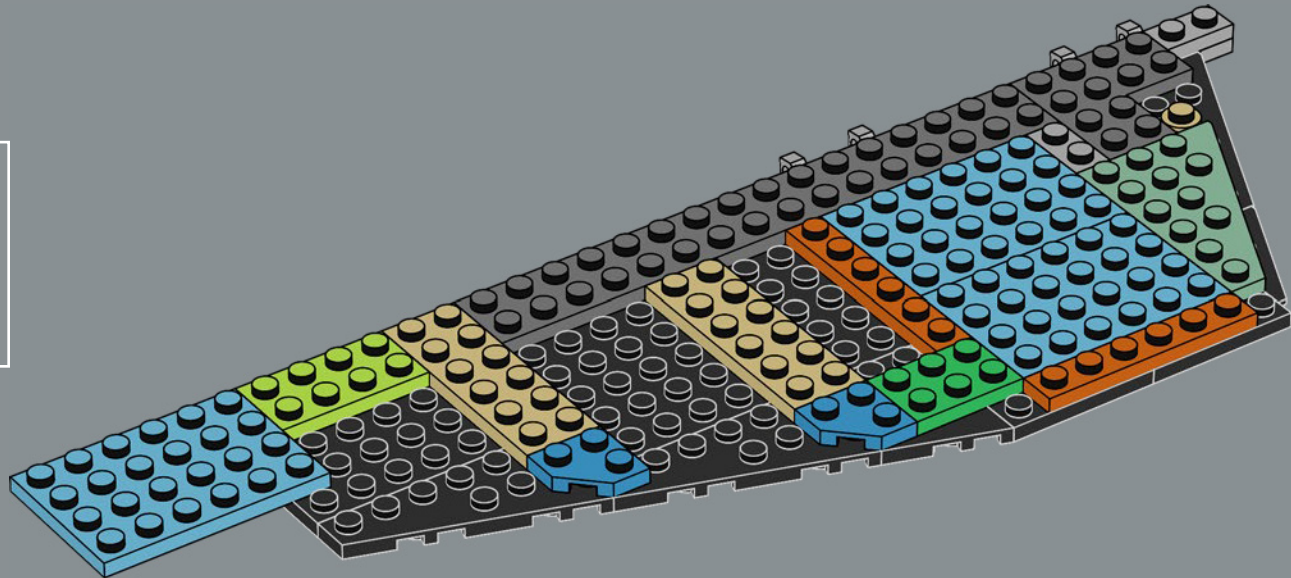



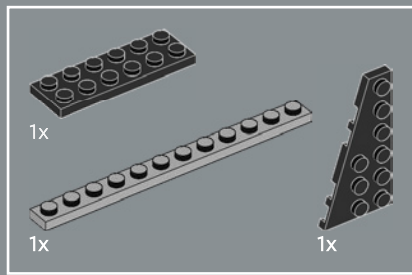

477

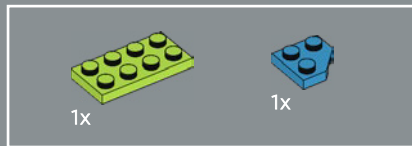
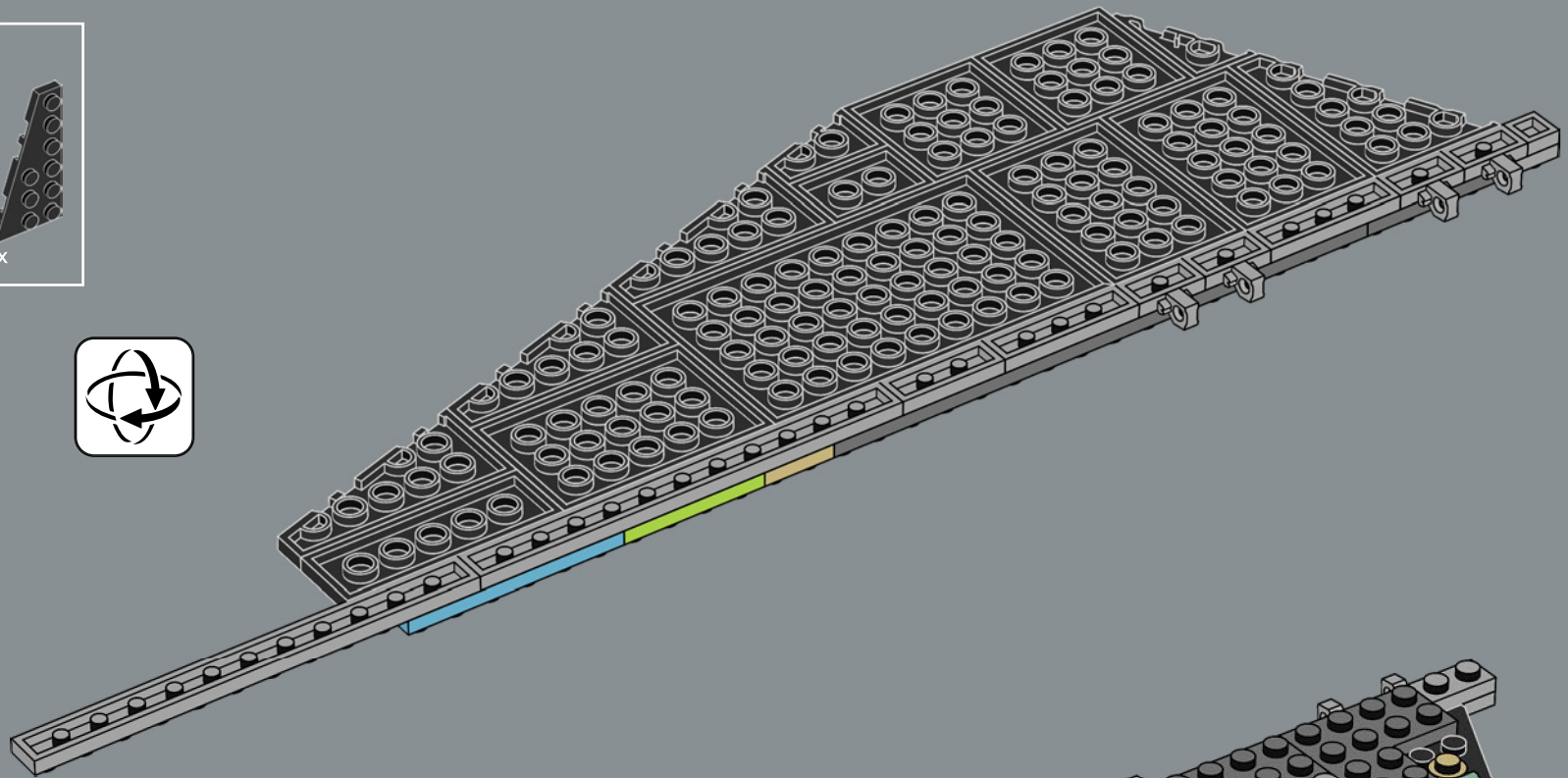

478

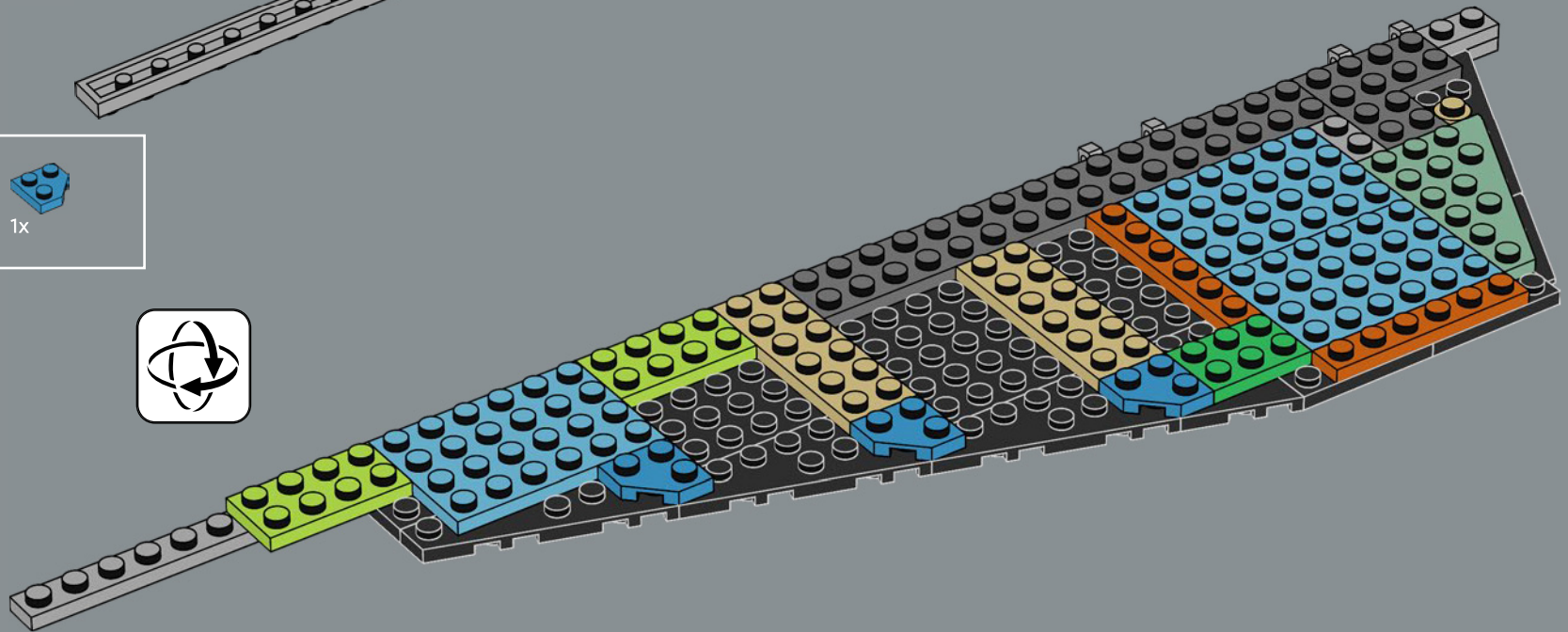

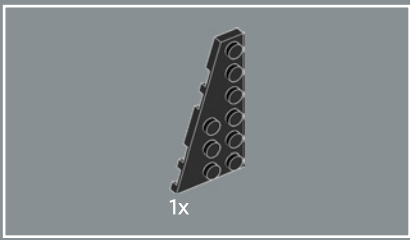

479

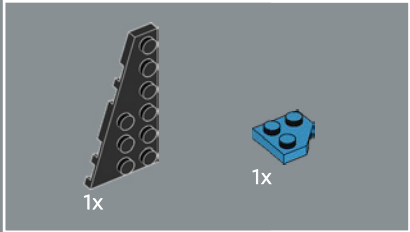
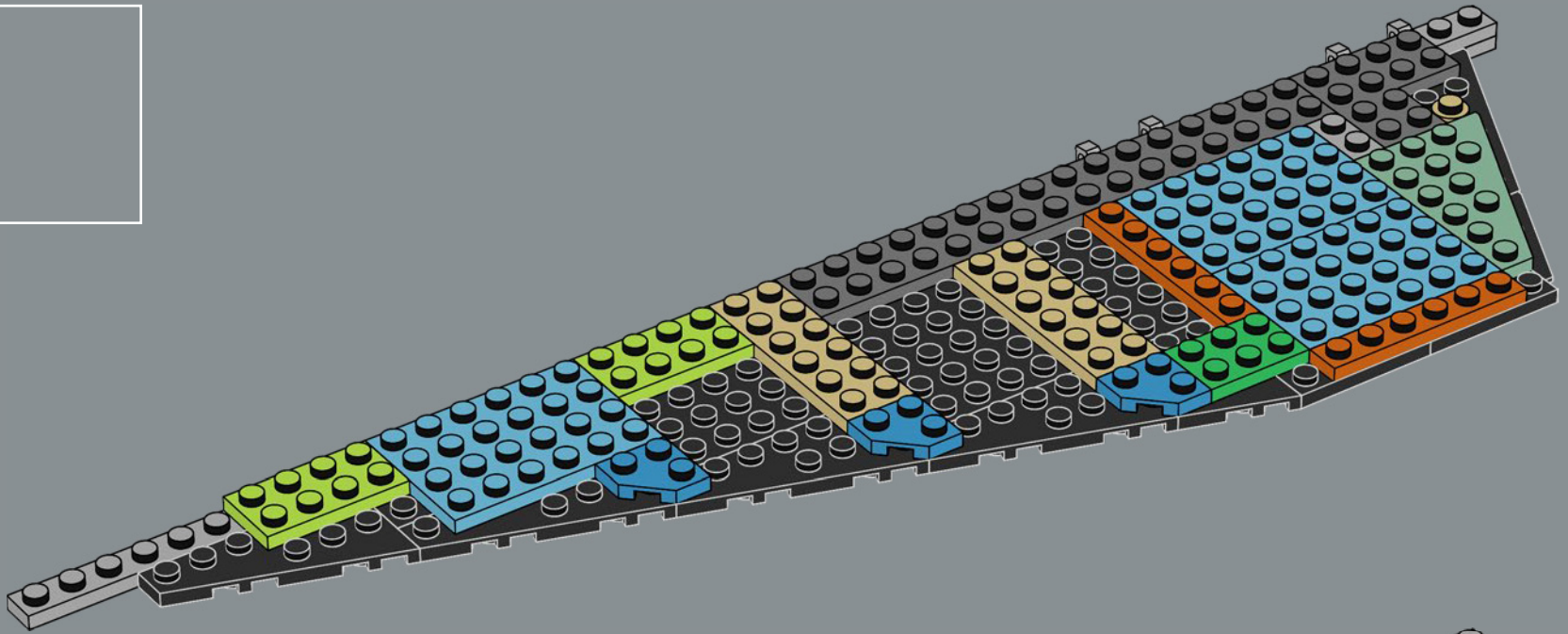

480

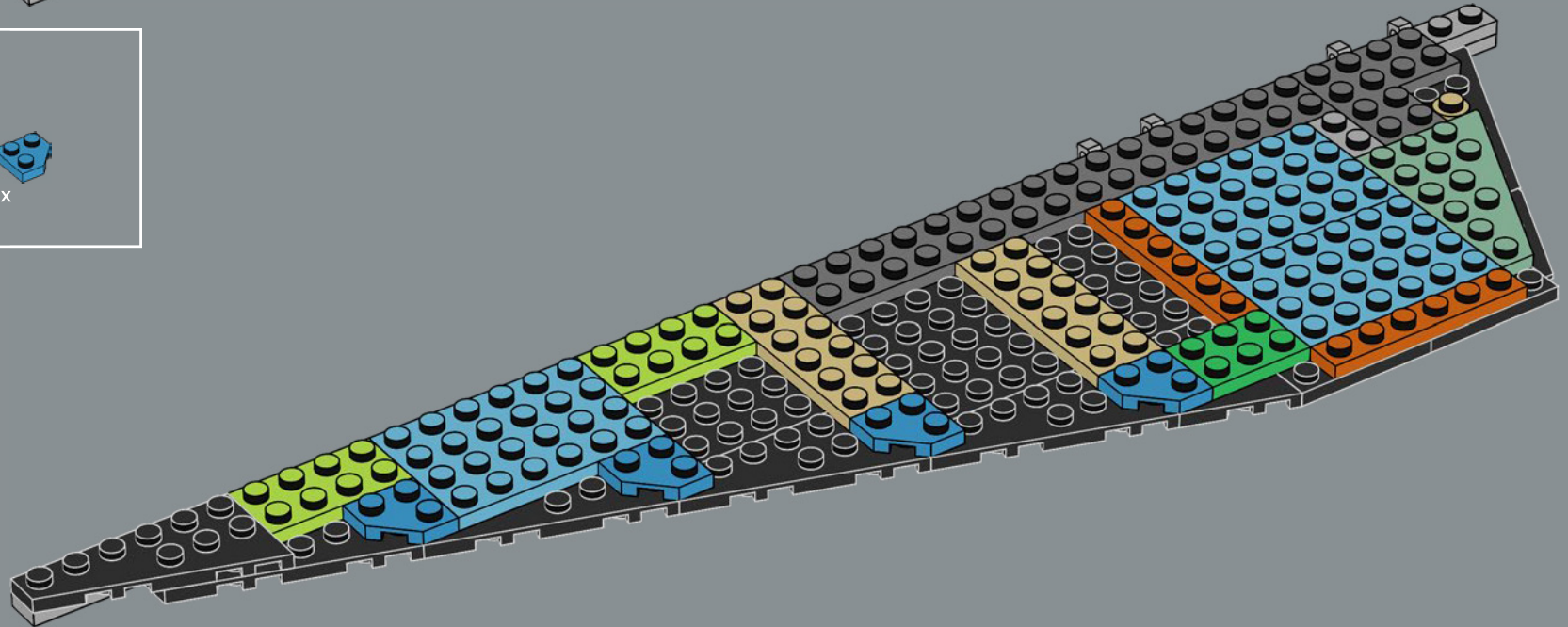



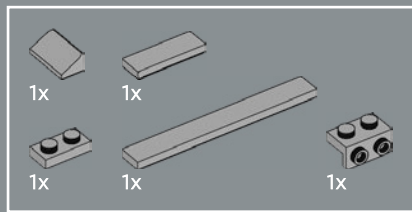

481

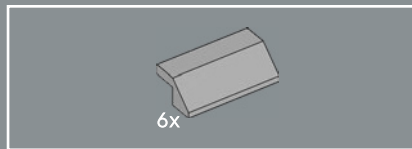
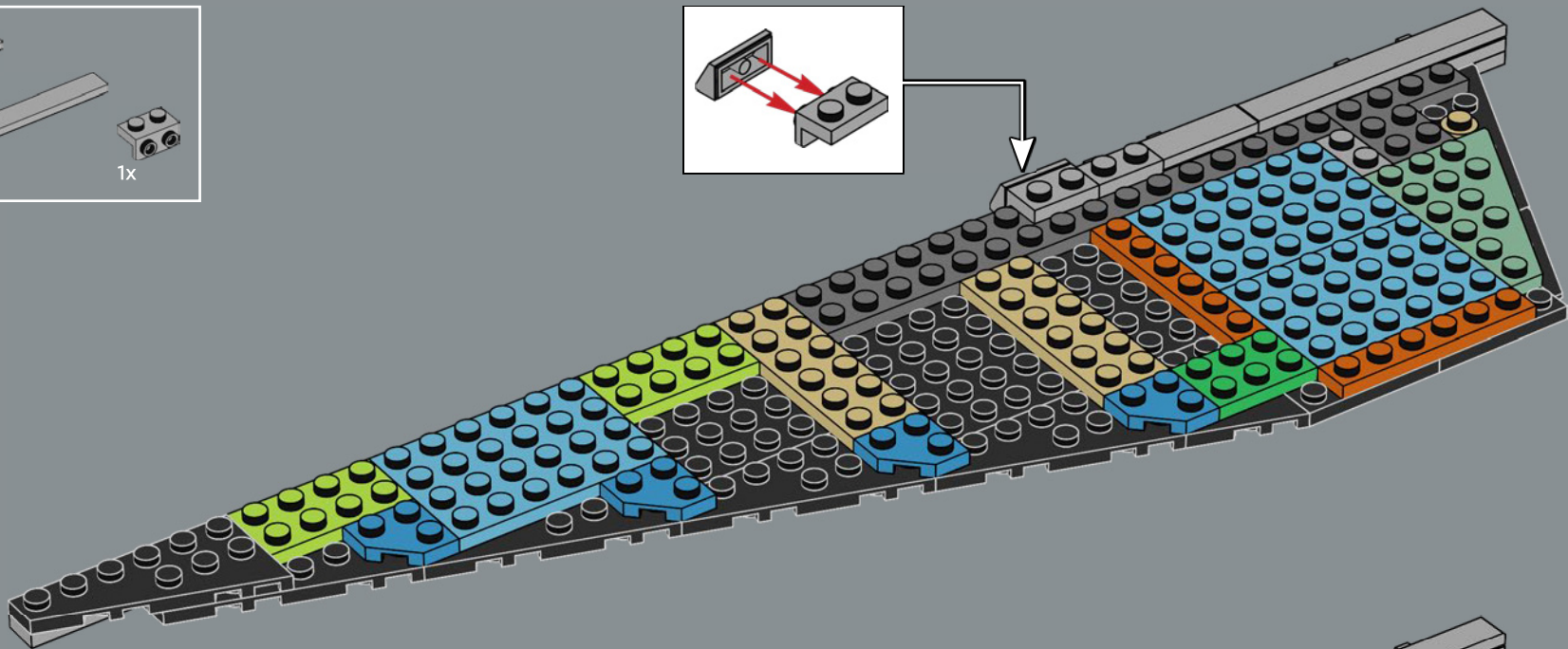
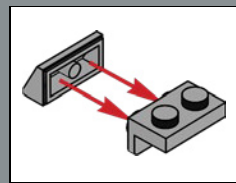

482

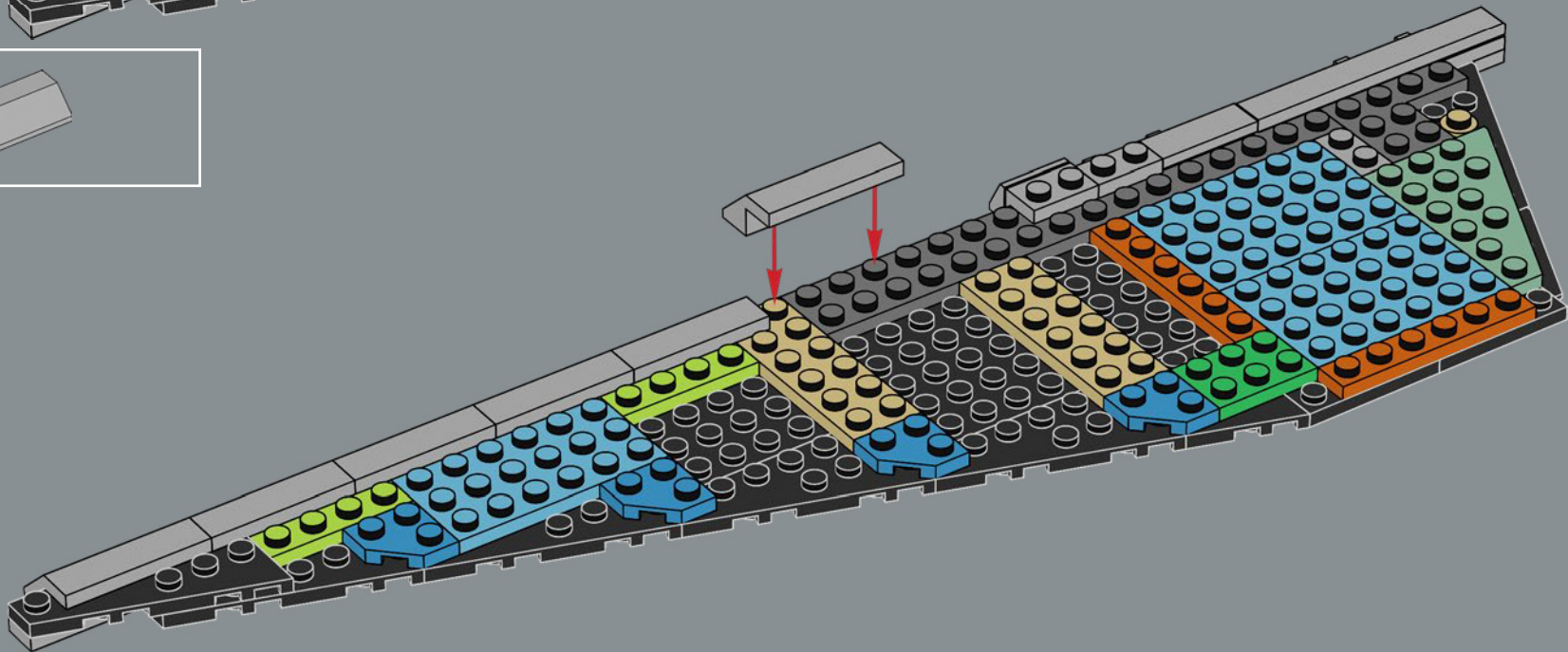



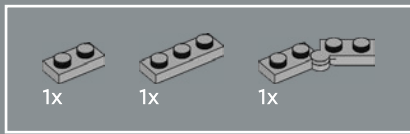

484

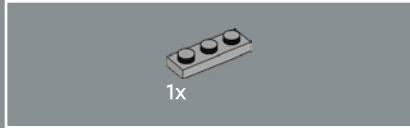
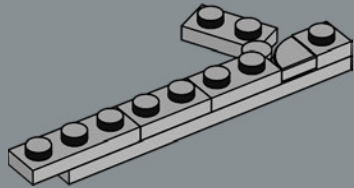

485

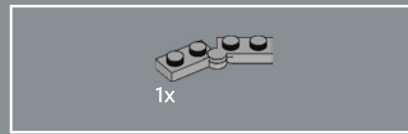
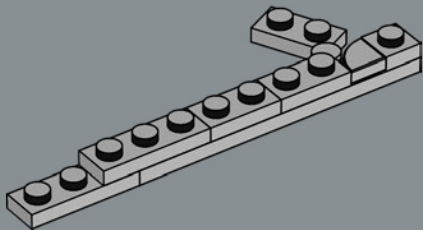

486

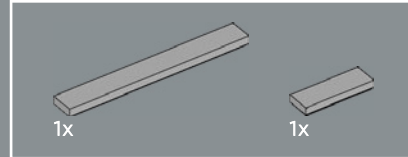
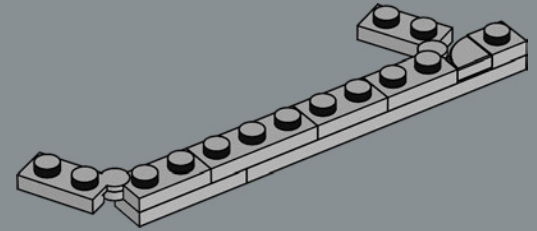

487

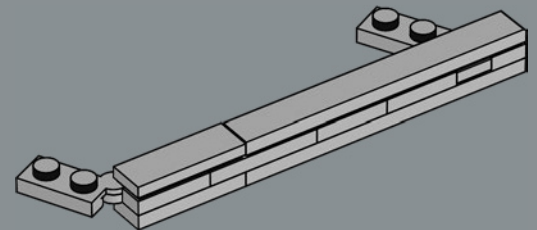

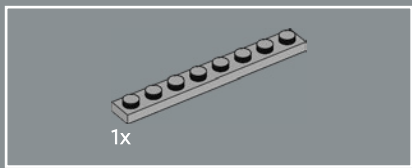

488

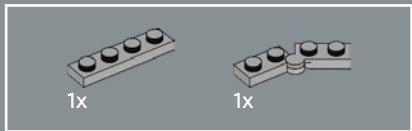
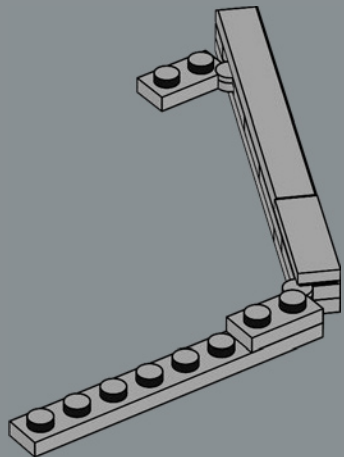

489

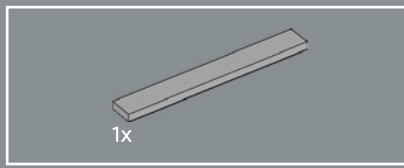
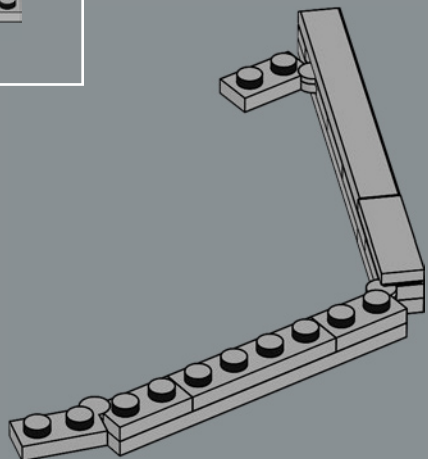

490

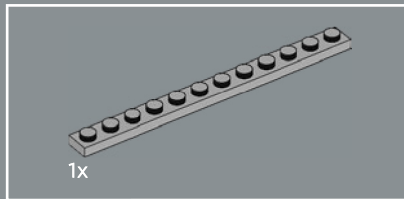
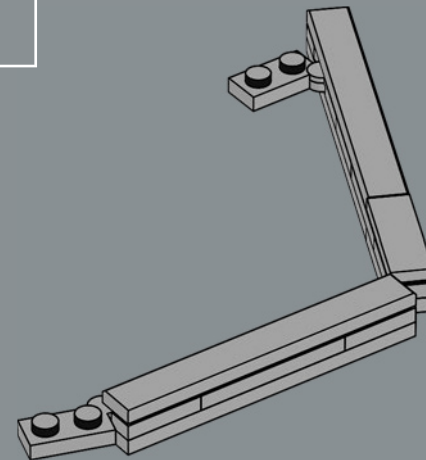

491

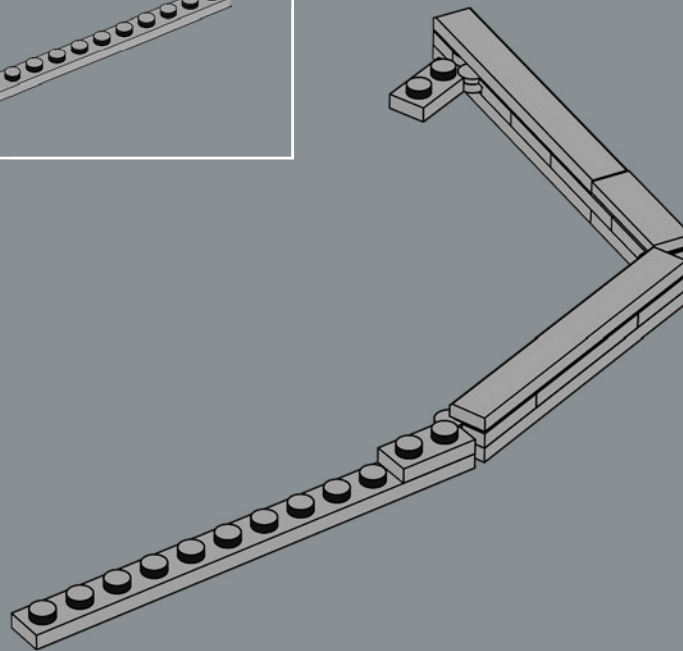



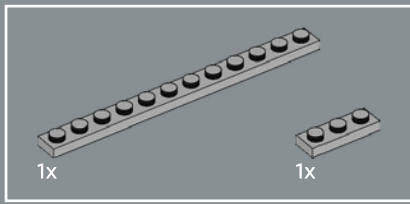

492

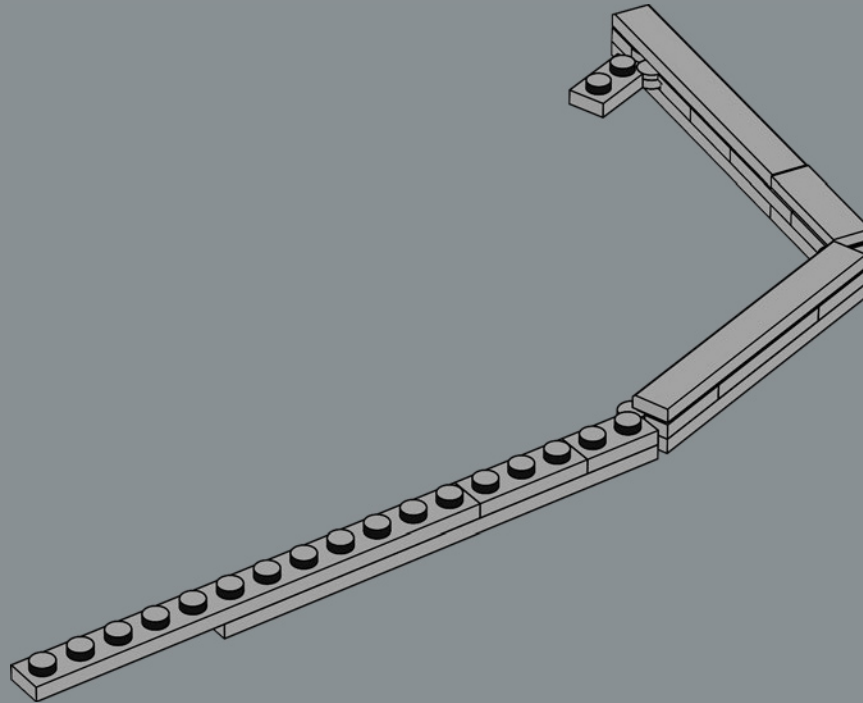

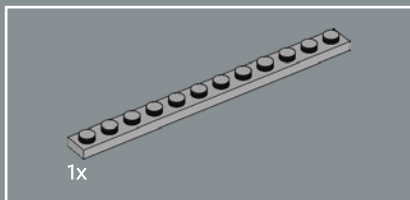

493

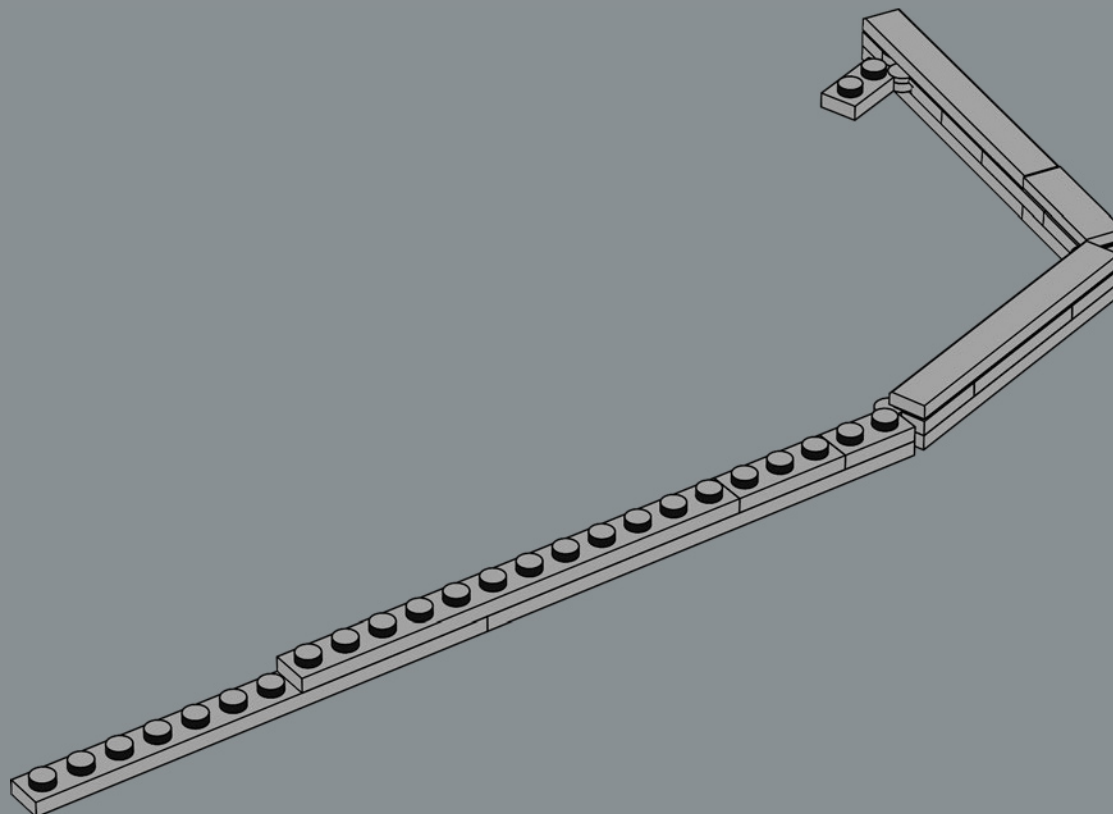

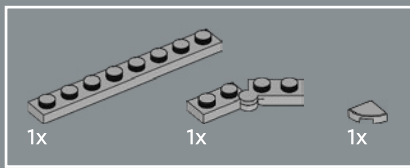

494

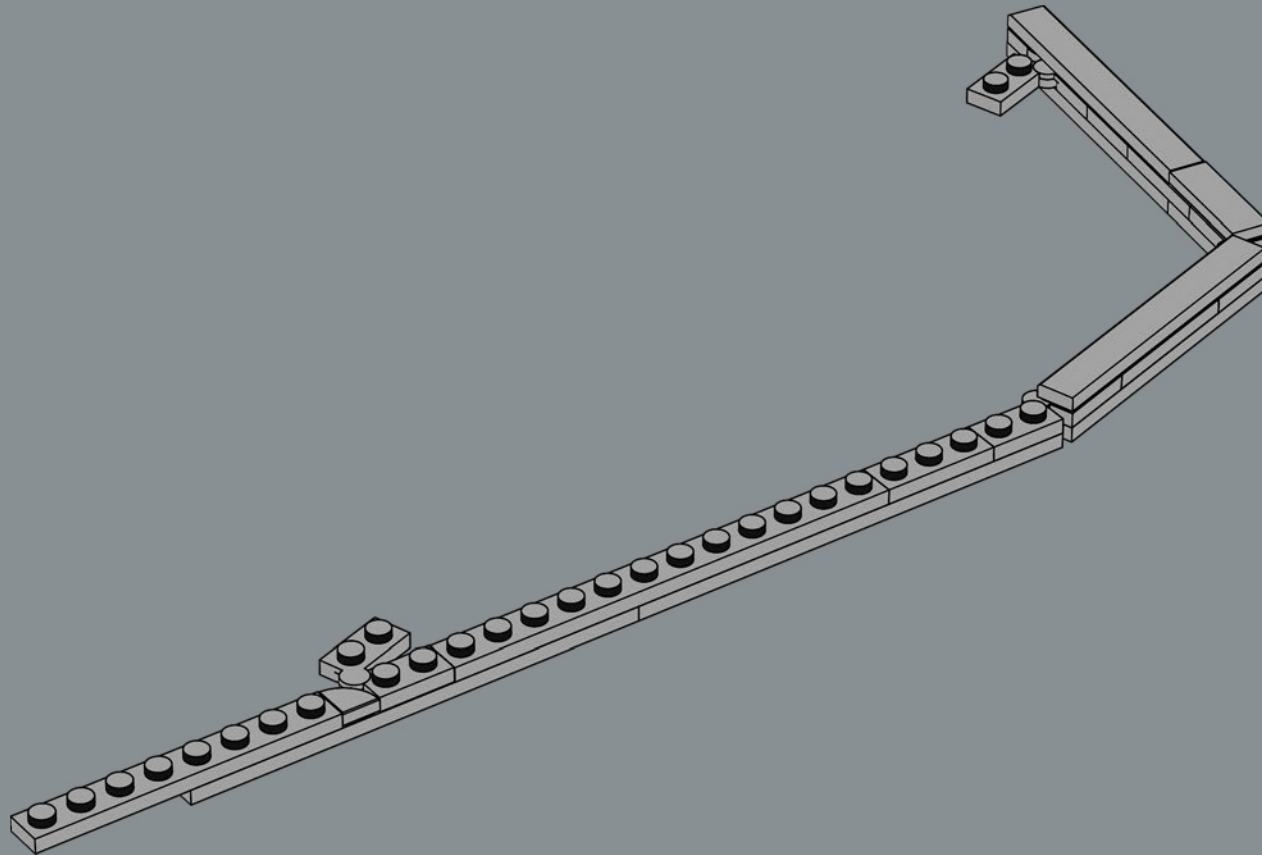

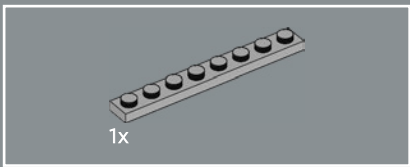

495

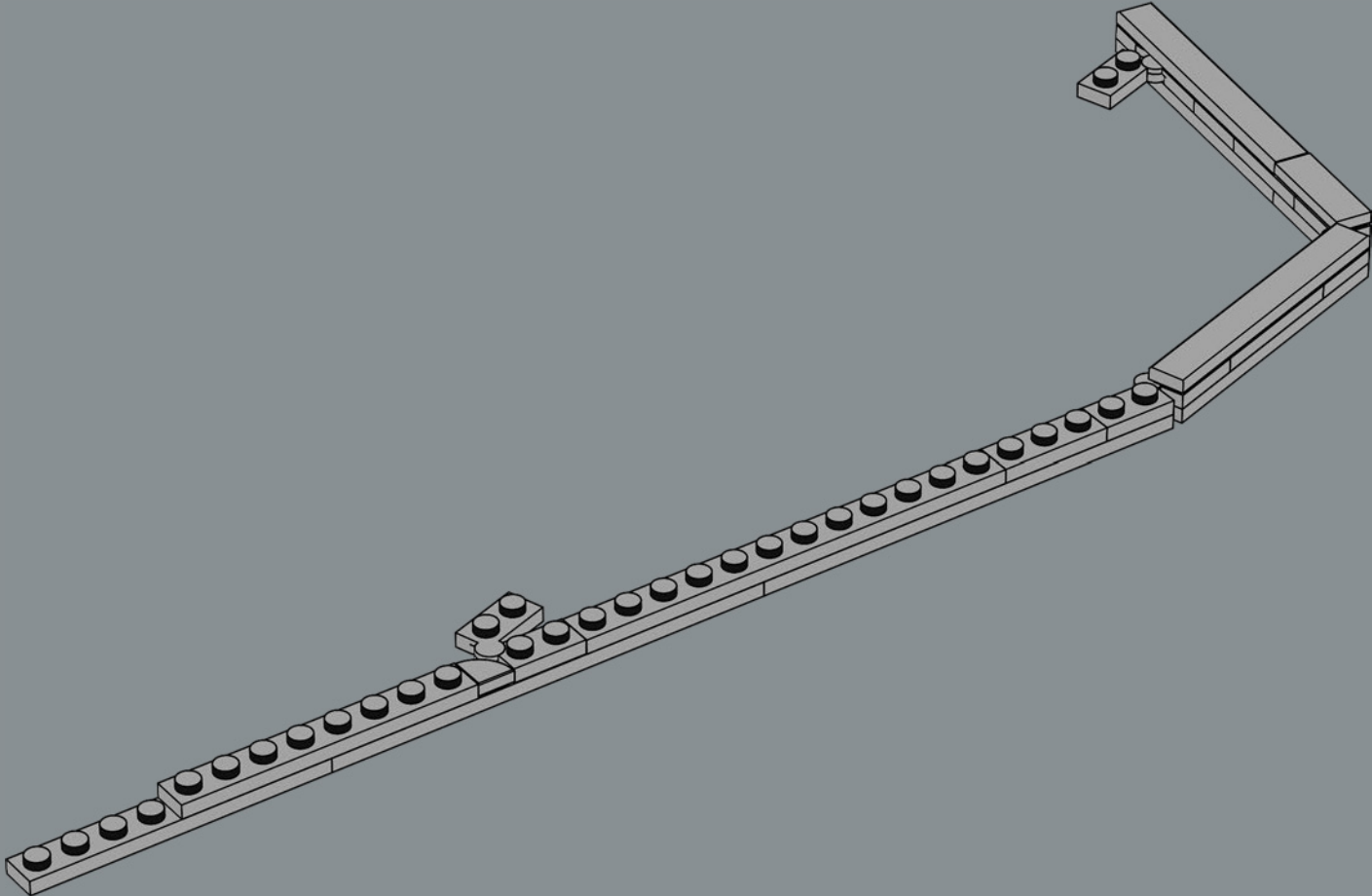



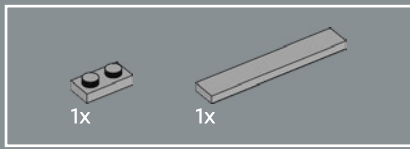

496

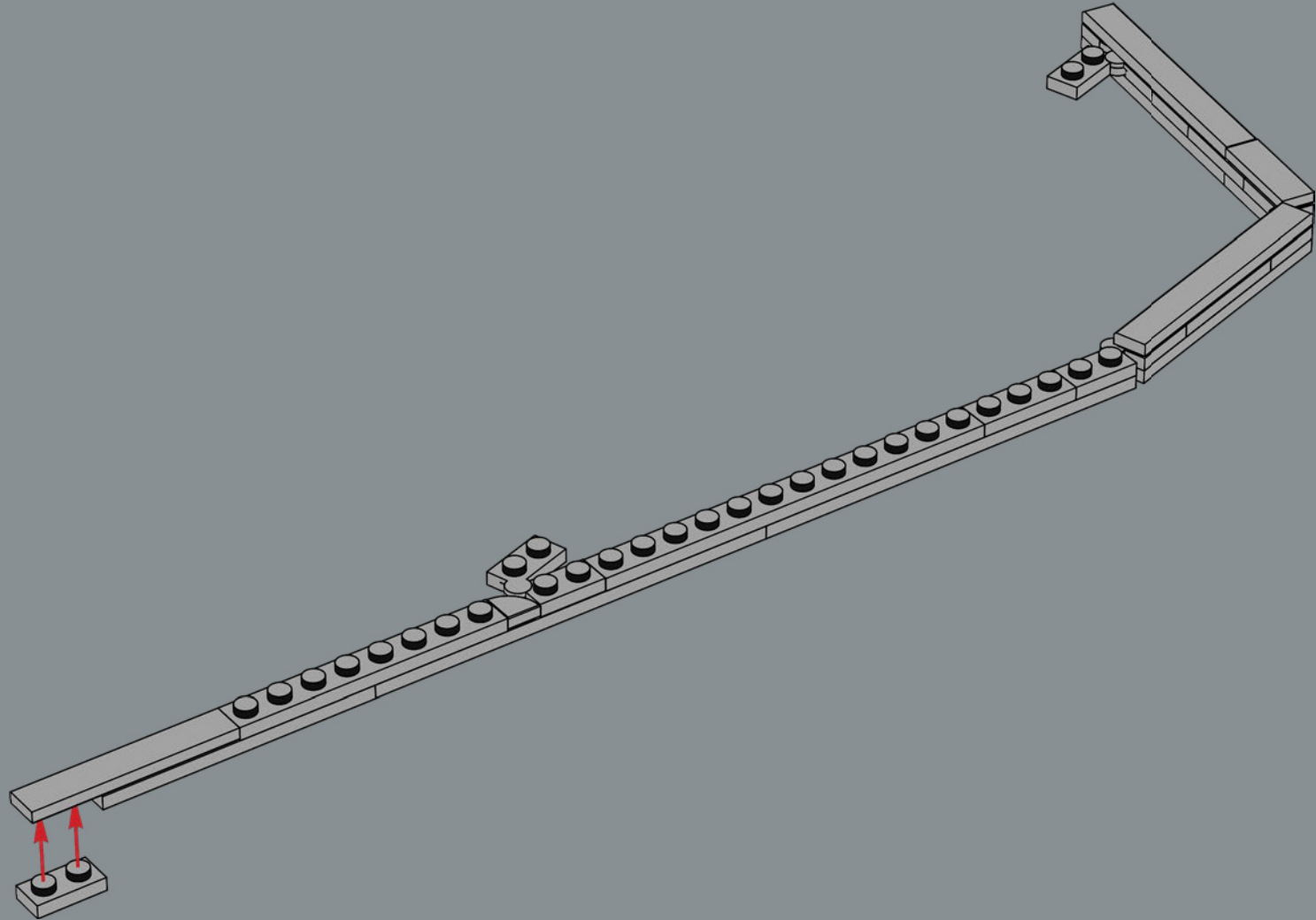

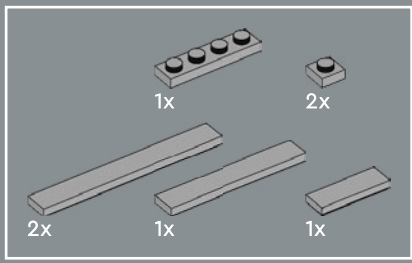

497

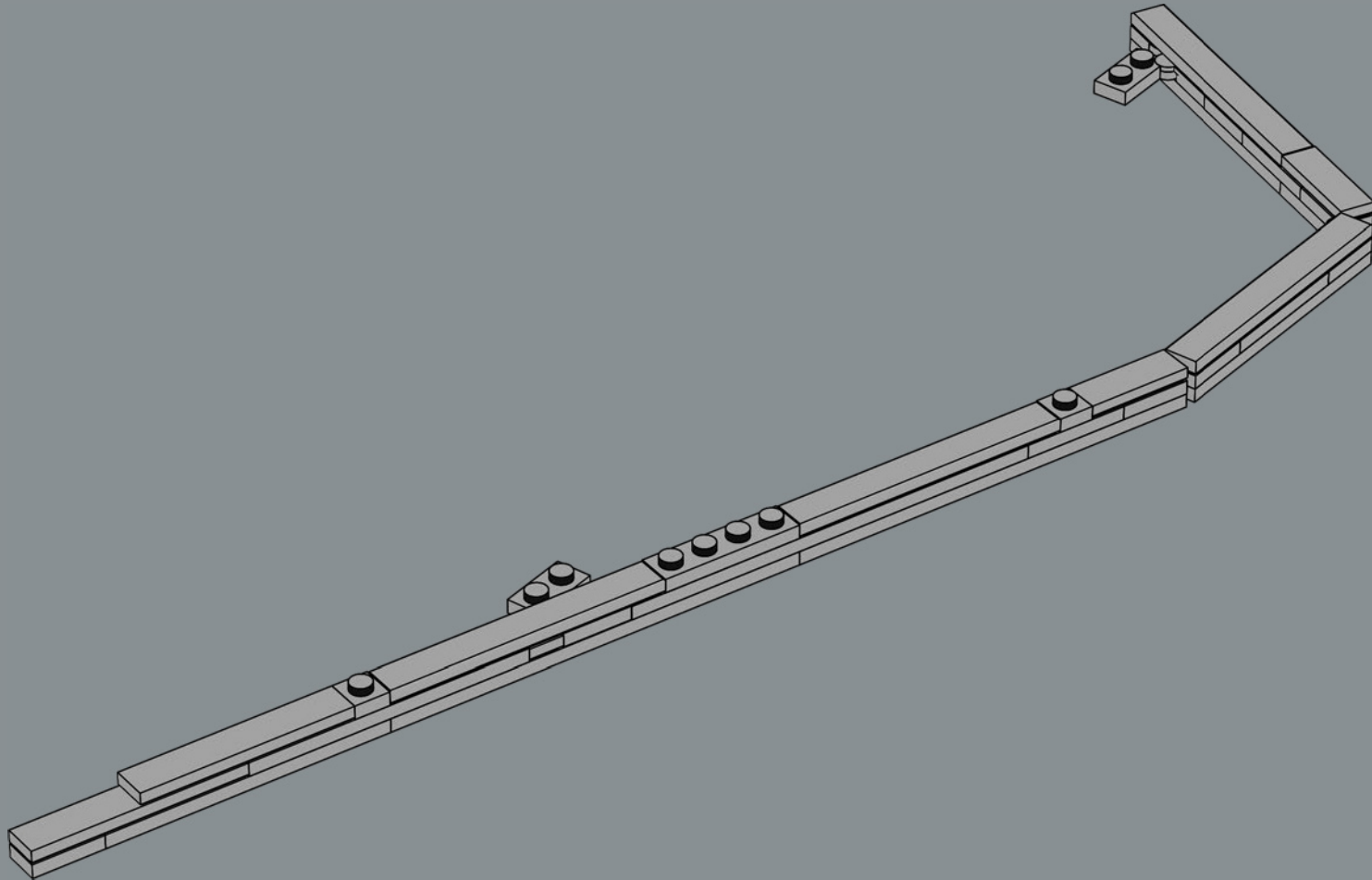

498

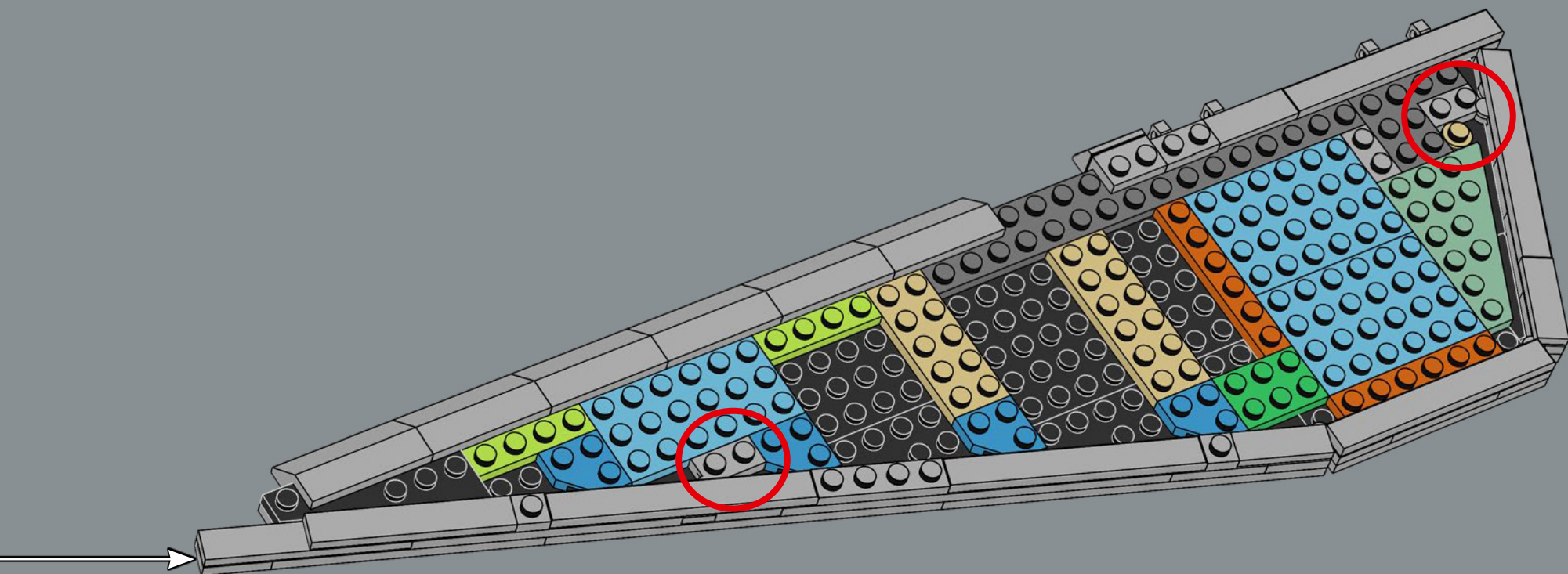

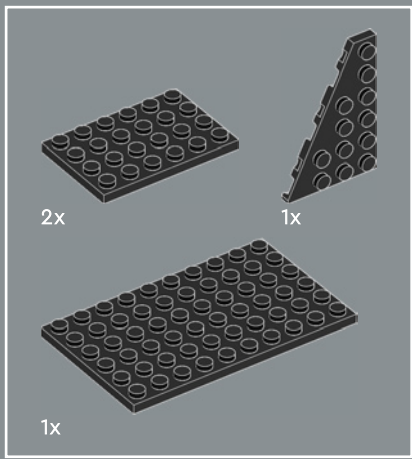

499

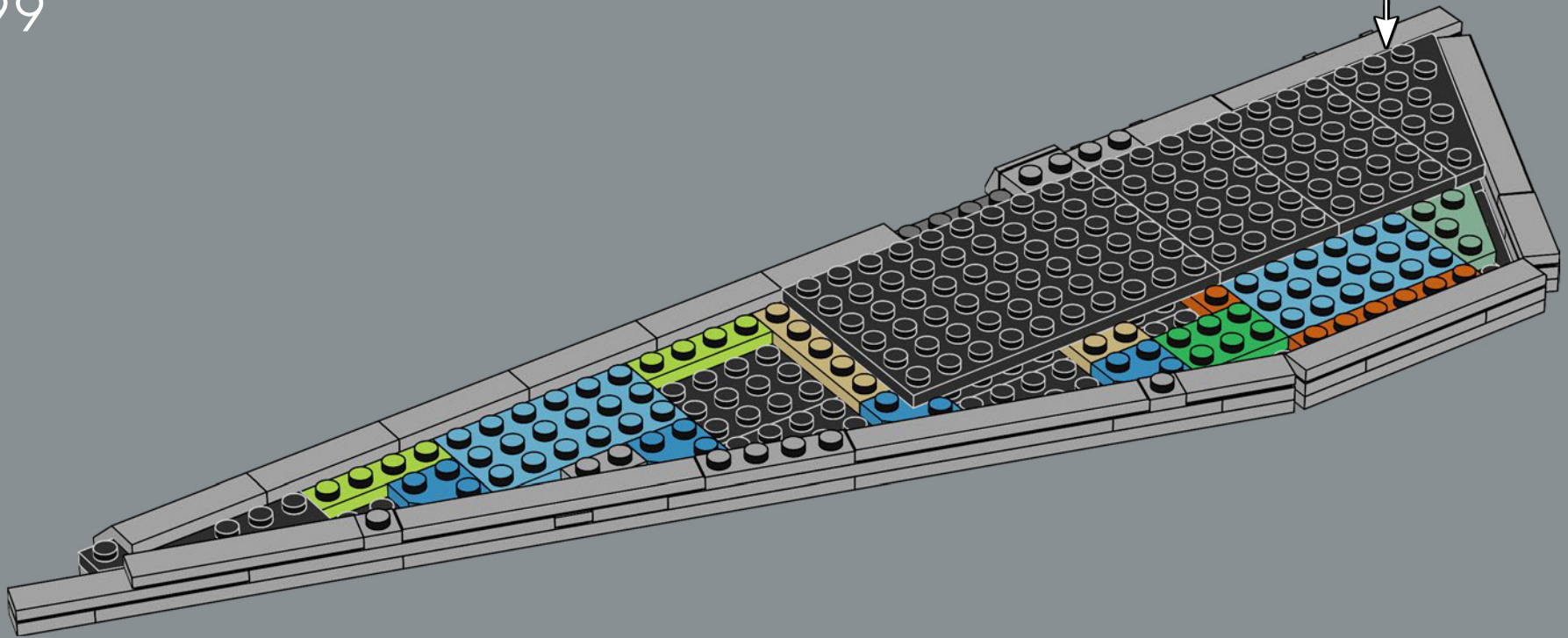
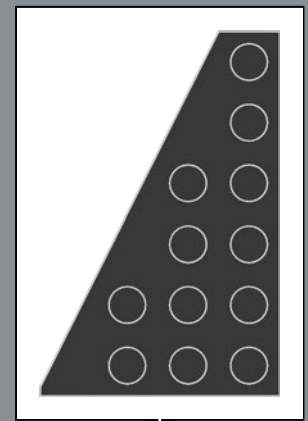



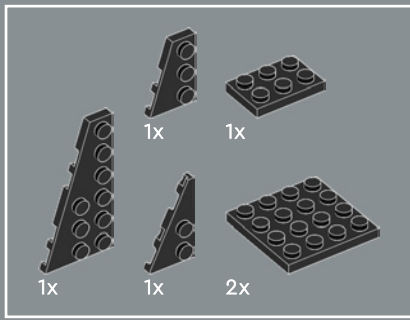

500

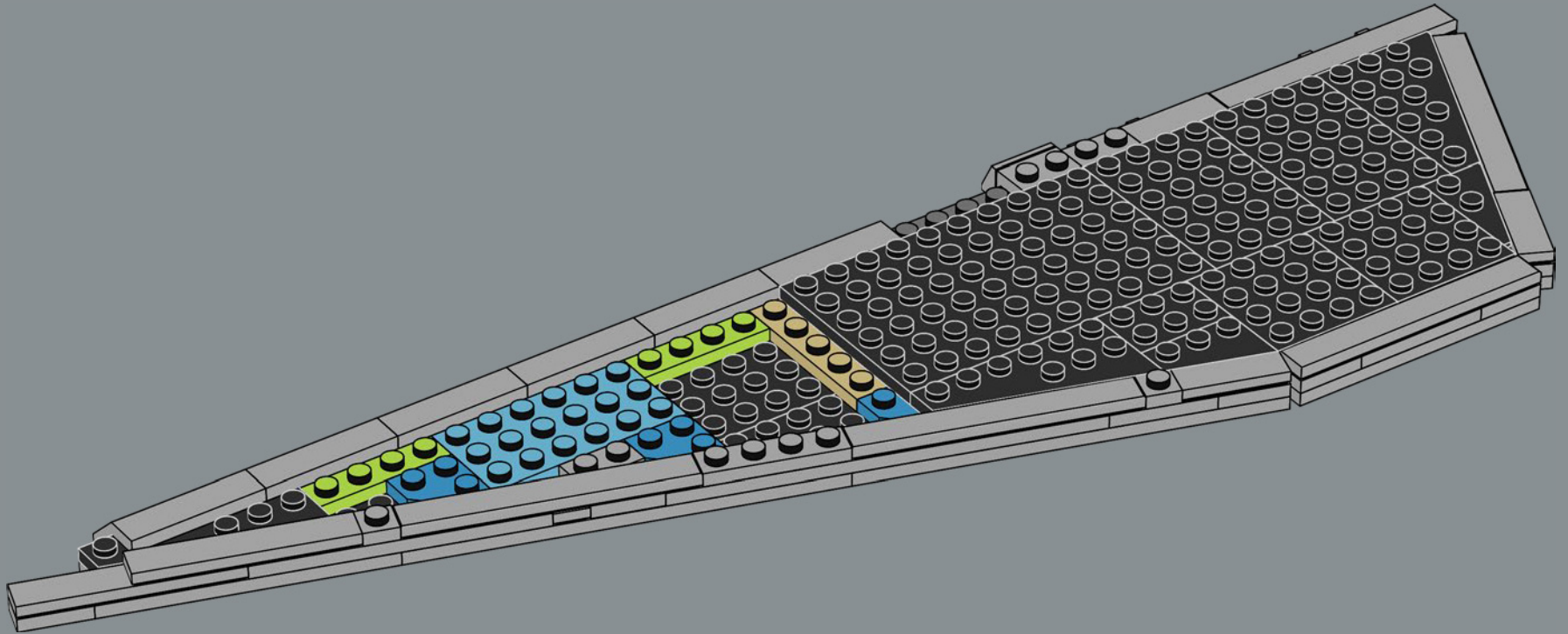

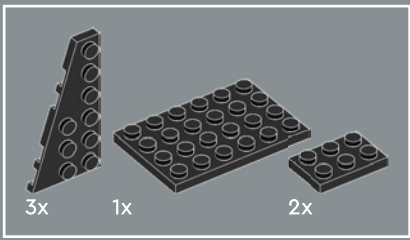

501

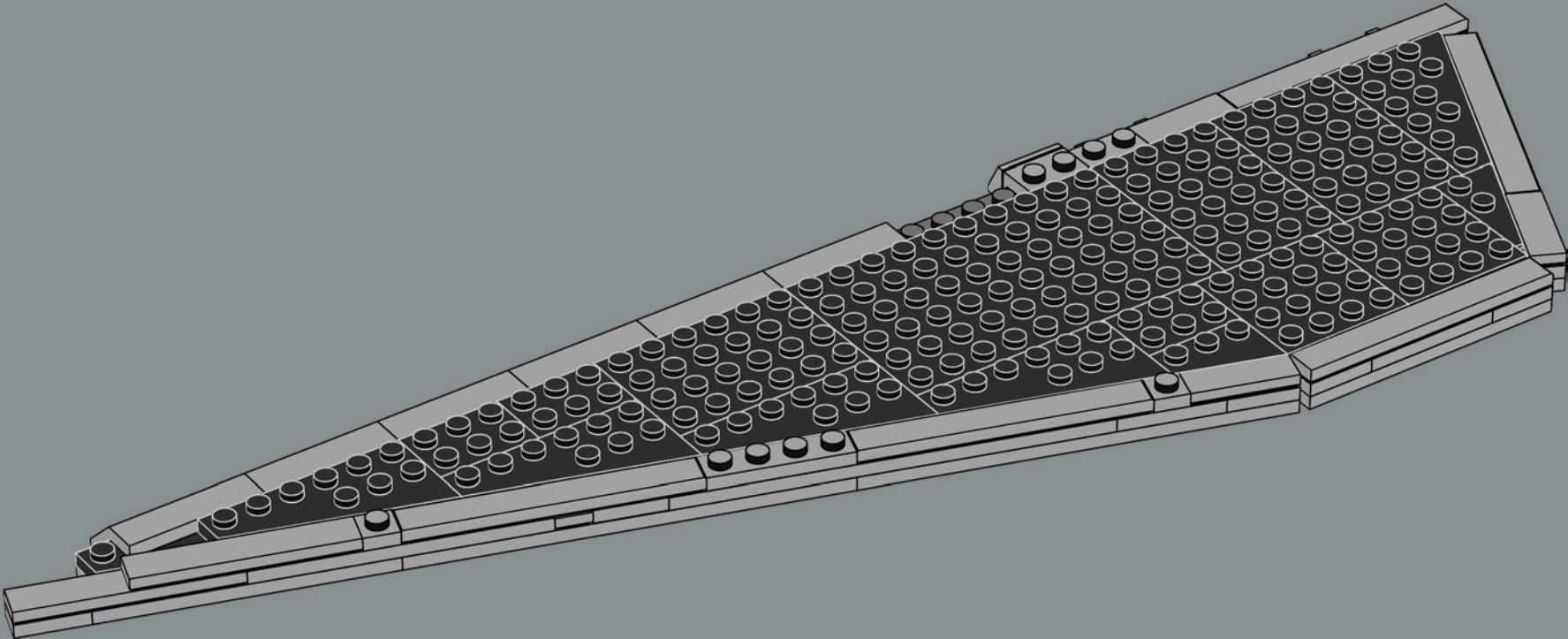

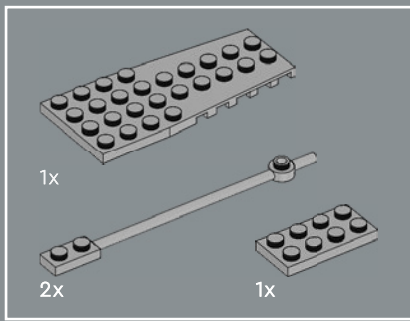

502

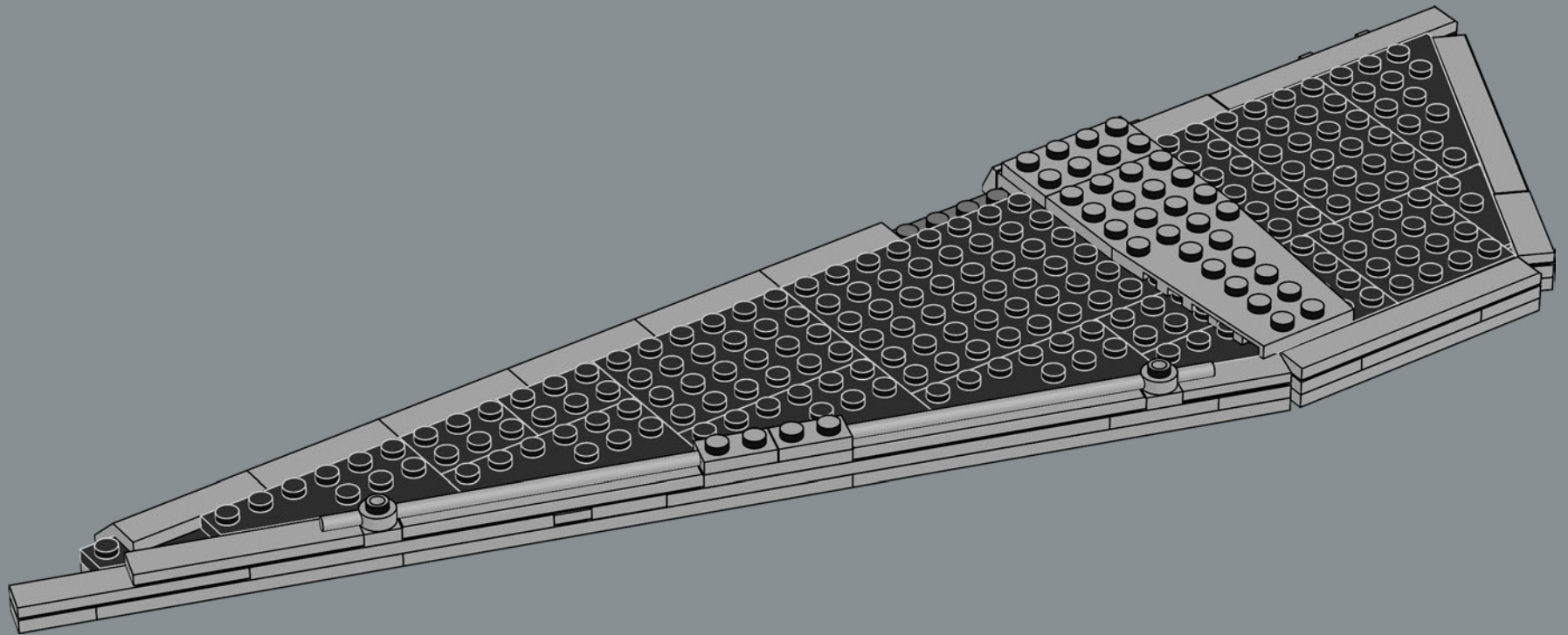

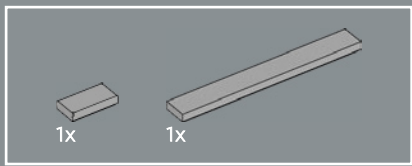

503

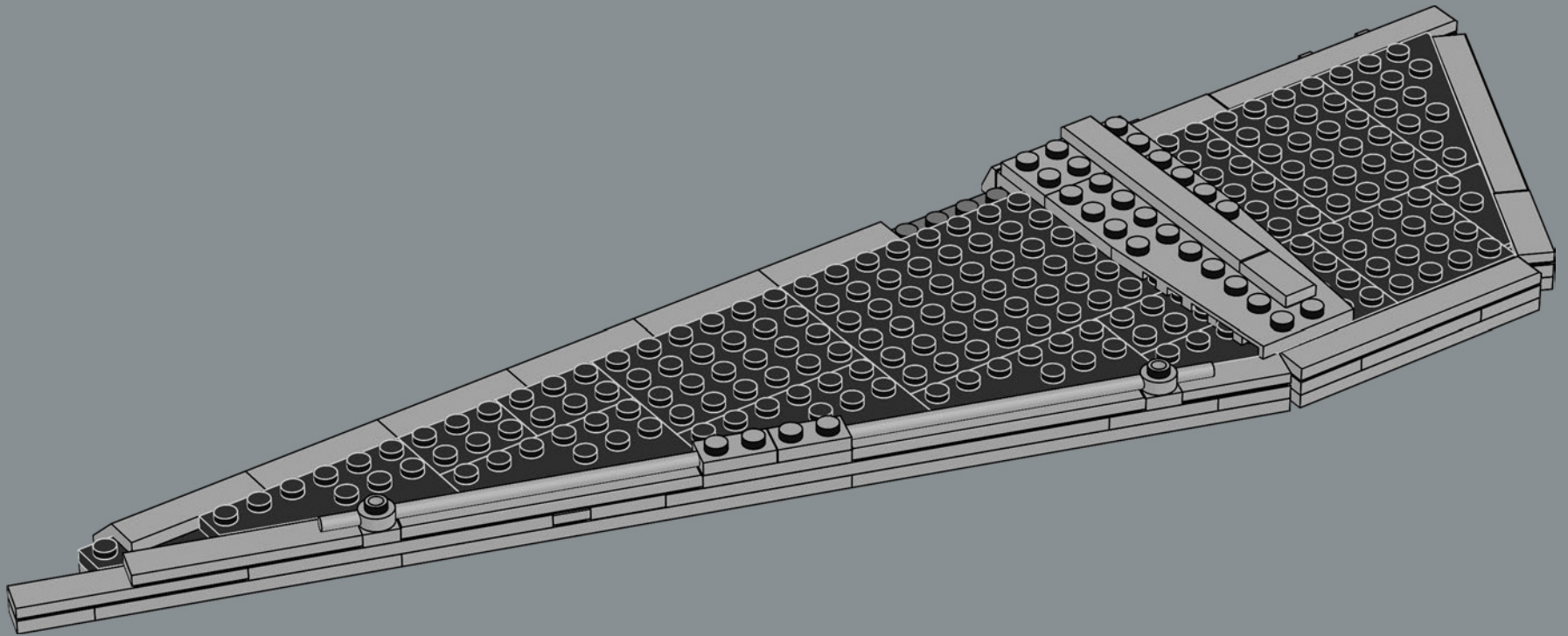



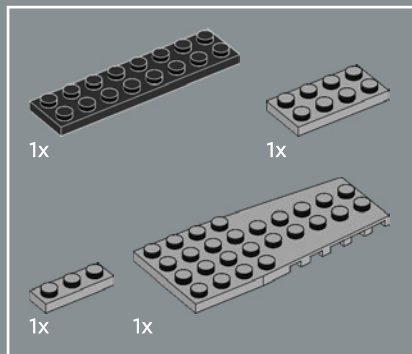

504

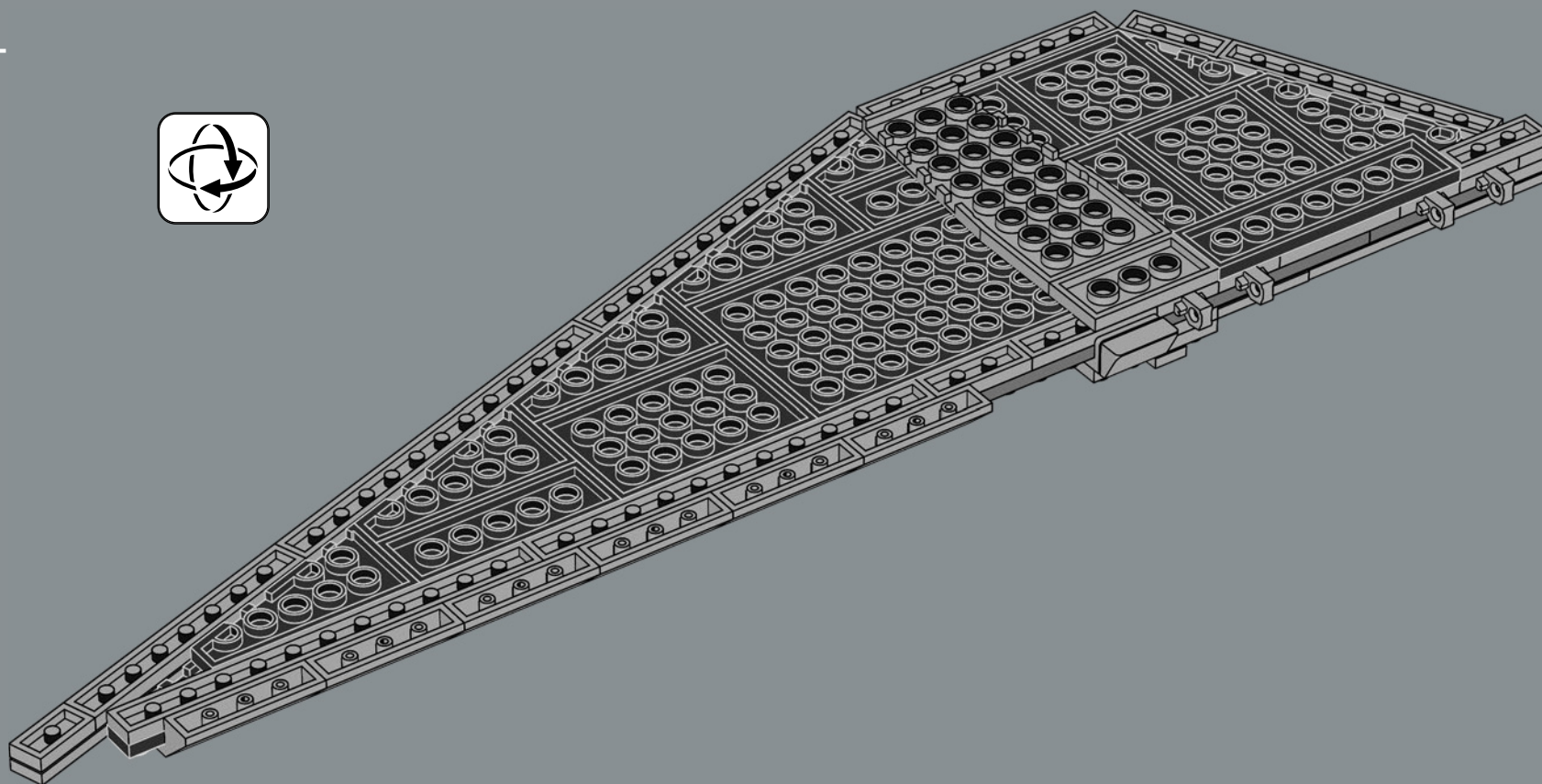

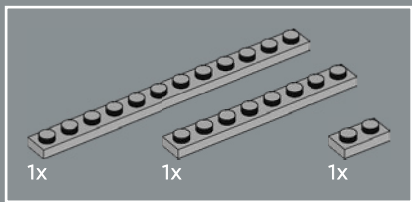

505

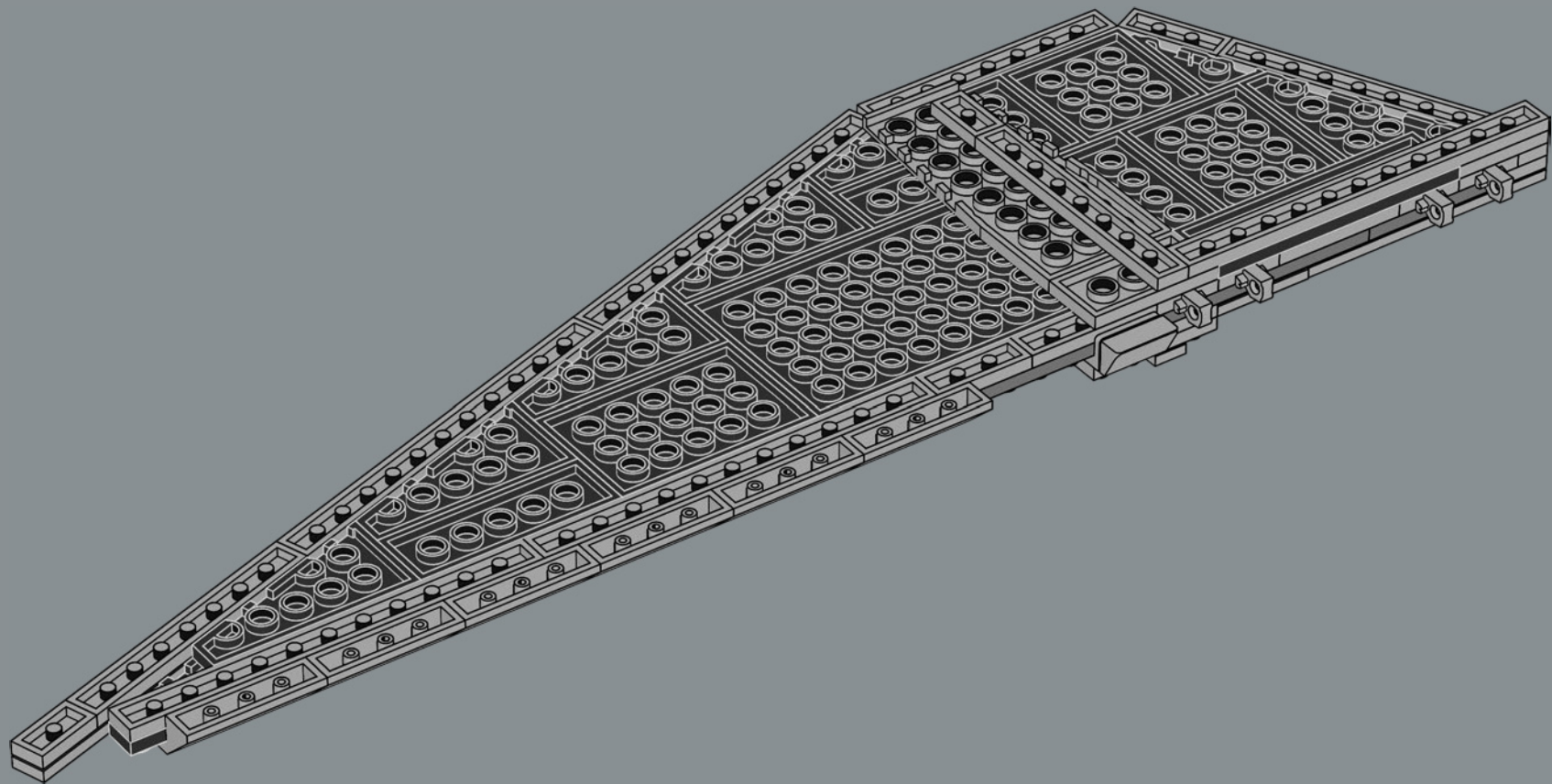

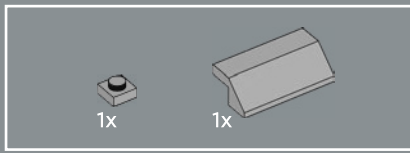

506

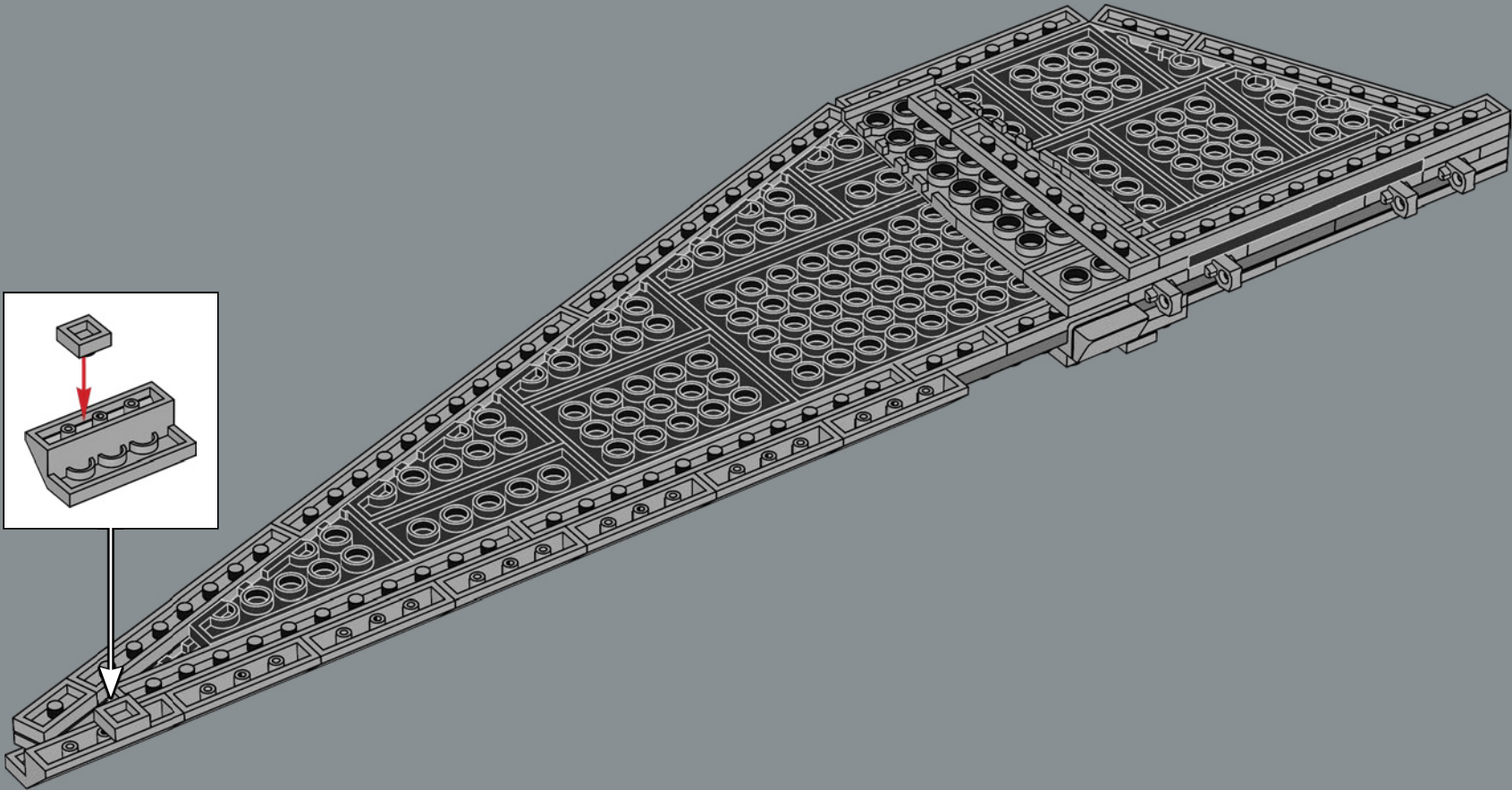

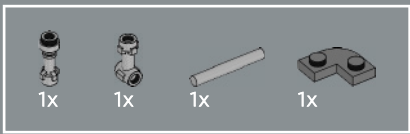

507

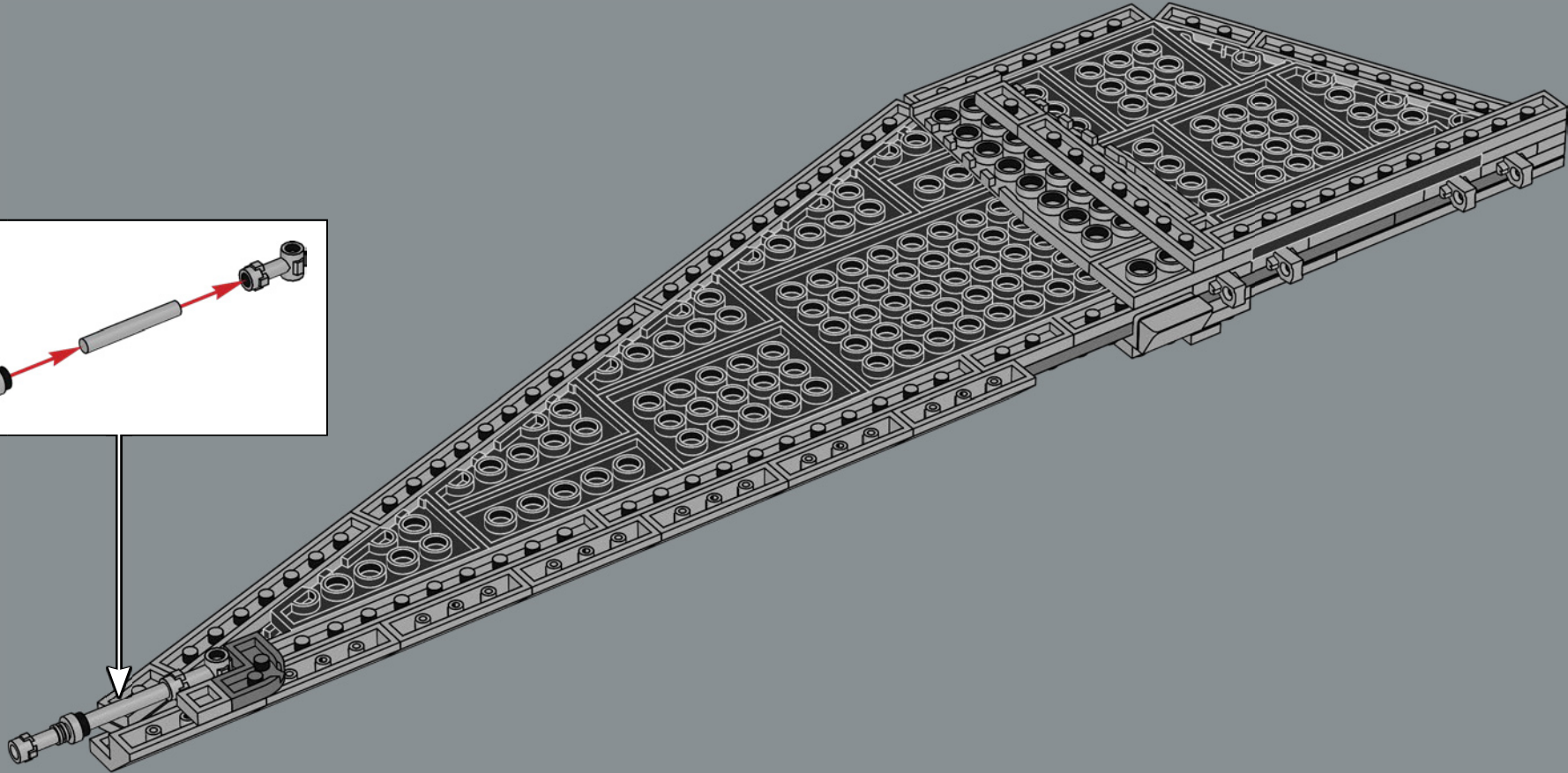
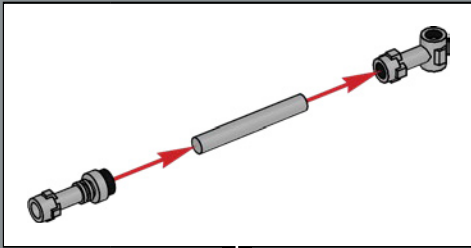





508

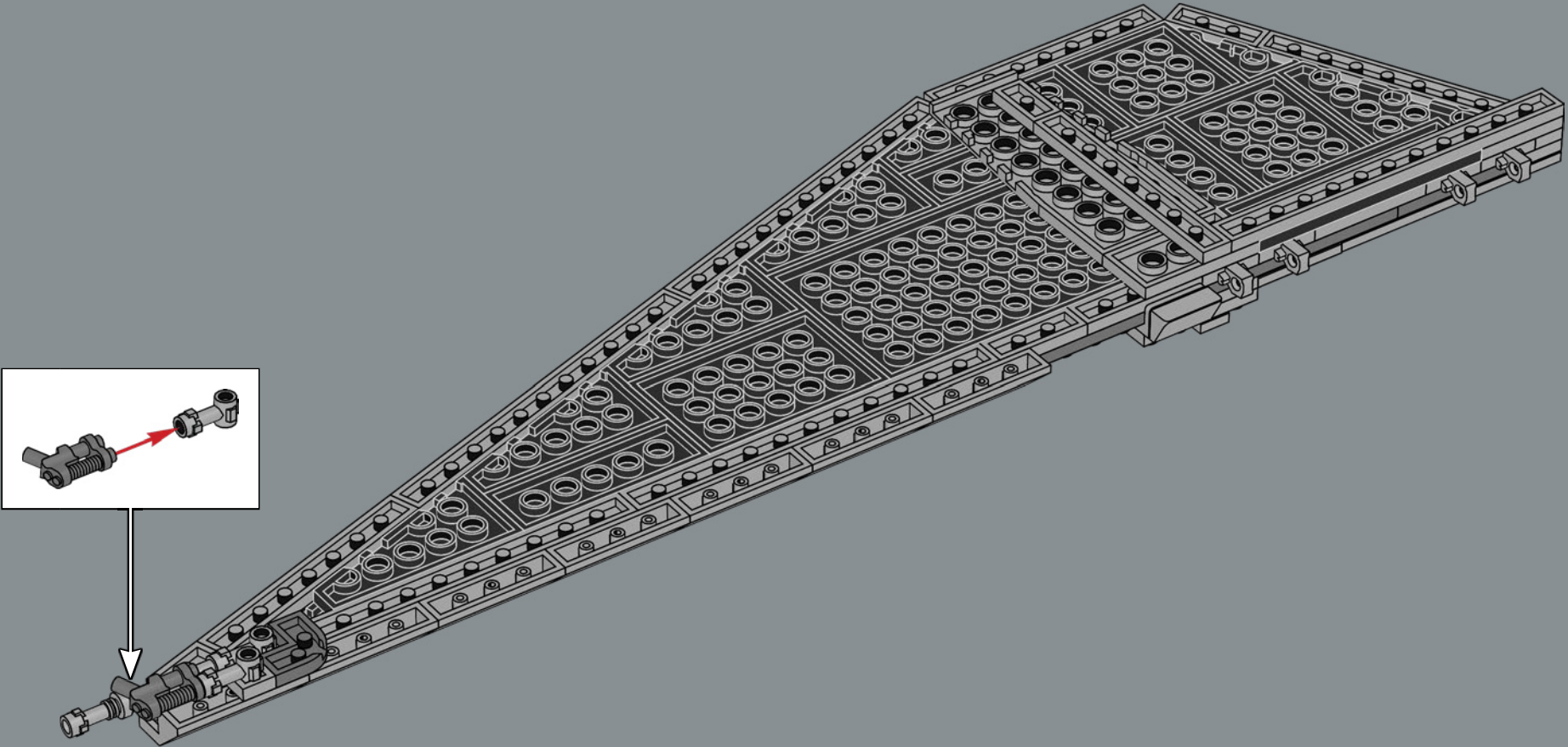

509

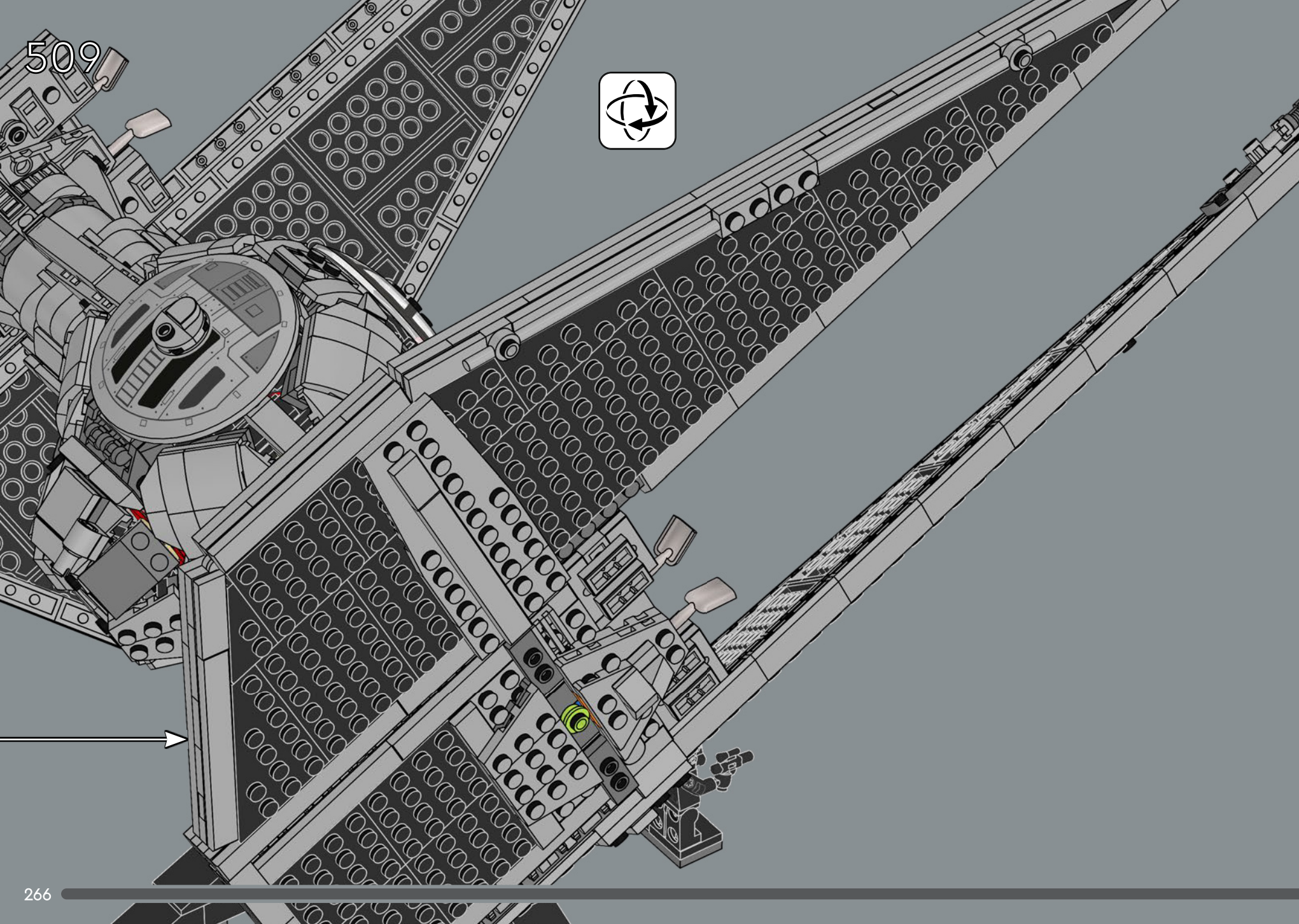



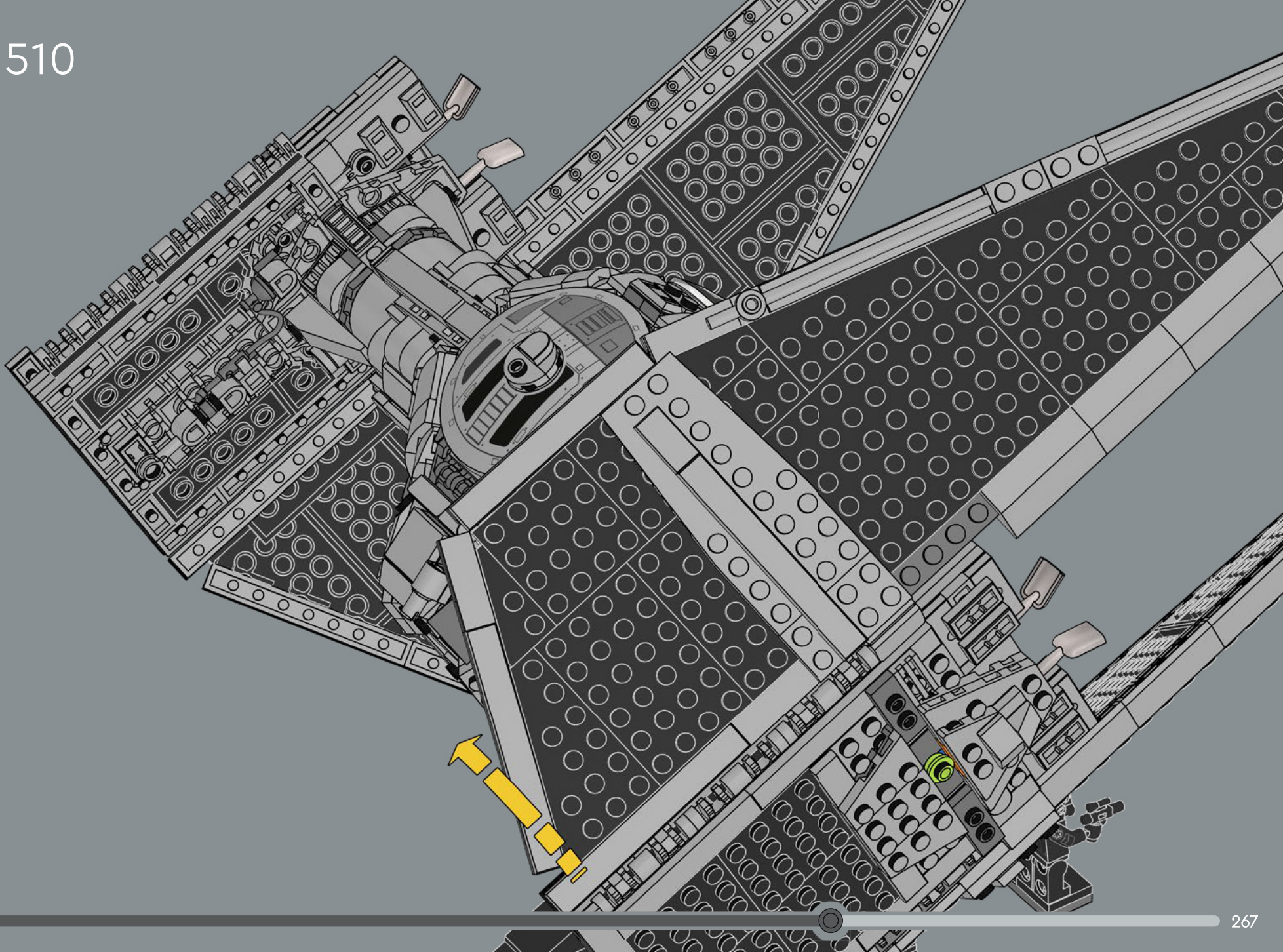



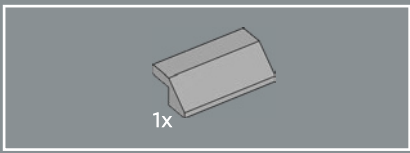

511

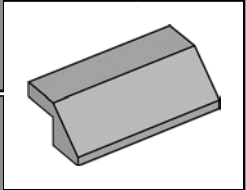
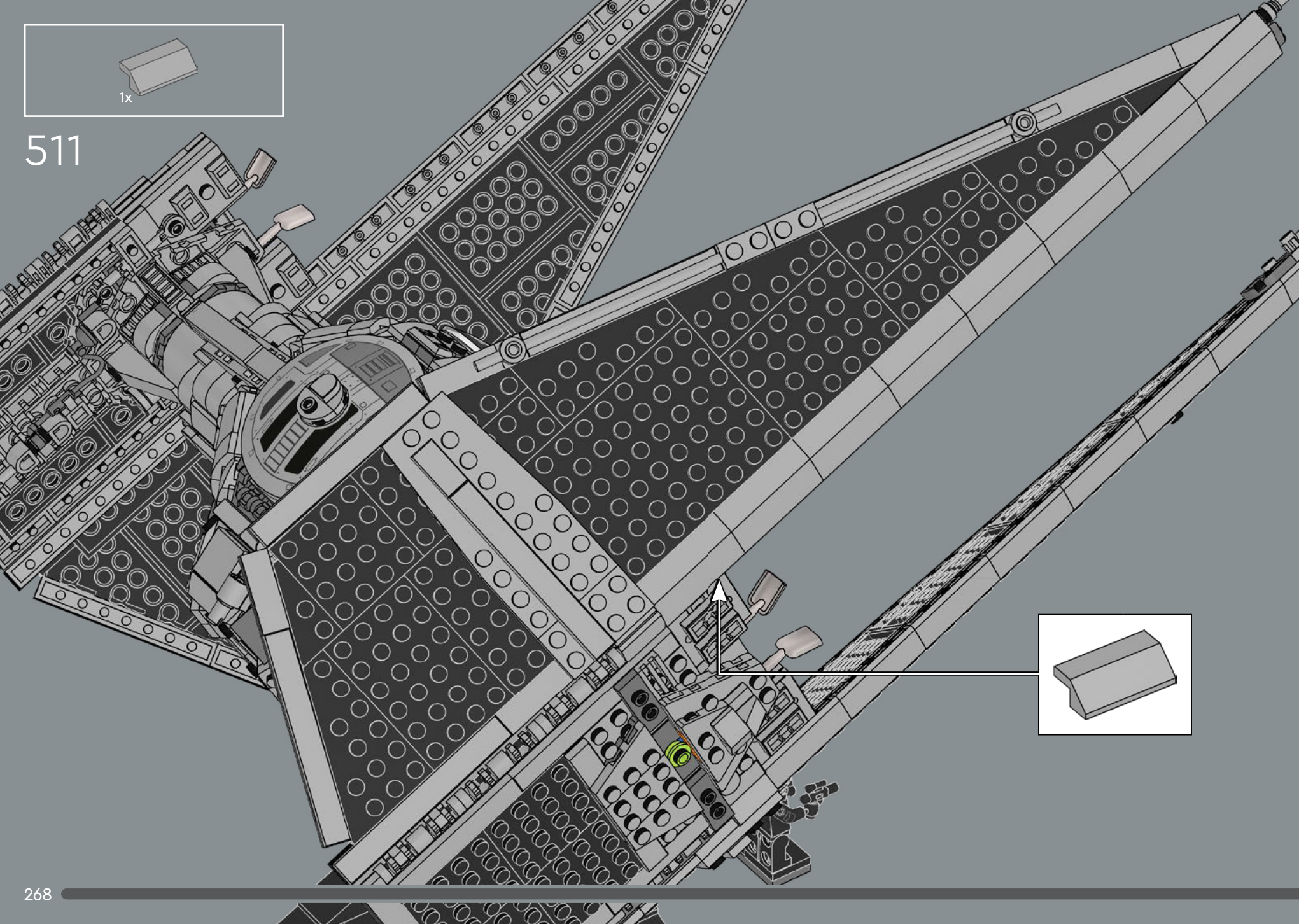



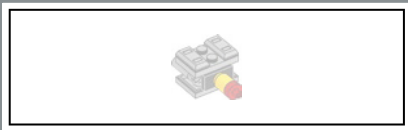

512

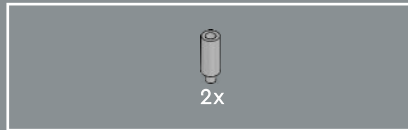
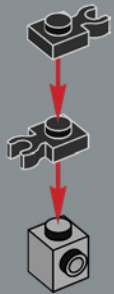

513

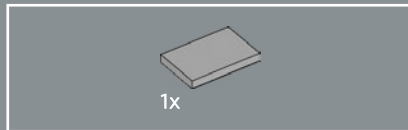
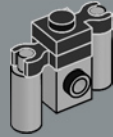

514

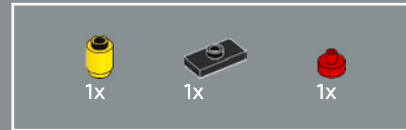
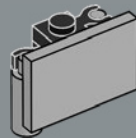

515

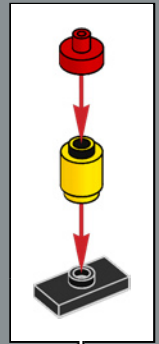
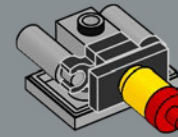

516

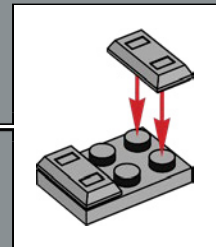
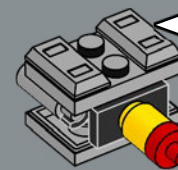

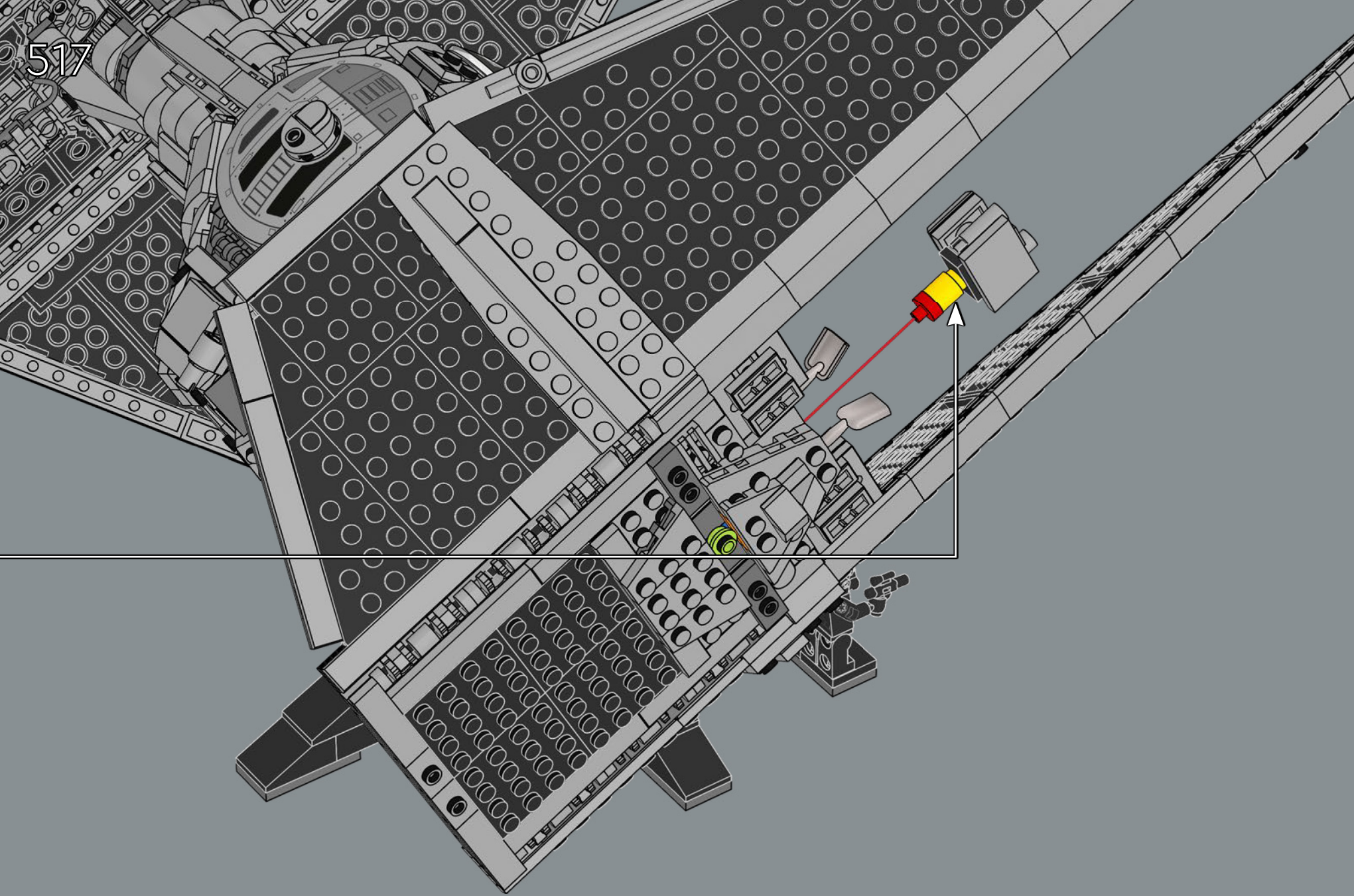



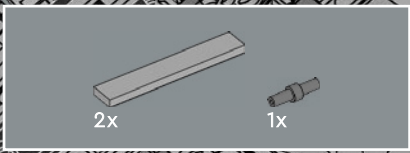

518

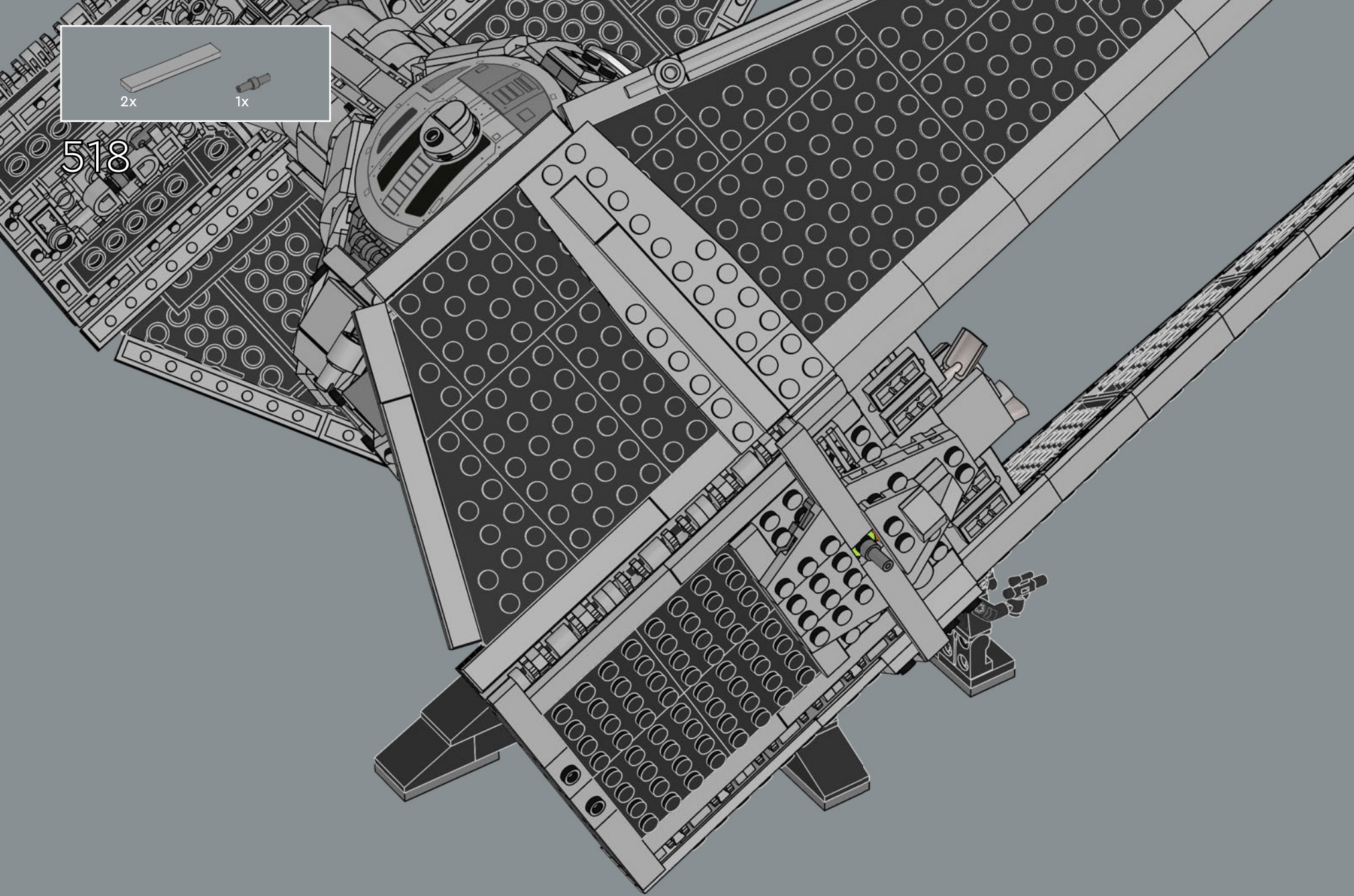



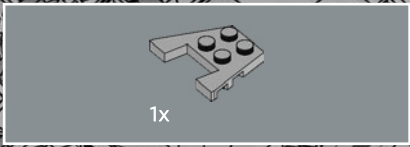

519

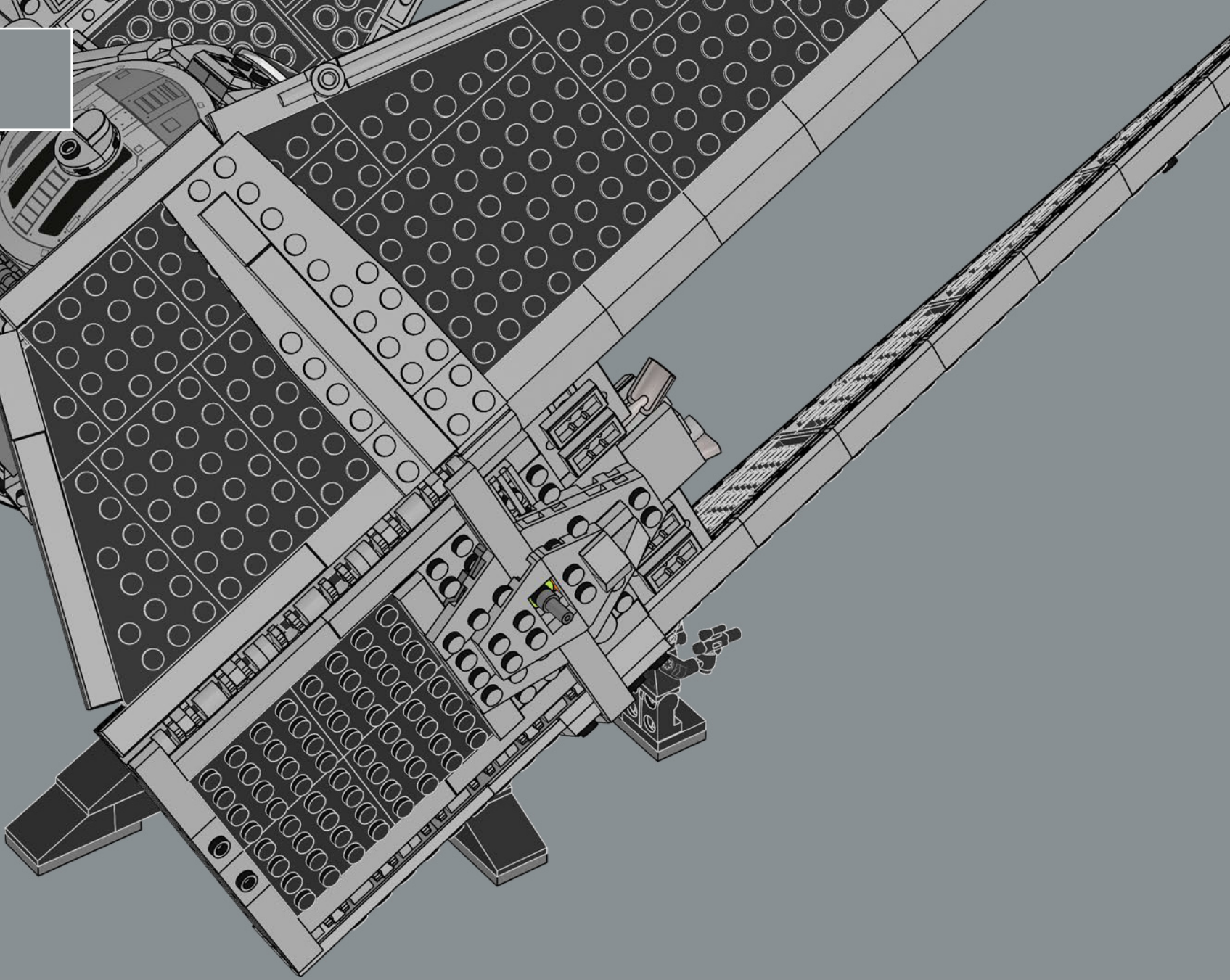





520

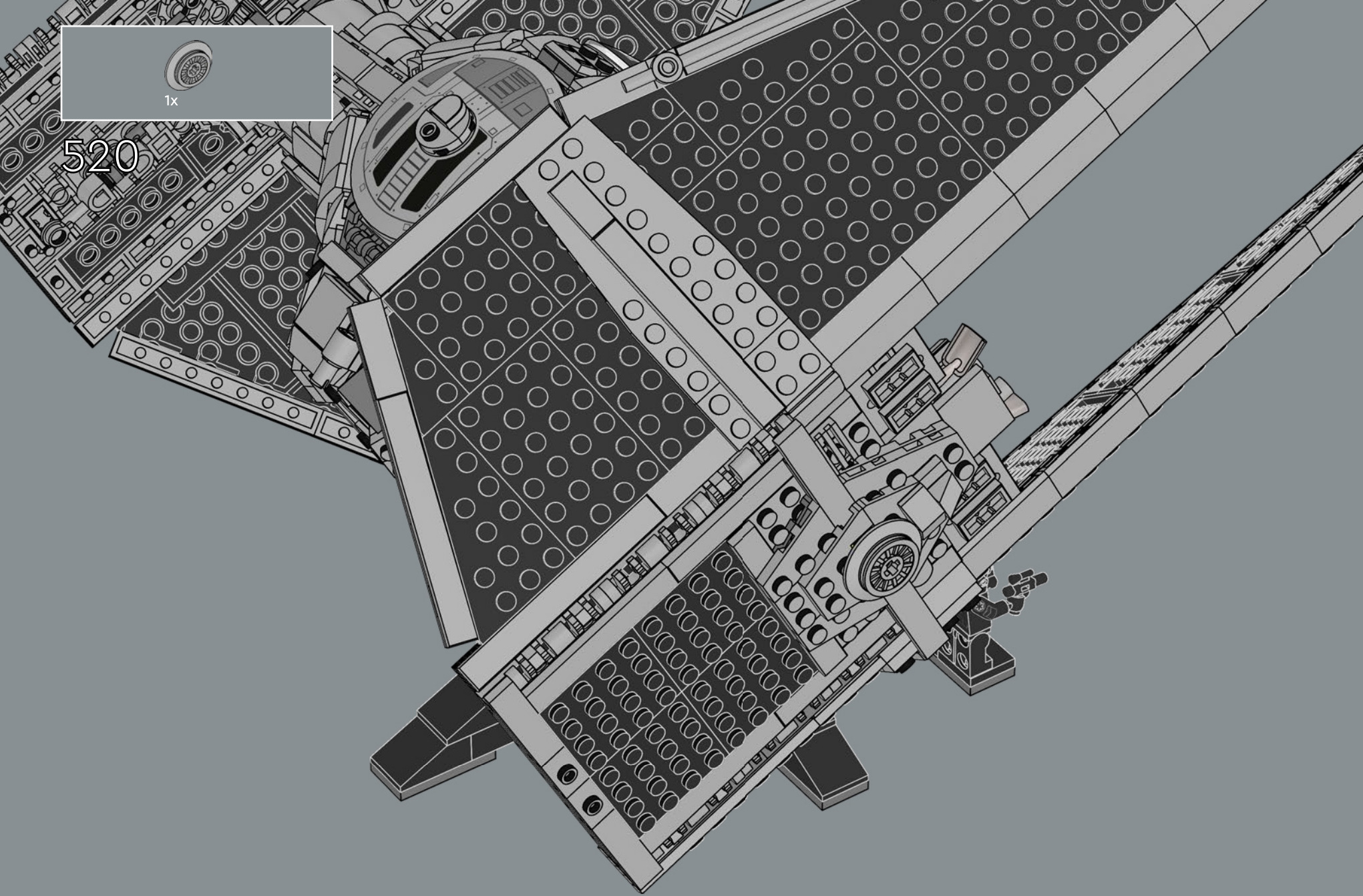

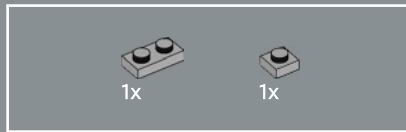
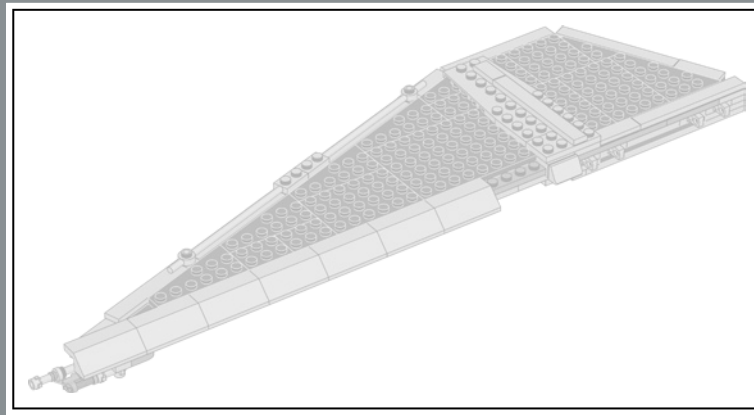

521

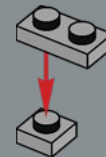

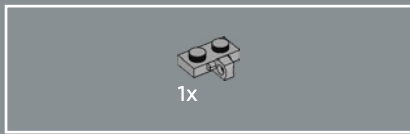

522

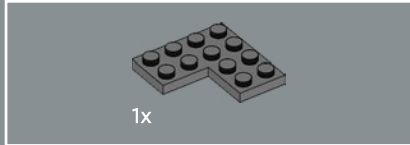
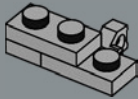

523

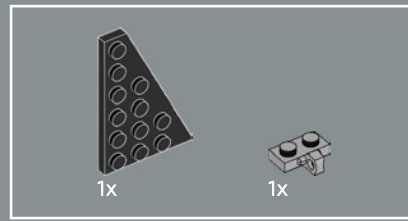
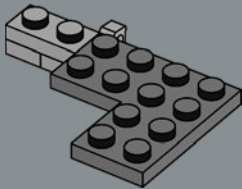

524

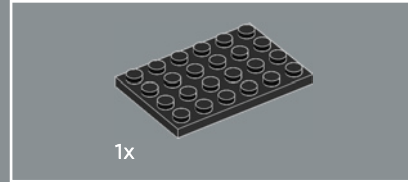
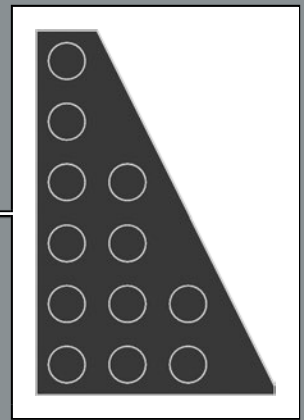
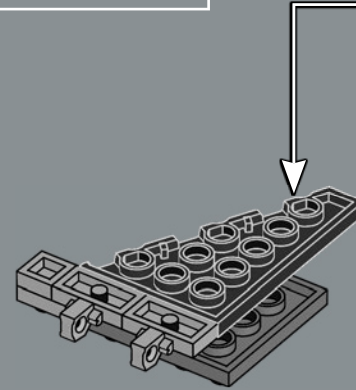

525

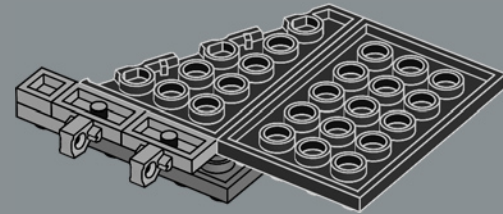

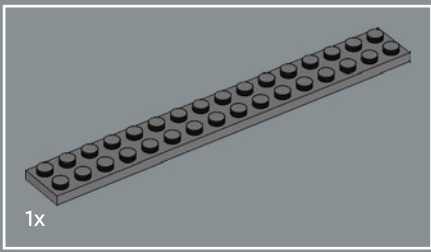

526

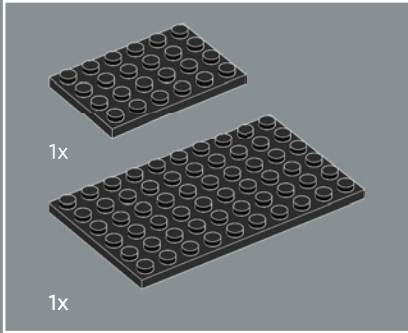
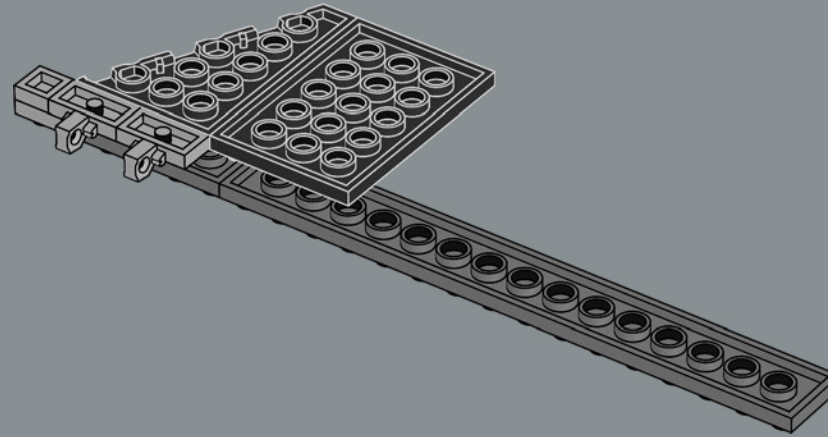

527

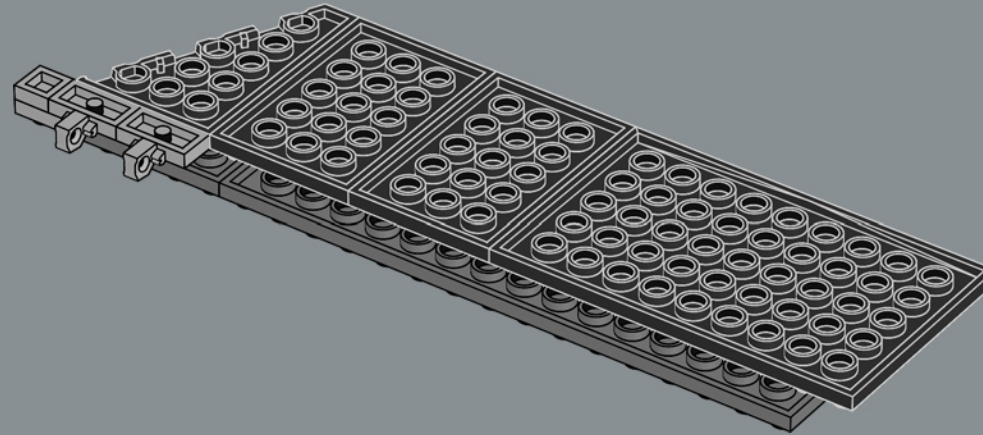



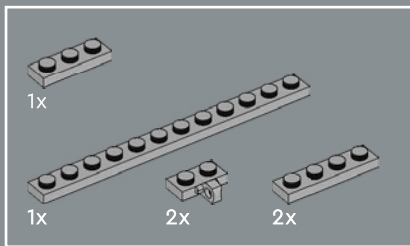

528

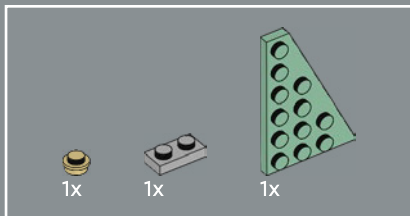
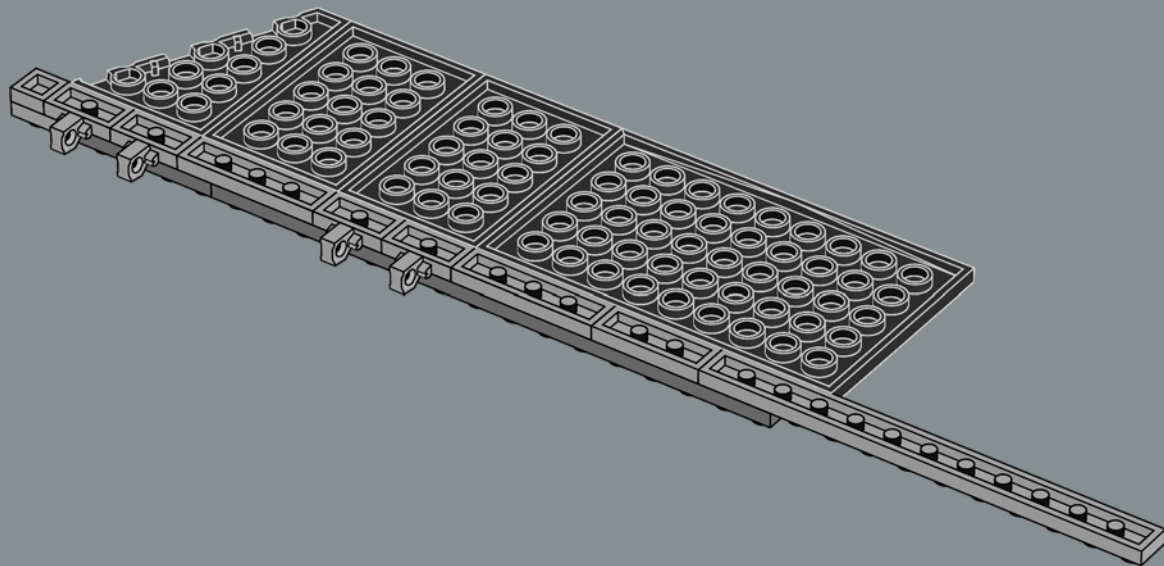

529

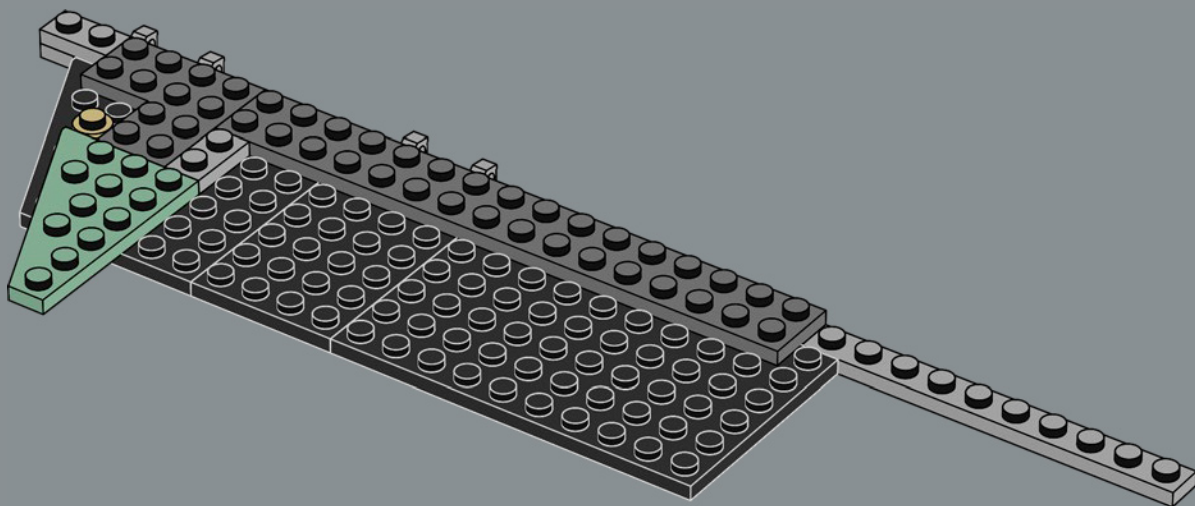

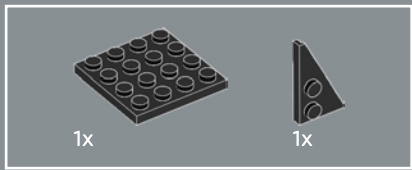

530

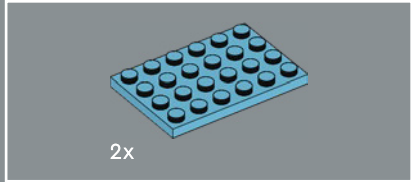
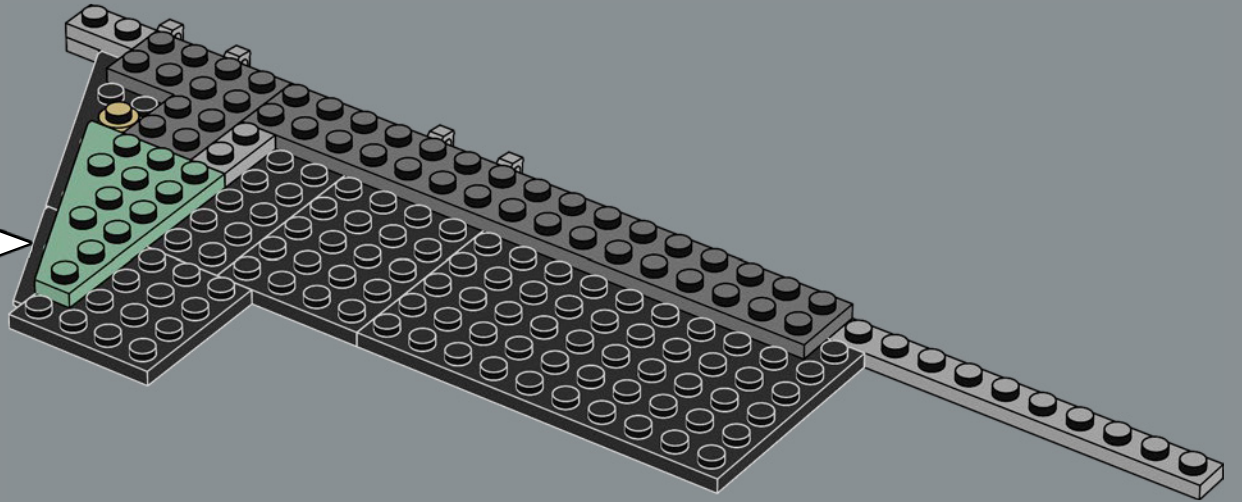
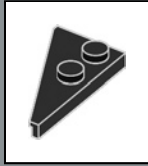

531

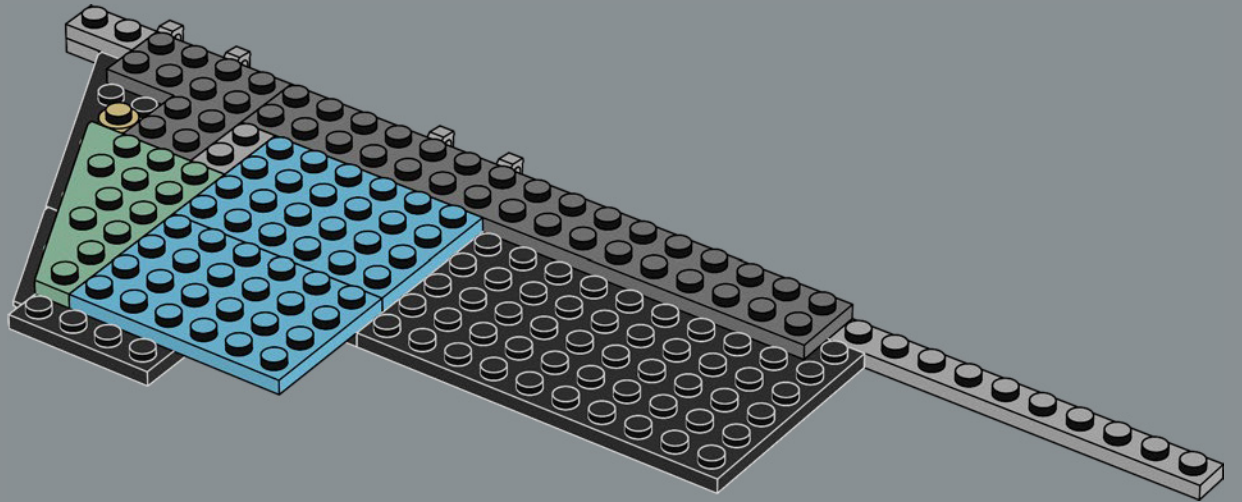

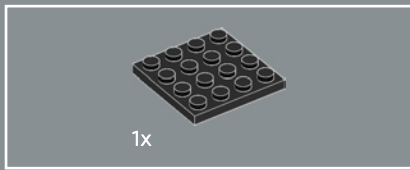

532

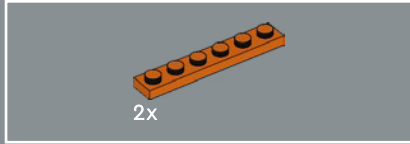
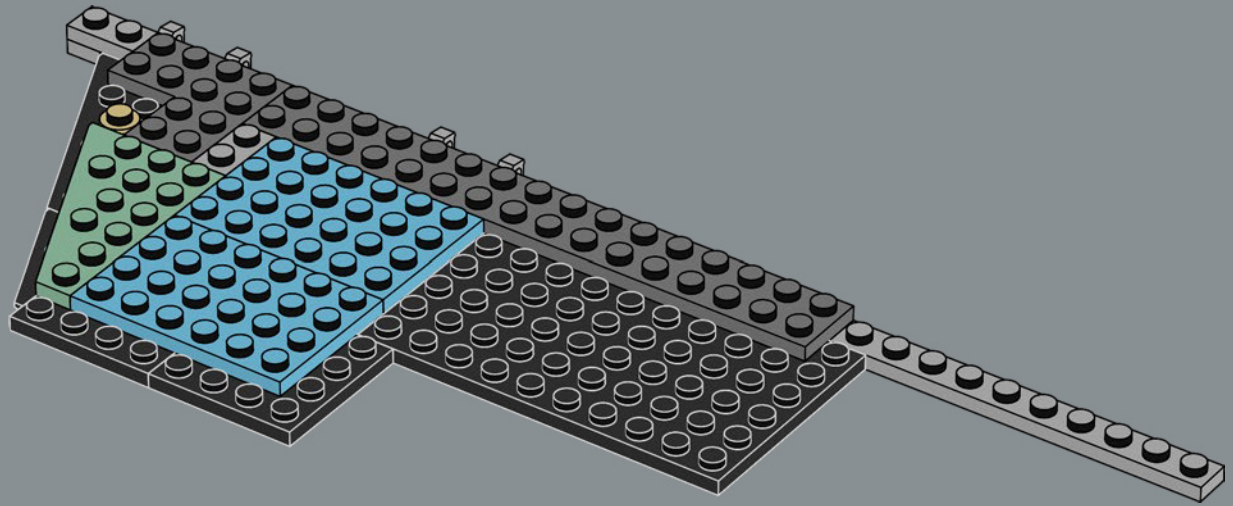

533

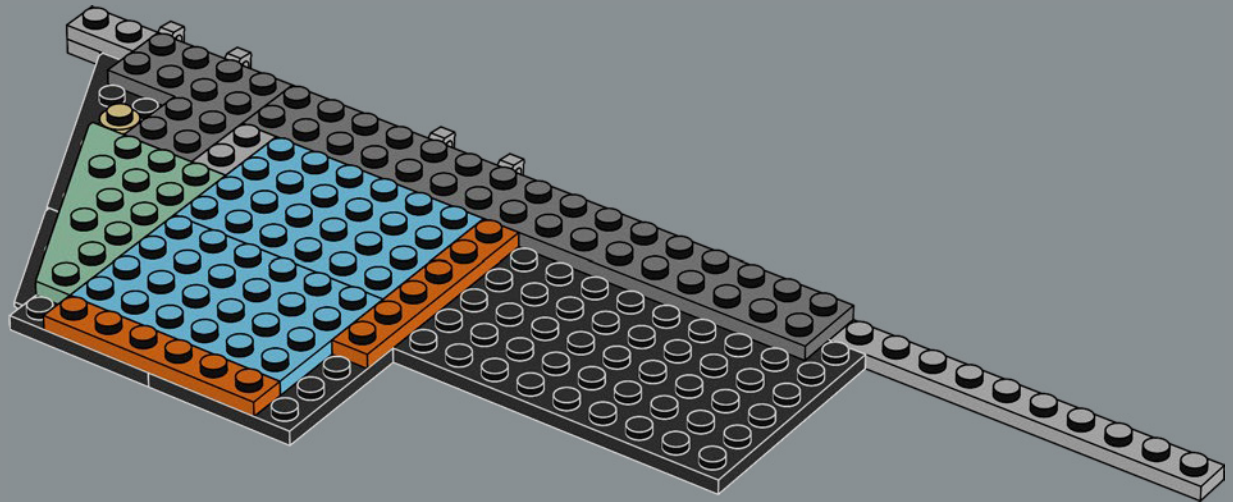



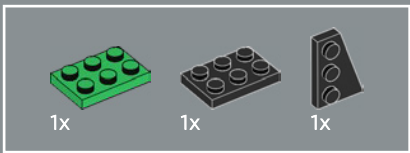

534

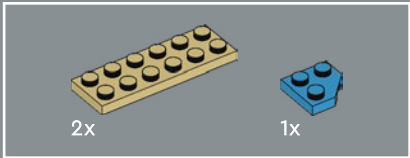
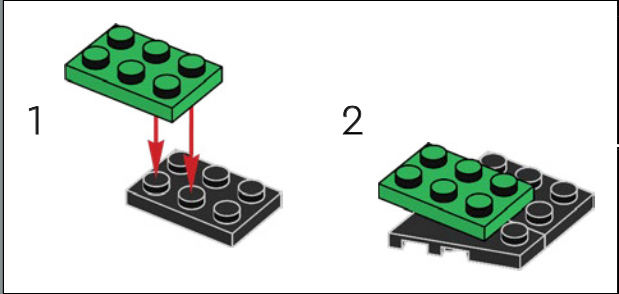
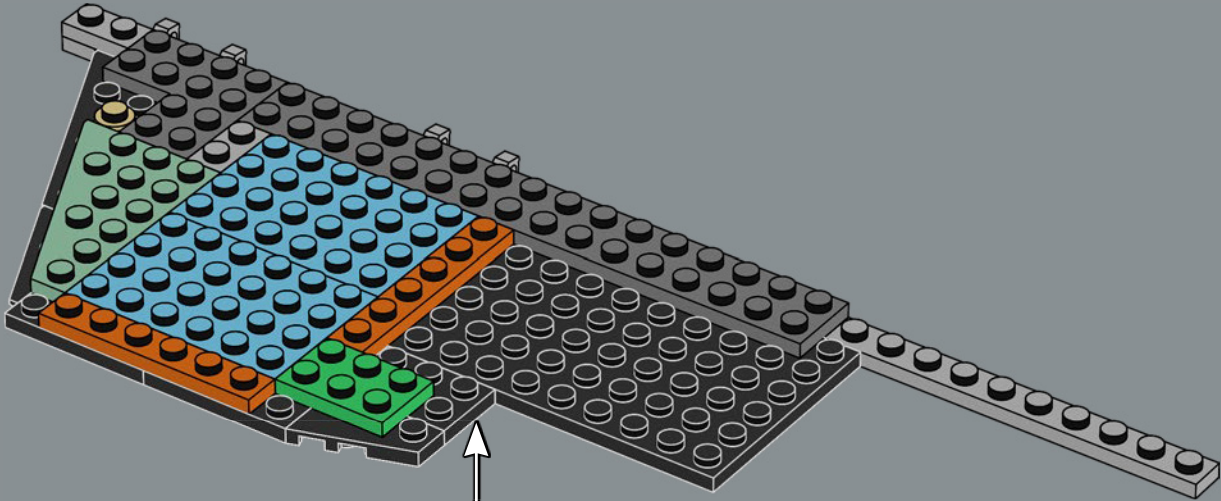

535





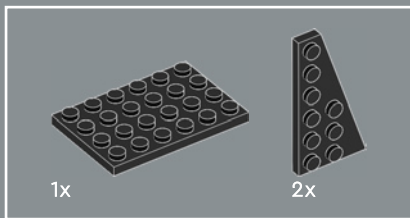

536

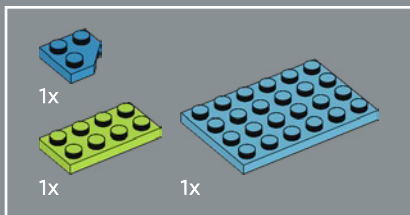
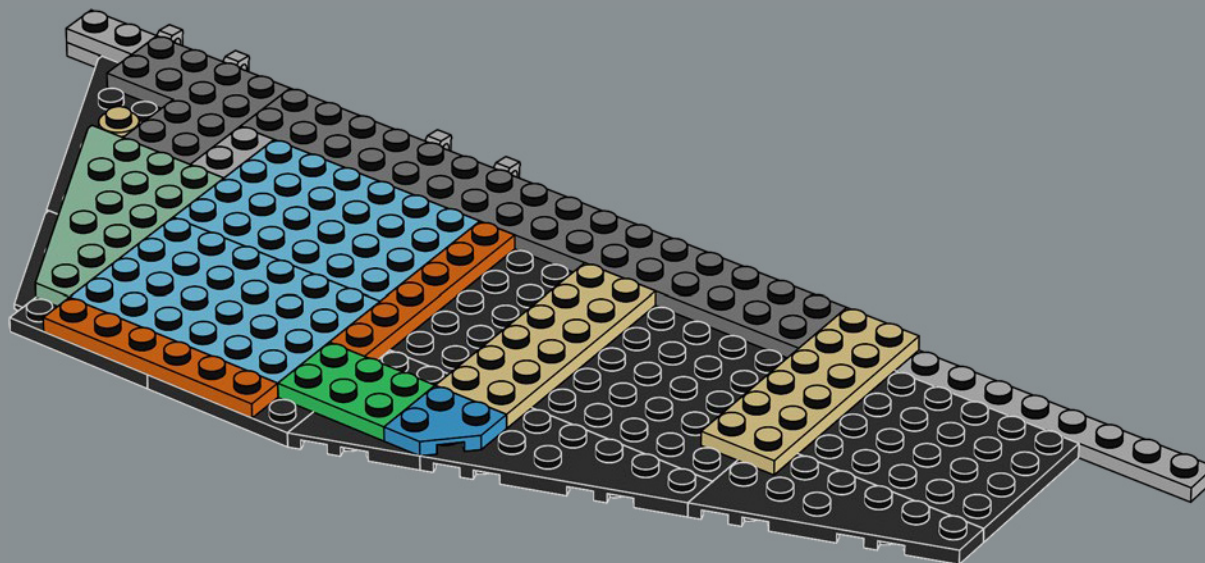

537

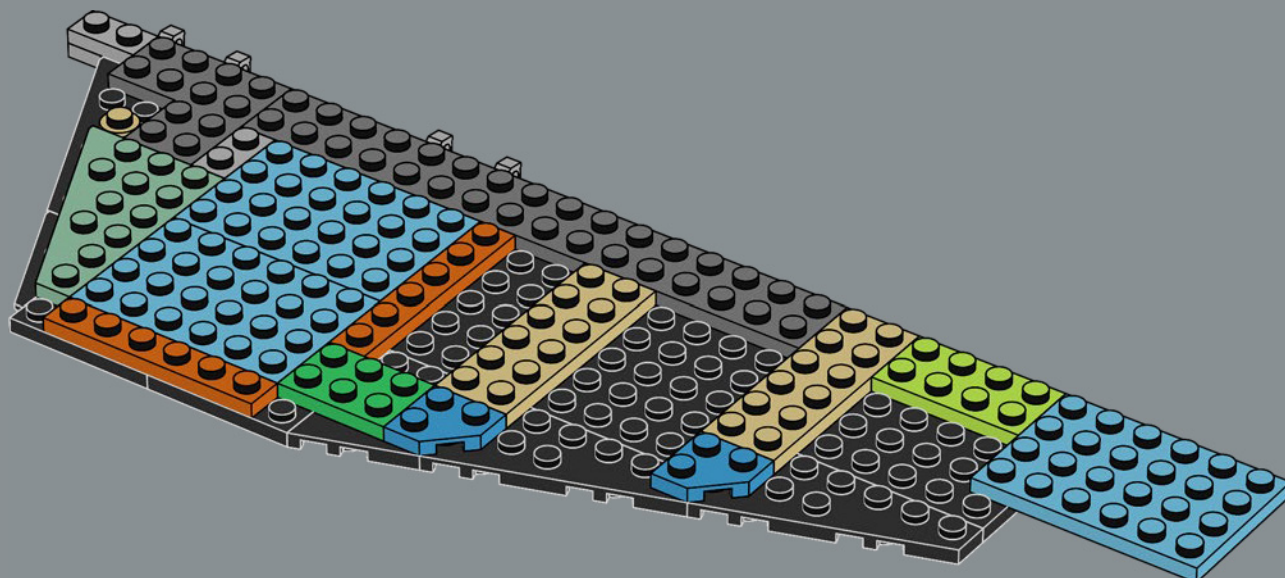

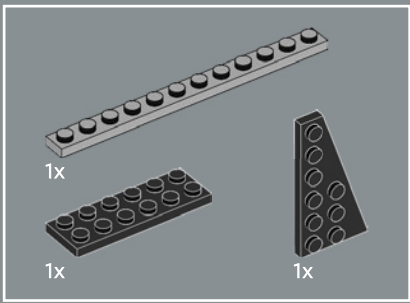

538

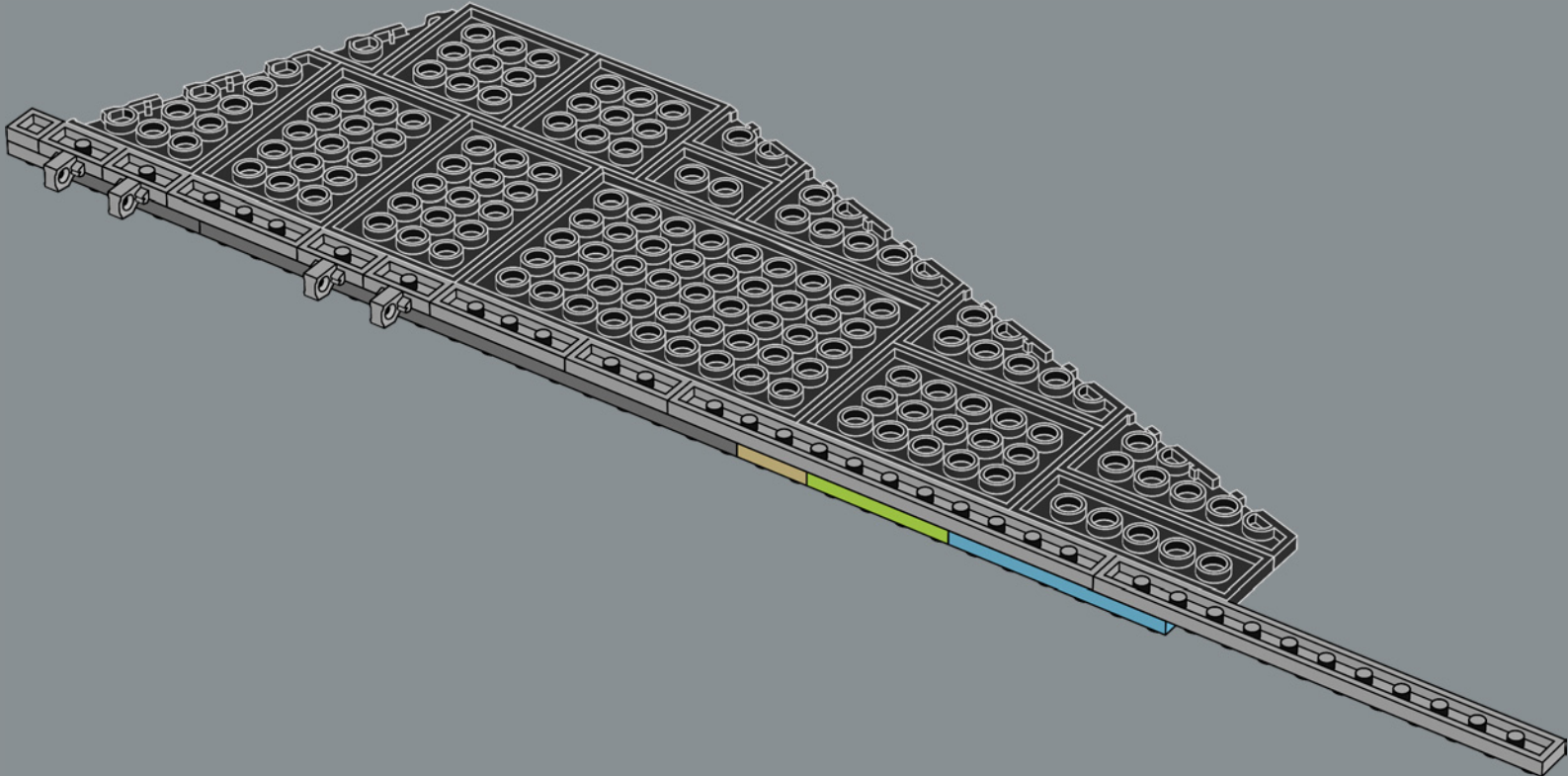

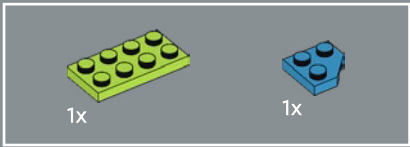

539

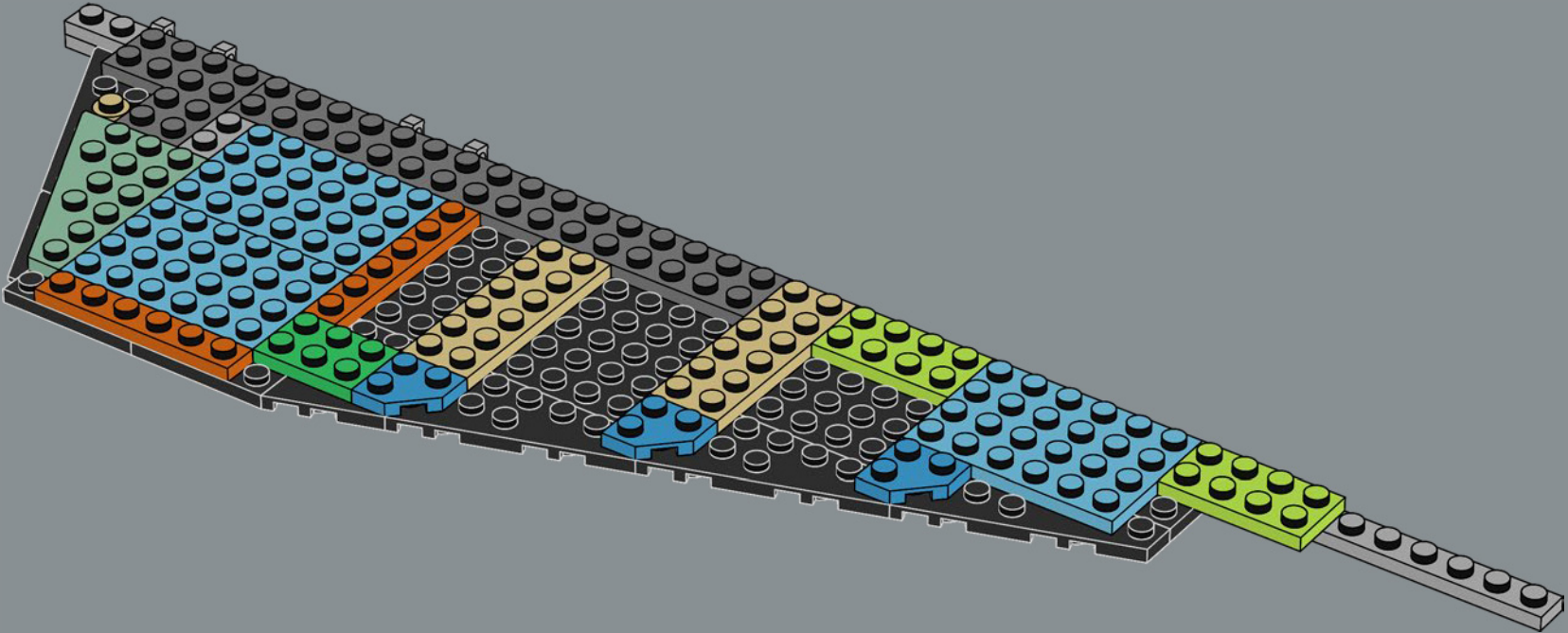

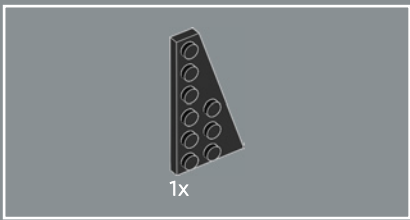

540

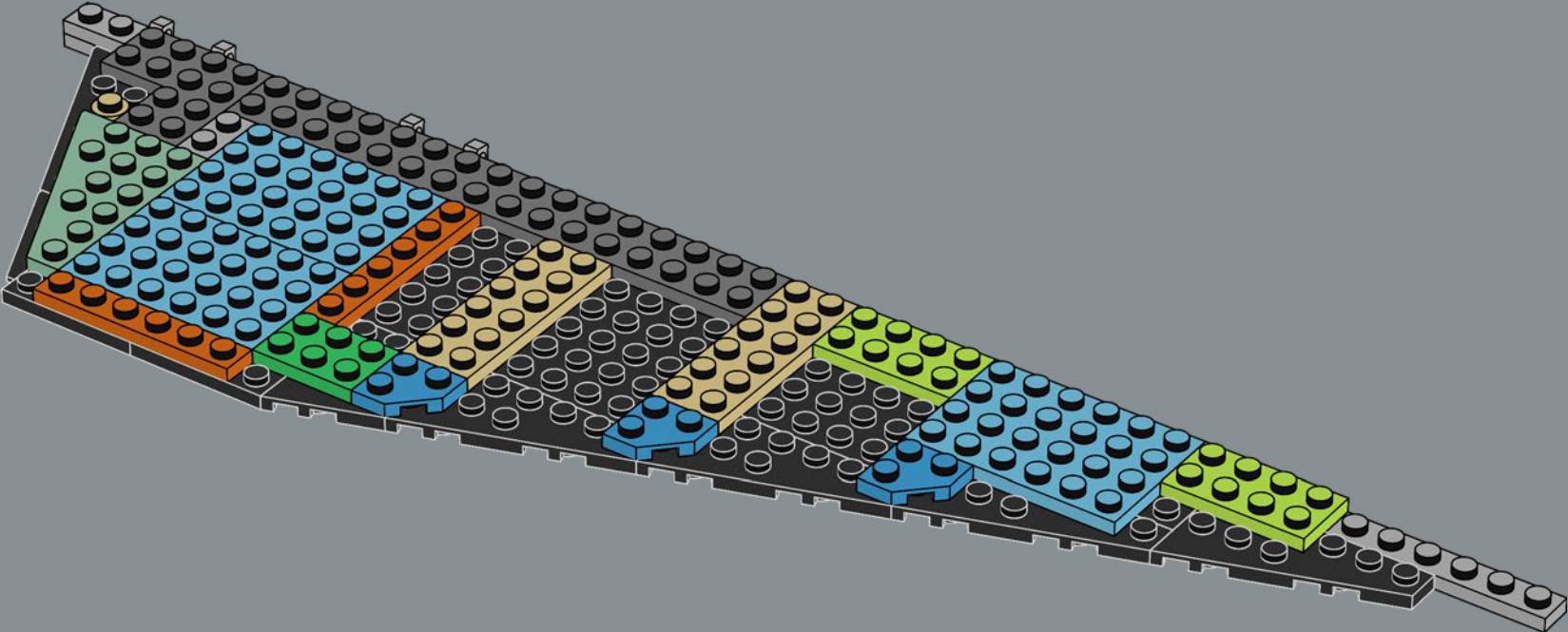



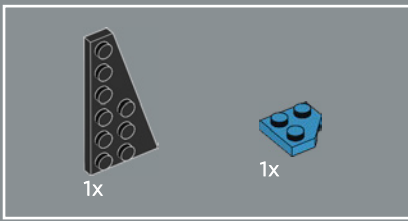

541

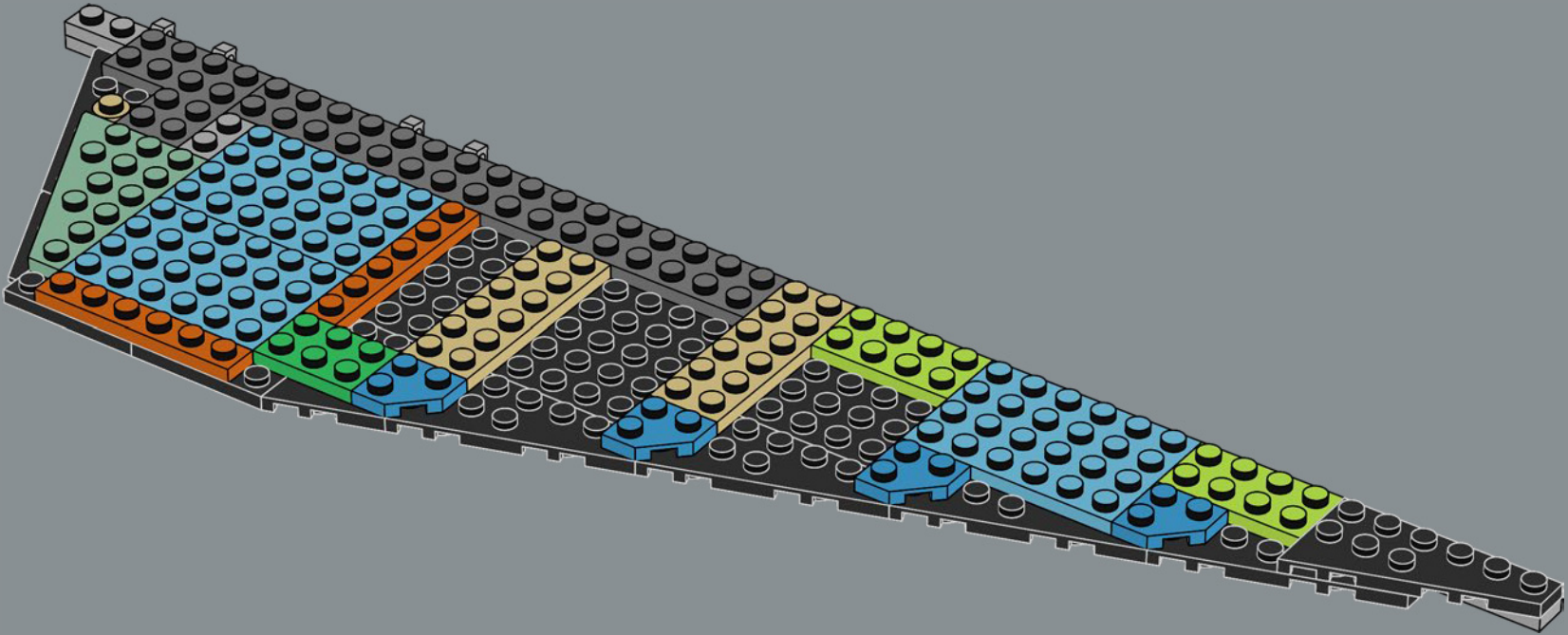

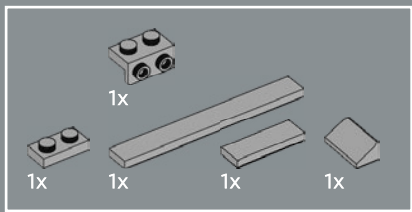

542

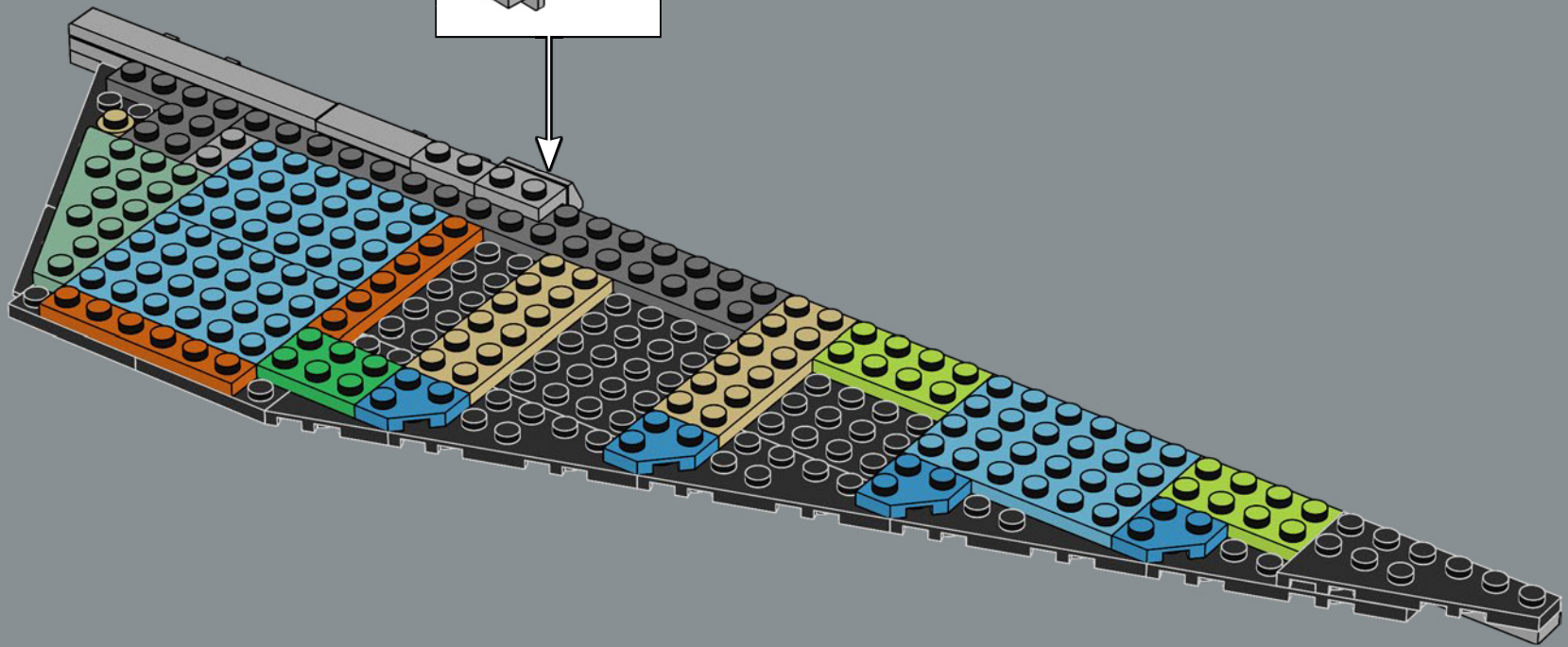
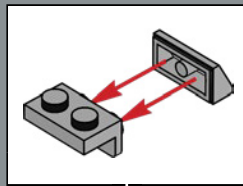

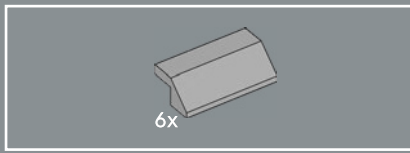

543

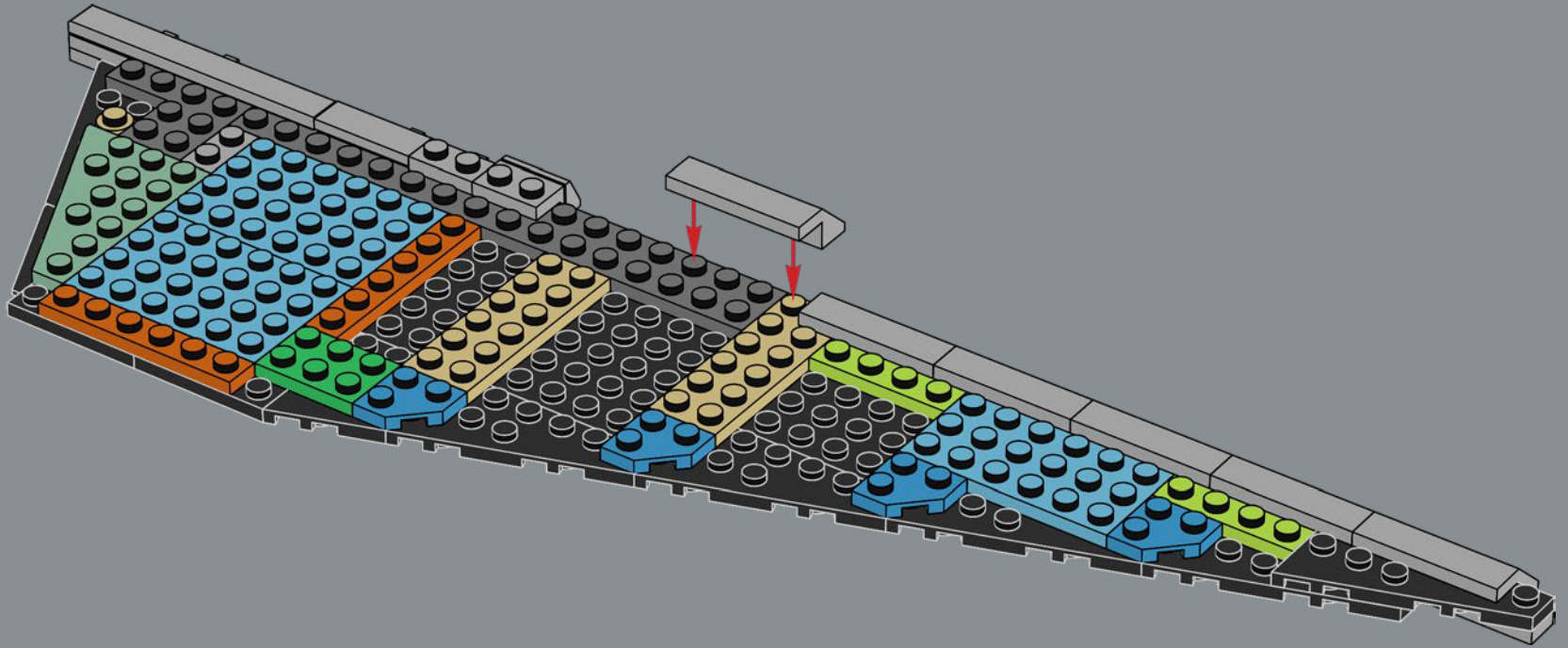

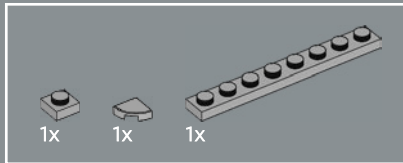
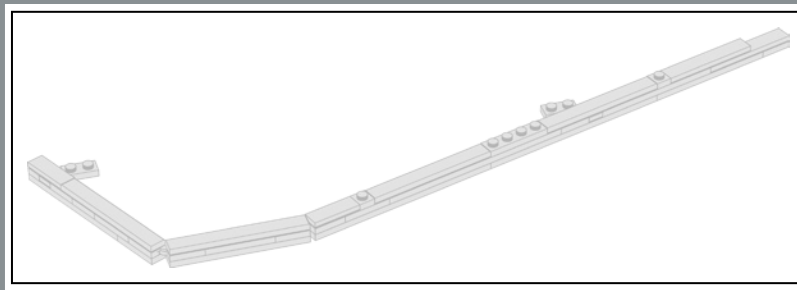

544

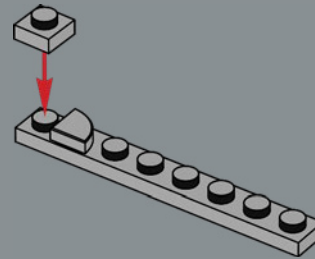



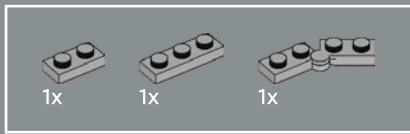

545

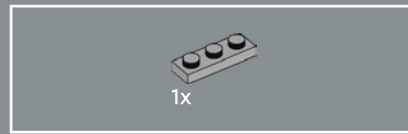
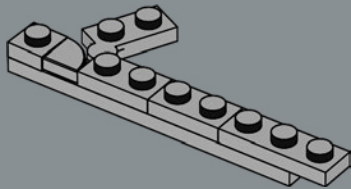

546

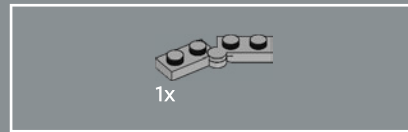
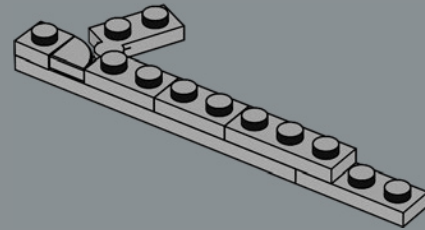

547

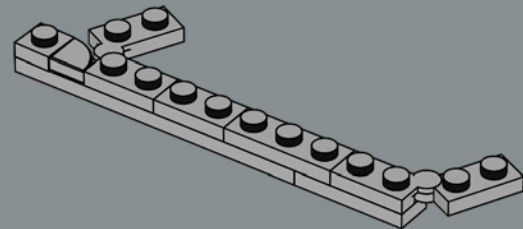

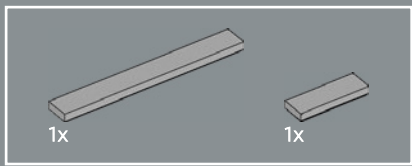

548

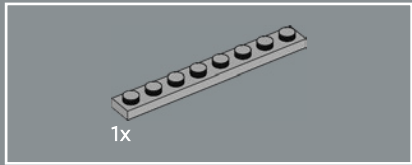
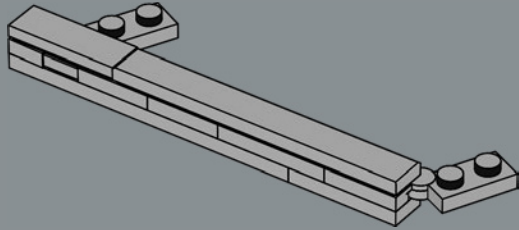

549

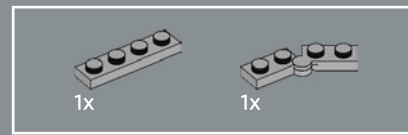
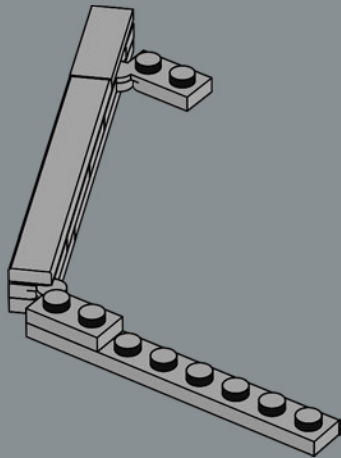

550

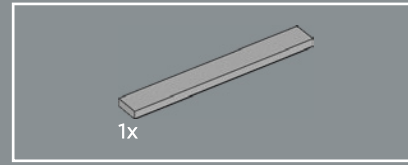
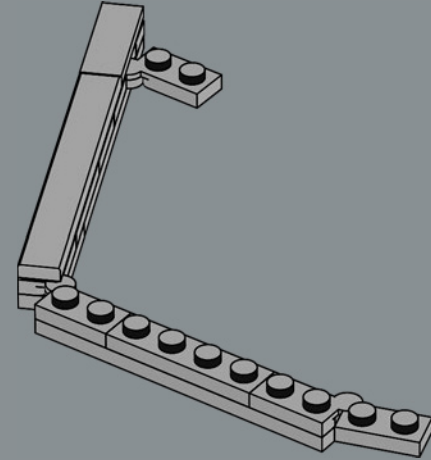

551

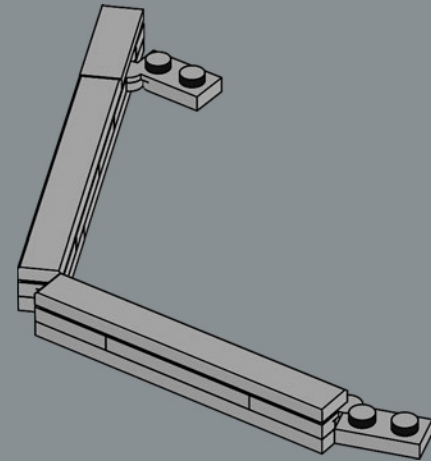

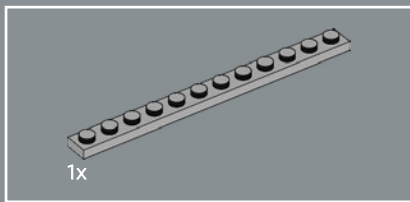

552

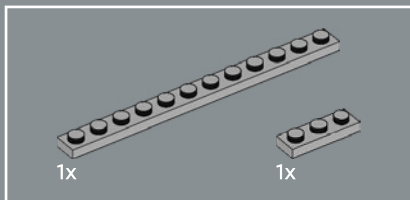
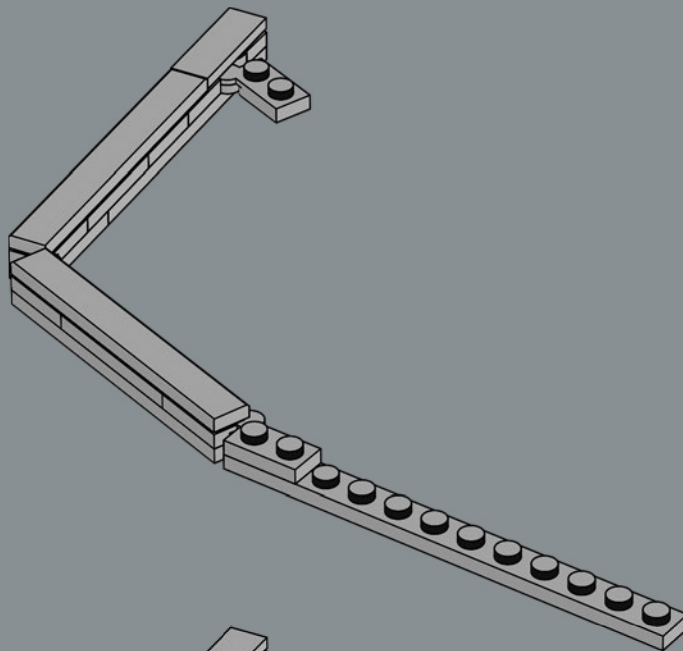

553

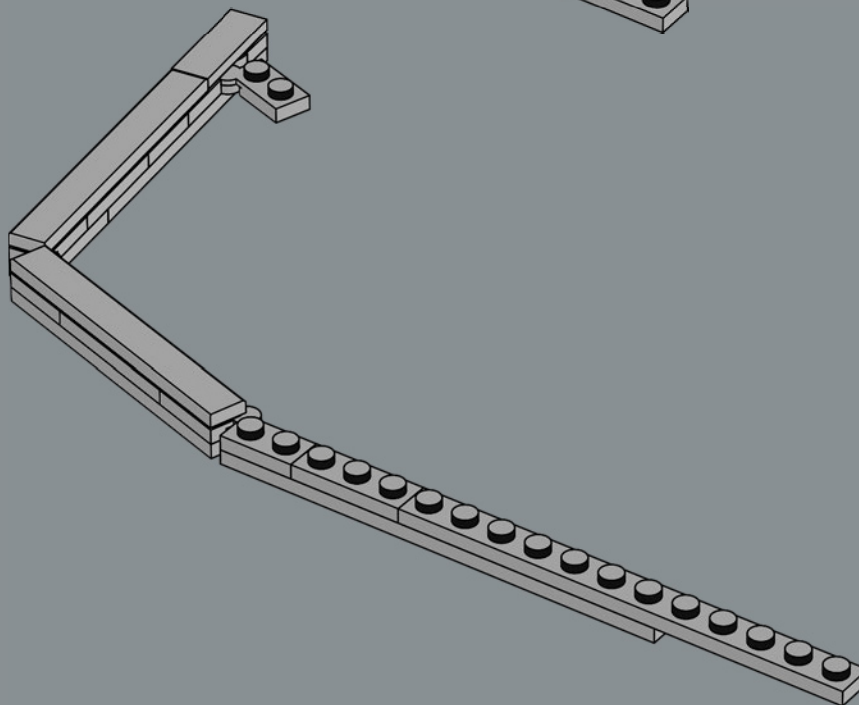

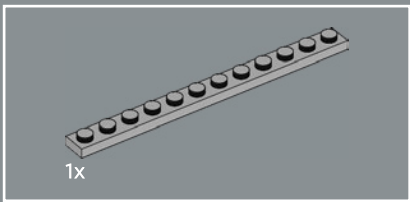

554

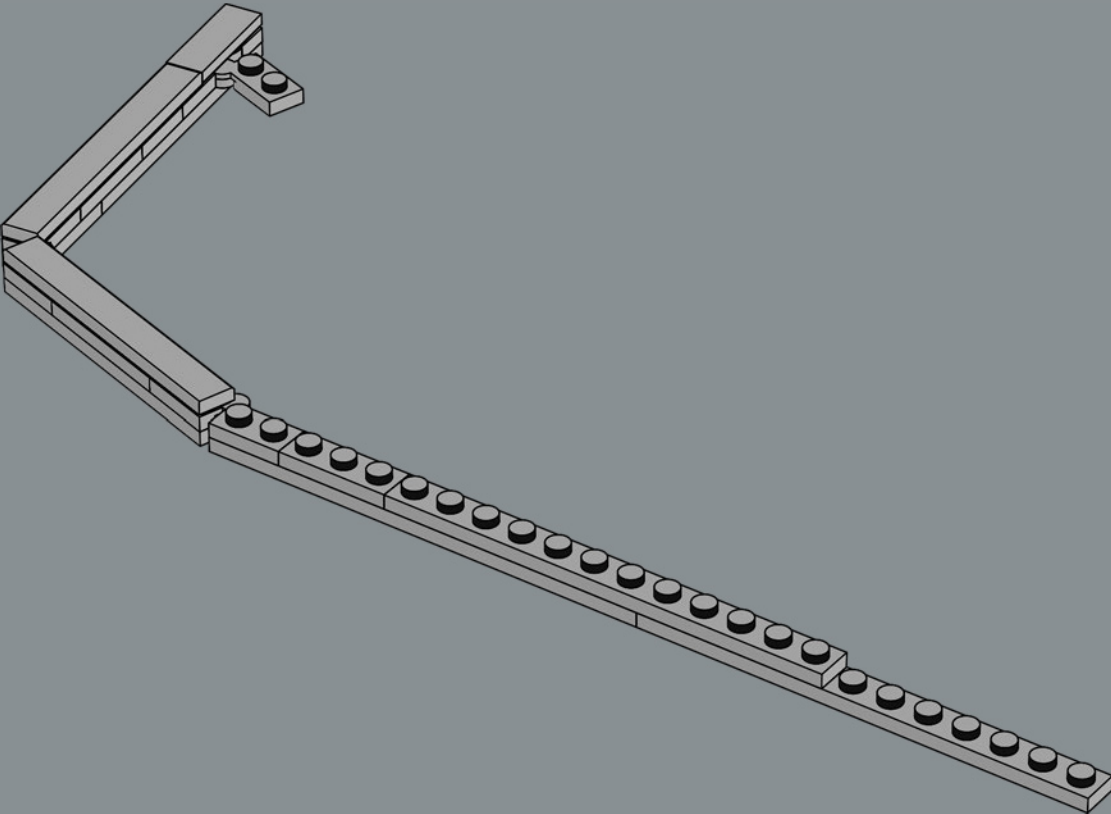



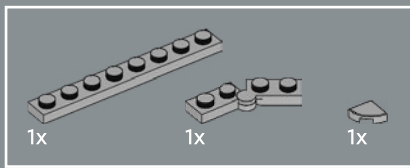

555

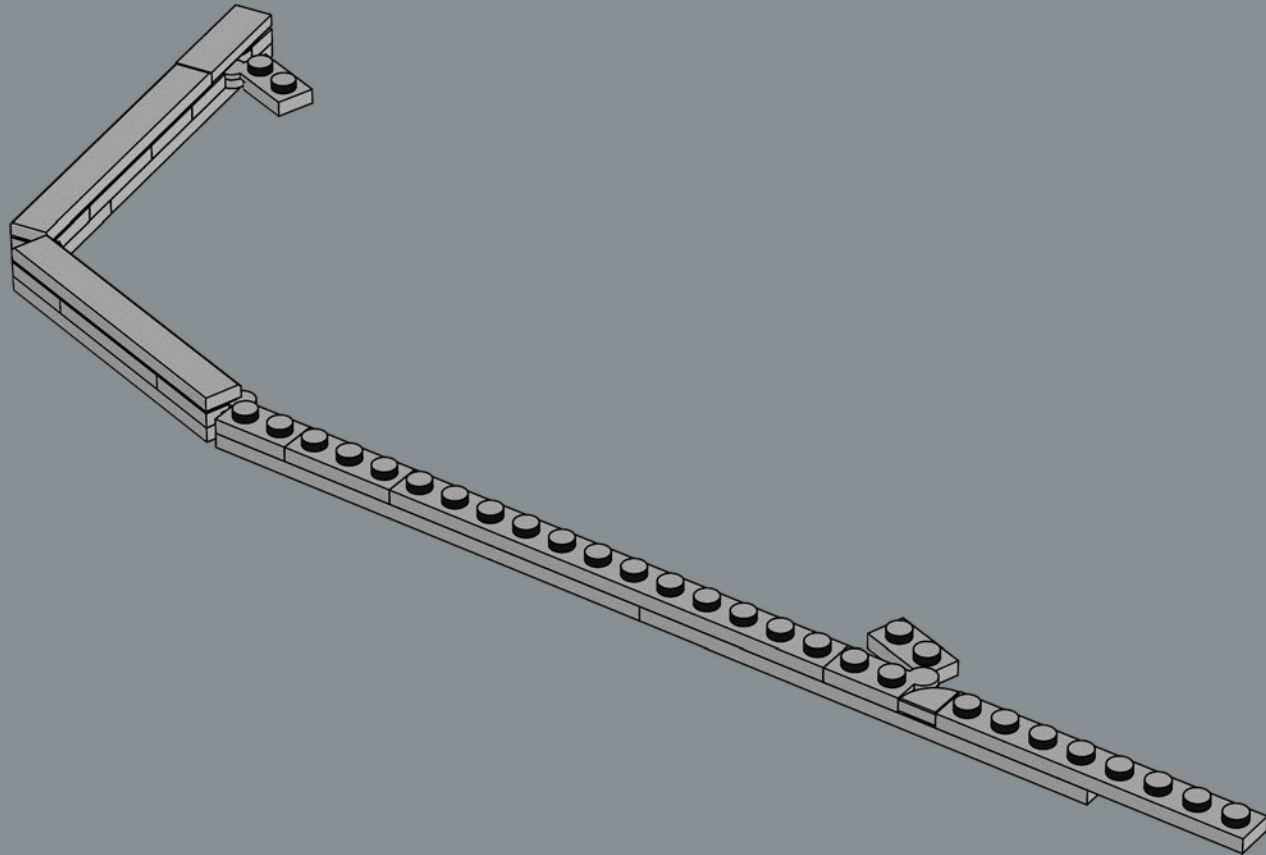

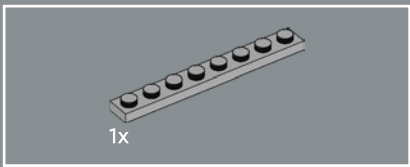

556

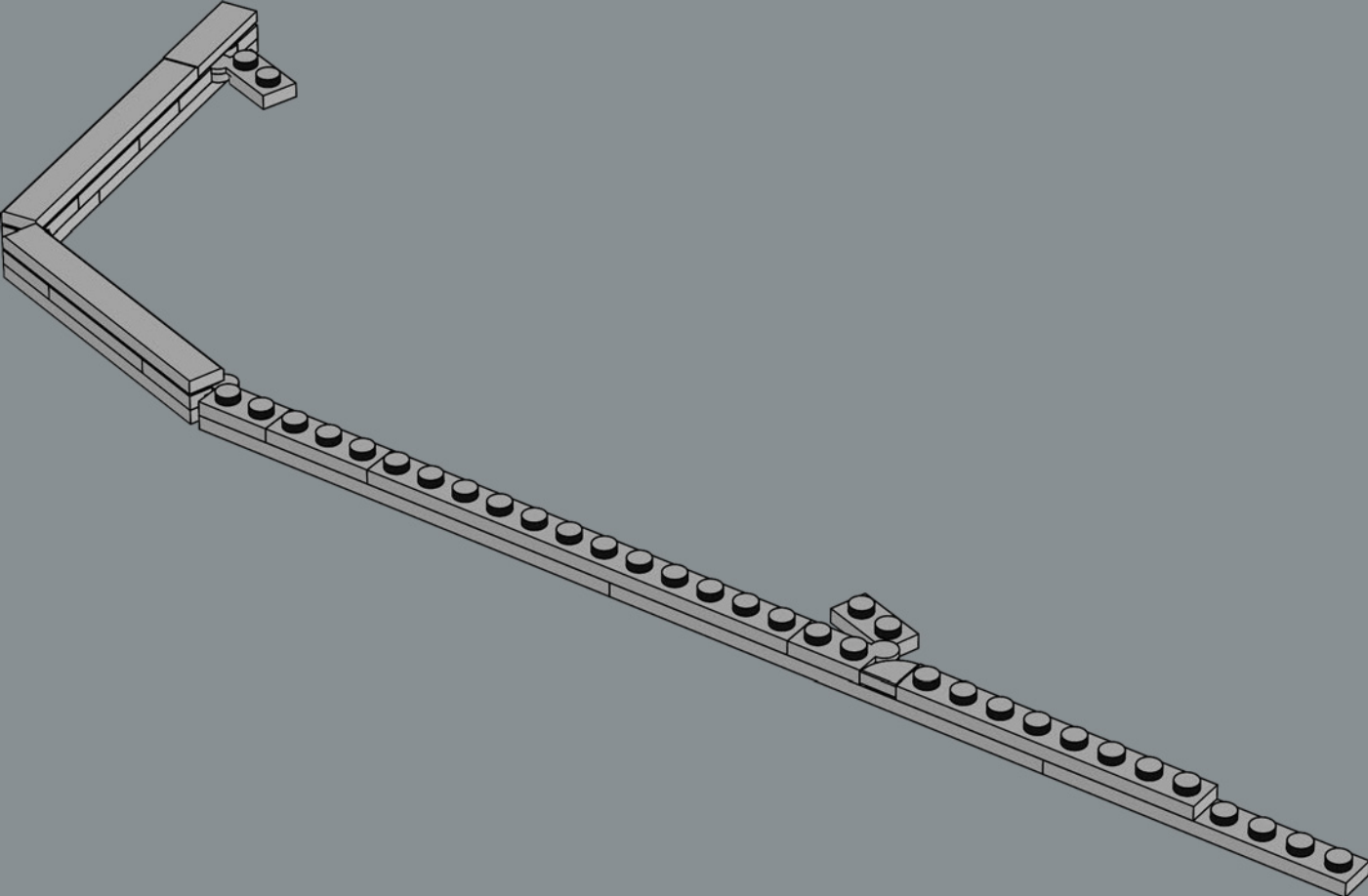

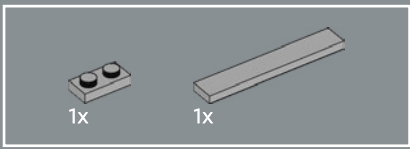

557

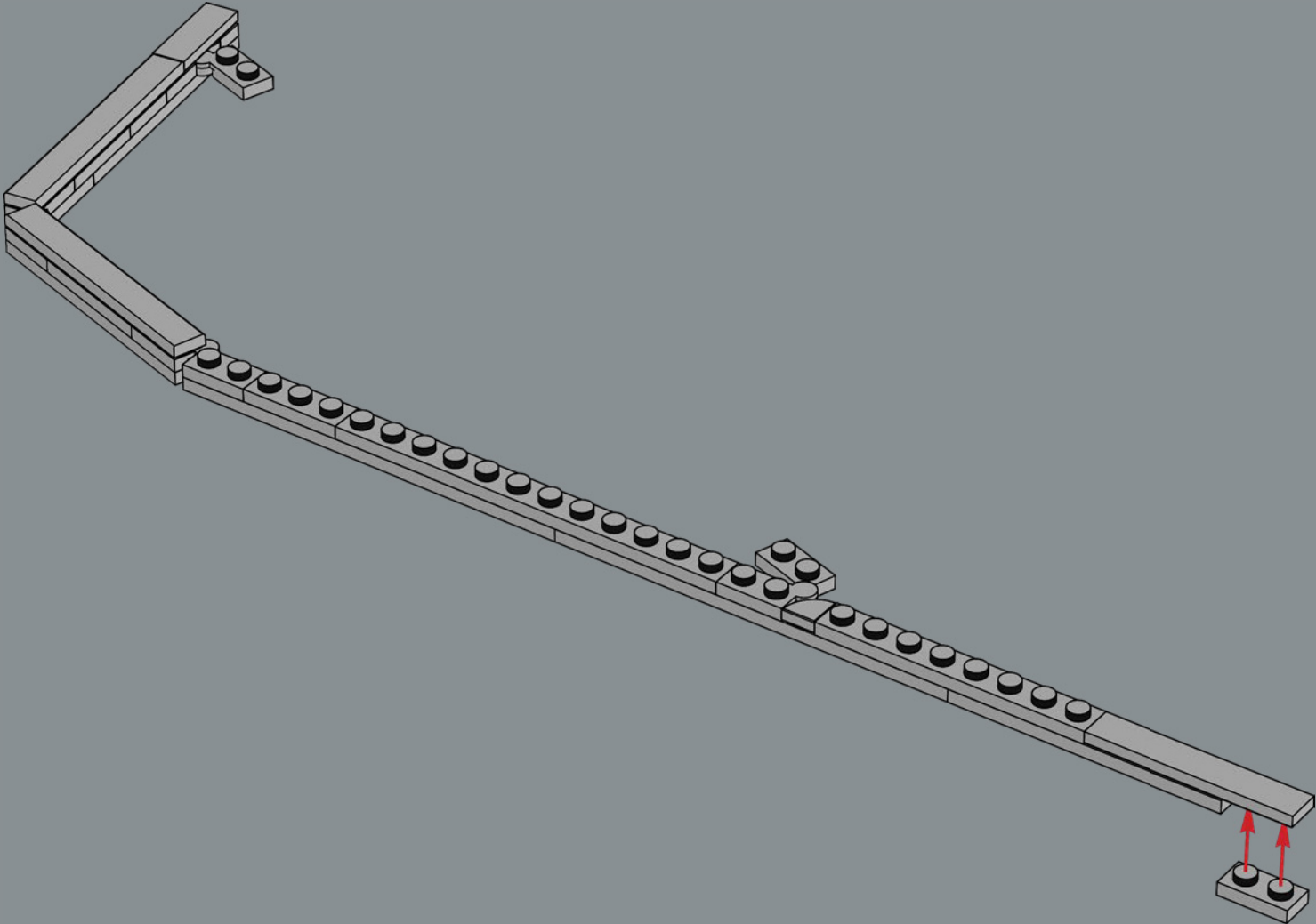

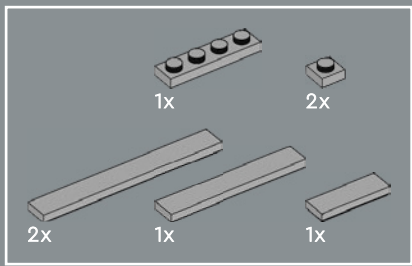

558

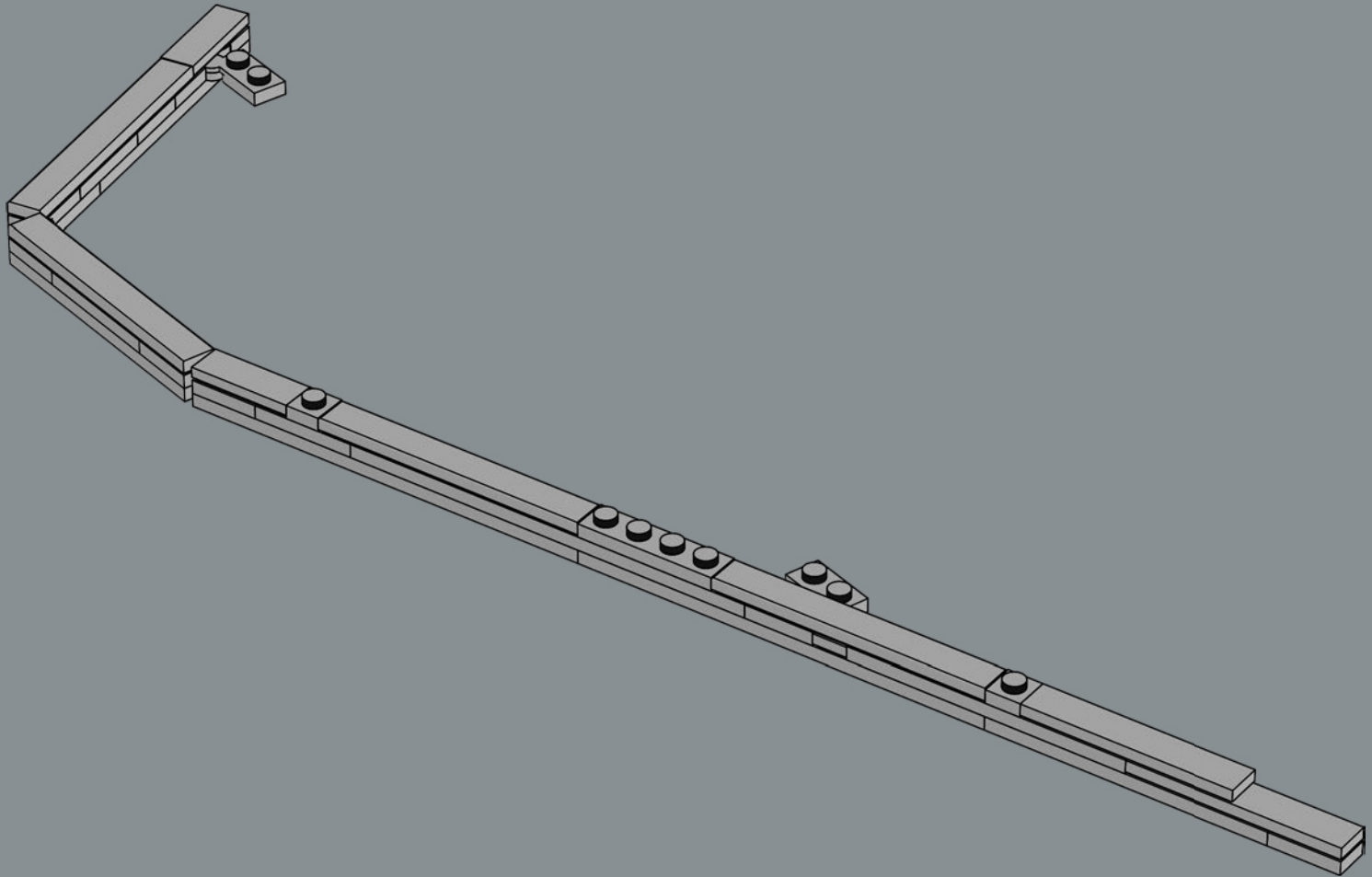



559

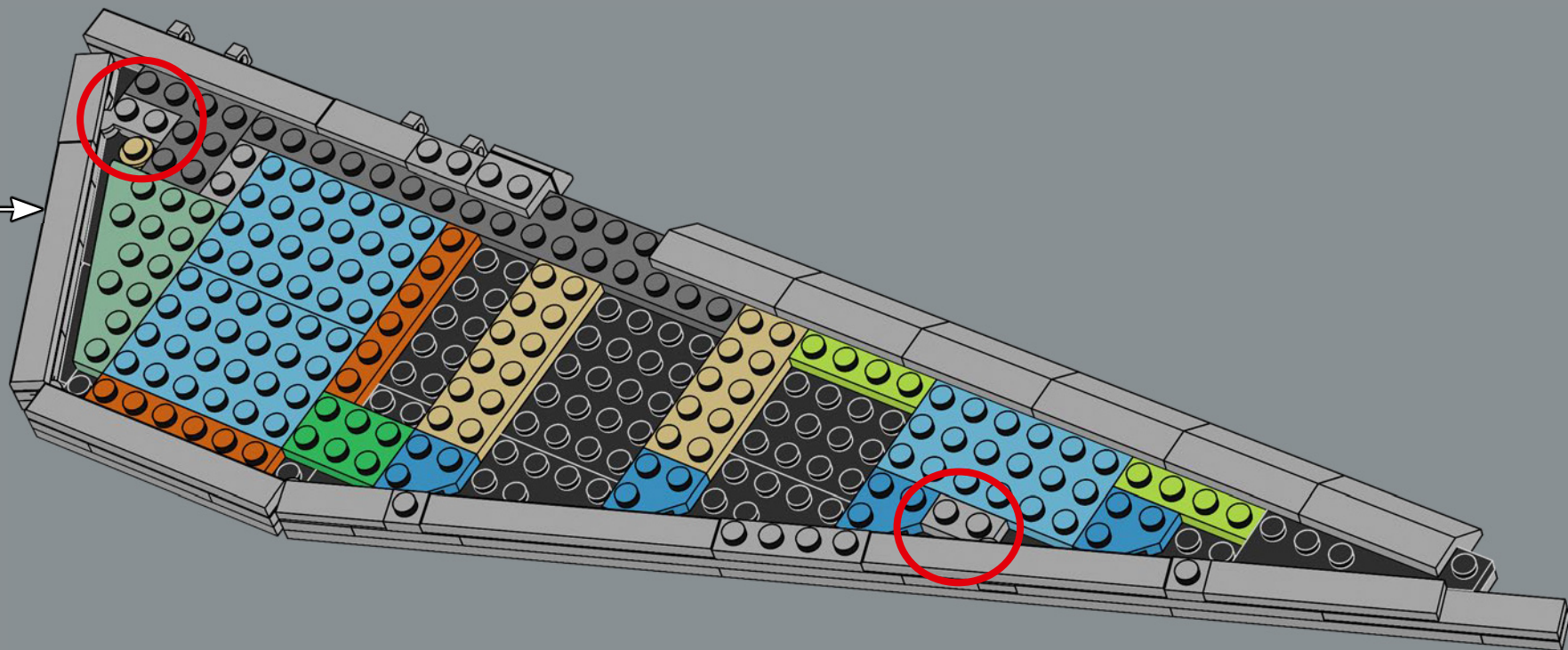

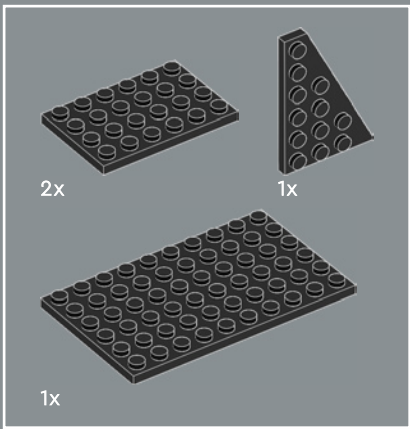

560

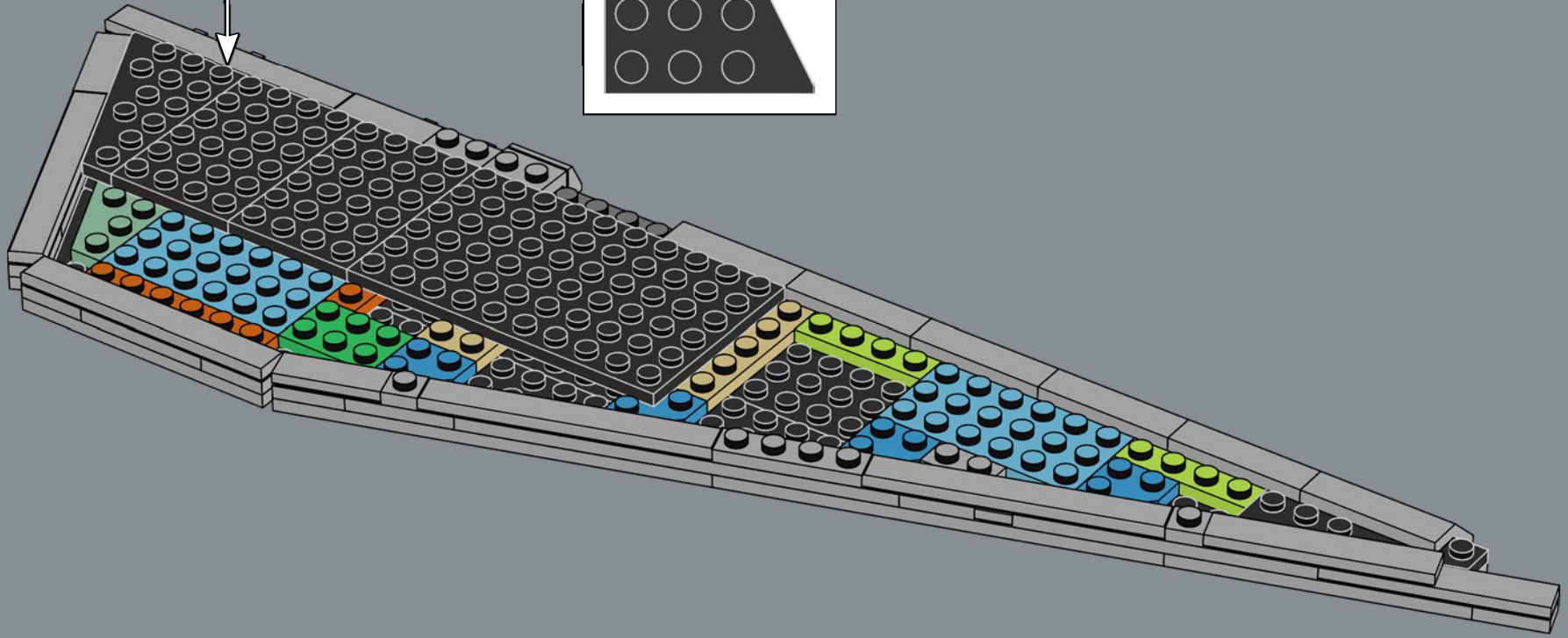
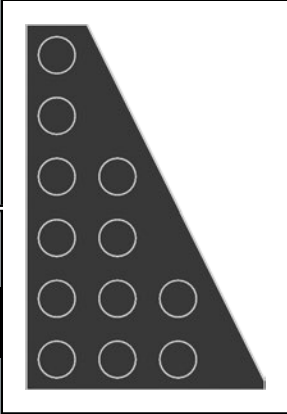

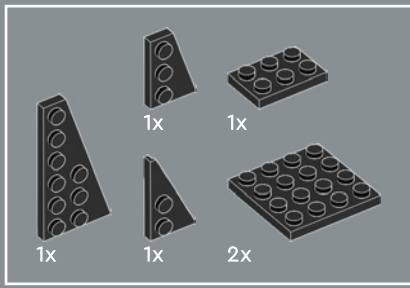

561

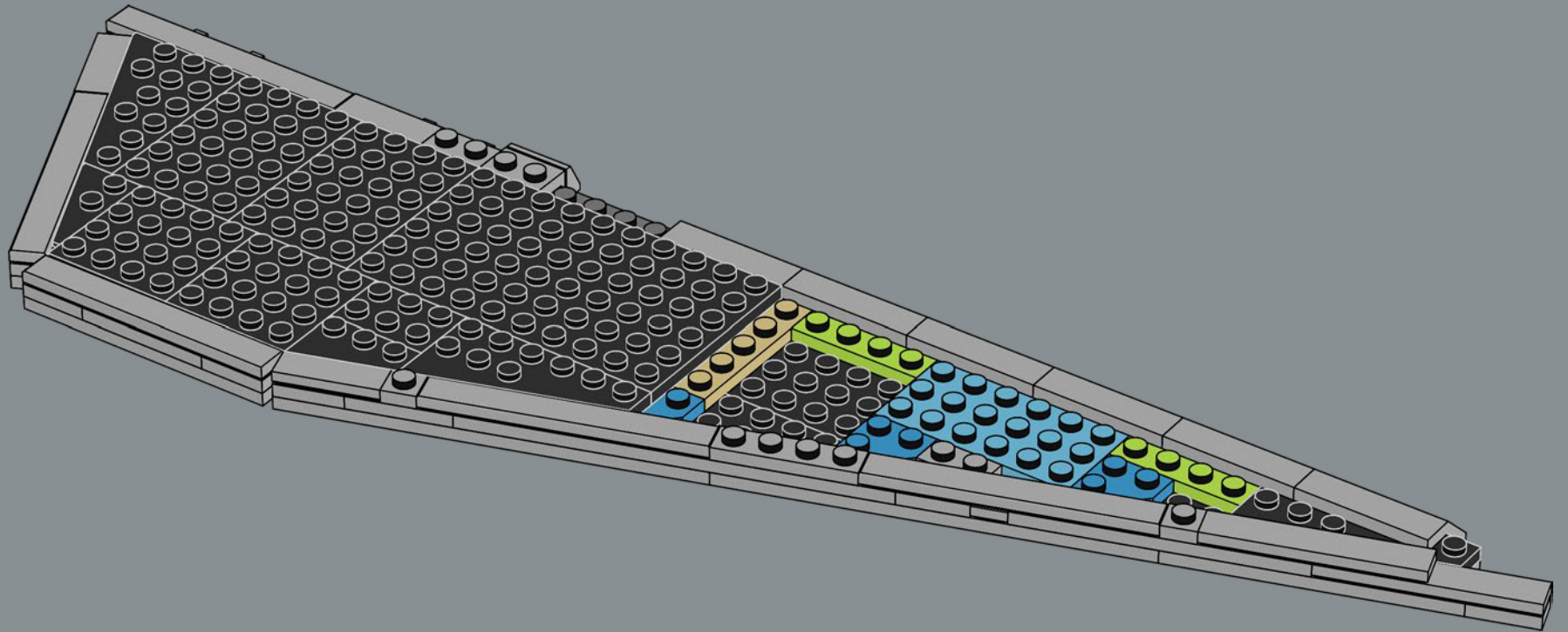

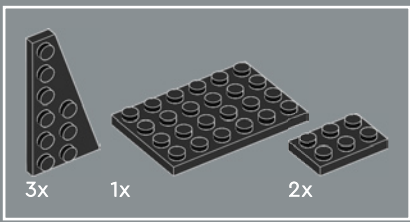

562

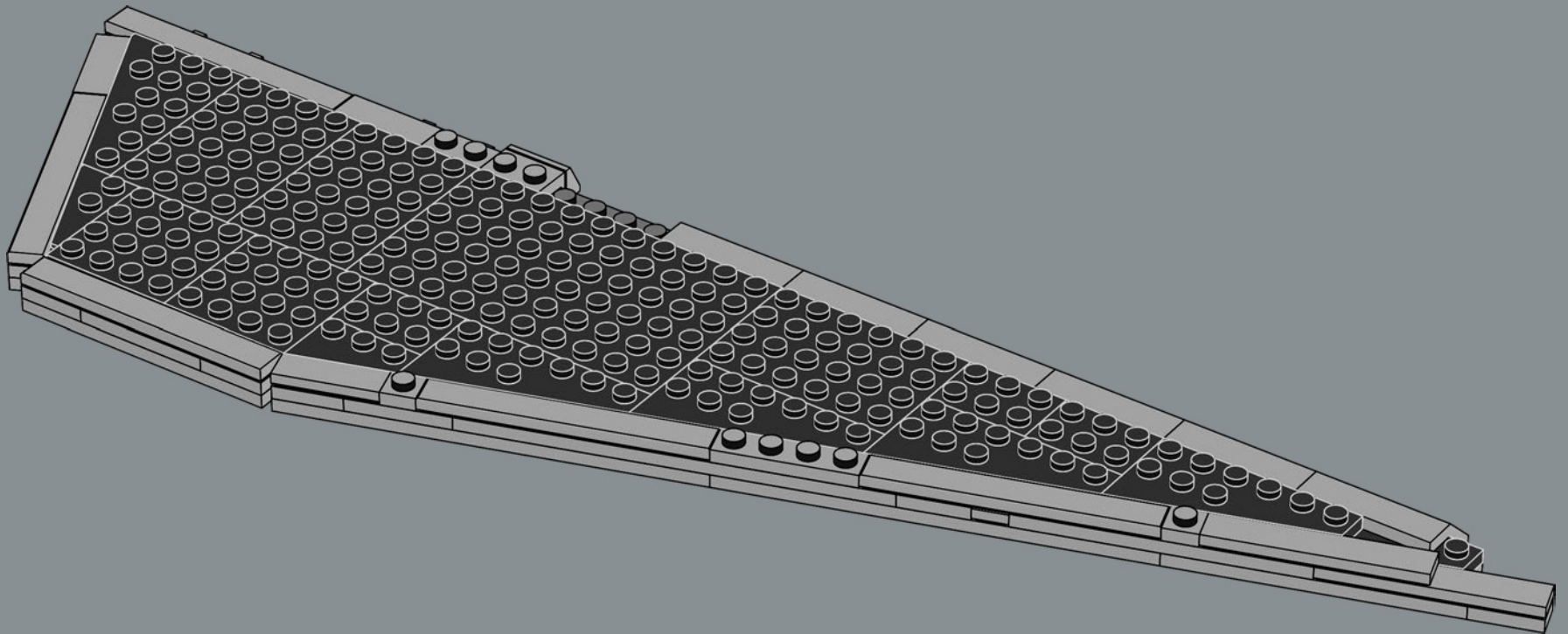



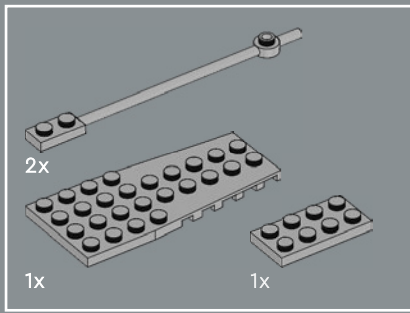

563

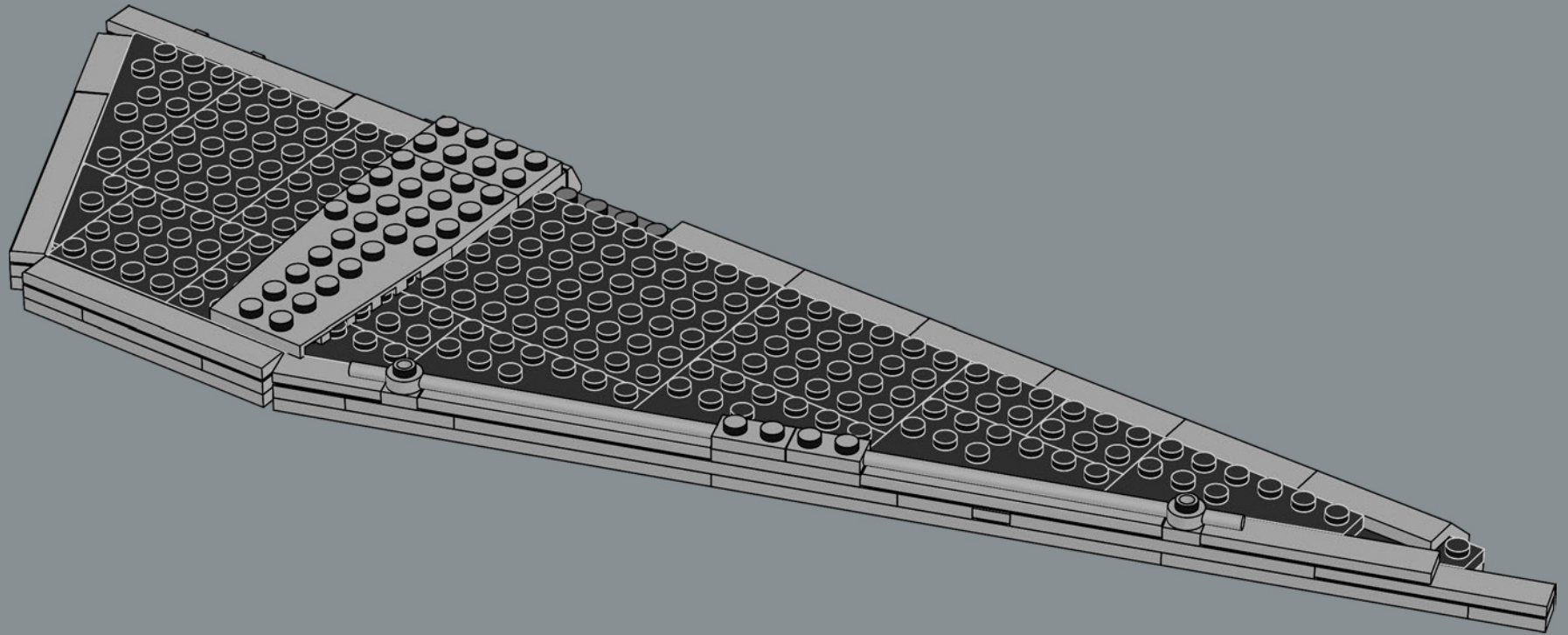

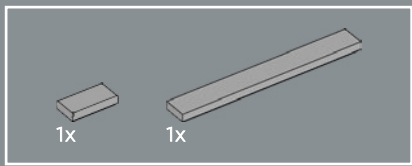

564

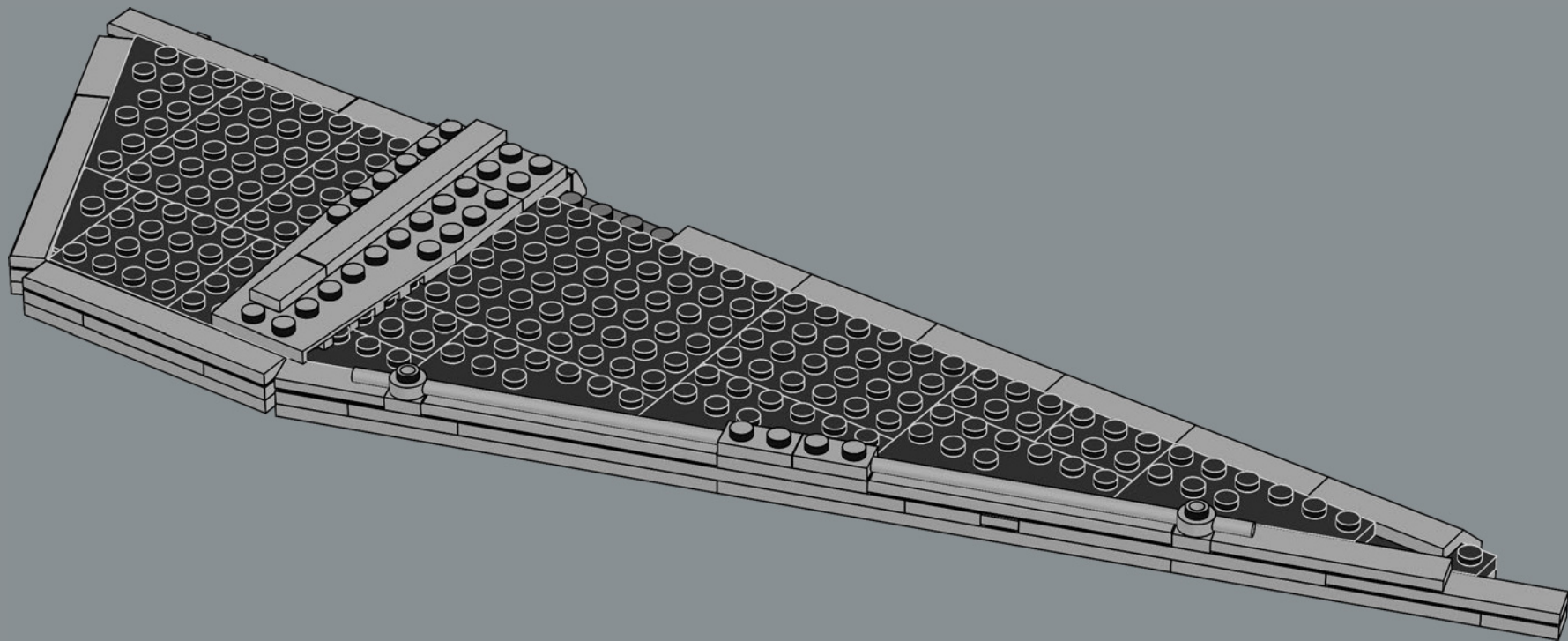

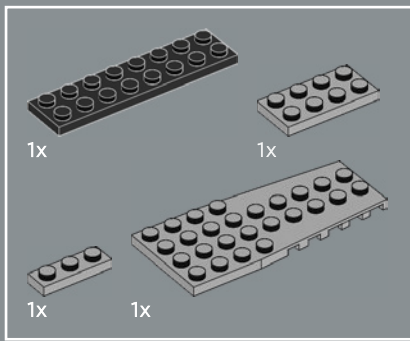

565

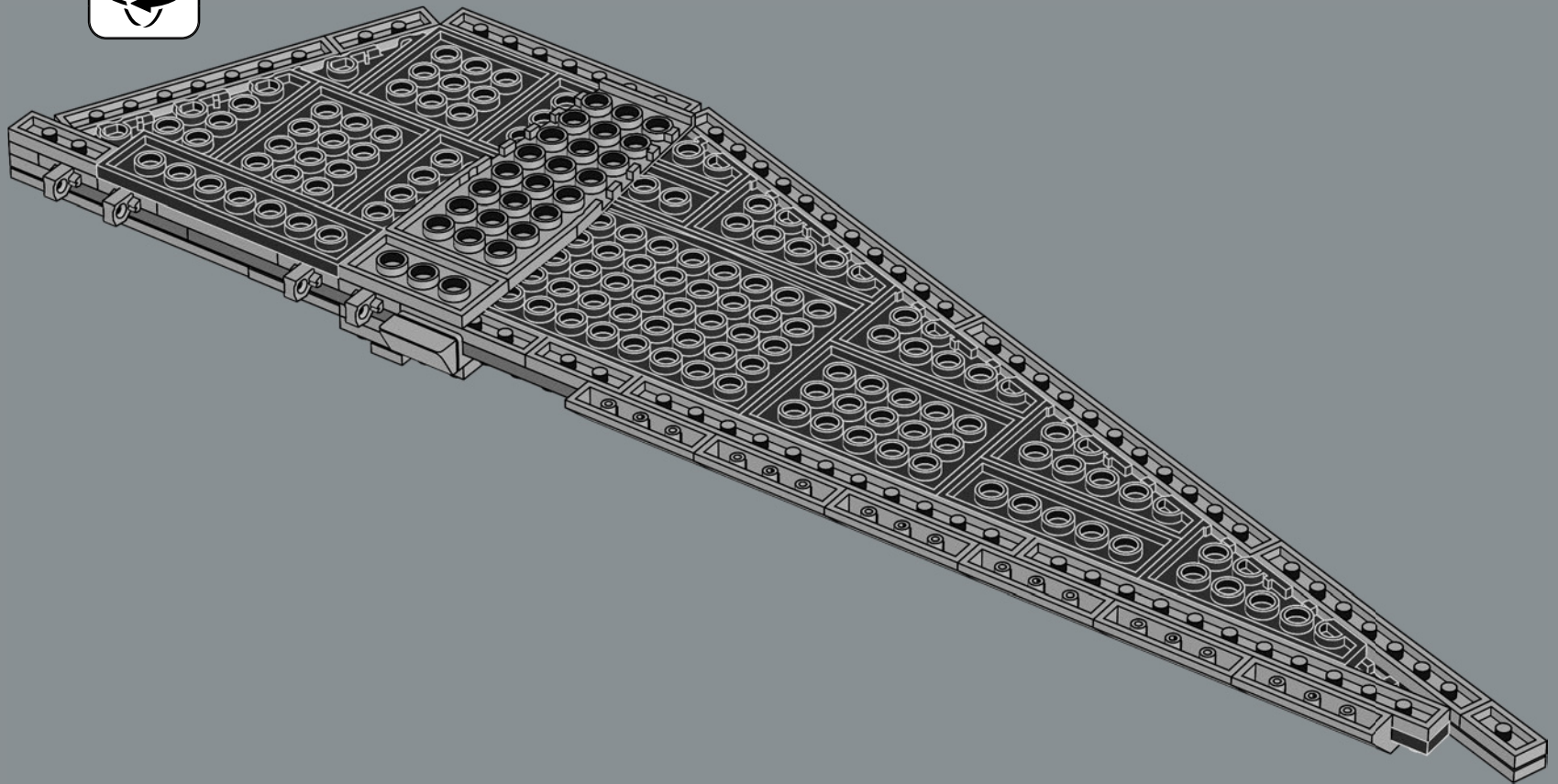

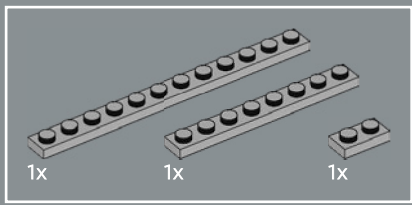

566

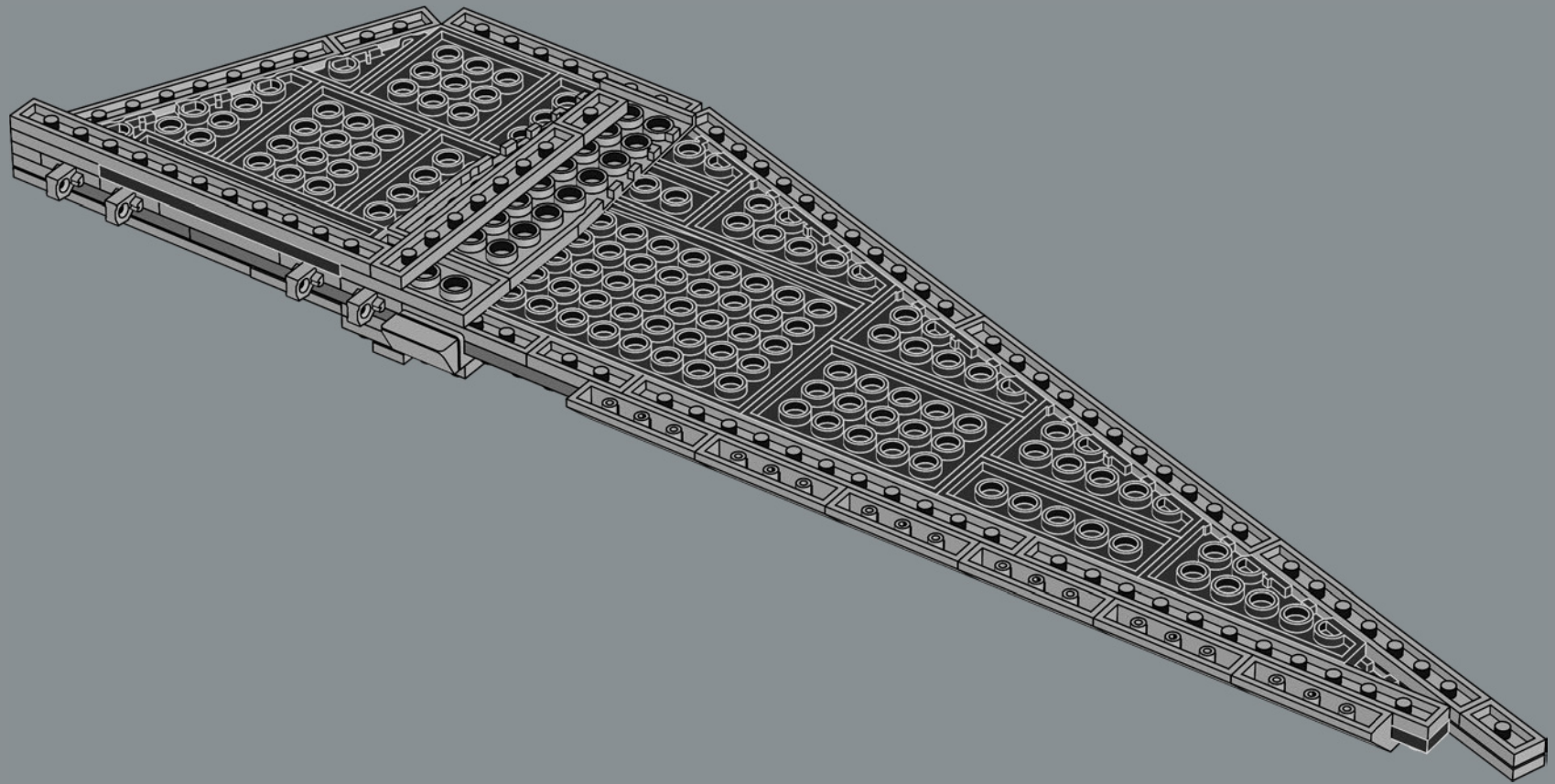



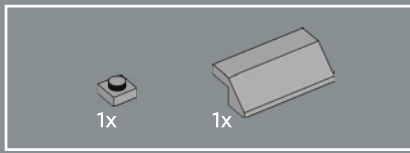

567

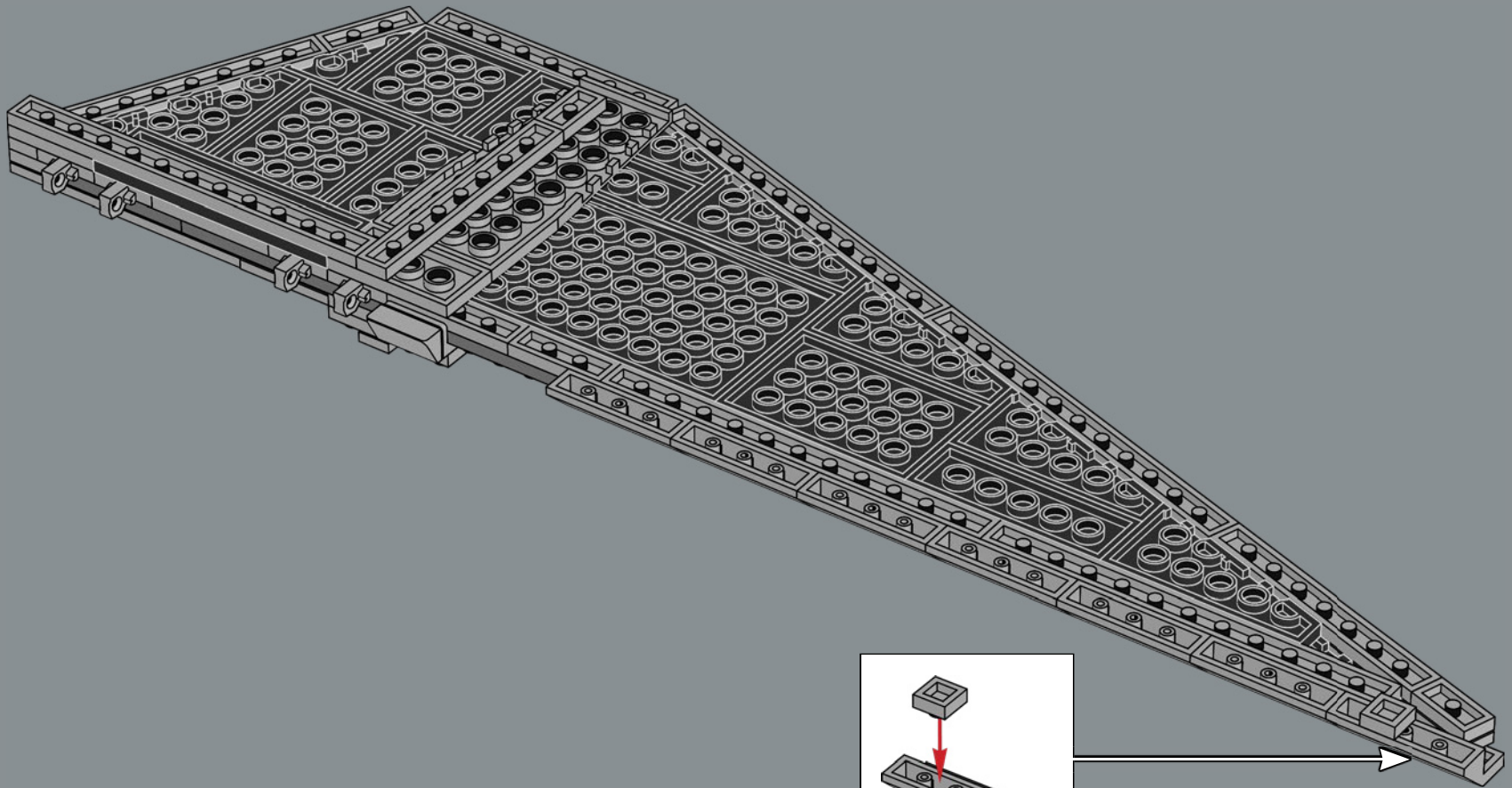



568

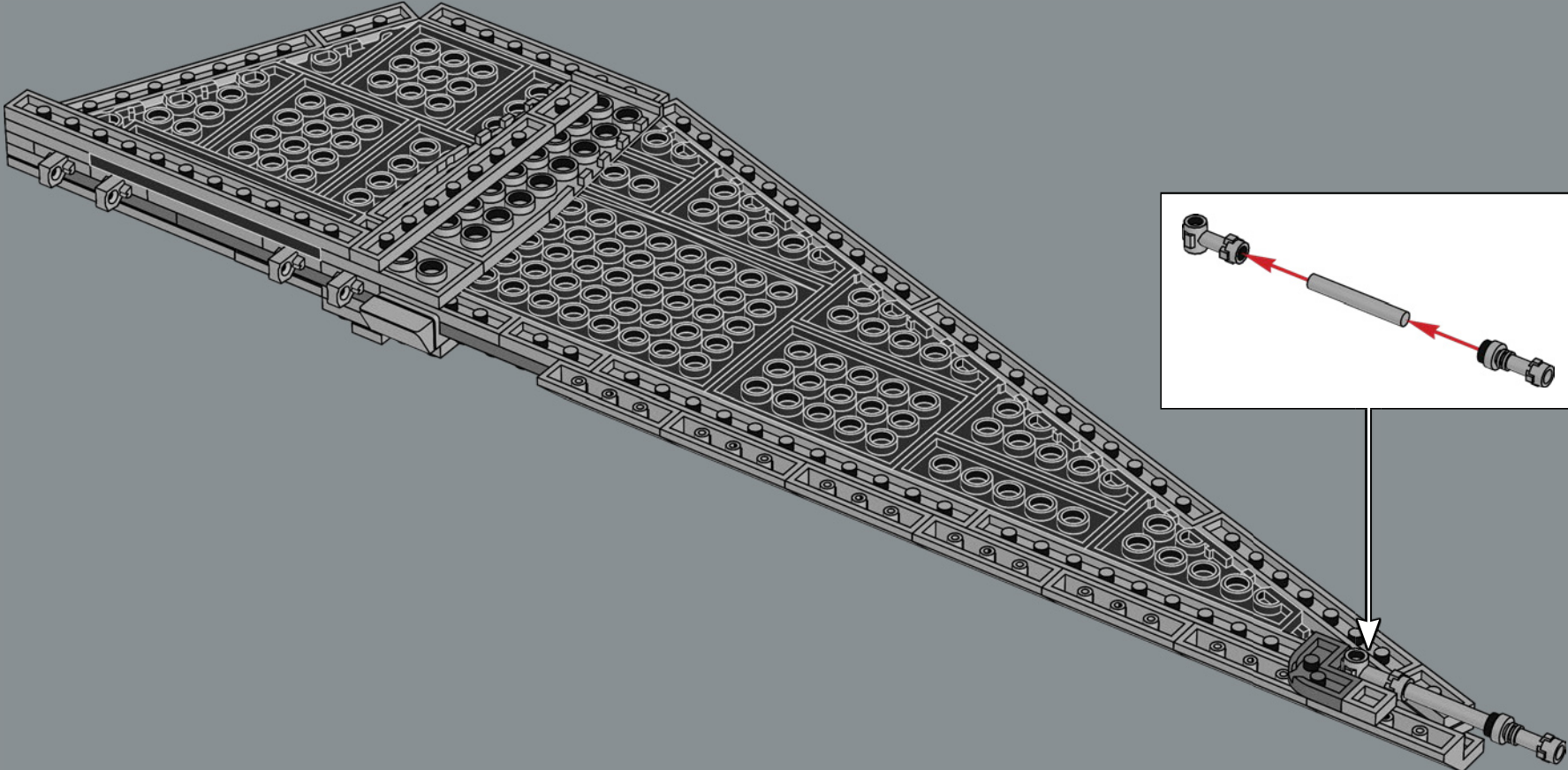



569

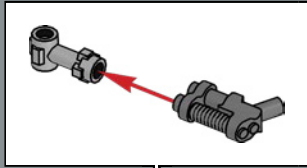
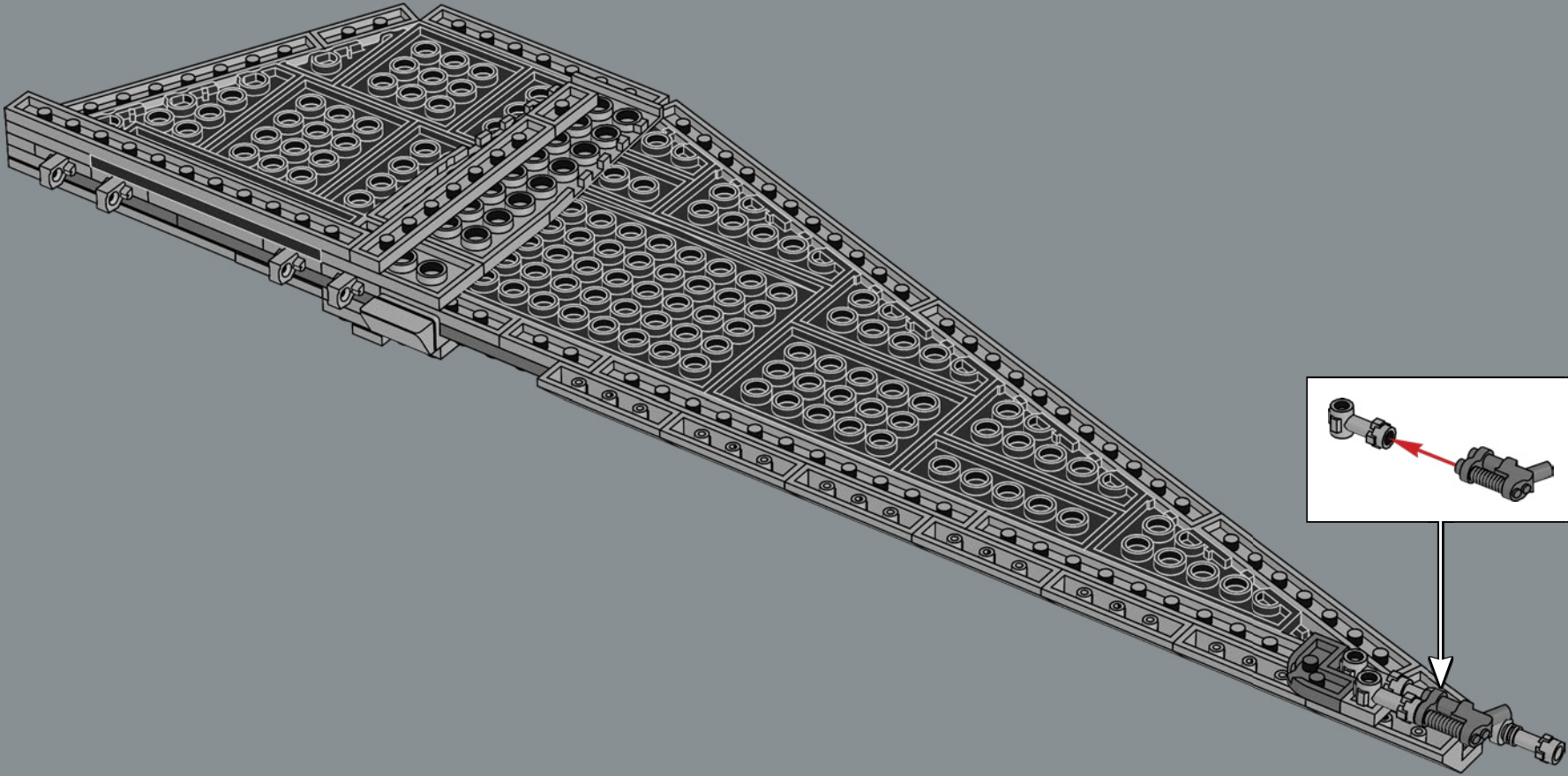



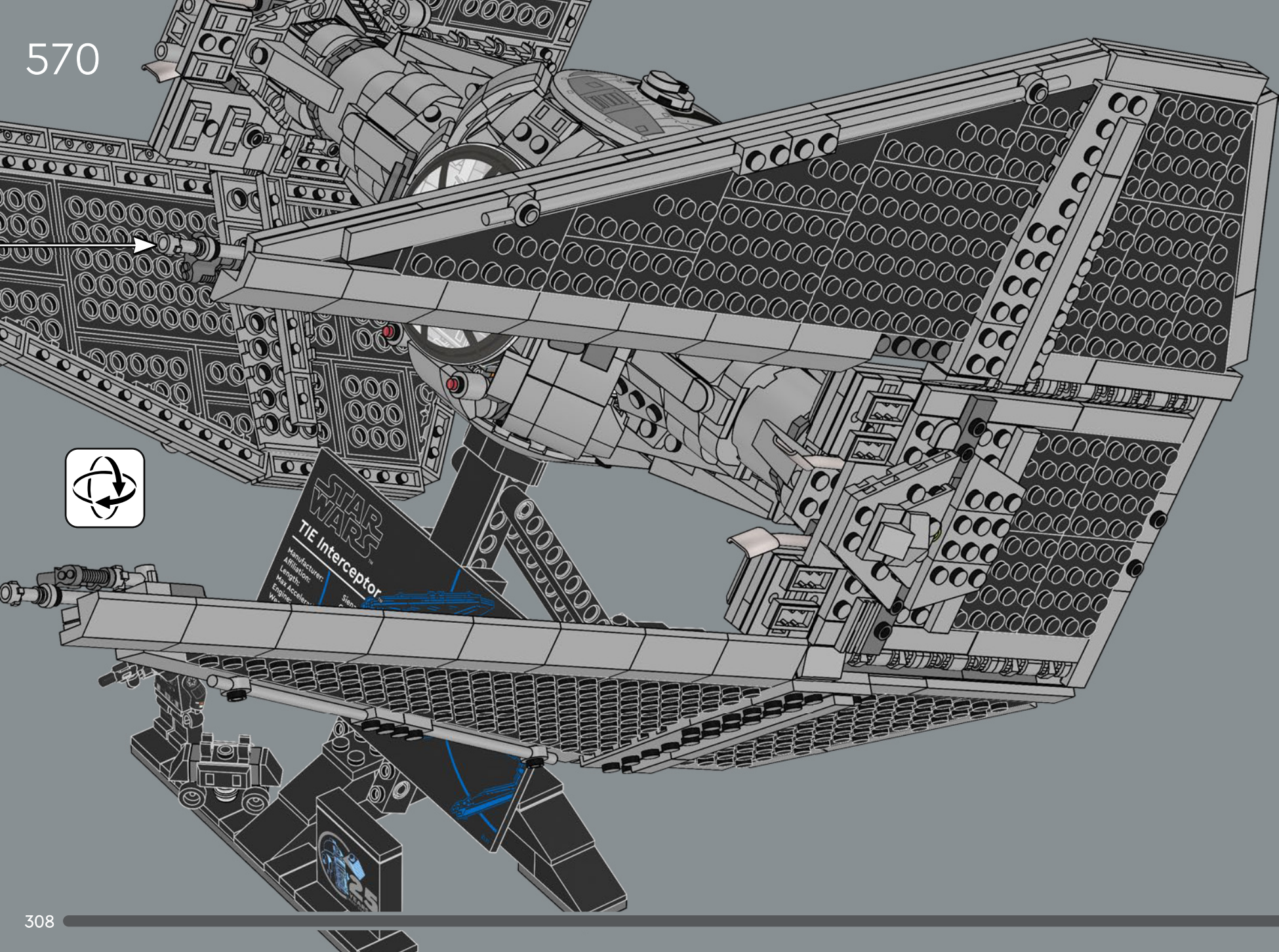

STAR WARS  
TIE Interceptor  
Manufacturer:  
Affiliation:  
Length:  
Max Acceleration:  
Engine:  
Sight:



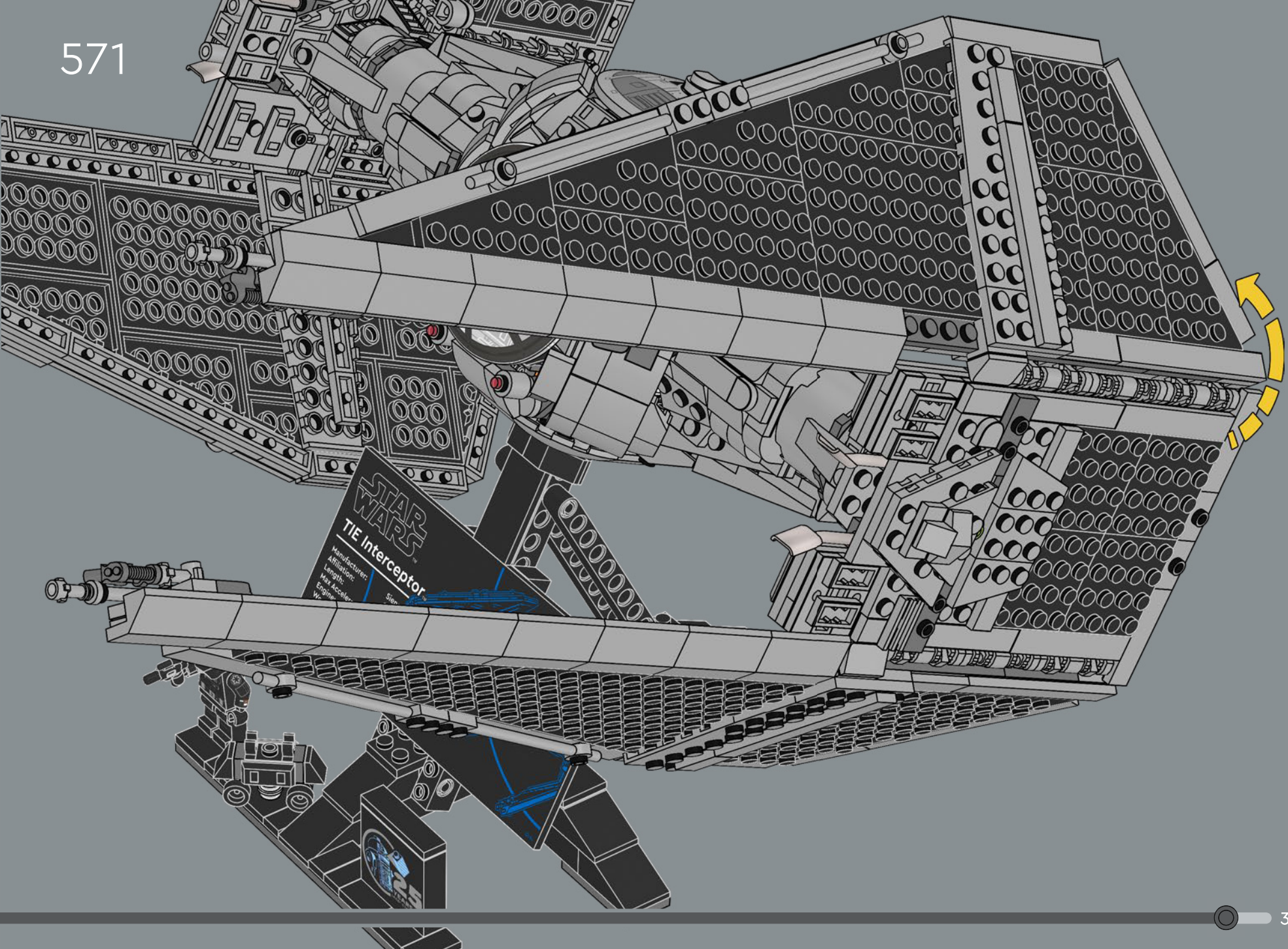

**STAR WARS**  
**TIE Interceptor**  
Manufacturer:  
Affiliation:  
Length:  
Max. Acceleration:  
Engines:  
Weapons:



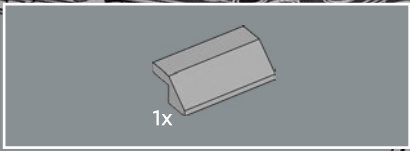

572

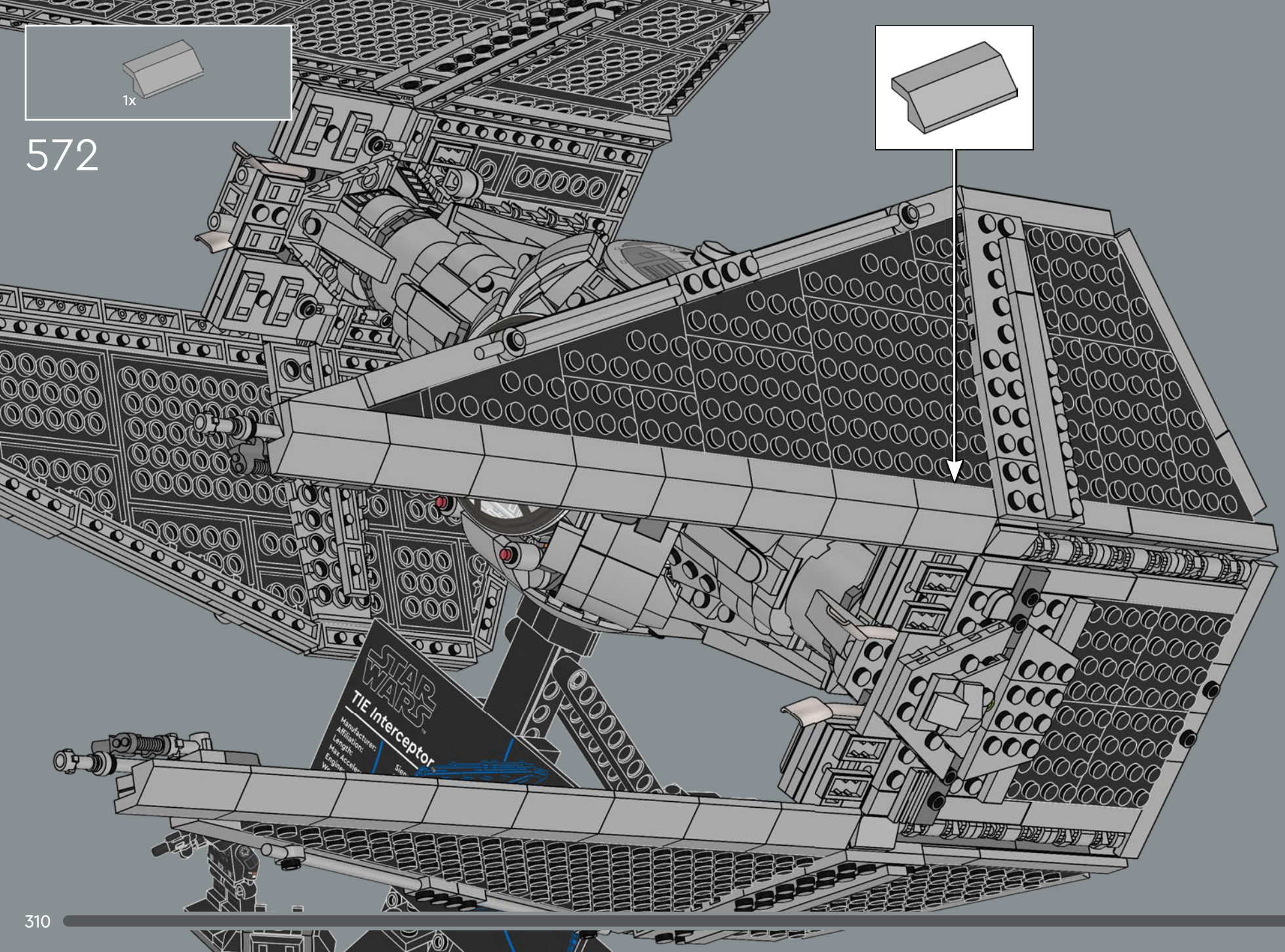
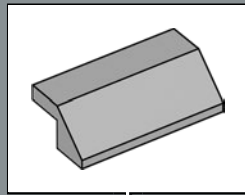

**STAR WARS**  
**TIE Interceptor™**  
Manufacturer:  
Affiliation:  
Length:  
Max. Acceleration:  
Engine:  
Wingspan:  
Sign:

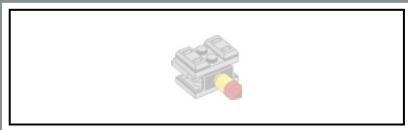

573

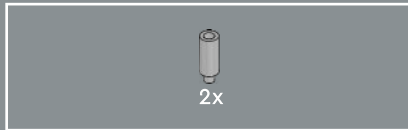
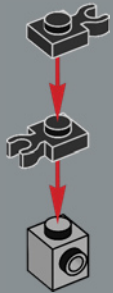

574

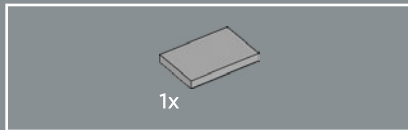
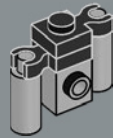

575

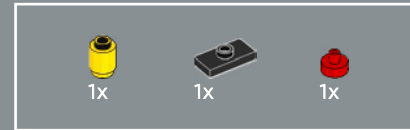
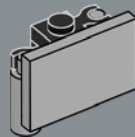

576

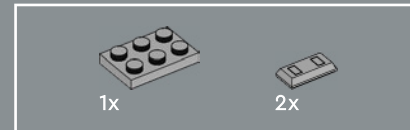
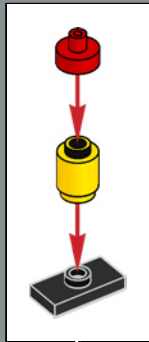
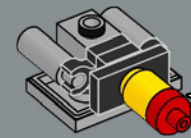

577

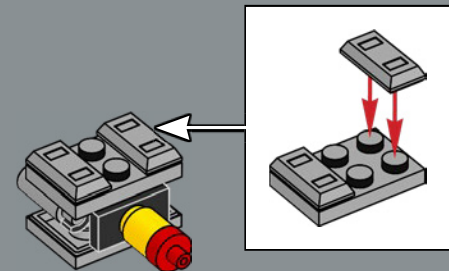



578

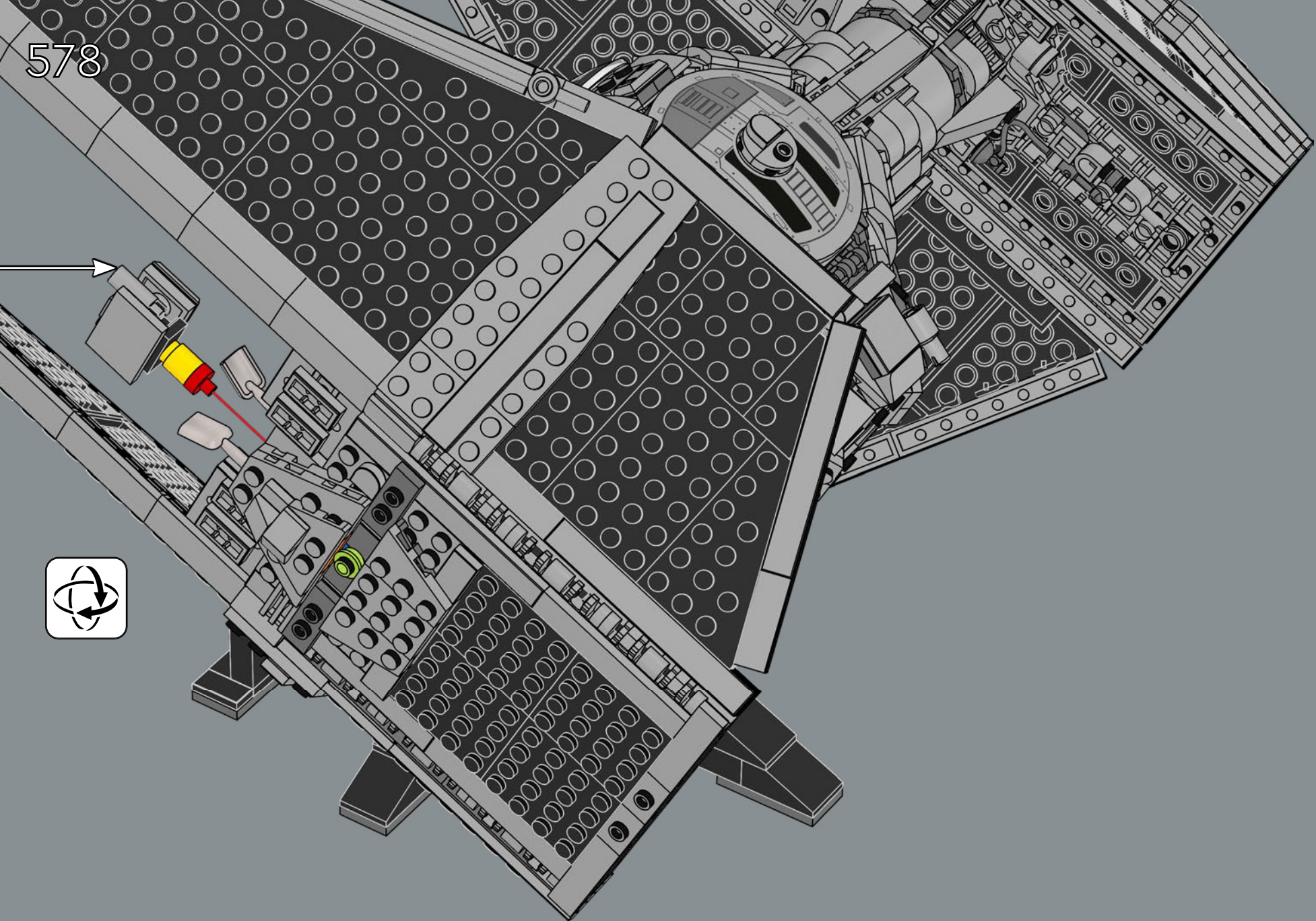



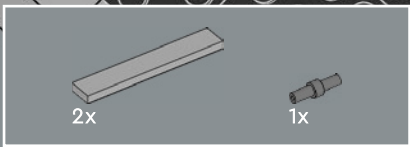

579

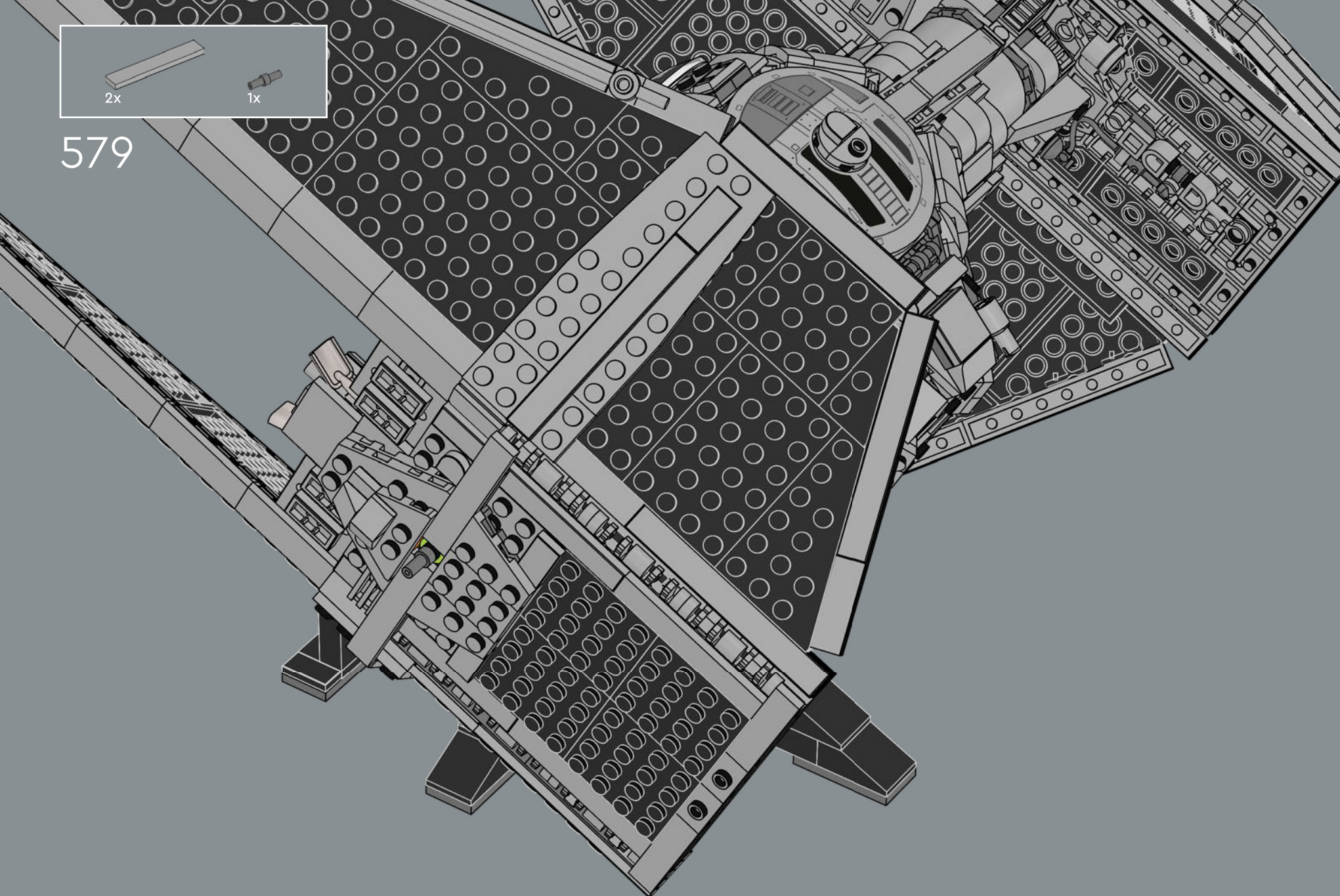



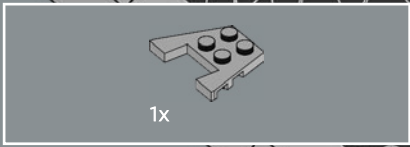

580

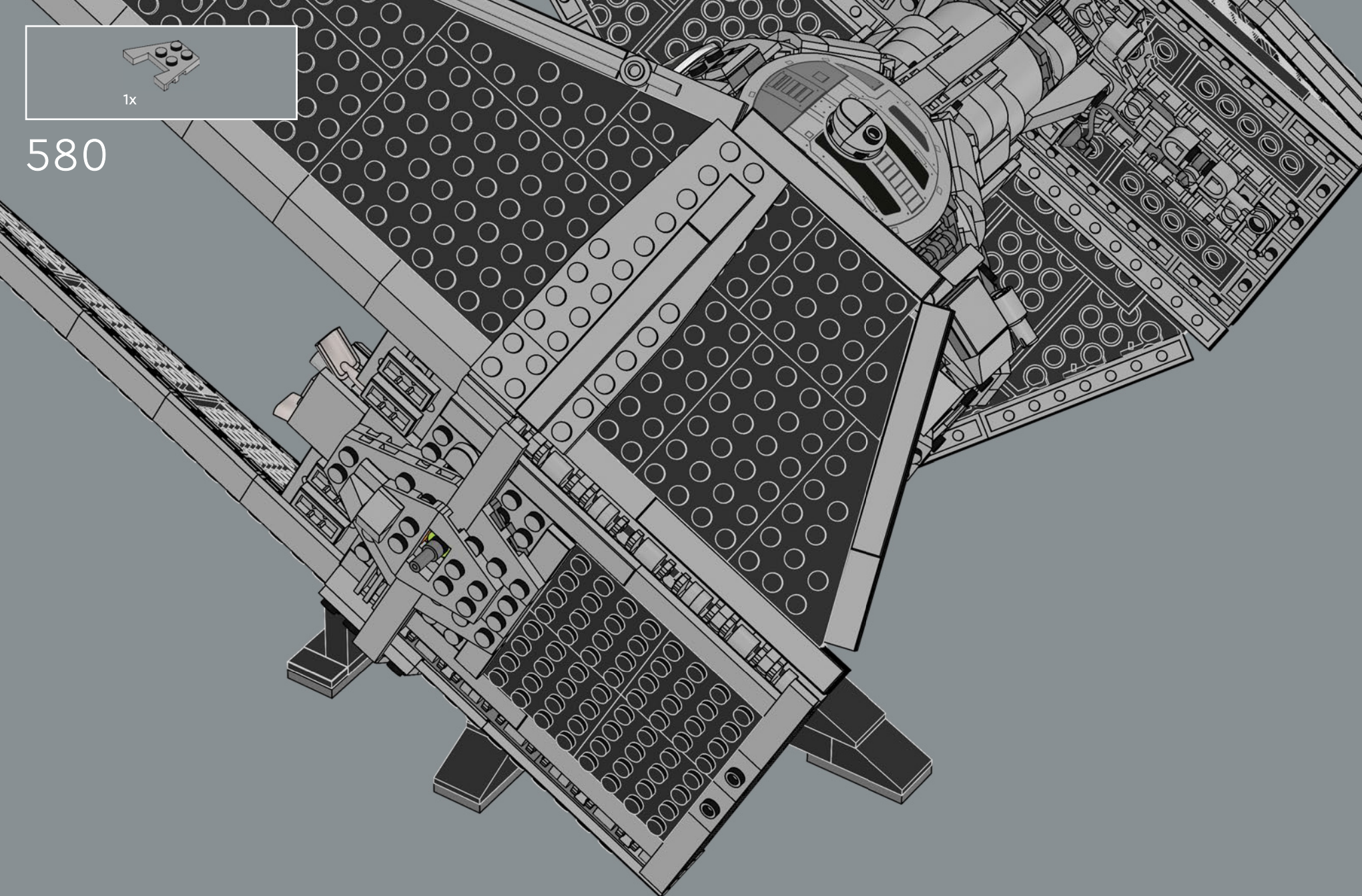





581

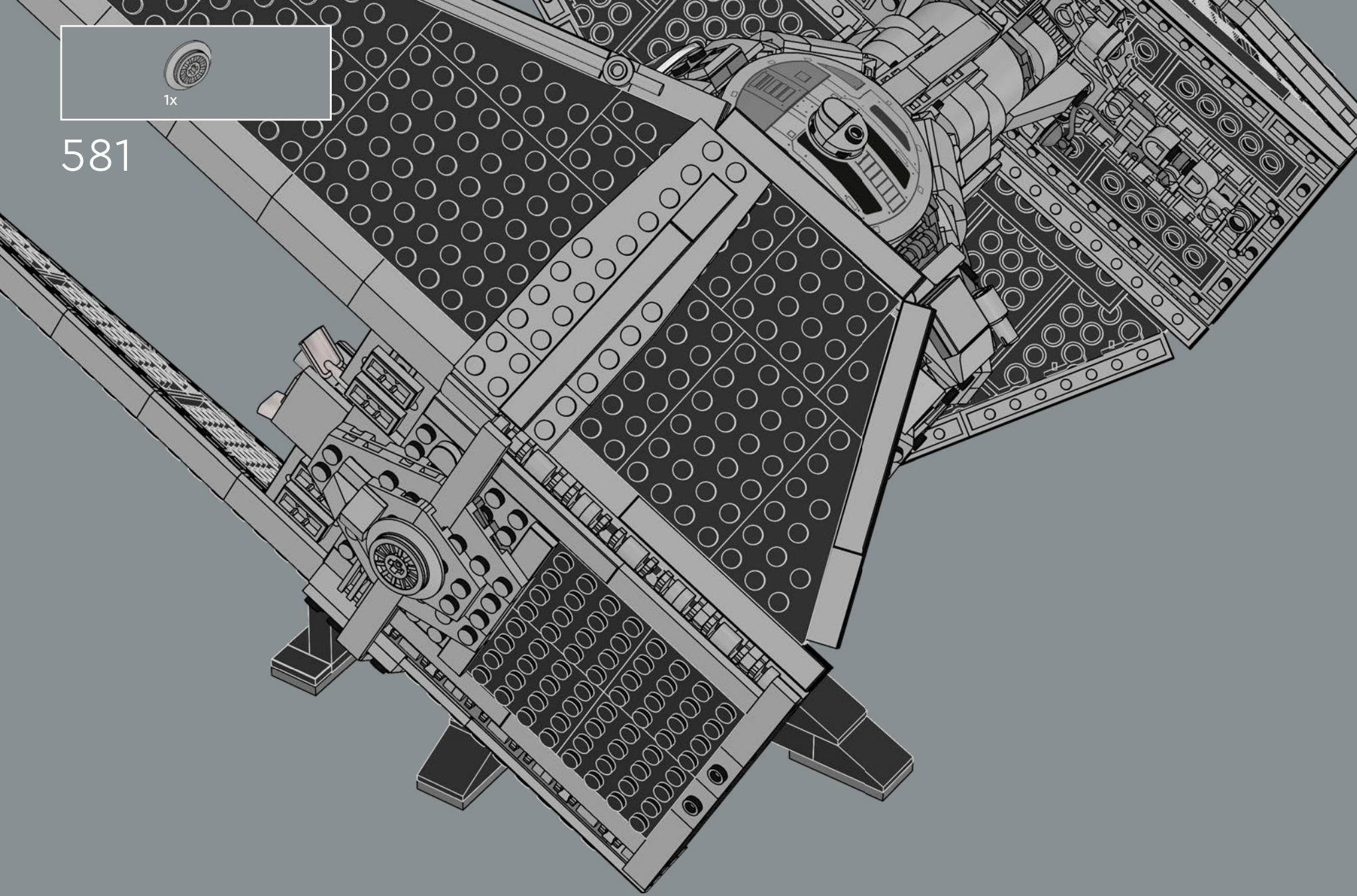



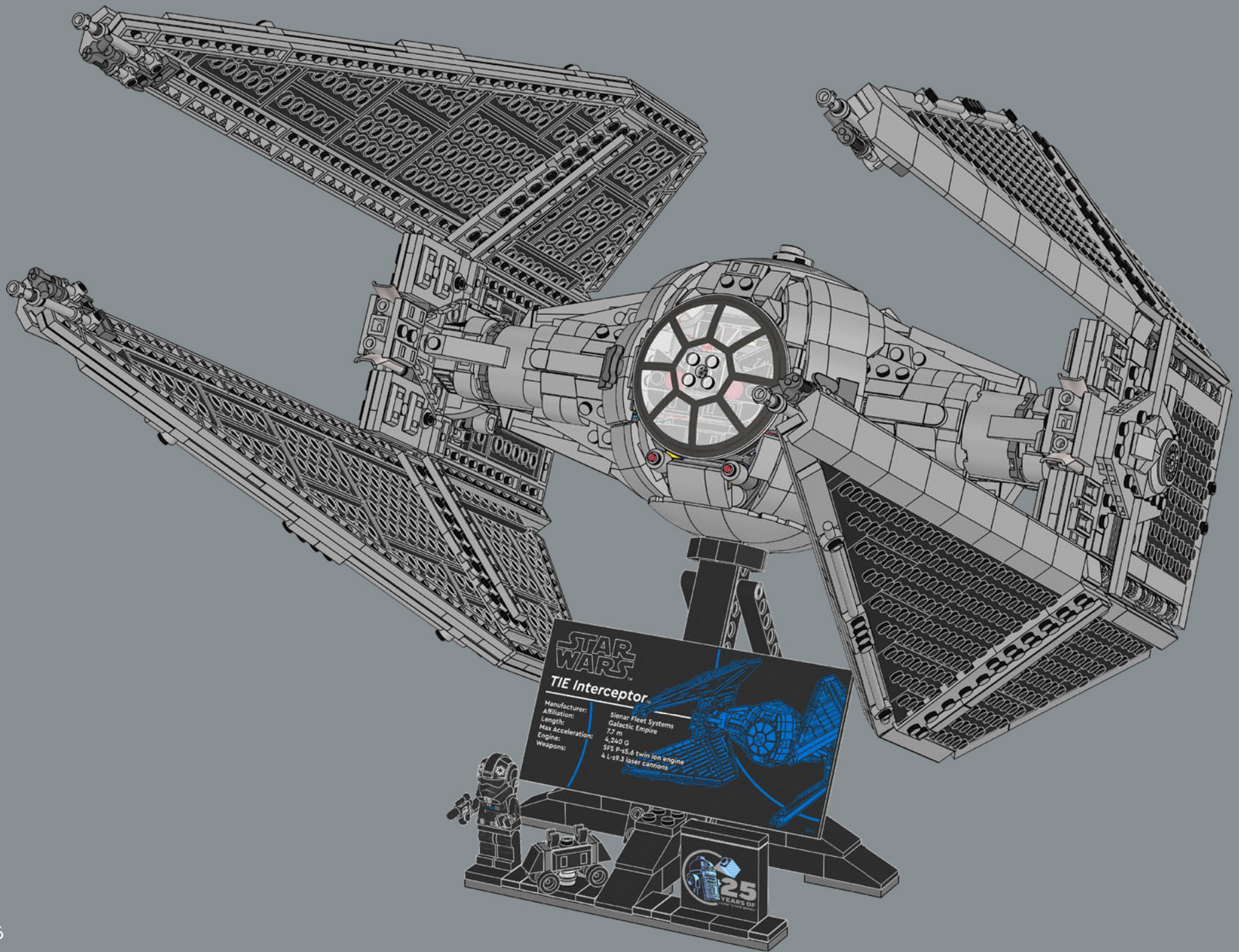

## STAR WARS

### TIE Interceptor

Manufacturer: Sienar Fleet Systems  
Affiliation: Galactic Empire  
Length: 77 m  
Max Acceleration: 4,240 G  
Engine: SFS P-8.6 twin ion engine  
Weapons: 4 L-9P.3 laser cannons

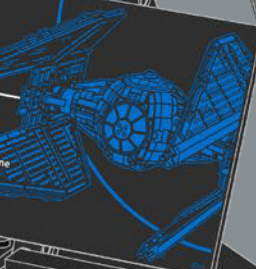





---

TIE INTERCEPTOR™

---

**STAR WARS**



---

L'INTERCEPTEUR TIE

---

**STAR WARS**



---

INTERCEPTOR TIE

---

**STAR WARS**





# YOU COULD WIN



## YOU COULD WIN

Your feedback will help shape the future development of this product series.

Visit:

## DU KÖNNTEST GEWINNEN

Dein Feedback trägt zur Weiterentwicklung dieser Produktreihe bei.

Geh auf:

## VOUS POURRIEZ GAGNER

Vos commentaires nous aideront à concevoir les futurs produits de cette gamme.

Visitez :

## POTRESTI VINCERE TU

La tua opinione ci aiuterà a migliorare la creazione futura di questa linea di prodotti.

Visita:

## PUEDES GANAR

Tu opinión contribuirá al futuro de esta serie de productos.

Visita:

## 轻松获奖

您的反馈将有助于我们在今后改进本产品系列。

请访问:

---

[LEGO.com/productfeedback](https://www.lego.com/productfeedback)

---

You also have the chance to win a LEGO® set.

Terms and conditions apply.\*

Außerdem hast du die Chance, ein LEGO® Set zu gewinnen.

Es gelten die Teilnahmebedingungen.\*

Vous pourriez également gagner un ensemble LEGO®.

Des conditions s'appliquent.\*

Hai anche la possibilità di vincere un set LEGO®.

Termini e condizioni sono applicabili.\*

También tienes la oportunidad de ganar un set LEGO®.

Aplican términos y condiciones.\*

您还有机会赢取乐高®套装。

条款和条件适用。\*

\*[LEGO.com/productfeedback-terms](https://www.lego.com/productfeedback-terms)



2x  
6320310

4x  
6435932

2x  
6034044

4x  
6070698

4x  
6266219

2x  
403201

21x  
4113917

3x  
6223291

8x  
4113993

2x  
4509897

16x  
4161734

1x  
6115248

4x  
300421

1x  
300121

**320**

2x  
6170390

12x  
6173961

1x  
6480856

12x  
6378120

4x  
6473603

1x  
4157223

4x  
6385920

4x  
6371957

4x  
242021

2x  
302121

6x  
6215539

4x  
6266205

4x  
6001806

4x  
6346804

2x  
6118830

2x  
6482573

6x  
6313131

8x  
6299413

2x  
6280384

4x  
370123

10x  
306224

2x  
389424

1x  
6130007

4x  
4504382

2x  
6267487

4x  
6069000

1x  
6181720

1x  
6181713

8x  
329826

1x  
6267482

4x  
614126

1x  
6284070

2x  
6172383

4x  
6186675

2x  
6335388

4x  
6299338

4x  
6308000

2x  
6157554

10x  
6330189

1x  
6266207

11x  
6000650

4x  
6310268

1x  
4140588

2x  
6336989

2x  
6013867

1x  
6265730

8x  
6469445

1x  
6141554

4x  
6295295

4x  
6295293

1x  
6141556

2x  
6210270

4x  
4180508

4x  
4180536

4x  
6174243

18x  
4283046

18x  
4283047

4x  
6258209

4x  
6258214

4x  
4160025

6x  
6325190

1x  
6487885

1x  
6405216

8x  
6491608

1x  
6405194

1x  
6508152

1x  
6360207

2x  
6253695

1x  
6325254

12x  
6279875



1x  
393826



1x  
473326



2x  
6436425



4x  
370026



8x  
4584274



4x  
654126



1x  
300326



1x  
6483080

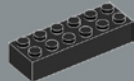

3x  
4181144



1x  
4617860



2x  
273026



2x  
246526



2x  
370326



2x  
6039869



6x  
306926



14x  
6214807



1x  
4565323



7x  
6192346



16x  
302126



4x  
6254045



1x  
243126



4x  
6174917



4x  
4560182



5x  
366626



4x  
370526



24x  
4243819



8x  
379526



8x  
379526



8x  
379526



19x  
6092585



17x  
6156991



1x  
6105963



2x  
6318582



24x  
303226



4x  
303426



1x  
383226



4x  
303026



8x  
303326



2x  
4522933



1x  
6001494



1x  
6001494



1x  
6001494



1x  
6472397



1x  
6472397



12x  
302128



4x  
6424859



2x  
6382577



2x  
6240030



6x  
4528604



6x  
6258607



2x  
6507880



14x  
4159007



4x  
6477975



1x  
6240515



4x  
4187743



8x  
4537936



8x  
4537936



8x  
4537936



8x  
4537936



2x  
6190251



8x  
6310279



4x  
6327442



1x  
6223219



2x  
6449566



2x  
6449566



2x  
6449565



2x  
4213567



6x  
6383177



2x  
4211412



20x  
4521921



4x  
6407412



1x  
4211640



1x  
4211640



1x  
4211640



16x  
4568637



2x  
4211488



3x  
4211421



6x  
6013497



32x  
6475652



2x  
6485155



13x  
6225139



13x  
6225142



31x  
6028813



2x  
6144138



32x  
6285778



4x  
6227184



27x  
6102357



3x  
6132207



1x  
4622803



13

4



4x  
6276969



8x  
4211415



2x  
6401023



24x  
4211399



7x  
4211350



26x  
6066097



45x  
4211398



23x  
4211414



4x  
4211353



1x  
4211413



2x  
6177078



20x  
4558169



6x  
6211969



46x  
4211429



30x  
4211396



2x  
6171894



2x  
6171894



16x  
6251044



4x  
4211356



18x  
4211445



8x  
4211395

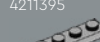

16x  
6372029

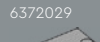

4x  
6079461



16x  
4211549



2x  
4211837



4x  
4211452



28x  
4211481



20x  
4211425

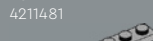

2x  
4211406



10x  
4251149



10x  
4251149

10x  
4251149

10x  
4251149

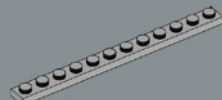

24x  
4514846



8x  
6277023



8x  
6448793



2x  
6420741



2x  
6507791



4x  
6043656



1x  
6225230



16x  
6266251



10x  
6004990



5x  
4654582



8x  
4211568



4x  
6319336



18x  
4515369



2x  
6421522



12x  
6266279



12x  
6266279



6x  
6335328



2x  
6335378



9x  
6250597



6x  
6227897



16x  
6176433



14x  
4211791



14x  
4211794



4x  
4282789



4x  
4282786



8x  
6163990



4x  
6491606



2x  
4507056



4x  
6508016



4x  
6508016



4x  
6508016



4x  
6508016



4x  
6508016



2x  
6170521



1x  
6472395

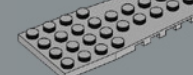

8x  
6048848



4x  
6249550



4x  
6093527



4x  
6436421



6x  
6217791



4x  
4539481



10x  
4640844



6x  
6326748



8x  
6491606



16x  
6092111



1x  
4211807



12x  
4211470

12x  
4211470



10x  
4211881



16x  
6416524



15x  
6134378



24x  
6473925



12x  
4558955



1x  
4210725



2x  
4529240



2x  
4504378



1x  
4211106

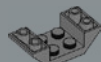

1x  
4211076



8x  
6215212



1x  
6071261



2x  
6100030



4x  
4211052



15x  
4210635



6x  
4211094



1x  
4211133



8x  
4568734



12x  
6343852



2x  
4211001



2x  
6039176



12x  
4211065



4x  
4539429



1x  
4210998



4x  
4211137



5x  
4210796



1x  
4528323



4x  
6350724



4x  
6336390



2x  
6214341



5x  
6117972



2x  
6336990



4x  
6123814



1x  
6457961



2x  
4521187



6x  
6231765



2x  
6143423



2x  
6143417



16x  
6221607



14x  
6164073



4x  
6411395



1x  
4528323



4x  
6350724



8x  
4211044



1x  
4567887



20x  
4210719



2x  
4210631



2x  
6116470



4x  
6439170



4x  
6359933



4x  
4623236



1x  
6258991



11x  
4211066



2x  
6281996



4x  
6353192



1x  
6118815



1x  
6118815



4x  
6210601



9x  
6322830



12x  
4619515



12x  
6469087



1x  
6472396



1x  
6472396



1x  
6472396



1x  
6472396



1x  
6472396



1x  
6472396



1x  
6472396



1x  
6472396



1x  
6472396



1x  
6472396



1x  
6472396

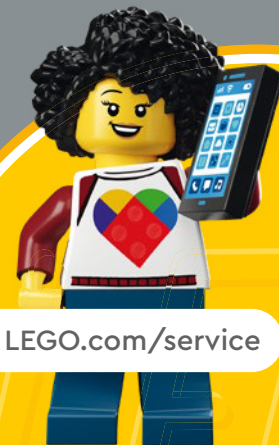

[LEGO.com/service](https://www.LEGO.com/service)

**STAR  
WARS™**

LEGO and the LEGO logo are trademarks of the/sont des marques de commerce du/  
son marcas registradas de LEGO Group. ©2024 The LEGO Group. 6515733

© & ™ Lucasfilm Ltd.