



# PRINCE OF PERSIA

THE SANDS OF TIME



# 7572



**LIGHT UP  
BRICK**



**WARNING: CHOKING HAZARD.**  
Small parts. Not for children under 3 years.

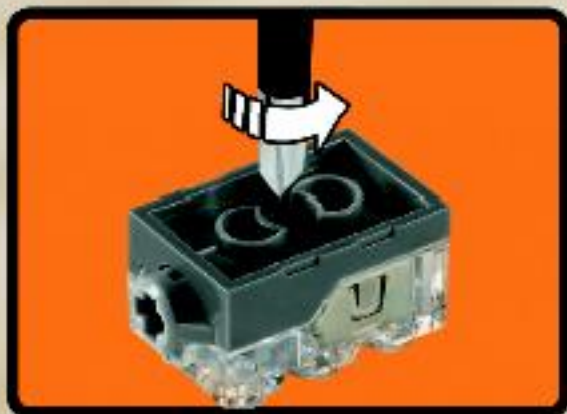

## GB

### Important information about batteries

Never use different types of batteries together or a combination of old and new batteries. Always remove the batteries if the product is not to be used for a long time or if the batteries have run down. Never use damaged batteries. Only use batteries of the type recommended, or a corresponding type. Insert the batteries so that the poles are correctly positioned. Rechargeable batteries must be recharged using the correct battery charger under the supervision of an adult. You cannot recharge batteries while they are still in the product, and you must never try to do so. Never attempt to recharge non-rechargeable batteries. Never short-circuit the battery holder.

## FR

### Informations importantes concernant les piles

Ne jamais utiliser un mélange de différents types de piles, ou de piles neuves et de piles anciennes ou déjà utilisées. Toujours retirer les piles si le produit n'est pas utilisé durant une période prolongée ou si les piles sont vides. Ne jamais utiliser de piles endommagées. Utiliser uniquement des piles du type recommandé ou d'un type équivalent. En insérant les piles, respecter scrupuleusement le sens d'orientation des piles (+/-). Les piles rechargeables doivent être rechargées en utilisant un chargeur de piles adéquat et sous la surveillance d'un adulte. Il est impossible de recharger les piles quand elles sont insérées dans le produit. Ne jamais tenter de le faire. Ne jamais essayer de recharger des piles non-rechargeables. Ne jamais court-circuiter le compartiment des piles.

## NL

### Belangrijke informatie over batterijen

Gebruik nooit verschillende soorten of nieuwe en oude batterijen tegelijkertijd. Verwijder de batterijen altijd als je het product lange tijd niet wilt gebruiken of als de batterijen leeg zijn. Nooit beschadigde batterijen gebruiken. Uitsluitend batterijen van het aanbevolen of overeenkomstige type gebruiken. Leg de batterijen met de polen in de juiste richting. Opladbare batterijen moeten in een voor dit doel bestemde oplader en onder toezicht van een volwassene opnieuw worden opgeladen. Opladbare batterijen kunnen niet in het product worden opgeladen en je mag dit ook niet proberen te doen. Probeer nooit niet-oplaadbare batterijen op te laden. Nooit de batterijhouder kortsluiten.

## DA

### Vigtig information om batterier

Brug aldrig forskellige typer batterier sammen, eller nye og gamle batterier samtidig. Tag altid batterierne ud, hvis du ikke skal bruge produktet i længere tid, eller hvis batterierne er brugt op. Anvend aldrig beskadigede batterier. Der må kun anvendes batterier af samme eller tilsvarende type som anbefalet. Batterierne skal vendes rigtigt når de i sættes. Genopladelige batterier skal oplades i en dertil beregnet oplader under opsyn af en voksen. Genopladelige batterier kan og må ikke forsøges oplades i produktet. Forsøg aldrig at genoplade ikke-genopladelige batterier. Kortslut aldrig batteriholderen kortslutninger.

## DE

### Wichtige Information zu Batterien

Benutzen Sie niemals unterschiedliche Arten von Batterien oder alte und neue gleichzeitig. Nehmen Sie stets die Batterien heraus, wenn mit dem Produkt längere Zeit nicht gespielt wird oder wenn die Batterien leer sind. Verwenden Sie niemals beschädigte Batterien. Verwenden Sie ausschließlich empfohlene bzw. geeignete Batterien. Achten Sie beim Einsetzen der Batterien auf die richtige Polung. Wiederaufladbare Batterien sollten mit einem geeigneten Ladegerät aufgeladen werden – unter der Aufsicht eines Erwachsenen. Batterien können und dürfen niemals aufgeladen werden, während sie sich im Produkt befinden. Versuchen Sie weder kalten Umschmelzen, „normale“ Batterien wiederzuladen. Schließen Sie das Batteriefach niemals kurz.

## IT

### Importanti informazioni sulle batterie

Non usare mai contemporaneamente batterie di tipo diverso e batterie nuove e usate insieme. Rimuovere sempre le batterie qualora il prodotto non venga utilizzato per periodi prolungati, oppure se le batterie sono esauste. Non utilizzare mai batterie danneggiate. Usare esclusivamente batterie del tipo raccomandato o un equivalente. Inserire le batterie avendo cura che la loro polarità sia corretta. Le batterie ricaricabili vanno ricaricate in un caricabatteria di tipo idoneo e con la supervisione di un adulto. Non è possibile e non bisogna mai tentare di ricaricare le batterie mentre queste sono inserite nel prodotto. Non tentare mai di ricaricare le batterie non ricaricabili. Non cortocircuitare mai il compartimento.

## ES

### Importante información sobre las baterías

No mezclar nunca diferentes tipos de baterías, ni utilizar baterías antiguas y nuevas a la vez. Sacar siempre las baterías, si el producto no se utiliza por un largo periodo de tiempo o si las baterías están descargadas. No utilizar nunca baterías dañadas. Utilizar solo el tipo de baterías recomendado o una correspondiente. Colocar las baterías de manera que los polos estén en su posición correcta. Las baterías recargables deben cargarse con un cargador adecuado bajo la supervisión de un adulto. Las baterías no pueden, ni deben recargarse mientras permanezcan en el producto. No intentar nunca recargar baterías no recargables. Asegurarse que no se produzcan en cortocircuitos en el parte baterías.

## FI

### Tärkeät tiedot paristoista

Älä koskaan käytä erityyppisiä paristoja yhdessä. Älä nappulain läydä vanhoja lakkosia sekä vanhoja että uusia paristoja. Poista paristot tuotteenosta silloin, kun se on pitkäaikaista silloin käyttämättä, tai kun paristot ovat tyhjentyneet. Älä koskaan käytä viallisia paristoja. Käytä vain tuotteen valmistaja tai valmistajayhteisöön paristoja. Aseta paristot oikein, ettei ne voi vaurioitua olemassa ollessaan. Ladatakset paristot on ladattava oikealla tavalla ja aikuisen valvonnassa. Ei on mahdollista ladata paristoja, jotka ei ole tarkoitettu ladatakseen. Älä koskaan yritä ladata normaalia paristoja. Älä koskaan yritä ladata normaalia paristoja ladatakseen viallisia.



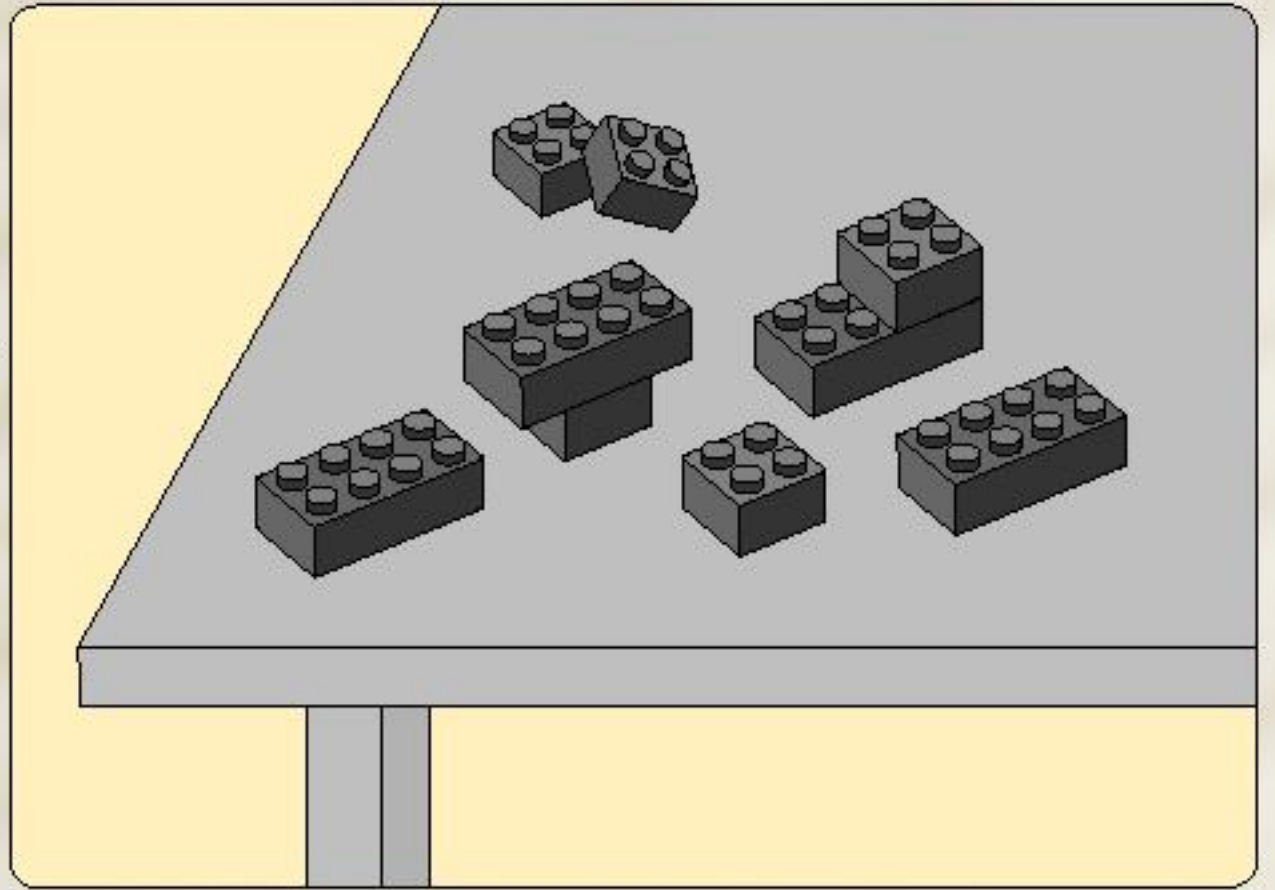
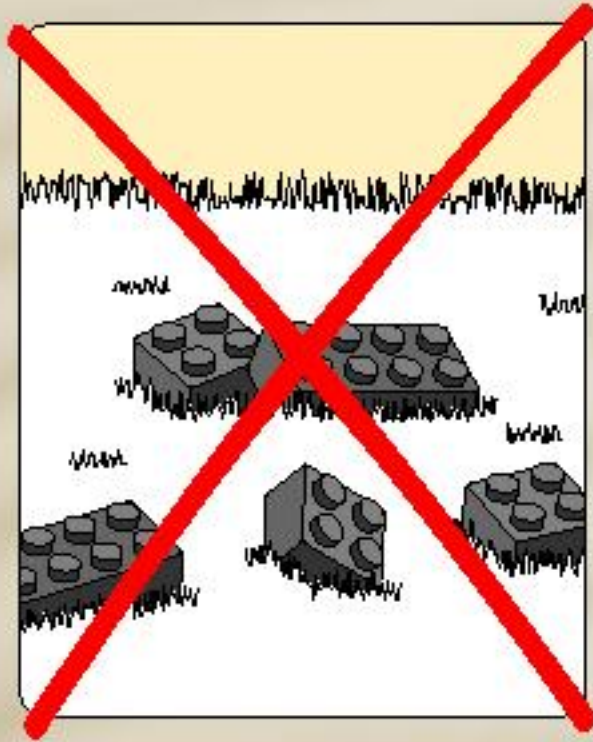

1

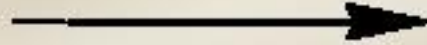

2

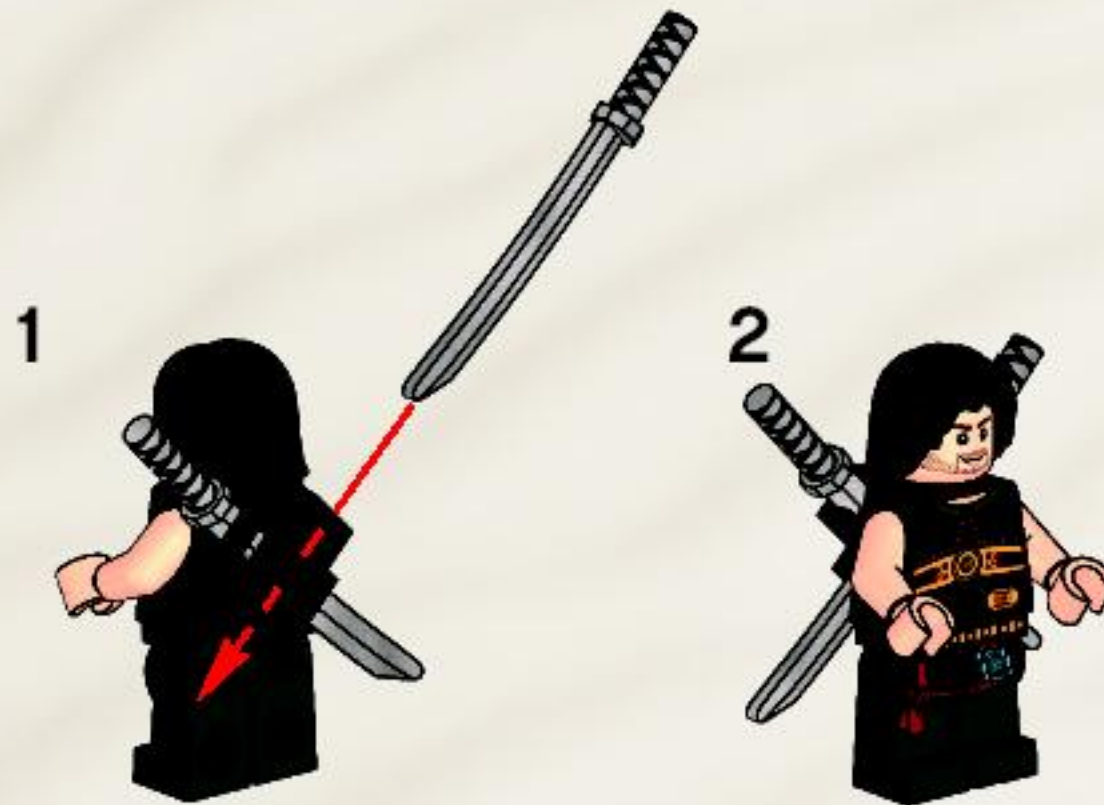
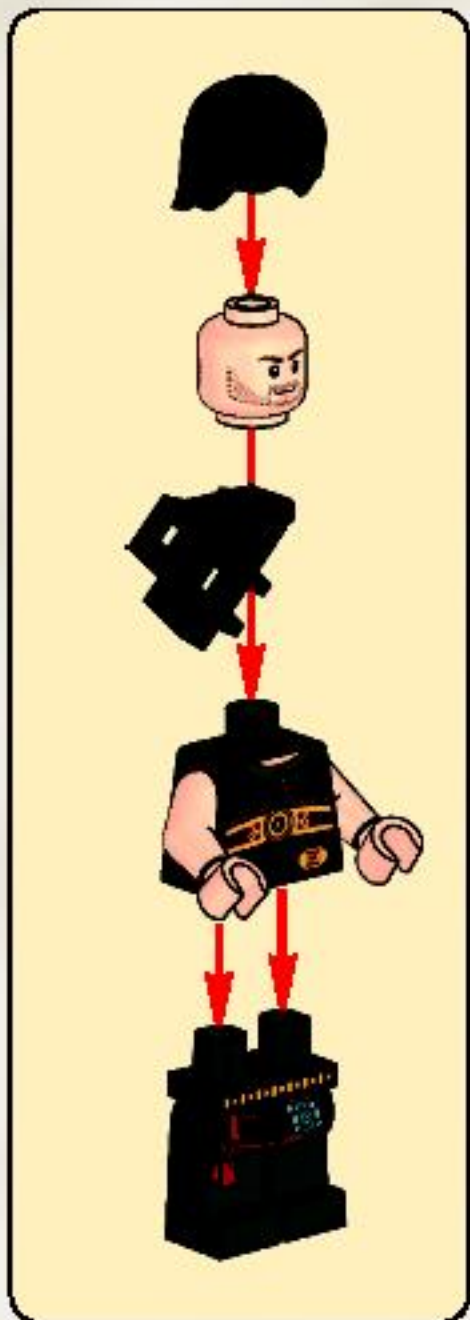
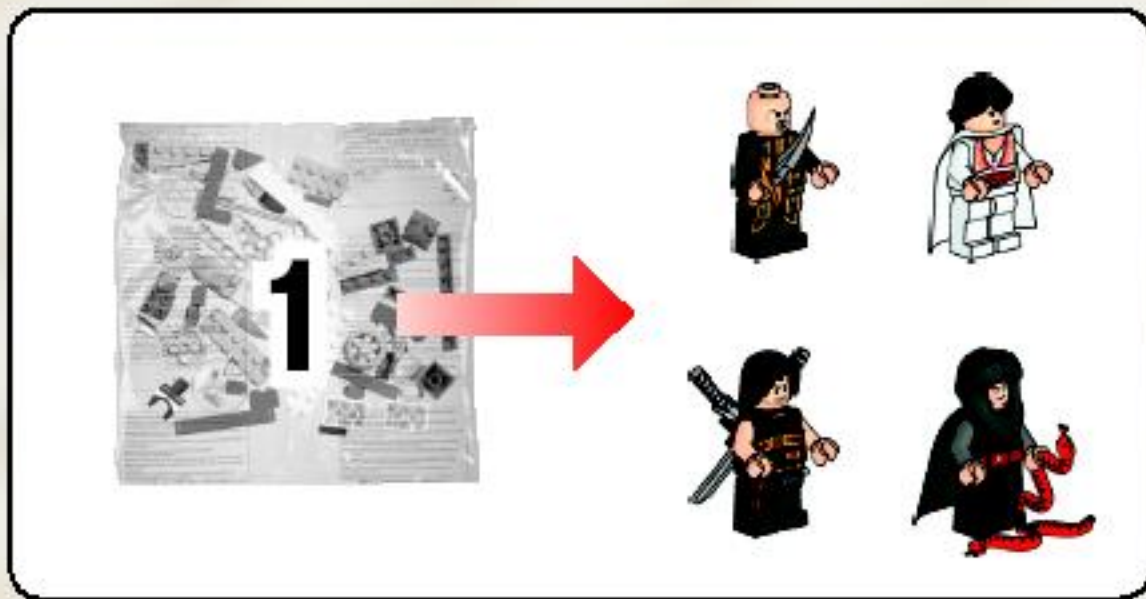



 **AVERTISSEMENT : RISQUE D'ÉTOUFFEMENT.**  
 Contient des petites pièces. Ne convient pas aux enfants de moins de 3 ans.

 **ADVERTENCIA: PELIGRO DE ASFIXIA.**  
 No recomendado para niños menores de 3 años. Contiene piezas pequeñas.

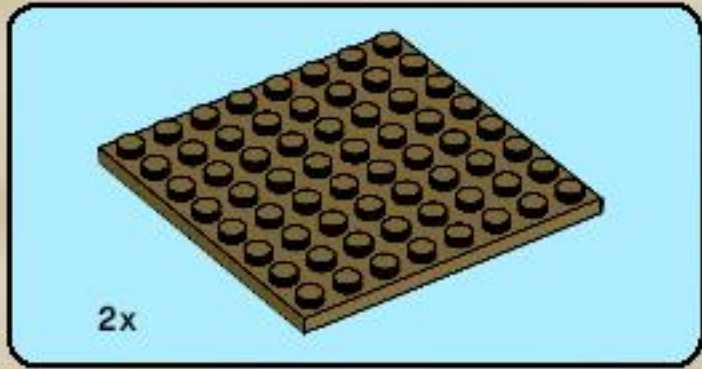
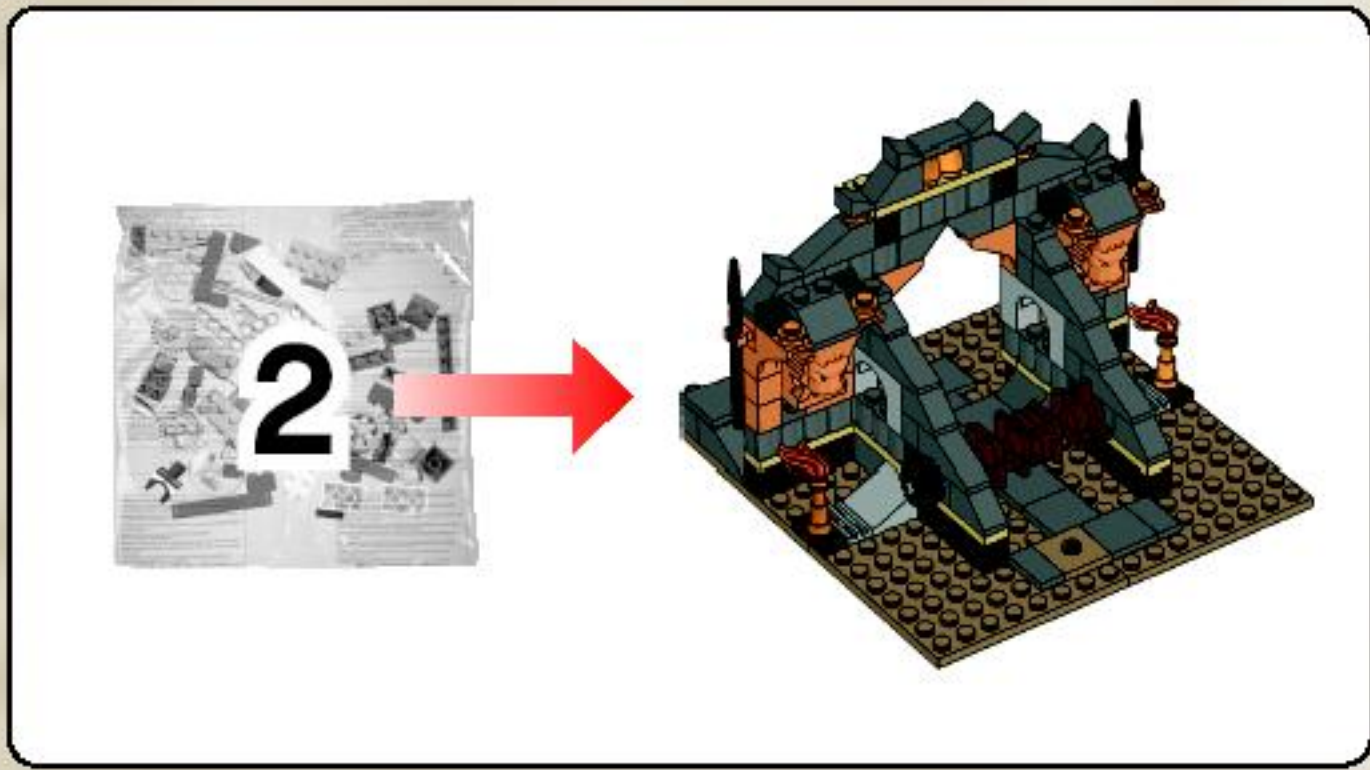

1

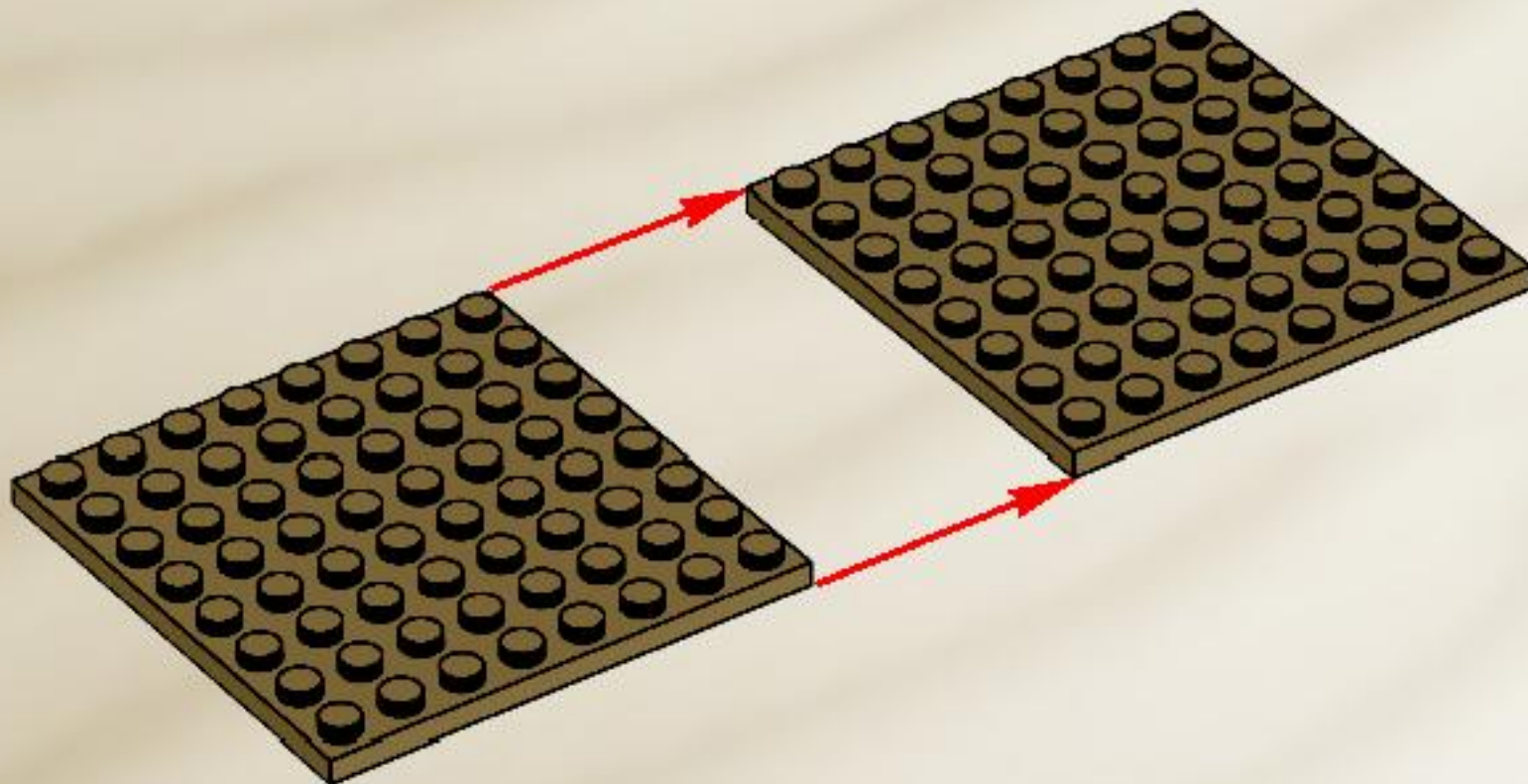

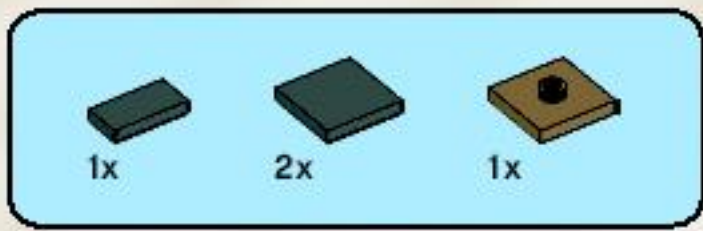

2

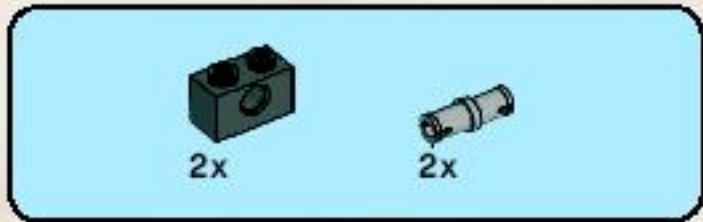
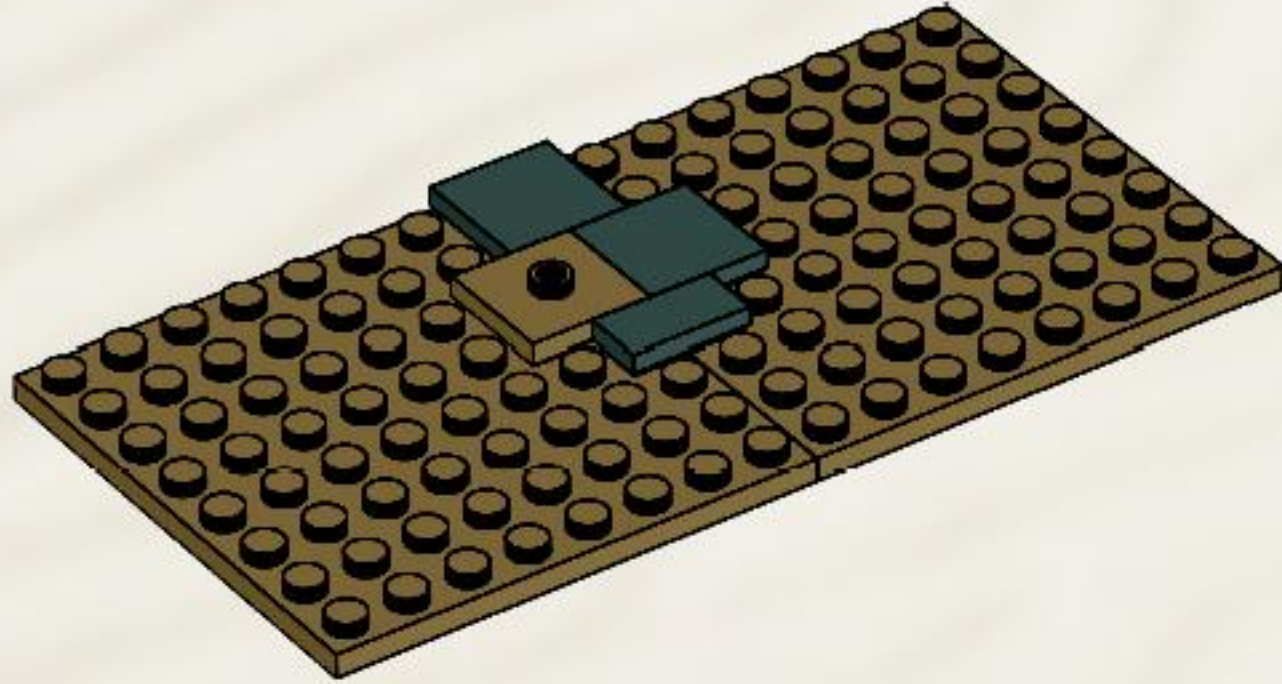

3

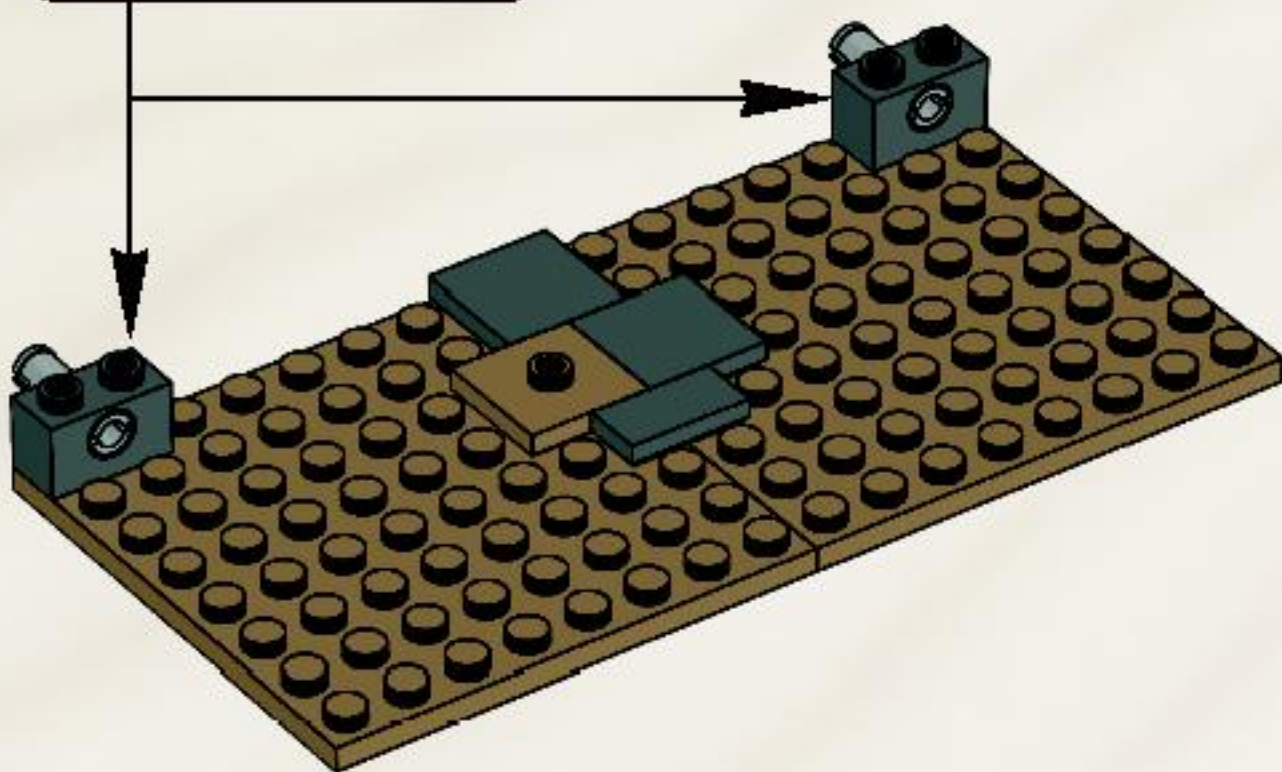
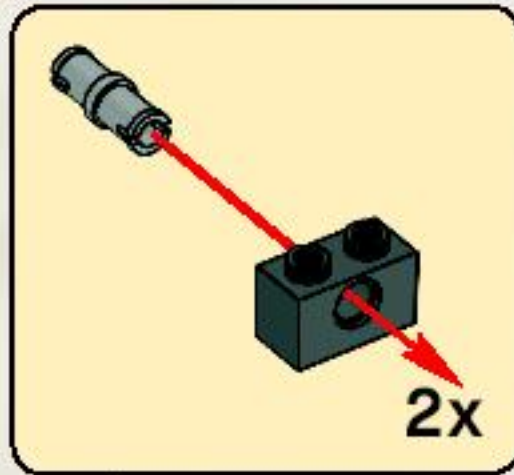

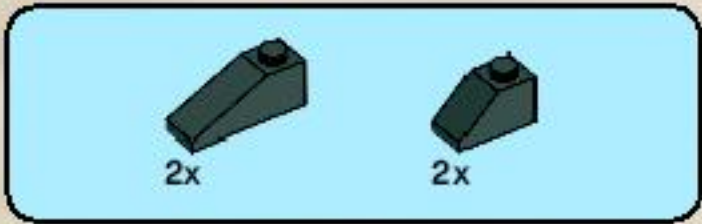

4

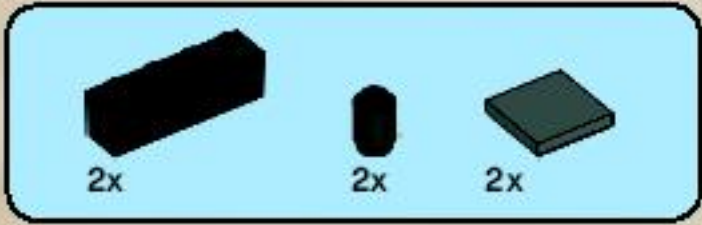
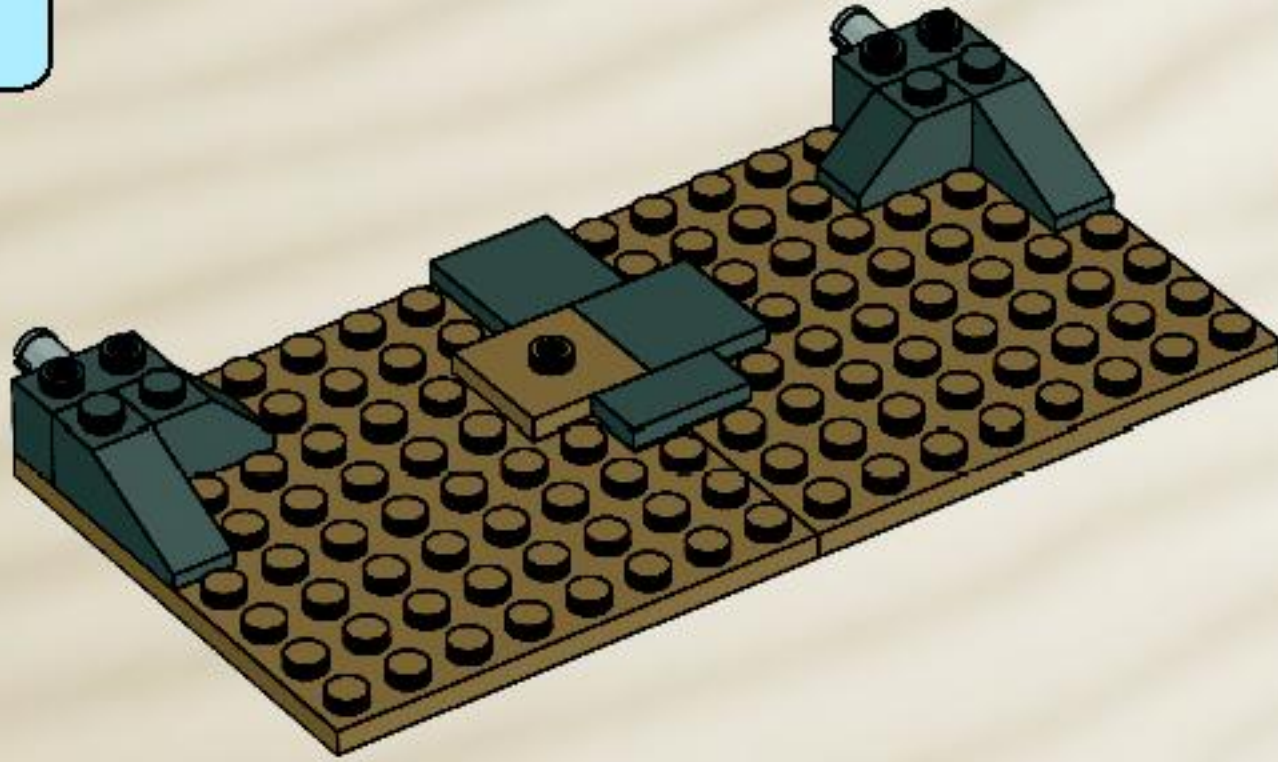

5

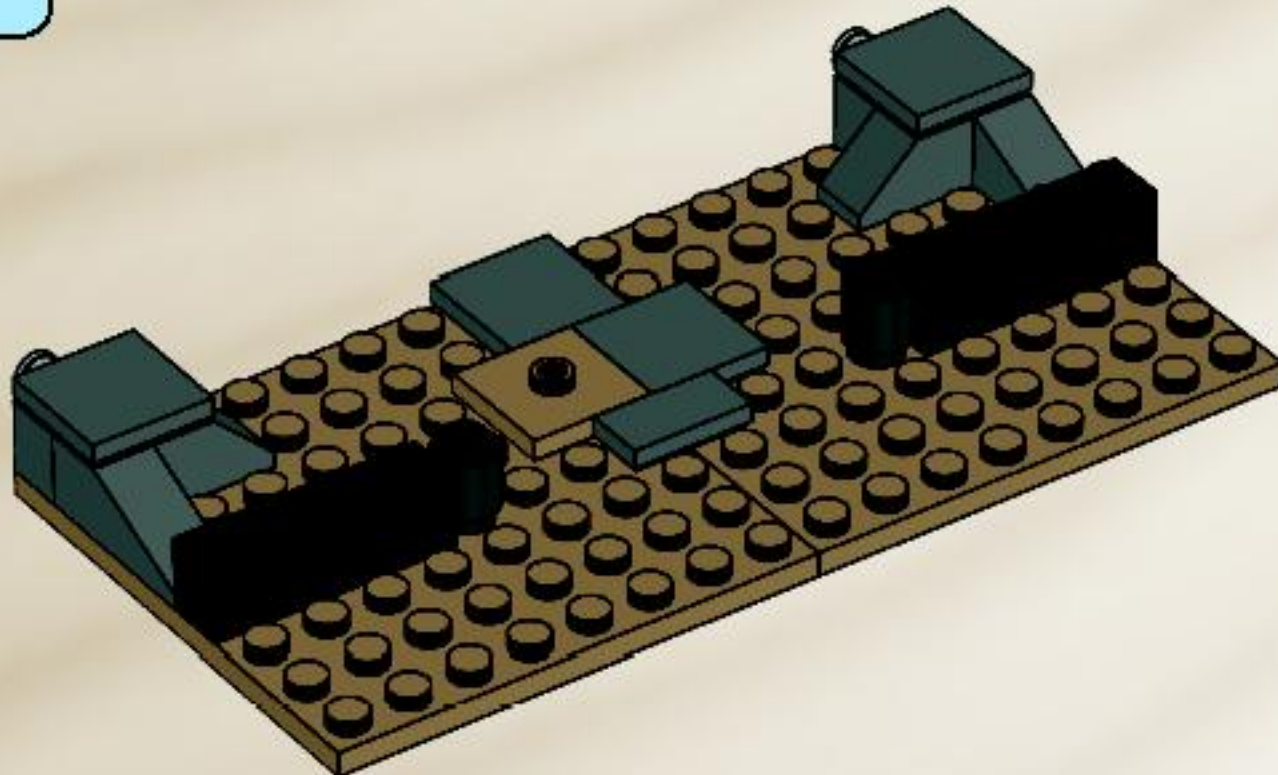



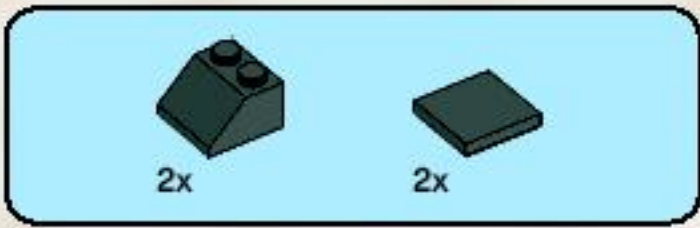

6

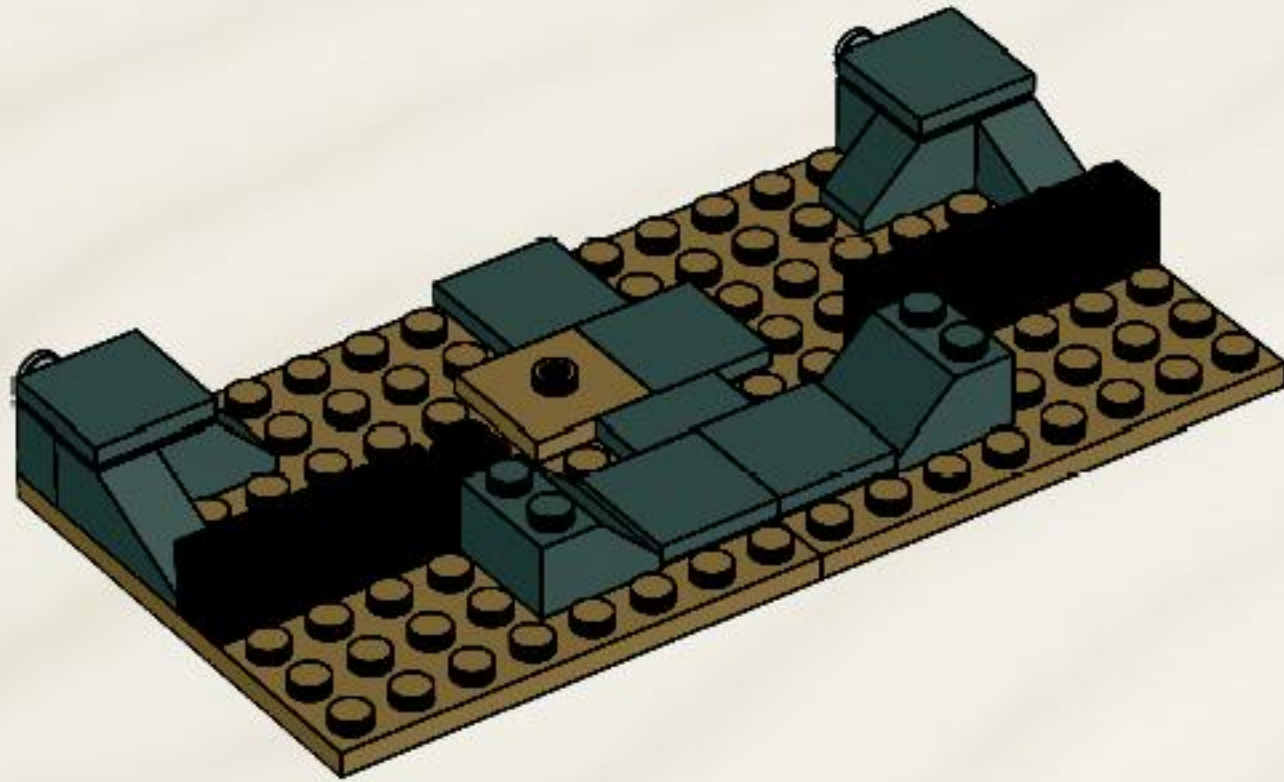

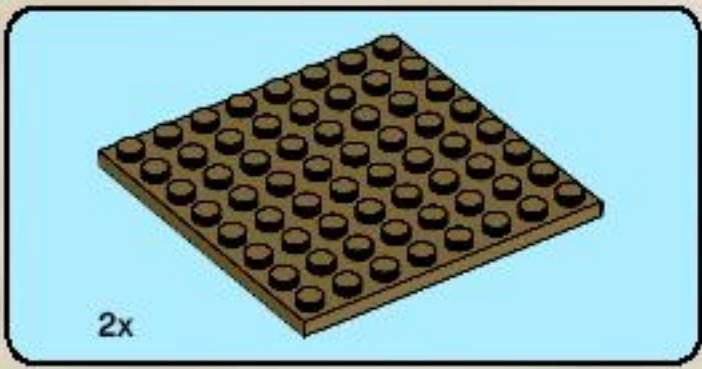

7

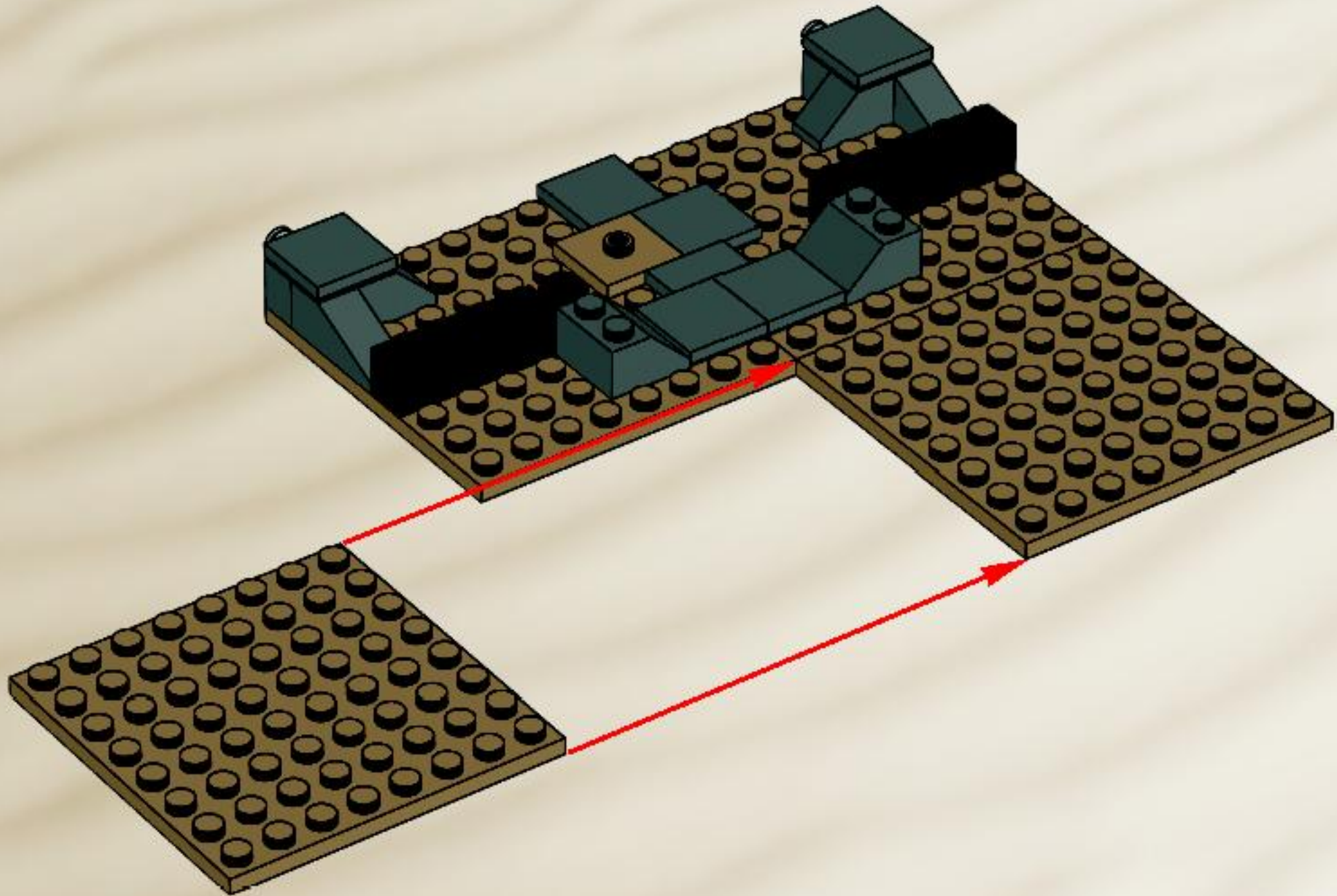

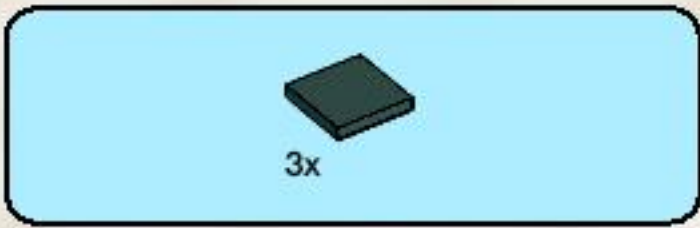

8

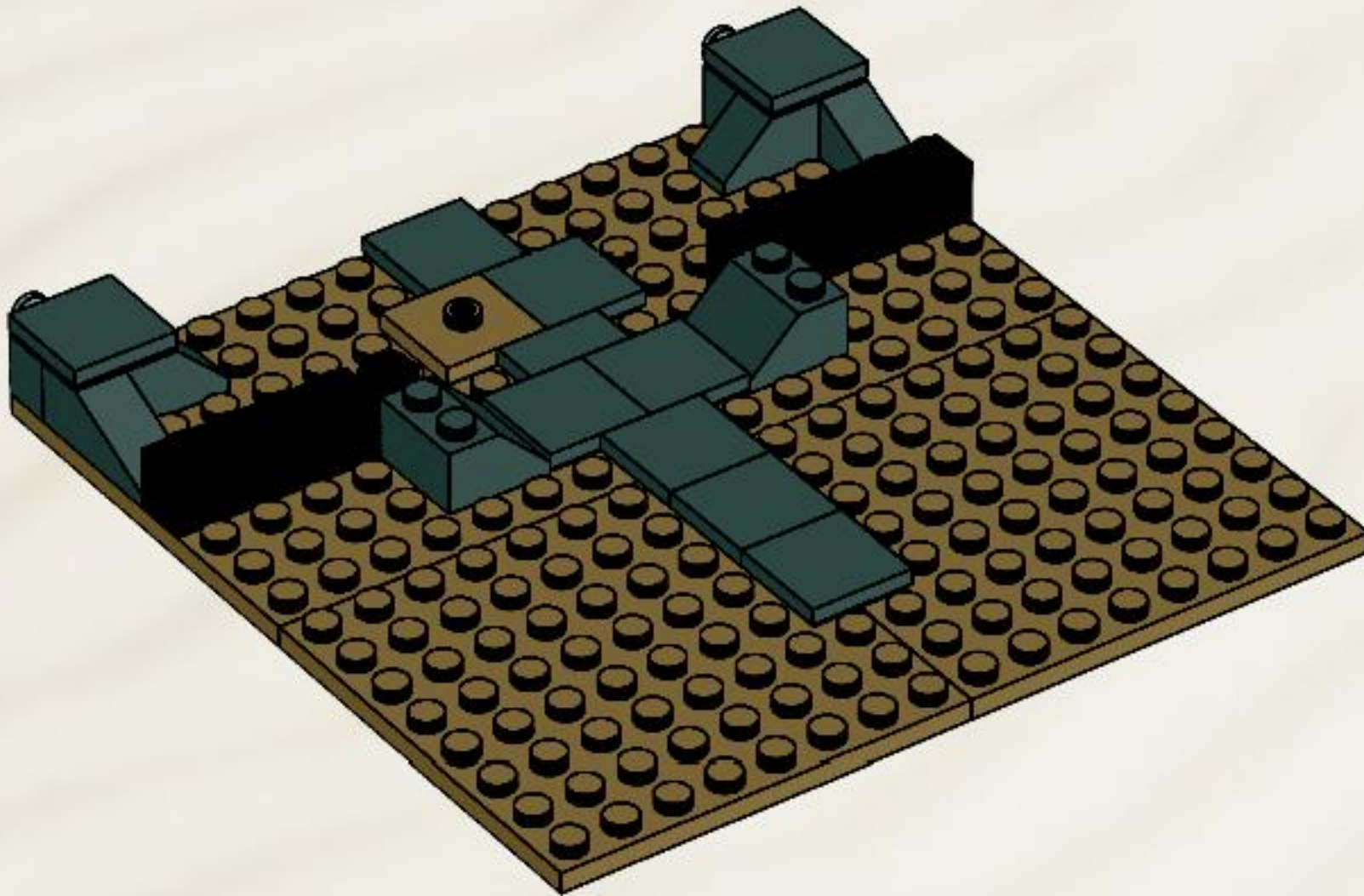

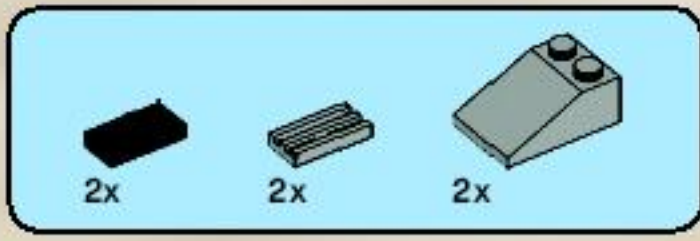

9

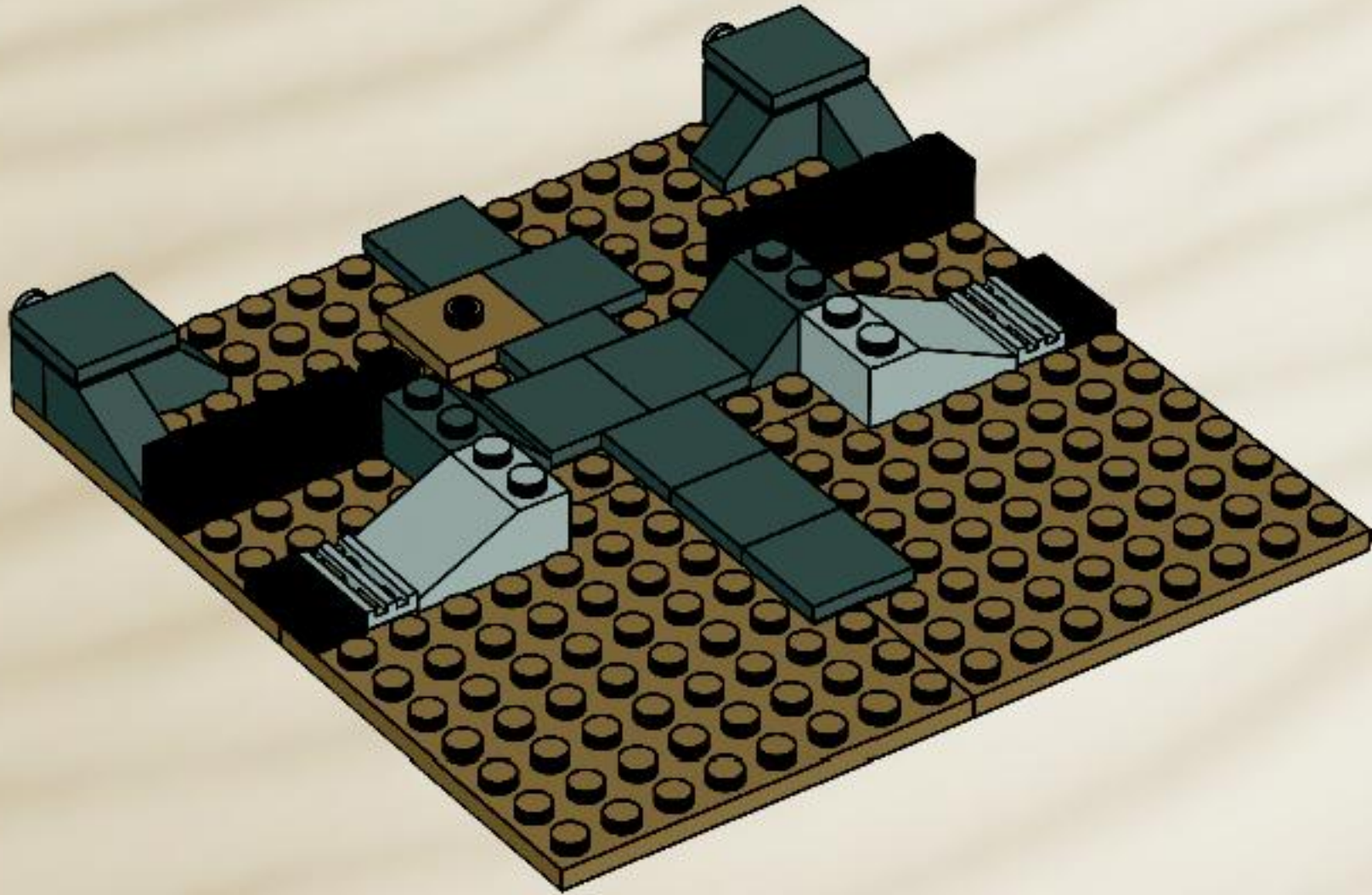

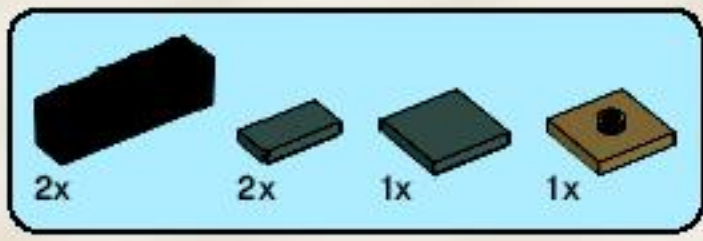

10

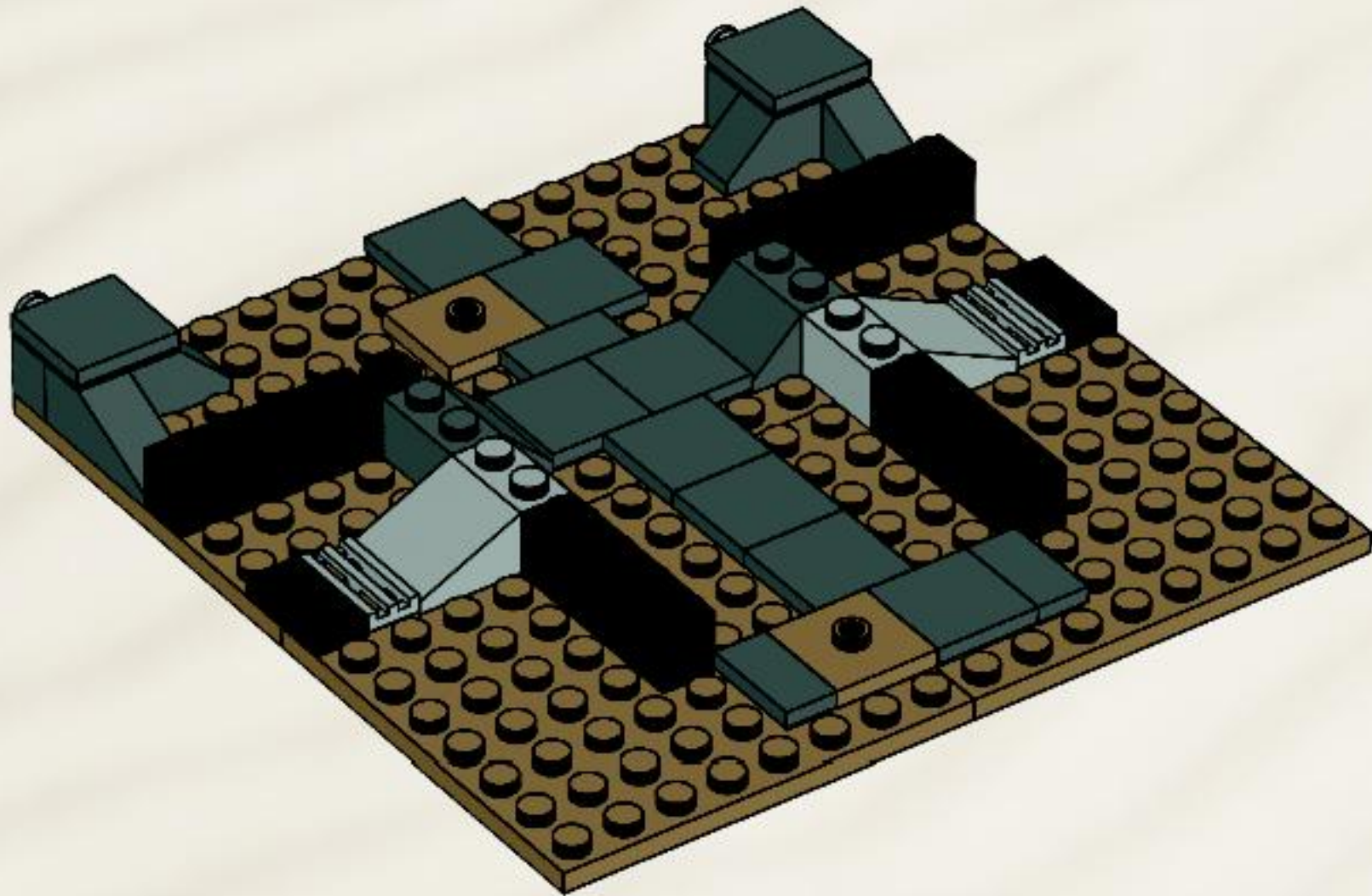

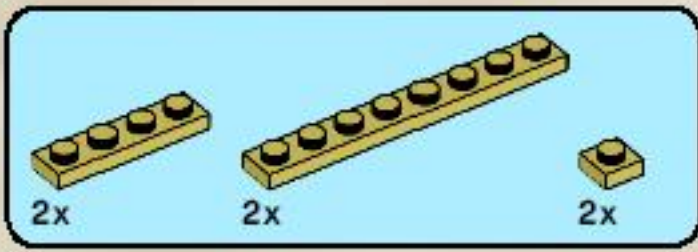

11

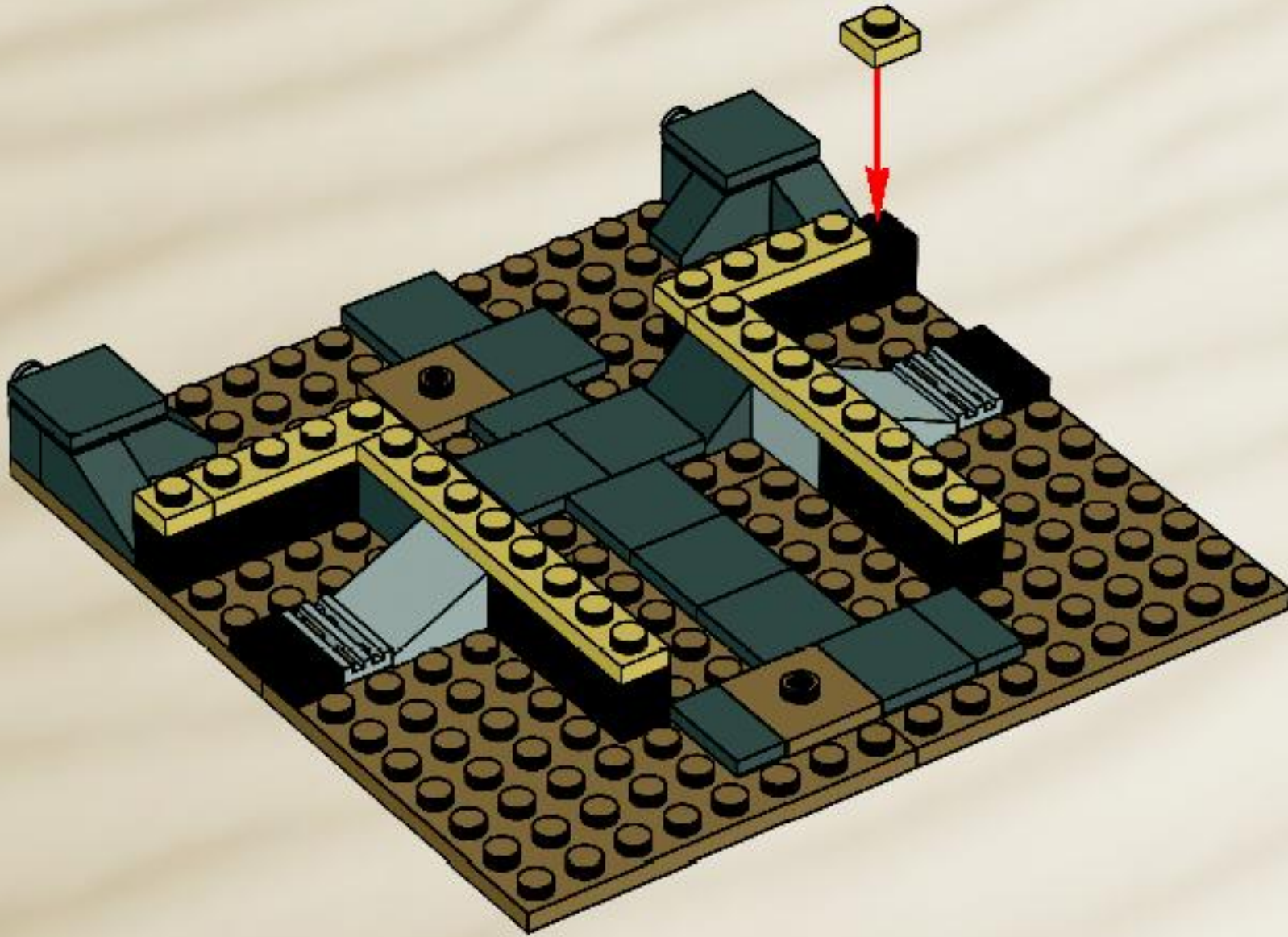

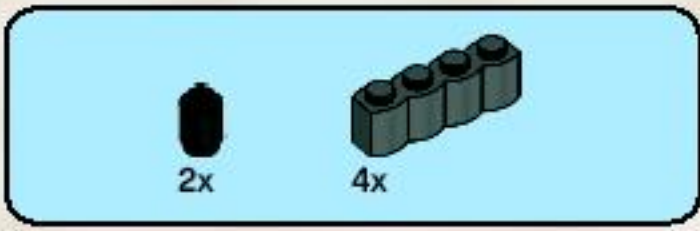

12

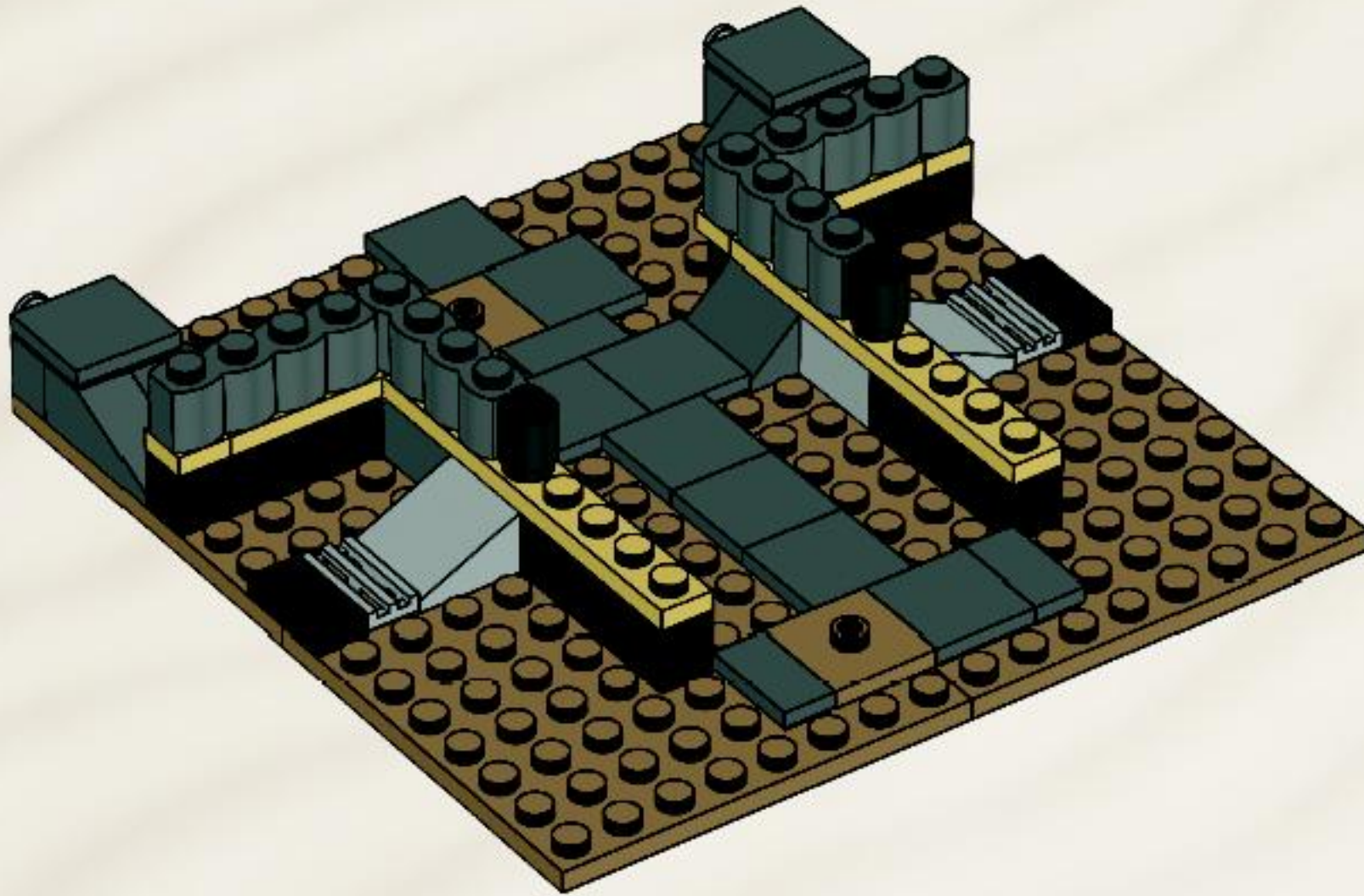

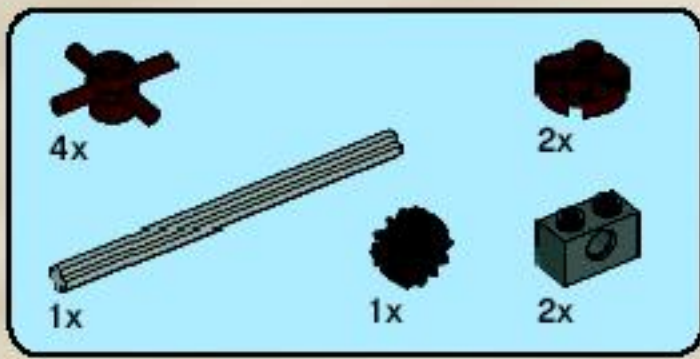

13

1

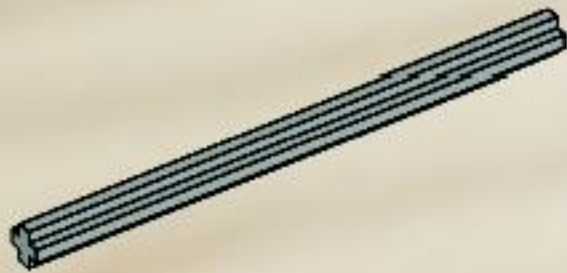

2

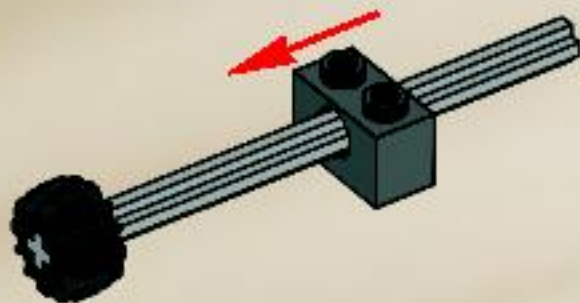

3

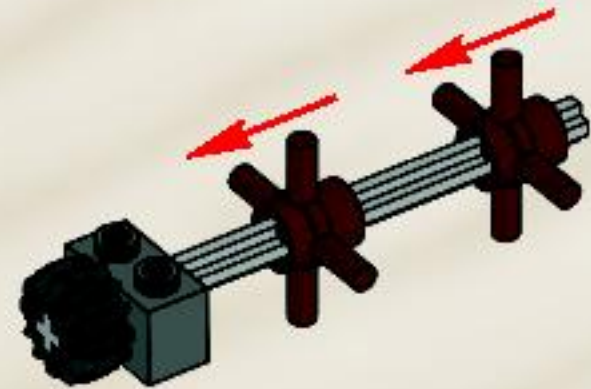

4

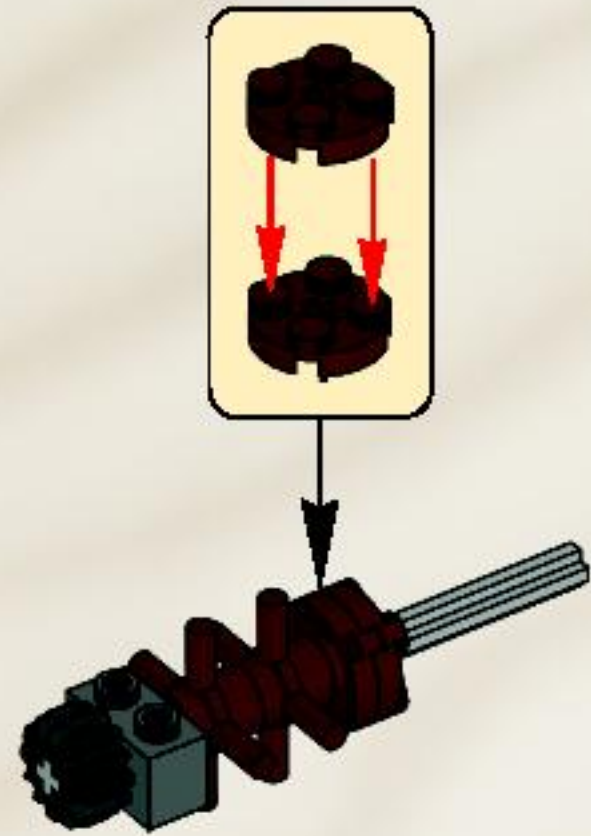



5

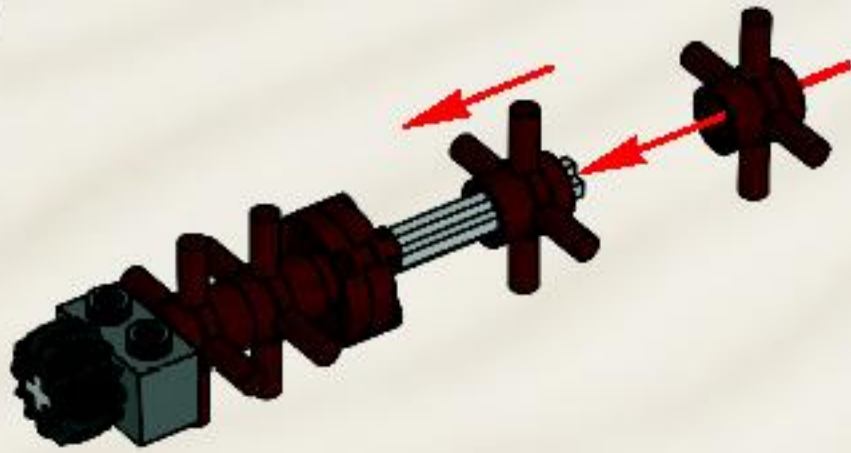

6

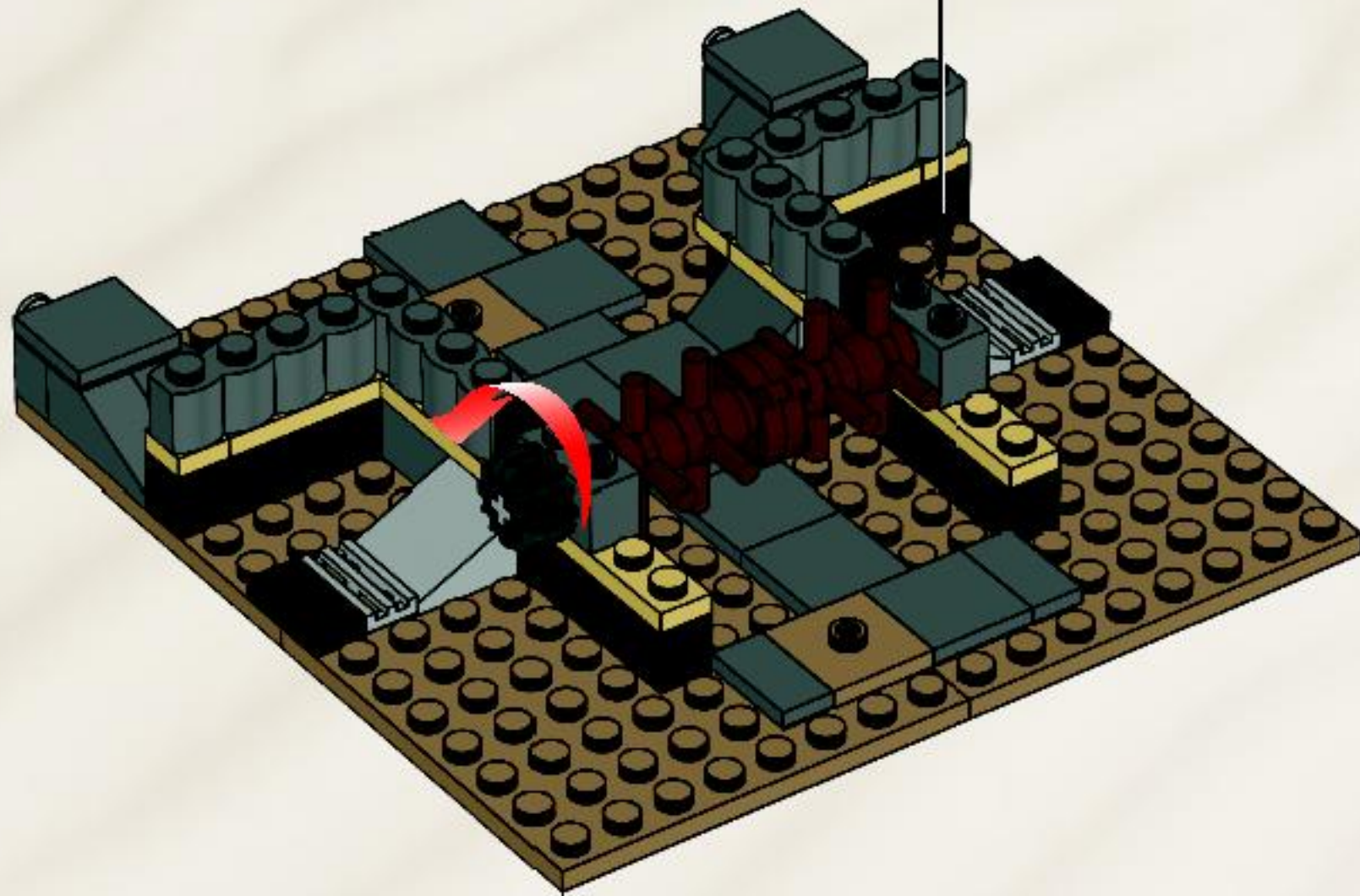
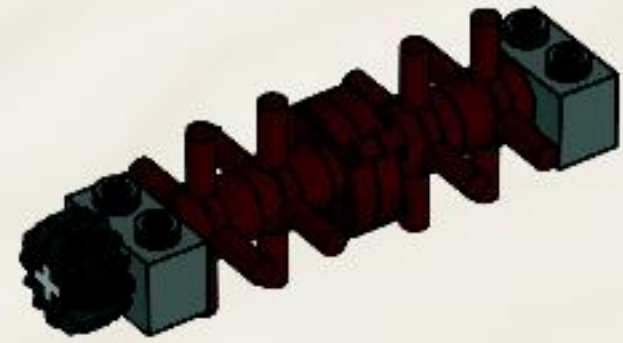

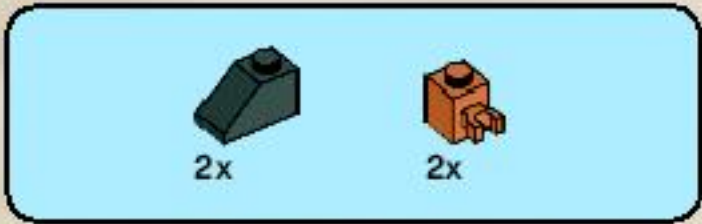

14

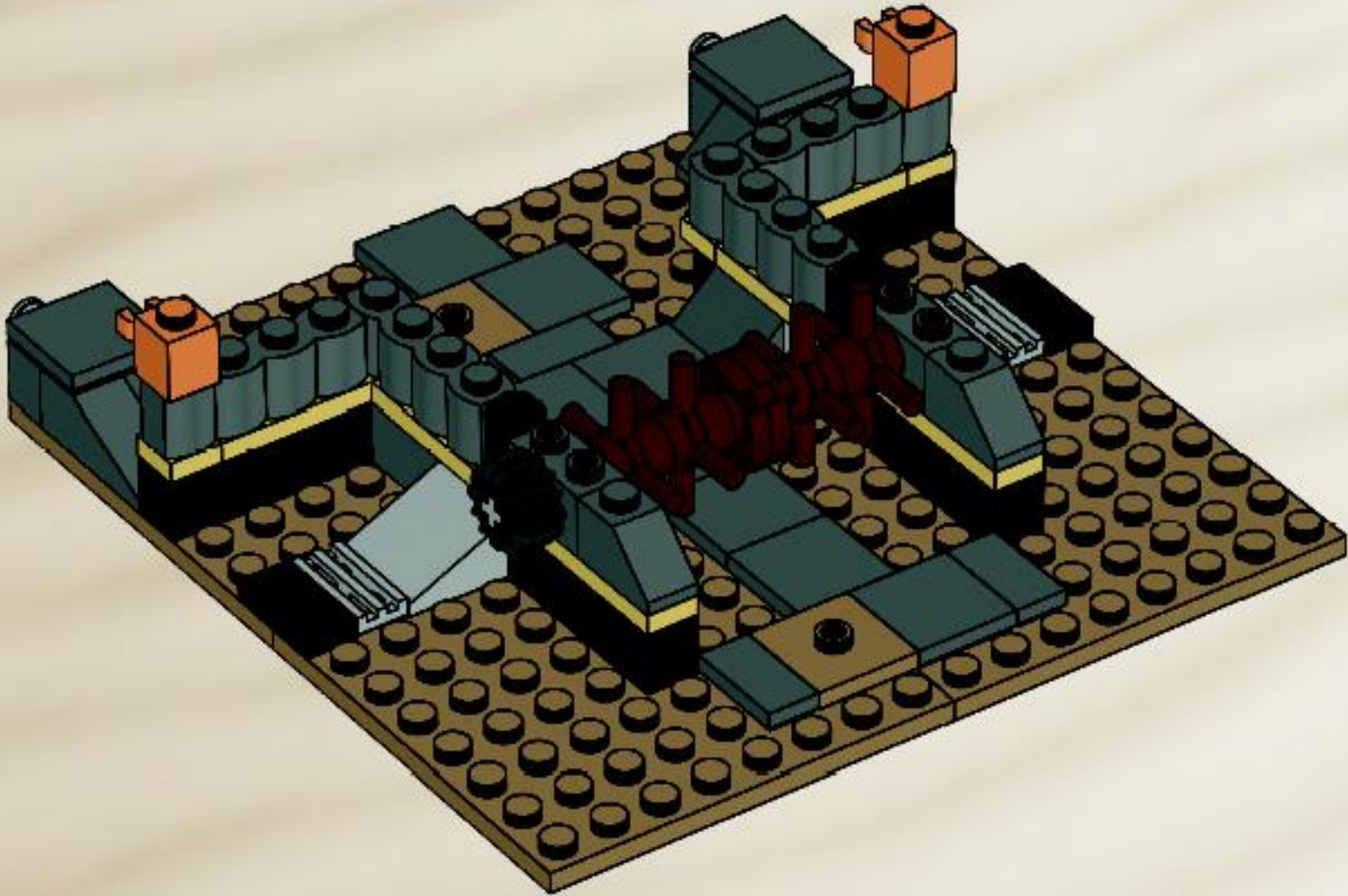

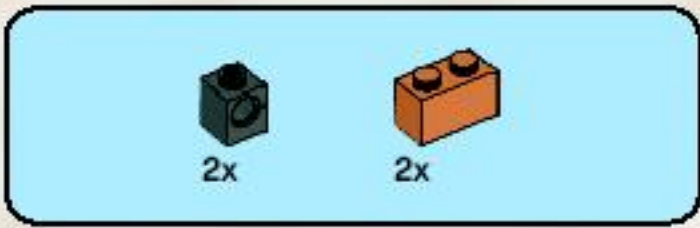

15

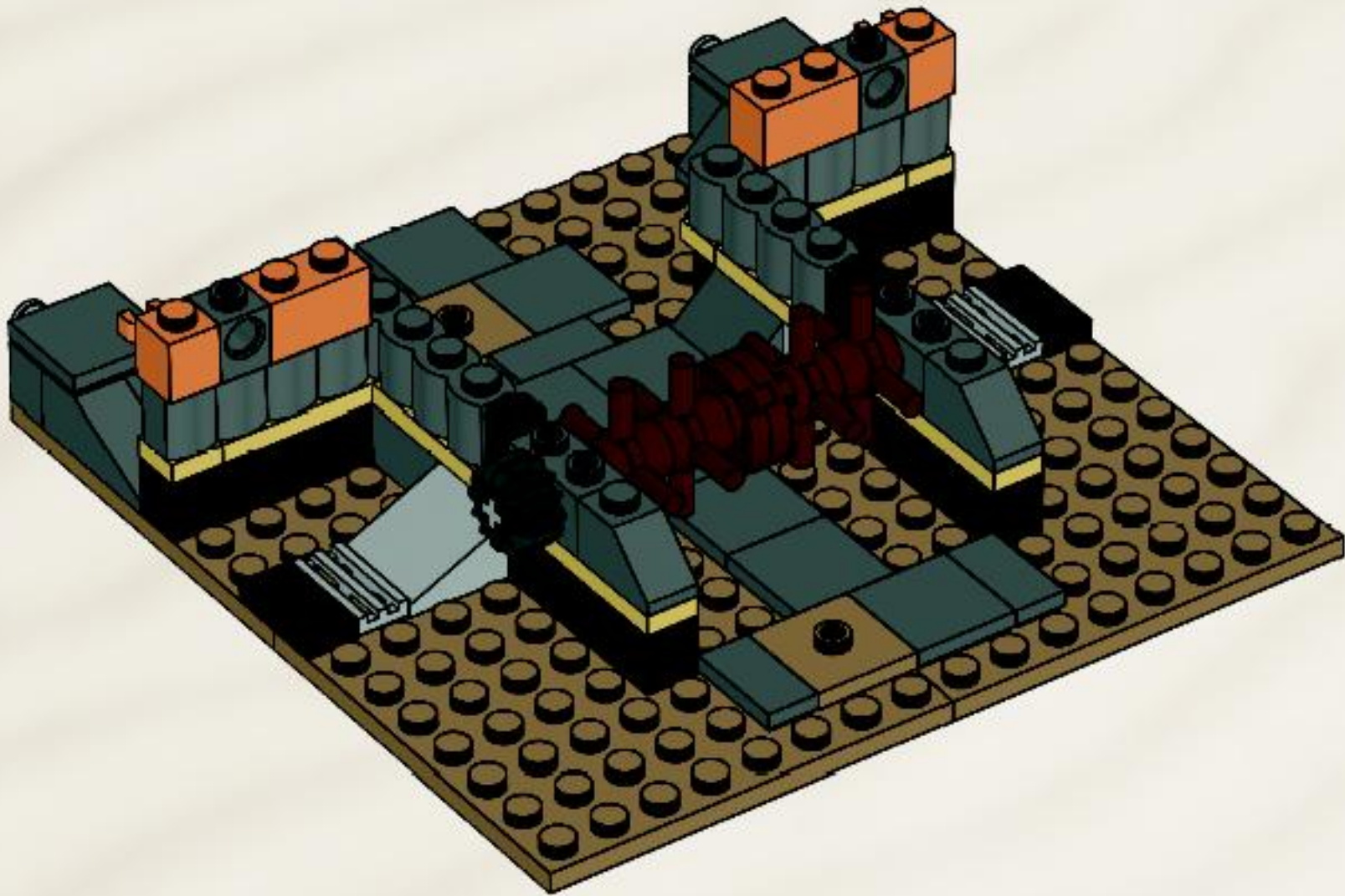



4x

# 16

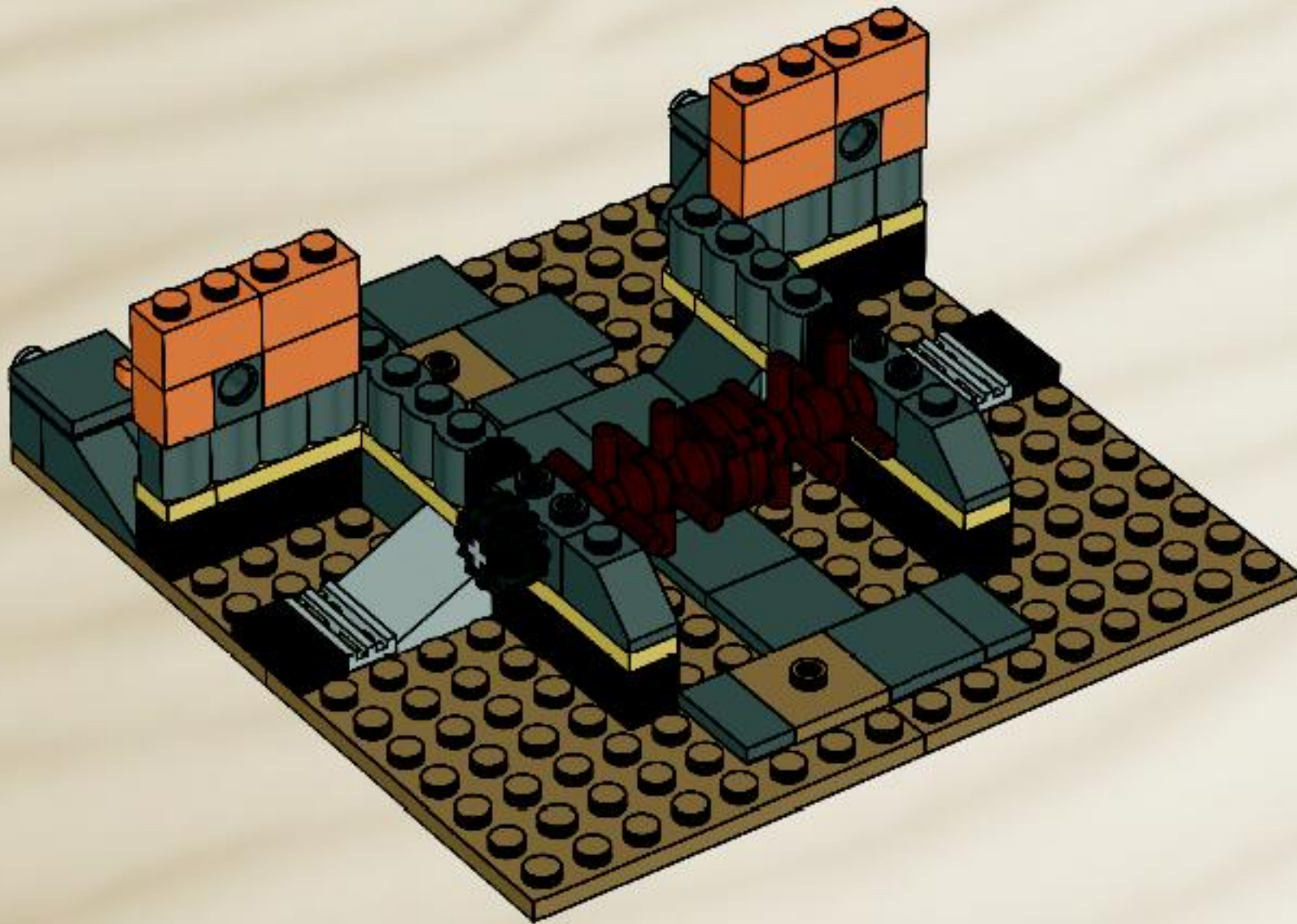

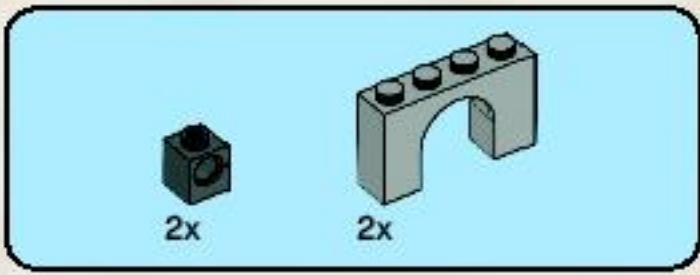

17

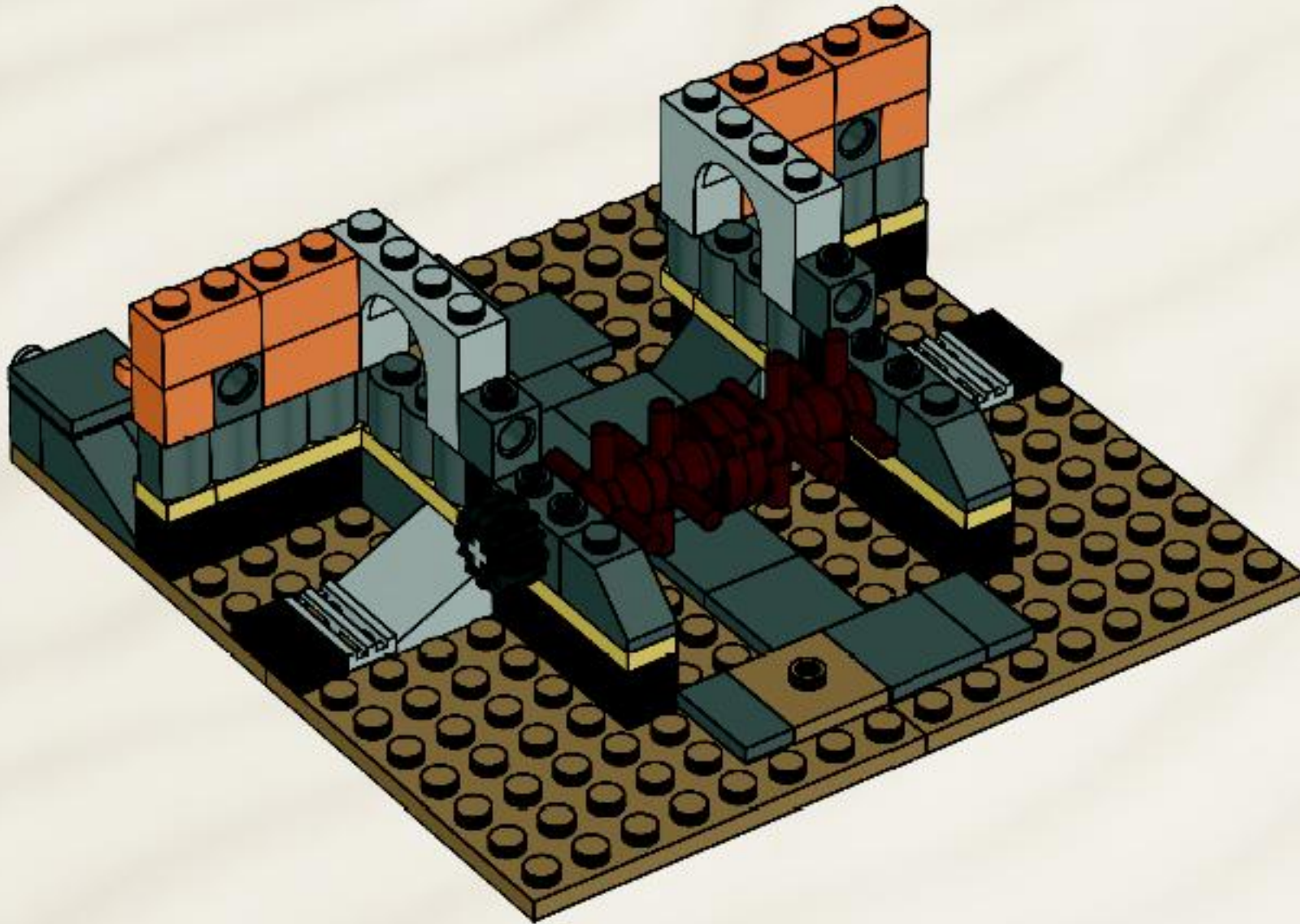

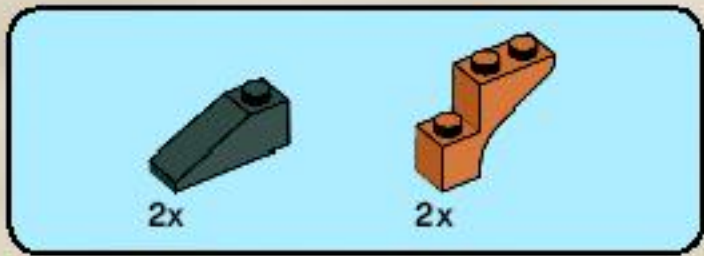

18

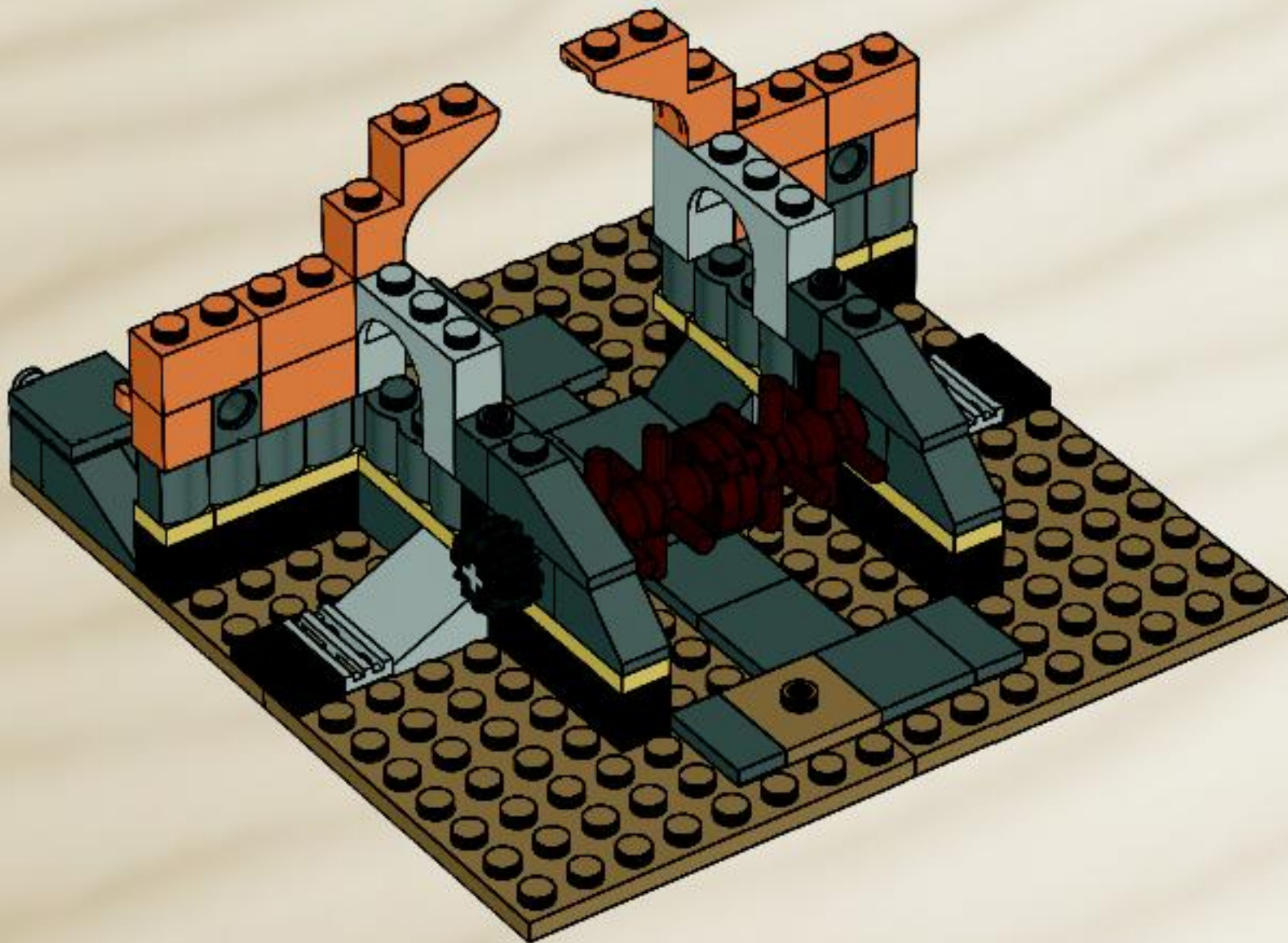

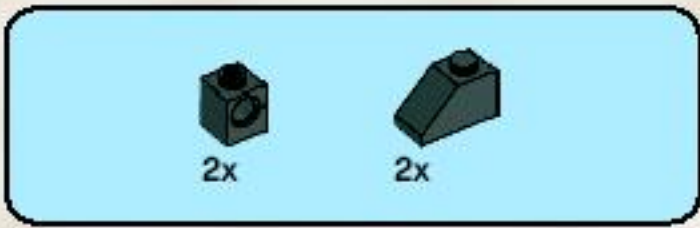

19

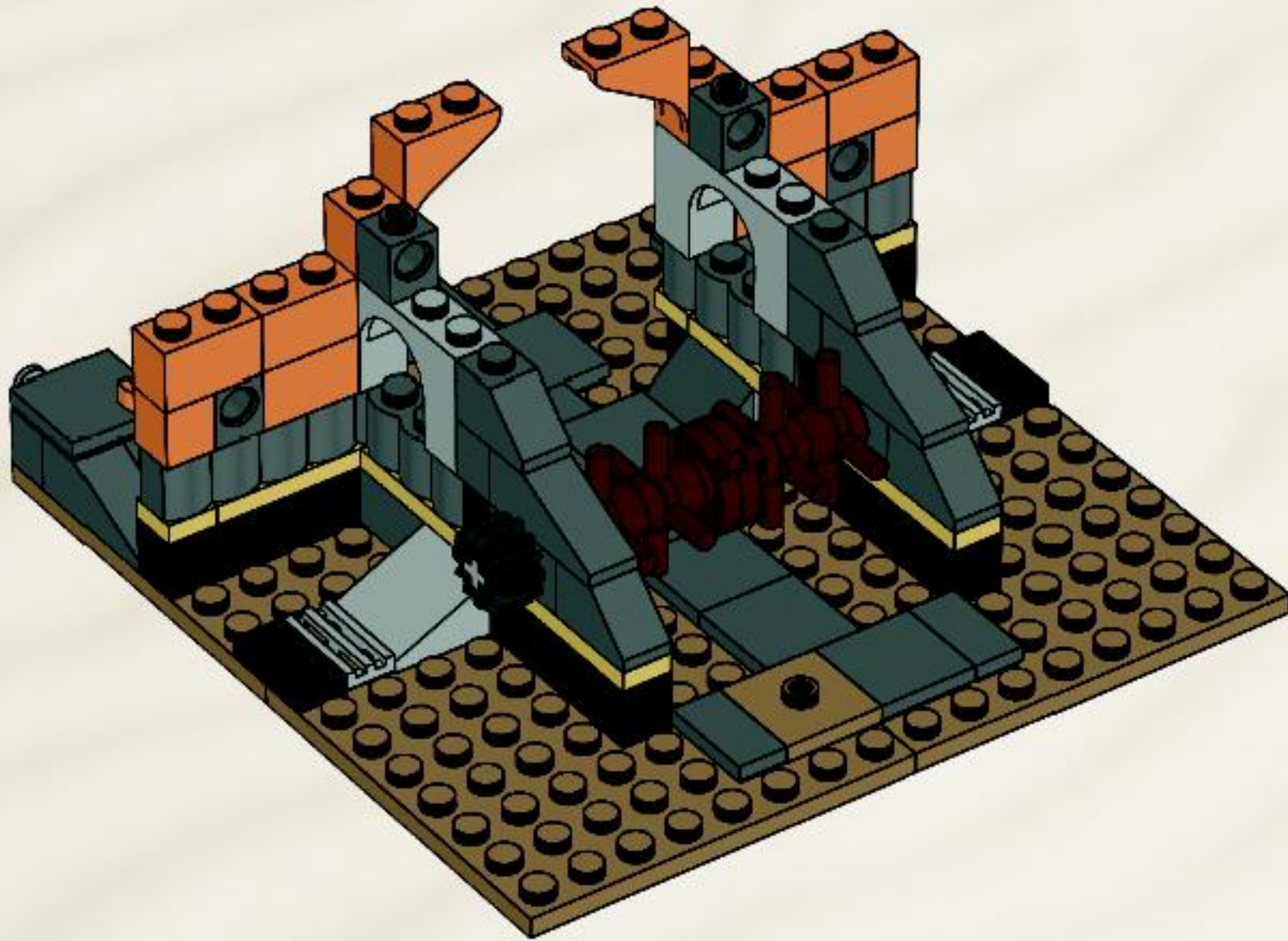

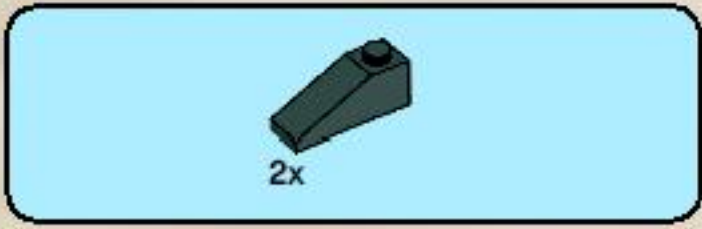

20

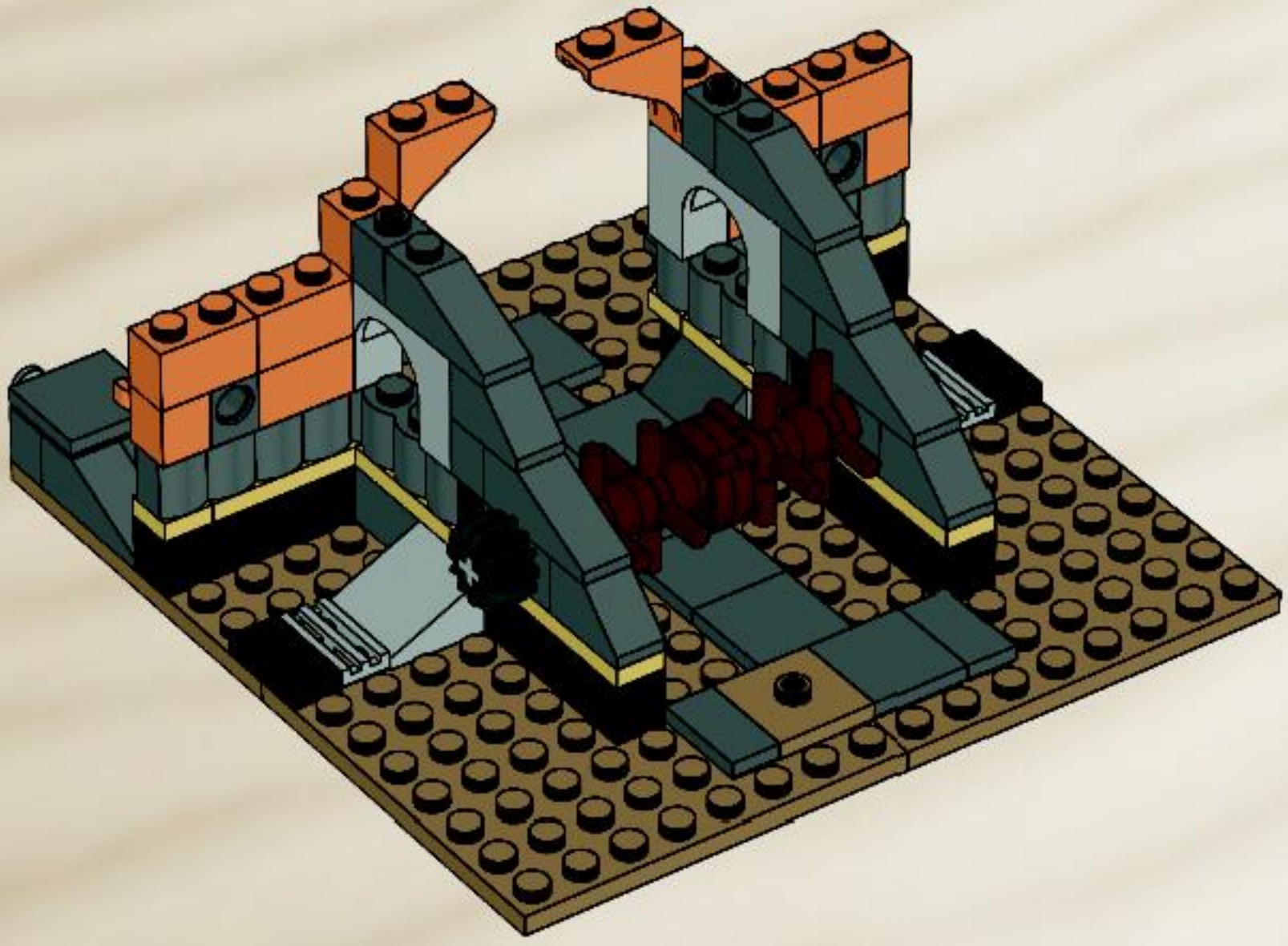



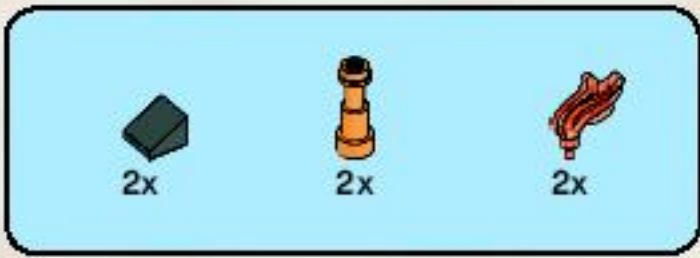

21

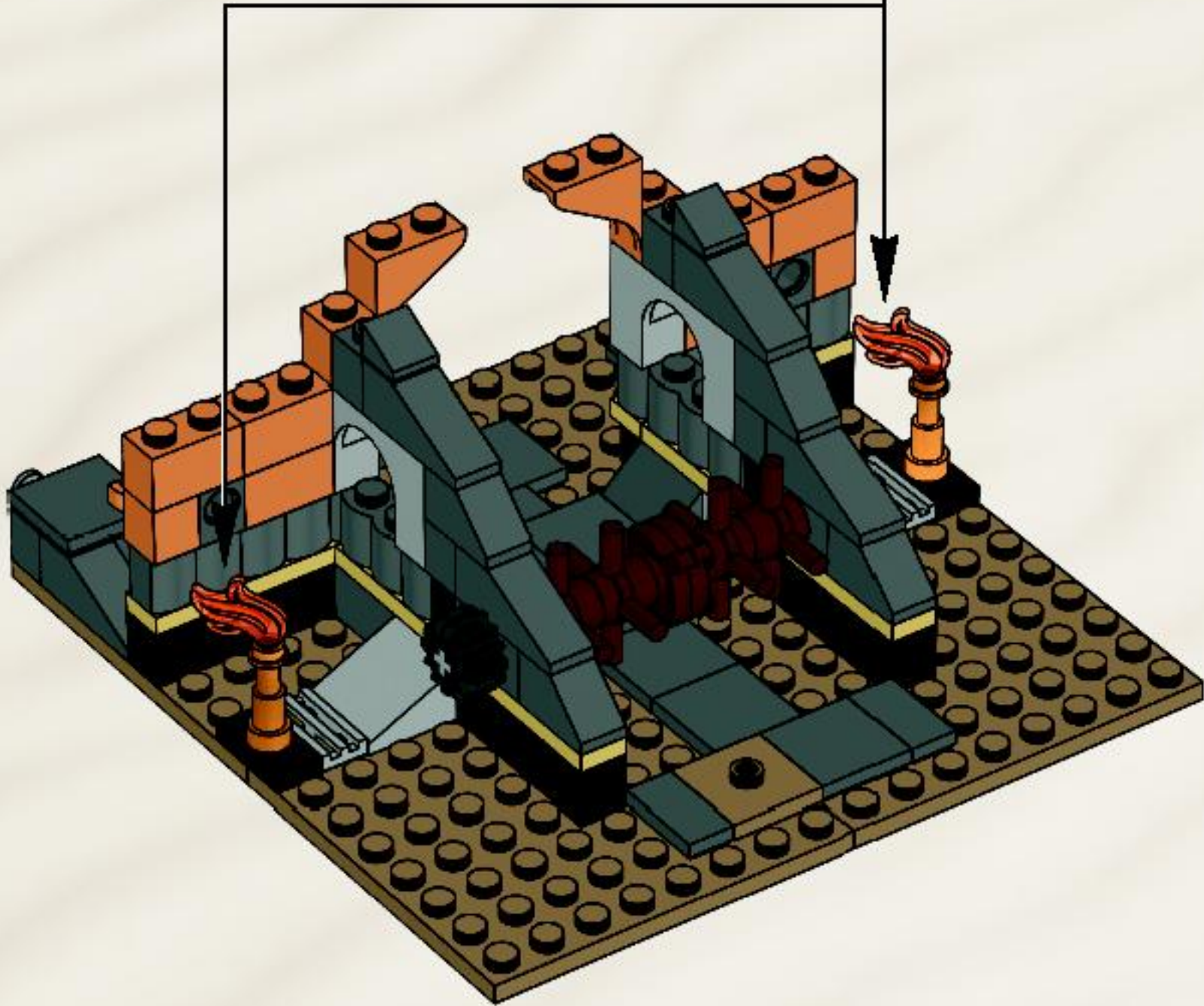

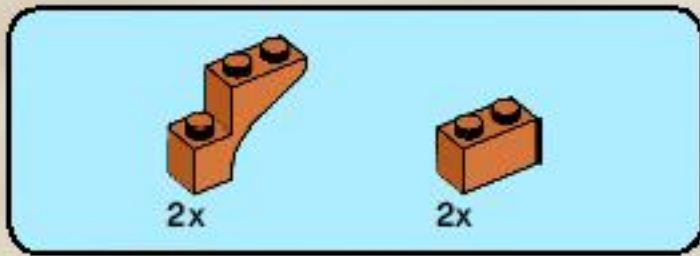

22

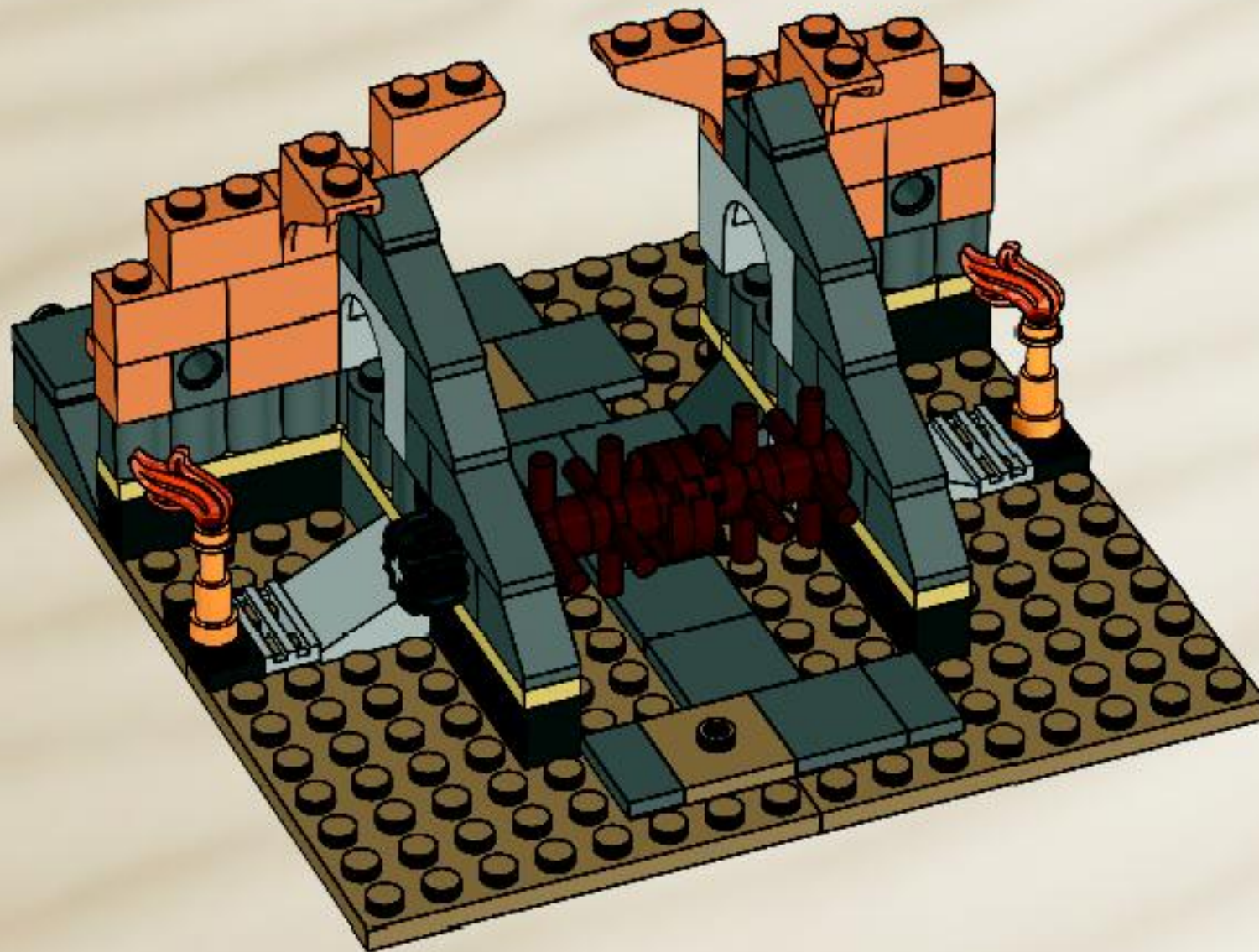

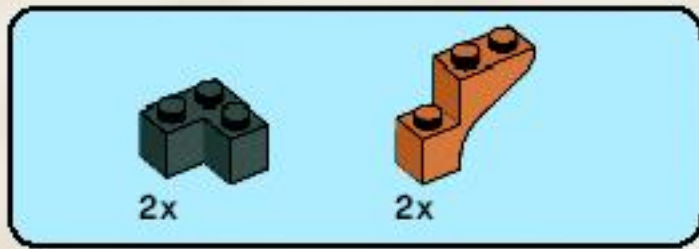

23

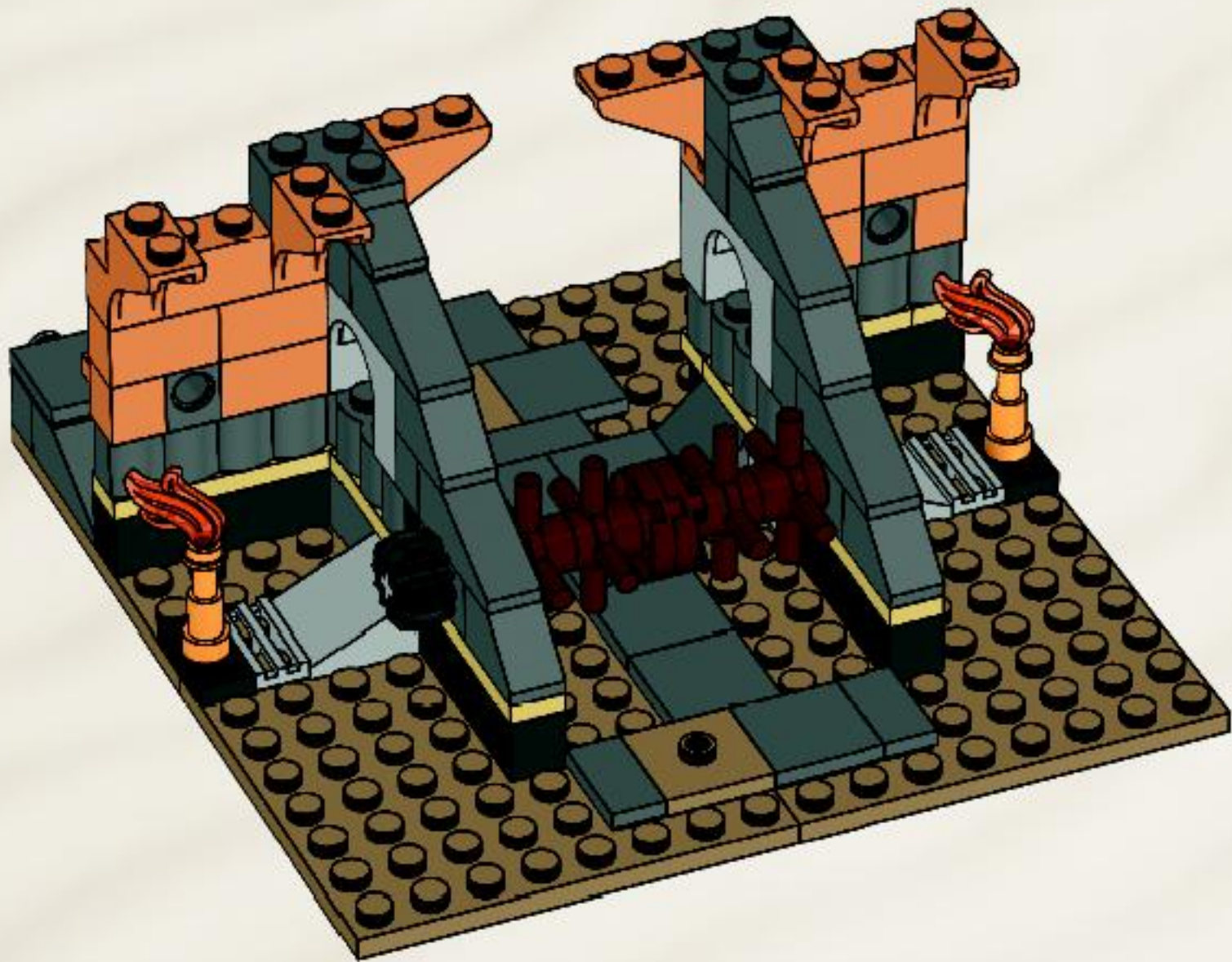

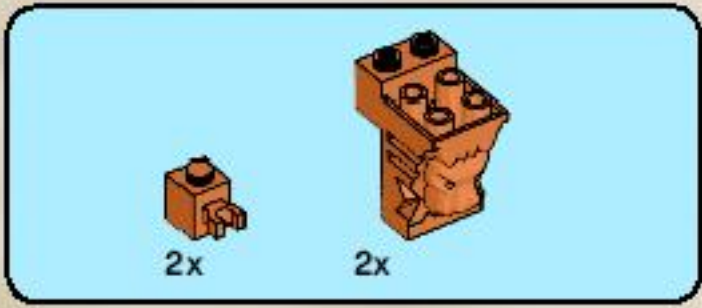

24

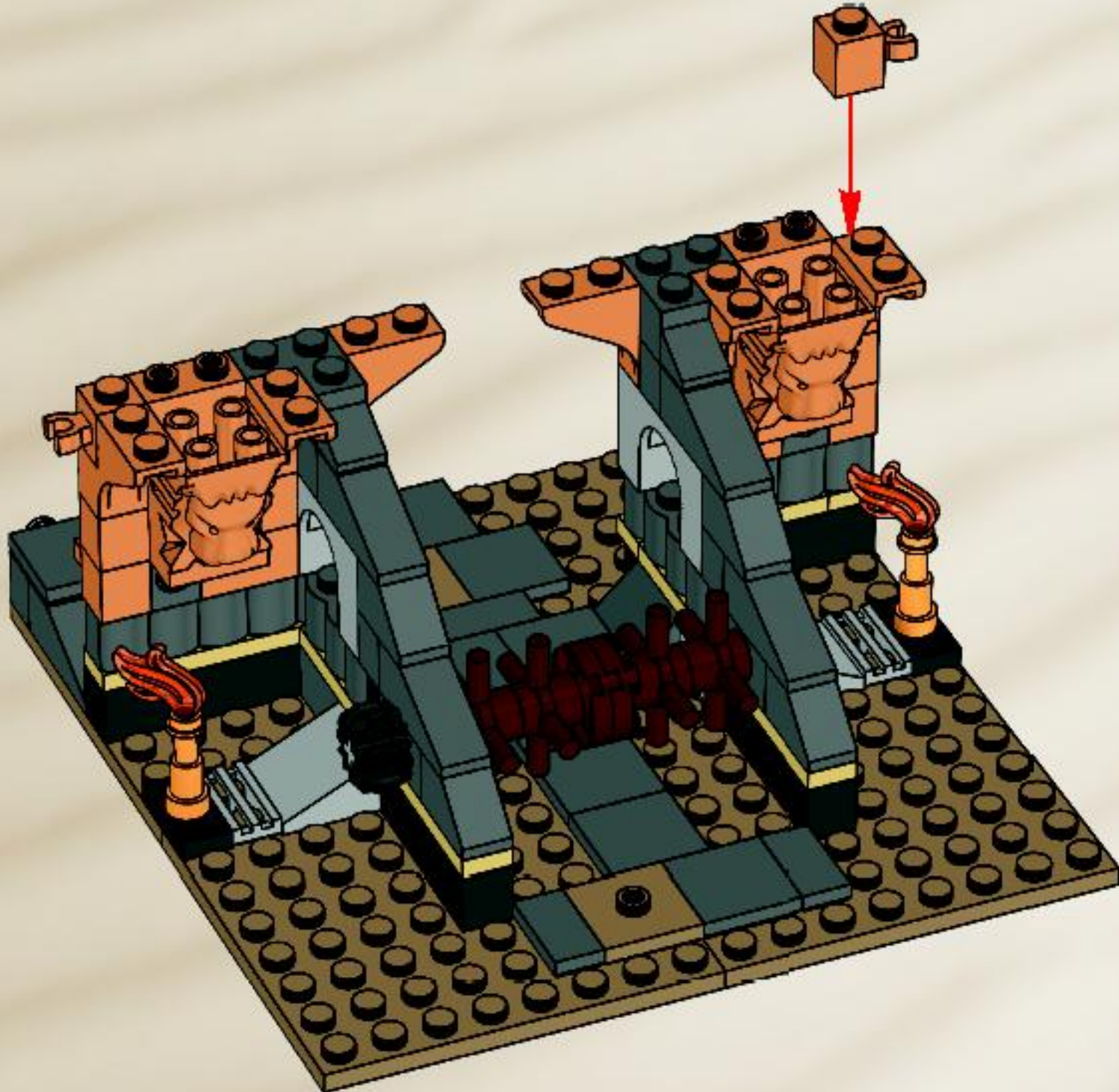

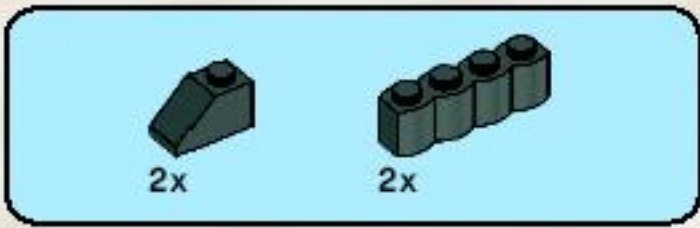

25

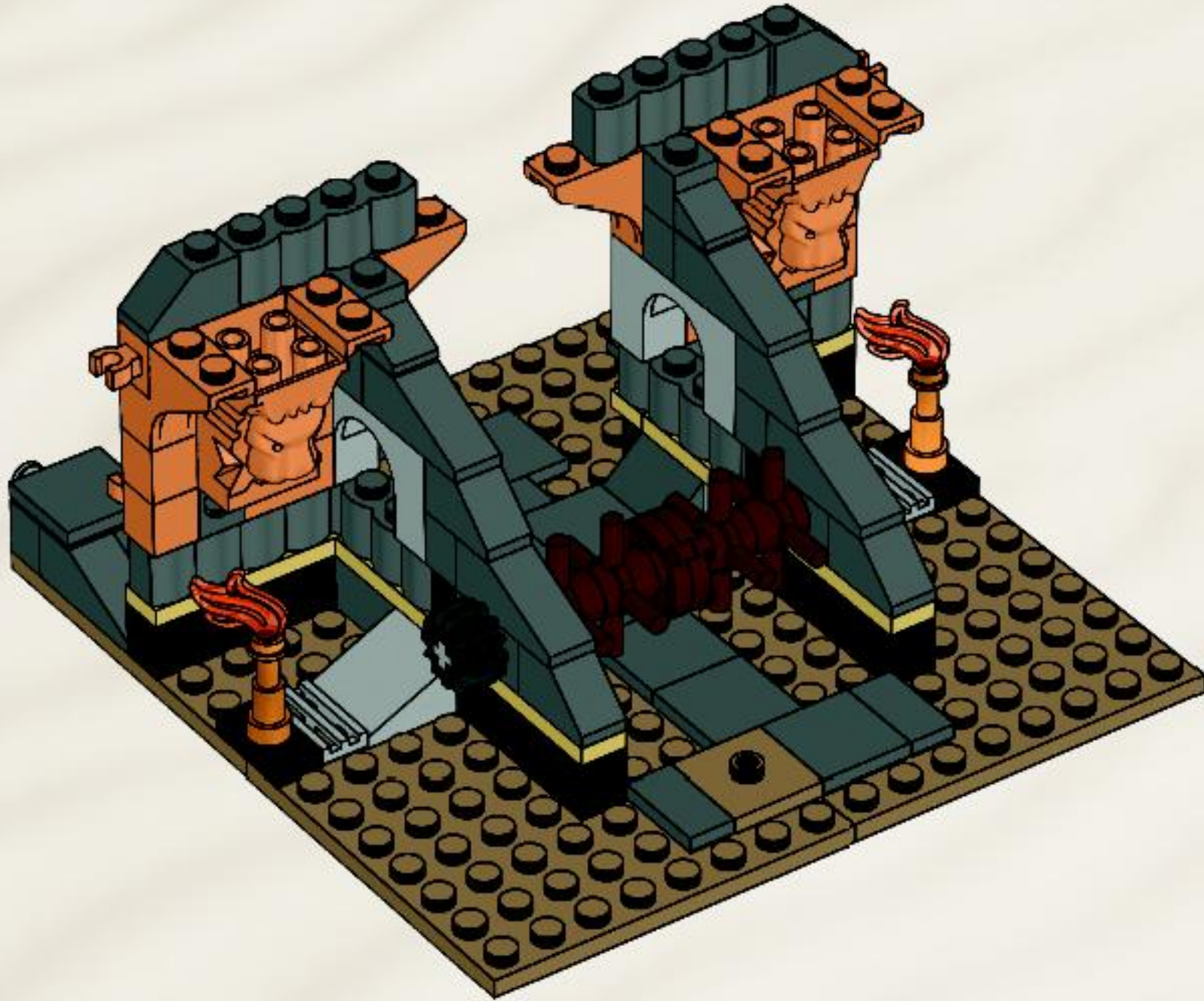

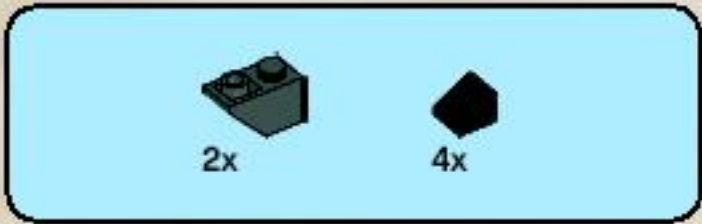

26

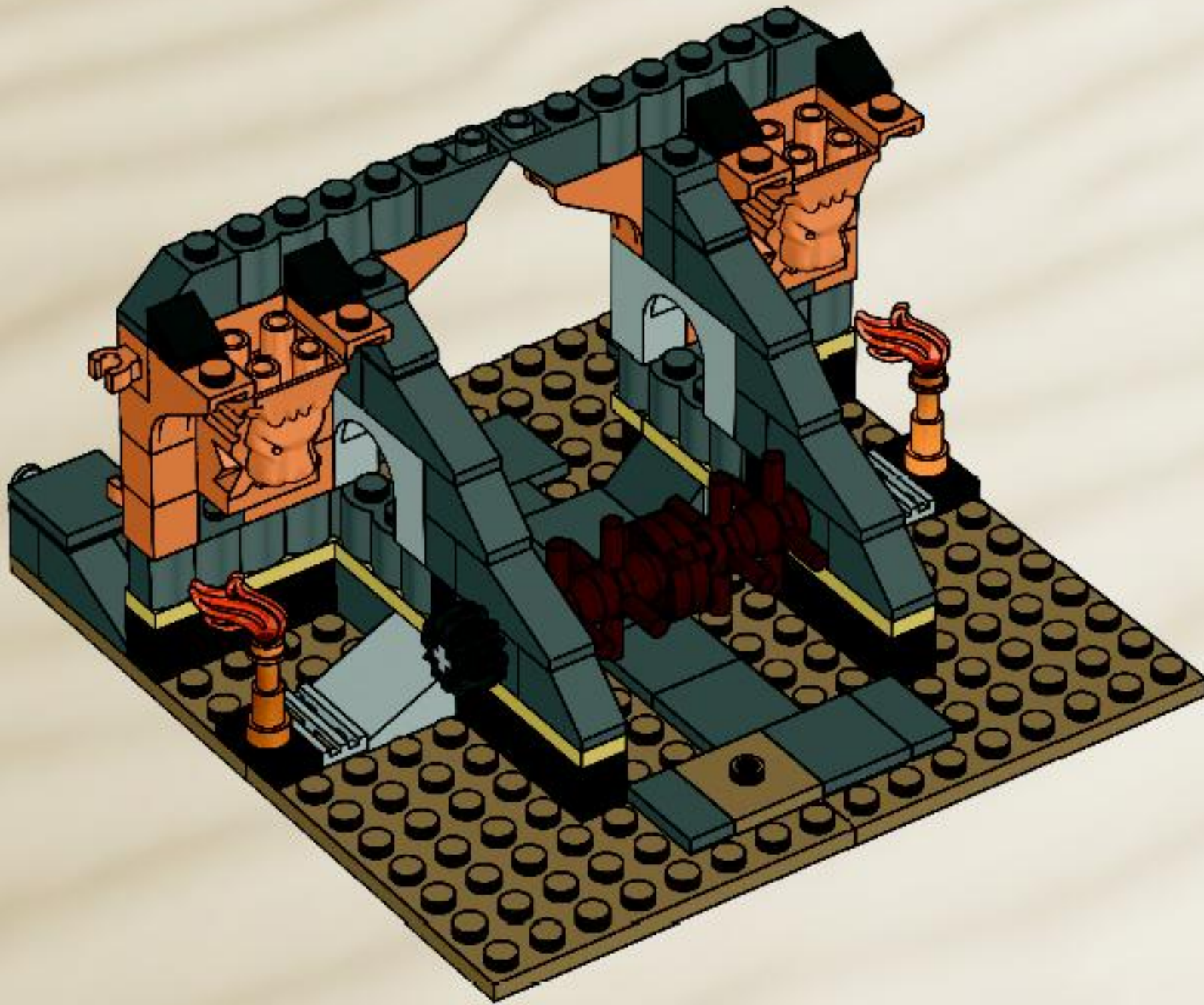

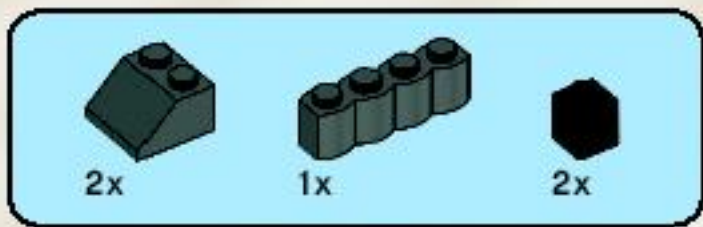

27

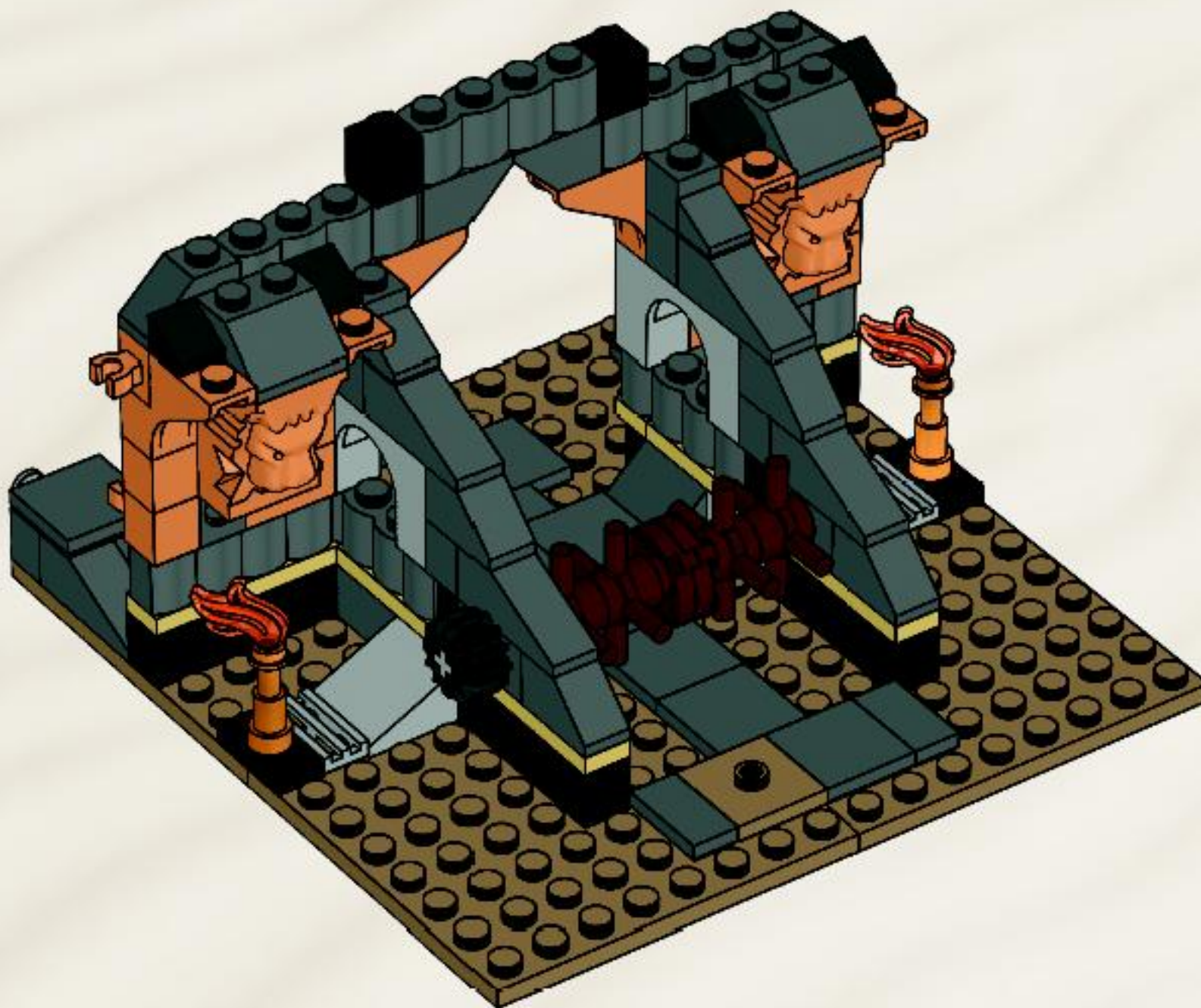

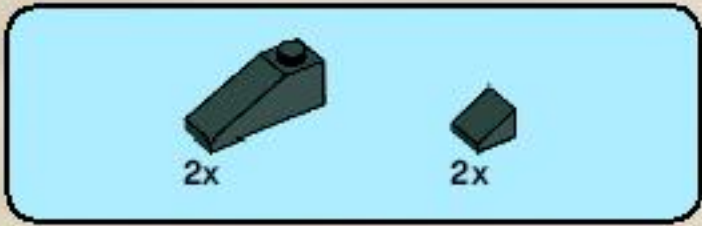

28

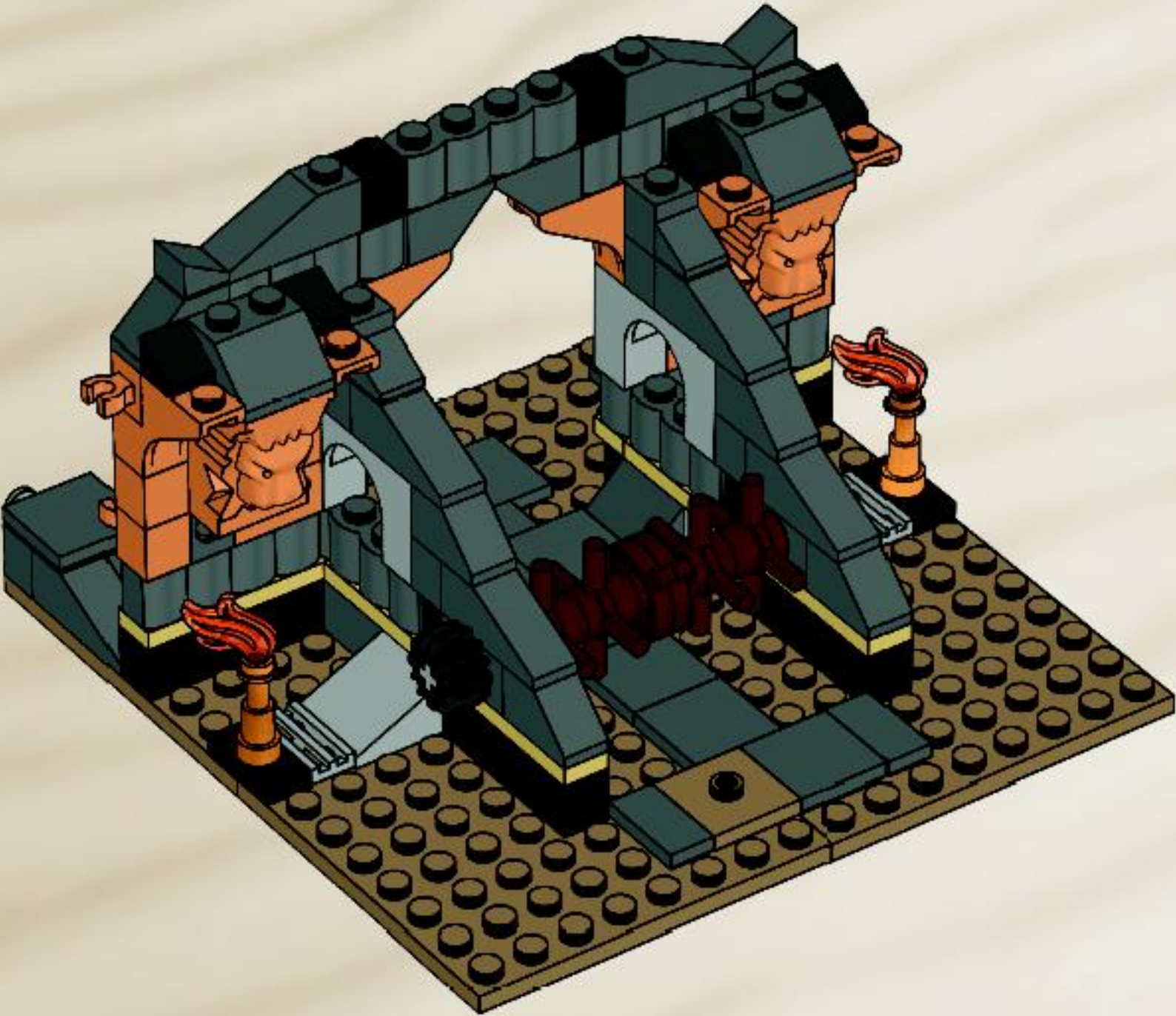





6x

# 29

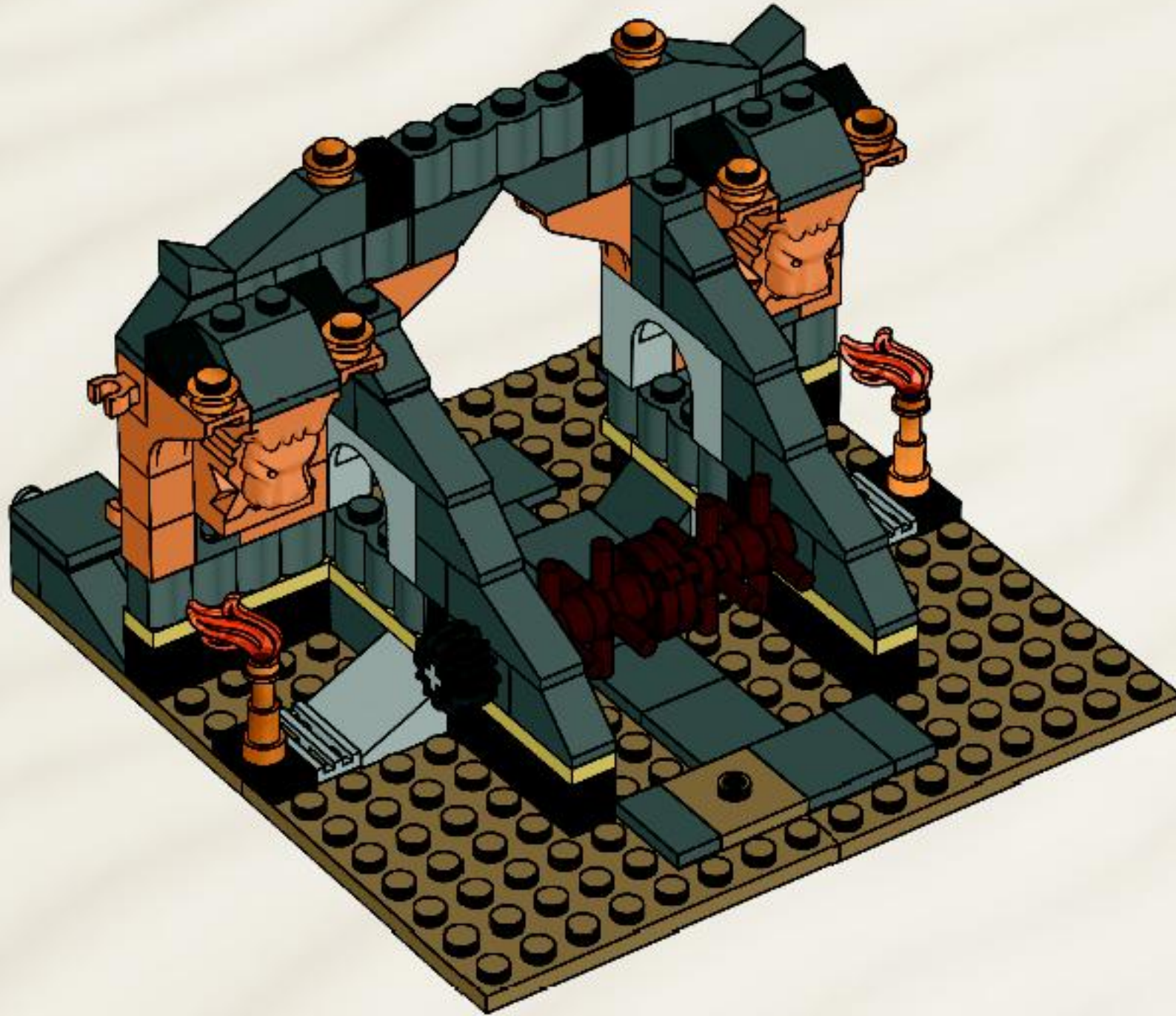

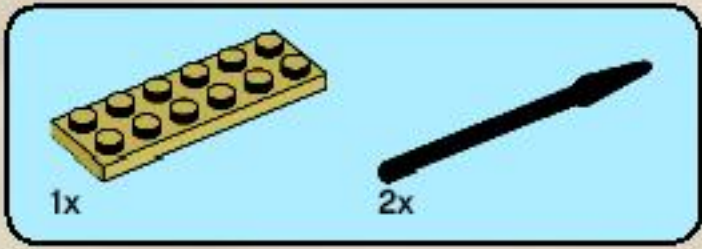

30



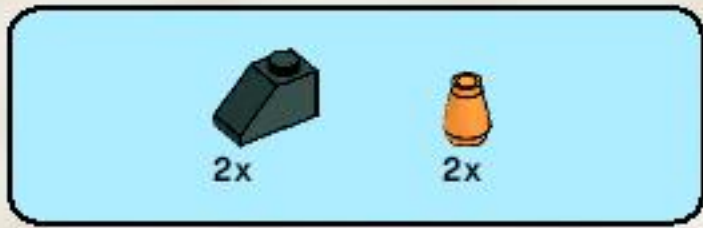

31

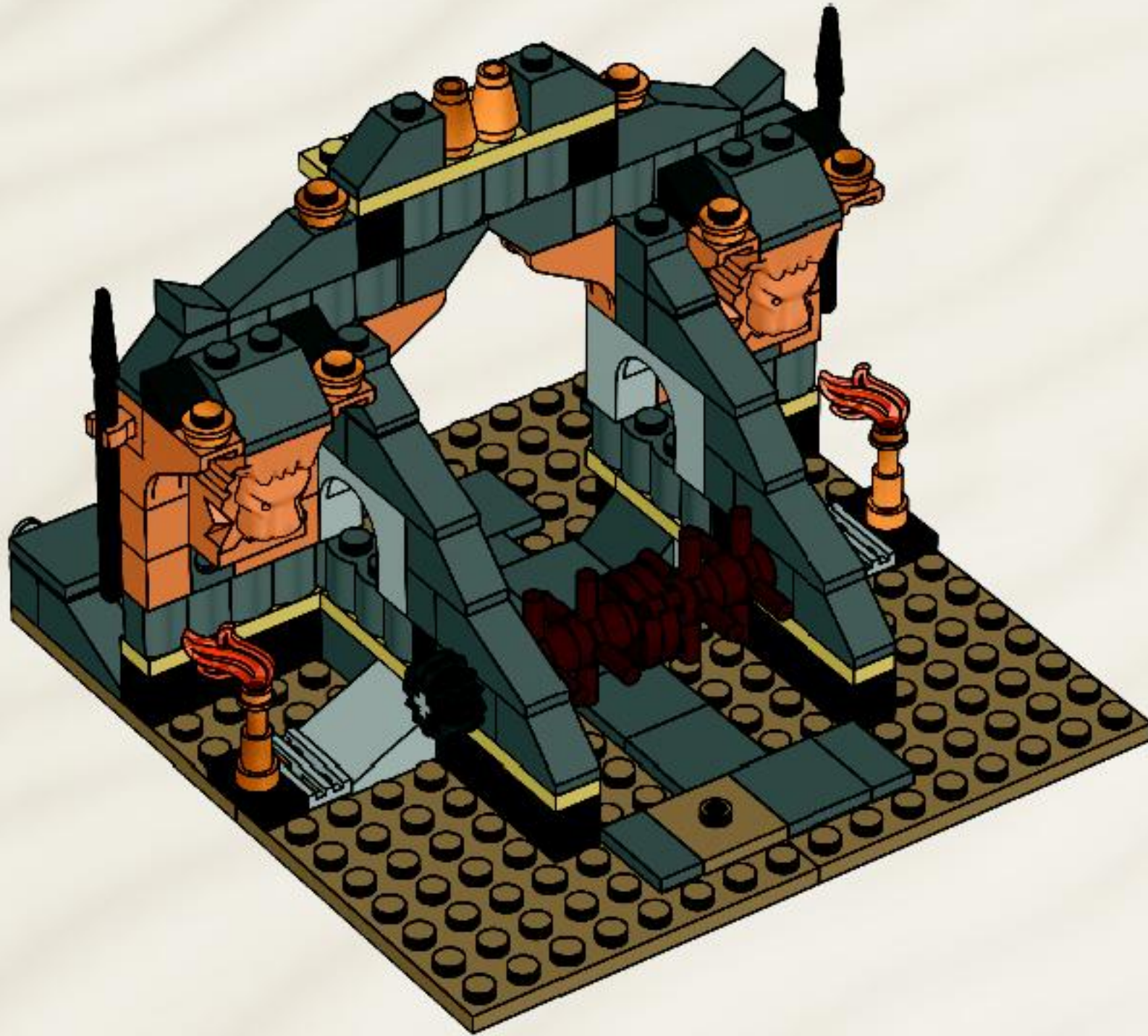

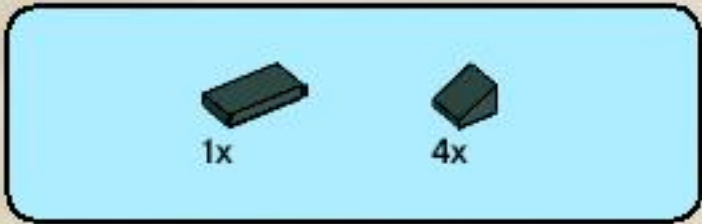

32



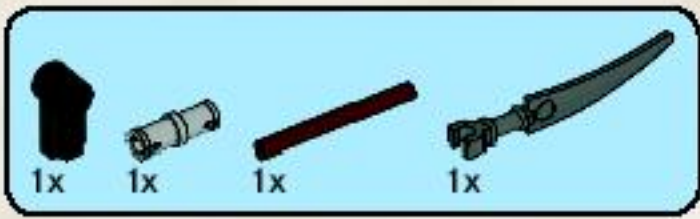

33

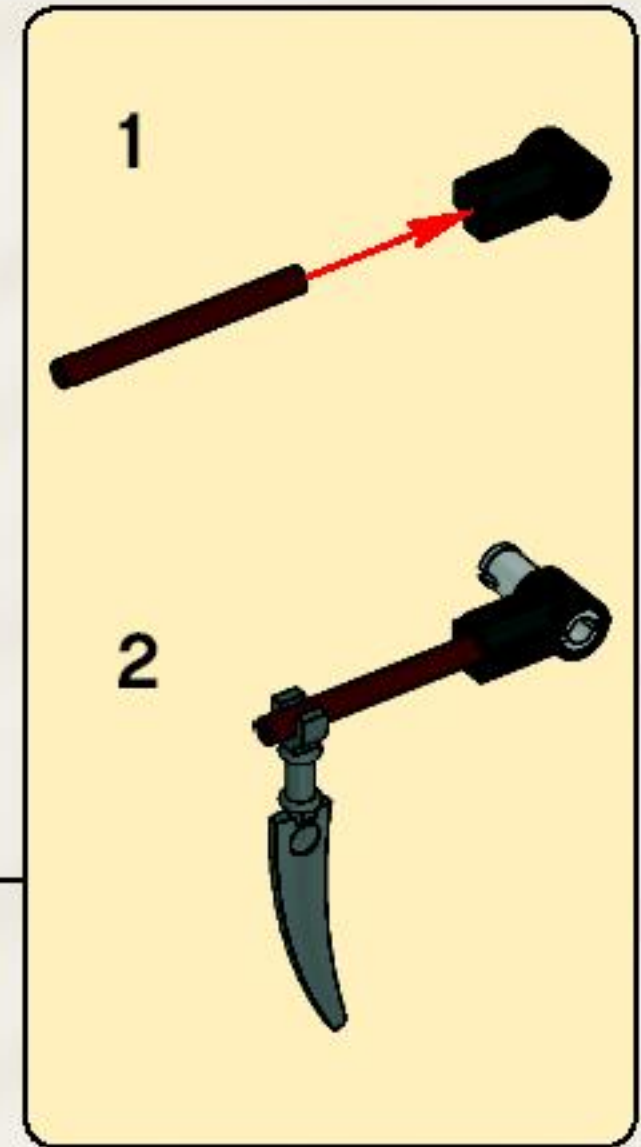

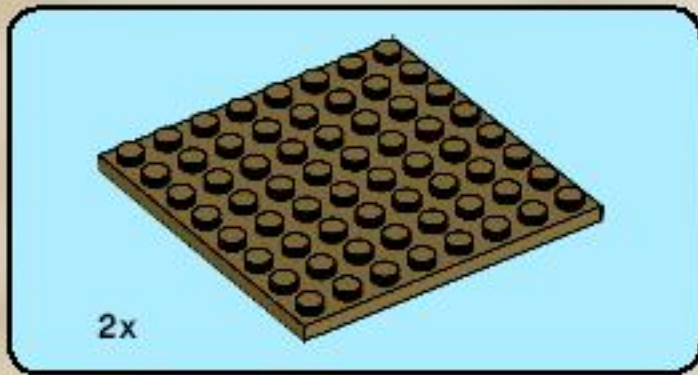
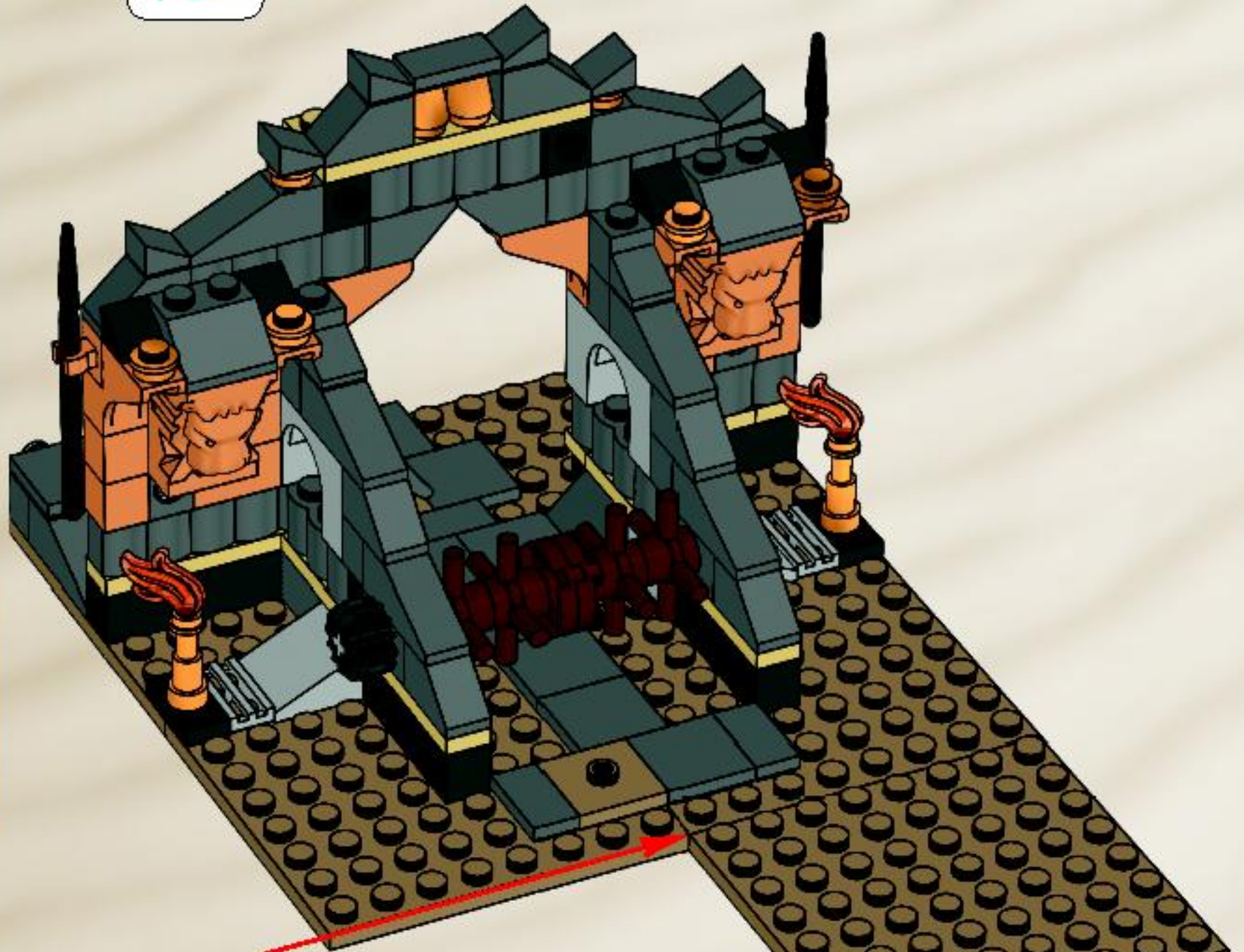

34



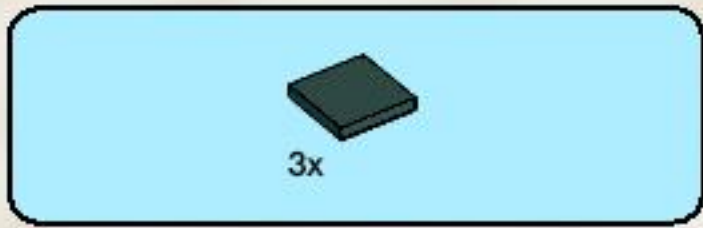

35



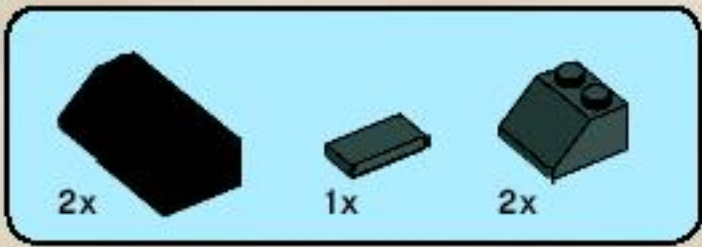

36

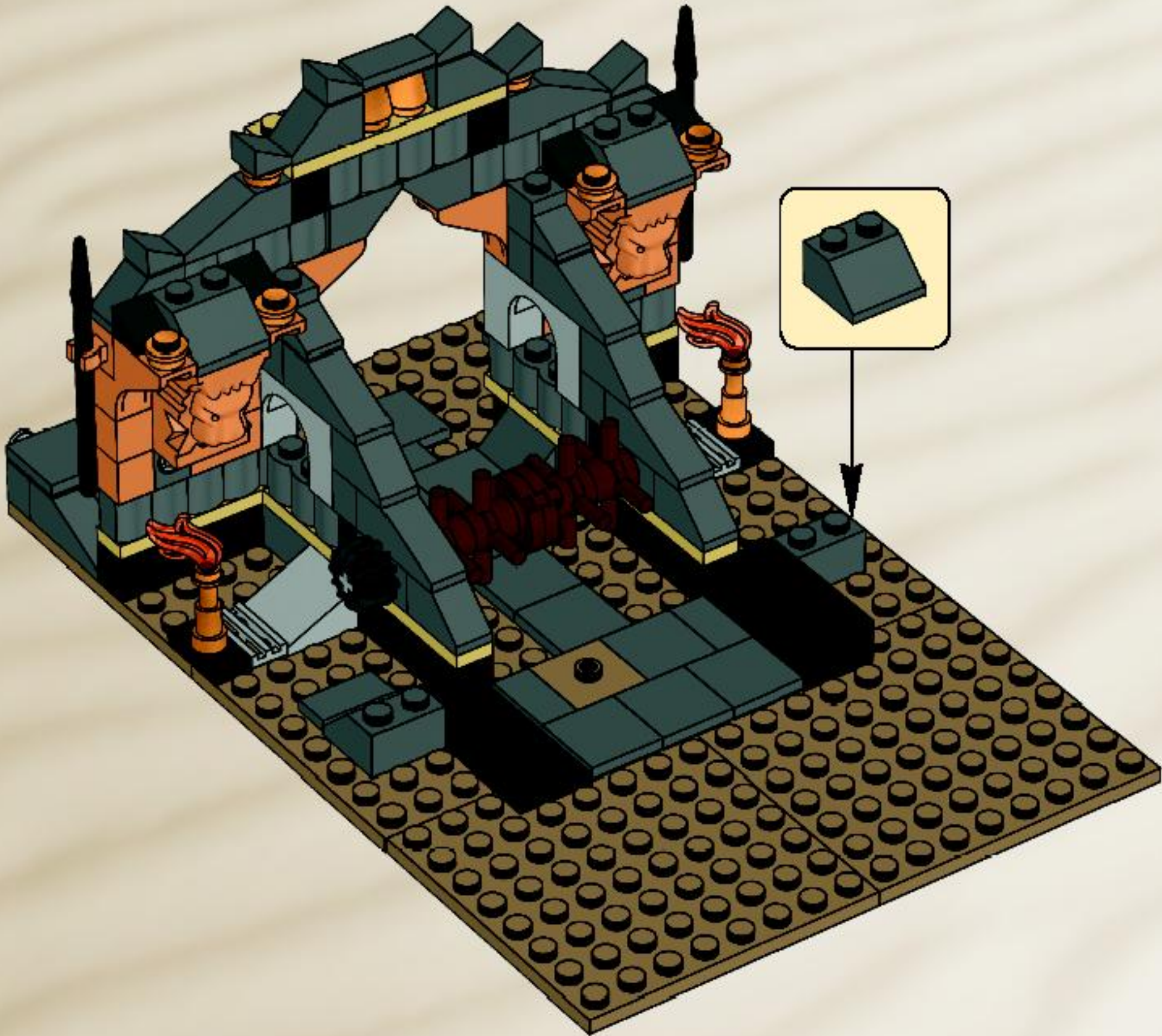



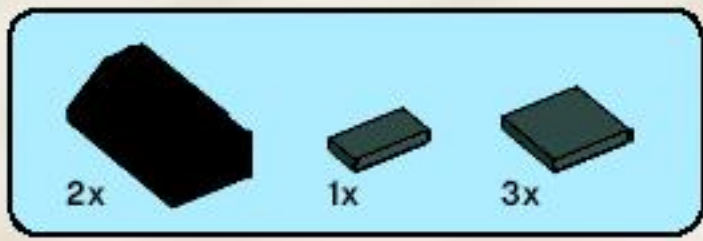

37

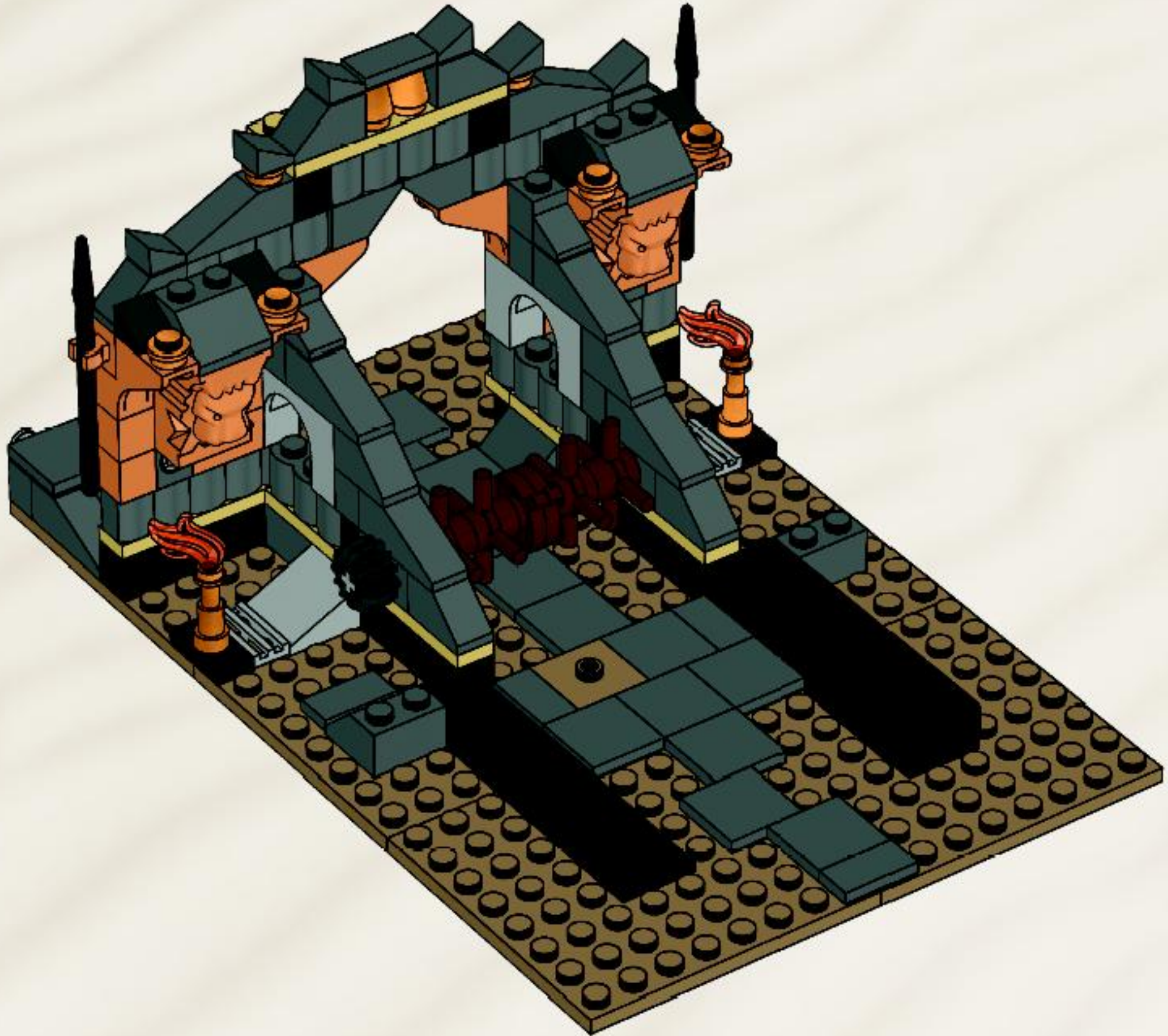

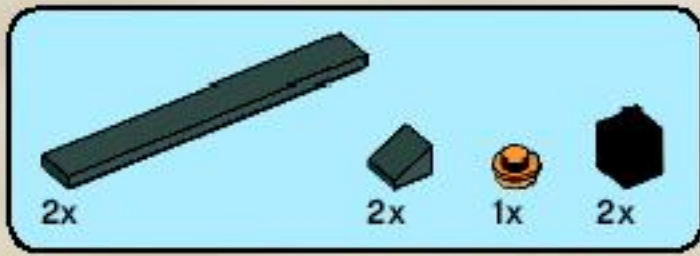

38

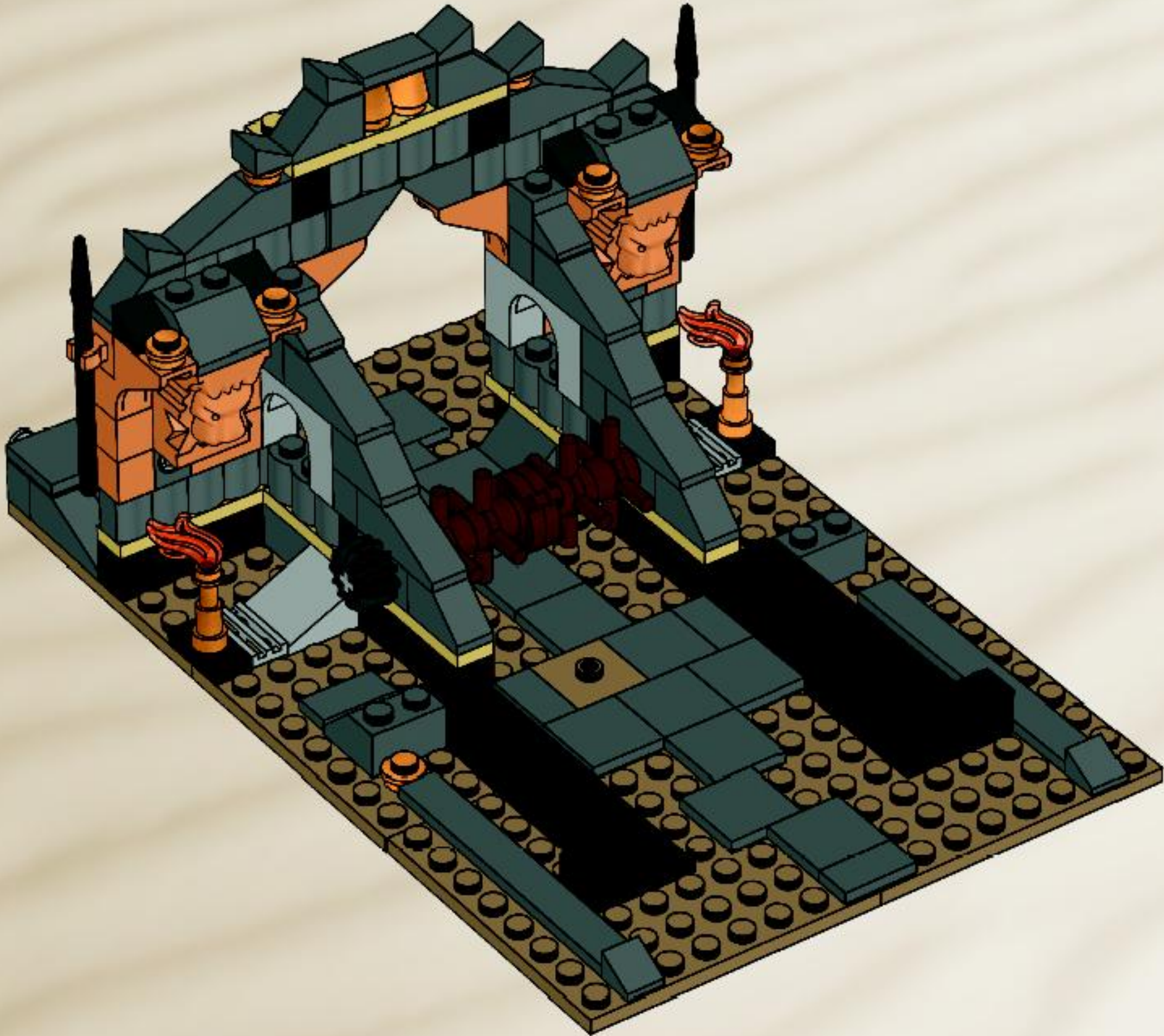

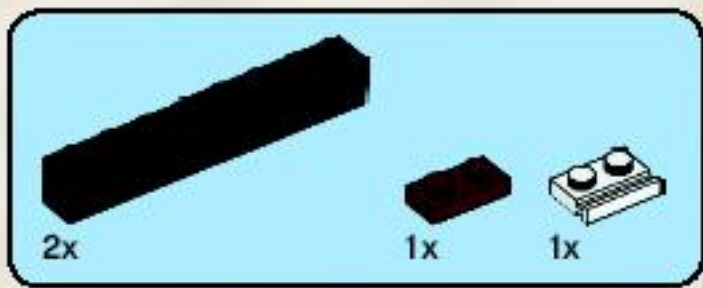

39

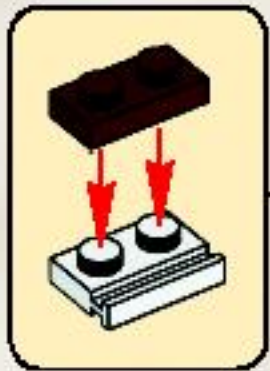
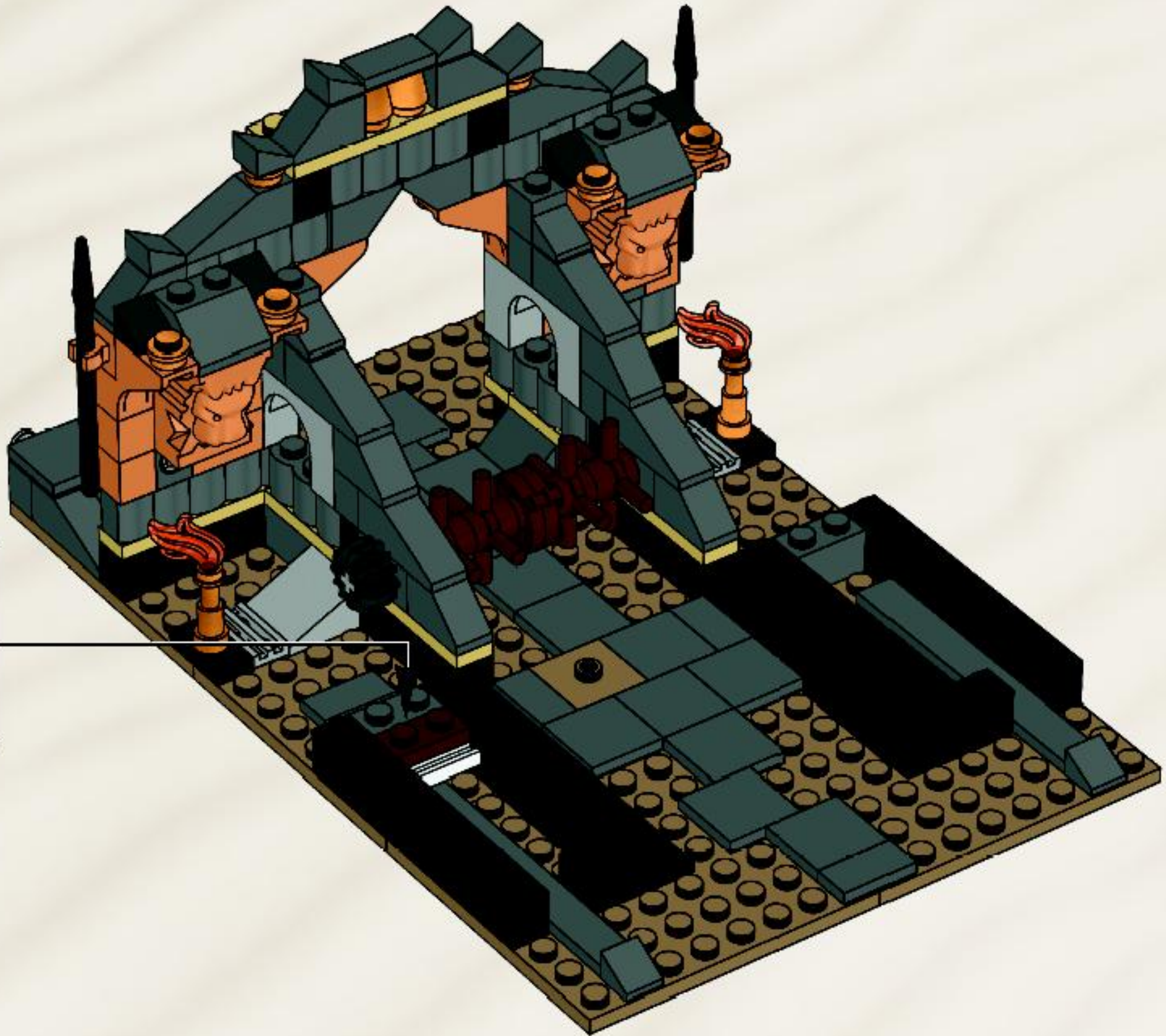

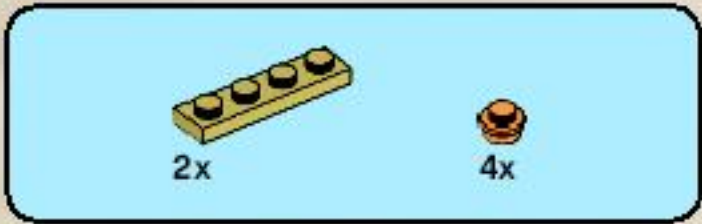

40

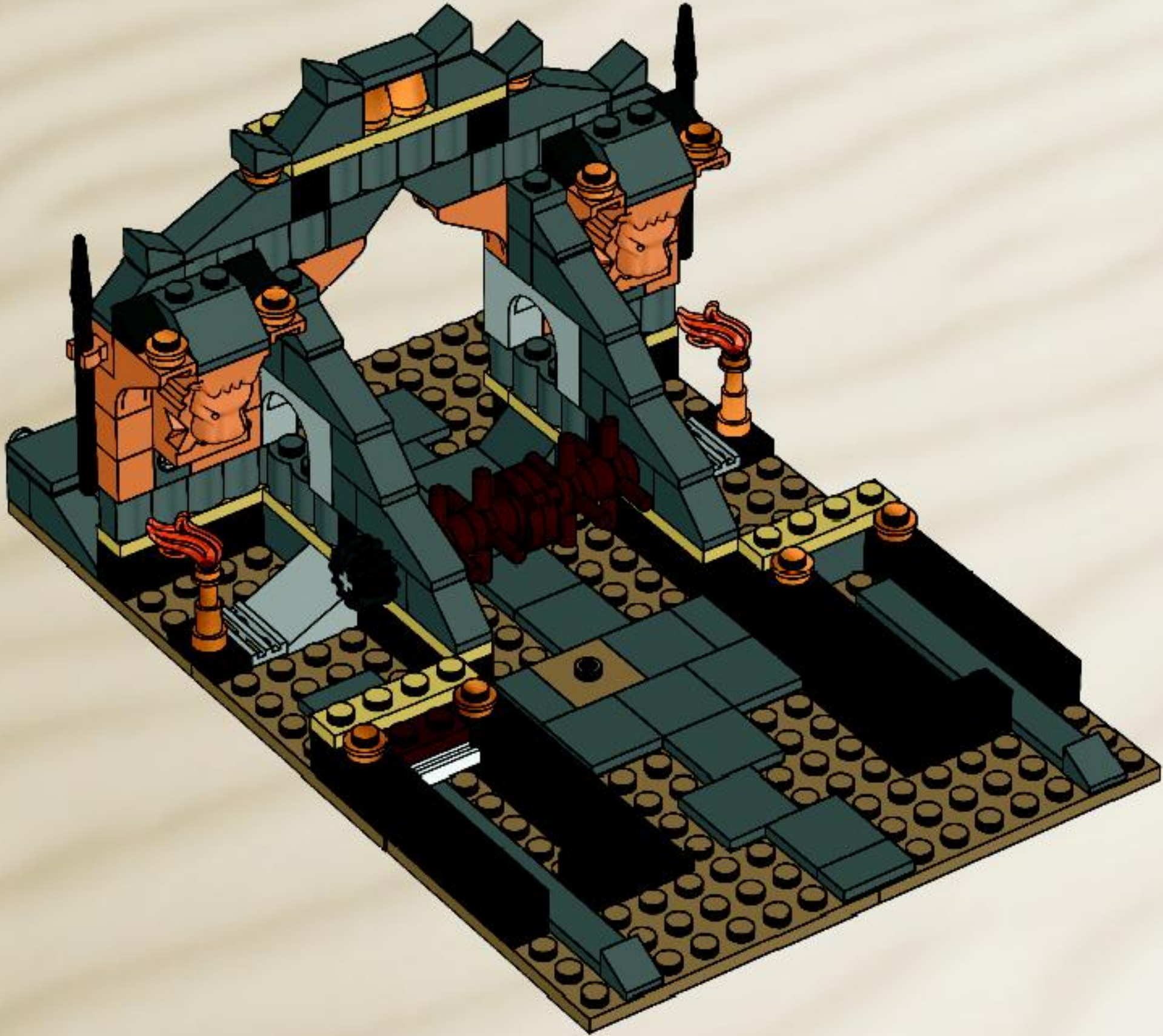

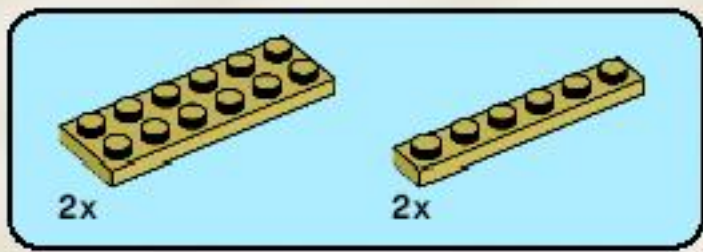

41

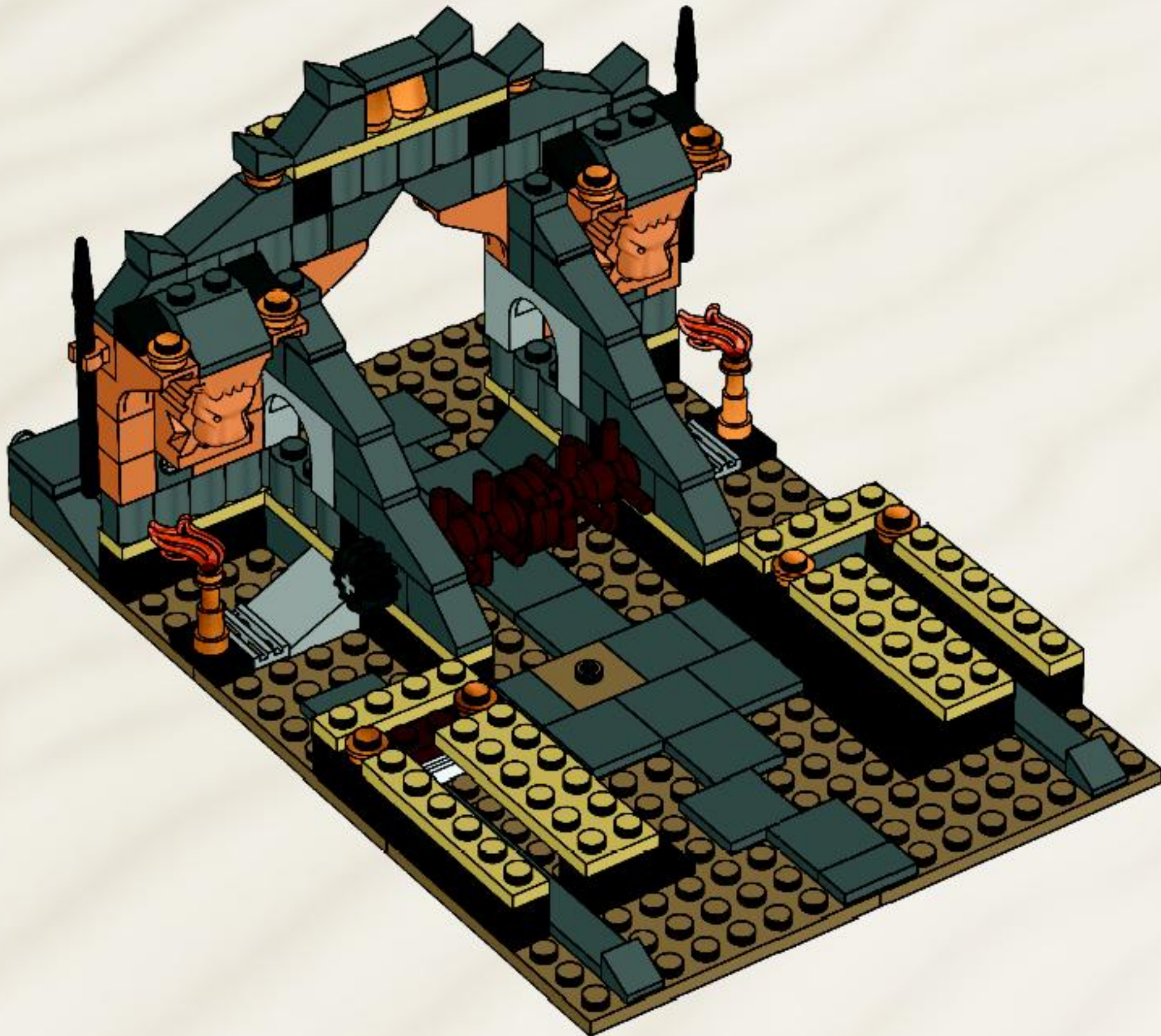

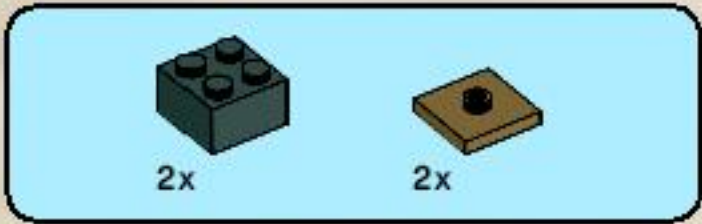

42

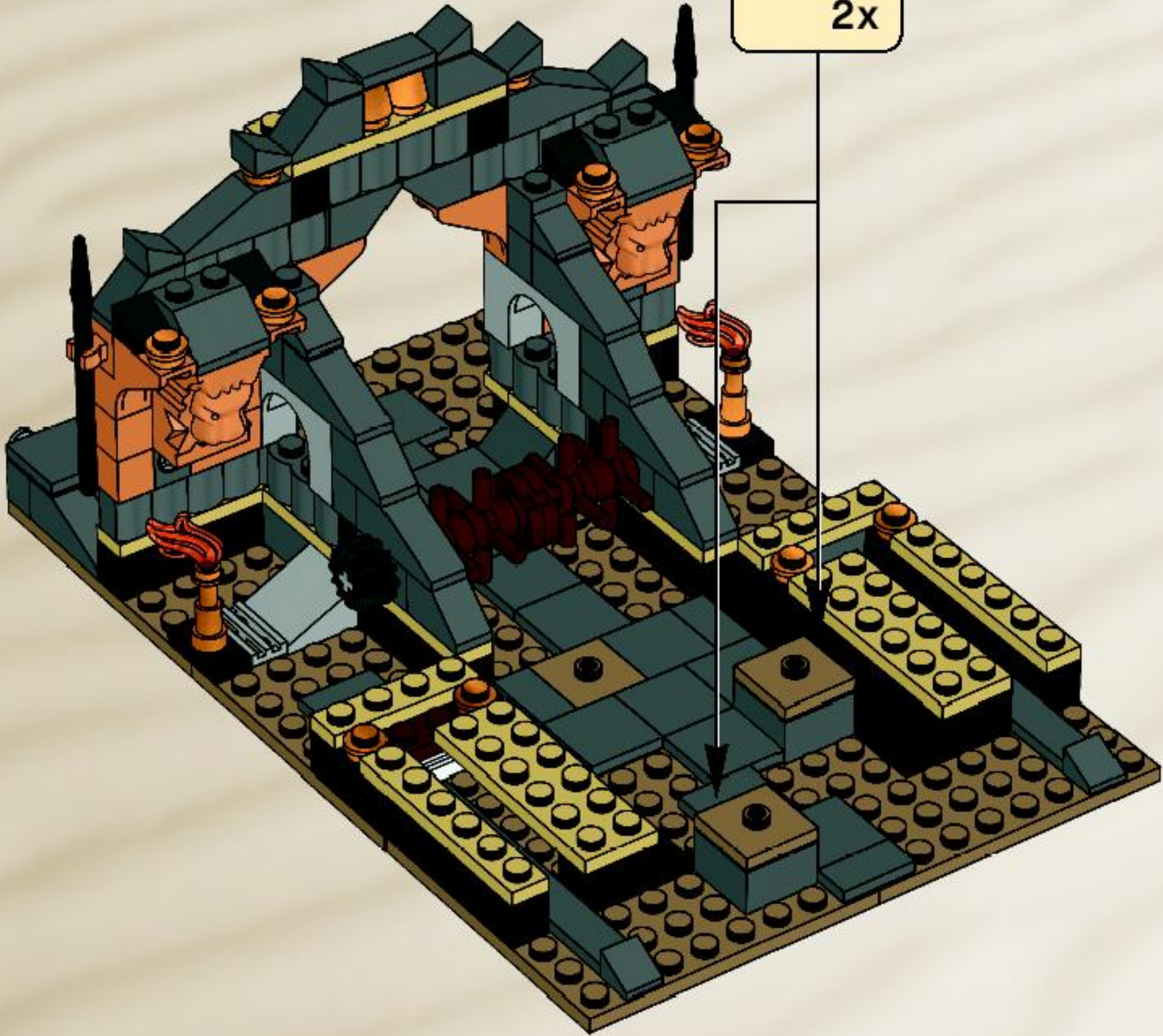
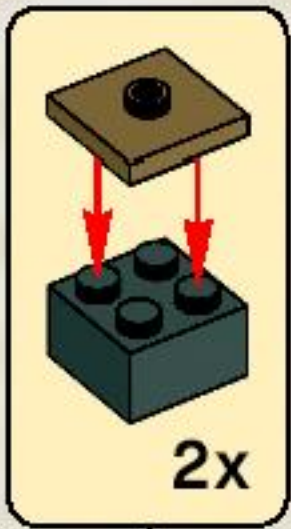

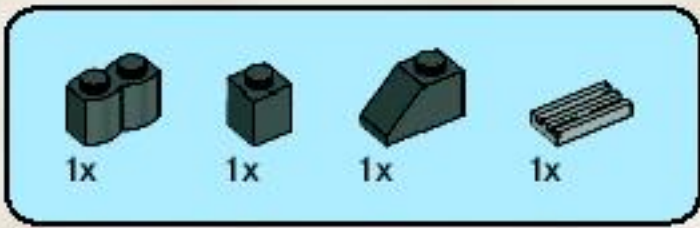

43

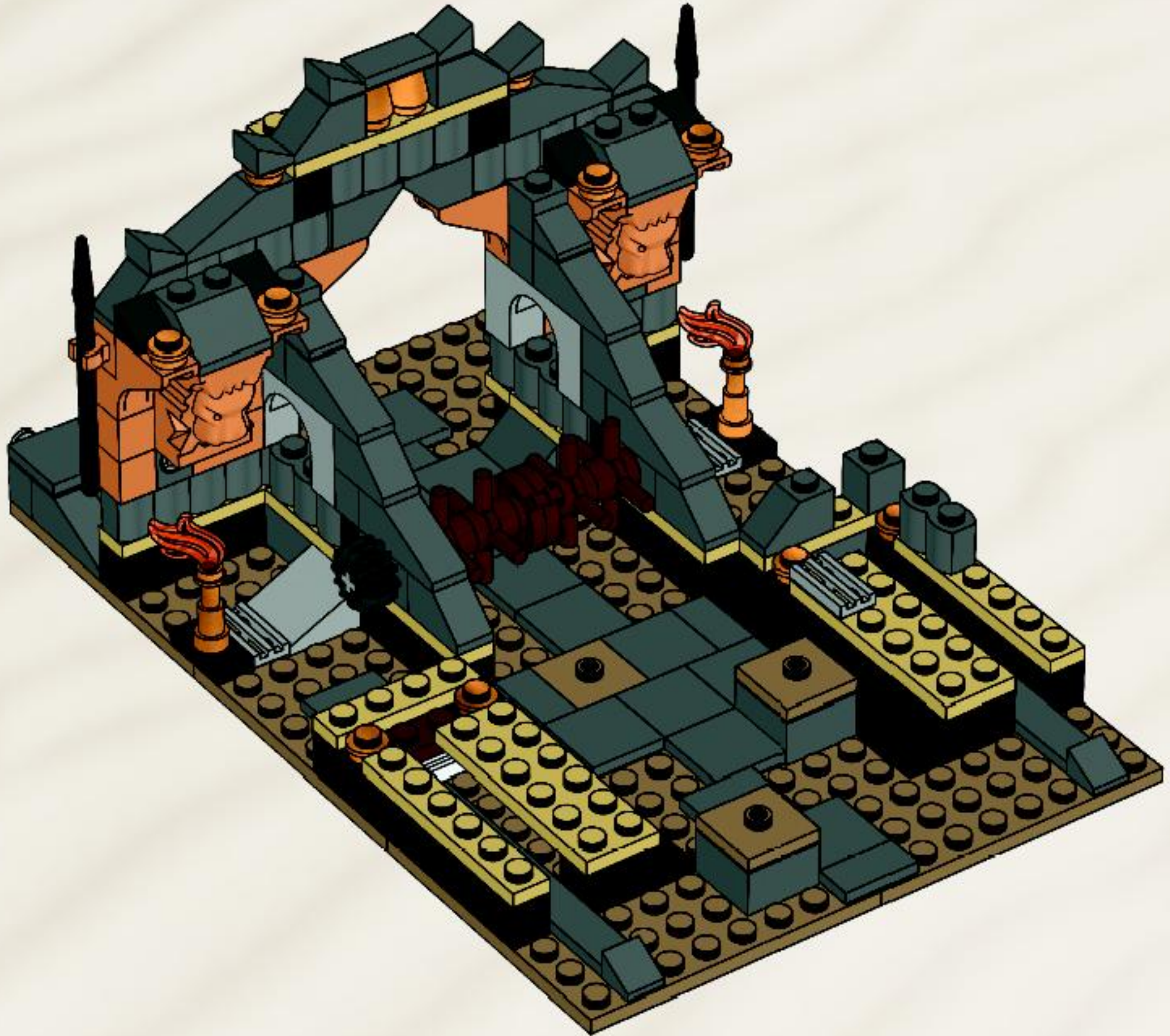

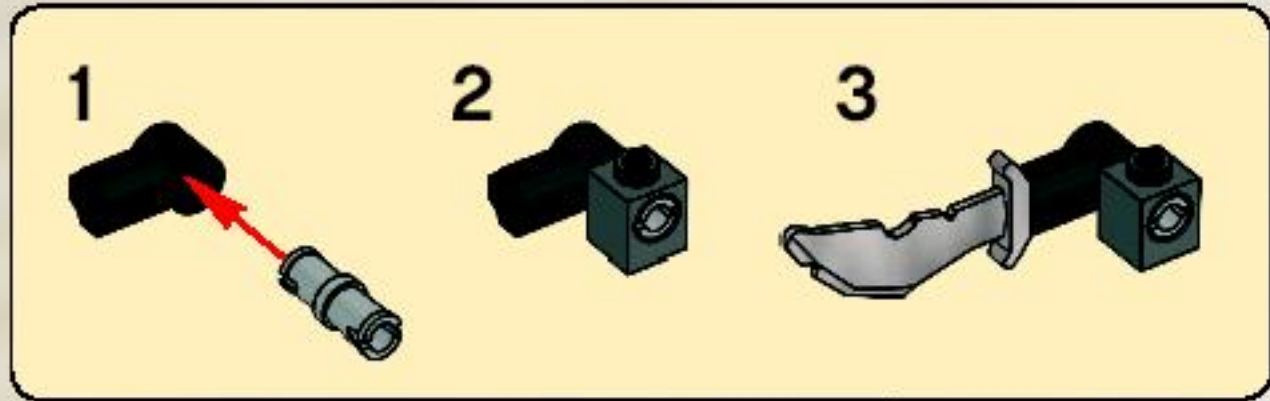
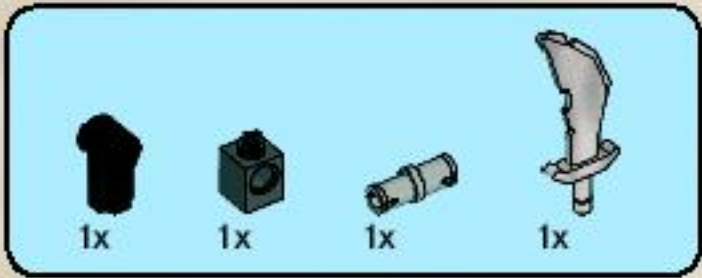

44

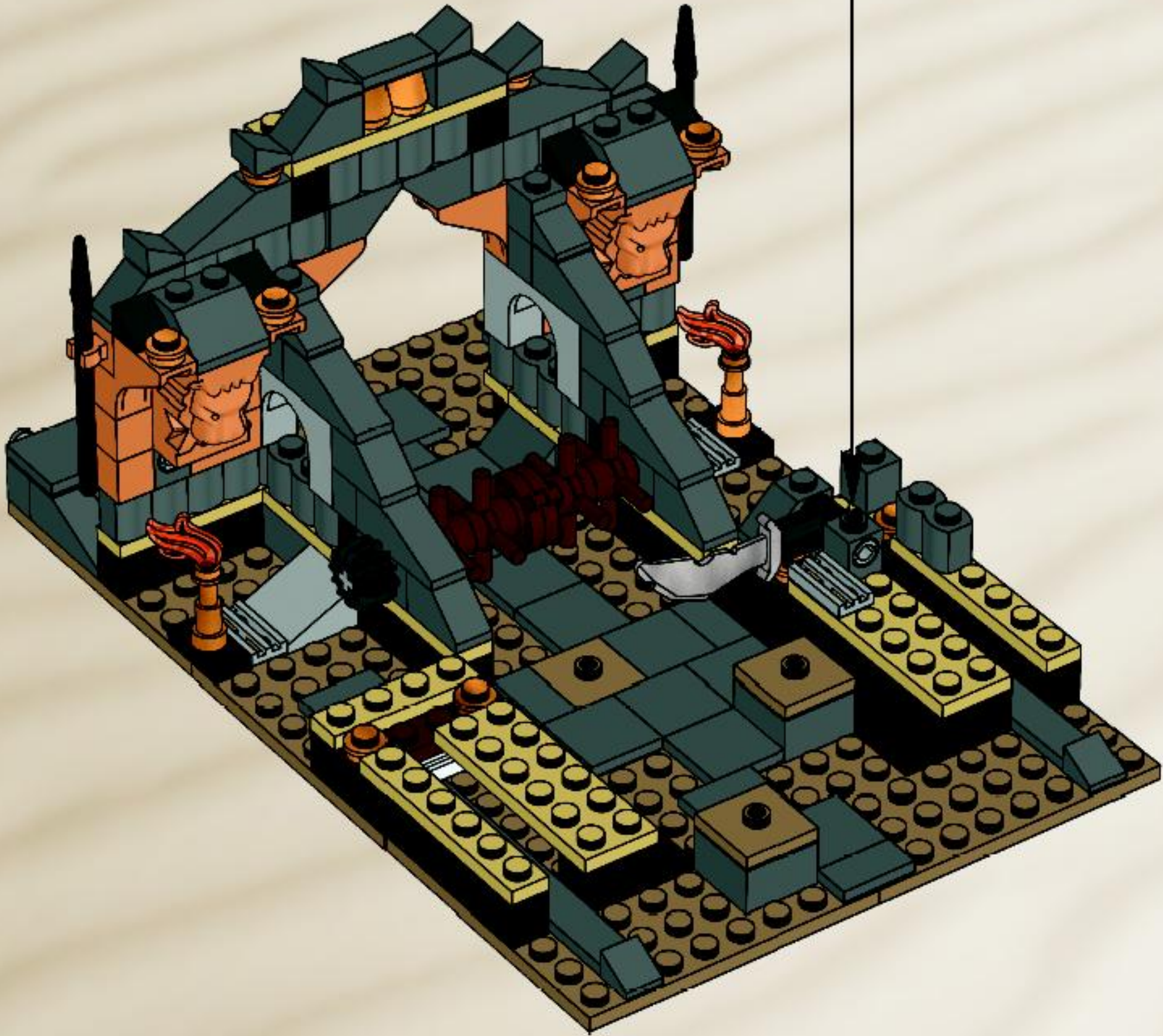



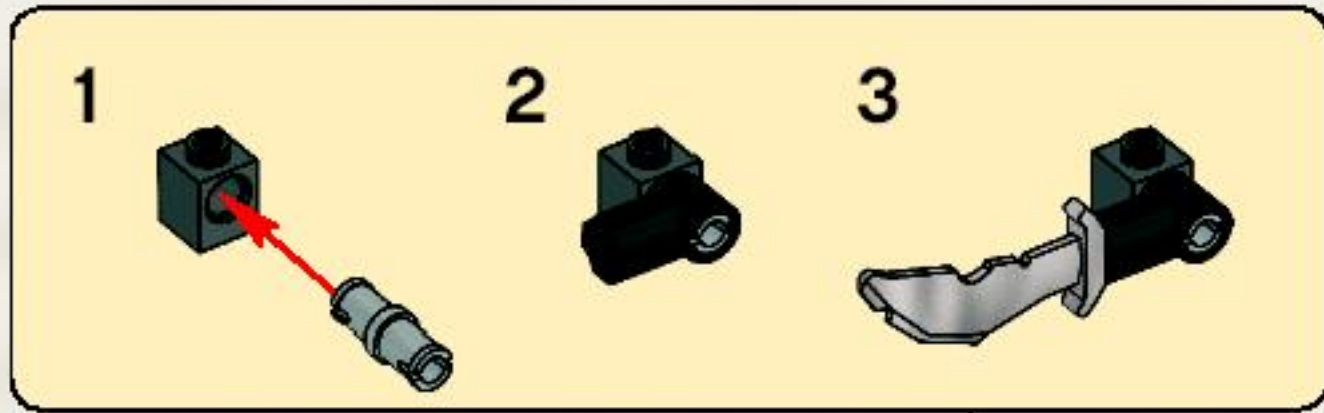
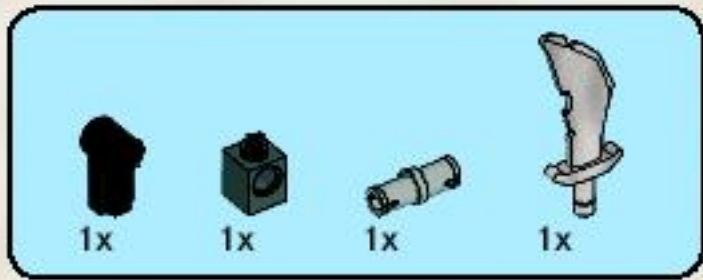

45

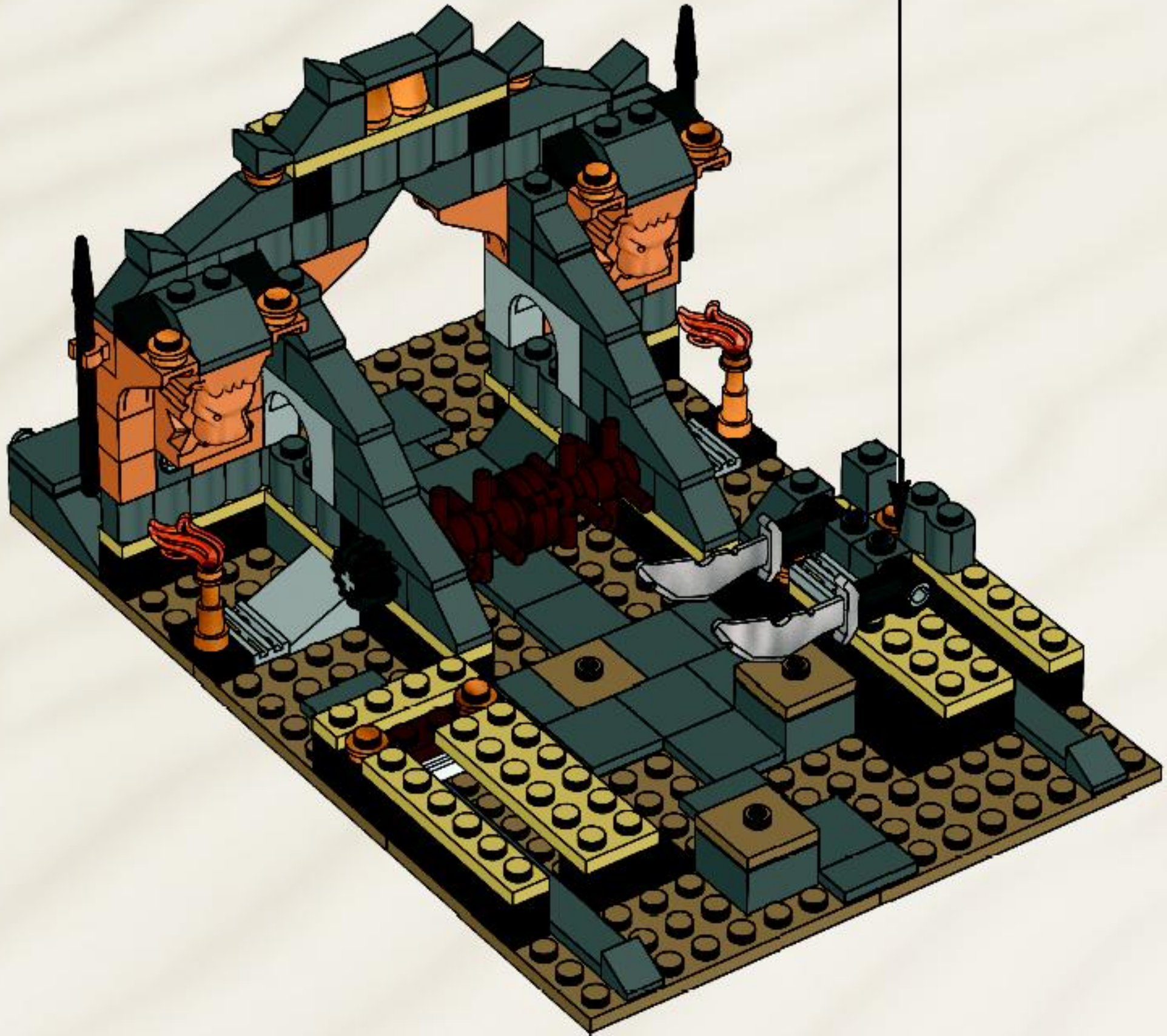

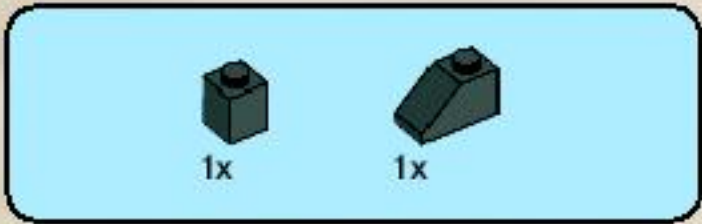

46

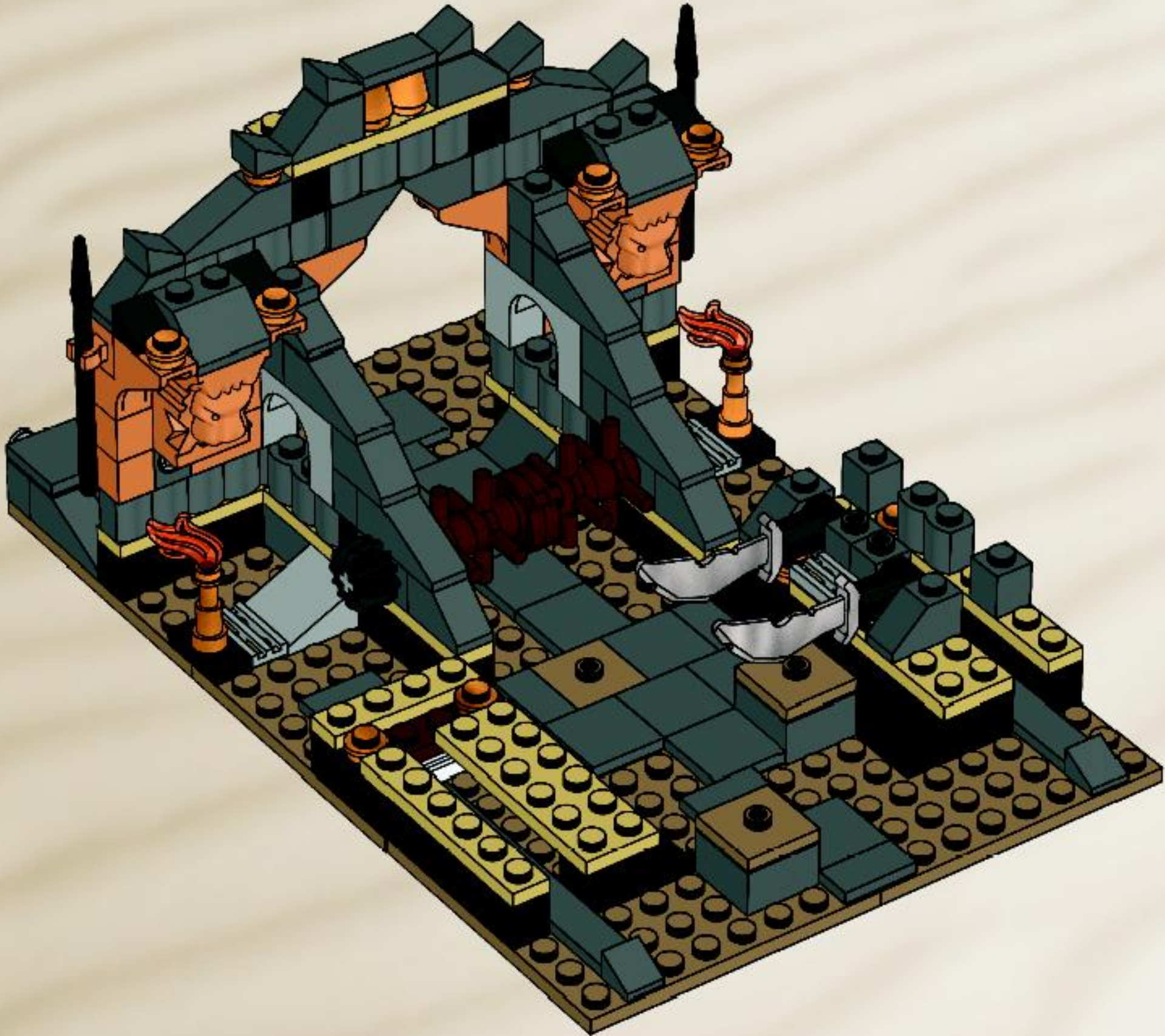

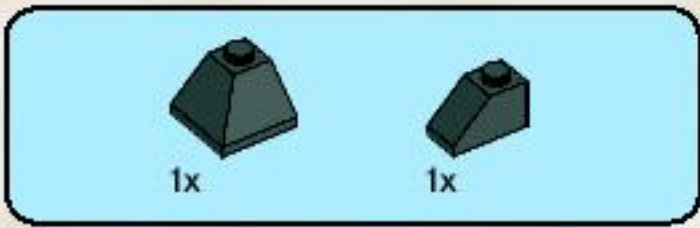

47

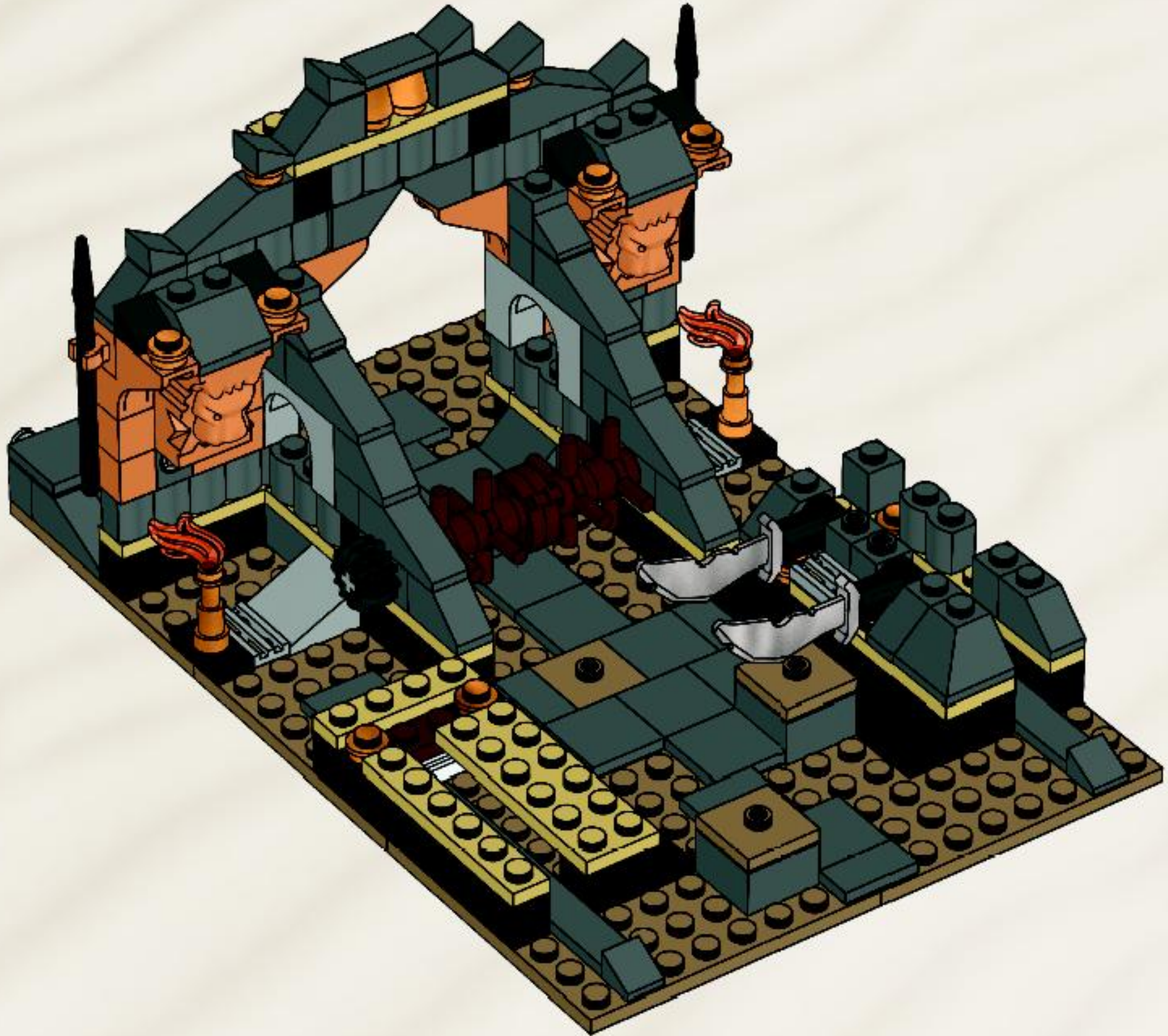

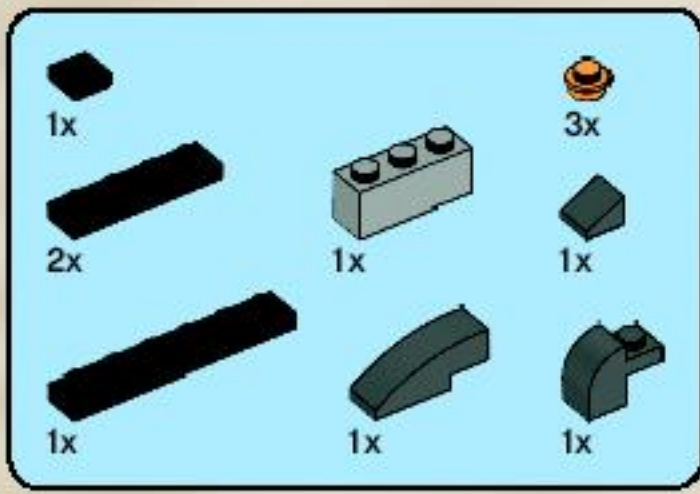

48

1



2

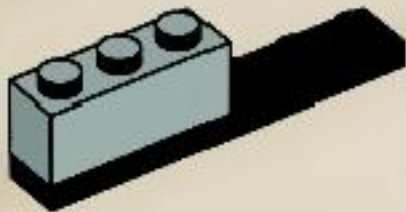

3



4



5

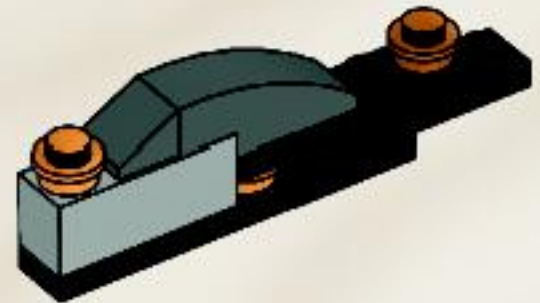

6

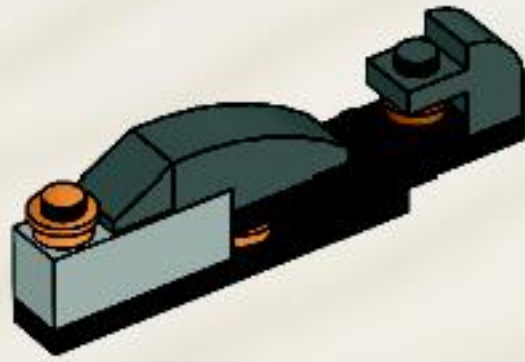

7

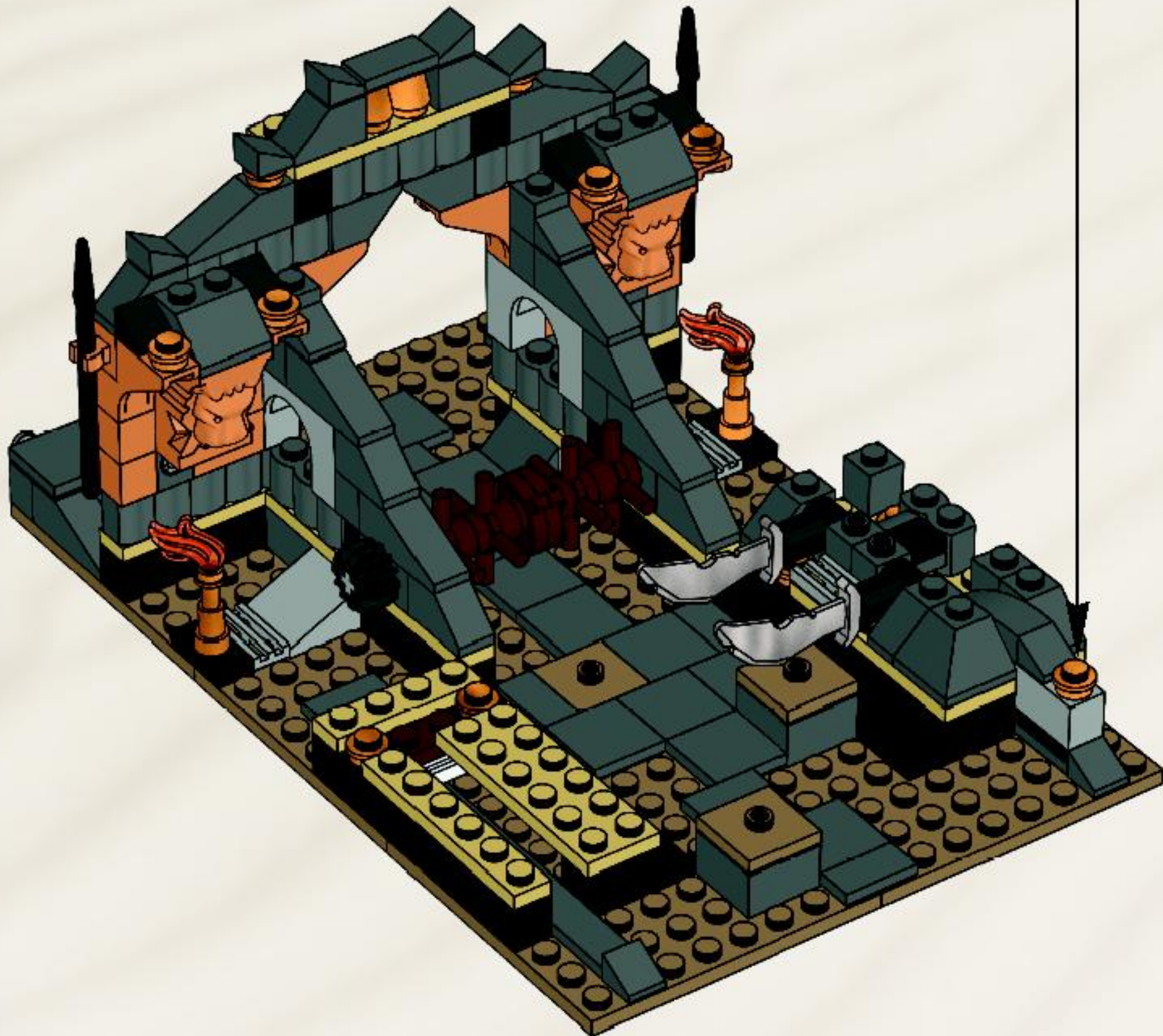
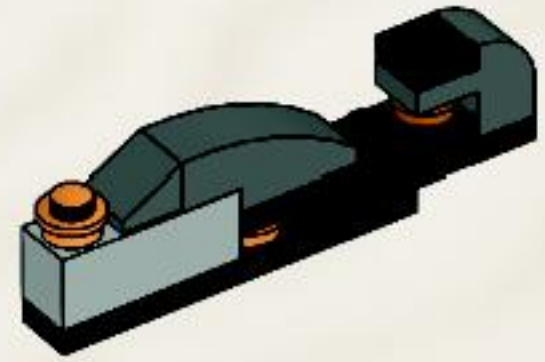

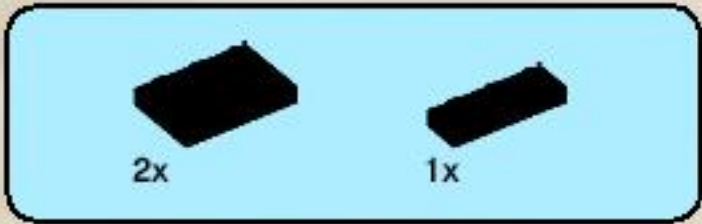

49

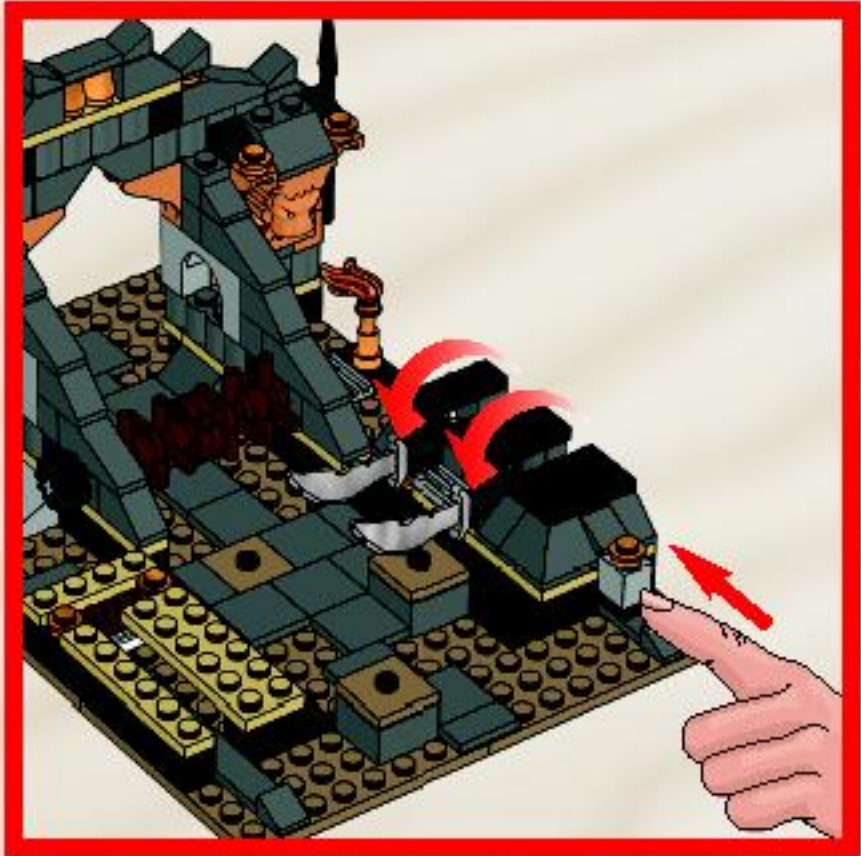
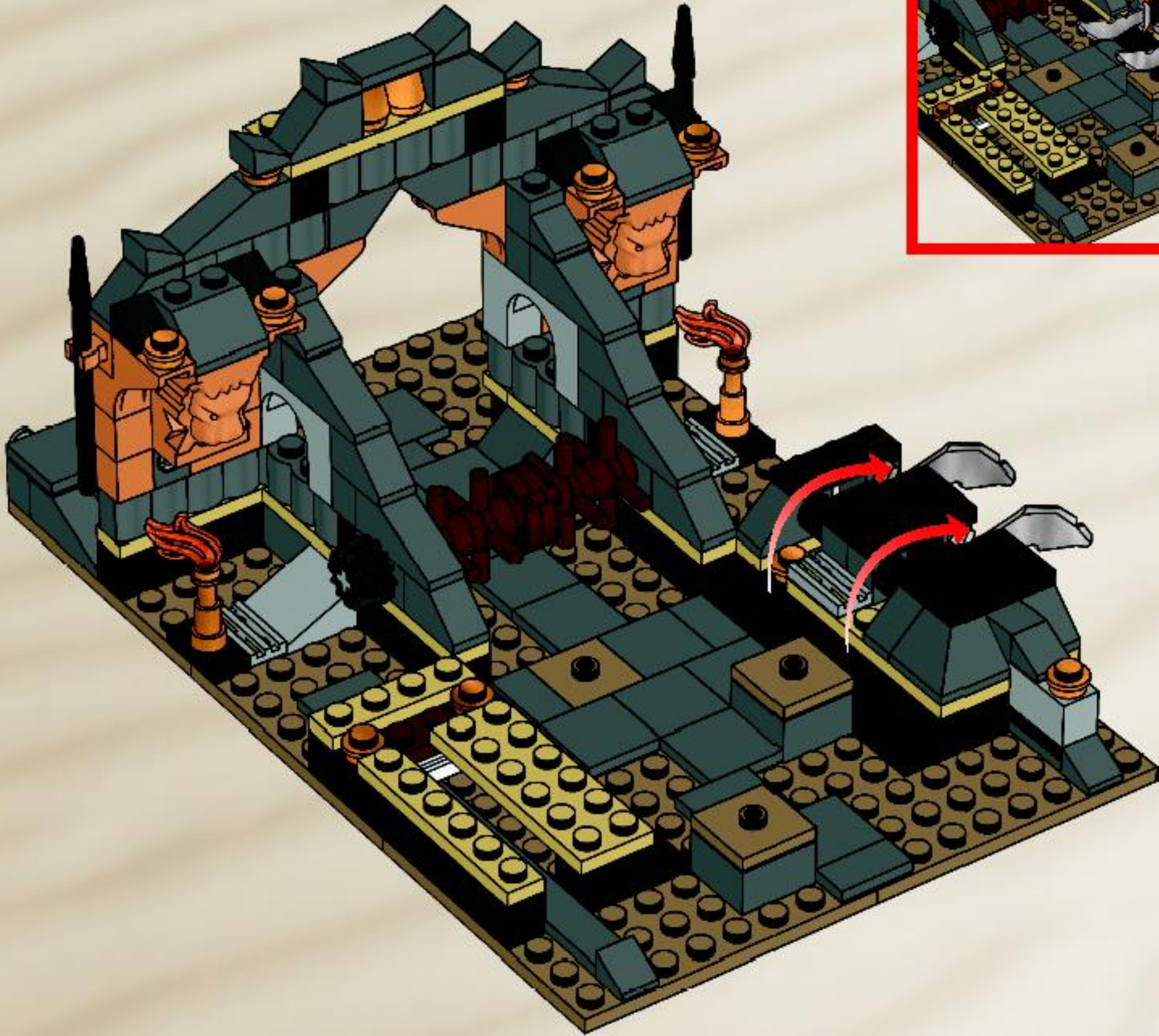

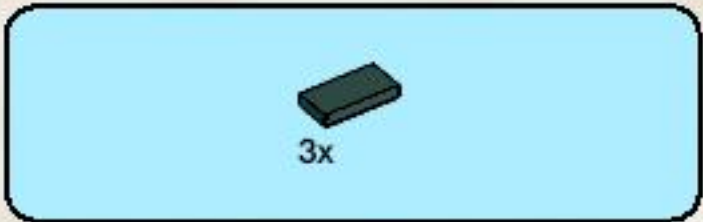

50

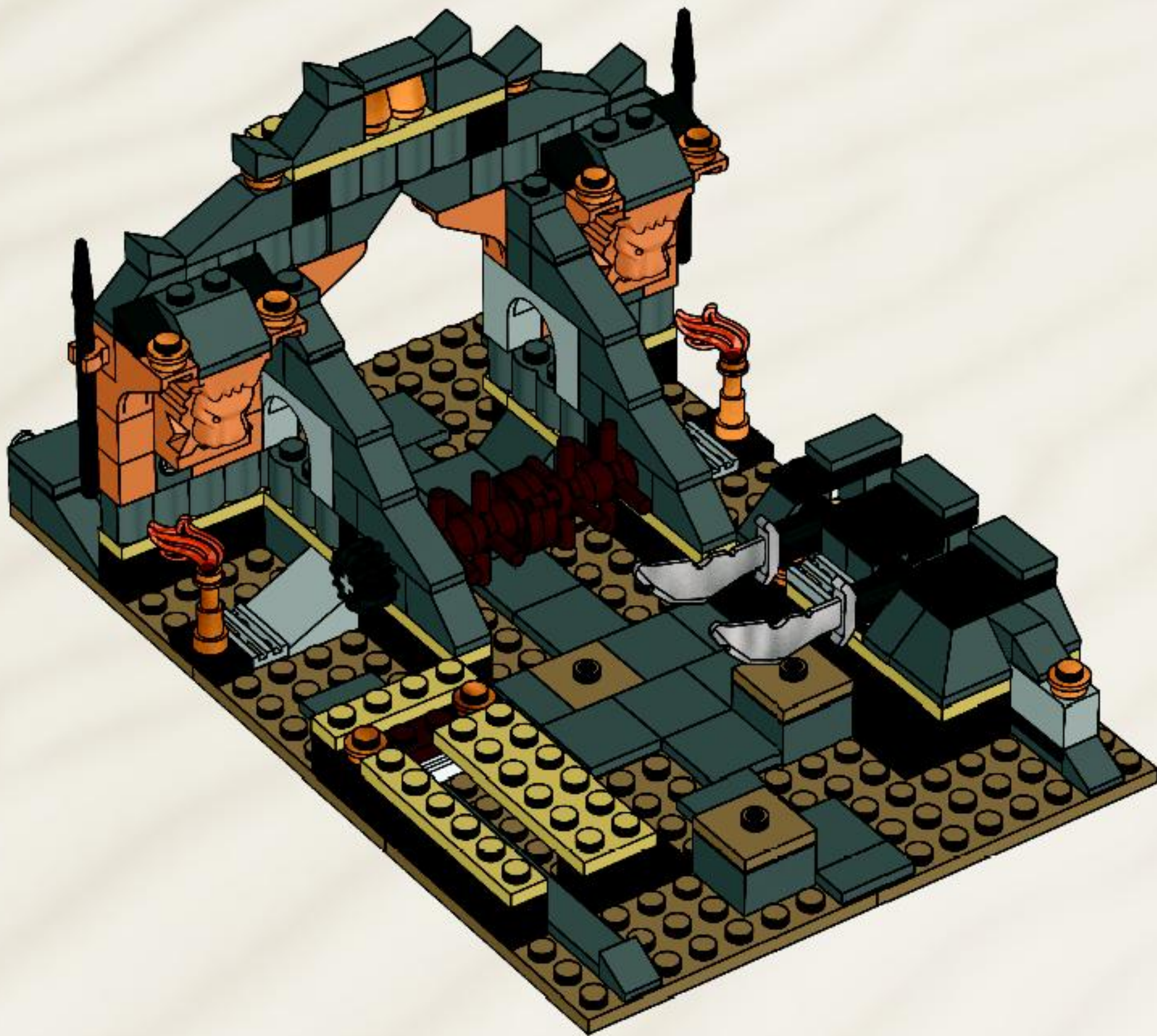

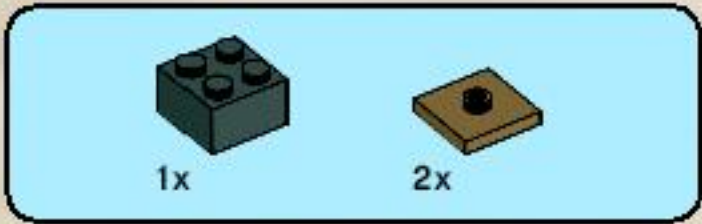

51

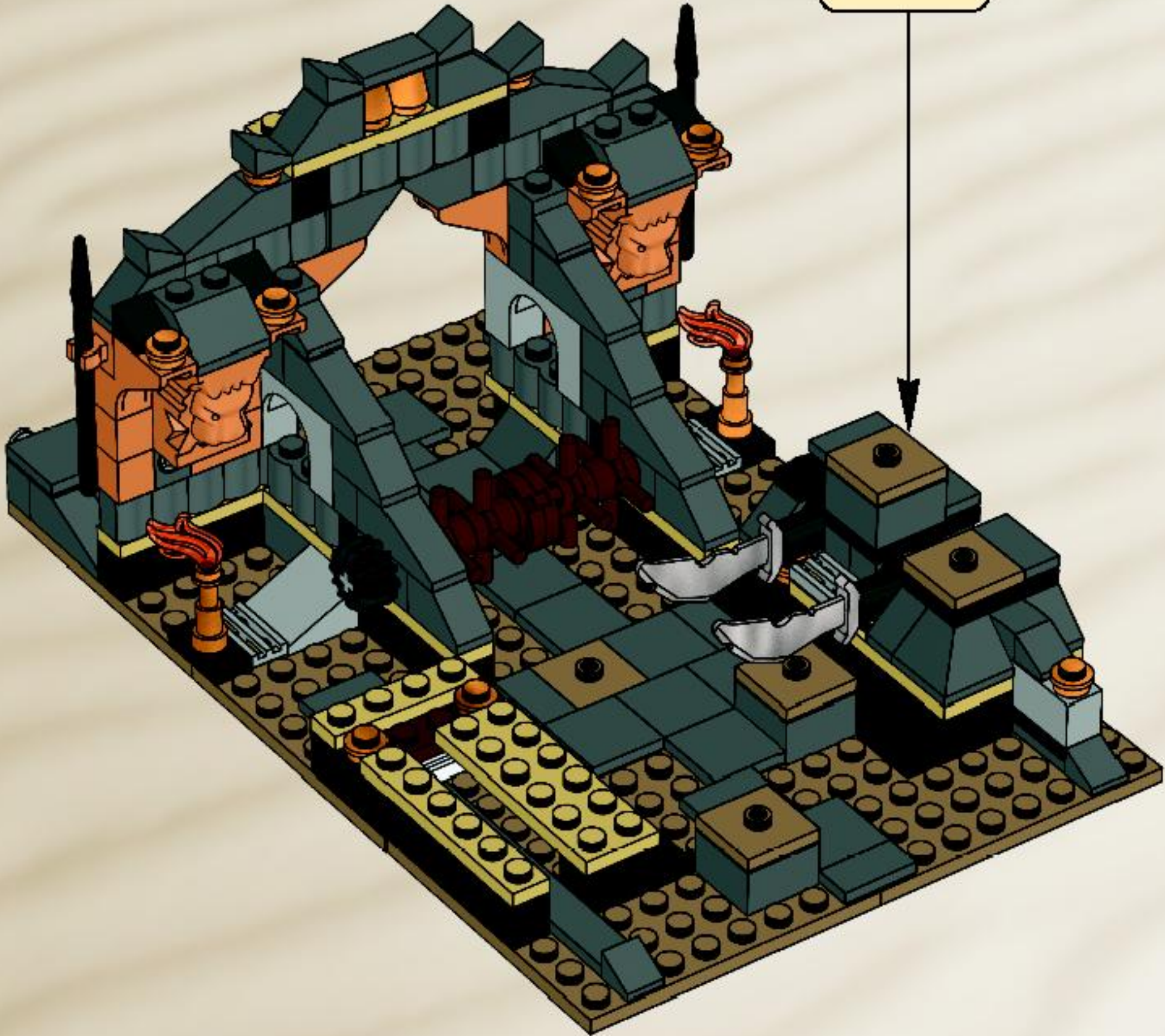
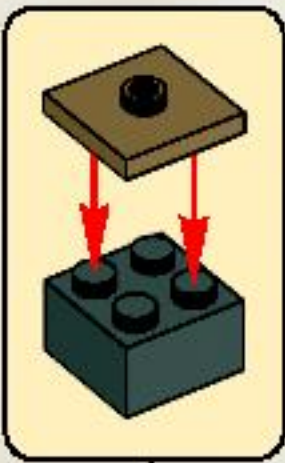



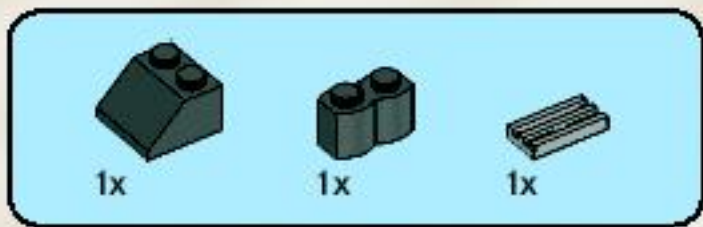

52



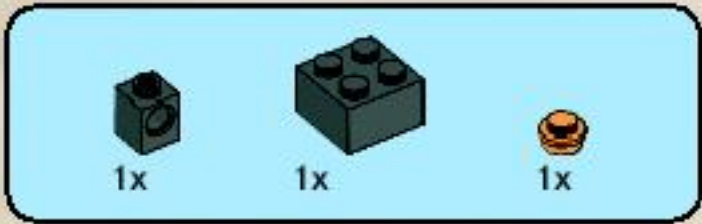

53



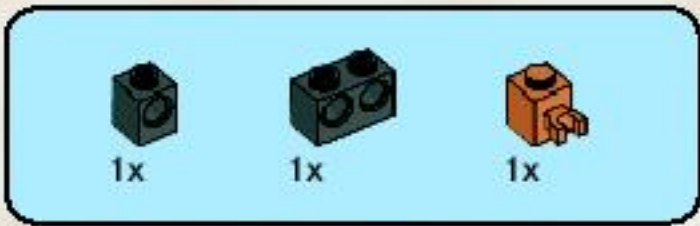

54



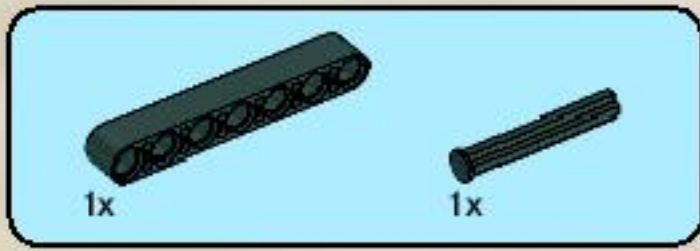

55



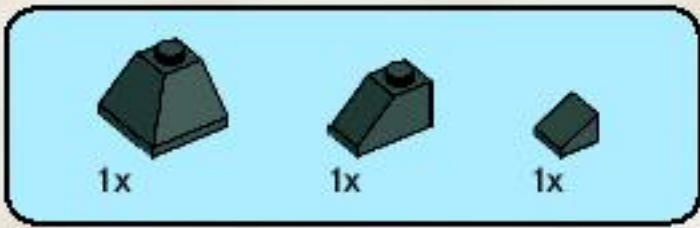

56



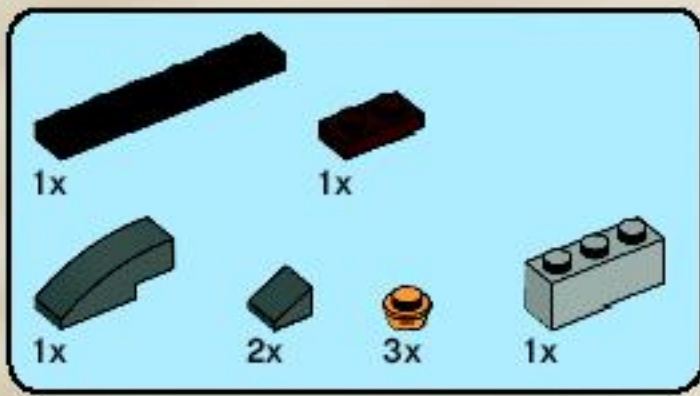

57

1



2

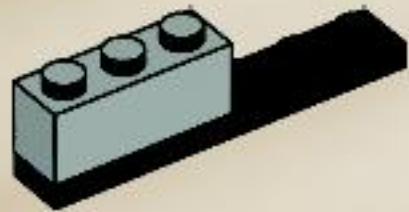

3

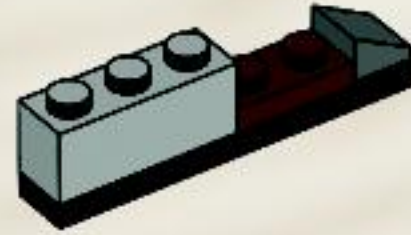

4



5



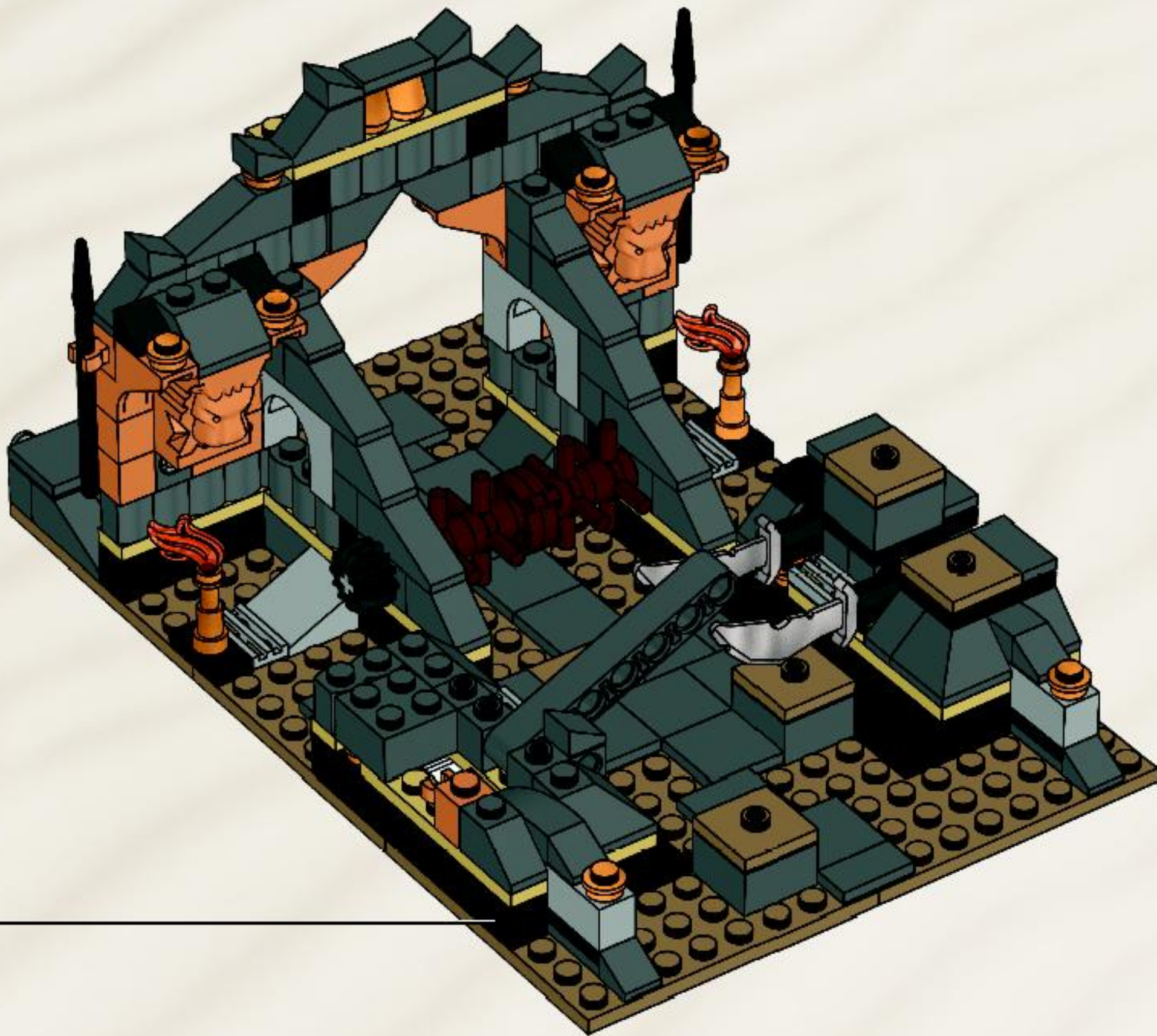

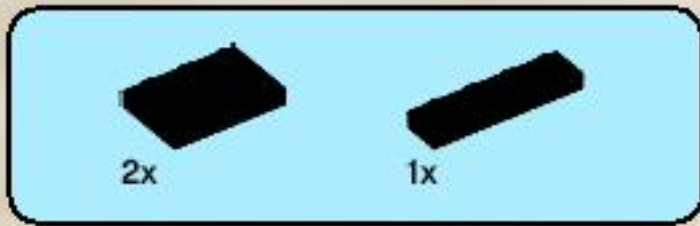

58





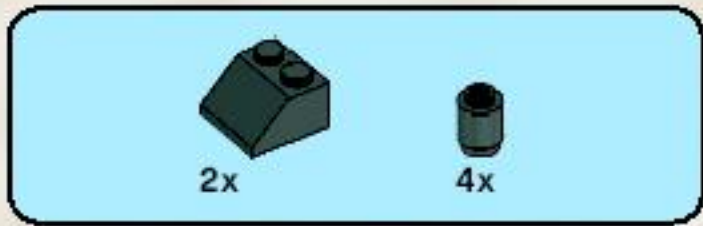

59





60

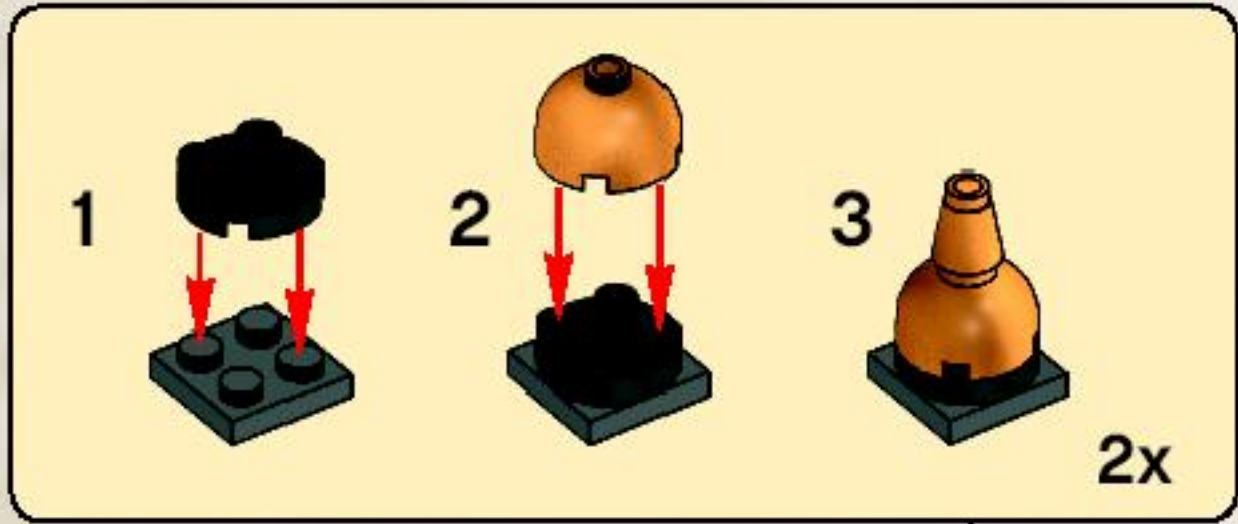

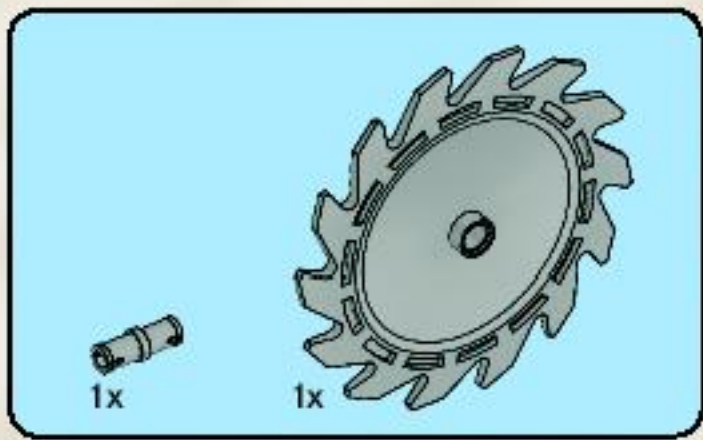

61

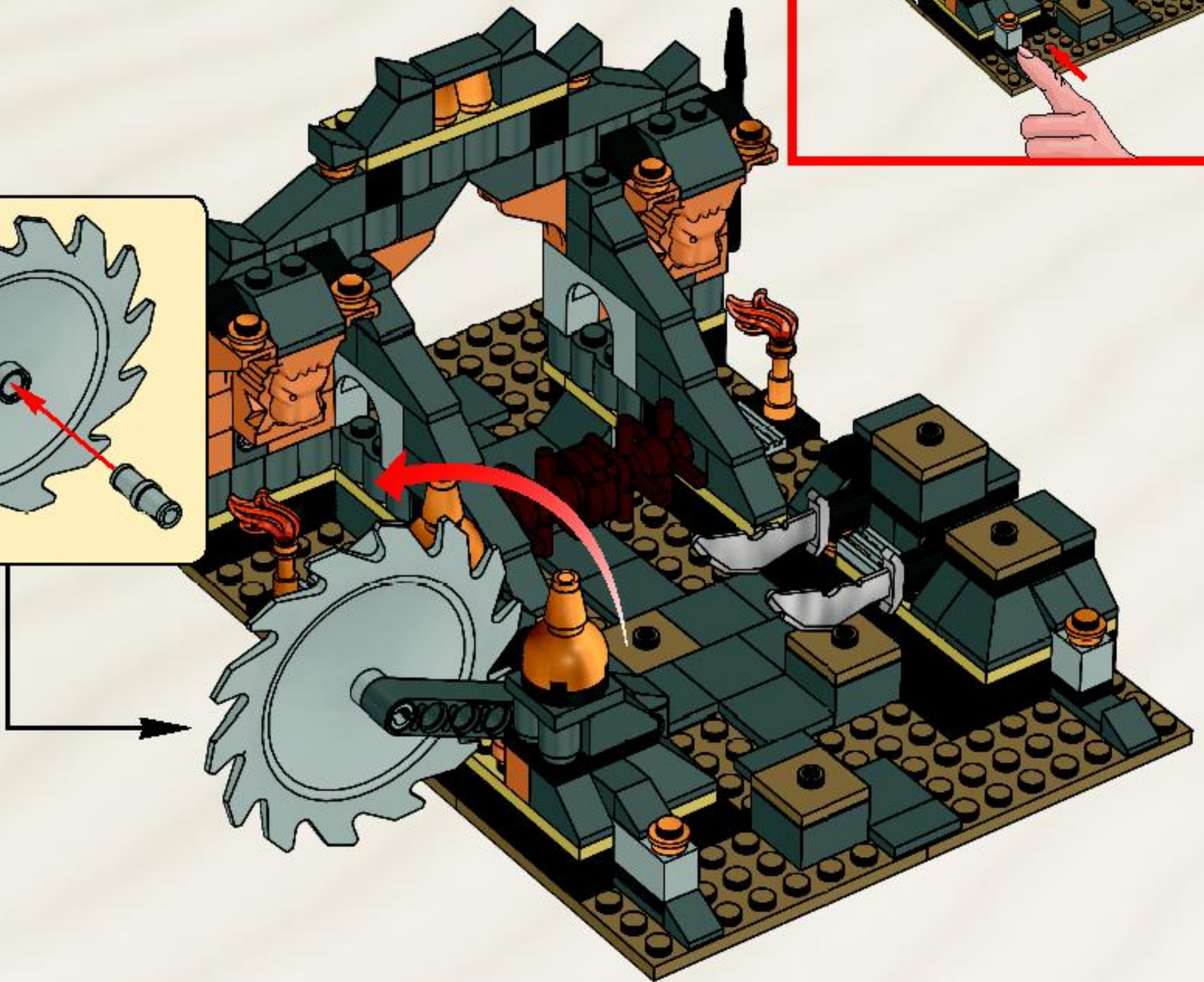
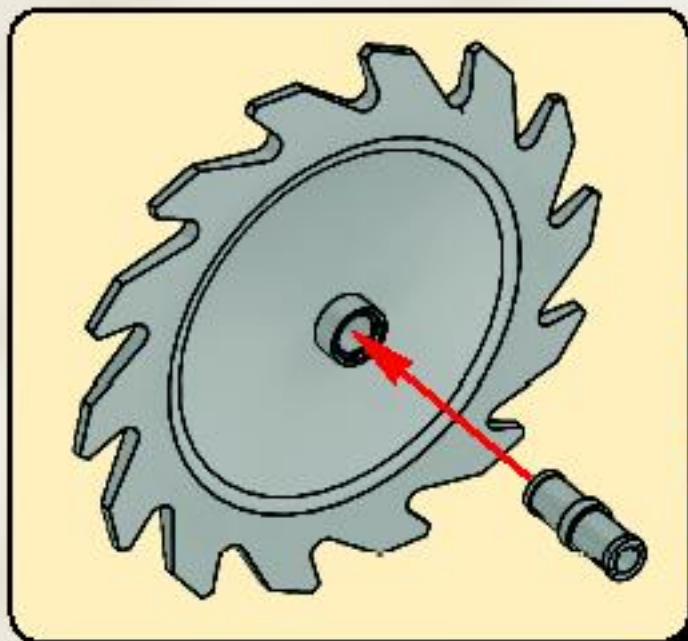

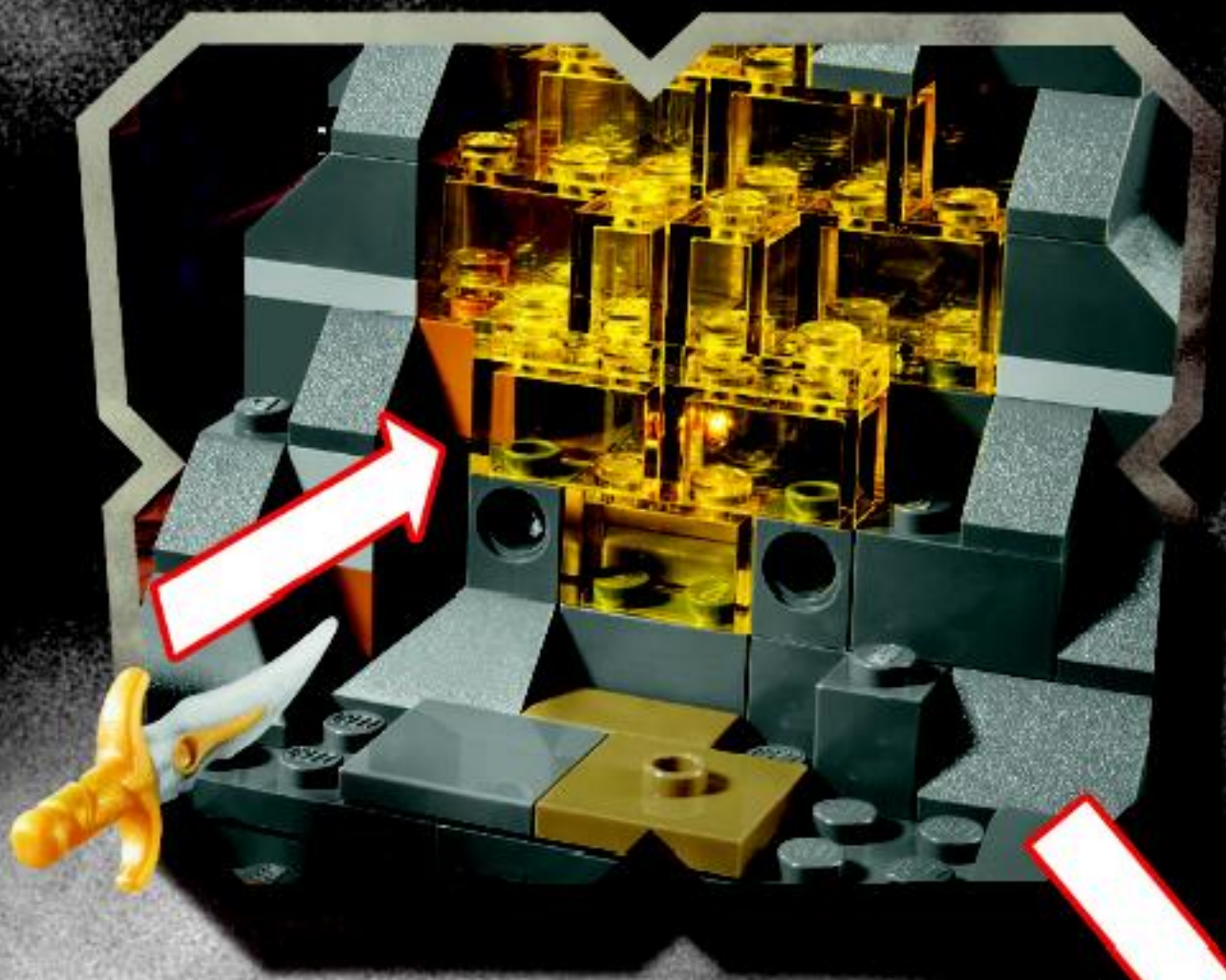





- |  |   |  |  |  |
|--|---|--|--|--|
| <br>9x<br>4211088     | <br>4x<br>4211111     | <br>3x<br>4211043    | <br>4x<br>4529247    | <br>15x<br>4569382   |
| <br>6x<br>4211075    | <br>1x<br>4210762    | <br>3x<br>4211065   | <br>2x<br>4569316   | <br>5x<br>4569385   |
| <br>6x<br>4211060    | <br>32x<br>4504378   | <br>3x<br>4211065   | <br>18x<br>4523159  | <br>6x<br>4568955   |
| <br>6x<br>4211060    | <br>3x<br>4211096    | <br>1x<br>4243831   | <br>2x<br>4538126   | <br>2x<br>4570156   |
| <br>10x<br>4211109   | <br>40x<br>4211135   | <br>2x<br>4211008   | <br>1x<br>4568950   | <br>13x<br>306544   |
| <br>3x<br>4211104    | <br>6x<br>4210646    | <br>1x<br>4211061   | <br>1x<br>4529672   | <br>1x<br>3006844   |
| <br>9x<br>4211105   | <br>13x<br>4211054  | <br>1x<br>4210794  | <br>1x<br>4580101  | <br>4x<br>4194746  |
| <br>4x<br>4211085  | <br>8x<br>4211045  | <br>2x<br>4513326 | <br>1x<br>4580118 | <br>1x<br>4568737 |
| <br>3x<br>4211100  | <br>1x<br>4210797  | <br>2x<br>4513326 | <br>1x<br>4581313 | <br>1x<br>4568730 |
| <br>2x<br>4211099  | <br>2x<br>4246896  | <br>3x<br>4210844 | <br>1x<br>4568934 | <br>1x<br>4568731 |
| <br>2x<br>4211095  | <br>4x<br>4210719  | <br>1x<br>4509194 | <br>1x<br>4521781 | <br>1x<br>4568735 |
| <br>7x<br>4268139  | <br>9x<br>4211052  | <br>1x<br>4495931 | <br>3x<br>4549898 |  |
| <br>4x<br>4211090  | <br>2x<br>4211094  | <br>1x<br>4560177 | <br>1x<br>4568952 |  |
| <br>12x<br>4210639 | <br>20x<br>4211055 |  |  |  |



Customer Service  
Kundenservice  
Service Consommateurs  
Servicio Al Consumidor

[www.lego.com/service](http://www.lego.com/service) or dial

: 00800 5346 5555  
: 1-800-422-5346







7573





Disney **PRINCE OF PERSIA**  
THE SANDS OF TIME



FREE! GRATIS! GRATUIT!



club  
MAGAZINE™

www.LEGOclub.com



00800 5346 5555\*        

  1-866-534-6258 • 1-877-518-5346

US & Canada only

Canada seulement



VISIT THE WORLD'S  
BIGGEST LEGO® SHOP!

[www.LEGOshop.com](http://www.LEGOshop.com)

\* Freephone. Mobile charges may apply. \* Numéro sans Frais. Les Frais peuvent s'appliquer avec les téléphones cellulaires. \* Gebührenfrei. Kosten für Anrufe aus Mobilfunknetzen können abweichen.  
\* gratis telefonnummer vanaf vaste lijn. \* Telefoon gratis nummer, ná de ringer-Pro Postbetaal. \* Det är gratis, när du ringer från en Postbetaal.



# WIN!

Go to [www.nielsen.com/LEGO](http://www.nielsen.com/LEGO) to fill out a survey for a chance to win a cool LEGO® Product.

No purchase necessary.

Open to all residents where not prohibited.



## [www.nielsen.com/LEGO](http://www.nielsen.com/LEGO)

### GEWINNE! WIN!

Nimm an der Umfrage auf [www.nielsen.com/LEGO](http://www.nielsen.com/LEGO) teil und hab die Chance ein cooles LEGO® Produkt zu gewinnen!

Die Teilnahme am Gewinnspiel führt zu keinerlei Kaufverpflichtungen. Teilnahme in allen nicht ausgeschlossenen Ländern möglich.

Ga naar [www.nielsen.com/LEGO](http://www.nielsen.com/LEGO), vul een enquêteformulier in en maak kans op een cool LEGO® product.

Geen aankoopverplichting. Iedereen mag deelnemen, uitgezonderd ingezetenden van landen waar een enquêteverbod geldt.

### GAGNE! 当てよう!

Visite [www.nielsen.com/LEGO](http://www.nielsen.com/LEGO) pour répondre à un questionnaire et avoir une chance de gagner un produit LEGO® très cool!

Aucune obligation d'achat. Ouvert à tous les résidents des pays autorisés.

[www.nielsen.com/LEGO](http://www.nielsen.com/LEGO)にアクセスして、アンケートにご記入ください。当選者にはレゴ®製品を差し上げます。

お買い上げの義務はありません。

禁止されていない限り、すべての皆様にご利用いただけます。