



SCOOBY-DOO!

75904





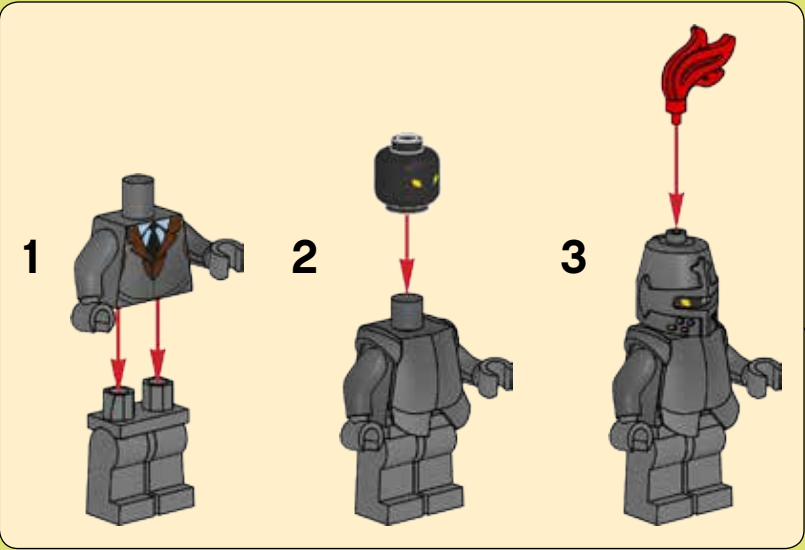
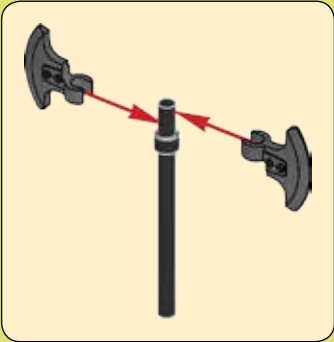
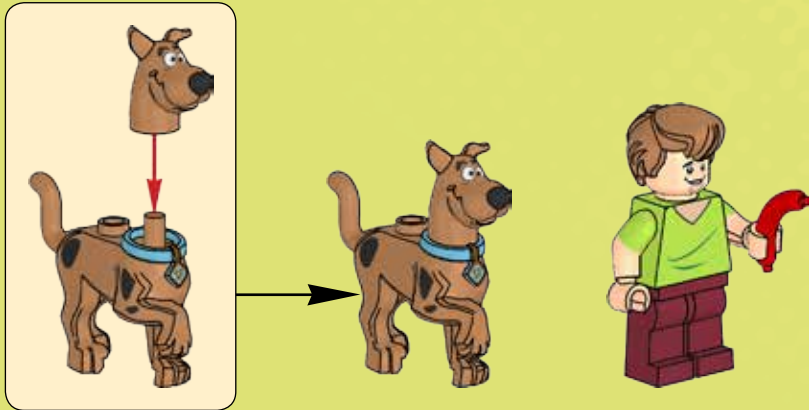

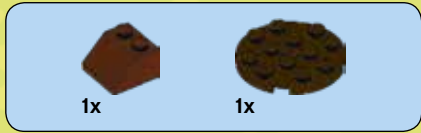

1

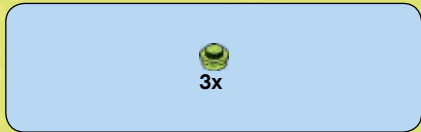

2



3





4



5

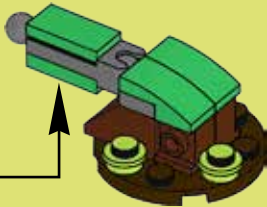
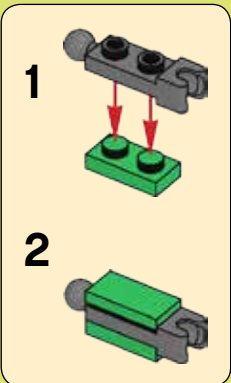

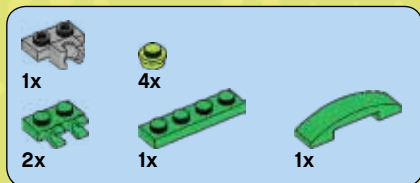

6

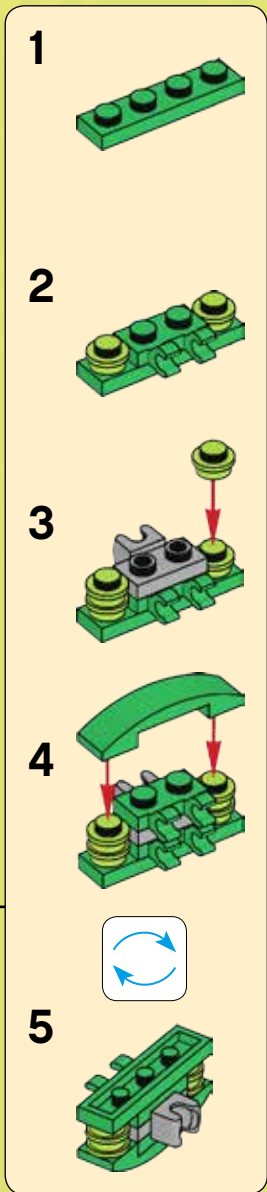
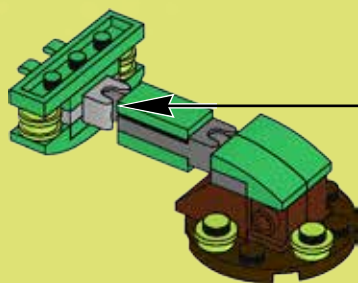

7





8

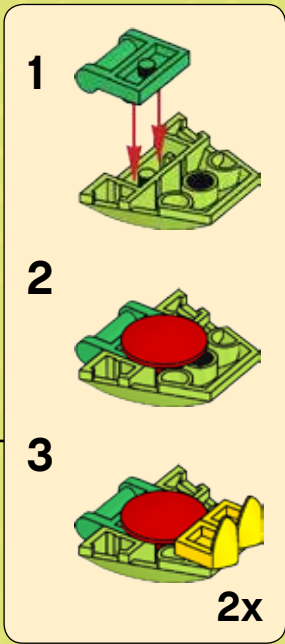
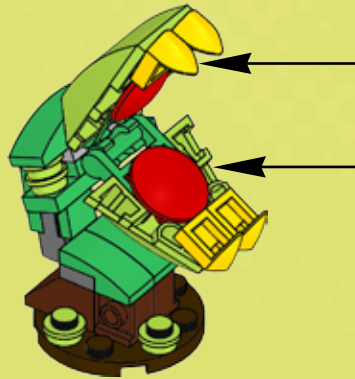

9



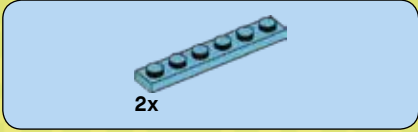

2x

1

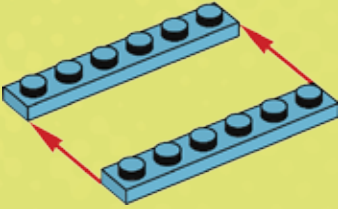

1x

2

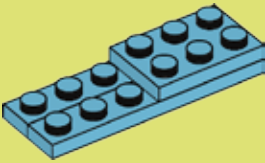

1x

3

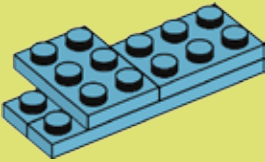

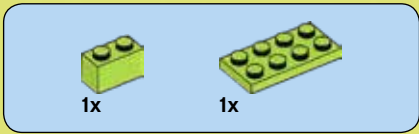

4

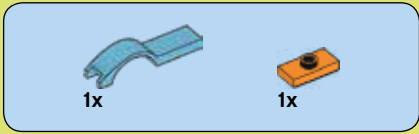
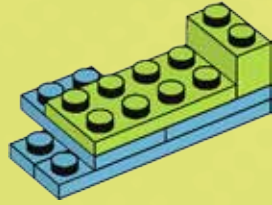

5

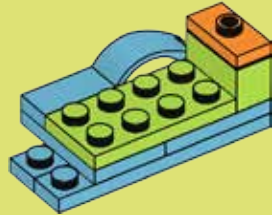

6

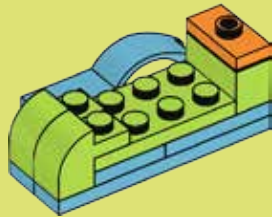

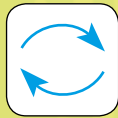

7

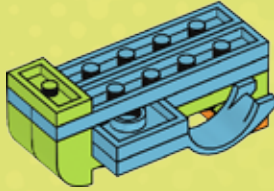

8

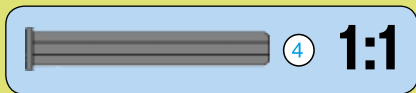
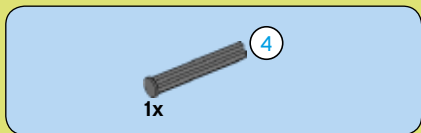
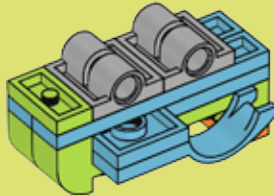

9

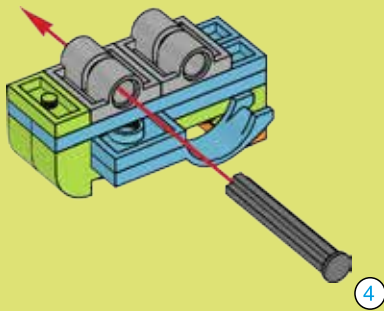

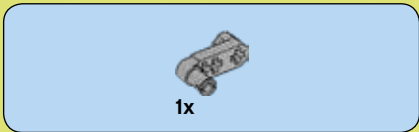

10

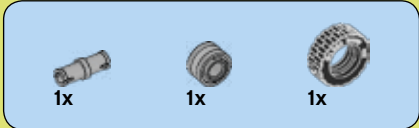
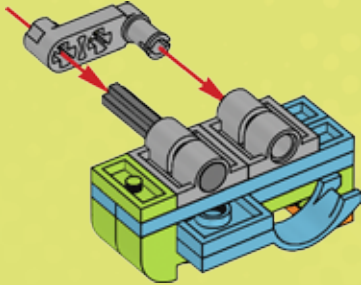

11

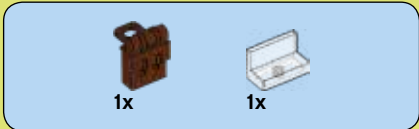
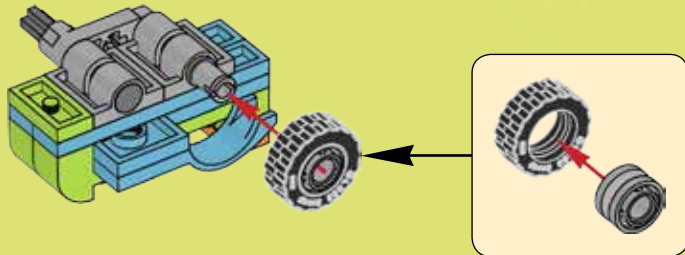

12

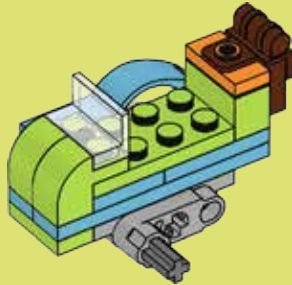

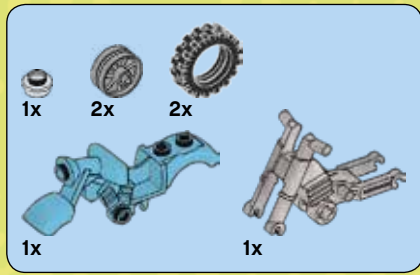

13

1



2

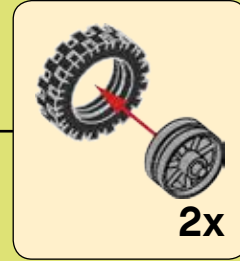
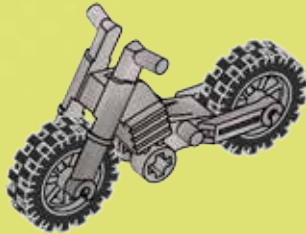

3

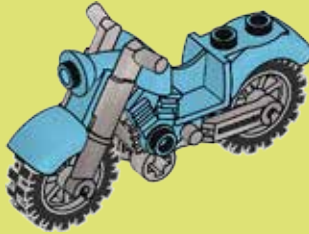

4

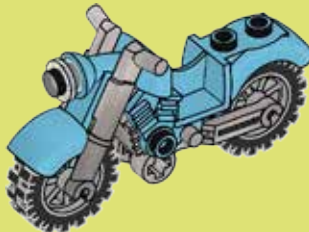

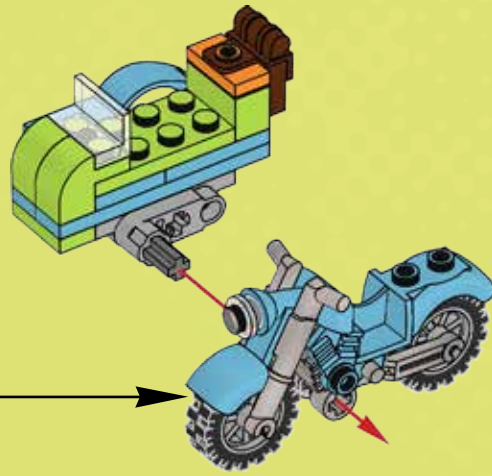

14



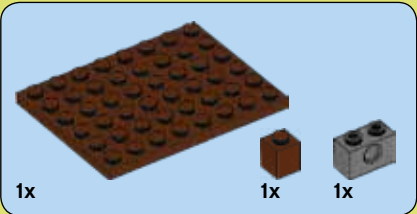
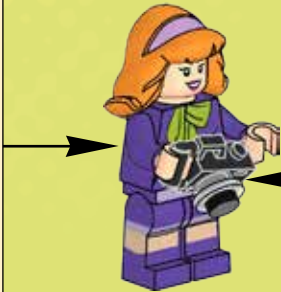
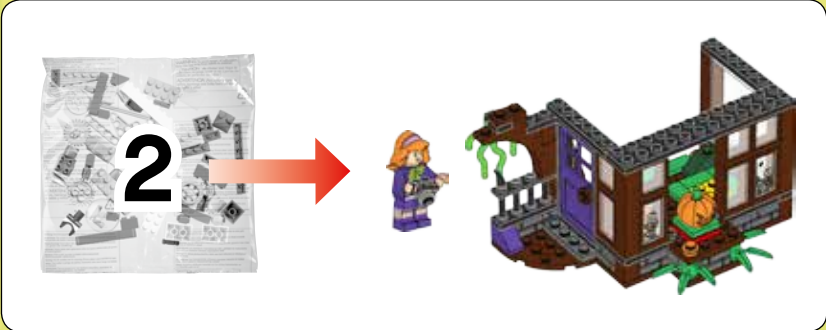

1

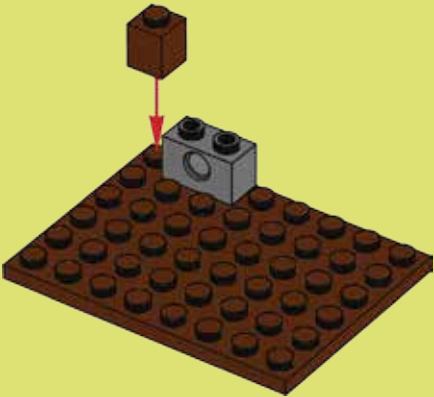



2

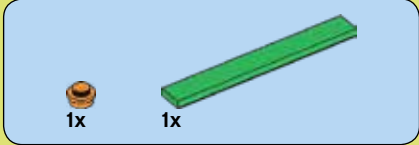

3

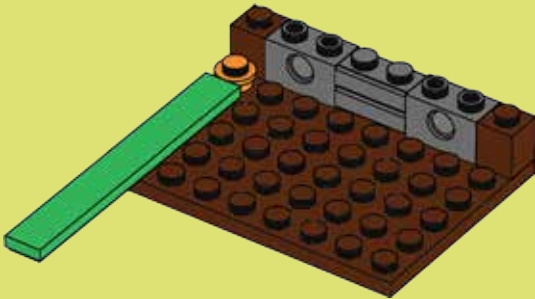

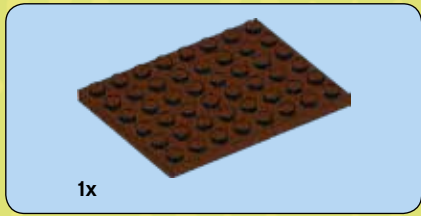

4

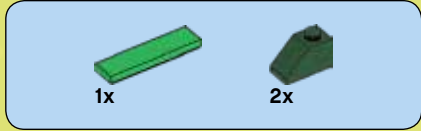
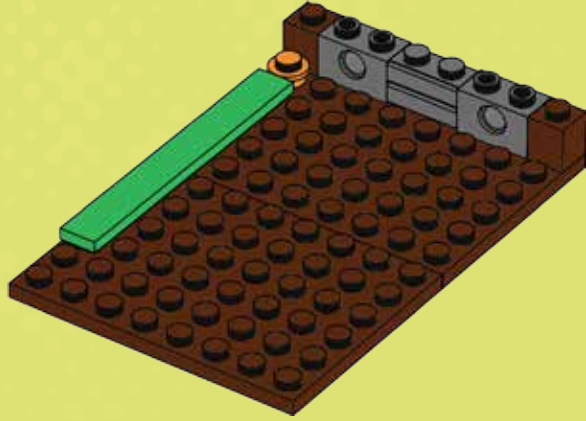

5

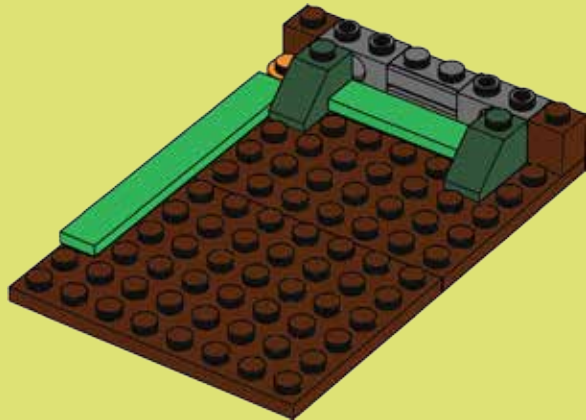

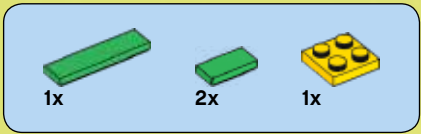

6



7

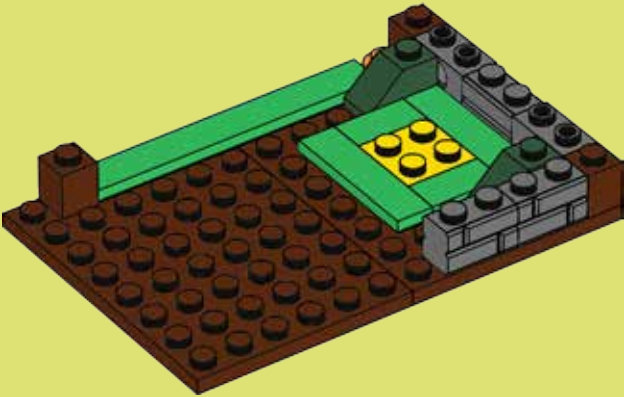

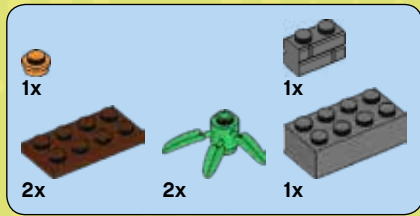

8

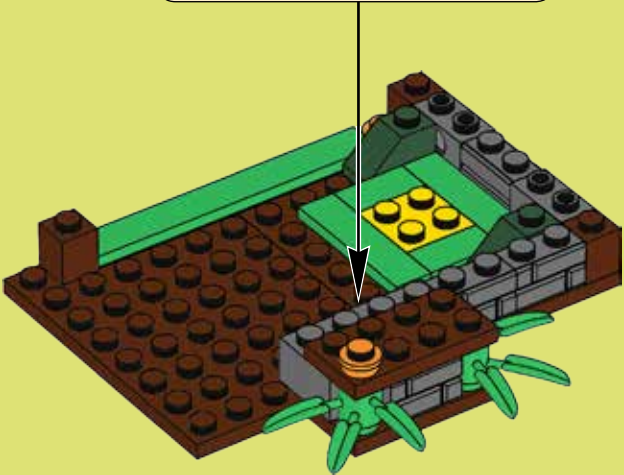
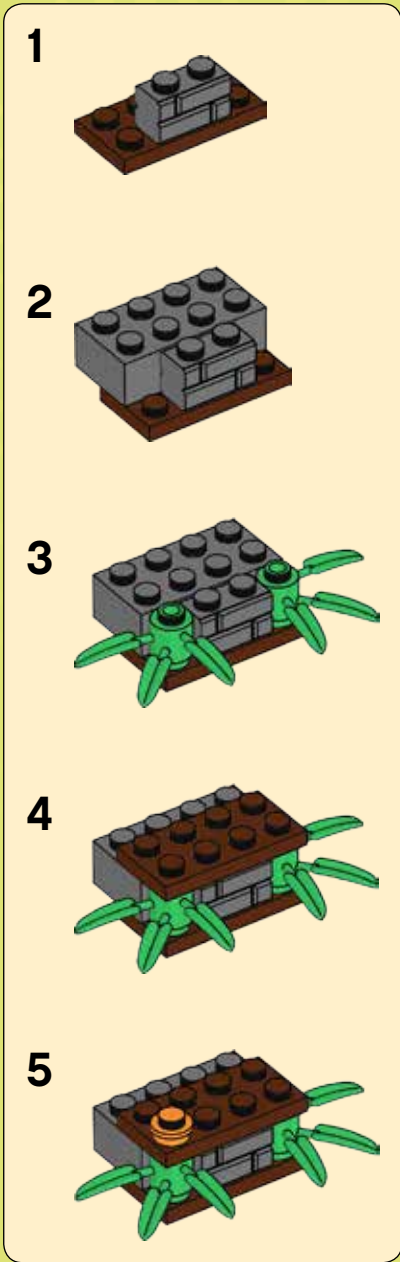



1x



2x

9

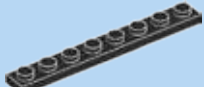

2x



1x

10



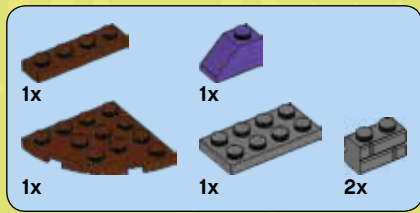

11

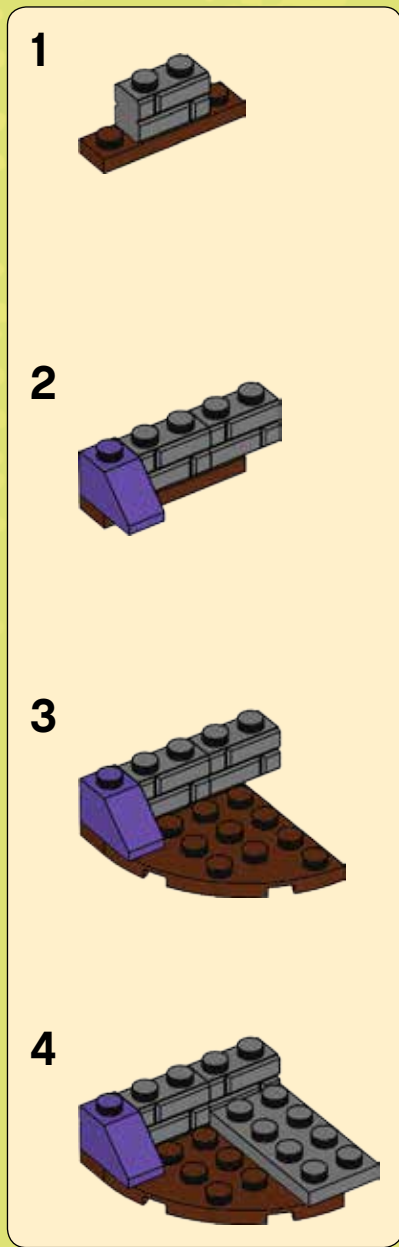

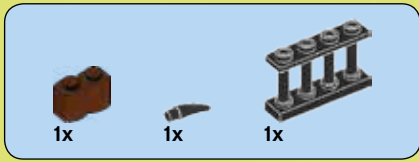

12



13

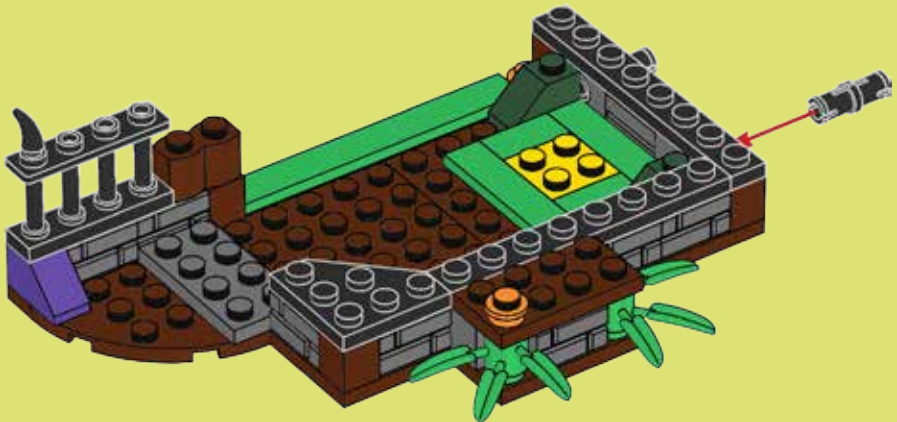

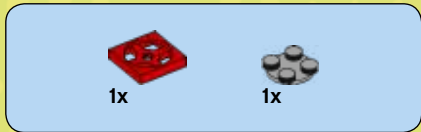

14

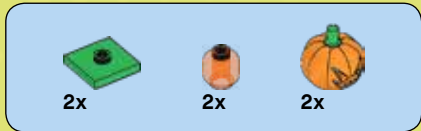
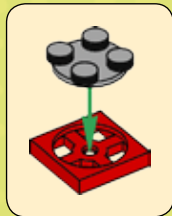

15

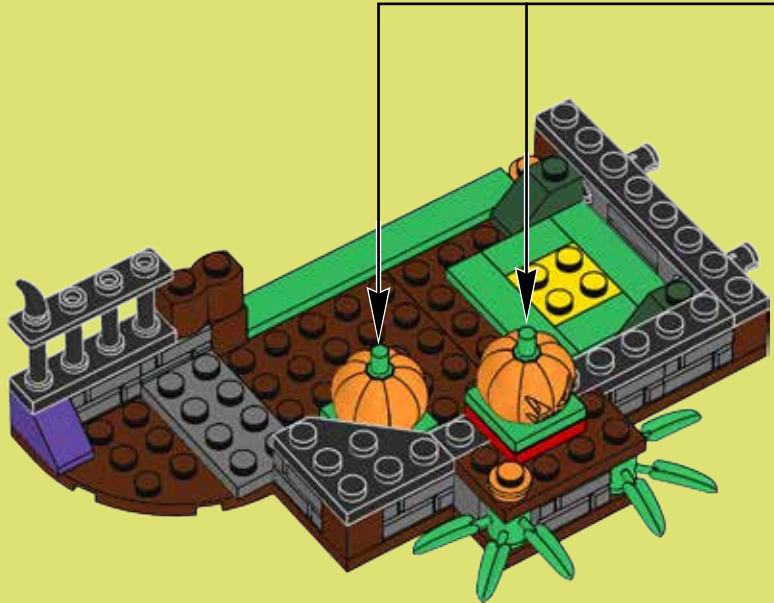



1x



1x

16



1x



1x

17





18

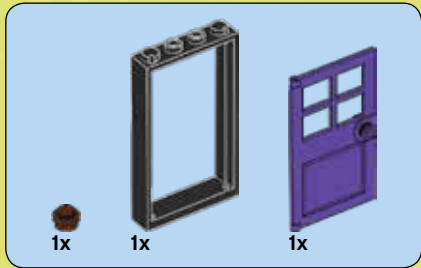

19

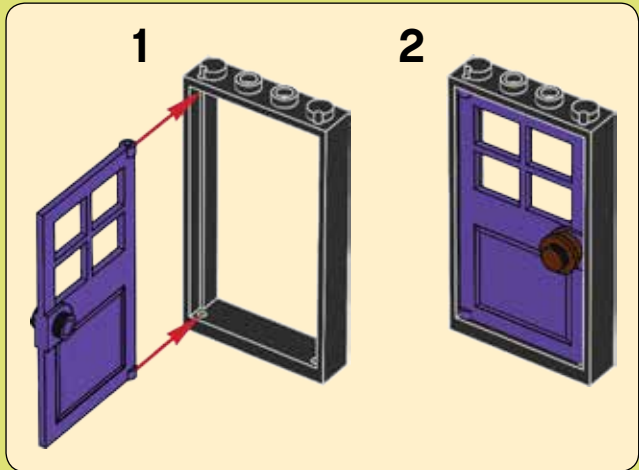

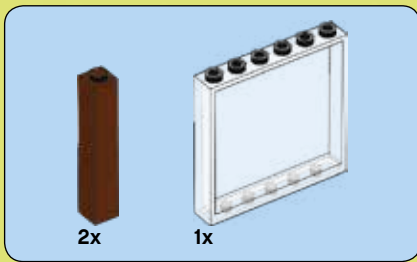

20

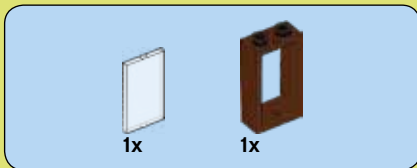

21

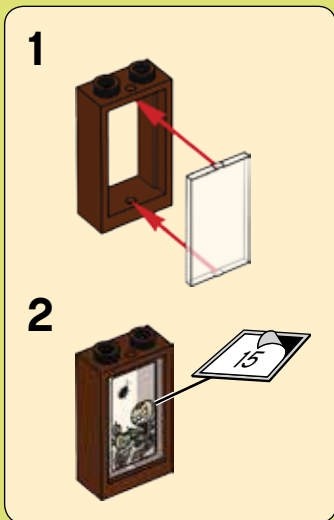



22

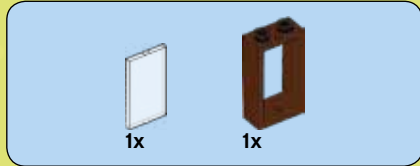
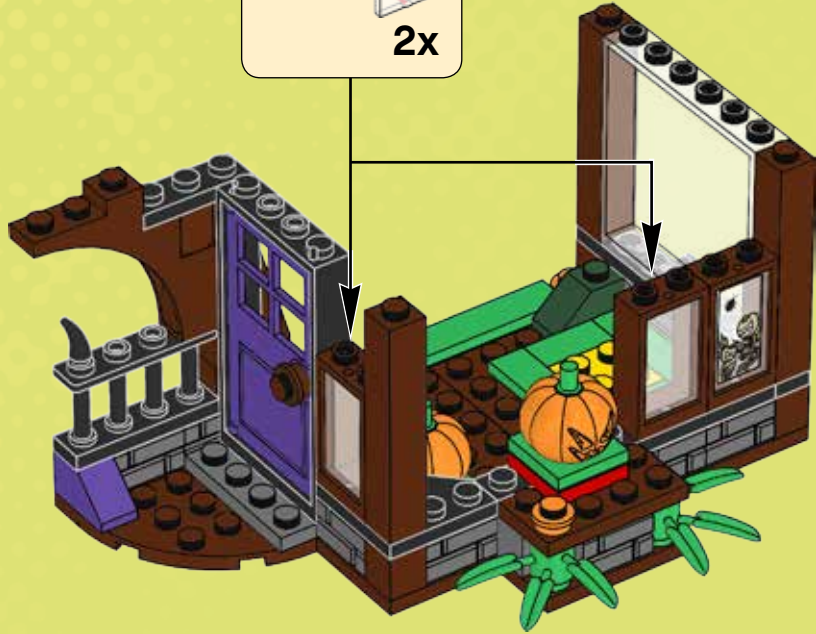
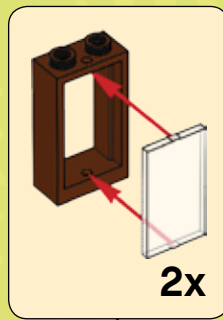

23

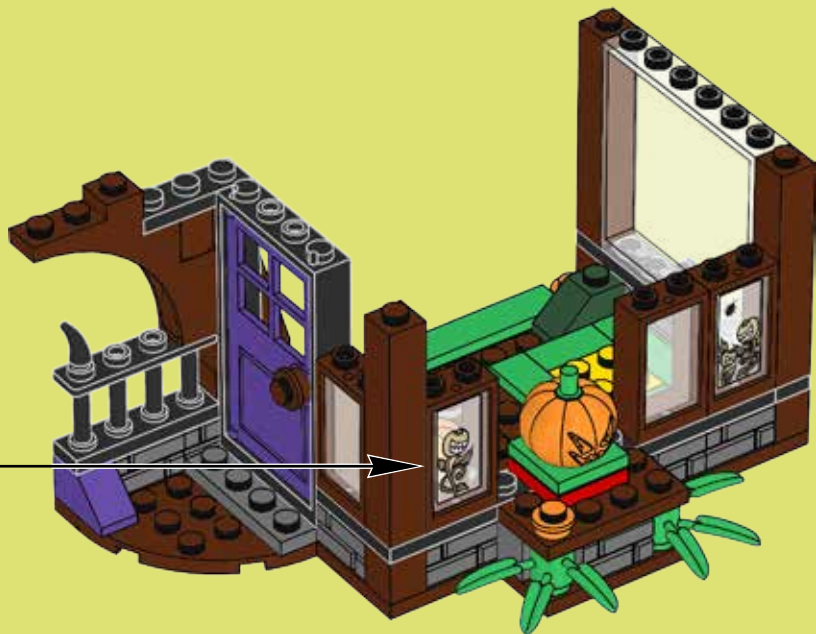
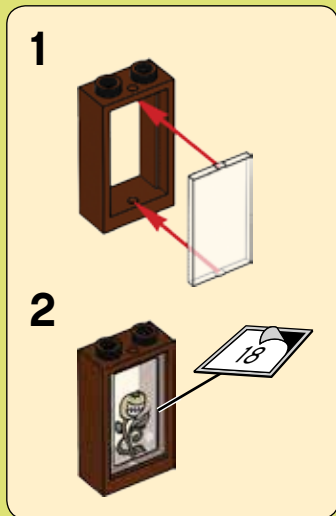



24

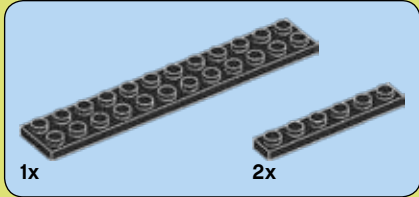
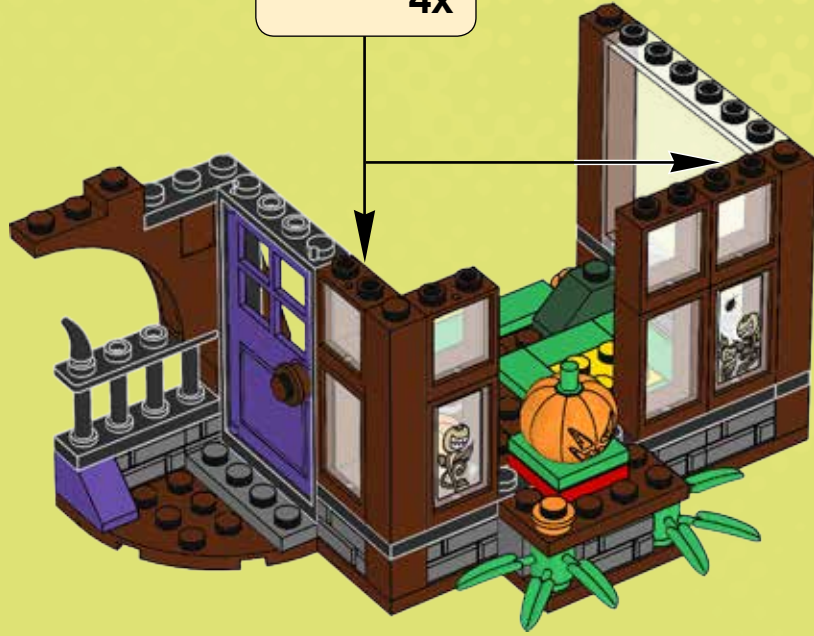
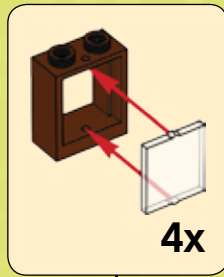

25





1x



1x

26



1x

27

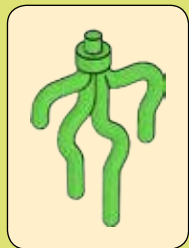

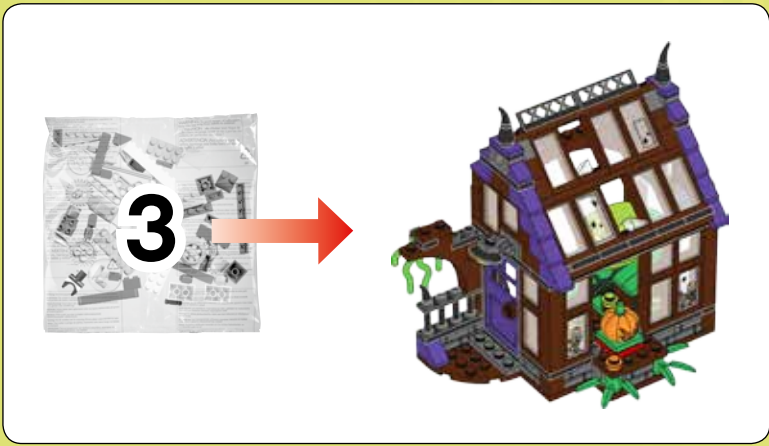

28

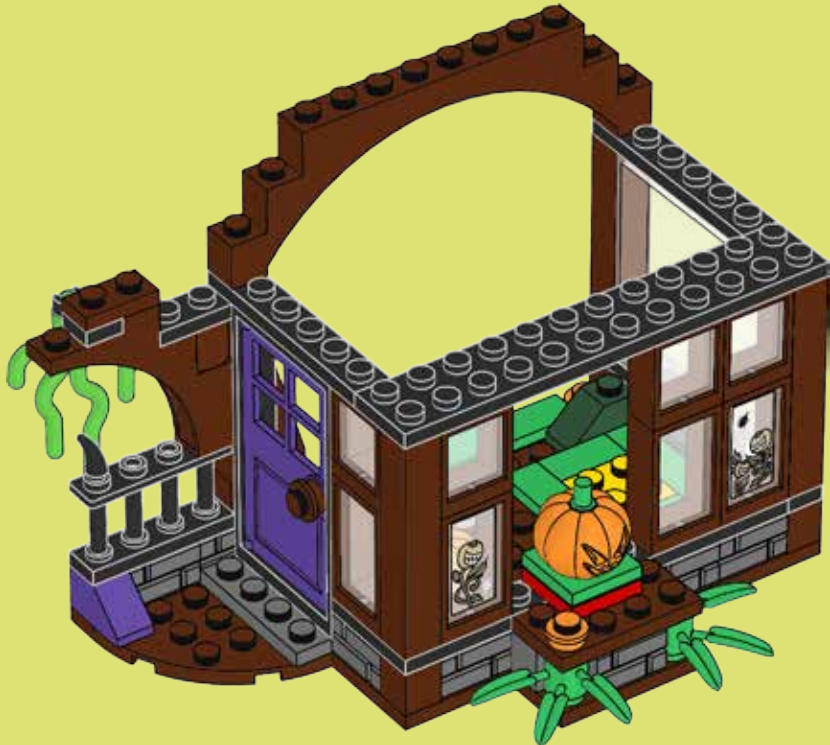



2x

29



1x



1x



2x

30

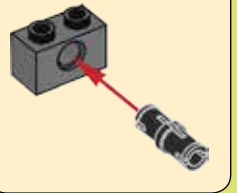
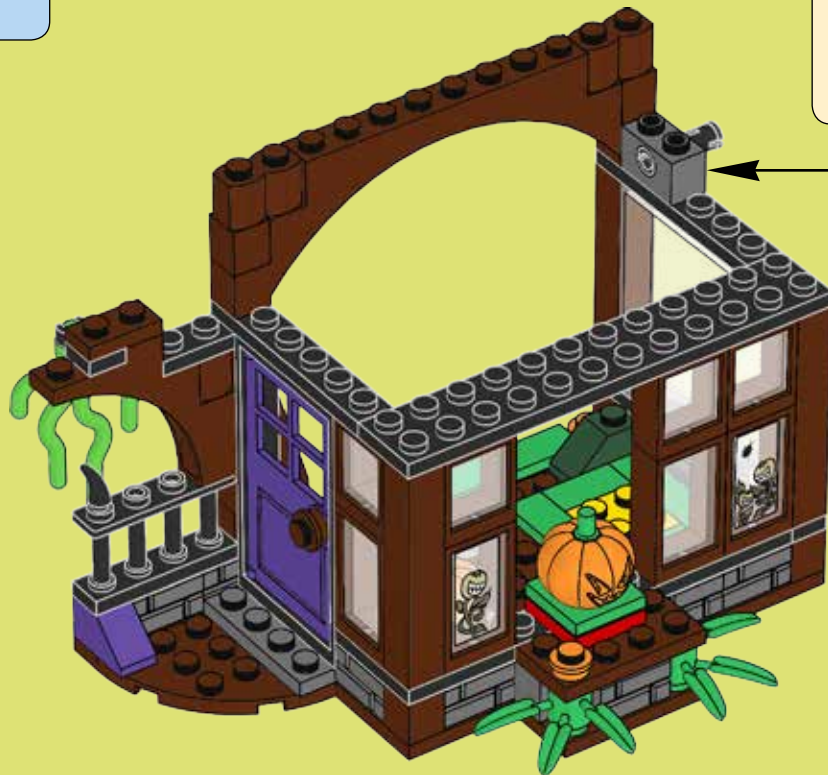

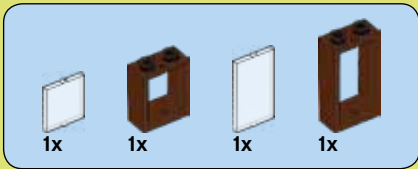

31

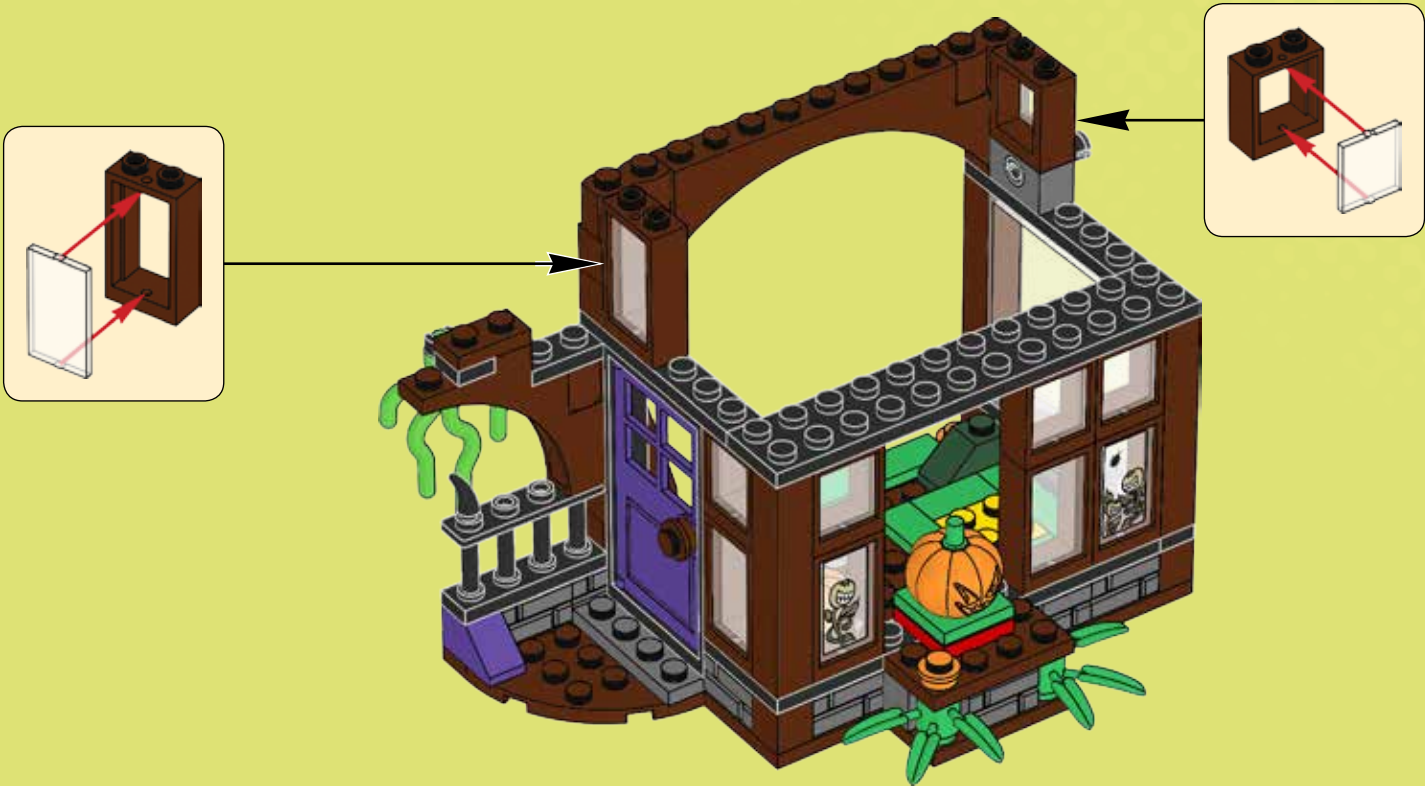



1x

32



1x



1x



1x



1x

33

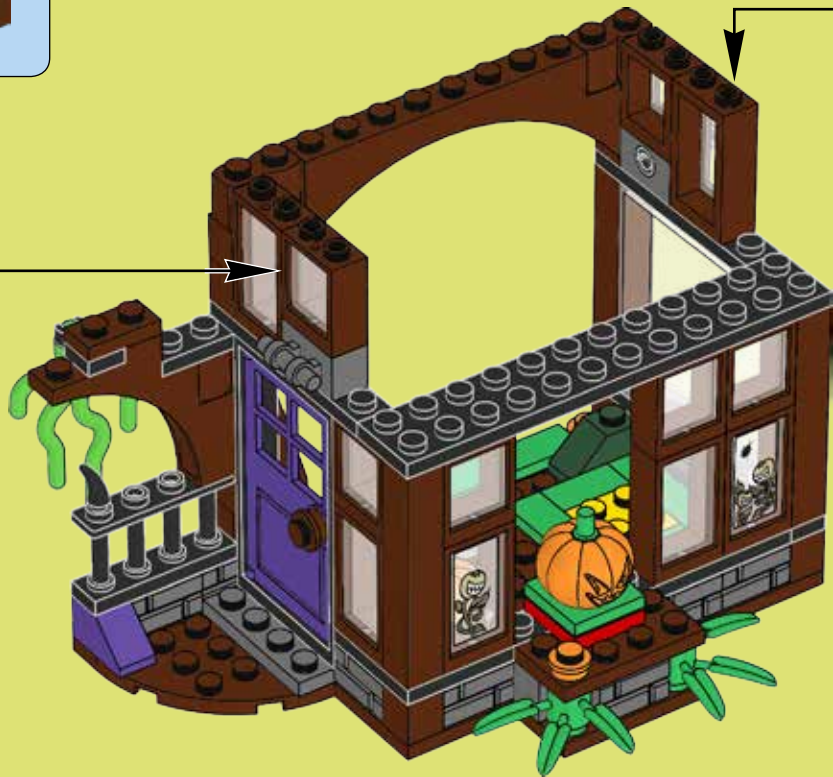
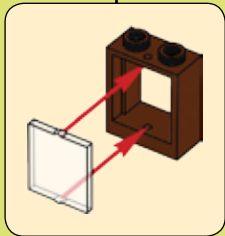
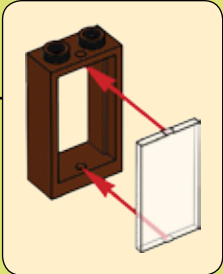



1x



1x



2x

34



2x



2x

35





2x

36



2x



4x

37

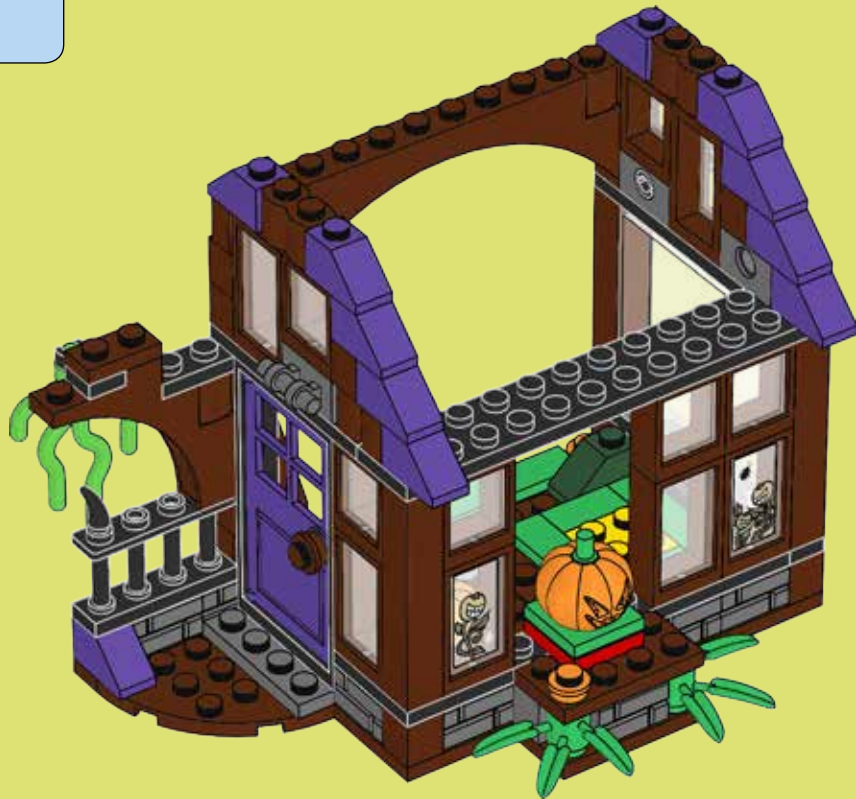



2x

38



1x

39



- 1x 
- 1x 
- 1x 

40

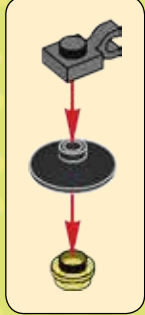

- 2x 

41

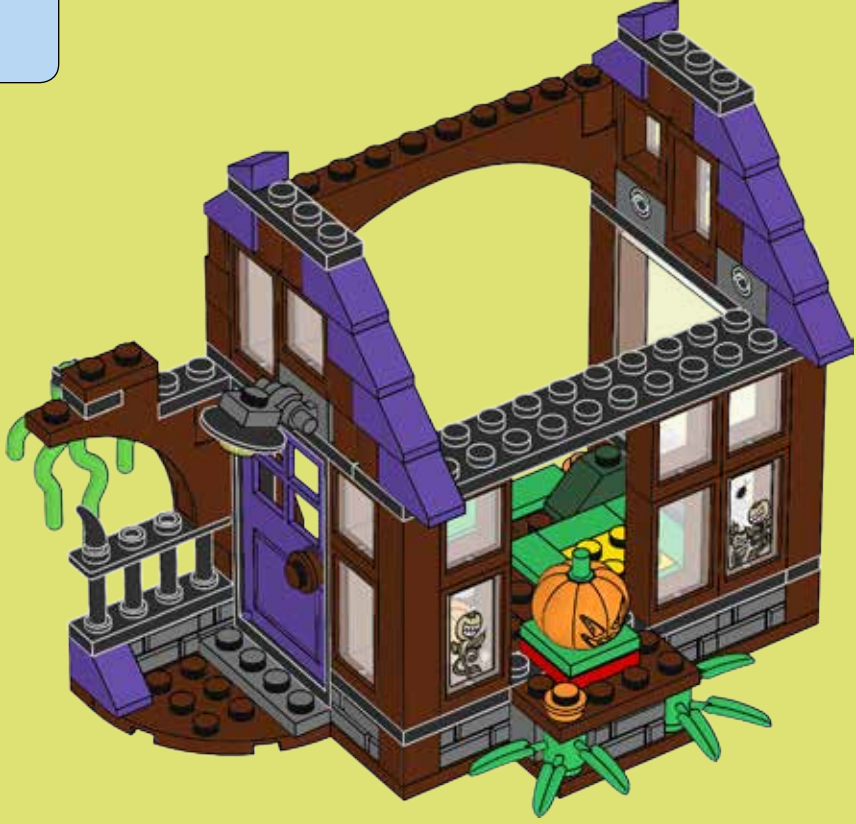

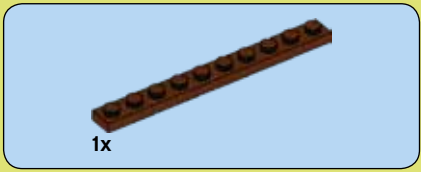
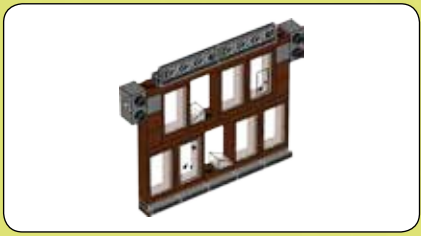

1



2

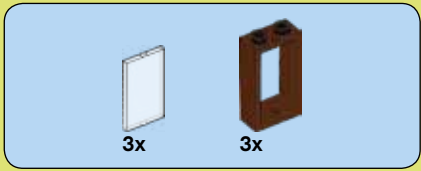
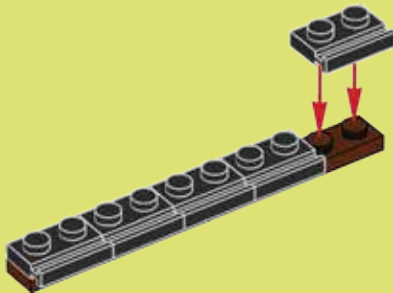

3

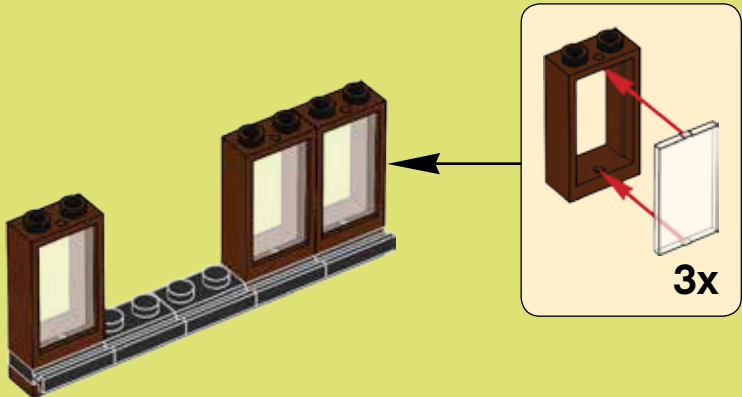



4

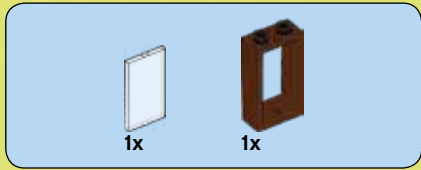
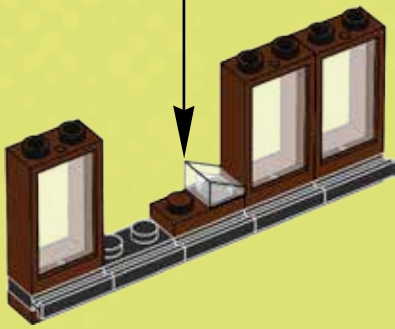

5

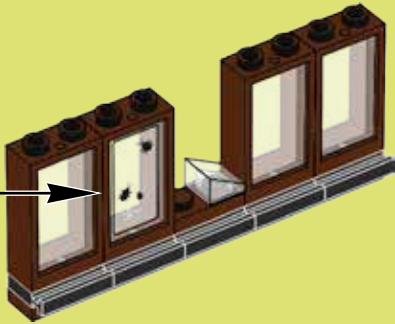
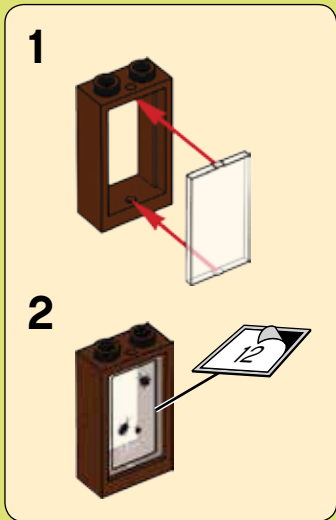

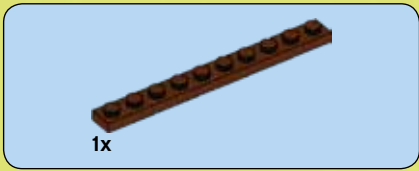

6

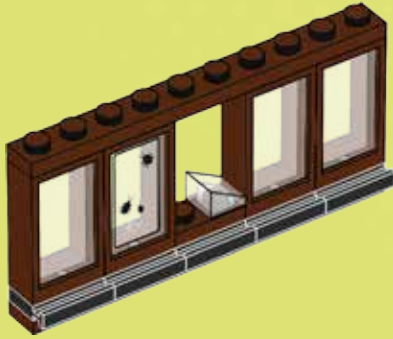

7

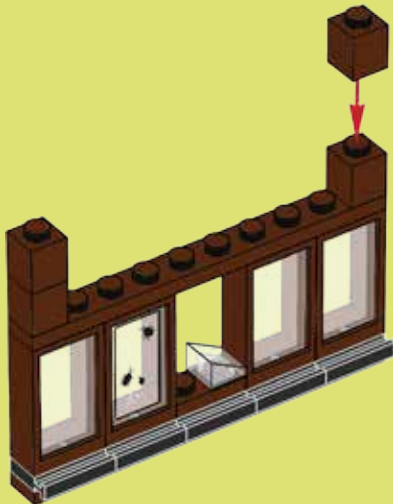

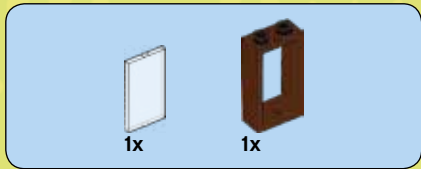

8

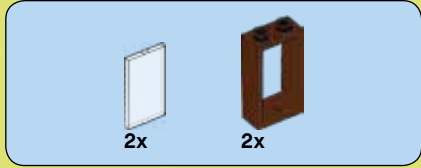
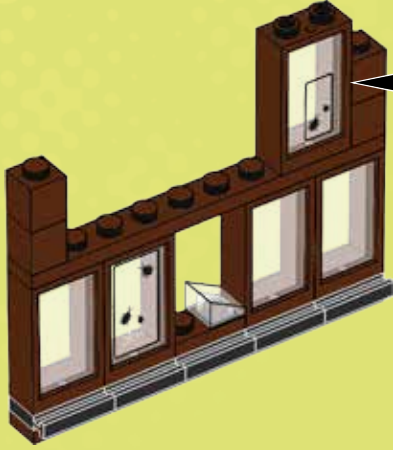
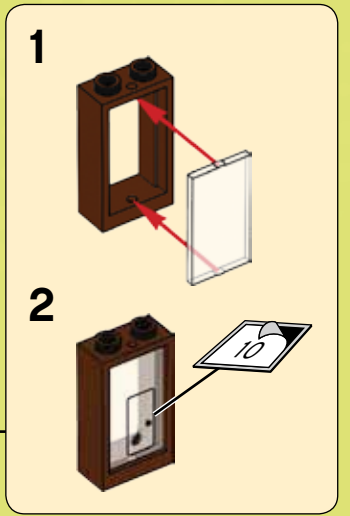

9

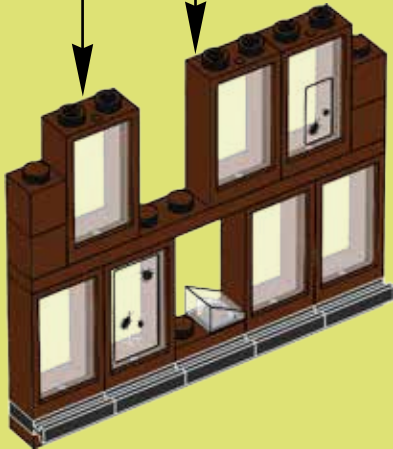
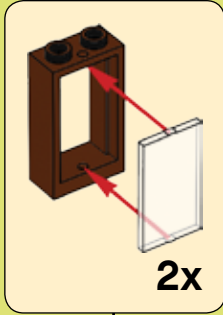



10

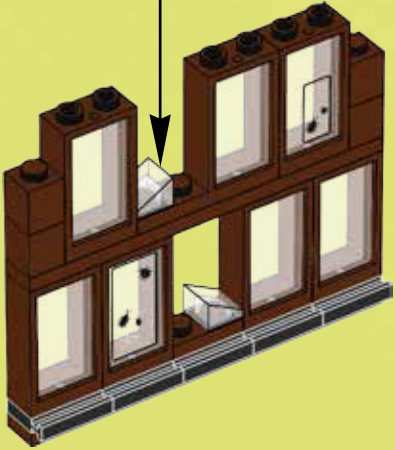

11

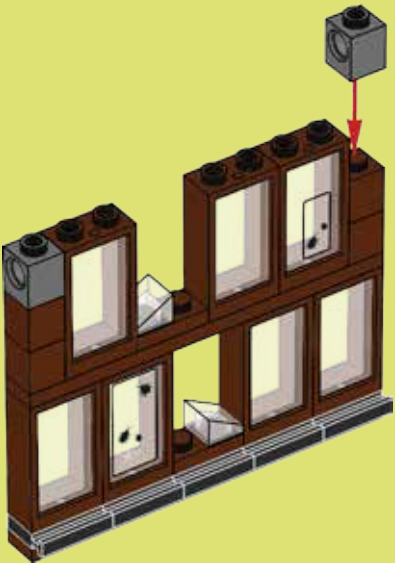



12

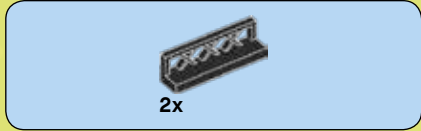
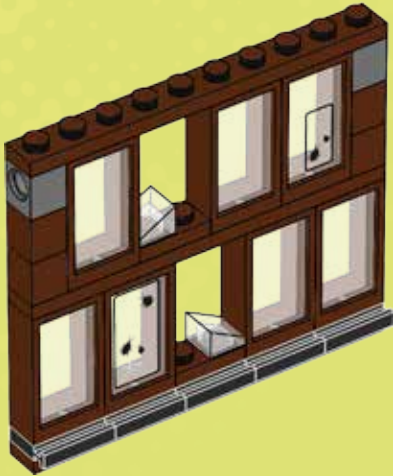

13

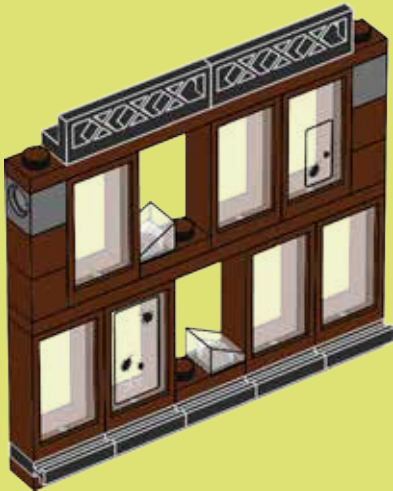



2x

14

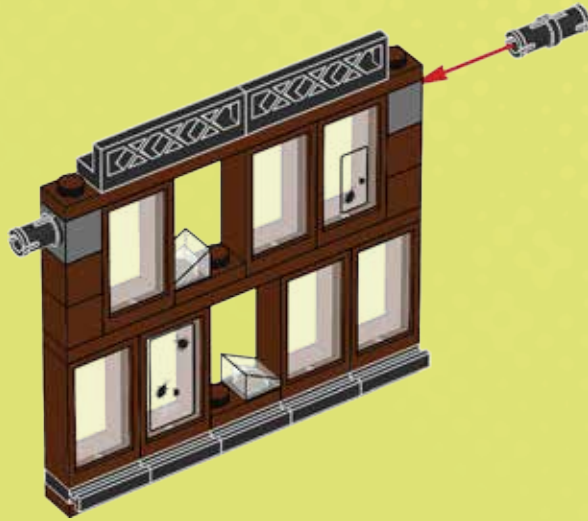

2x

15

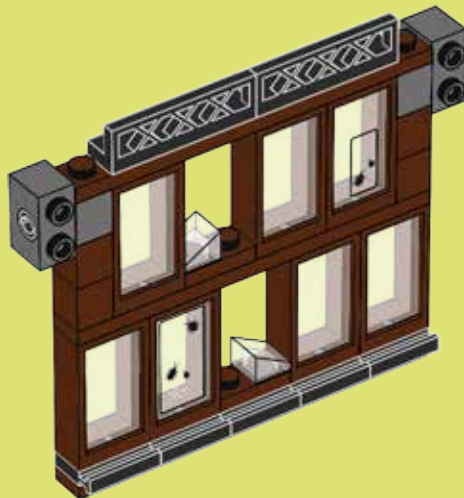

42





2x



2x

43



2x



2x

44



2x

45

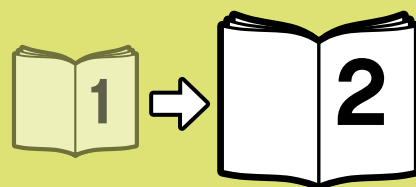
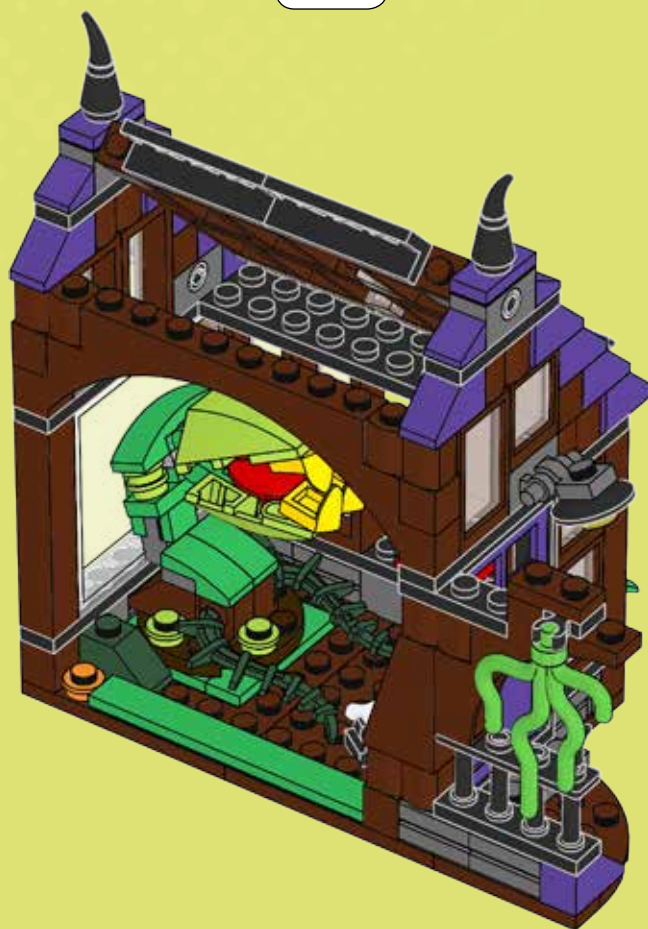
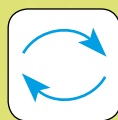



SCOOBY-DOO!

WE'VE GOT A MYSTERY TO SOLVE
WIR MÜSSEN EIN GEHEIMNIS LÜFTEN
NOUS AVONS UN MYSTÈRE À RÉSOUDRE

TENEMOS UN MISTERIO QUE RESOLVER
TEMOS UM MISTÉRIO PARA RESOLVER
MÁIS VAN EGY MEGOLDÁSRA VÁRÓ REJTÉLYÜNK

75900



75901



75902



75903



75904



LEGO.COM/scoobydoo

