



Disney · PIXAR
**Toy
Story**
3



 **WARNING: CHOKING HAZARD.**
Toy contains small parts and a small ball.
Not for children under 3 years.



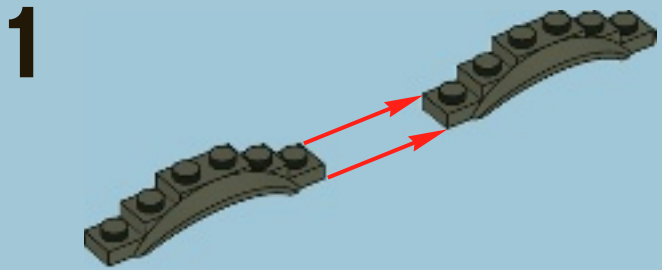
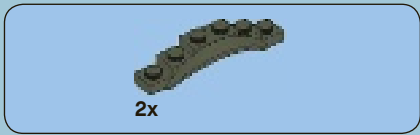
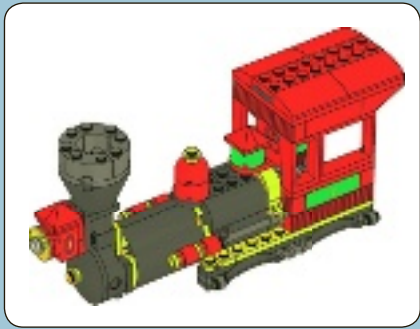
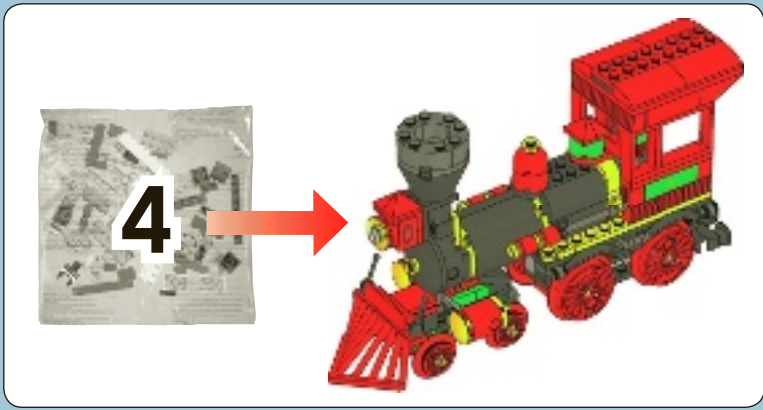

2

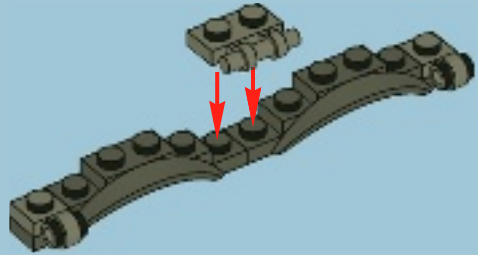

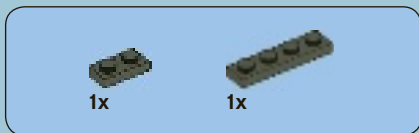

3

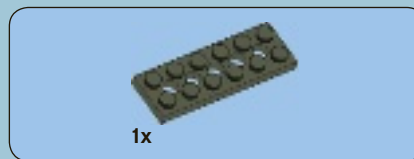
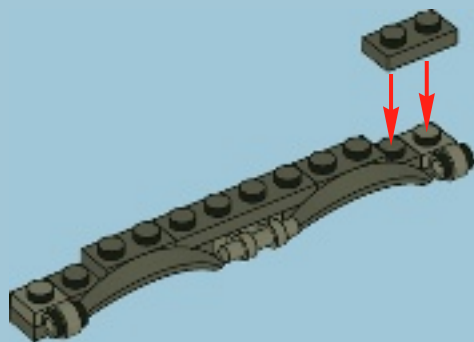

4

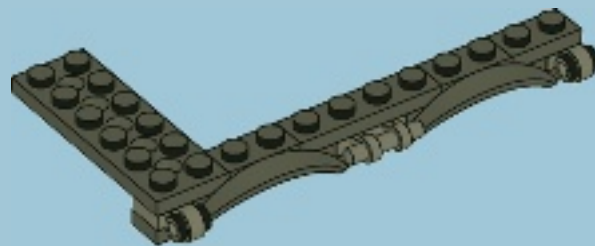

-  **AVERTISSEMENT** : RISQUE D'ÉTOUFFEMENT.
Le jouet contient des petites pièces ainsi qu'une petite boule.
Il ne convient pas aux enfants de moins de 3 ans.
-  **ADVERTENCIA**: PELIGRO DE ASFIXIA.
Juguete que contiene partes pequeñas y una pelota pequeña.
No recomendado para niños menores de 3 años.

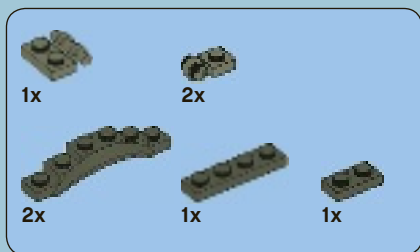

5

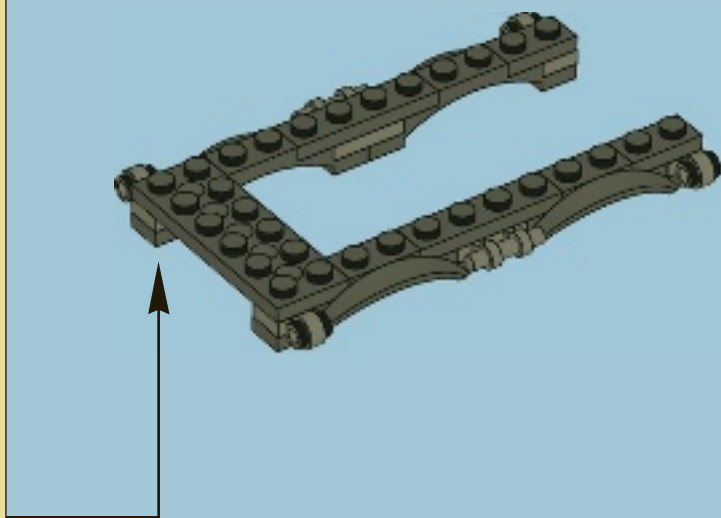
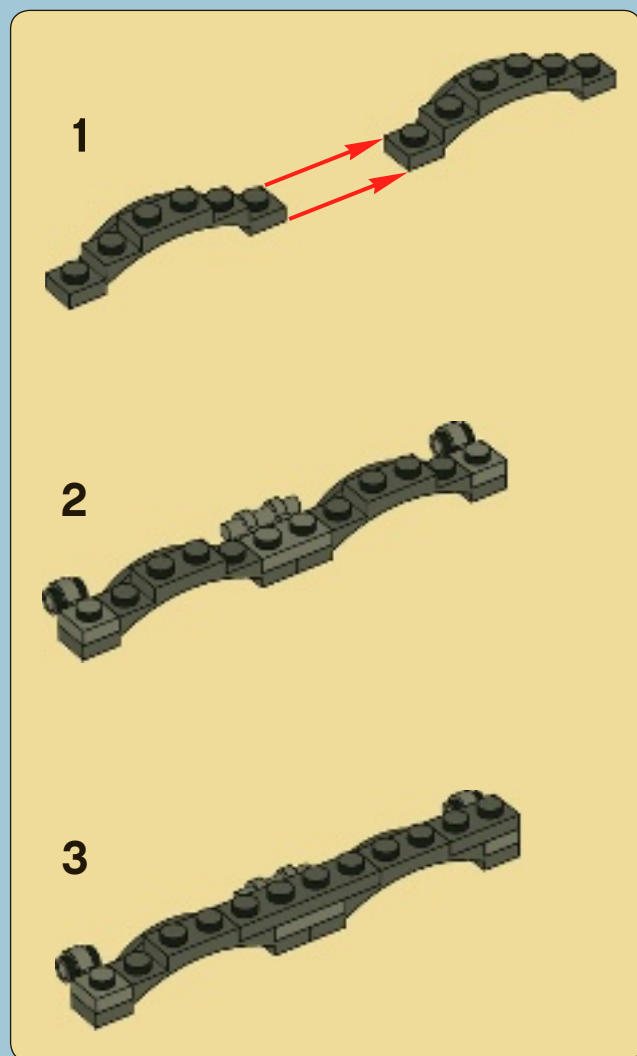

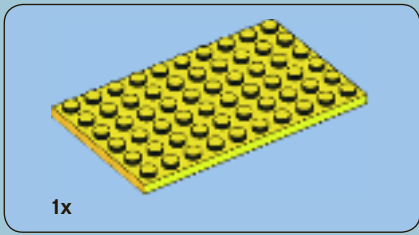

6

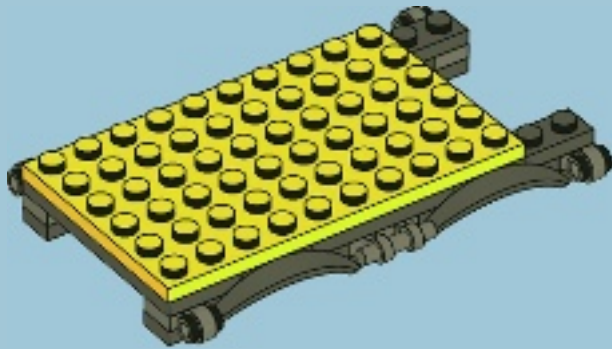

7

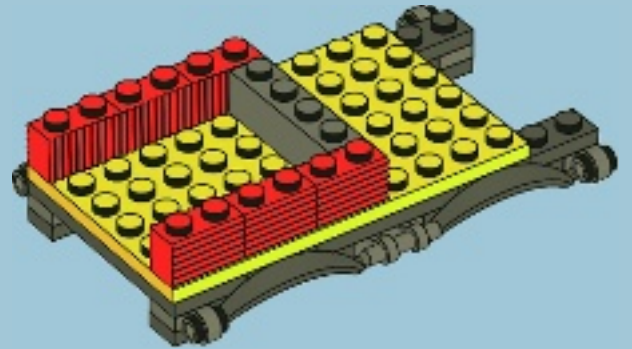

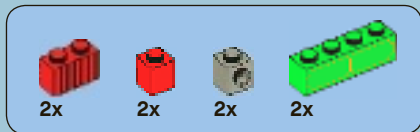

8

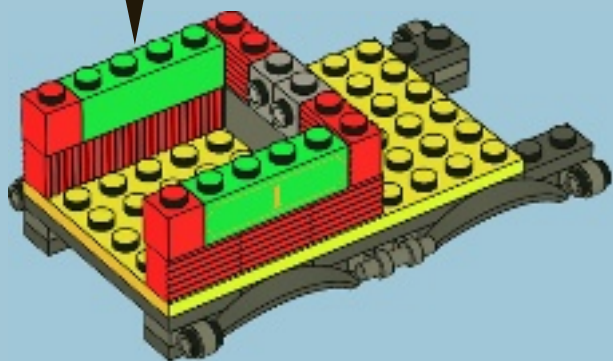
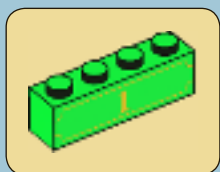

9

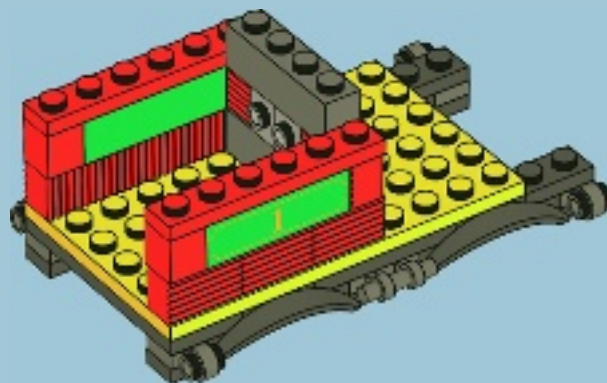



10

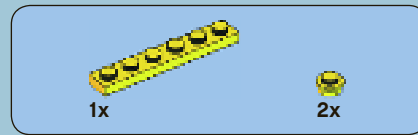
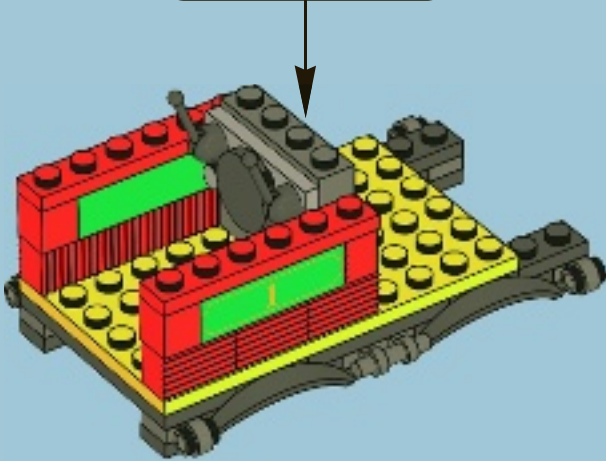
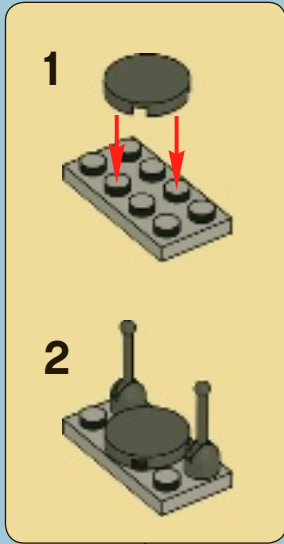

11

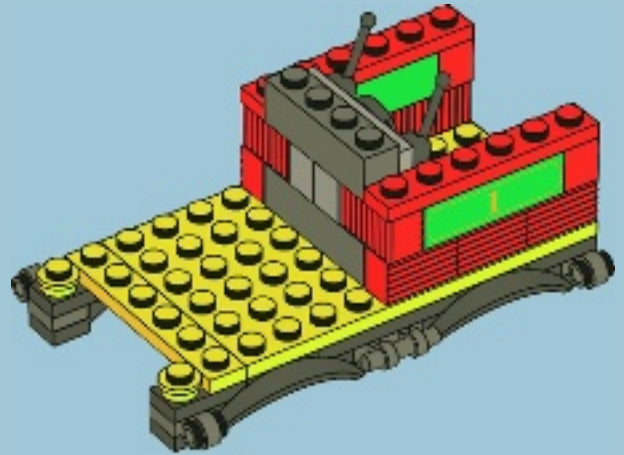



3x

12

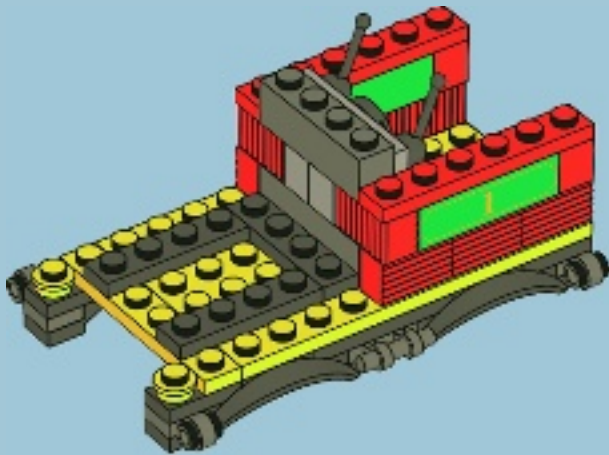

2x



2x

13

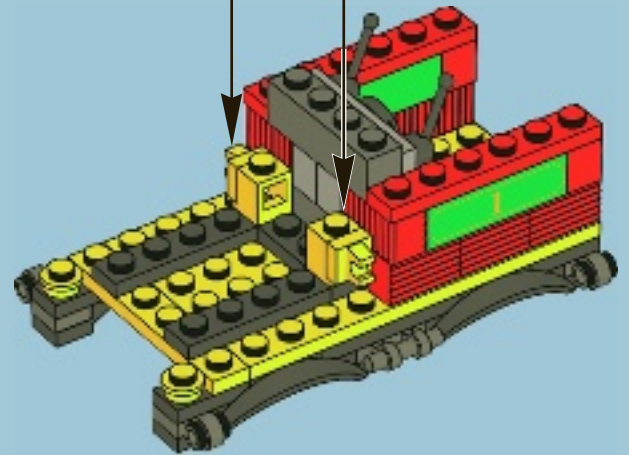
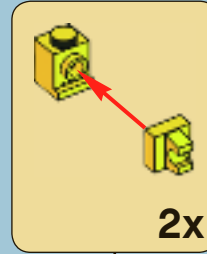



1x



1x

14

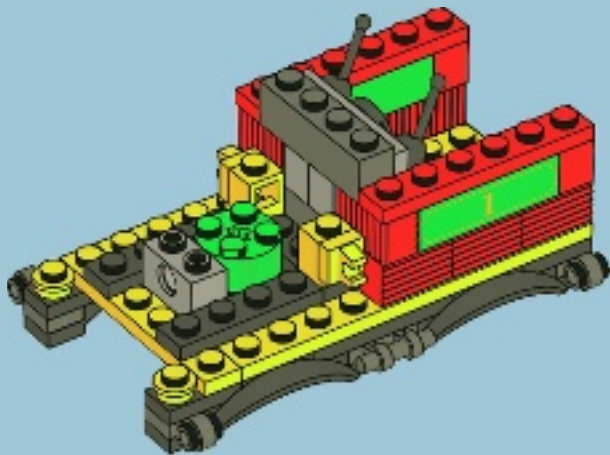

1x



2x



1x

15

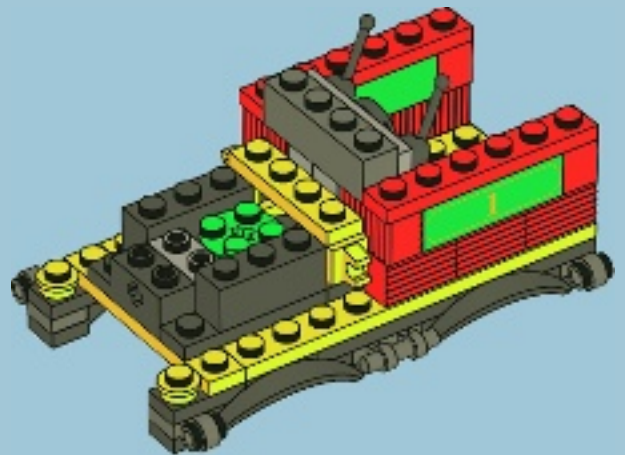



2x



2x

16

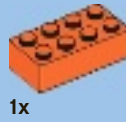
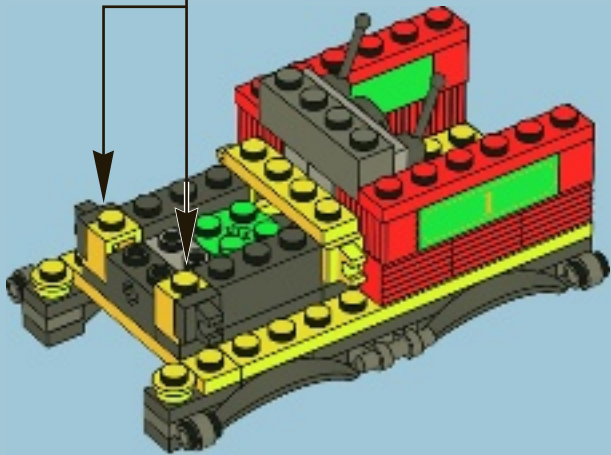
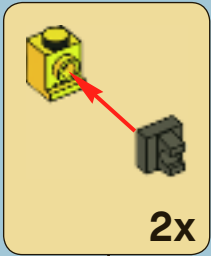

1x



2x

17

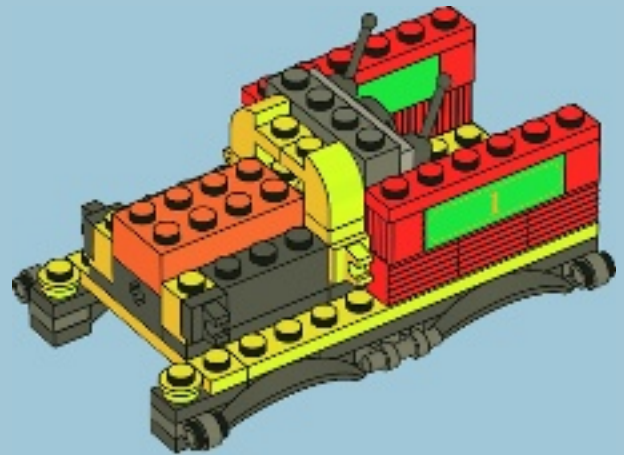

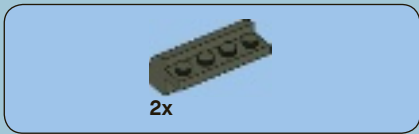

18

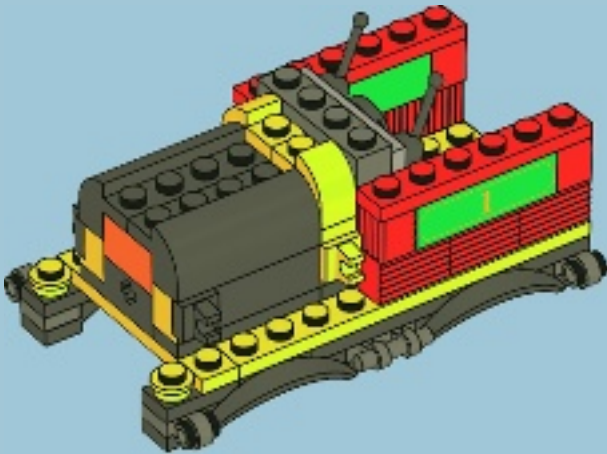

19

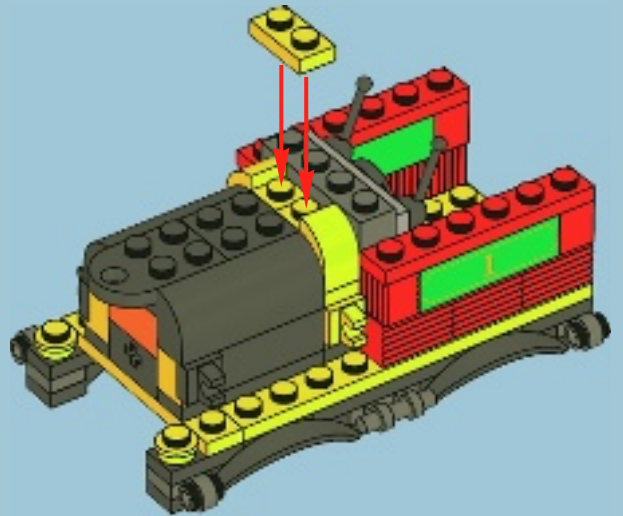



20

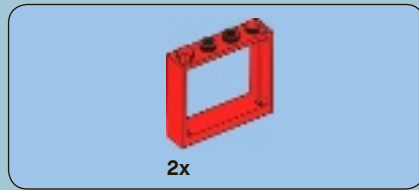
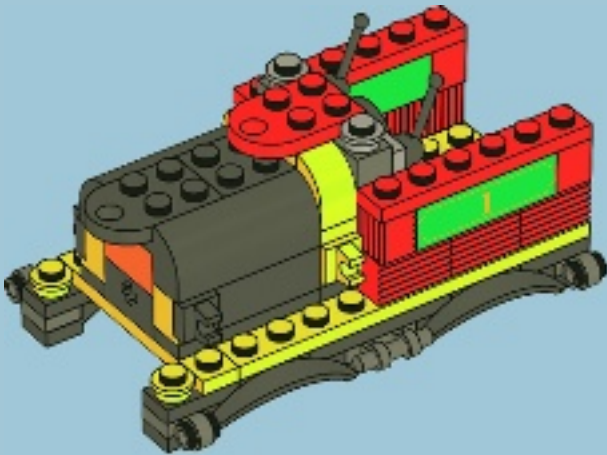

21

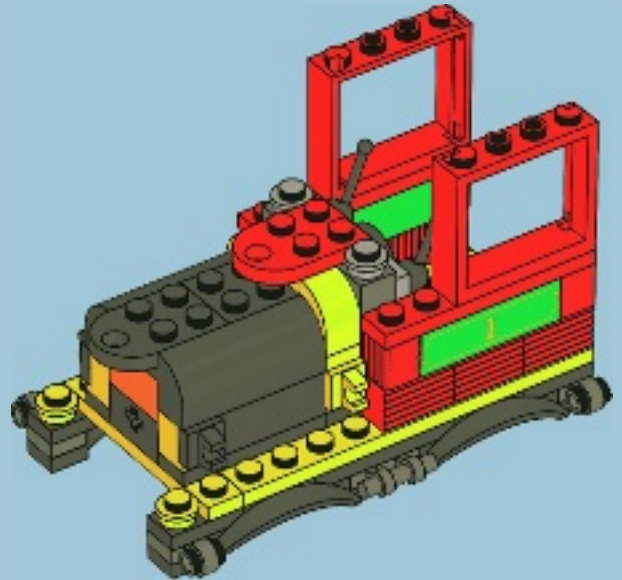

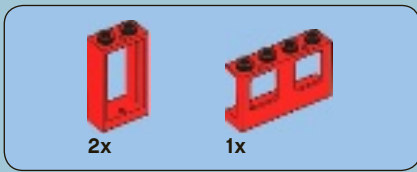

22

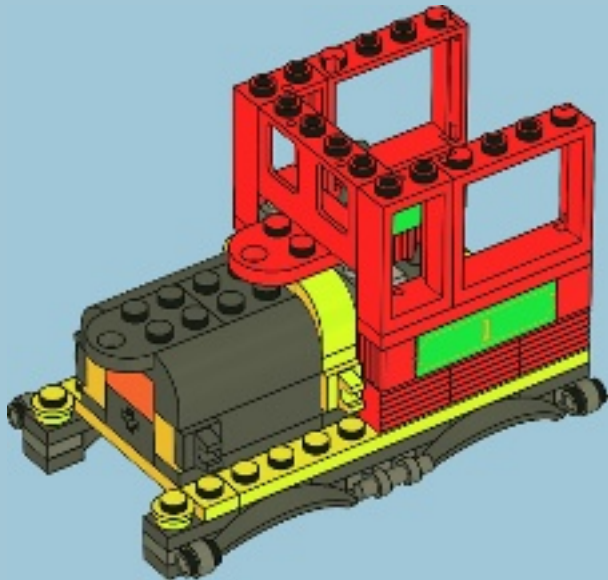

23

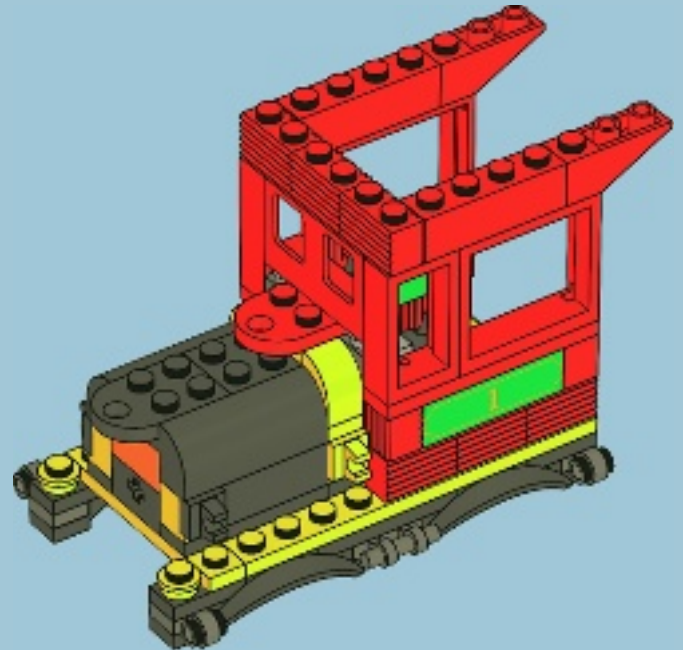

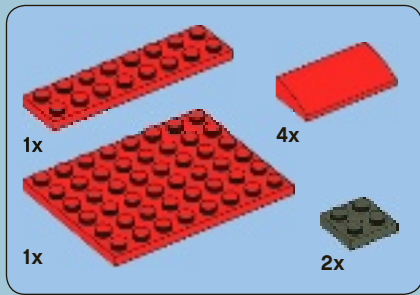

24

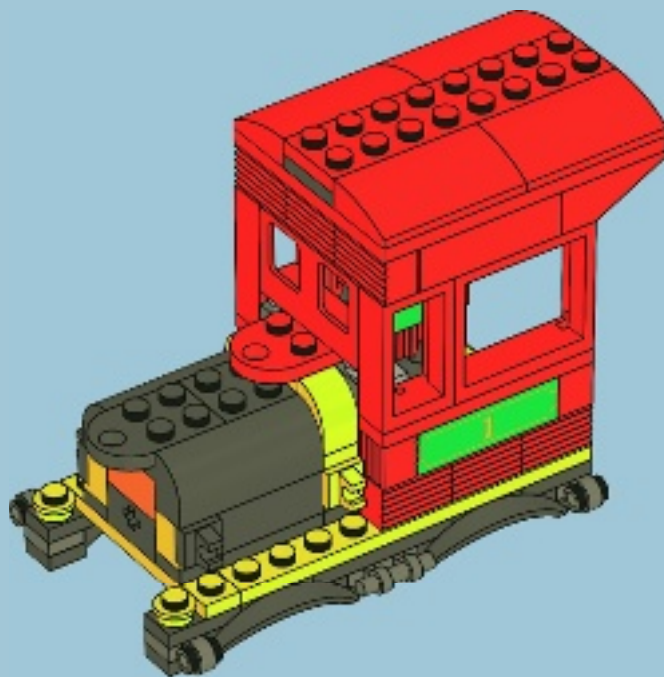
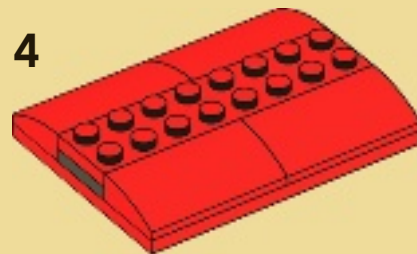
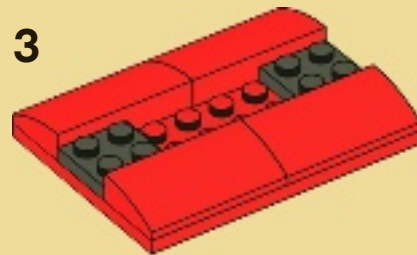



25

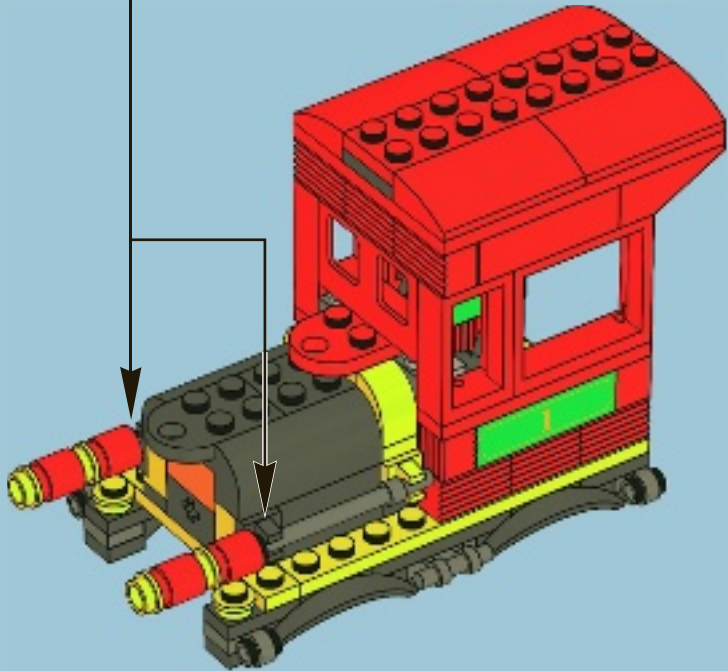
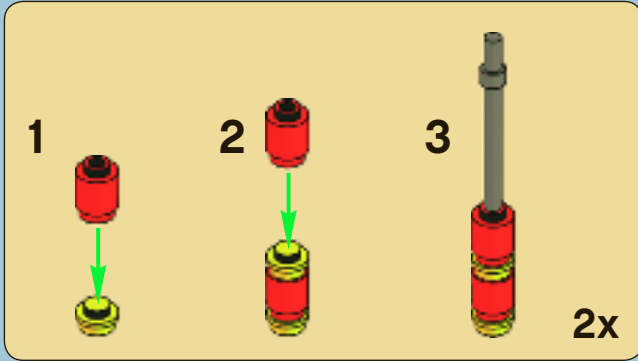

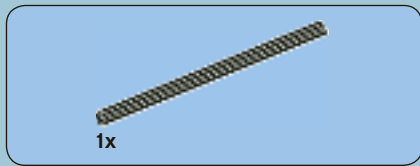

26

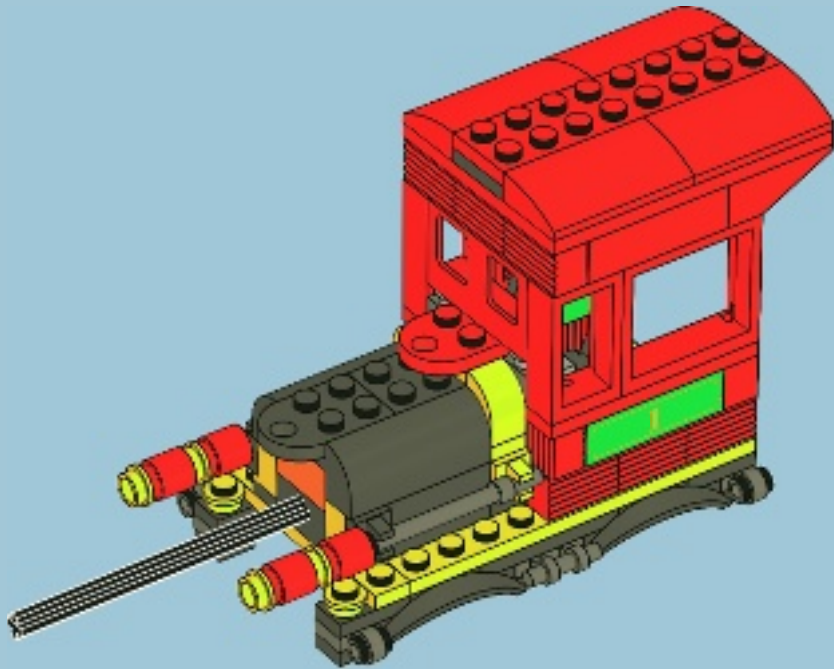



2x



1x

27

1



2

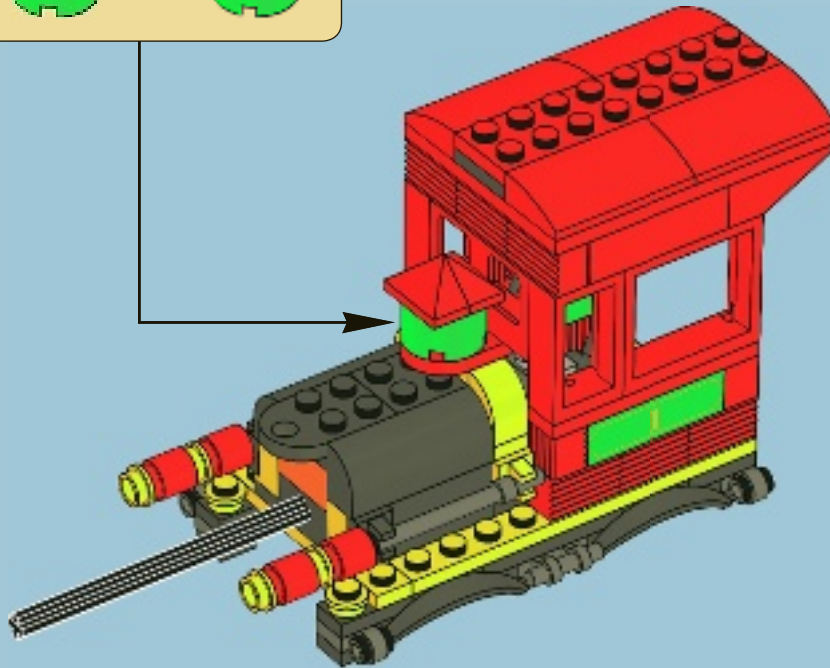
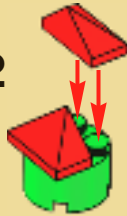

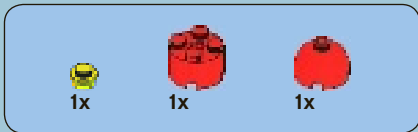

28

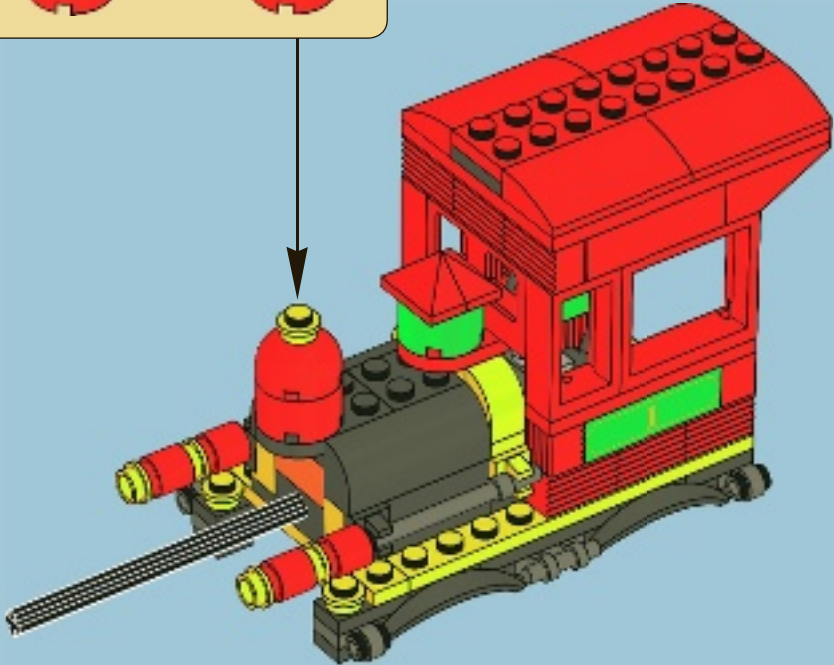
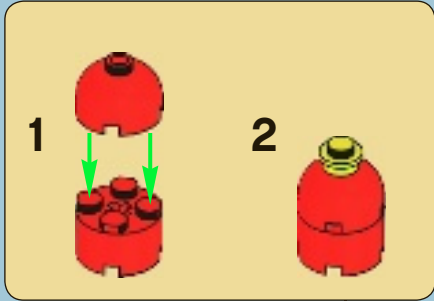



1



2



3



4





5

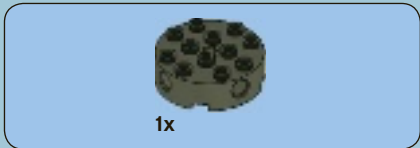

6

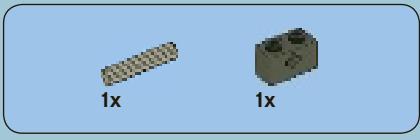

7

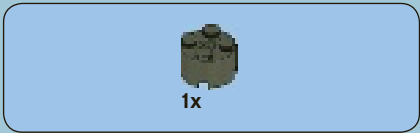
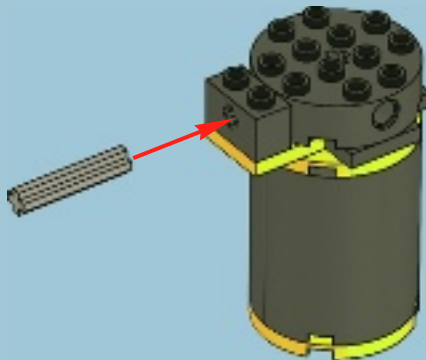

8



29

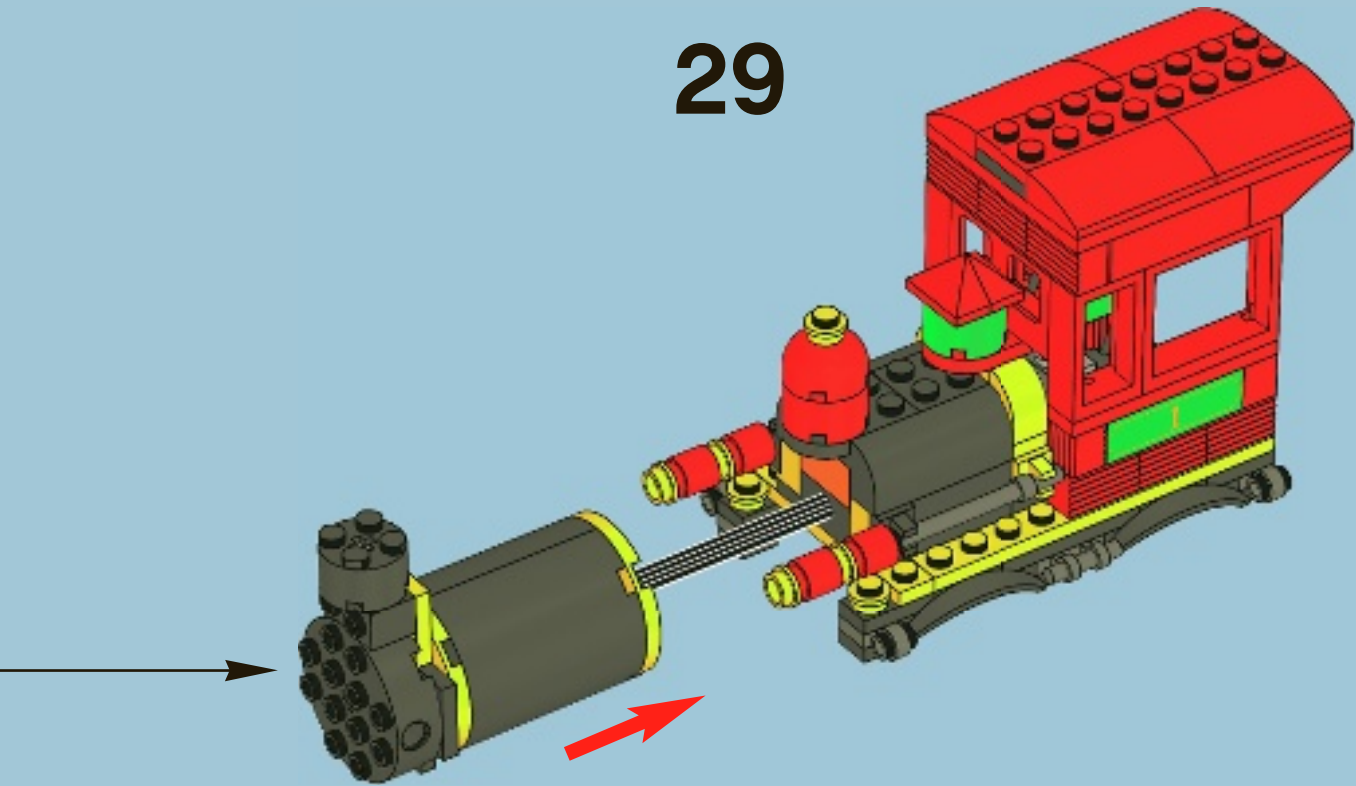



30

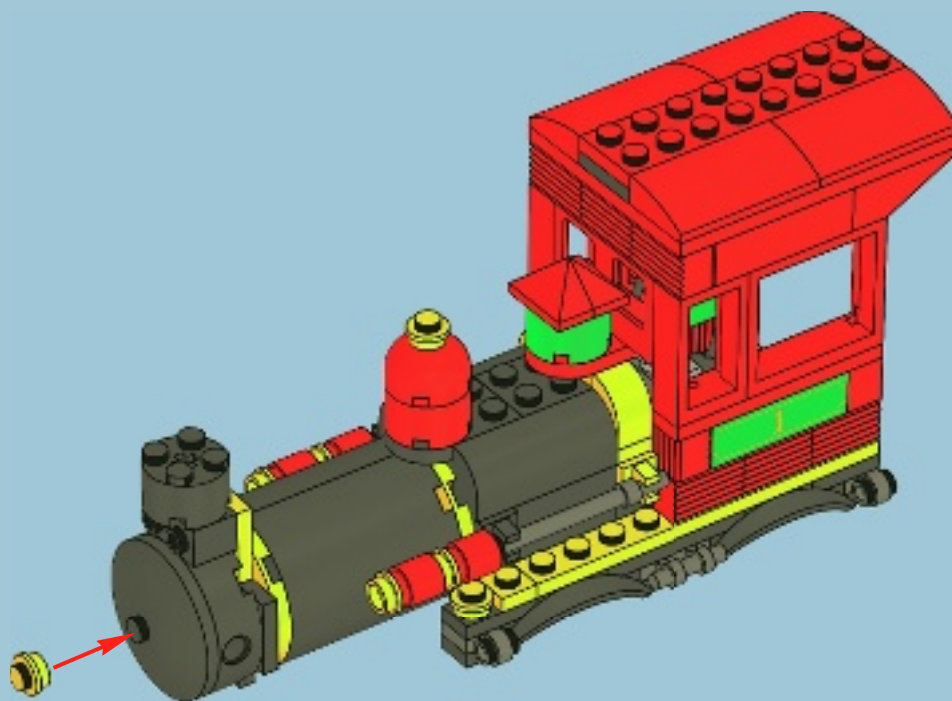



31

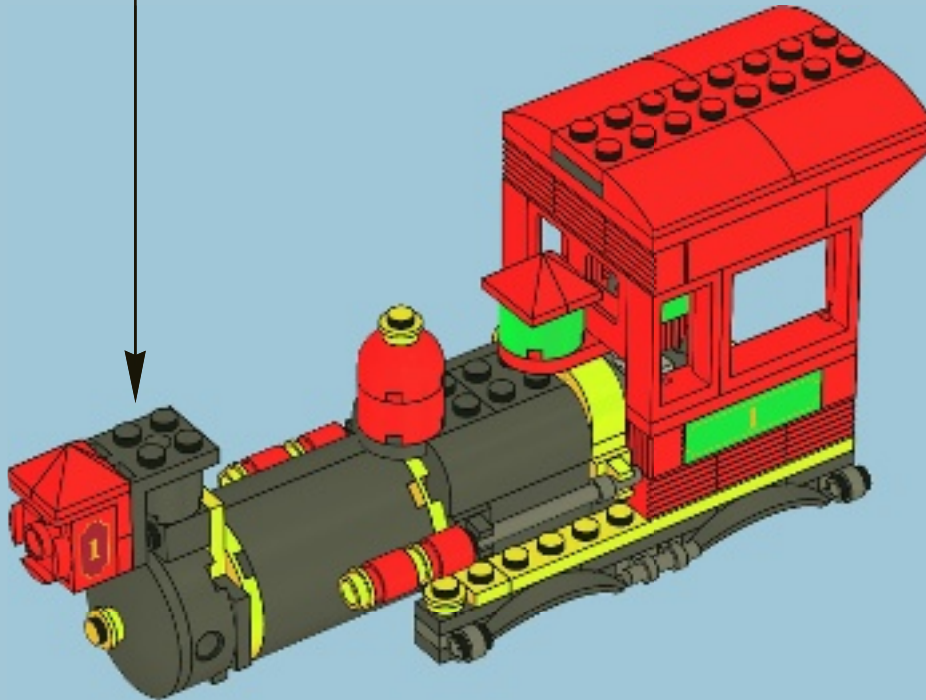
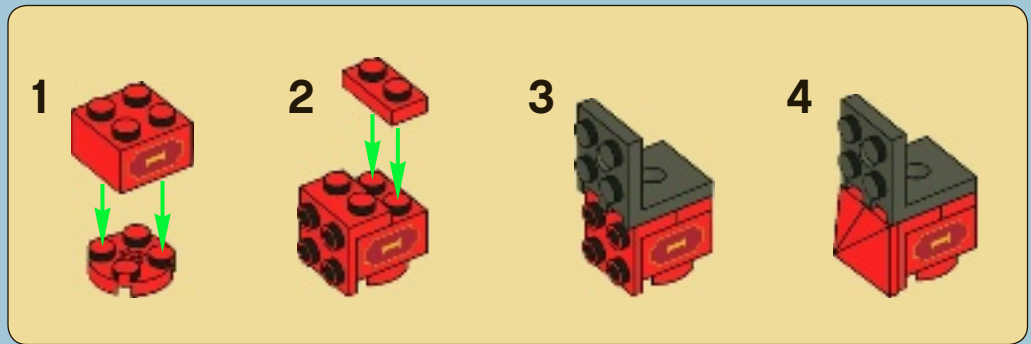



1x



1x

32

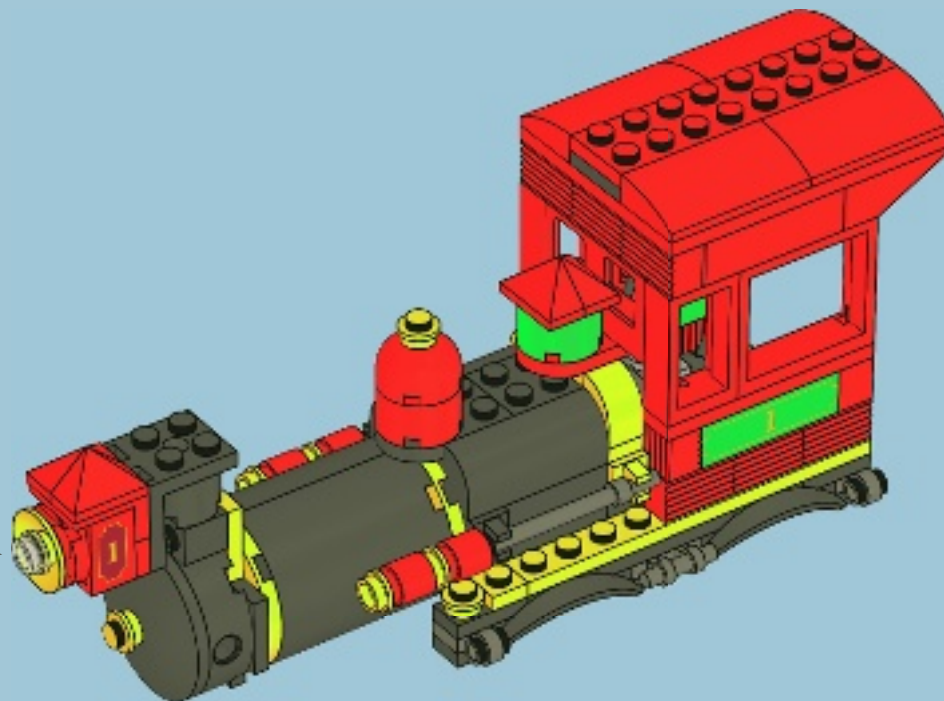



2x

33

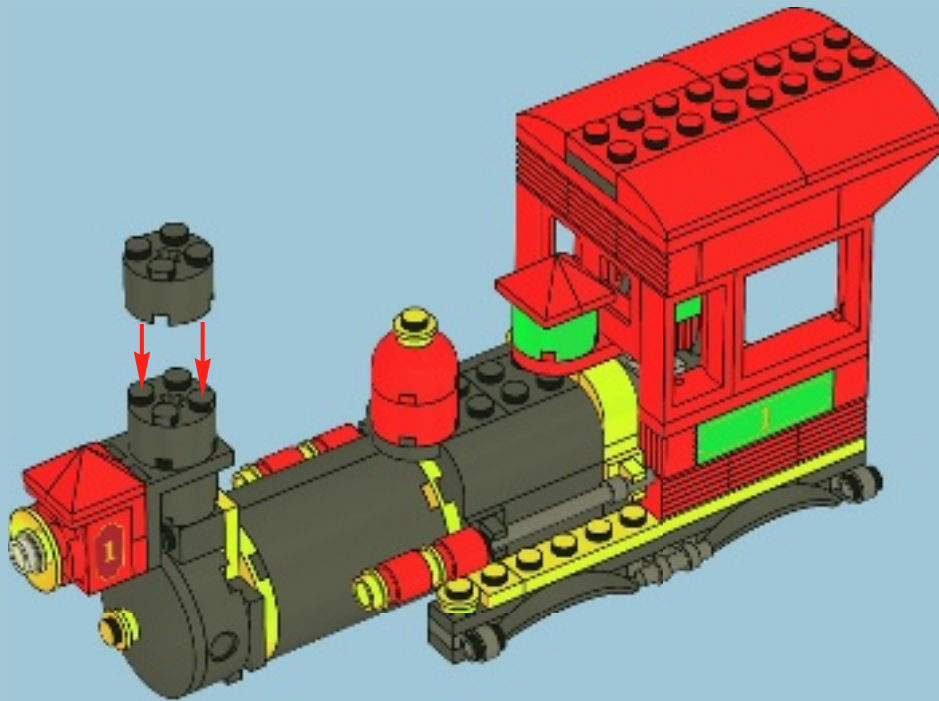



1x

34

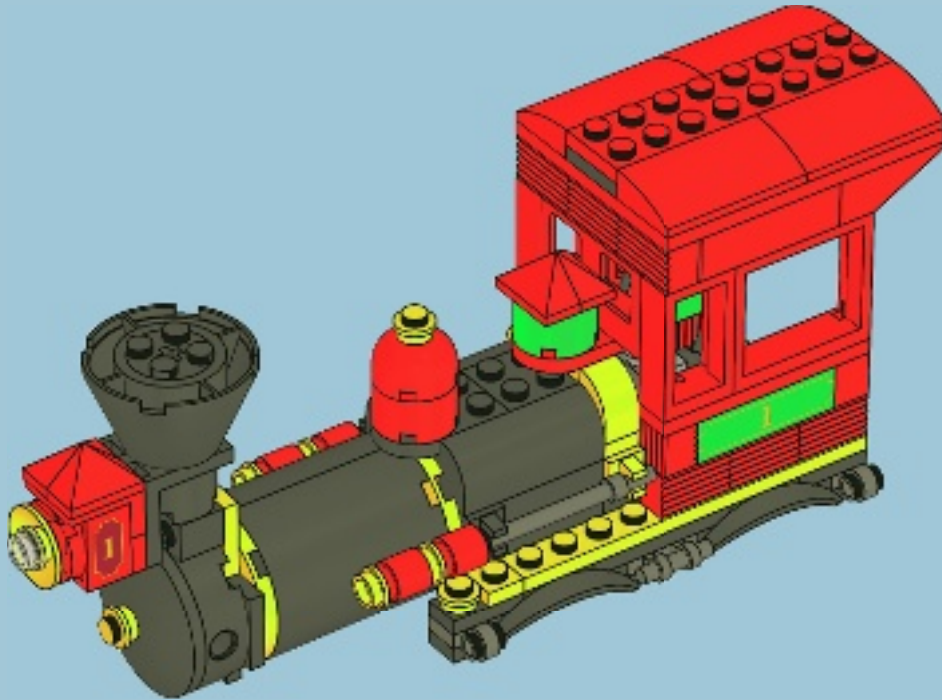



1x



4x

35

1



2

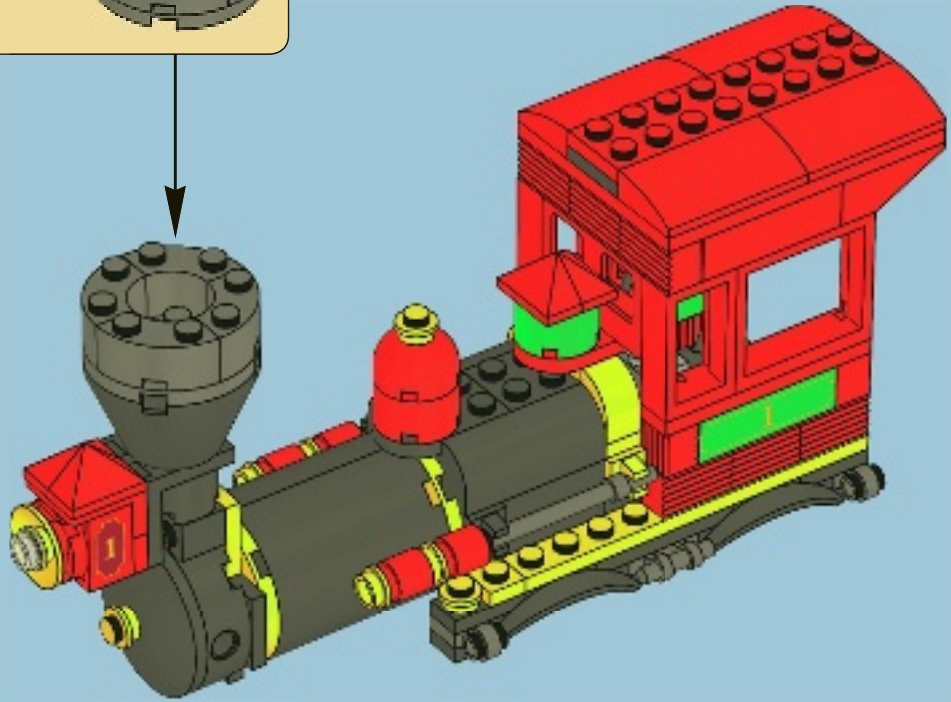
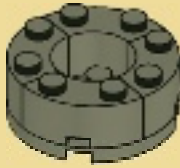

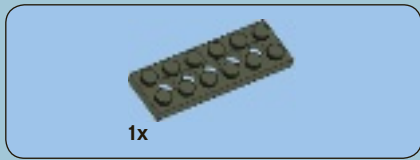

36

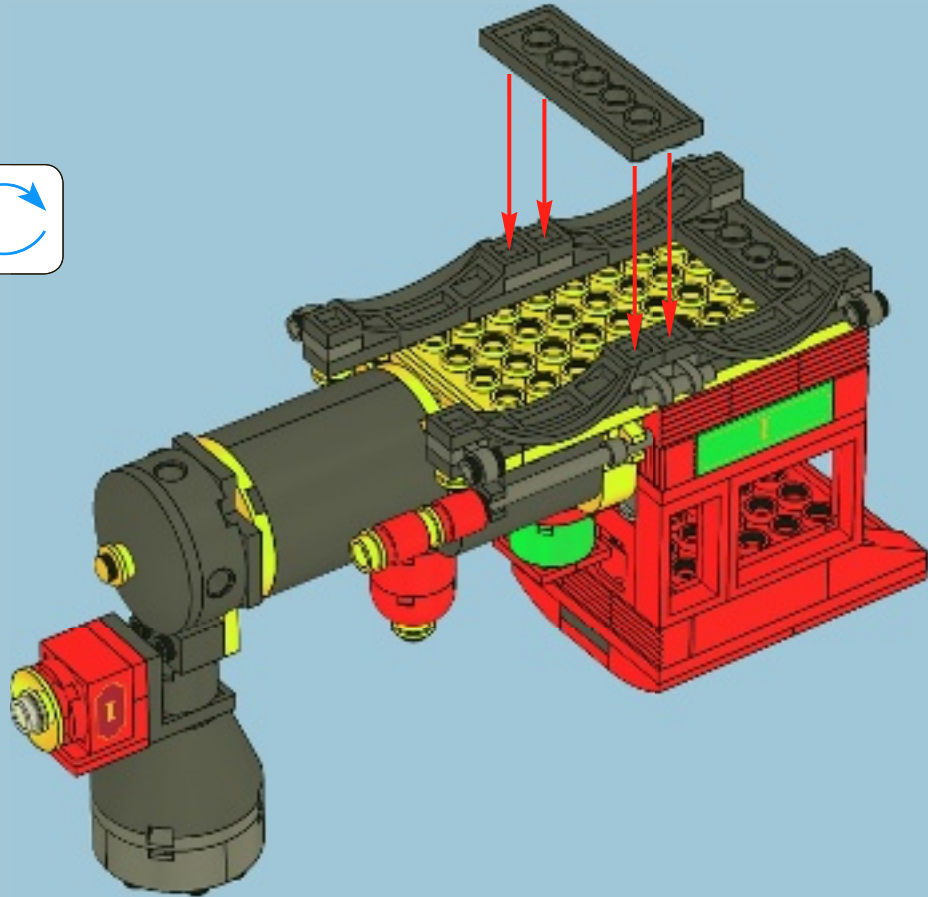
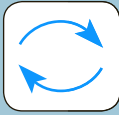

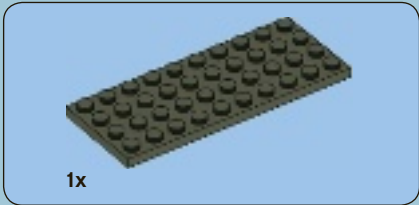

1

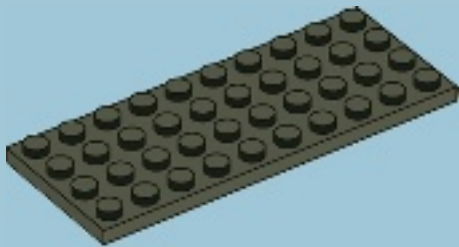

2

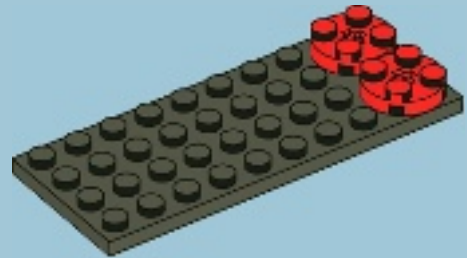



1x



2x

3

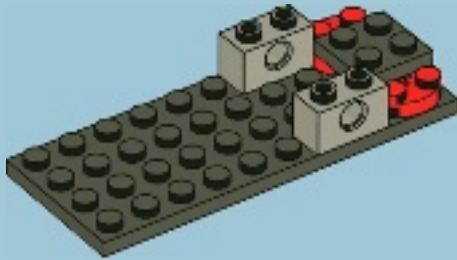

2x

4





2x



2x

5

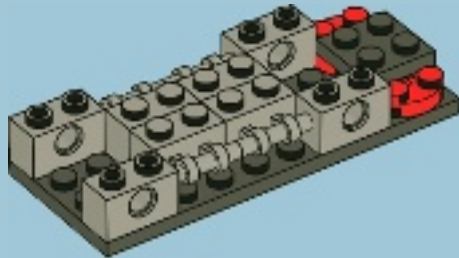

1x



1x

6

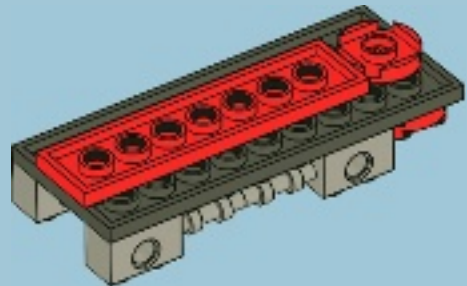
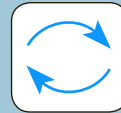

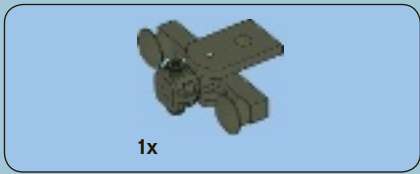

7

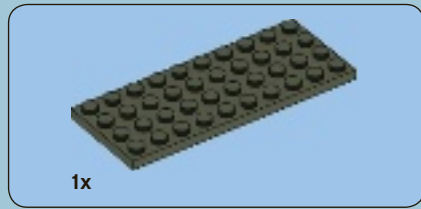
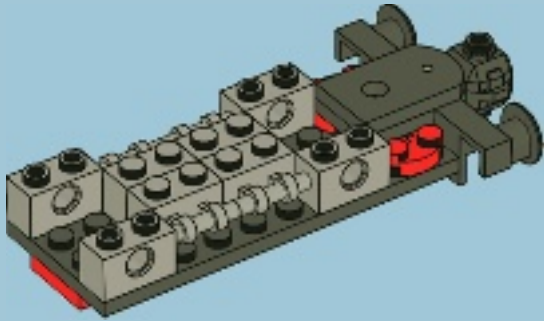

8

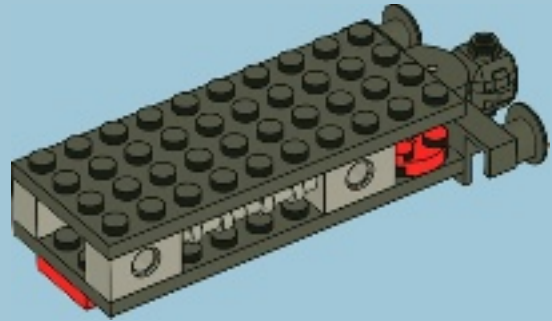



9

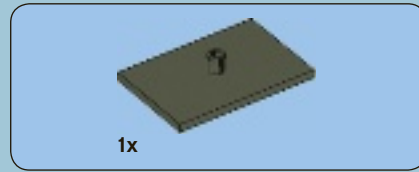
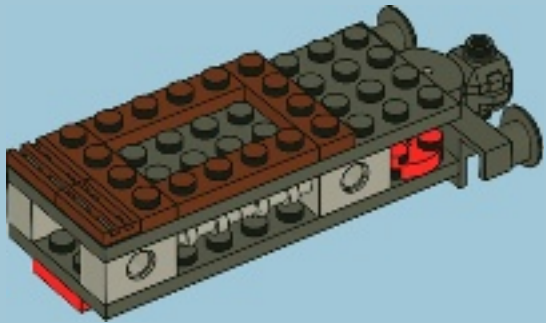

10

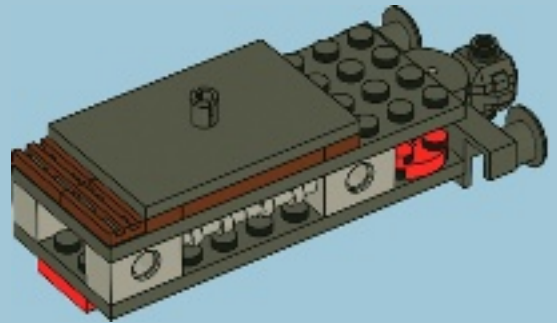



11

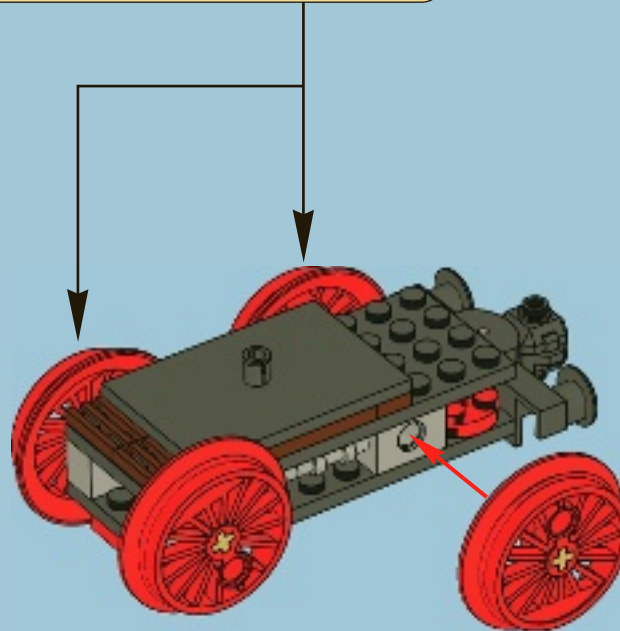
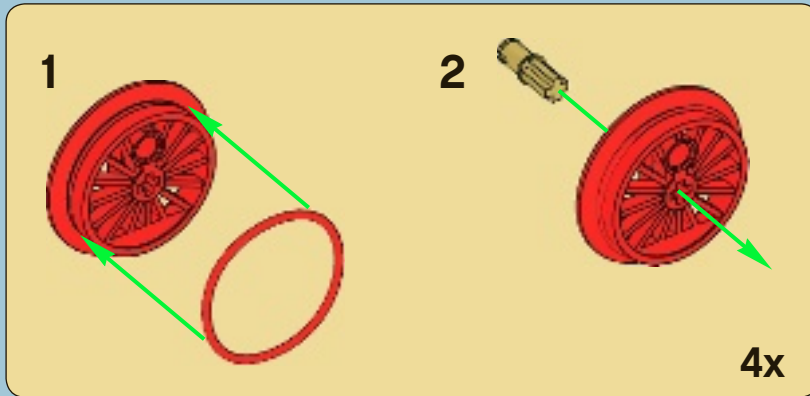

37

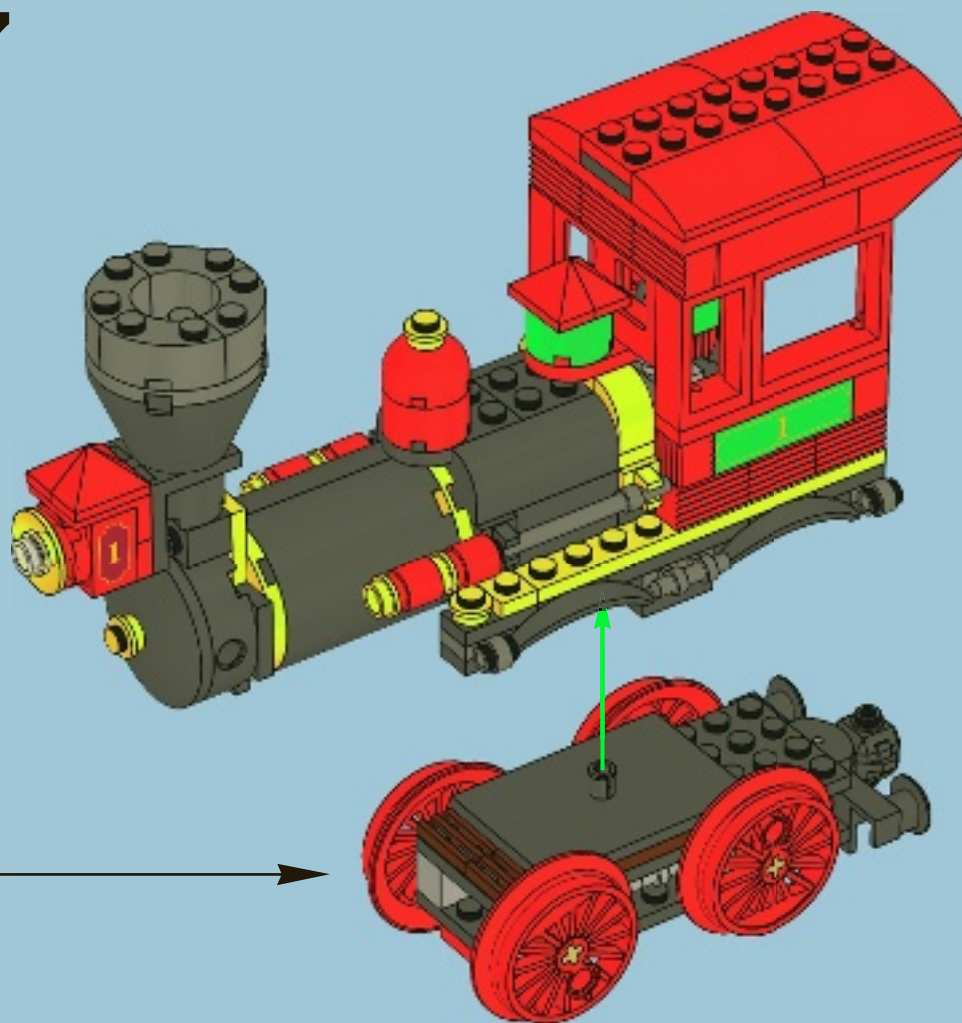



1

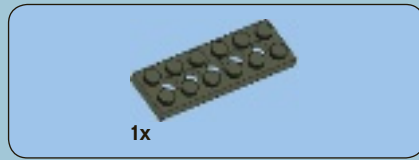
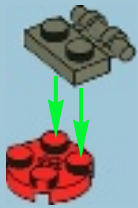

2

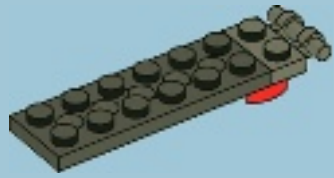



3

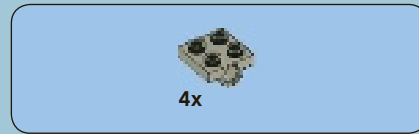
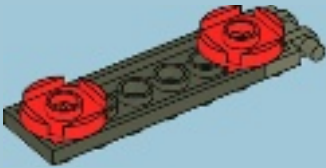

4

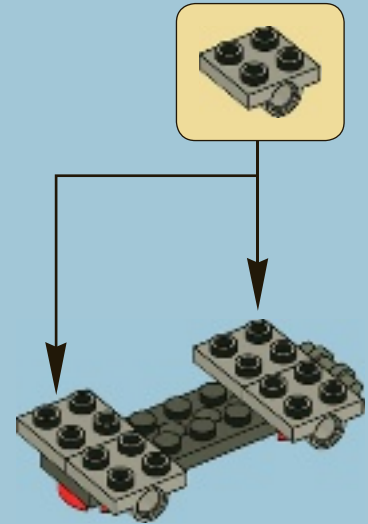
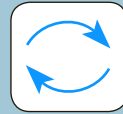



5

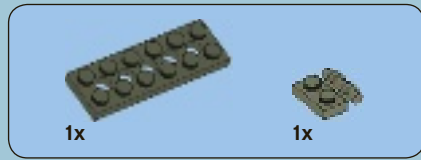
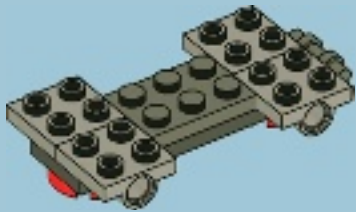

6

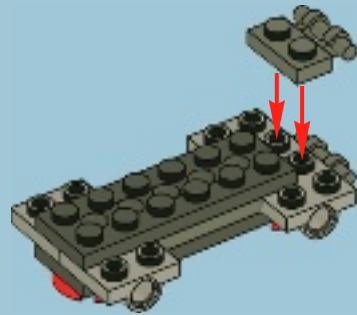



8x

7

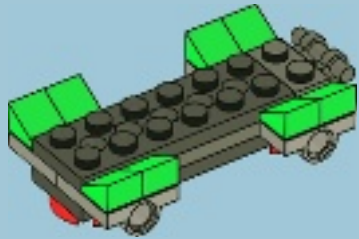

2x

8

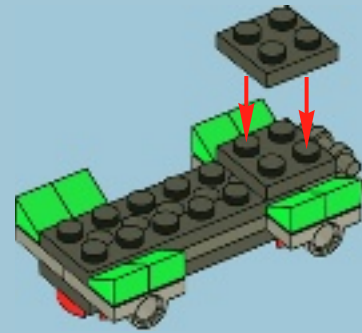



1x

9

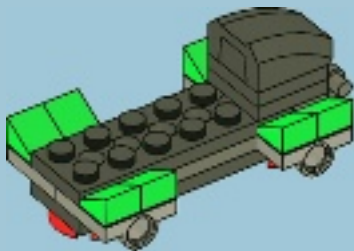

1x



1x



1x



1x

10

1

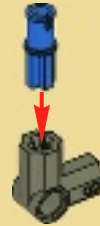

2

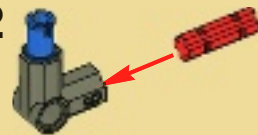

3

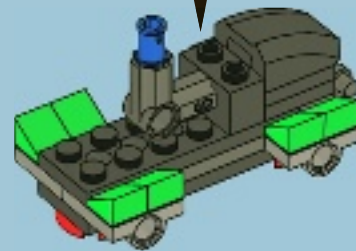



1x

11

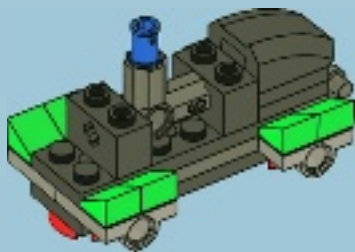

2x



1x

12

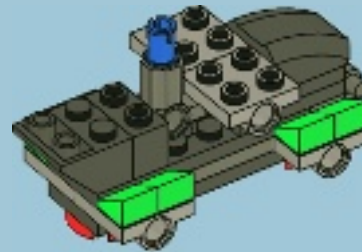



1x



1x

13

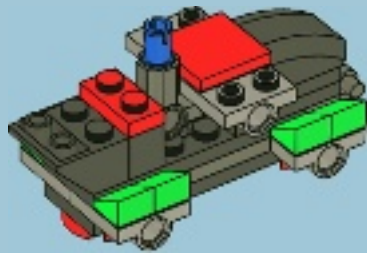

4x

14

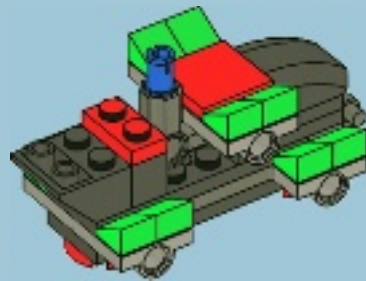

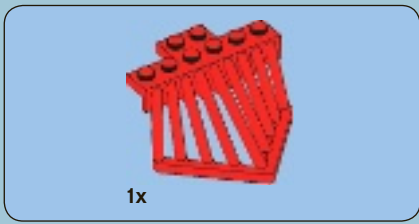

15

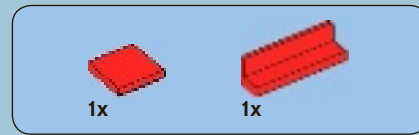
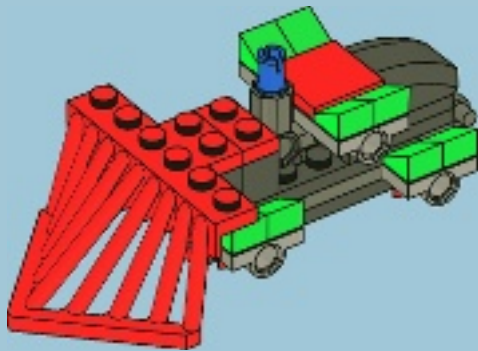

16

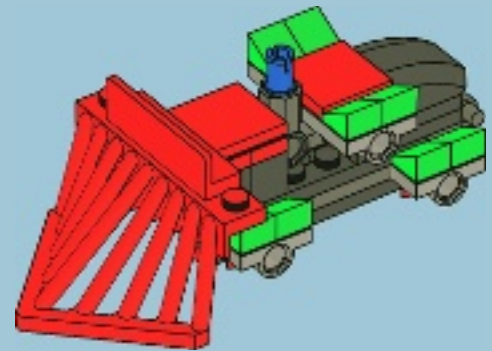



2x

17

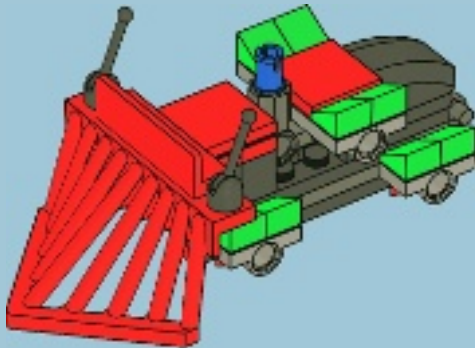

4x



4x

18

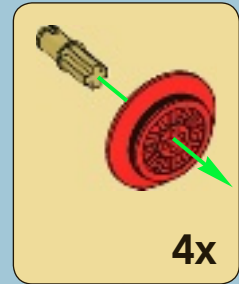

4x

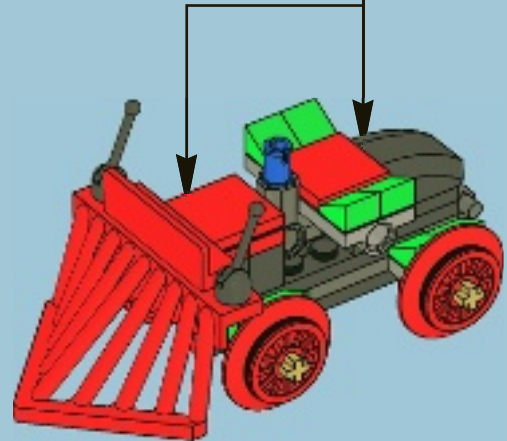



19

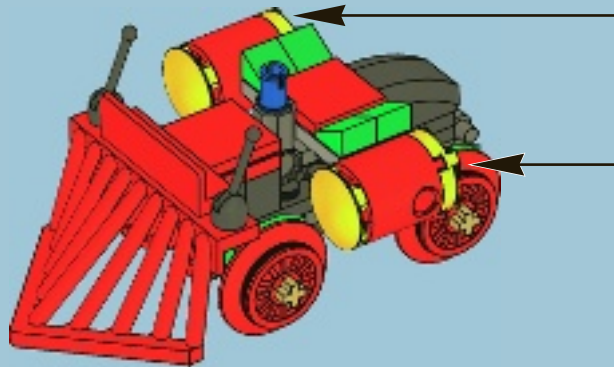

38

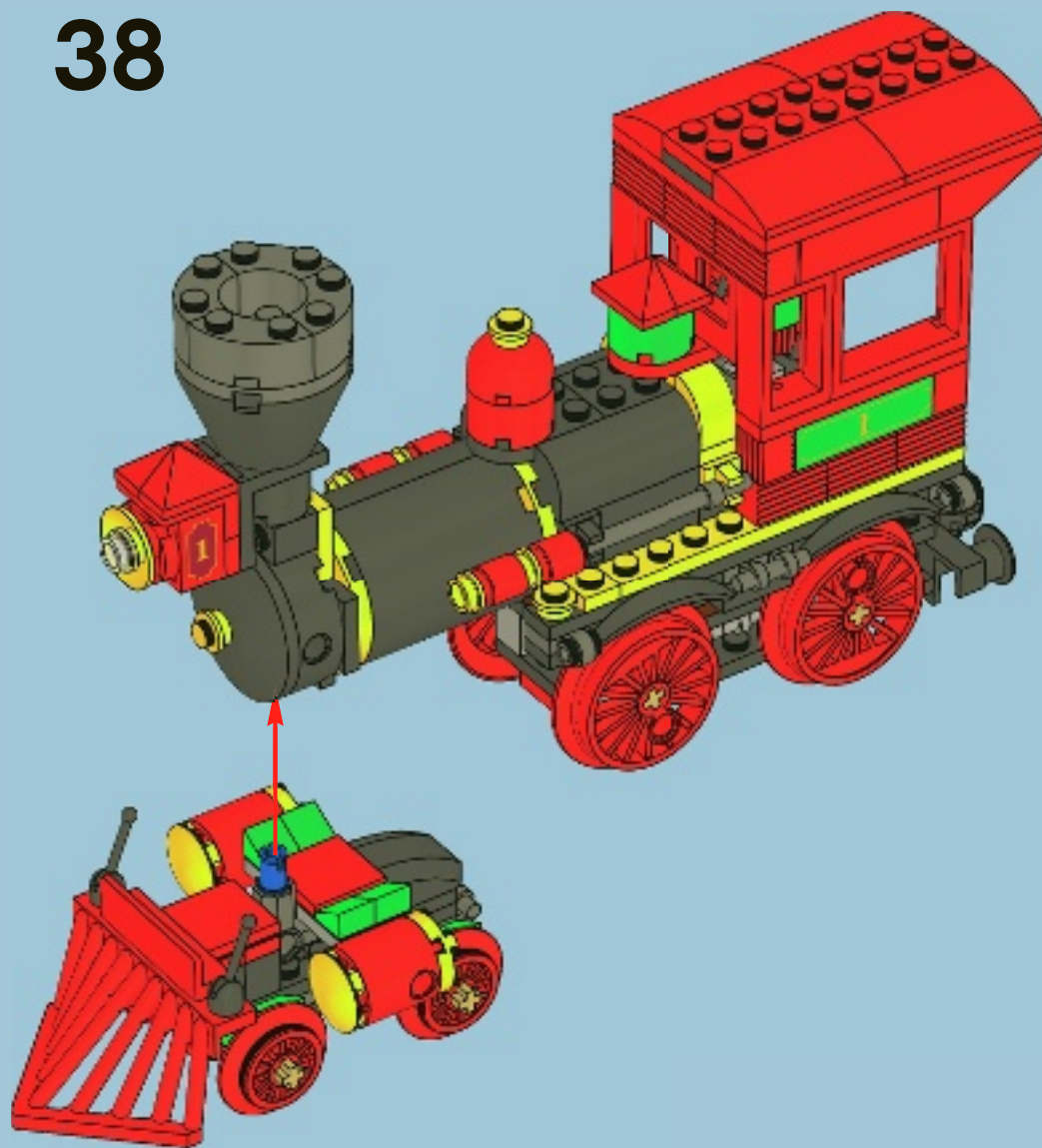



1x

1x

39

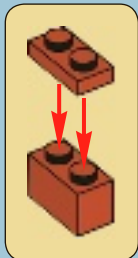

1



2

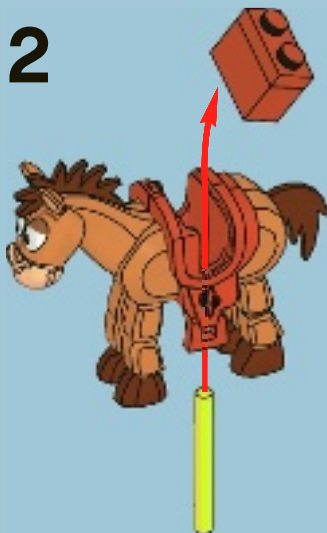

3





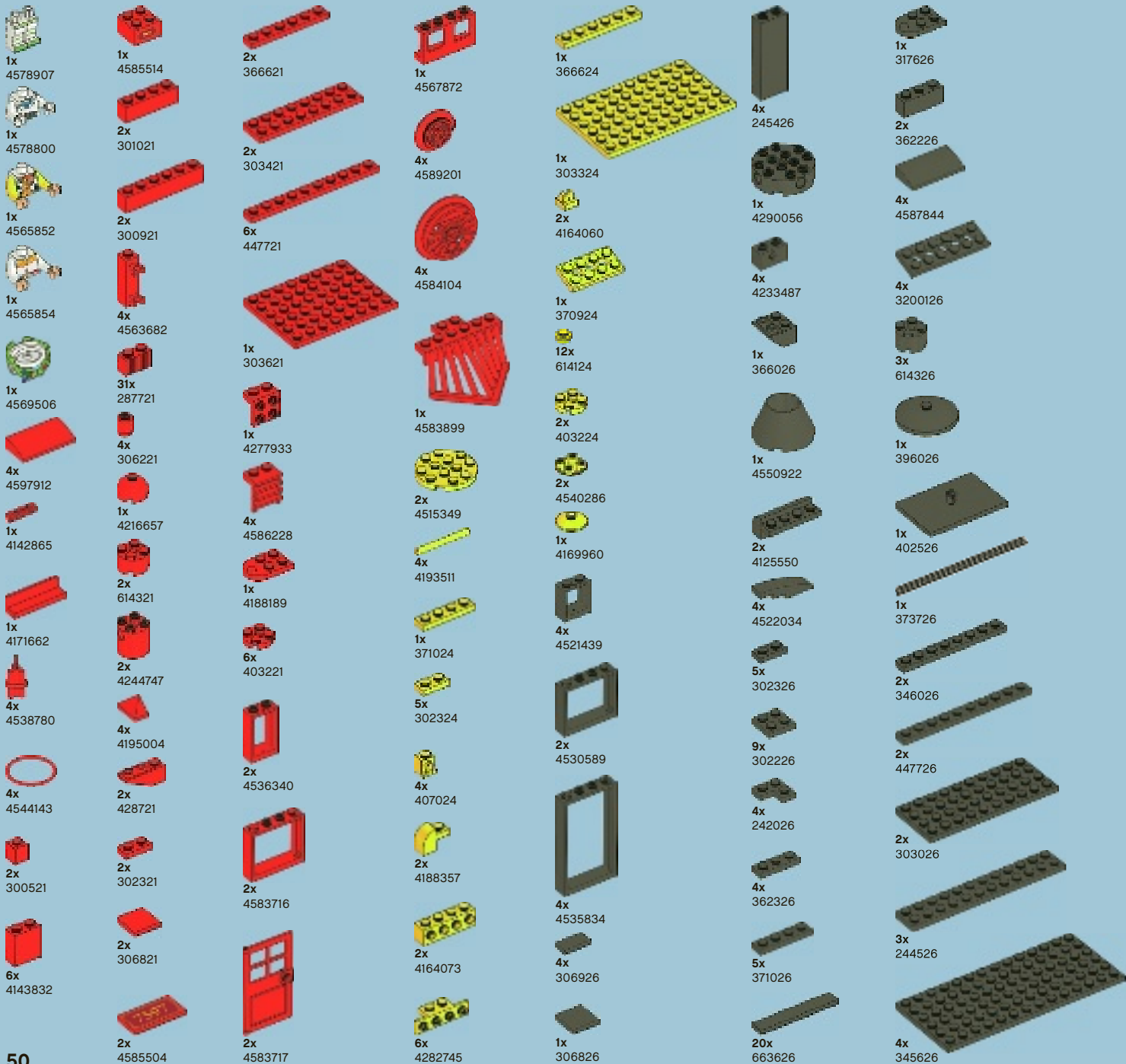



Customer Service
Kundenservice
Service Consommateurs
Servicio Al Consumidor

www.lego.com/service or dial



: 00800 5346 5555
 : 1-800-422-5346



Disney · PIXAR
TOY
STORY



7596



7789





7590



7593



7594



7592

LEGO

CITY



7241



7942



7239



7207



7208

FREE! GRATIS! GRATUIT!



club
MAGAZINE™

www.LEGOclub.com



00800 5346 5555*

1-866-534-6258 • 1-877-518-5346

US & Canada only

Canada seule ment



VISIT THE WORLD'S
BIGGEST LEGO® SHOP!

www.LEGOshop.com

* Freephone. Mobile charges may apply. * Numéro sans Frais. Des Frais peuvent s'appliquer avec les téléphones cellulaires. * Gebührenfrei, Kosten für Anrufe aus Mobilfunknetzen können abweichen.
* Gratis telefonnummer vanaf vaste lijn. * Det er ett gratis nummer, när du ringer från Fasttelefon. * Det är gratis, när du ringer från en Fast telefon.



WIN!

Go to www.nielsen.com/LEGO to fill out a survey for a chance to win a cool LEGO® Product.

No purchase necessary.

Open to all residents where not prohibited.



www.LEGO.com

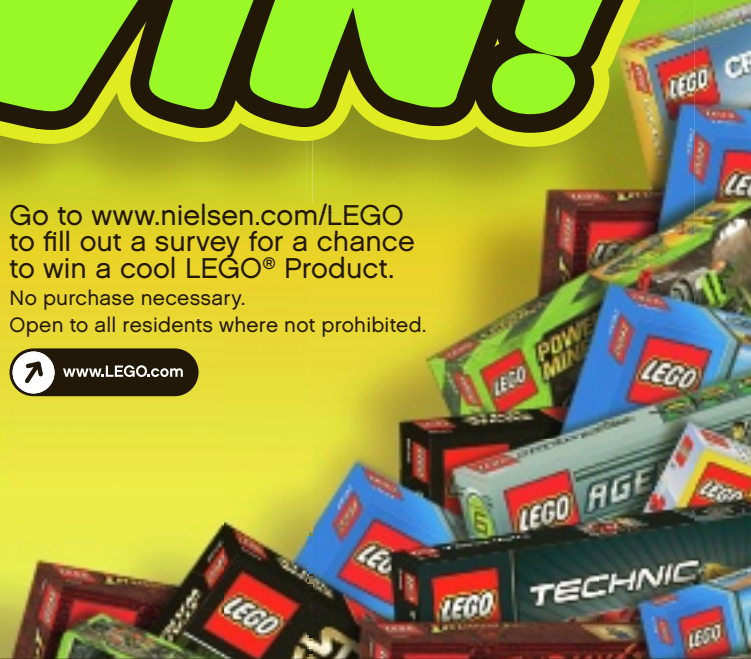

www.nielsen.com/LEGO

GEWINNE! WIN!

Nimm an der Umfrage auf www.nielsen.com/LEGO teil und hab die Chance ein cooles LEGO® Produkt zu gewinnen!

Die Teilnahme am Gewinnspiel führt zu keinerlei Kaufverpflichtungen. Teilnahme in allen nicht ausgeschlossenen Ländern möglich.

Ga naar www.nielsen.com/LEGO, vul een enquêteformulier in en maak kans op een cool LEGO® product.

Geen aankoopverplichting. Iedereen mag deelnemen, uitgezonderd ingezetenden van landen waar een enquêteverbod geldt.

GAGNE! 当てよう!

Visite www.nielsen.com/LEGO pour répondre à un questionnaire et avoir une chance de gagner un produit LEGO® très cool!

Aucune obligation d'achat. Ouvert à tous les résidents des pays autorisés.

www.nielsen.com/LEGOにアクセスして、アンケートにご記入ください。当選者にはレゴ製品を差し上げます。

お買い上げの必要はありません。

禁止されていない限り、すべての皆様にご利用いただけます。