



DC UNIVERSE™
**SUPER
HEROES**

76001



THE DARK KNIGHT RISES™

1



2



3



4



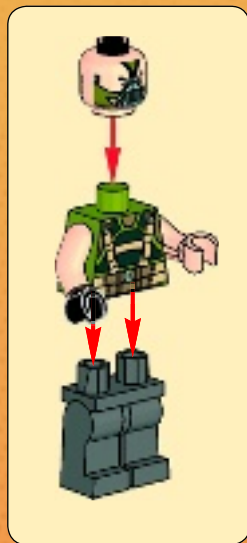

L'ASCENSION DU CHEVALIER NOIR™ EL CABALLERO DE LA NOCHE ASCIENDE™

BATMAN

EL CABALLERO DE LA NOCHE ASCIENDE™

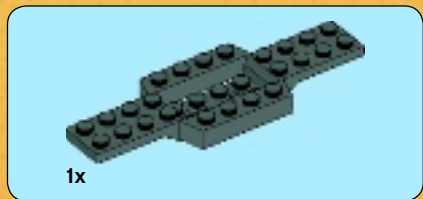

1

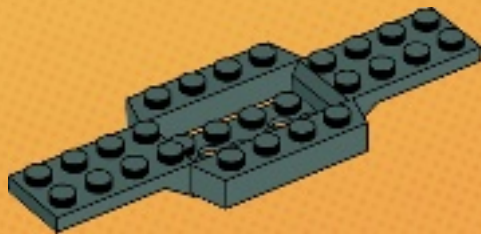

1x



1x



2

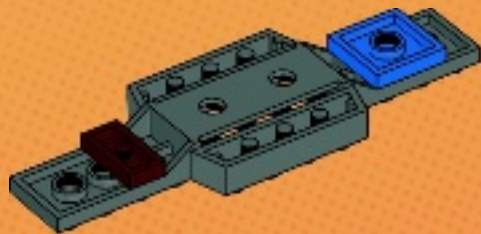

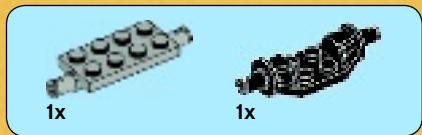

3

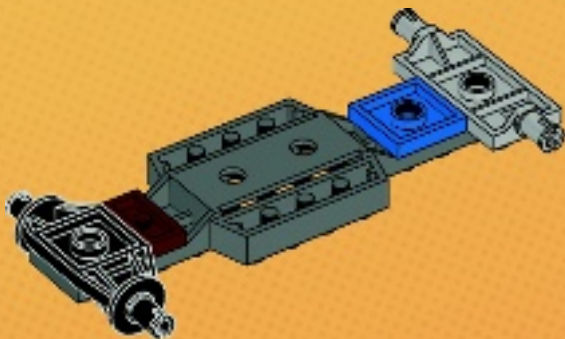



4x

4

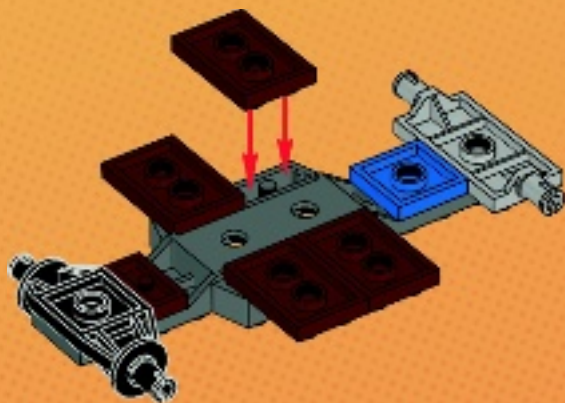



1x

5

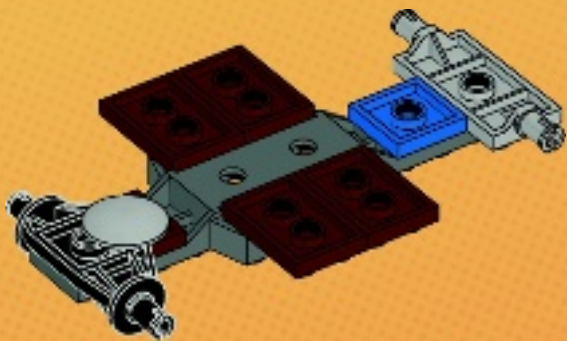

8



2x

6

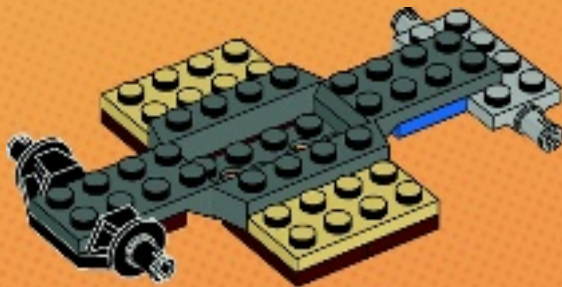



1x



3x

7

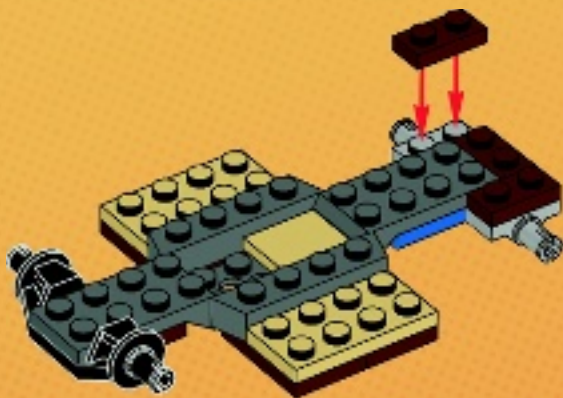



1x



1x

8

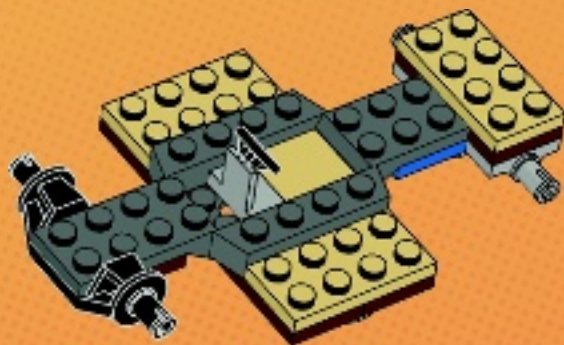



2x

9

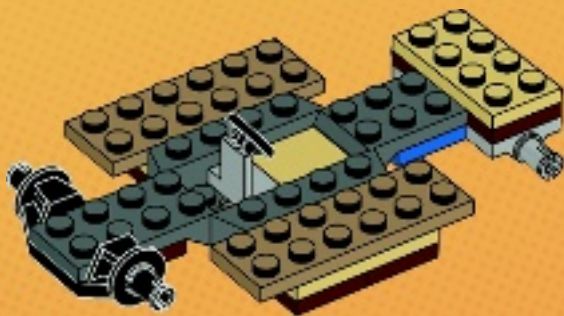

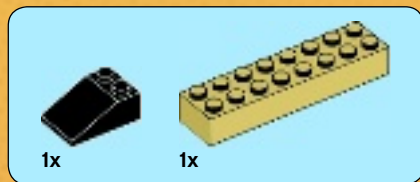

10

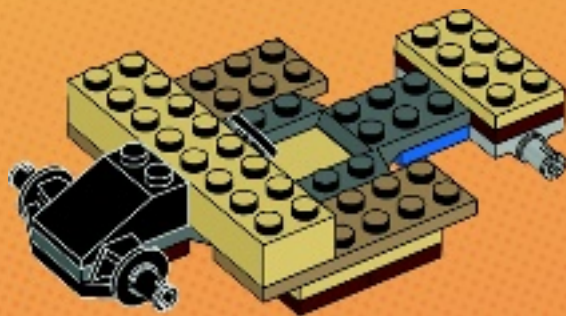



2x



1x

11

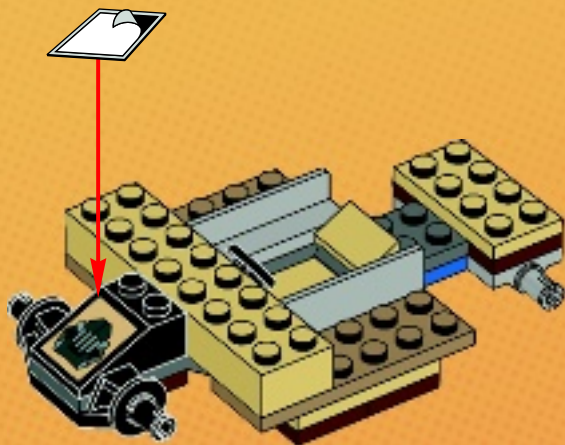

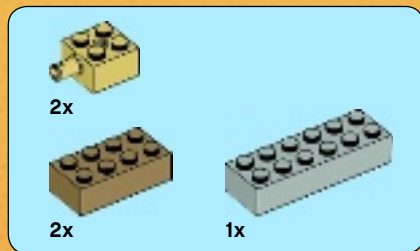

12

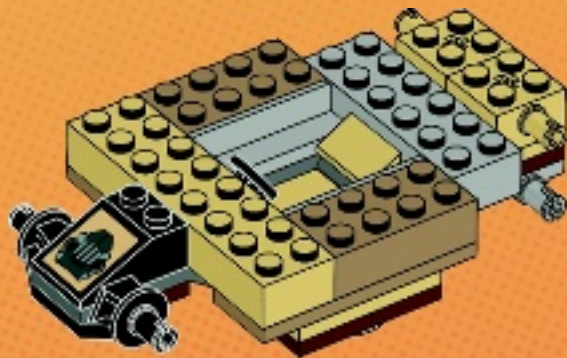



13

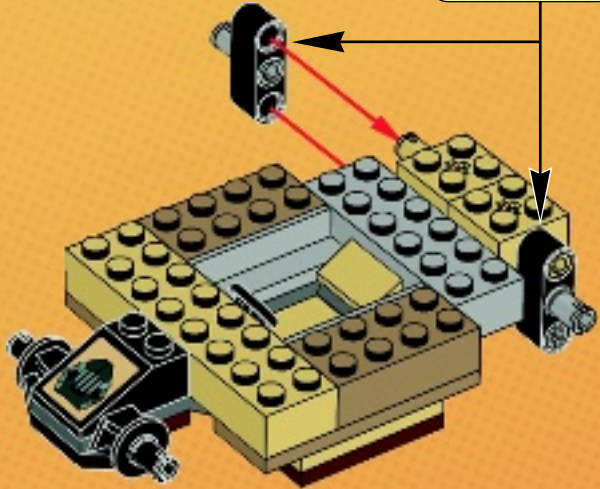
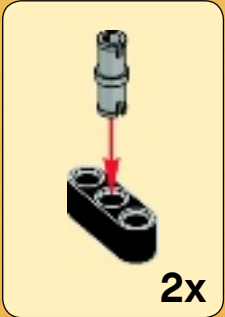



2x



1x

14

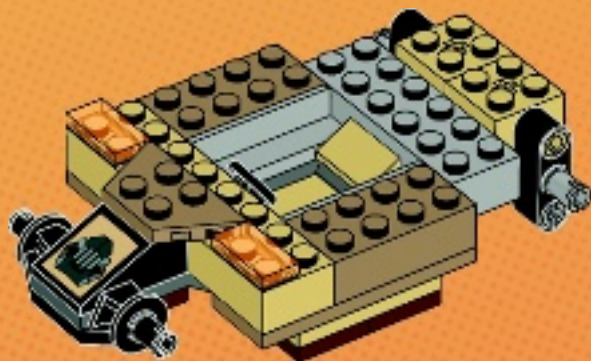



2x



1x

15

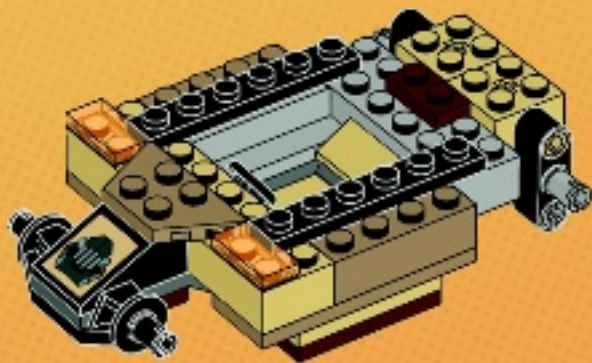



1x



6x

16

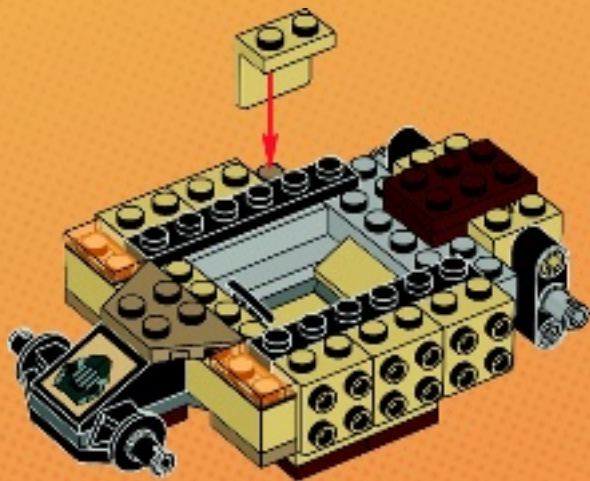



2x



2x

17

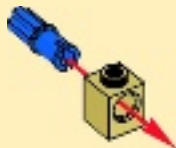

2x





1x



1x

18

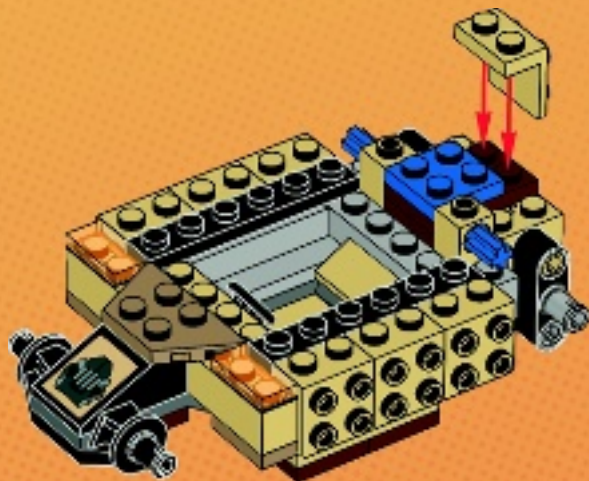



1x



1x

19

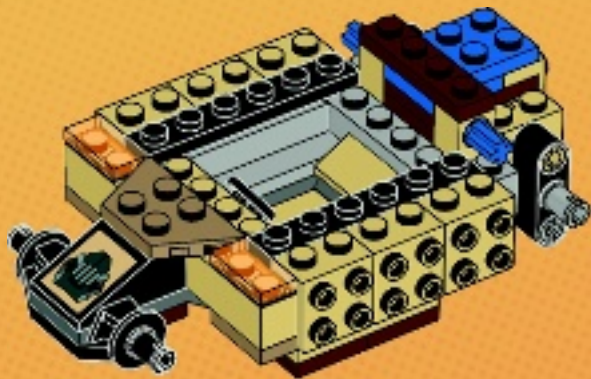



20



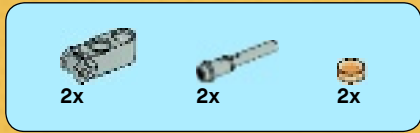

21

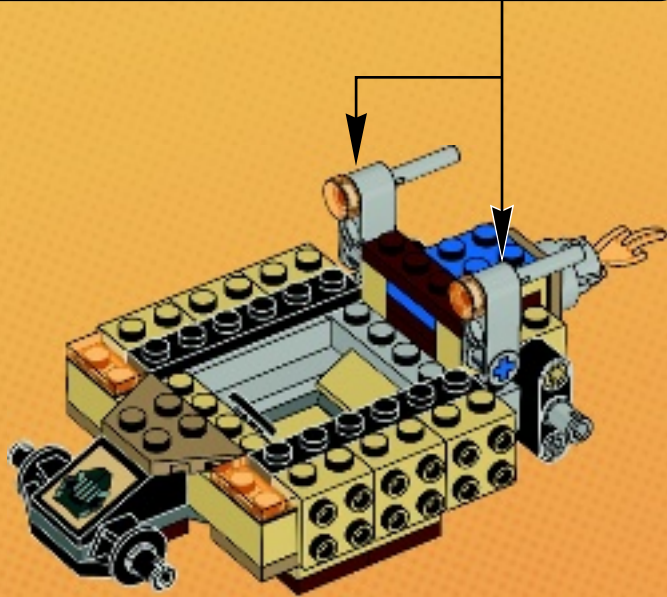
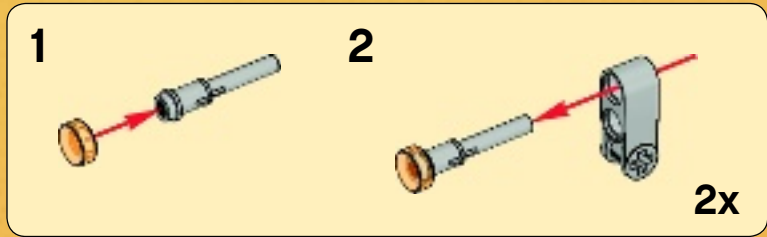



1x



2x

22

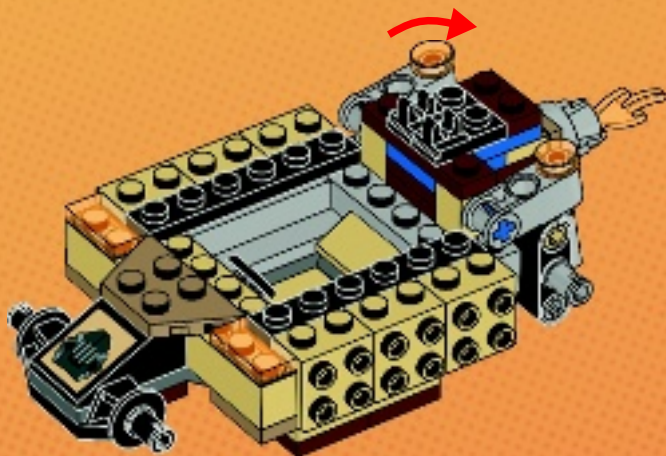



2x

23

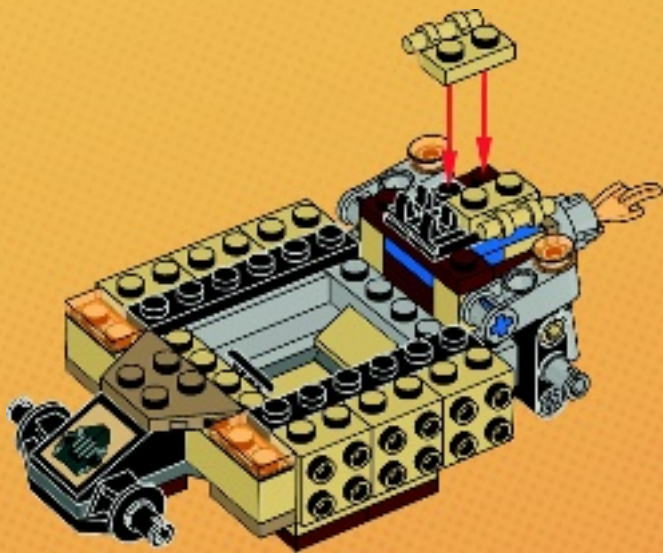



2x



2x

24

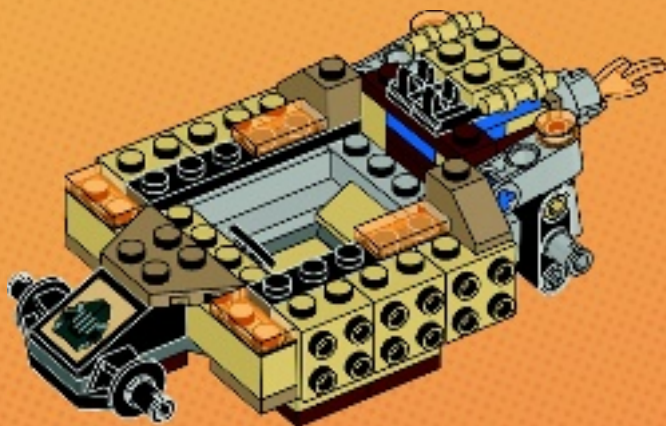



1x



2x

25

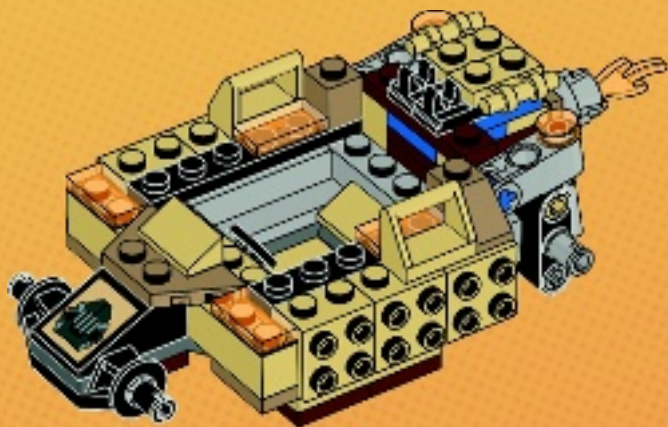



1x

26

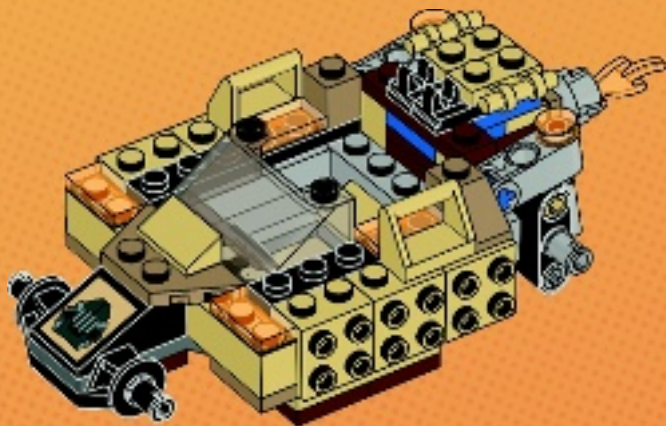



1x



1x

27

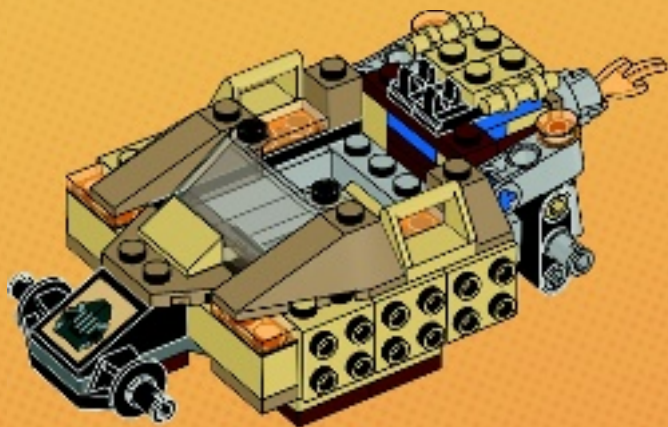



1x



3x

28

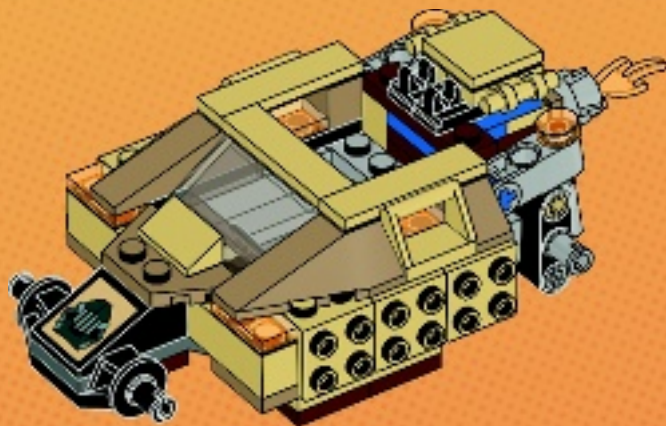

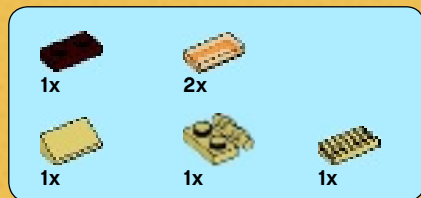

29





2x

30

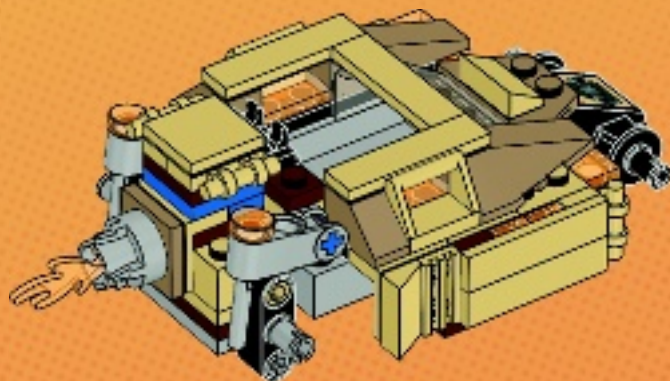

31

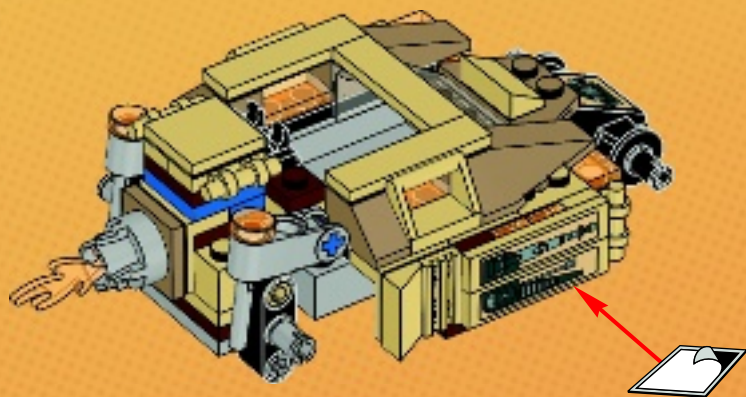

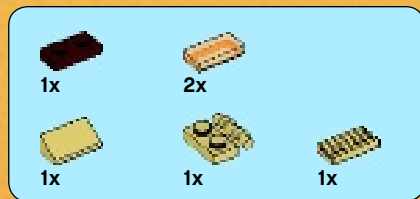

32





2x

33

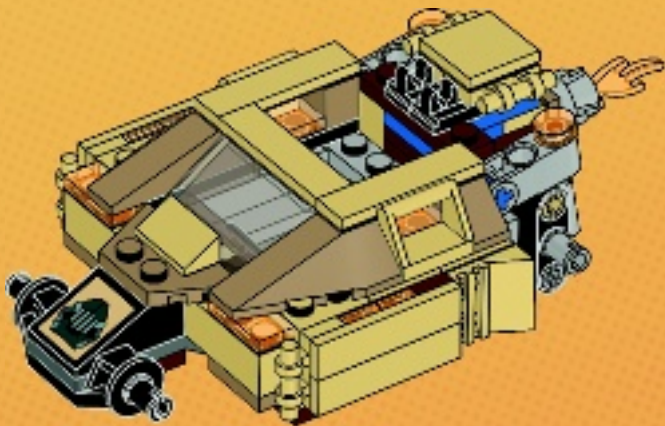

34

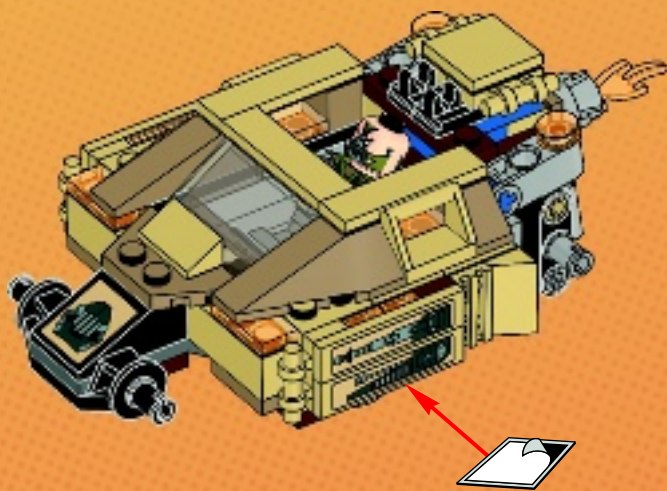

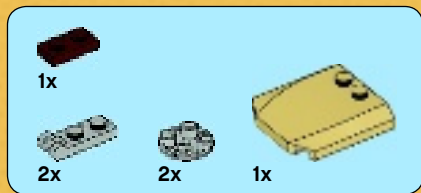

35

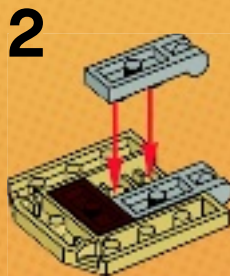
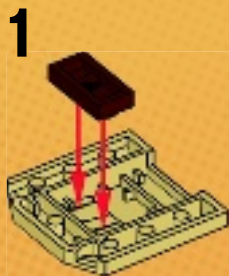

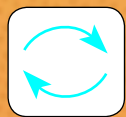

4

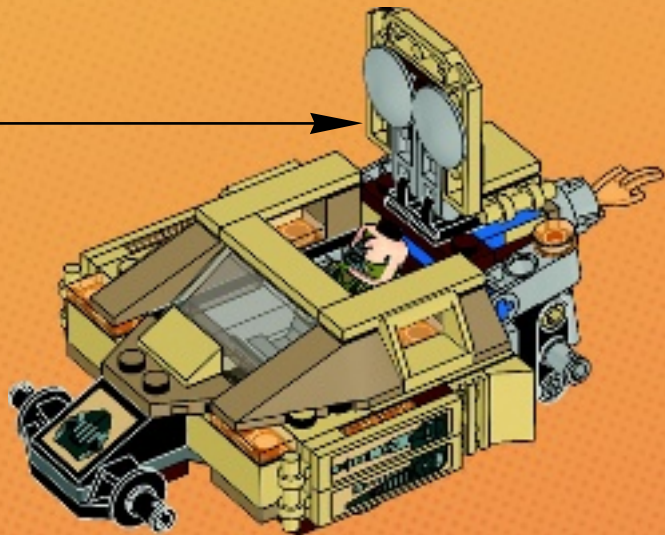
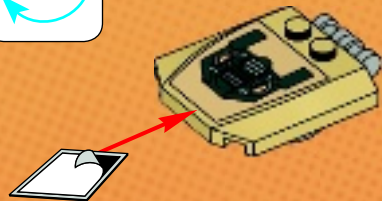



3x

36

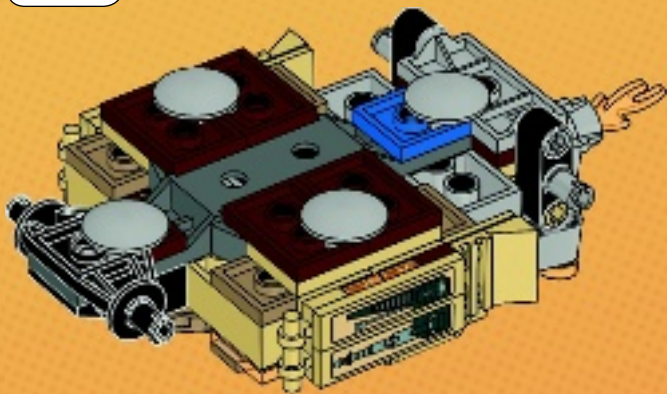



37

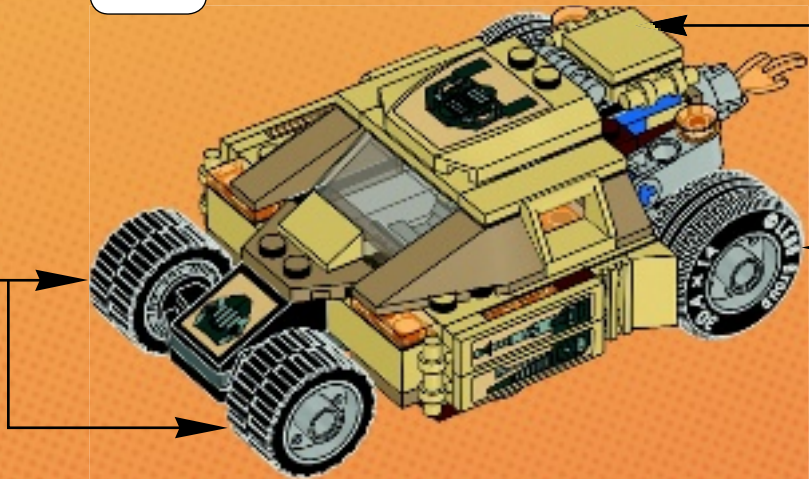
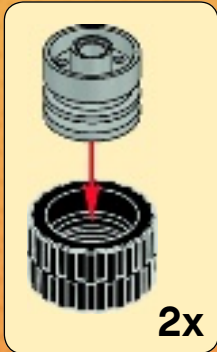
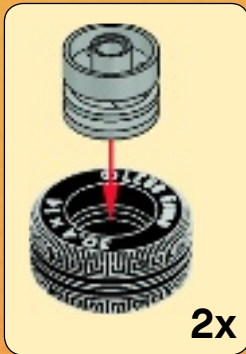



4x

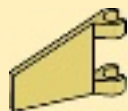

38

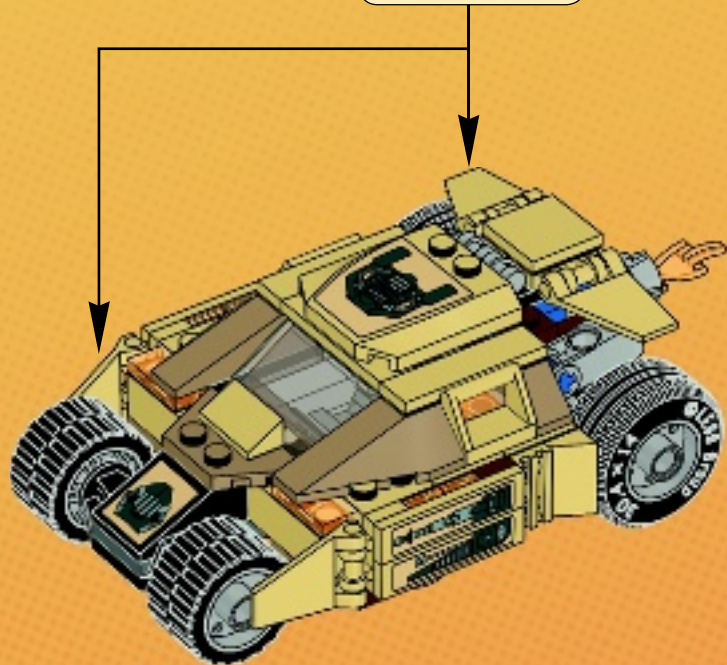

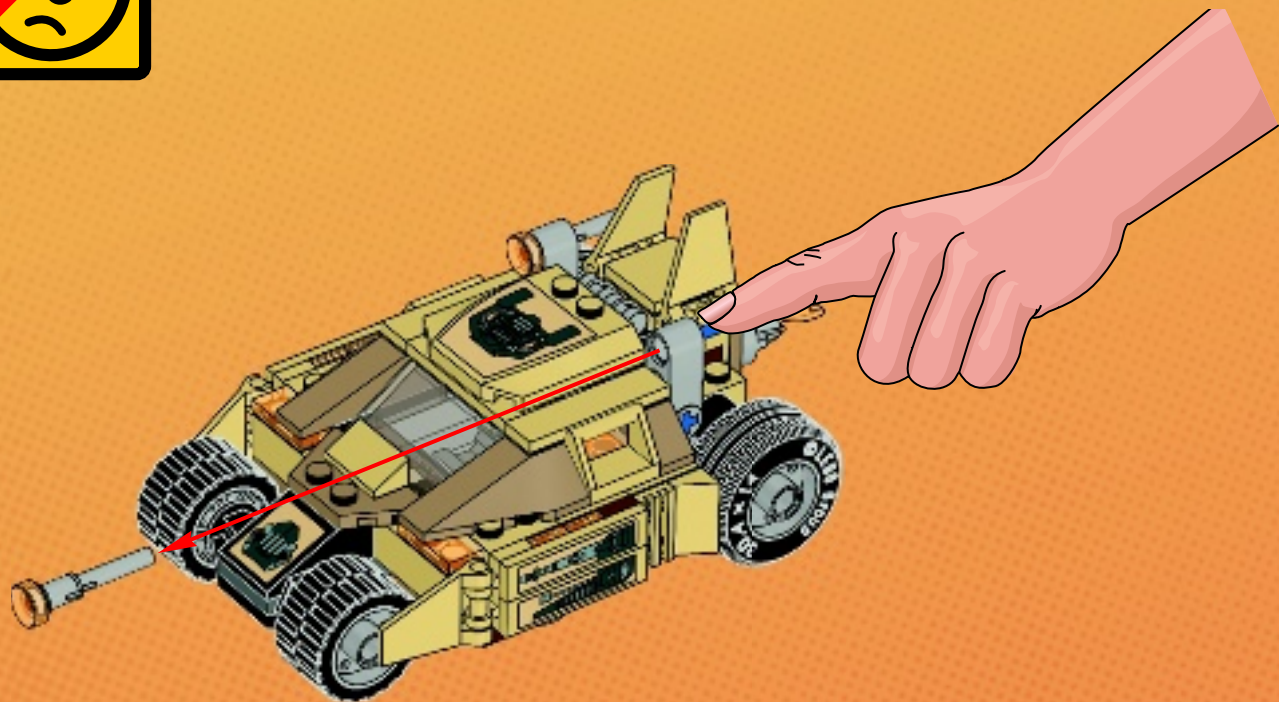



WIN!

Go to www.LEGOsurvey.com/product to fill out a survey for a chance to win a cool LEGO® Product.

No purchase necessary.

Open to all residents where not prohibited.



www.LEGOsurvey.com/product

GEWINNE!

Nimm an der Umfrage auf www.LEGOsurvey.com/product teil und hab die Chance ein cooles LEGO® Produkt zu gewinnen!

Die Teilnahme am Gewinnspiel führt zu keinerlei Kaufverpflichtungen. Teilnahme in allen nicht ausgeschlossenen Ländern möglich.

WIN!

Ga naar www.LEGOsurvey.com/product, vul een enquêteformulier in en maak kans op een cool LEGO® product.

Geen aankoopverplichting. Iedereen mag deelnemen, uitgezonderd ingezetenden van landen waar een enquêteverbod geldt.

GAGNE!

Visite www.LEGOsurvey.com/product pour répondre à un questionnaire et avoir une chance de gagner un produit LEGO® très cool!

Aucune obligation d'achat. Ouvert à tous les résidents des pays autorisés.

当てよう!

www.LEGOsurvey.com/product にアクセスして、アンケートにご記入ください。当選者にはレゴ®製品を差し上げます。

お買い上げの必要はありません。禁止されていない限り、すべての皆様にご利用いただけます。



WB SHIELD: TM & © Warner Bros. Entertainment Inc. (s13)

LEGO and the LEGO logo are trademarks of the/son des marques de commerce de/son marcas registradas de LEGO Group. ©2013 The LEGO Group.

6035642 / 6035647