



DC UNIVERSE™

SUPER HEROES



76002



© 2011 DC ENTERTAINMENT™

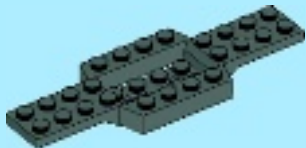

1x

1

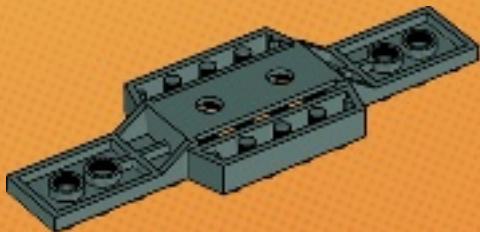

2



2x



1x

2

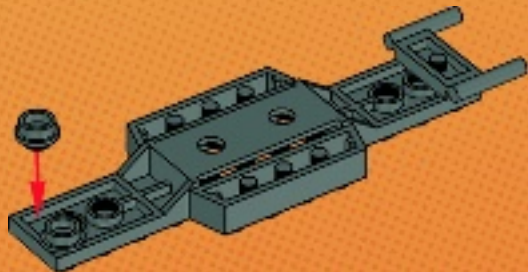



4x

3

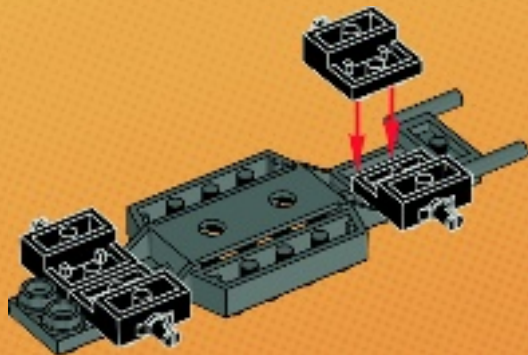

4



2x

4

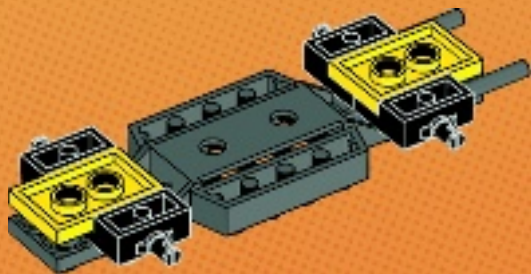



1x



1x

5

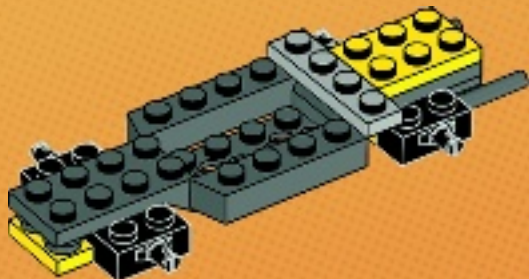

6



4x

6

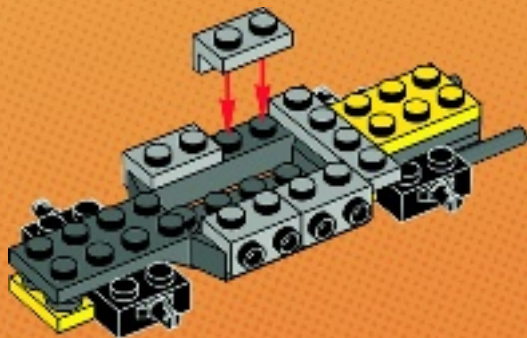



1x

7

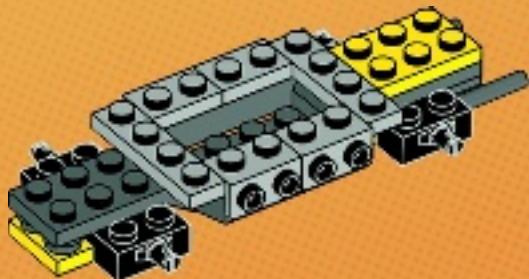

8



2x



1x

8

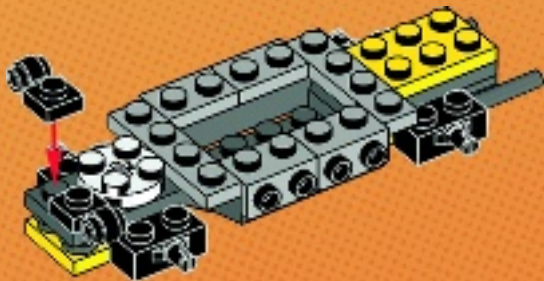



2x



1x

9

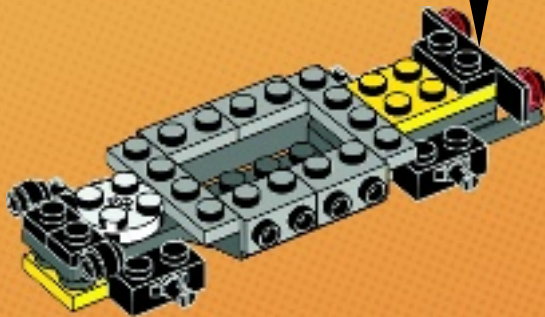
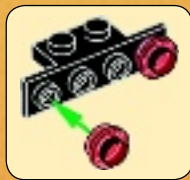



1x

10

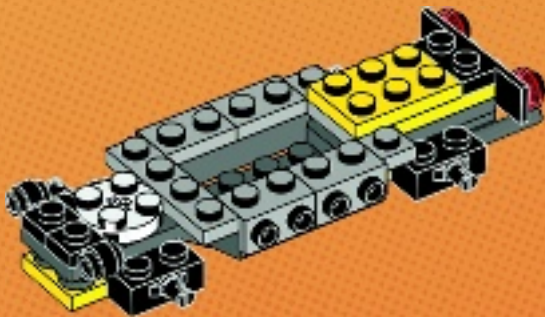



2x



1x

11

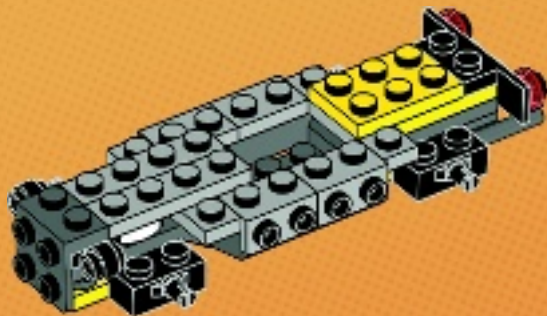



1x



2x

12

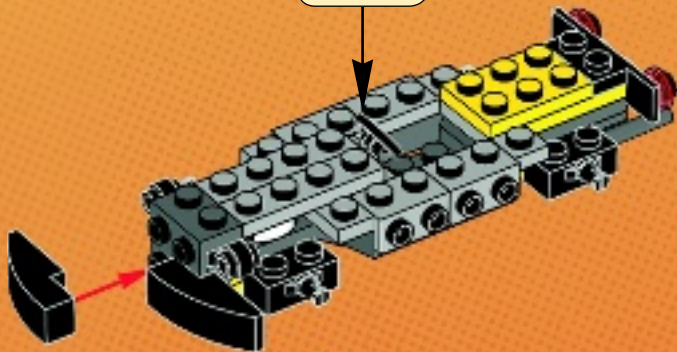



2x



1x

13

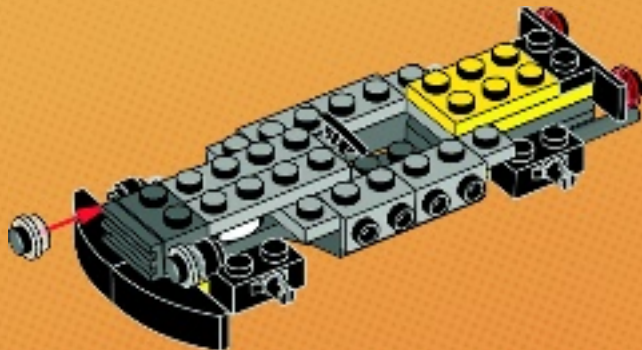



4x

14





4x



4x

15



4x

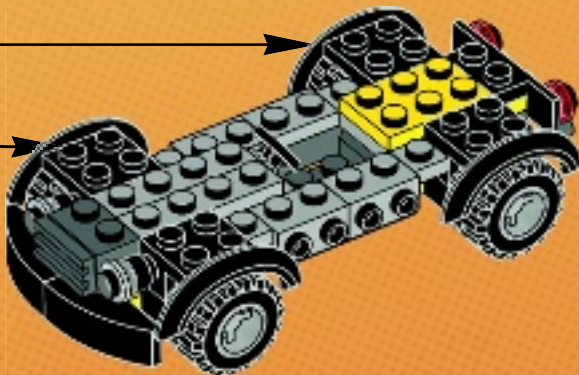



16

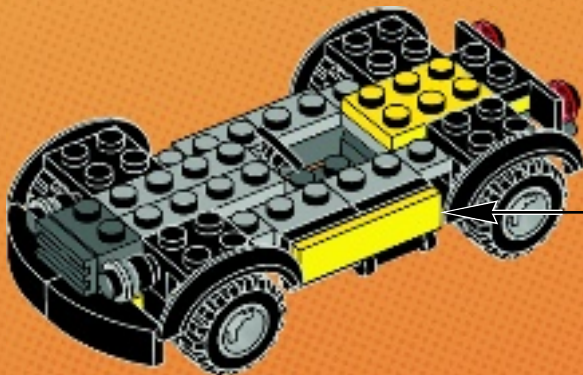
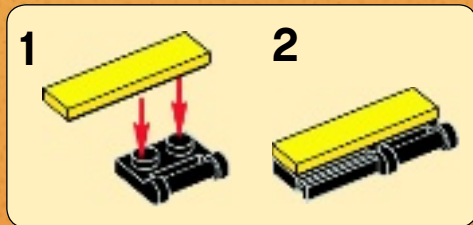



1x



1x



1x

17

1

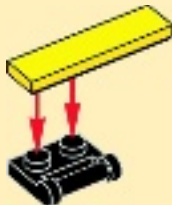

2

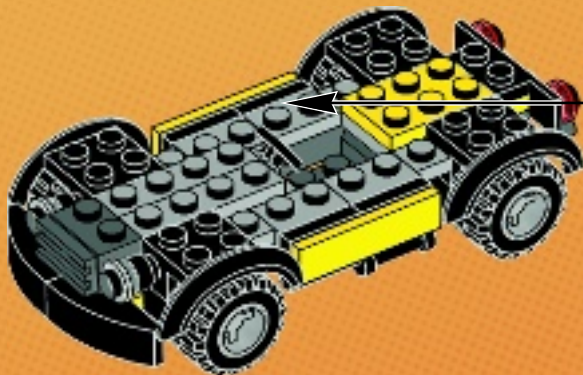
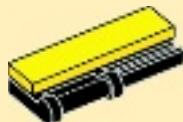



4x

18

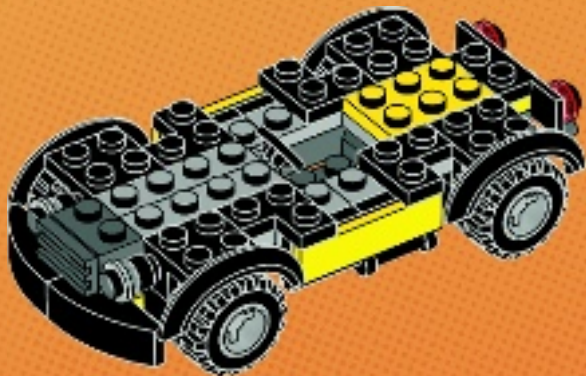



1x



2x

19

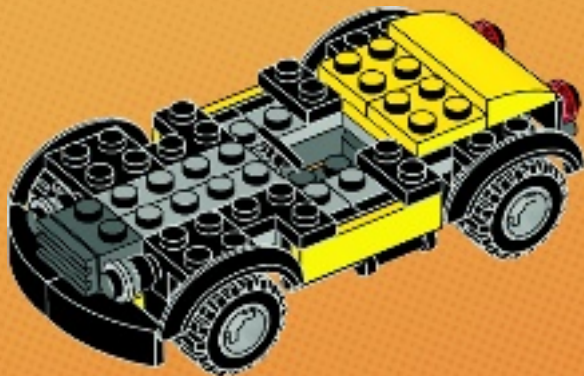



2x



2x

20





2x

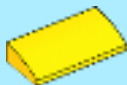

1x

21



22



1x



2x



2x

22

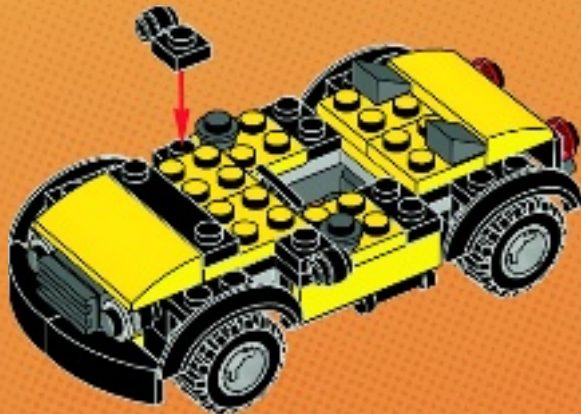



4x

23



24



1x

24



25

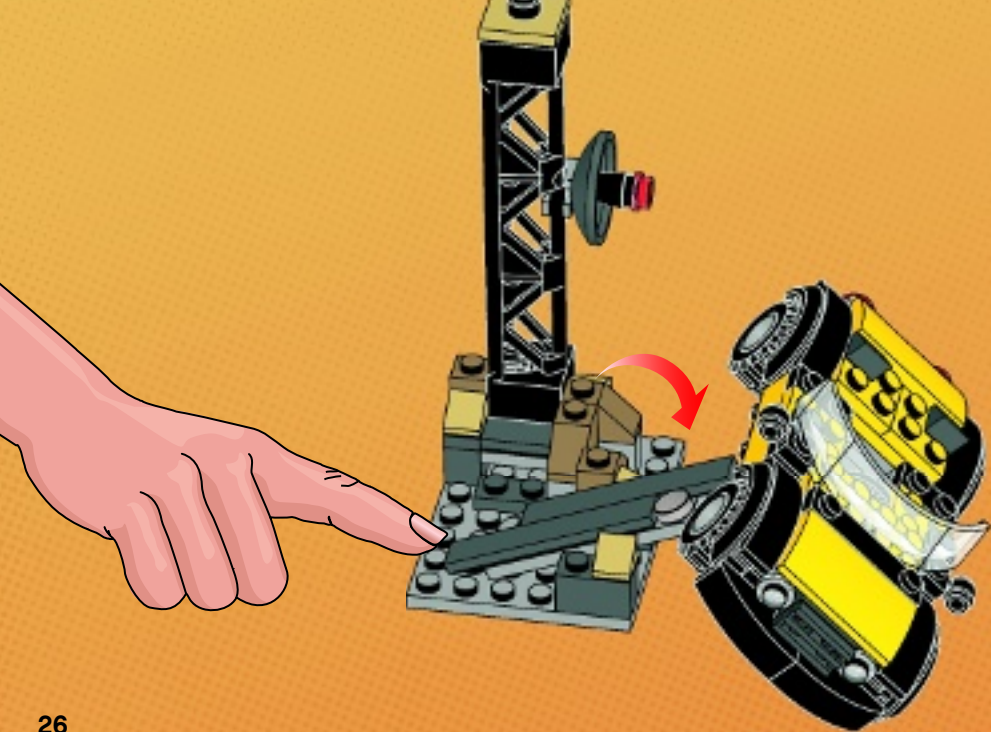

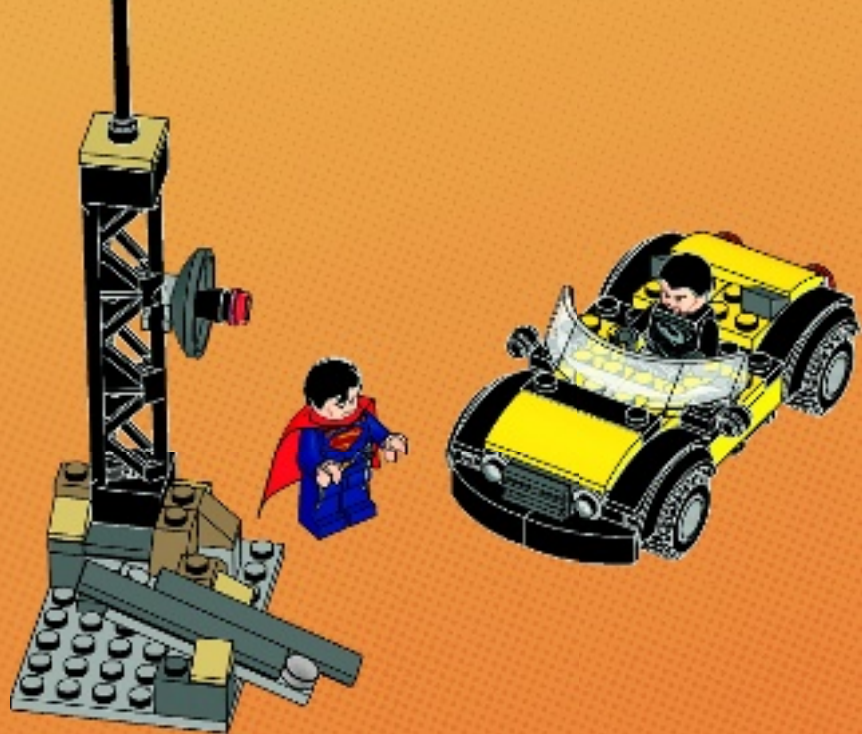



1x
403201



4x
4516055



1x
4565387

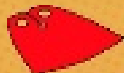

1x
4143210



4x
302224



6x
302124



2x
243124

28



2x
4597902



1x
4529236



2x
4251161



4x
4613153



4x
242026



1x
4599499



4x
4632571



2x
4107761



1x
395726



1x
6041729



1x
6039687



1x
4654944



1x
4667463



1x
4651571



4x
4568644



4x
448826



2x
4225201



1x
4282746



4x
4648117



1x
4523573



2x
3005740



3x
3005741



4x
4530678



1x
6041728



1x
6039684



4x
4211445



1x
4211408



3x
4211389



1x
4541978



4x
4654582



1x
4211394



2x
4211376



4x
4211764



1x
4226995



1x
4211452



1x
4277928



4x
4211087



2x
4504378



4x
4211063



1x
4210631



2x
4210651



1x
4259673



1x
4211055



1x
4263176



4x
4210633



1x
4210865



1x
6037902



1x
6037903



1x
4655241



Customer Service

Kundenservice

Service Consommateurs

Servicio Al Consumidor

LEGO.com/service or dial





OF SUPER HEROES BATMAN™



LEGO and the LEGO logo are trademarks of the LEGO Group.
©2013 The LEGO Group.
TM & © DC Comics. WB SHIELD. TM & © Warner Bros. Entertainment Inc.
(S13)

7+



2-4



15-25



GAMES



Available on the
App Store



LEGO.com/SuperHeroes



LEGO UNIVERSE™
**SUPER
HEROES**

MOVIE MAKER CRÉATEUR DE FILM

SHOOT, EDIT & SHARE YOUR STOP MOTION MOVIE
TOURNE, MONTE ET PARTAGE TON FILM D'ANIMATION

LEGO and the LEGO logo are trademarks of the LEGO Group. TM & © DC Comics. (s13)



WIN!

Go to www.LEGOsurvey.com/product to fill out a survey for a chance to win a cool LEGO® Product.

No purchase necessary.

Open to all residents where not prohibited.



www.LEGOsurvey.com/product

GEWINNE!

Nimm an der Umfrage auf www.LEGOsurvey.com/product teil und hab die Chance ein cooles LEGO® Produkt zu gewinnen!
Die Teilnahme am Gewinnspiel führt zu keinerlei Kaufverpflichtungen.
Teilnahme in allen nicht ausgeschlossenen Ländern möglich.

6047346



LEGO.com



DC COMICS™ TM & © DC Comics.

WIN!

Ga naar www.LEGOsurvey.com/product, vul een enquêteformulier in en maak kans op een cool LEGO® product.
Geen aankoopverplichting.
Iedereen mag deelnemen, uitgezonderd ingezetenden van landen waar een enquêteverbod geldt.

GAGNE !

Visite www.LEGOsurvey.com/product pour répondre à un questionnaire et avoir une chance de gagner un produit LEGO® très cool !
Aucune obligation d'achat.
Ouvert à tous les résidents des pays autorisés.

当てよう!

www.LEGOsurvey.com/product にアクセスして、アンケートにご記入ください。
当選者にはレゴ製品を差し上げます。
お買い上げの必要はありません。
禁止されていない限り、すべての皆様にご利用いただけます。



WB SHIELD: TM & © Warner Bros. Entertainment Inc. (s13)

LEGO and the LEGO logo are trademarks of the LEGO Group.
©2013 The LEGO Group.