



7615



ブロックはずし入



1

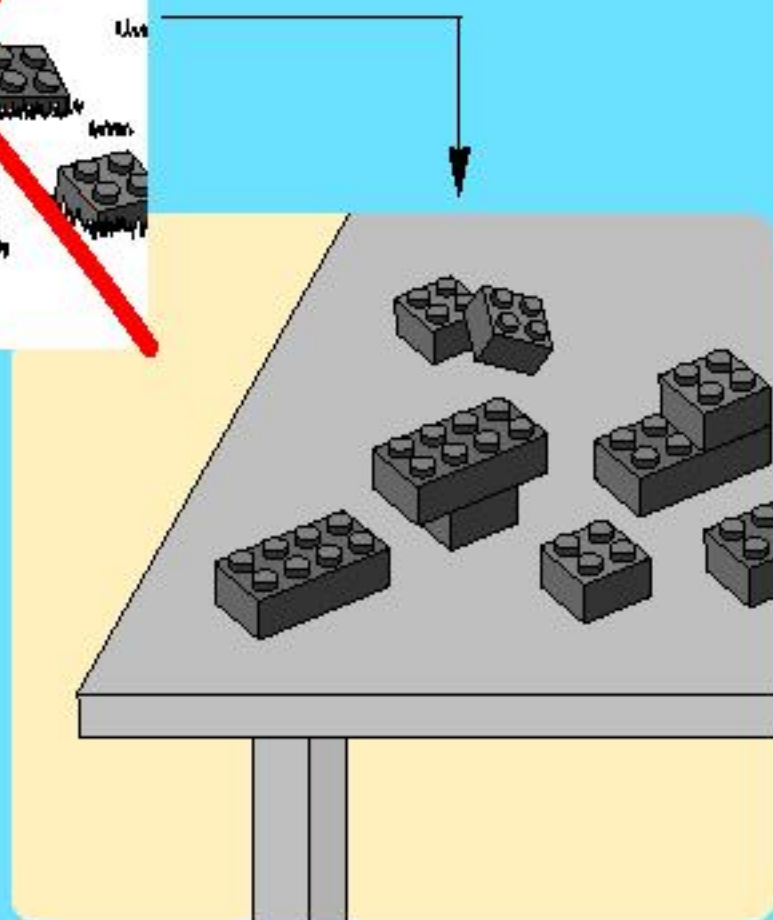

2

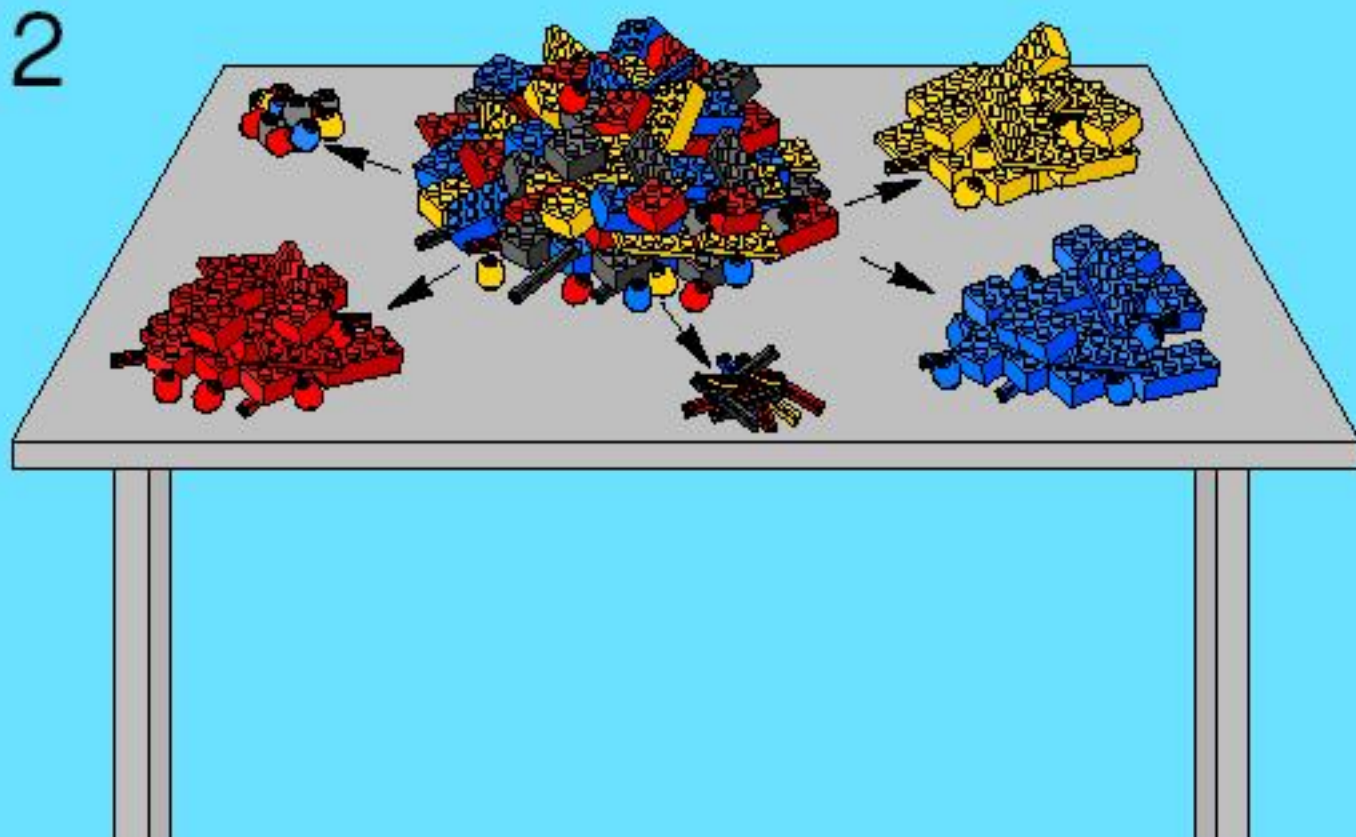

2

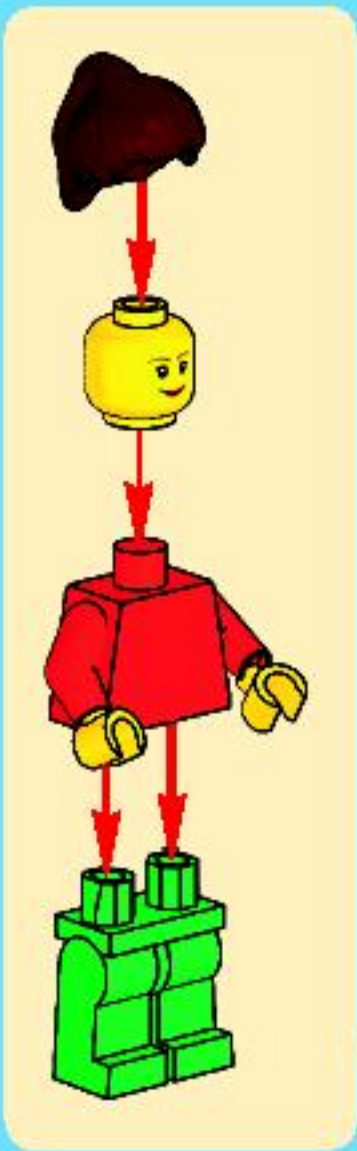



1

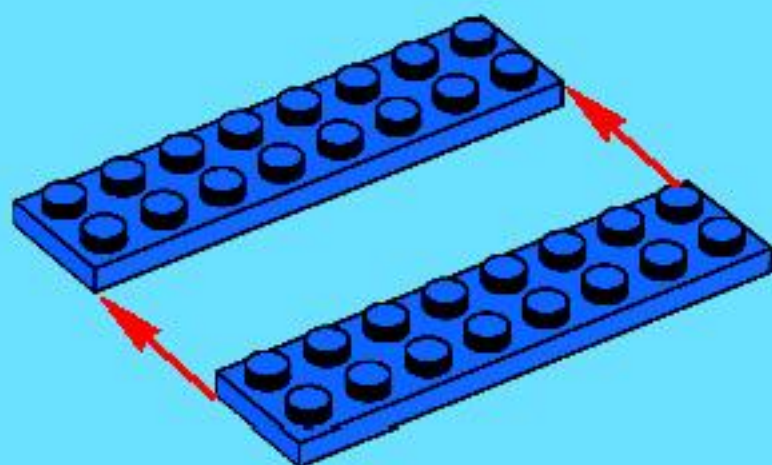

2

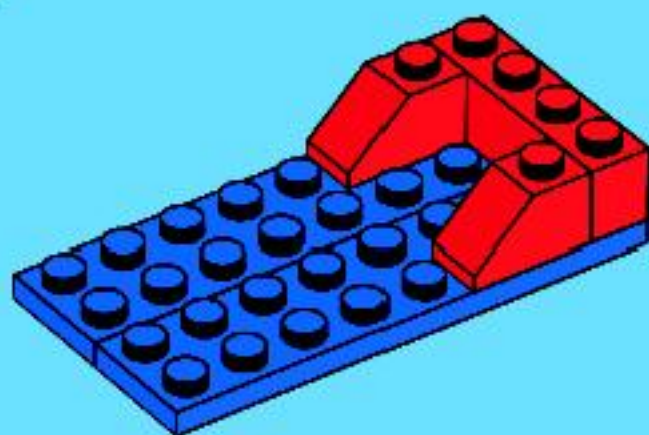

3



4

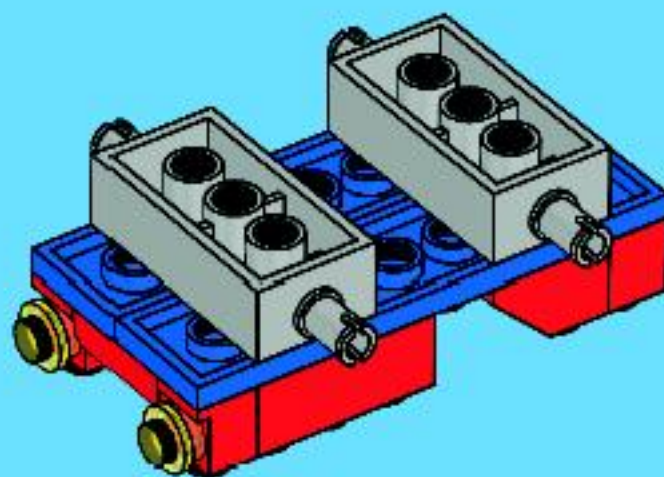

5

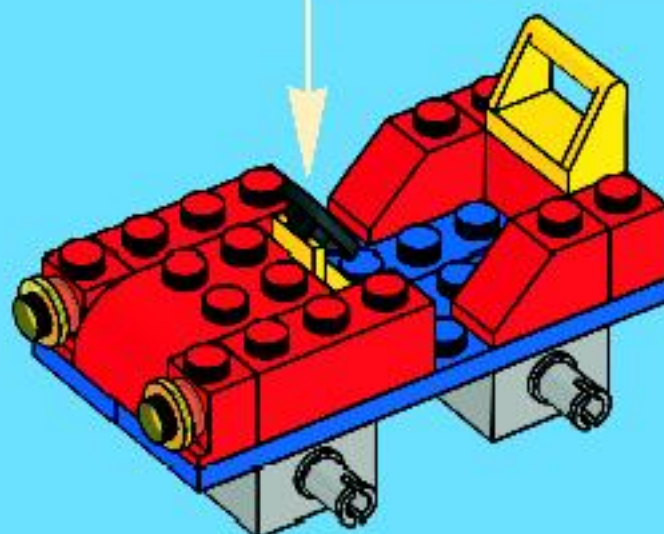

6

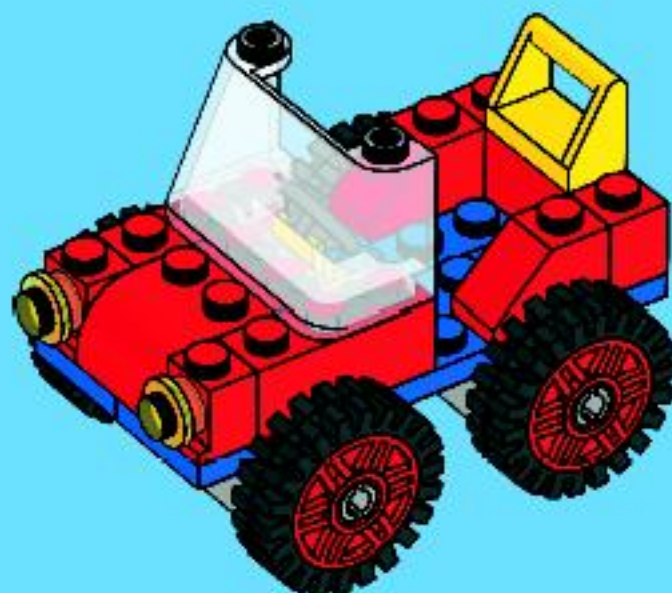





1

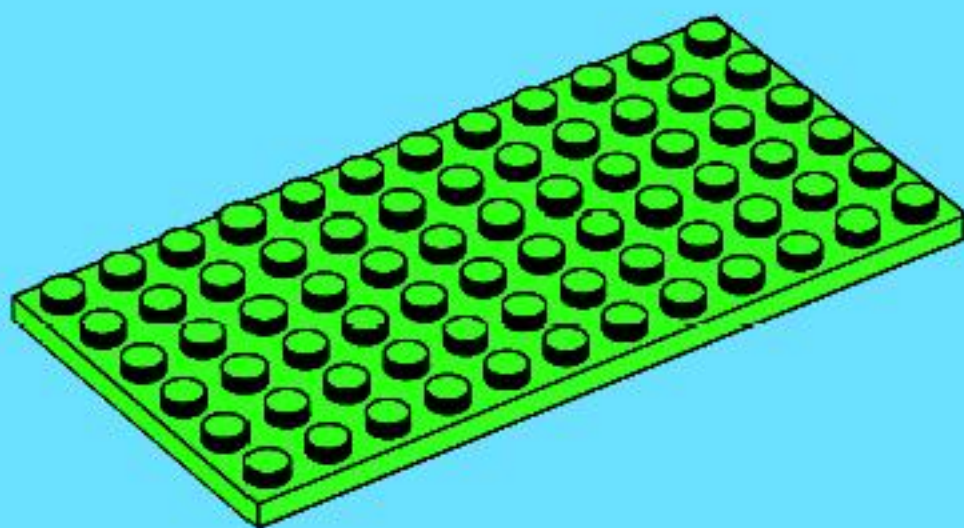

2

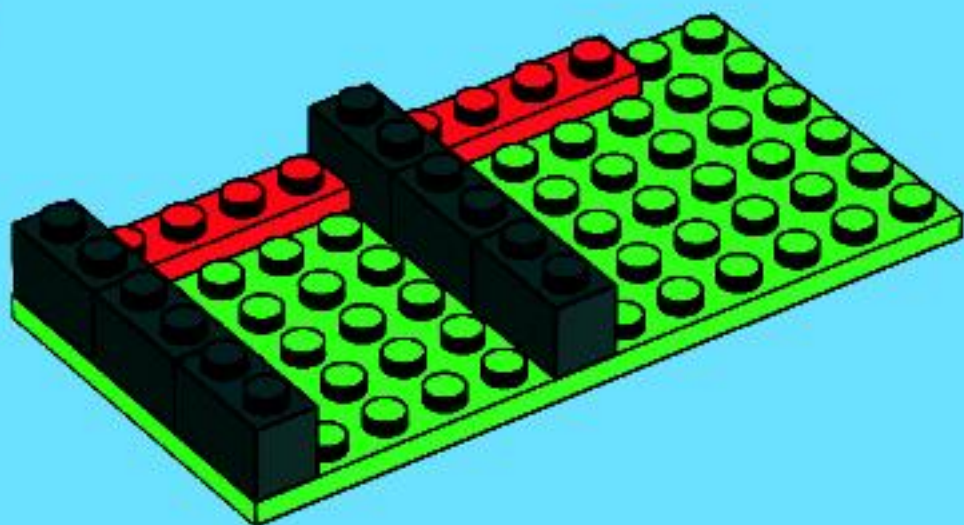

3

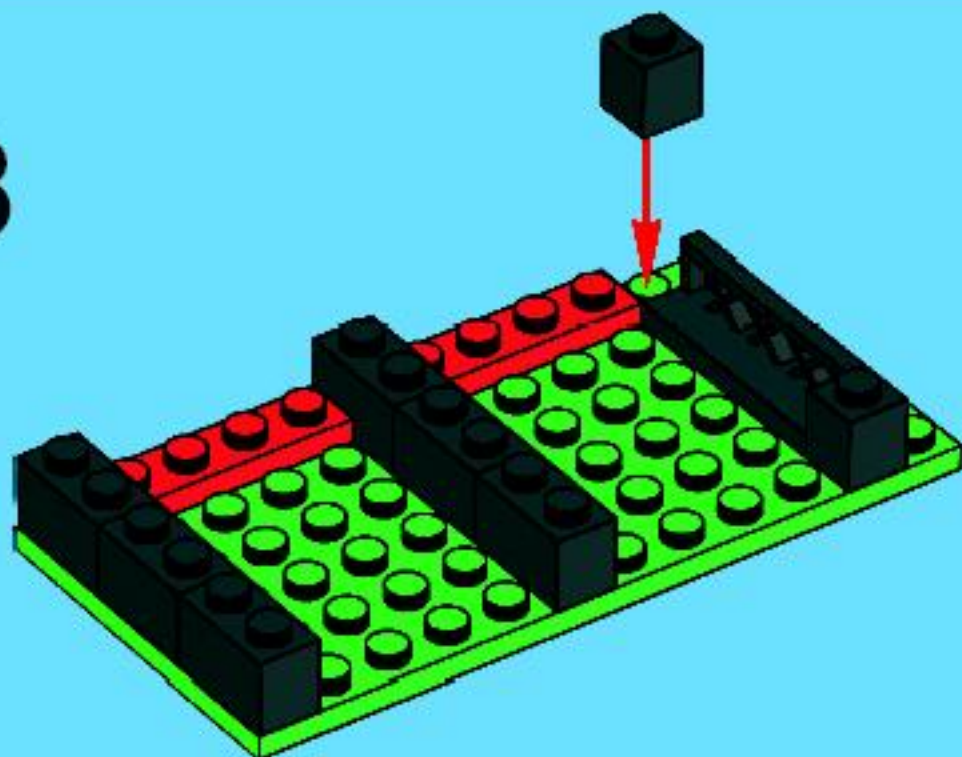

4

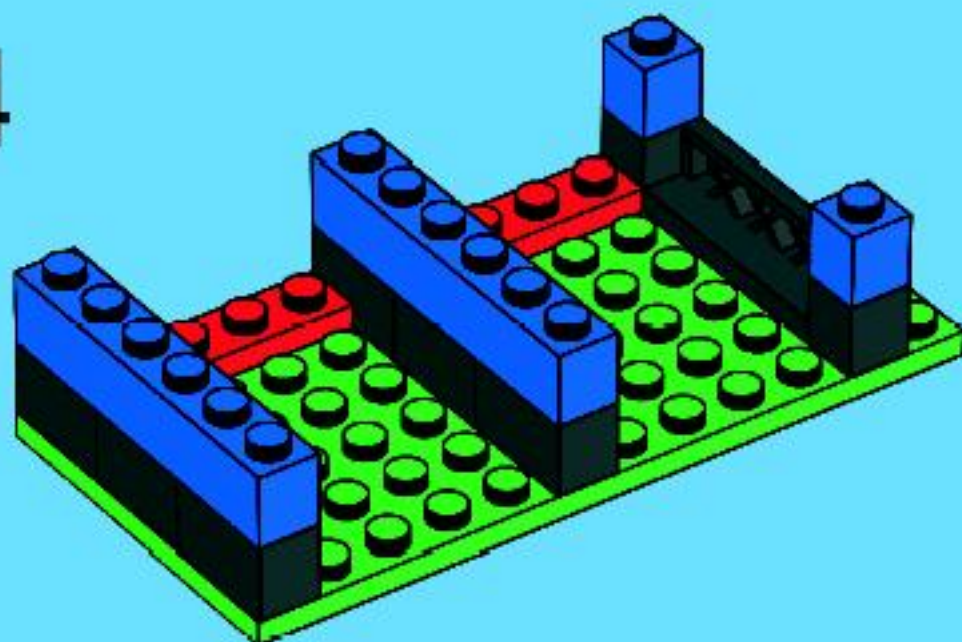

5

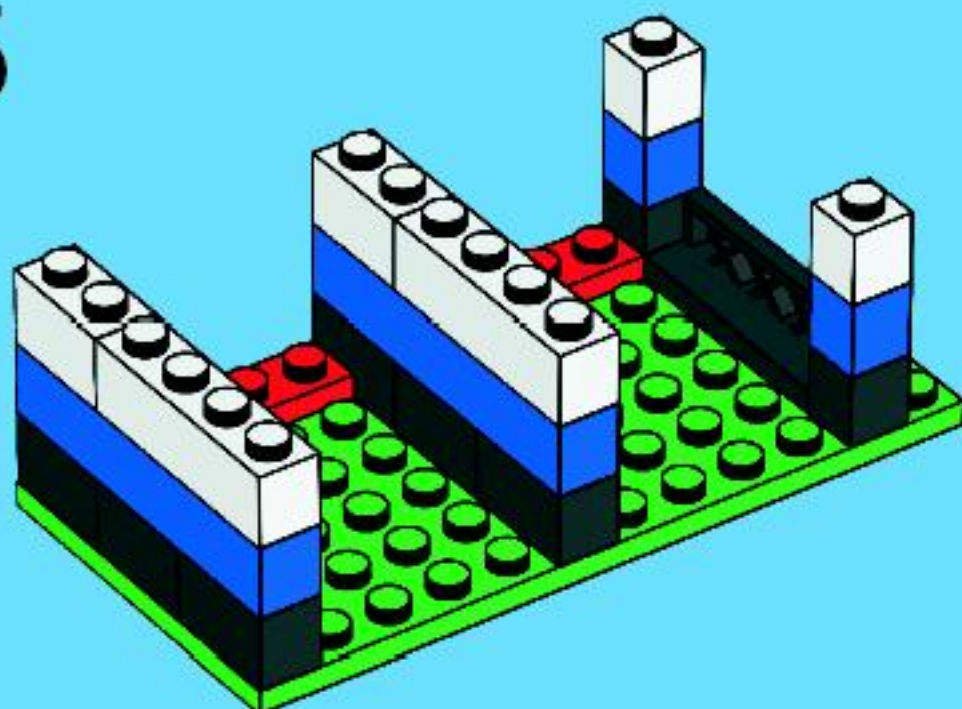

6

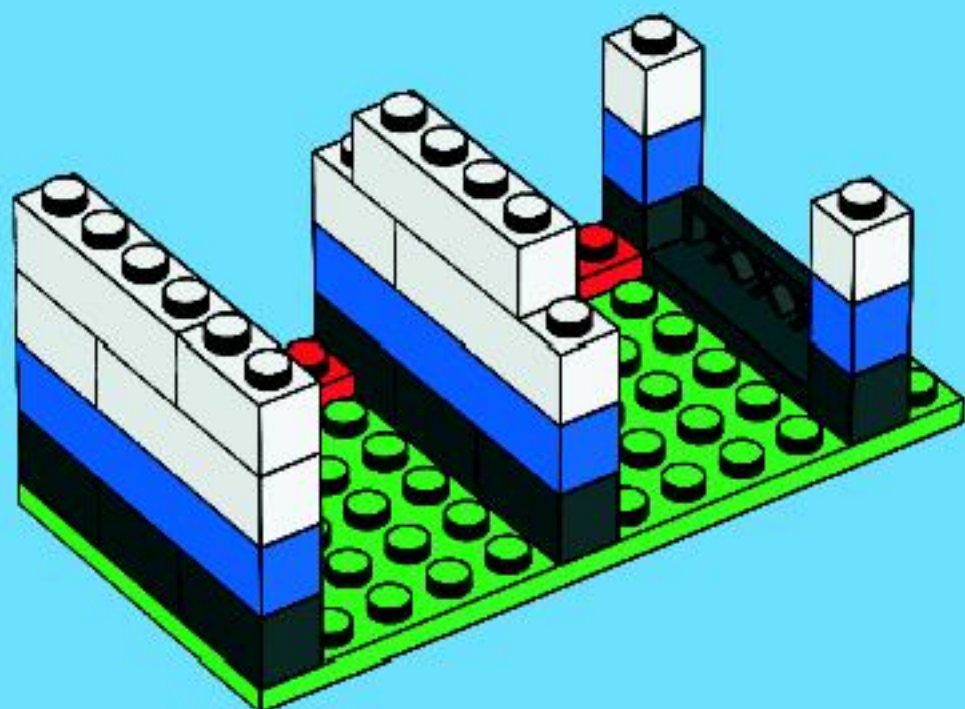

7

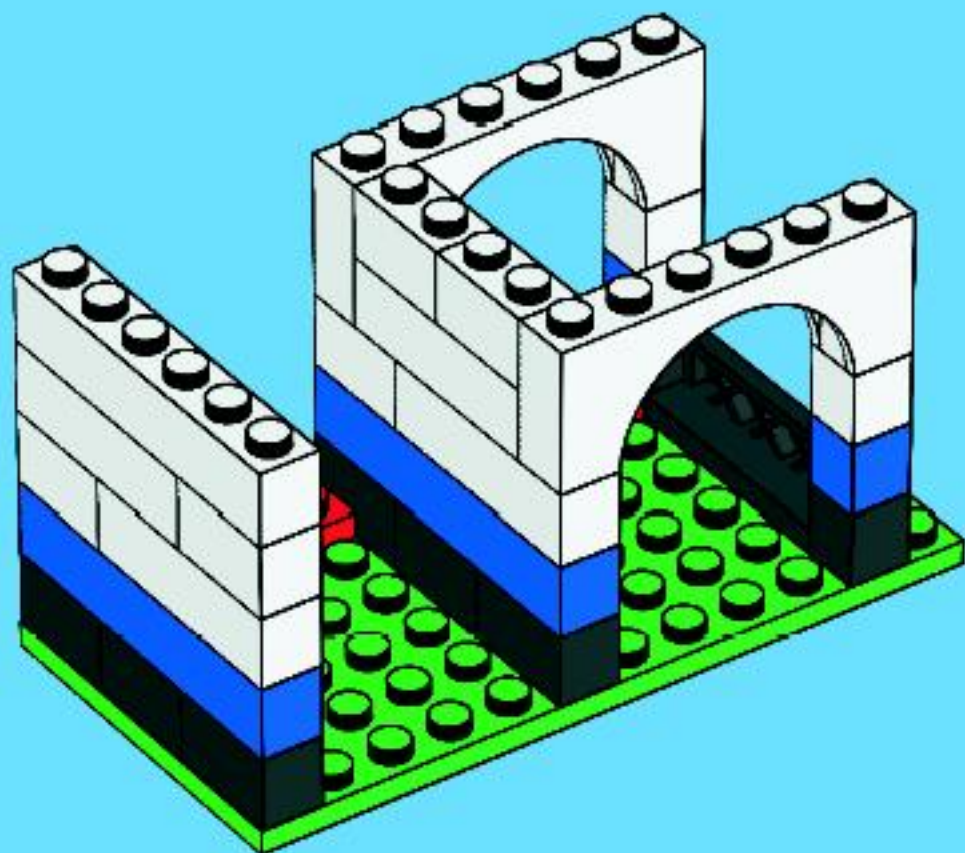

8

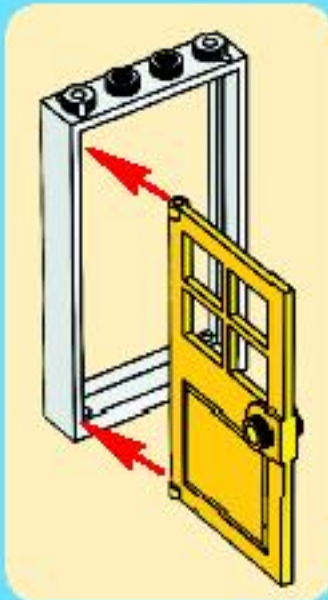
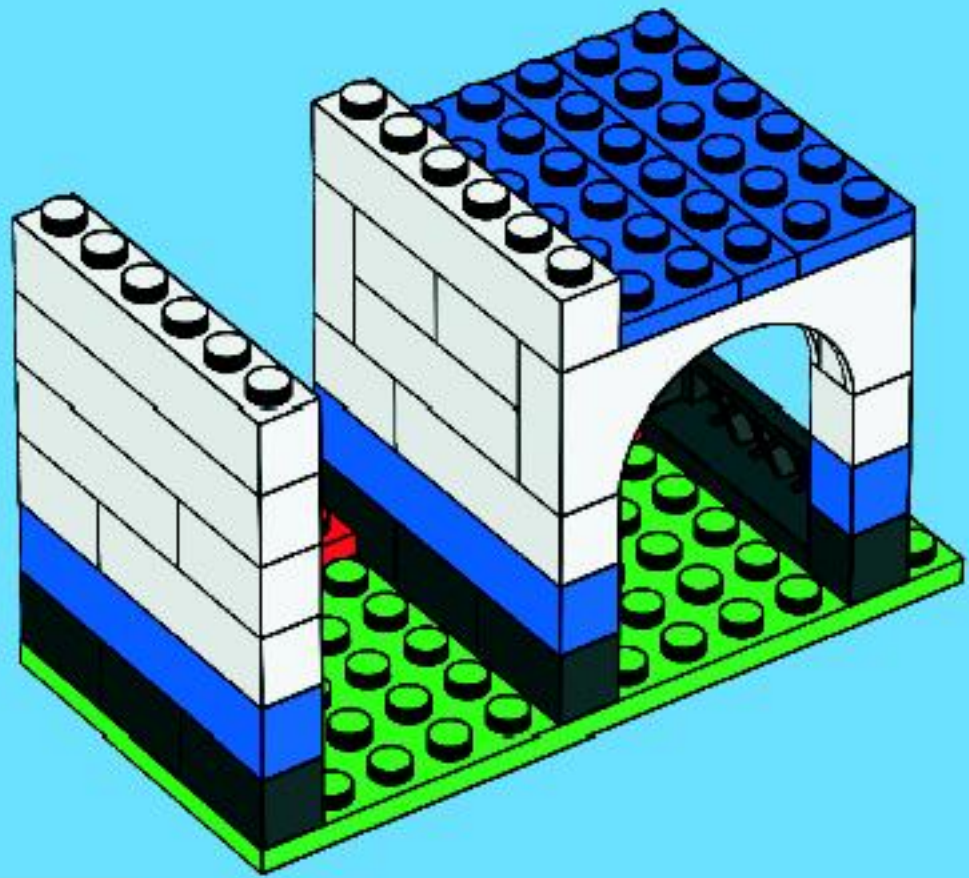

9

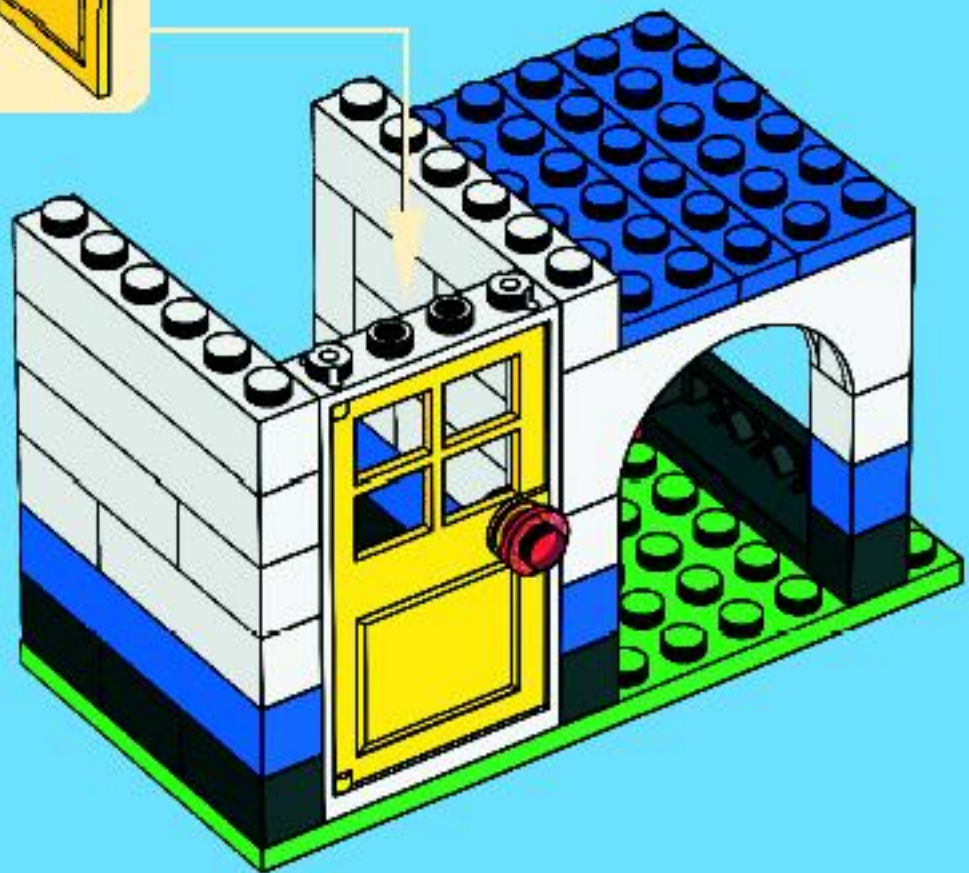

10

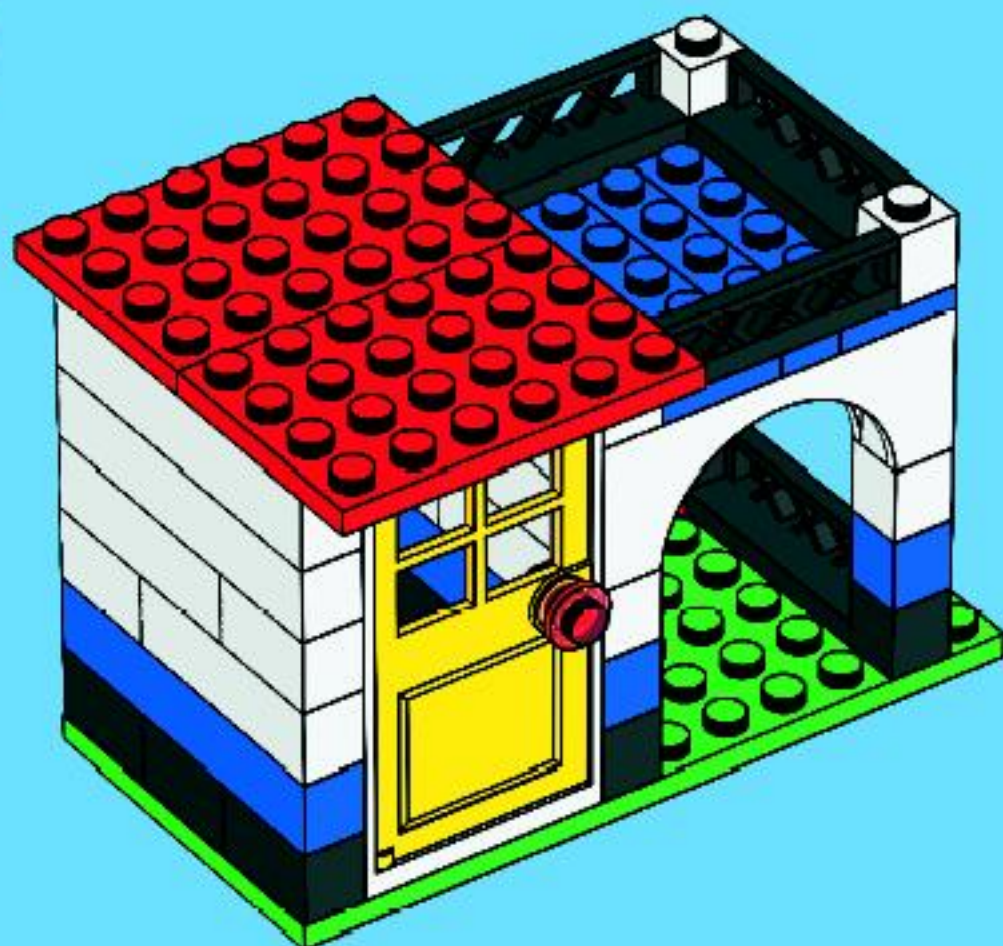

11

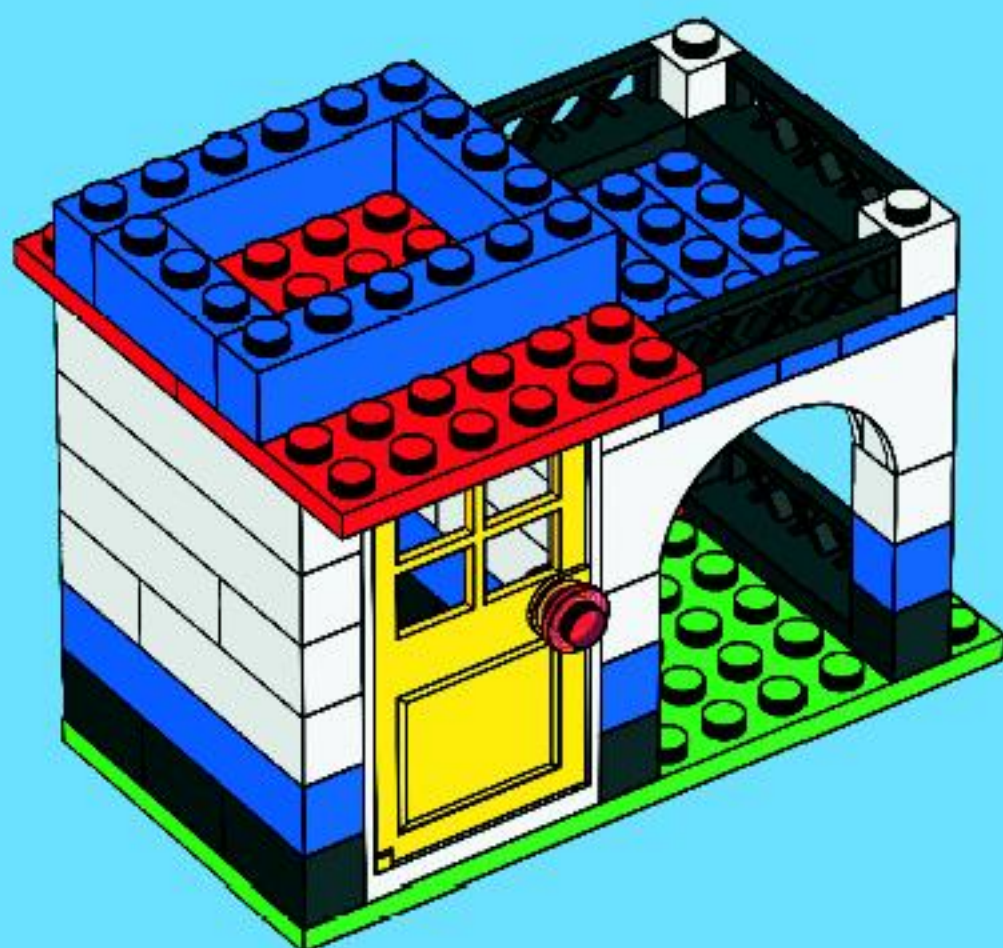

12

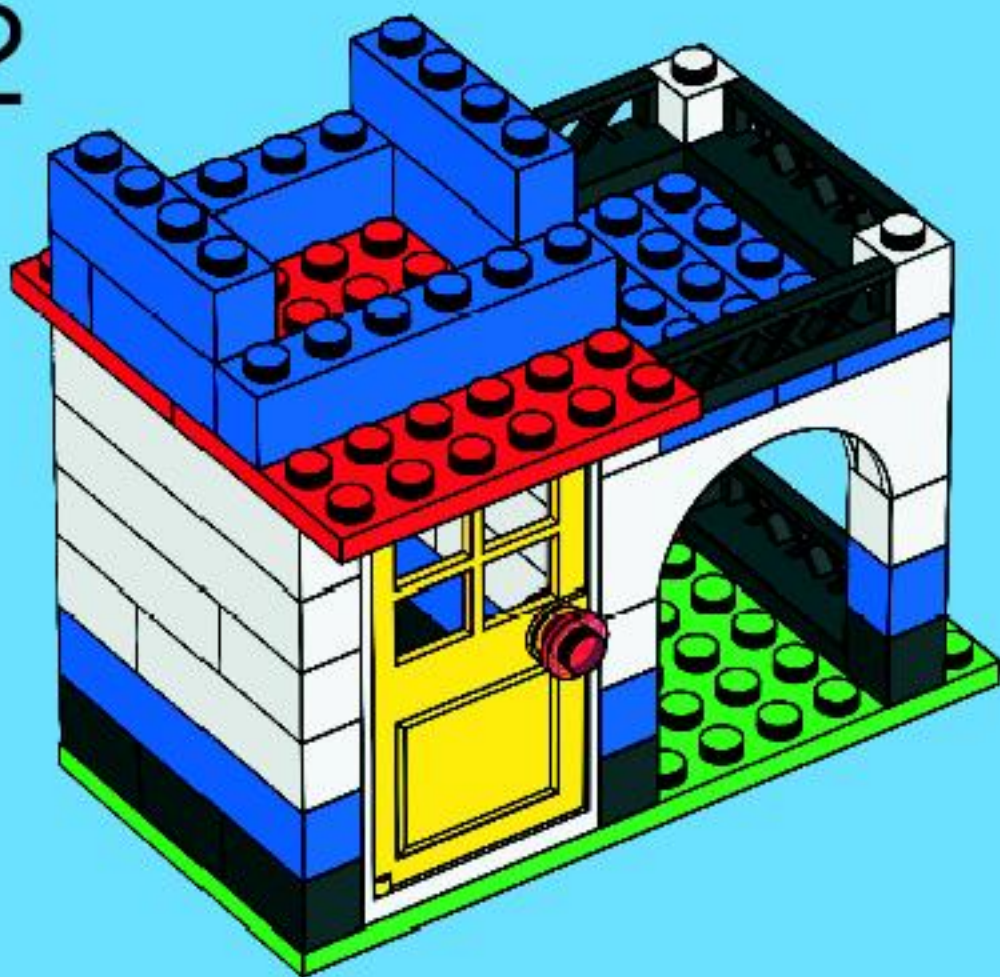

13

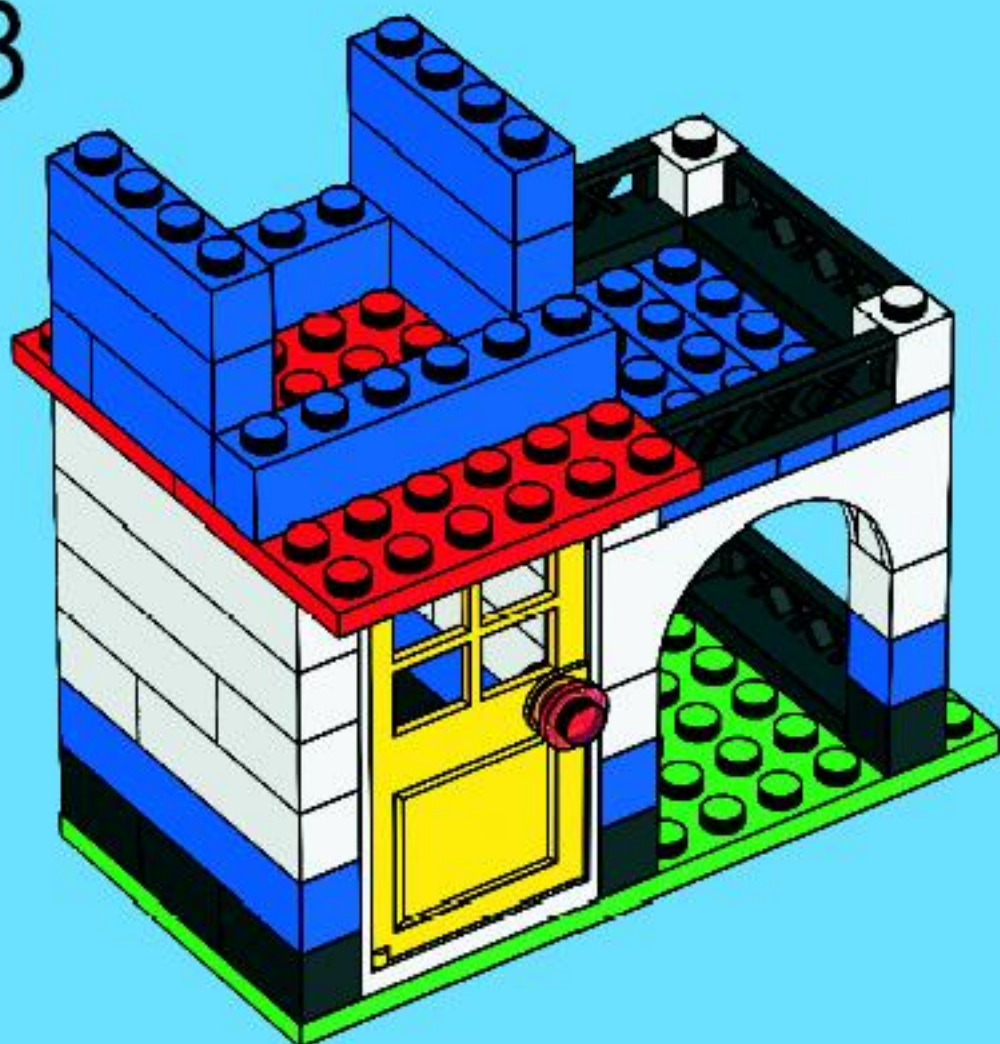

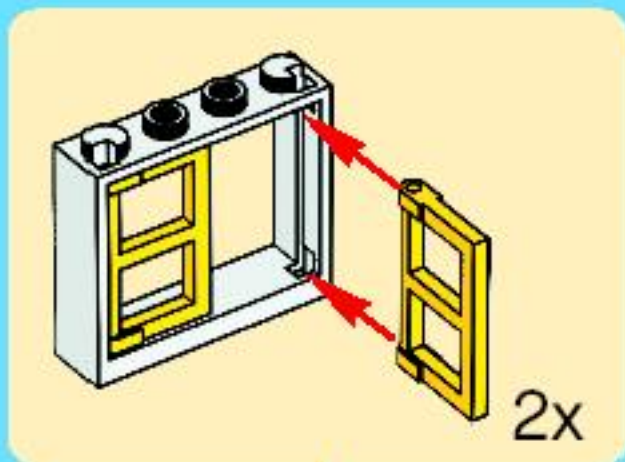

14

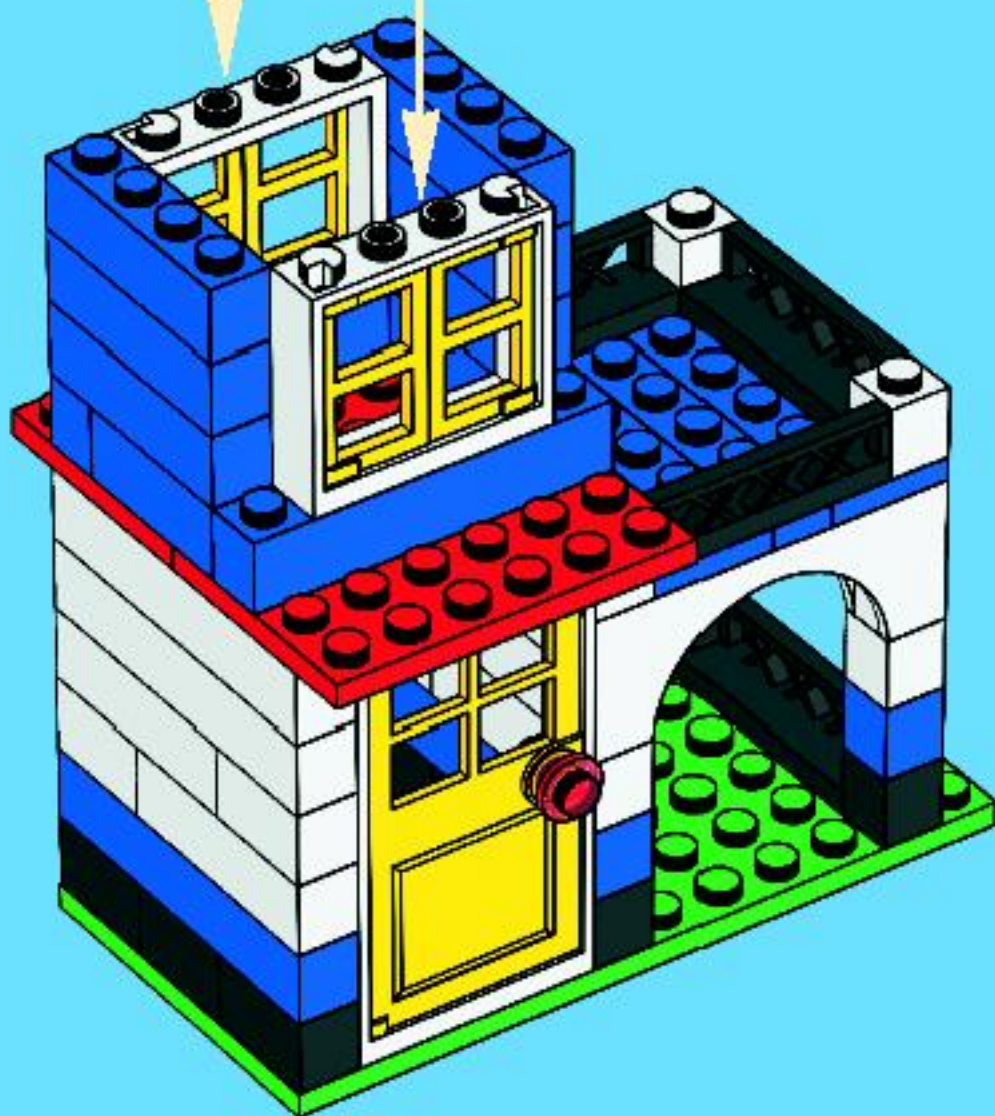

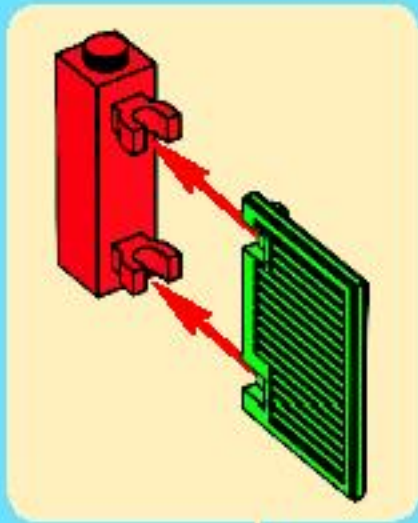

15

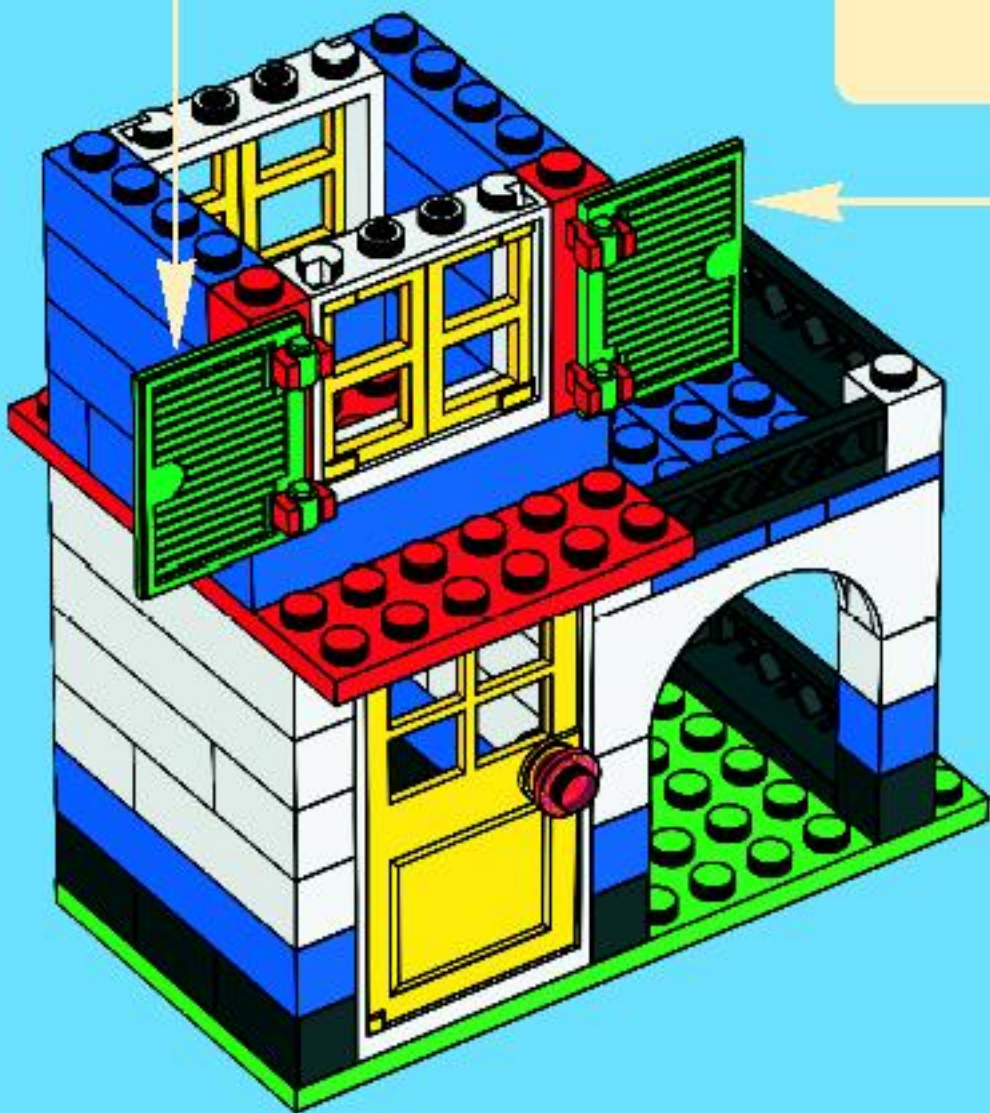
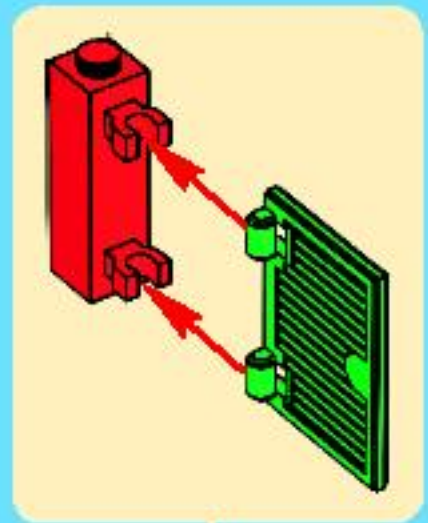

16

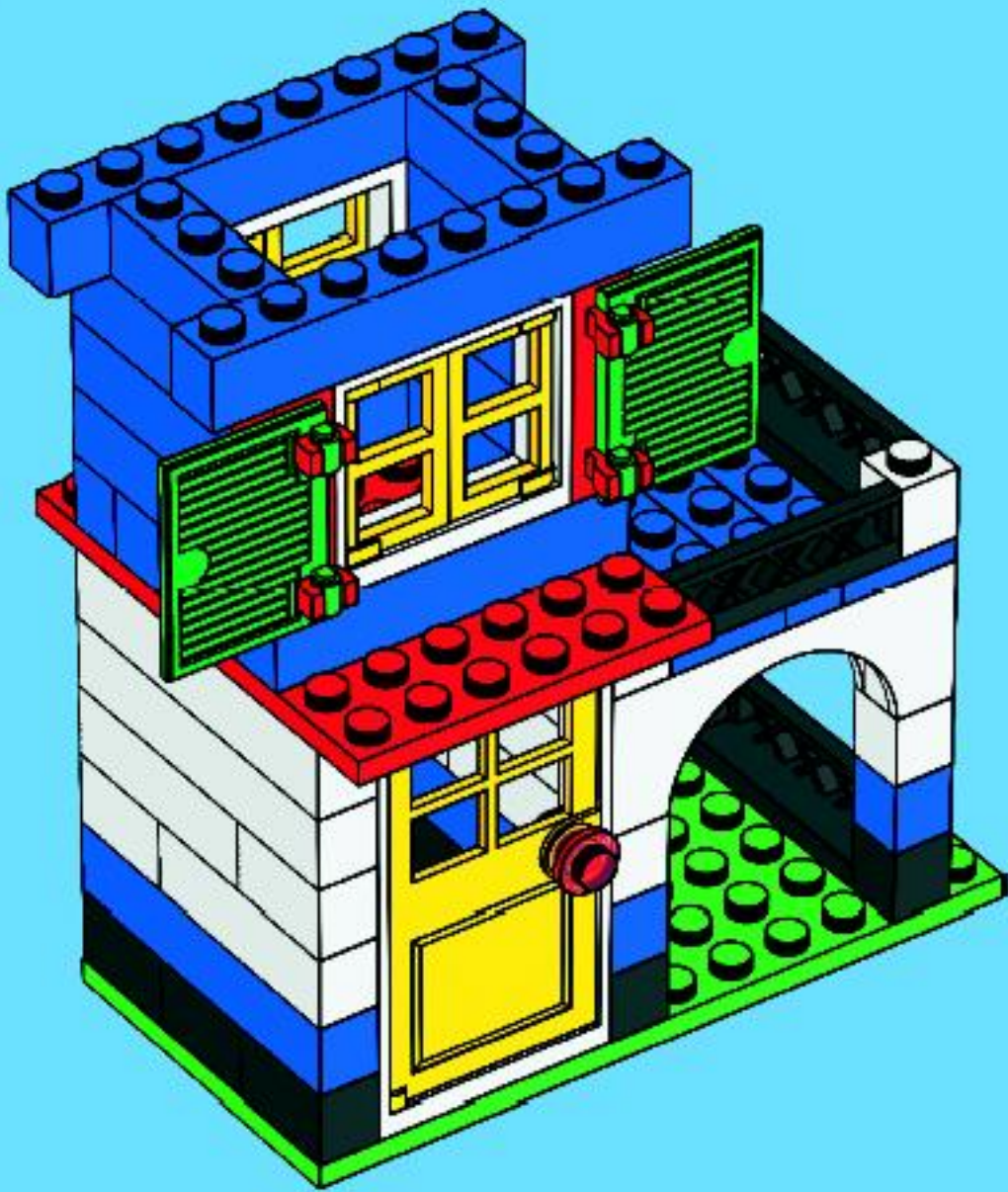

17

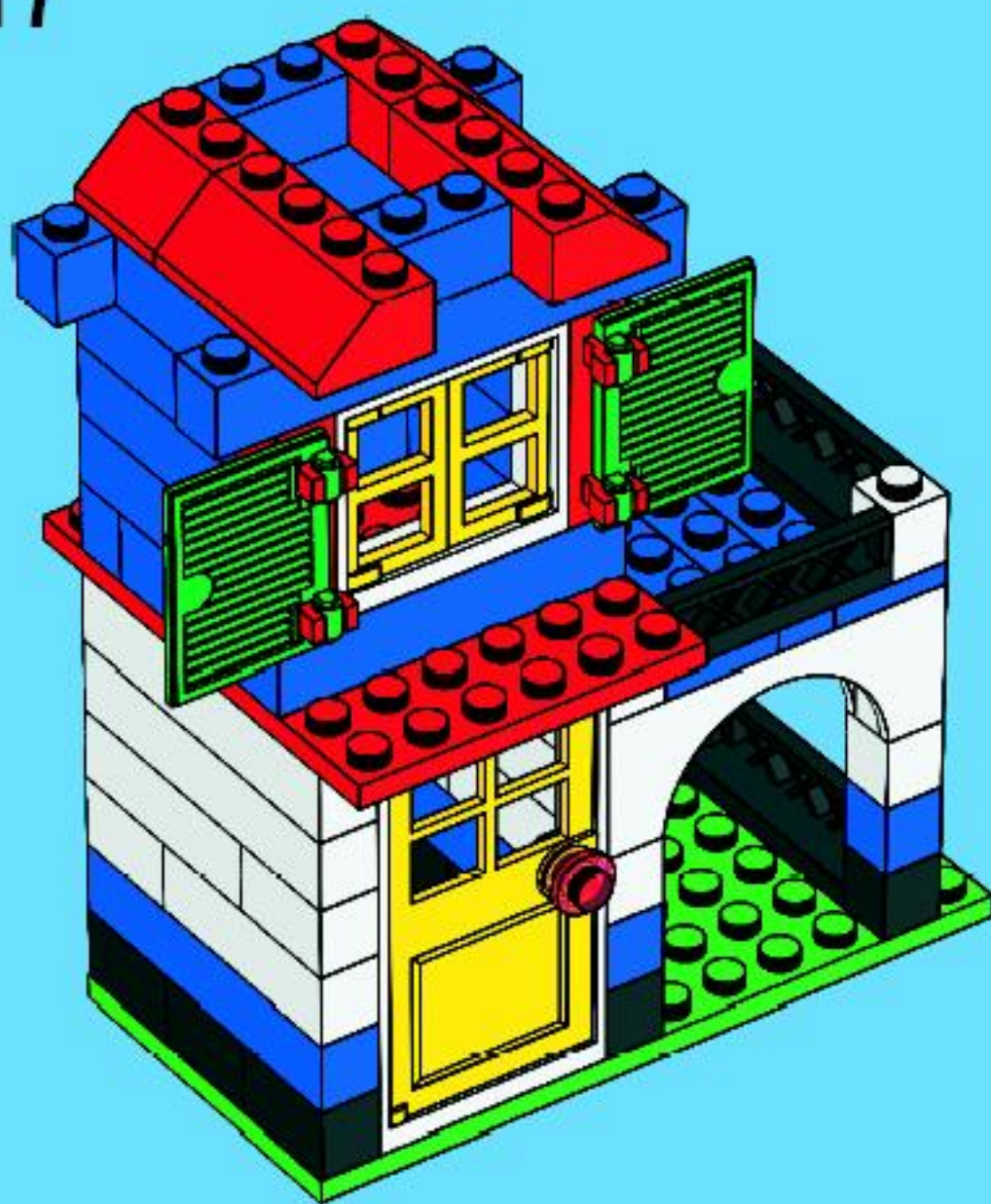

18

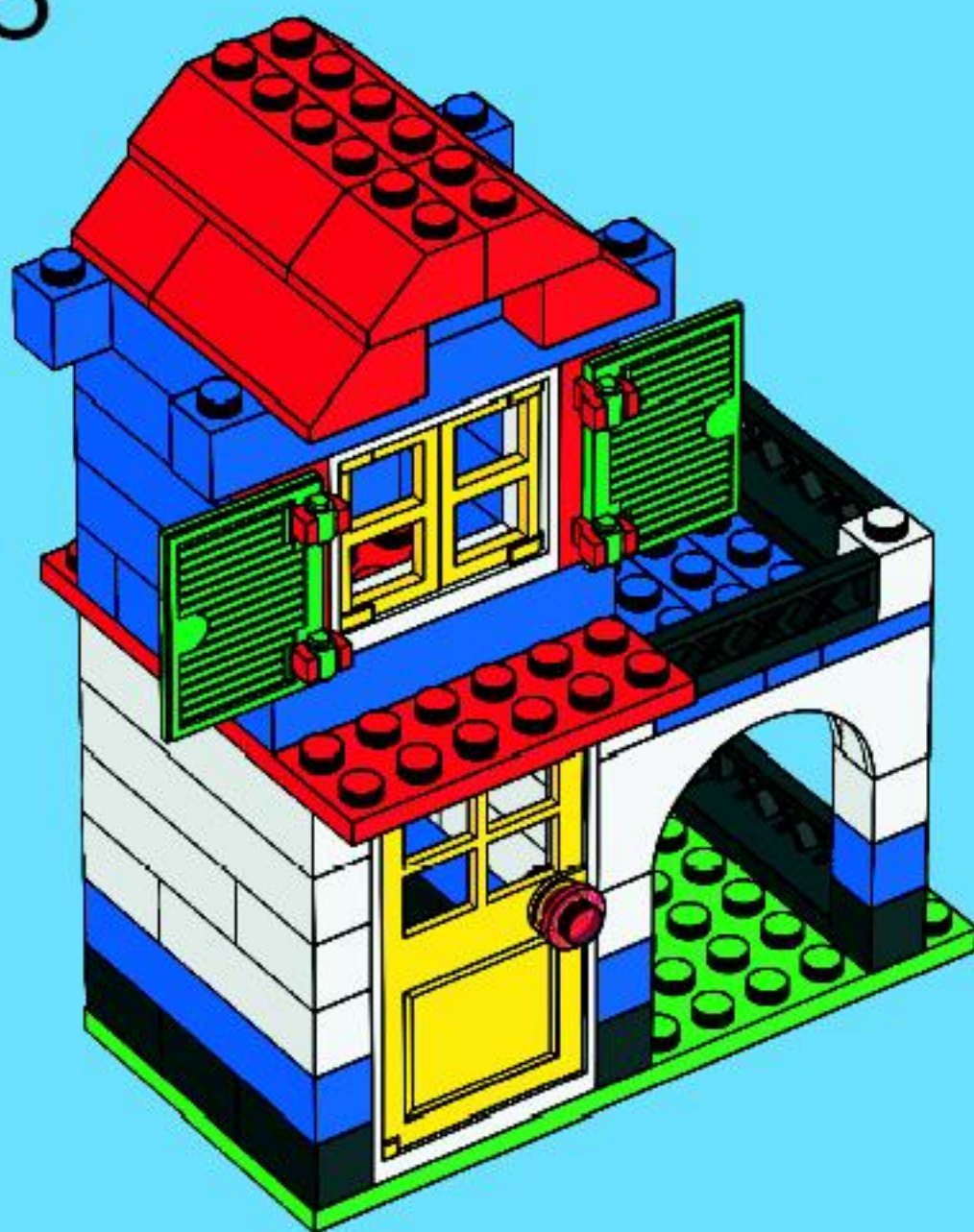

19

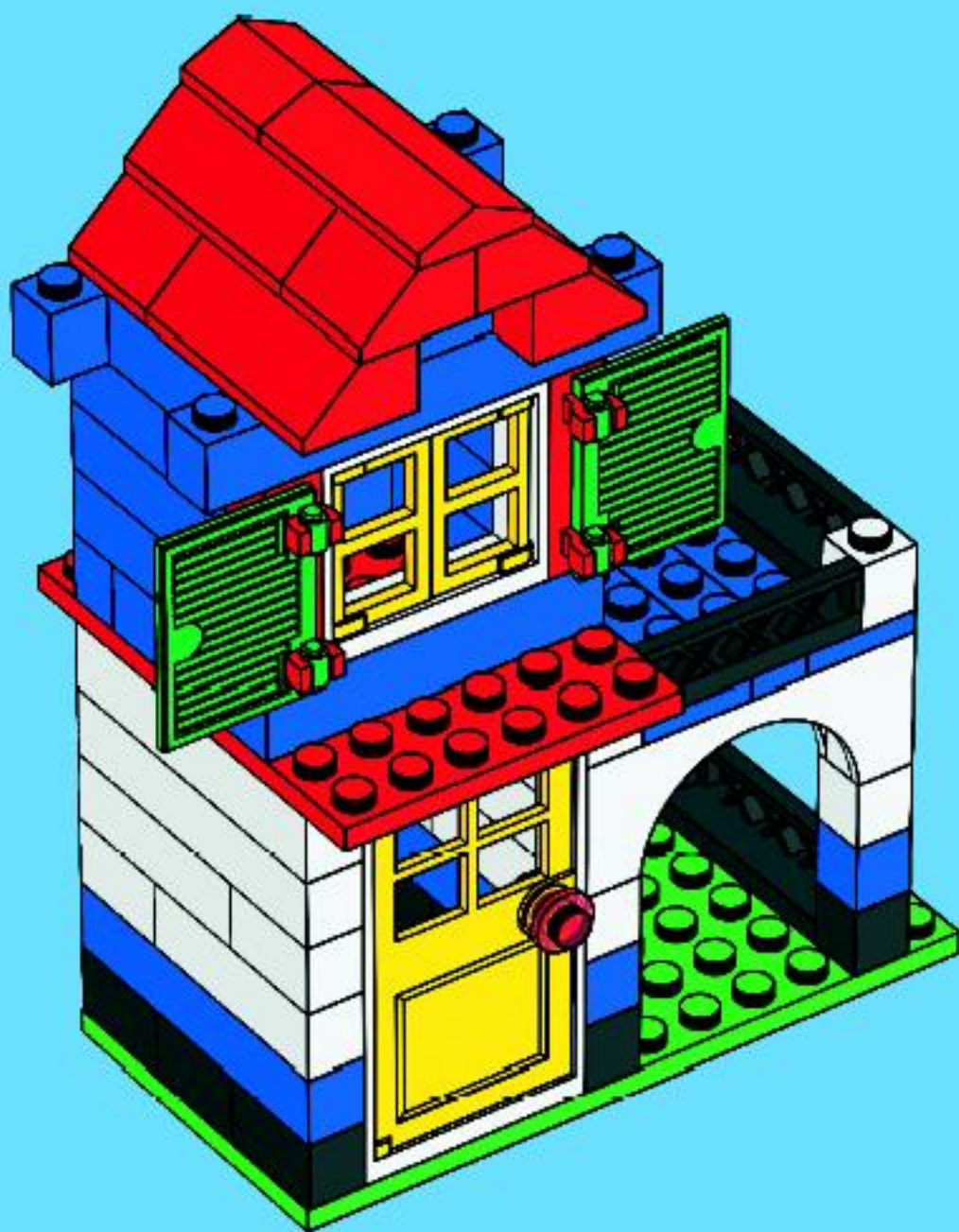

20







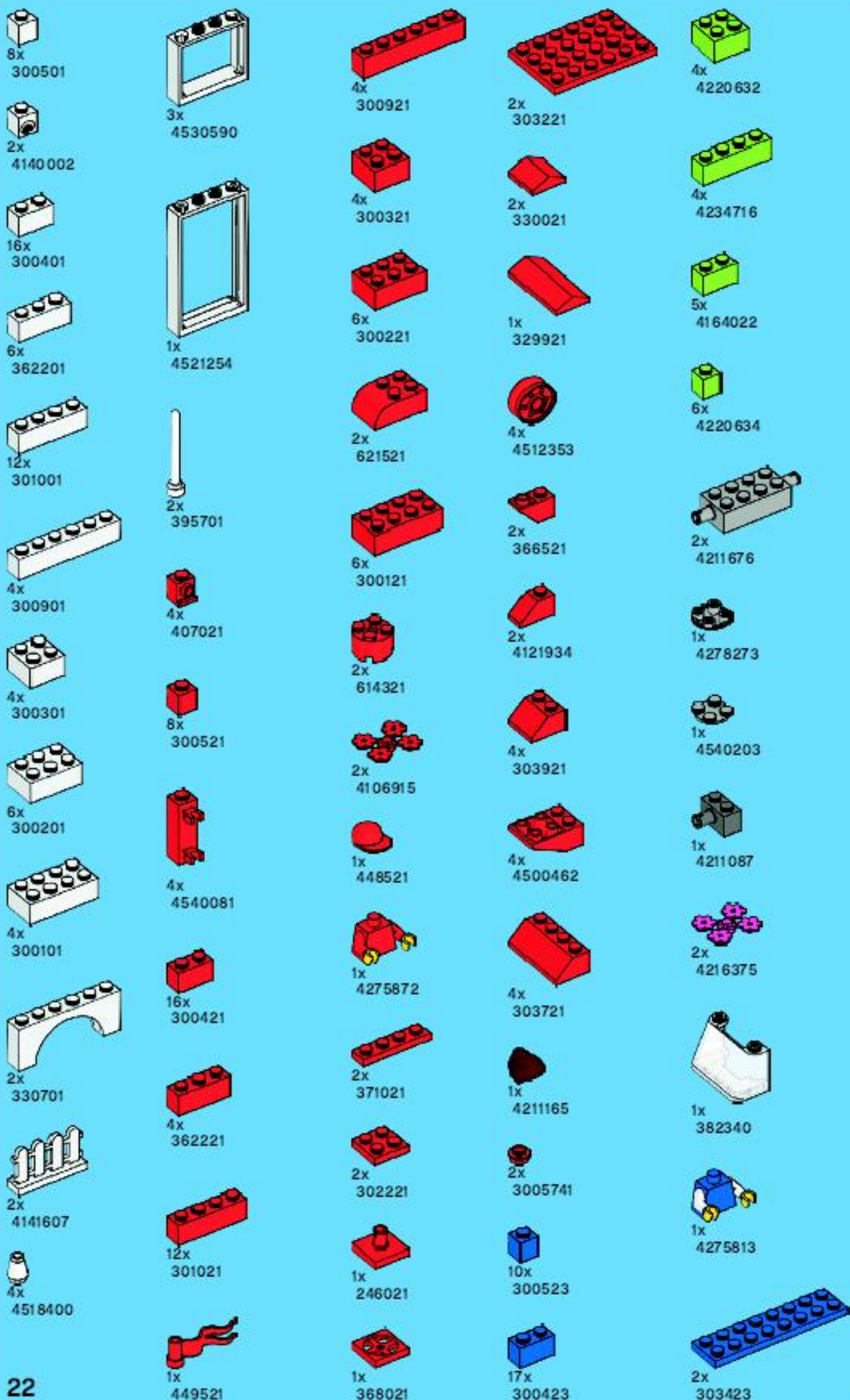

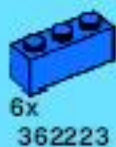

6x
362223



10x
300524



1x
9553



6x
300526



2x
4107722

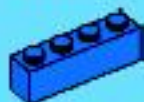

14x
301023



2x
82357



10x
300426



8x
4107736

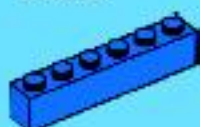

4x
300923



16x
300424



4x
300326



4x
300328



2x
300823



6x
362224

1x
4528550



4x
300226



1x
74040



6x
300323

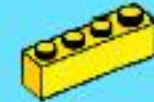

14x
301024



2x
4100529



4x
300126



2x
302128



6x
300223



4x
300924



1x
4261269



4x
4187209



4x
4528128



6x
300123



2x
300824



1x
4293369



1x
9339



4x
374128

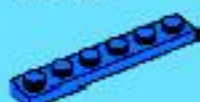

2x
366623



6x
300324



2x
371024



1x
604126



2x
3005744



2x
302223



6x
300224



2x
241224



1x
247926



6x
300528



2x
302123



6x
300124



2x
329824



4x
4541455



2x
243224



2x
379523



2x
407924



4x
306226

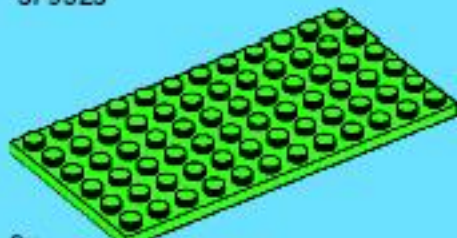

2x
4541414



6x
4528136

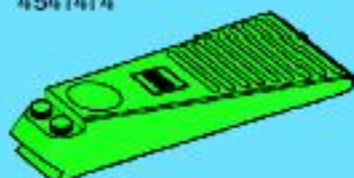

1x
600728



2x
614324



Customer Service
Kundenservice
Service Consommateurs
Servicio Al Consumidor

www.lego.com/service or dial



: 00800 5346 5555

: 1-800-422-5346

レゴブロック遊びのQ&A

—ママたちのご質問にお答えします—

Q1 作ってもすぐにこわしてしまいますが、いいのでしょうか？

A1 どんどんこわしてください！こわしてから、さらにちがうものやバージョンアップしたものを作るプロセスがとても大切です。

Q2 細かい部品がたくさんありすぎて、もてあましています。

A2 お子様の理解力や指の力が成長してくると、「カッコいい作品を作りたい！」という欲求も強くなります。リアルな作品作りには、細かい部品が欠かせません。たとえば人形は「頭」・「帽子/髪/髪の毛」・「上半身」・「下半身」と4つの部品に、家の部品は「窓枠」・「扉」・「よるい戸」と3つの部品から構成されています。少しずつ細かい部品を作品に組み込めるように促してあげましょう。

Q3 うまく作れないのですが…

A3 ブロックがすき間無くぴったりはまっていないと、作っている途中でこわれやすくなり、イライラがたまって楽しく遊べないことがあります。またブロックがくっついたまま外せなくなってしまった時は、付属の「ブロックはずし」が便利です。使い方はバケツラベルか、このアイデアブックの一番前のページを参考にしましょう。

Q4 へんなカタチのものばかり作るのですが…

A4 レゴブロック遊びに「正しい」とか「まちがっている」ということはありません。お子様が作りたいものを作るのがレゴブロック遊びの楽しみです。「できあがったら見せてね!」「何を作ったの?」「ここは何をしたらいいの?」いろいろ聞いてみると、お子様が思いがけない想像力の持ち主だということにきっとびっくりします!

Q5 手伝ってほしいといわれたらどうすればいいのでしょうか？

A5 「どう手伝ってほしいのか」お子様に聞いてみましょう。「ブロックが見つからない」「はずせない」「くっつけ方がわからない」などお子様が「できない!」と思ったところだけを手伝ってあげ、作品を最後までがんばって完成させるように促してあげましょう!

Q6 青いバケツの次は何を買えばいいですか？

A6 基本ブロックや基礎版を追加して、大きくて複雑な作品に挑戦することができます。また「レゴクリエイター」で生き物や乗り物、家などテーマごとにモデルを組み立てられるセットや、「レゴシティ」などのように街並みや物語の世界を再現して遊べるセットなど、お子様の好みに合わせて選んでいただくことができます。