



MARVEL STUDIOS

# SPIDER-MAN

*No Way Home*

76184





Check for compatibility  
Kompatibilität prüfen  
Vérifier la compatibilité  
Controlla la compatibilità  
Comprueba tu compatibilidad  
Verificar a compatibilidade  
Ellenőrizd a kompatibilitást  
Pārbaudīt saderību  
检查兼容性

[LEGO.com/devicecheck](https://www.lego.com/devicecheck)

# 乐高® 拼搭指引



LEGO® Building Instructions



Download on the  
App Store



GET IT ON  
Google Play



腾讯应用宝  
安卓应用商店

Apple and the Apple logo are trademarks of Apple Inc.  
Google Play and the Google Play logo are trademarks of Google LLC.  
Tencent and the Tencent logo are trademarks of Tencent Inc.





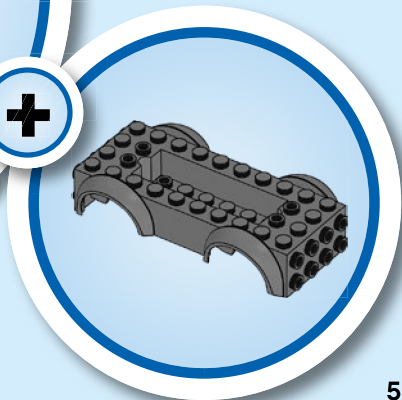

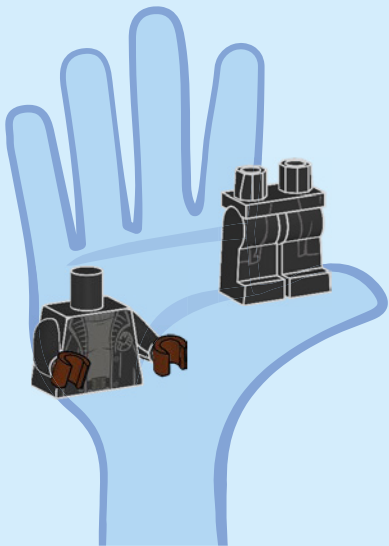

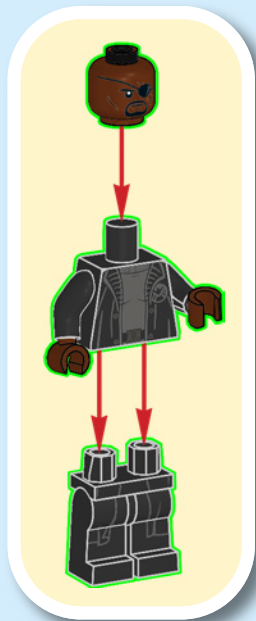

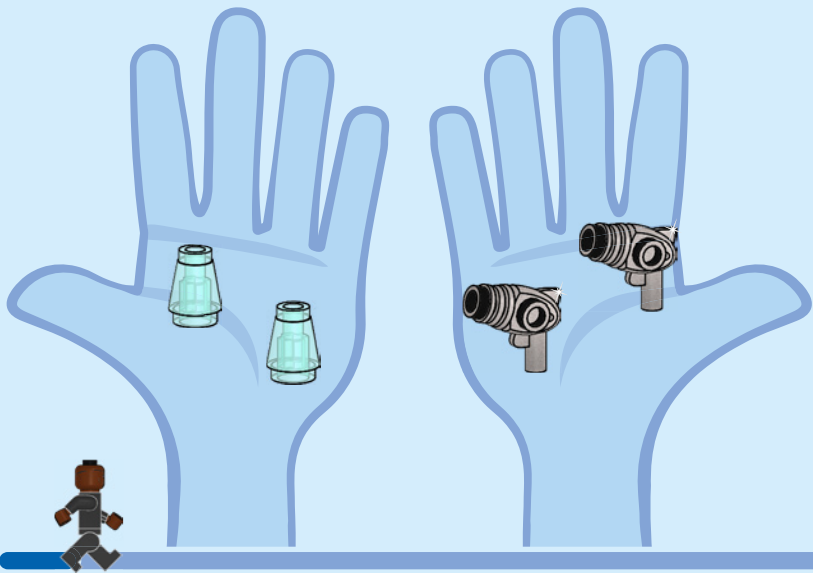





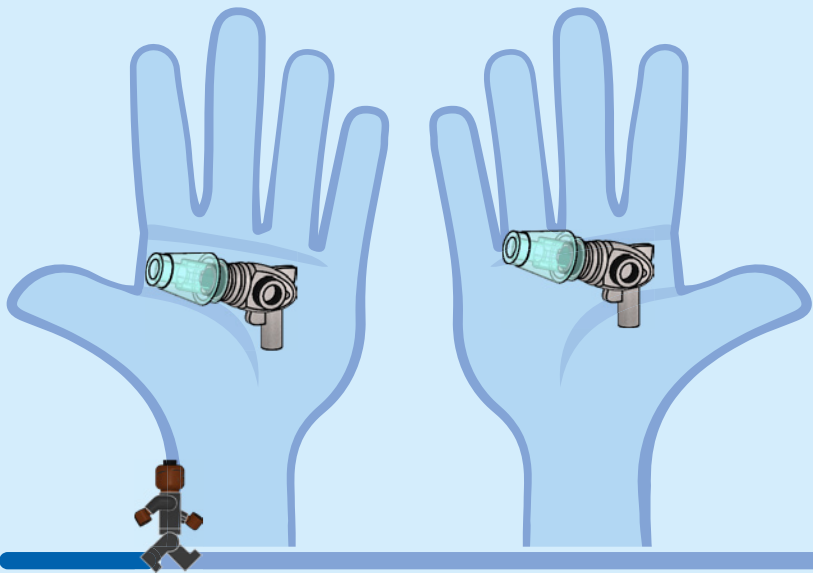



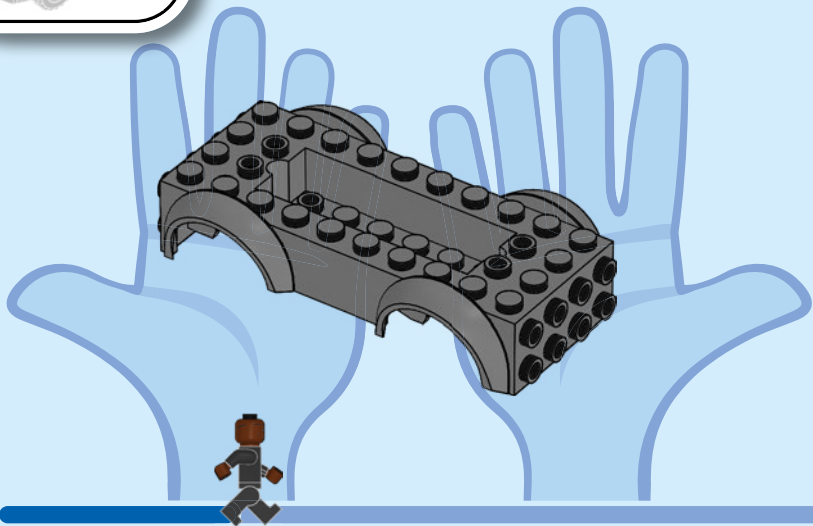

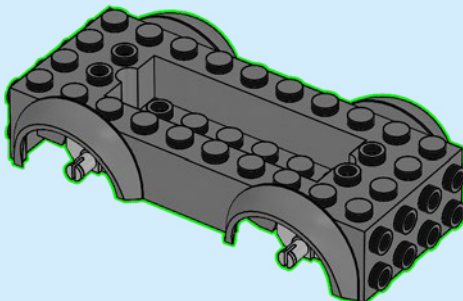



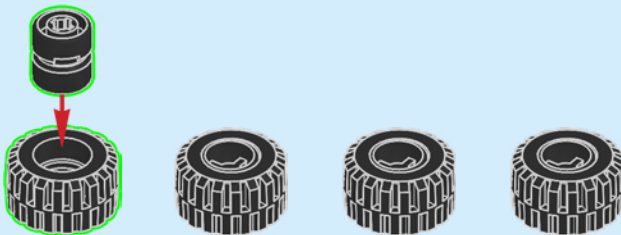

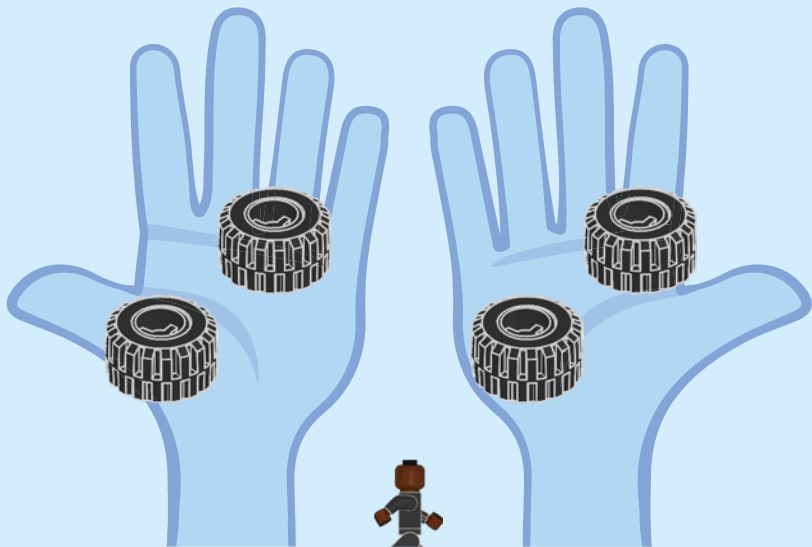



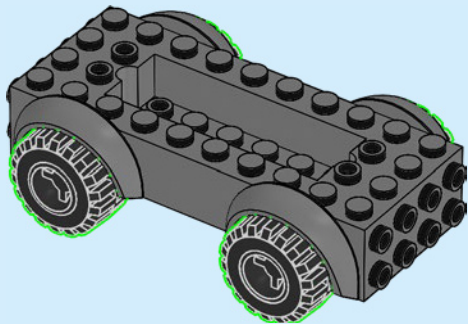

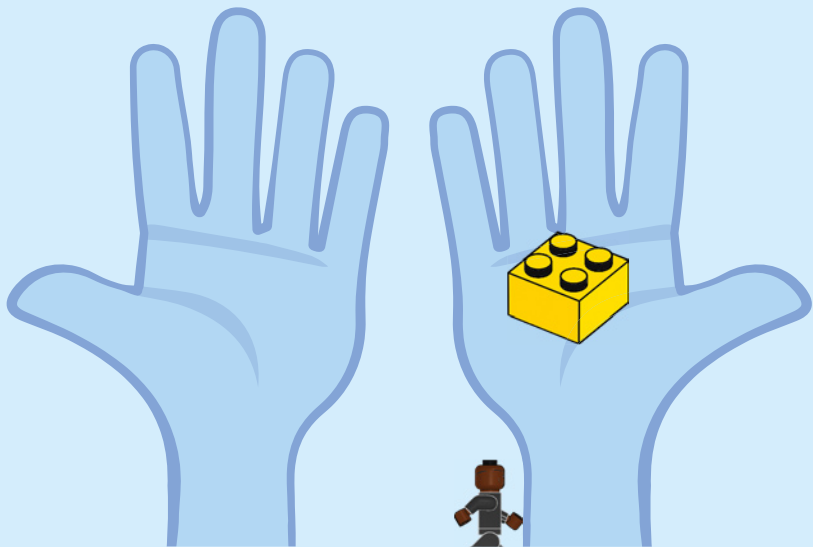

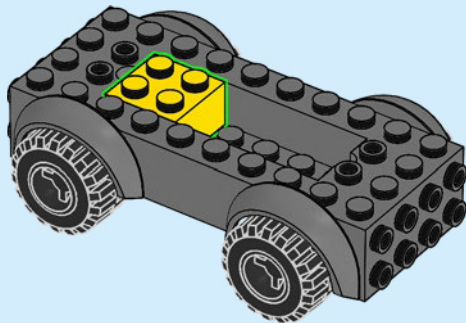

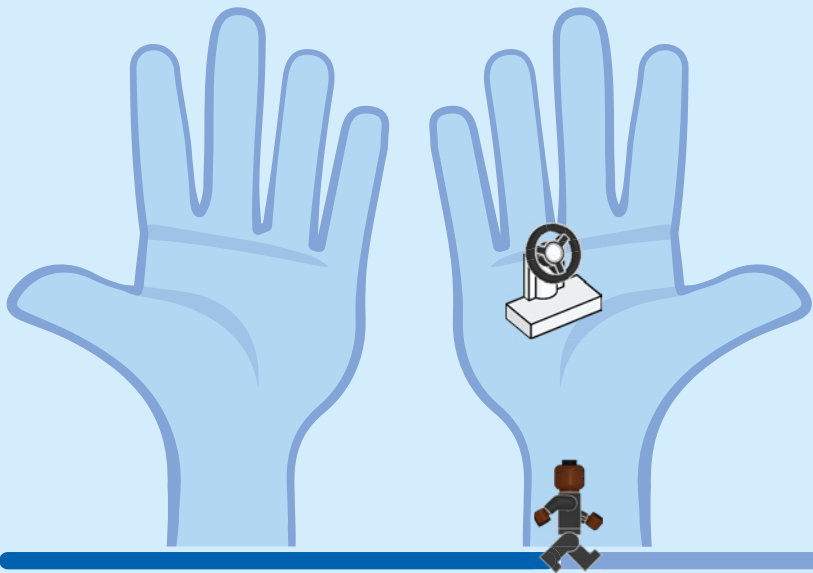

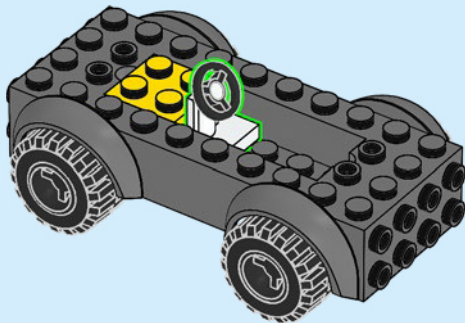



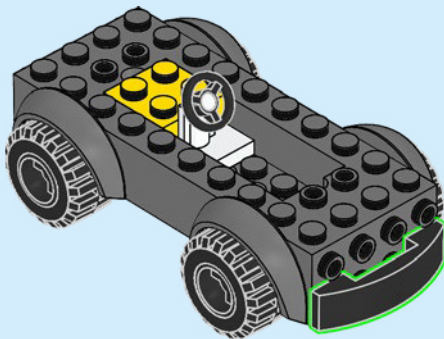

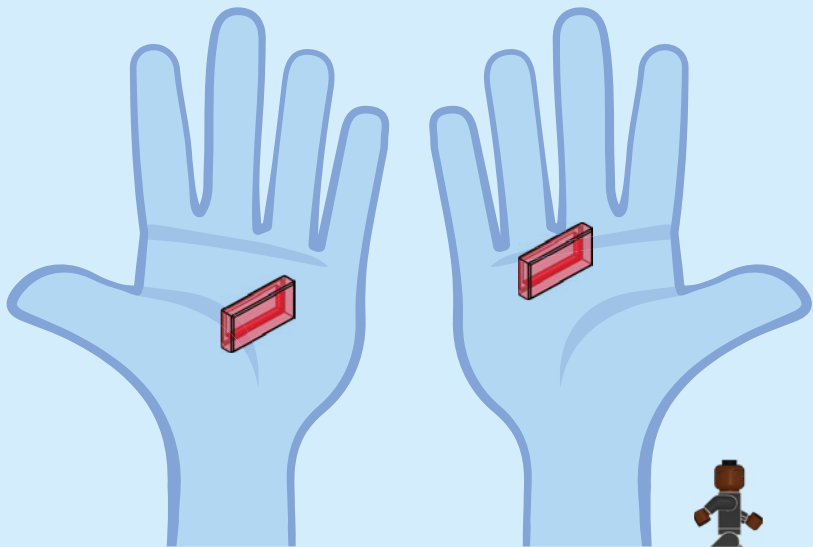



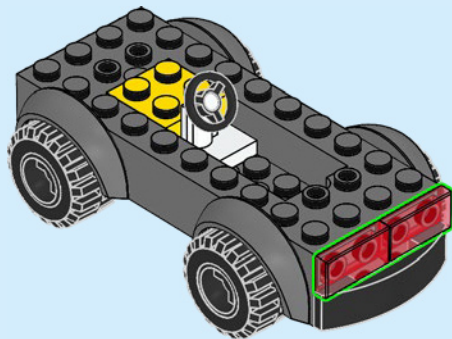

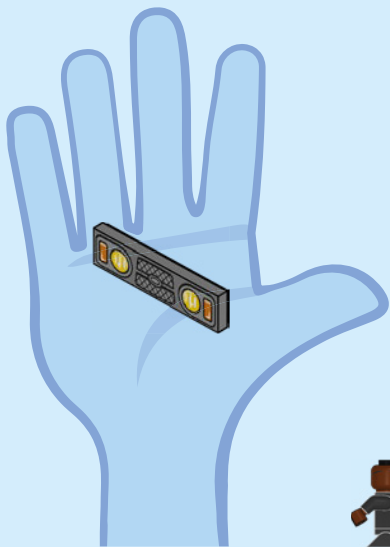

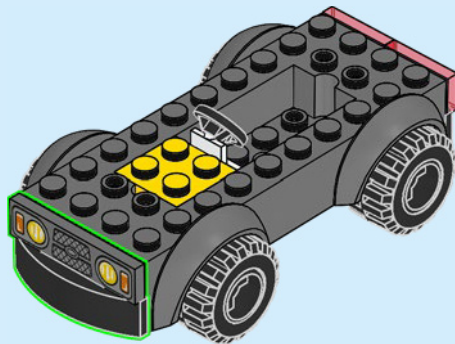

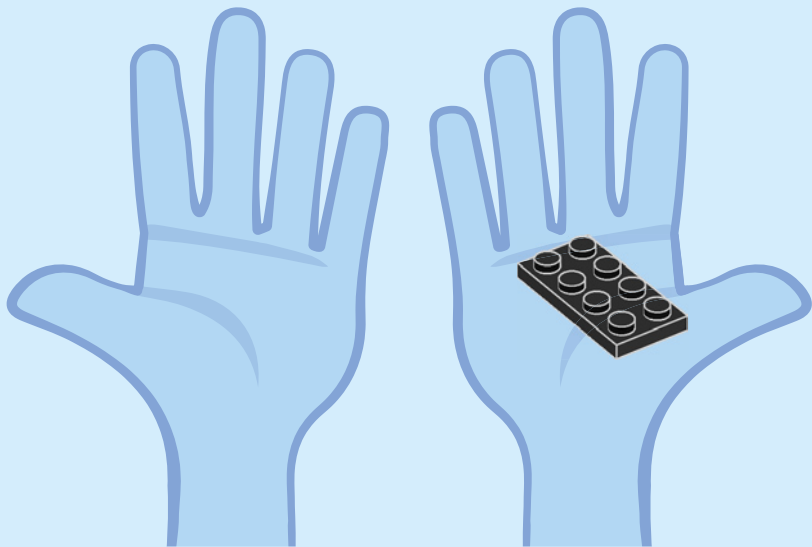

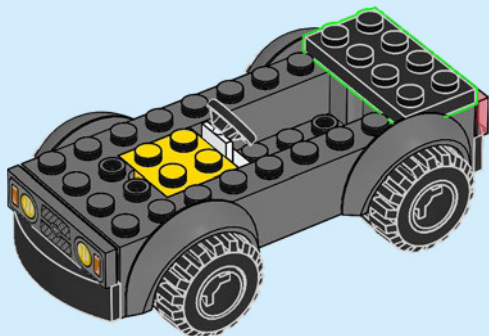

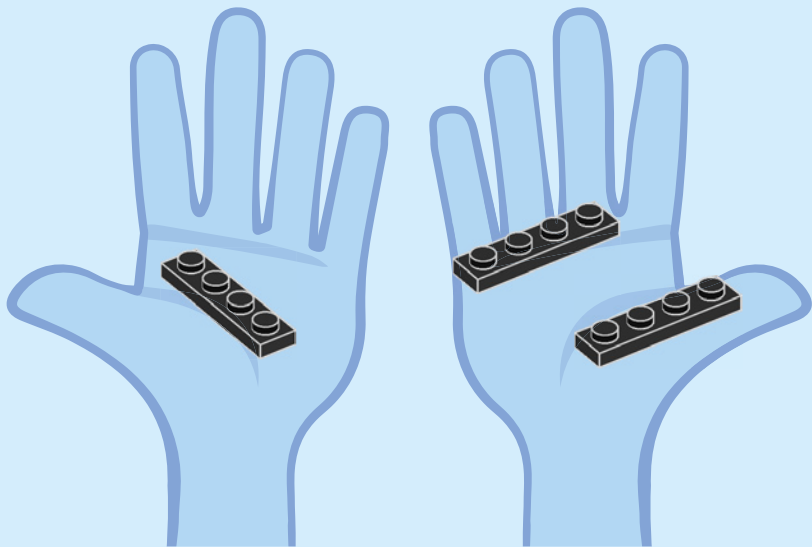

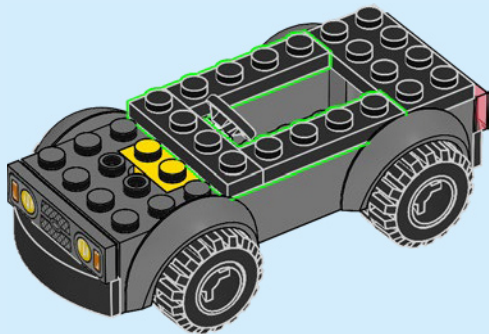

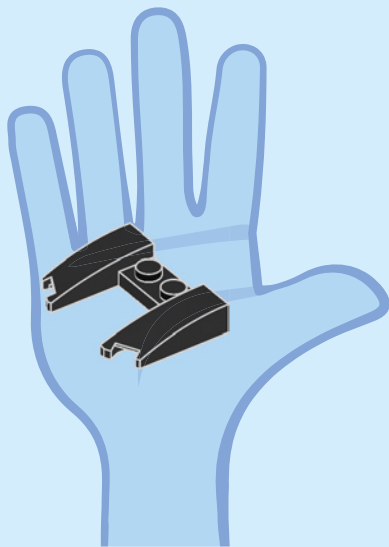
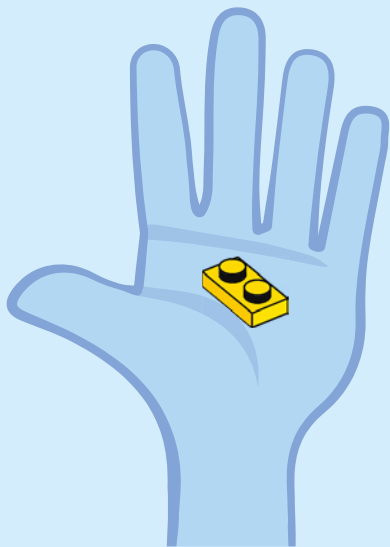



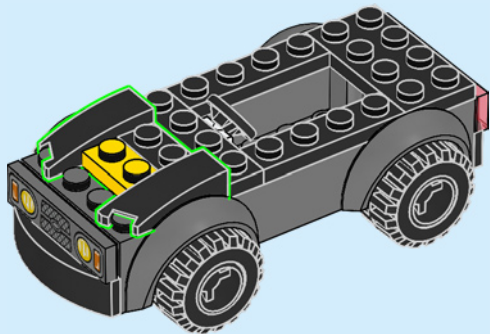

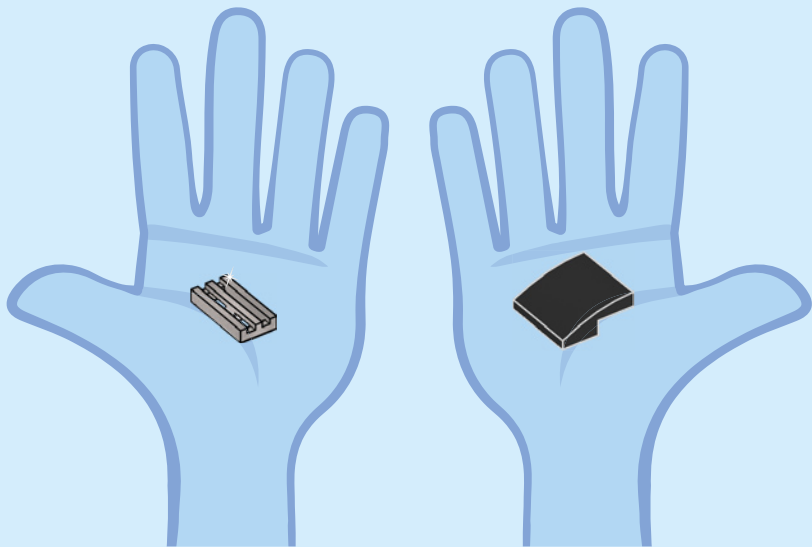

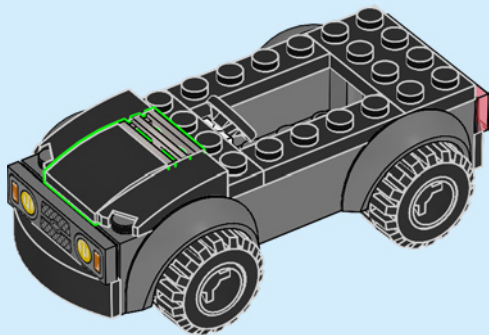

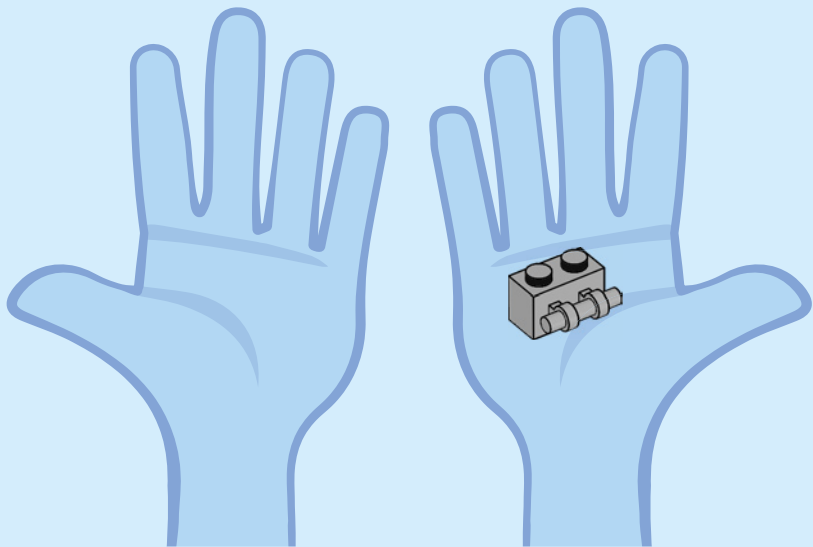

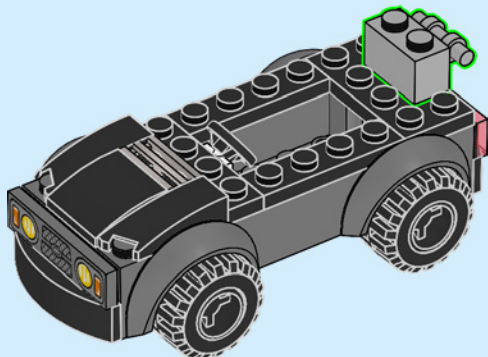

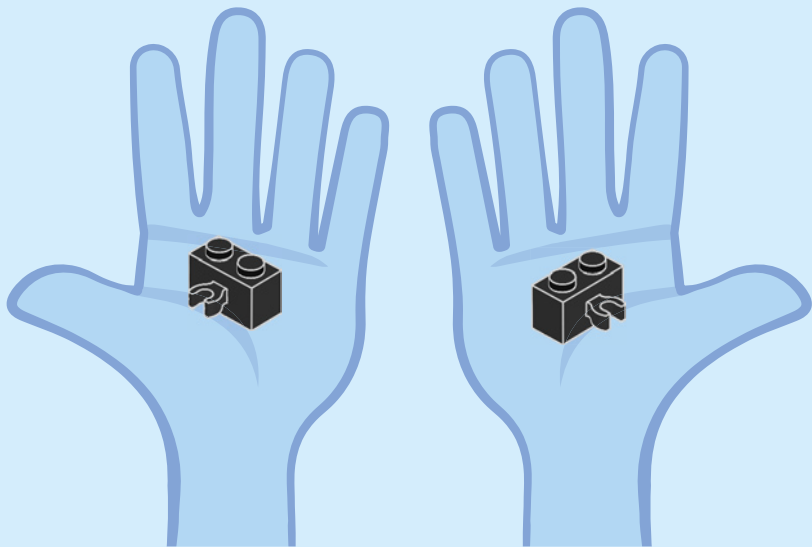

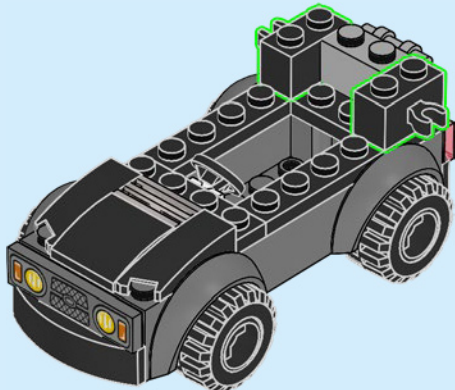

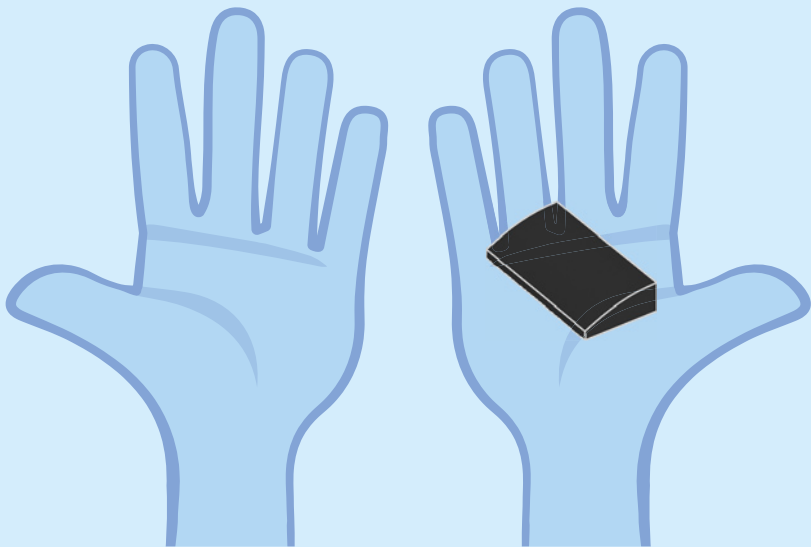



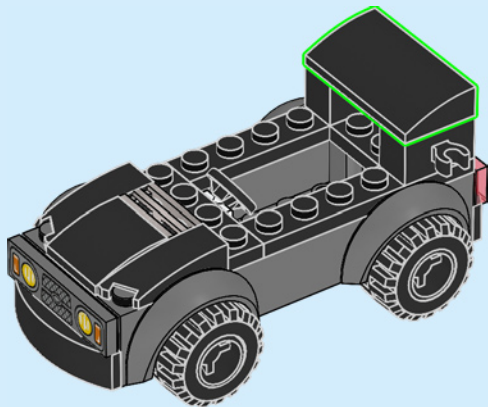

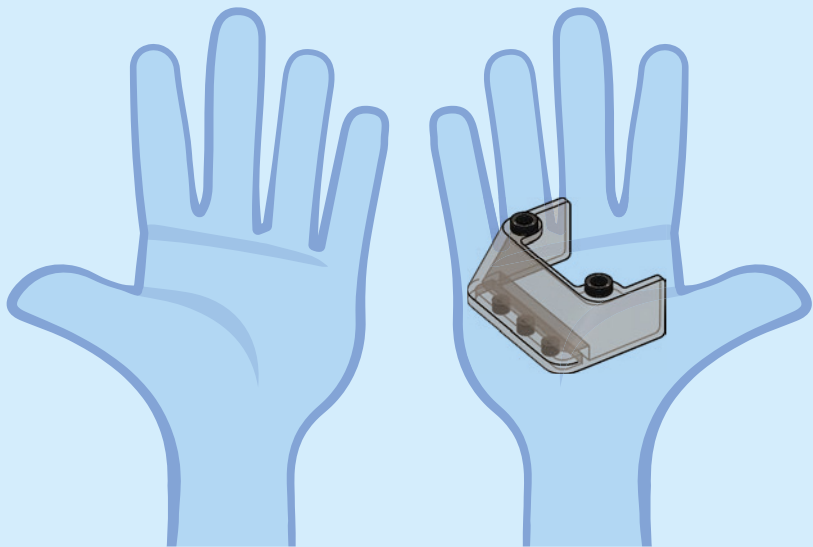

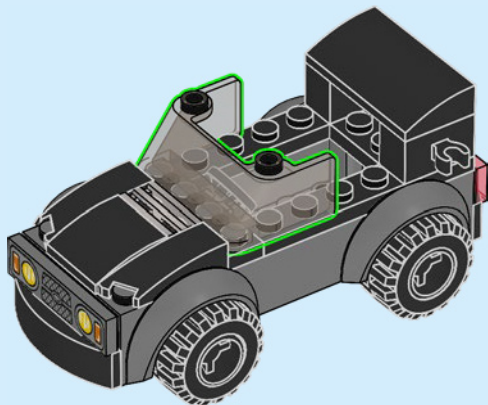

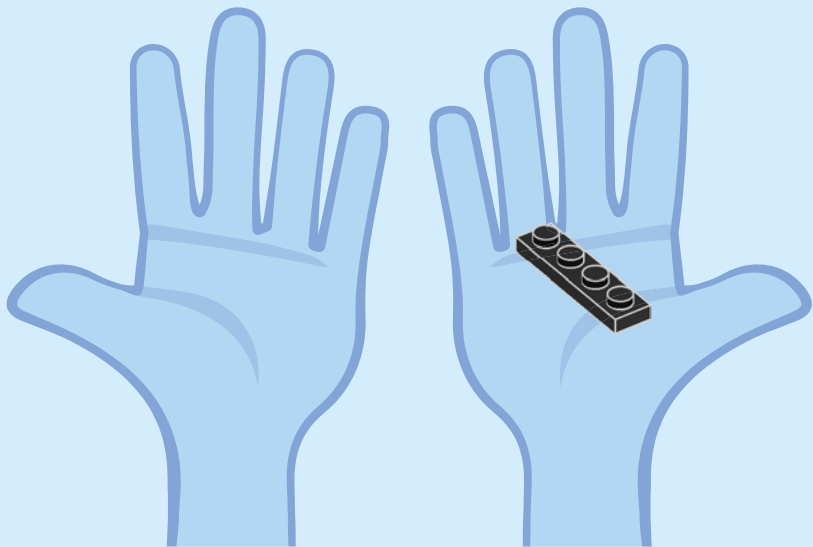

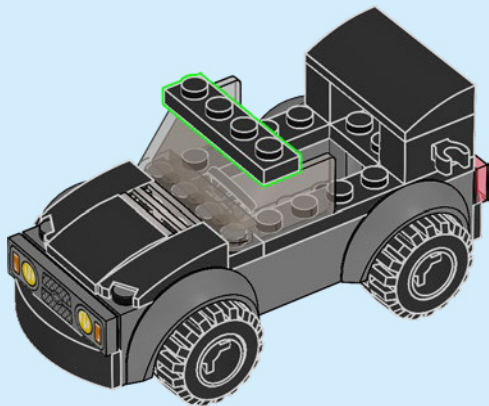

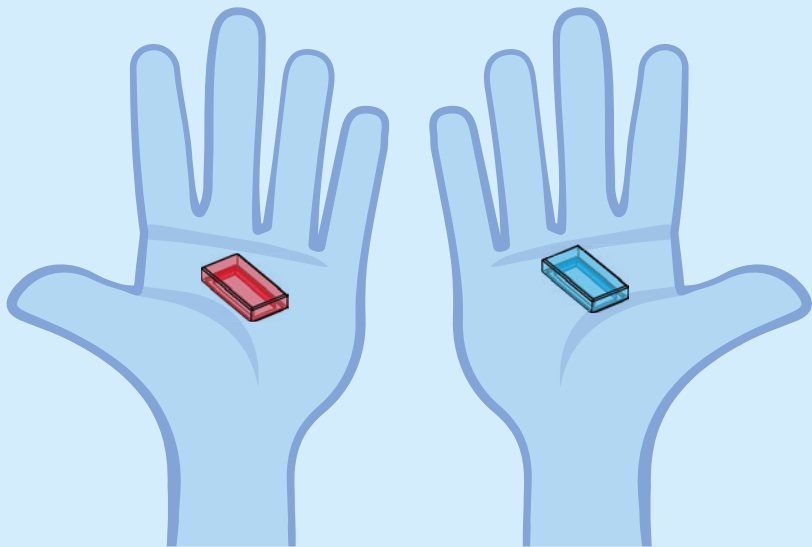

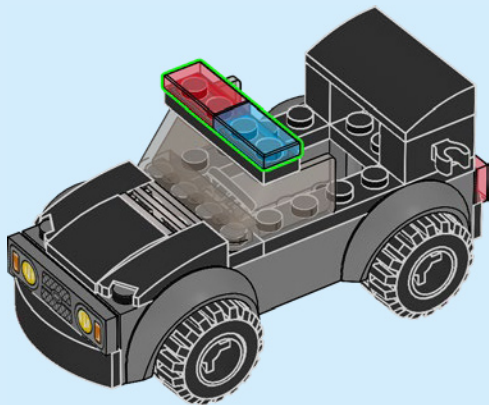

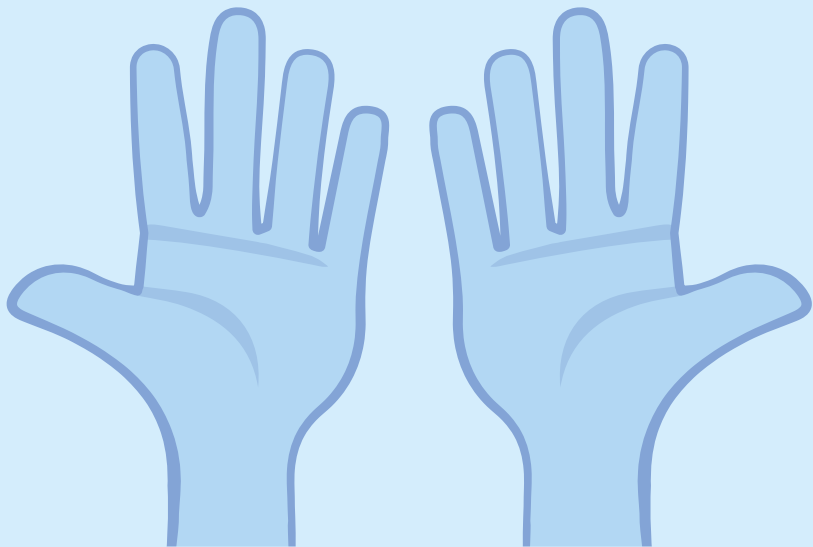



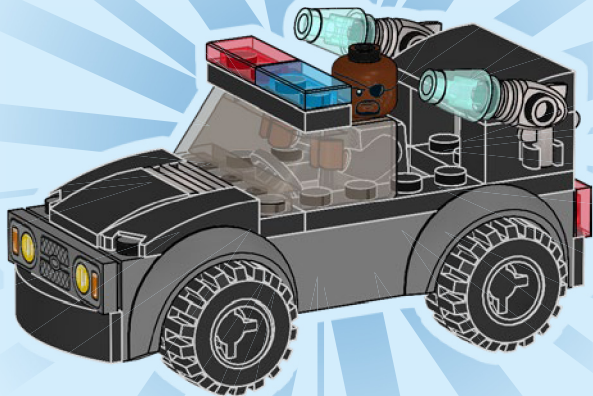



1x  
9551



2x  
4195869



1x  
4508408



1x  
6006221



1x  
6096959  
**50**



1x  
6349786



1x  
6368665



1x  
302324



1x  
300324



2x  
6321194



1x  
6170545



4x  
6286850



1x  
6363243



1x  
6308975



2x  
6330197



4x  
4568644



1x  
6053077



2x  
4613153



1x  
6356162



4x  
371026



1x  
4587844



1x  
302026



1x  
6179660



1x  
6267014



1x  
6253360



3x  
6092766



2x  
4519195



1x  
6294957



1x  
6363240



1x  
6267012



2x  
6320306



1x  
6015344



1x  
4211580



1x  
4211386

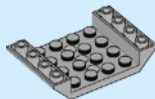

1x  
4549997



1x  
6251289



1x  
6247785



3x  
6251290



2x  
6337639



1x  
6368666



4x  
6251298



2x  
6046398



1x  
4619636



1x  
6151415



1x  
6324167

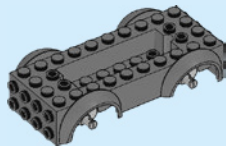

1x  
6250176



2x  
6291791



1x  
6223079



**Customer Service**  
**Kundenservice**  
**Service Consommateurs**  
**Servicio Al Consumidor**

**LEGO.com/service or dial**



**: 00800 5346 5555**

**: 1-800-422-5346**



LEGO and the LEGO logo are trademarks of the LEGO Group. ©2021 The LEGO Group.  
© Marvel © CPII

Rebuild  
the  
world™



6390633