

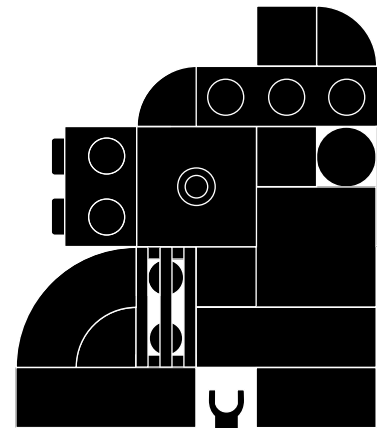

4

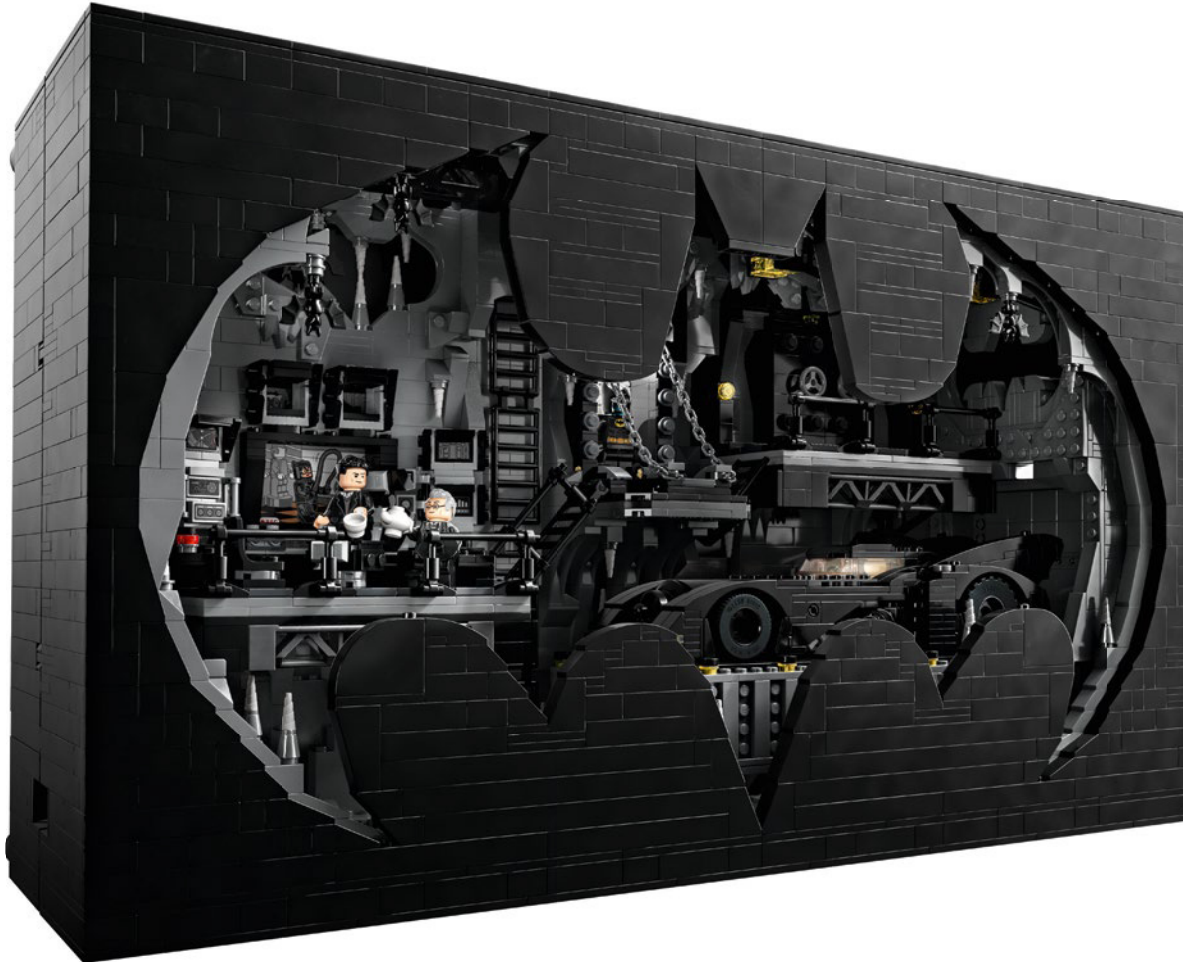

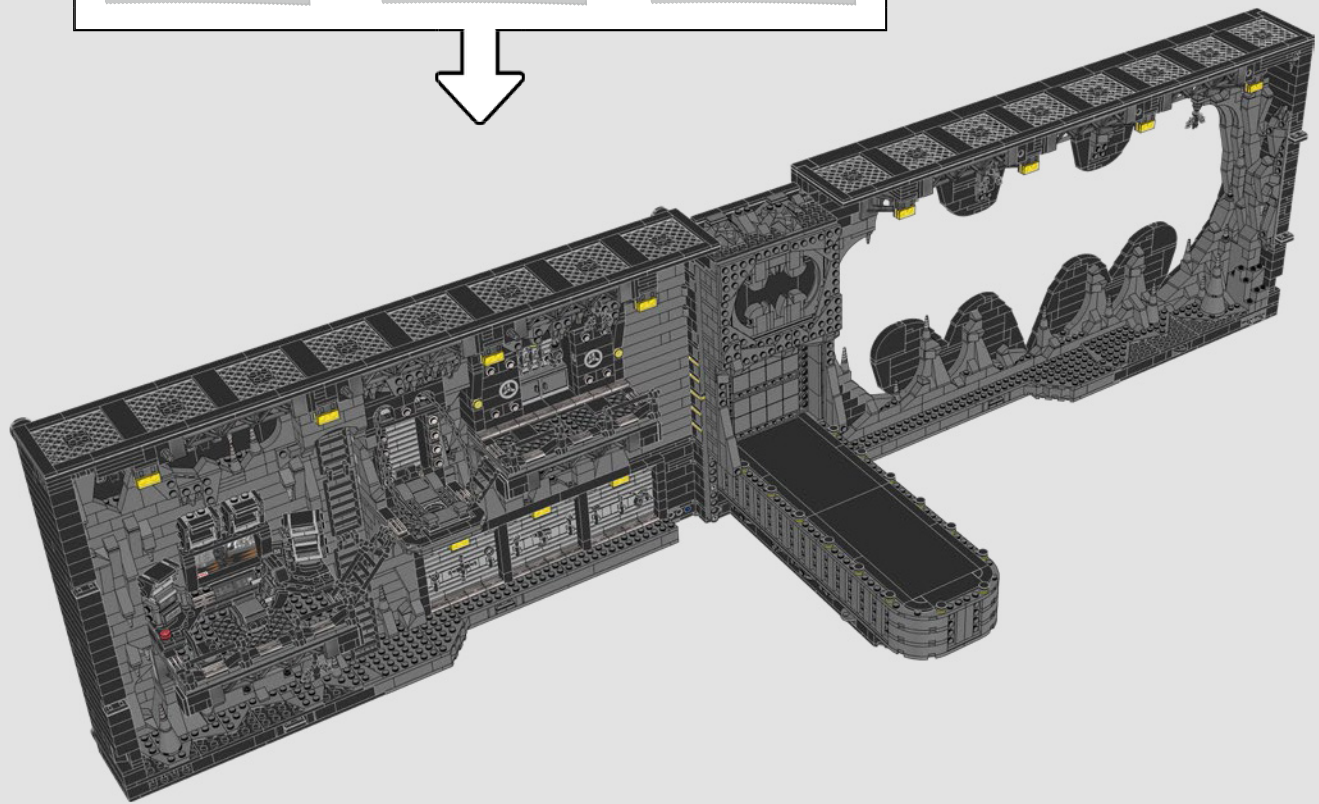

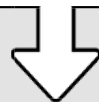

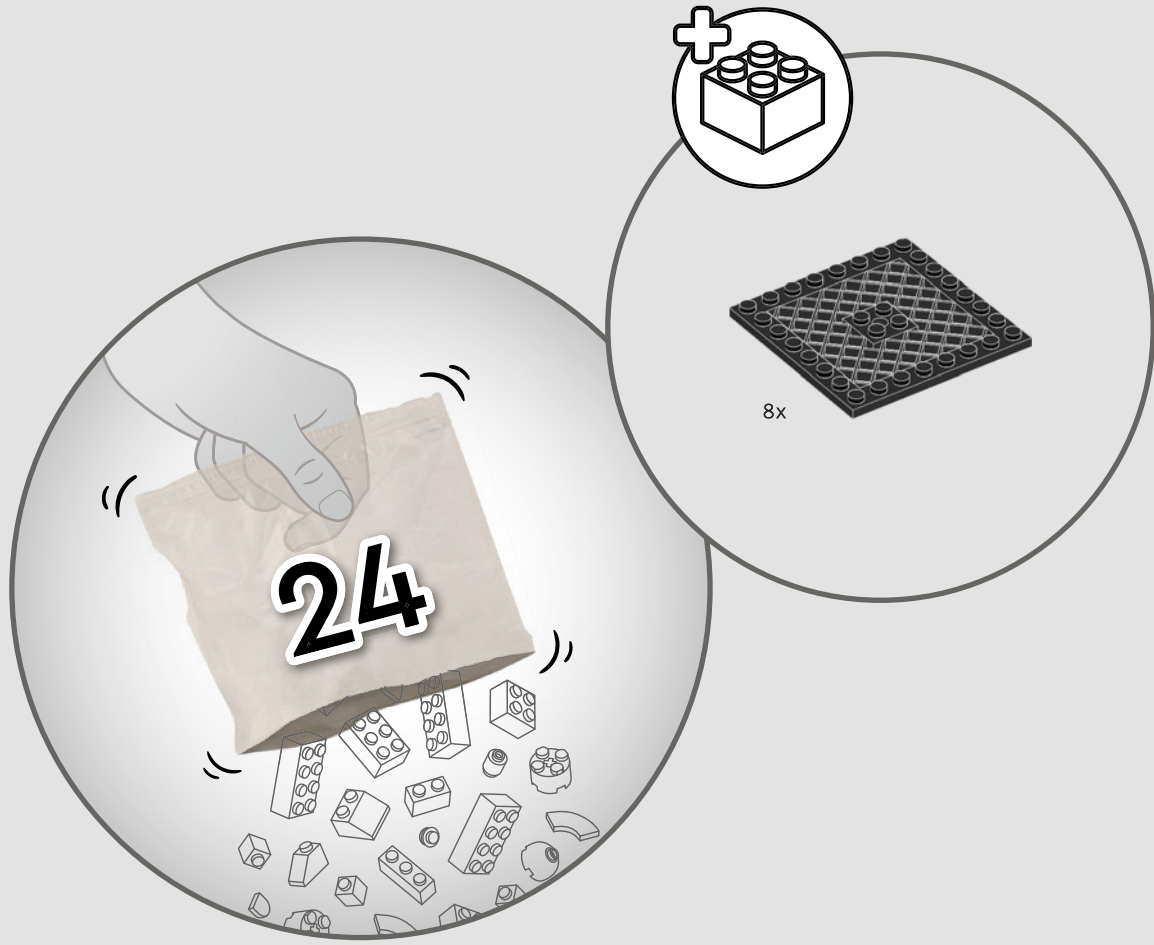

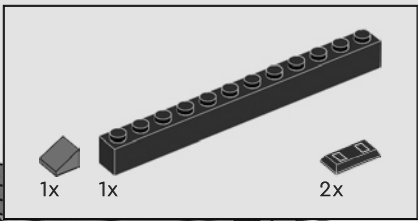

841

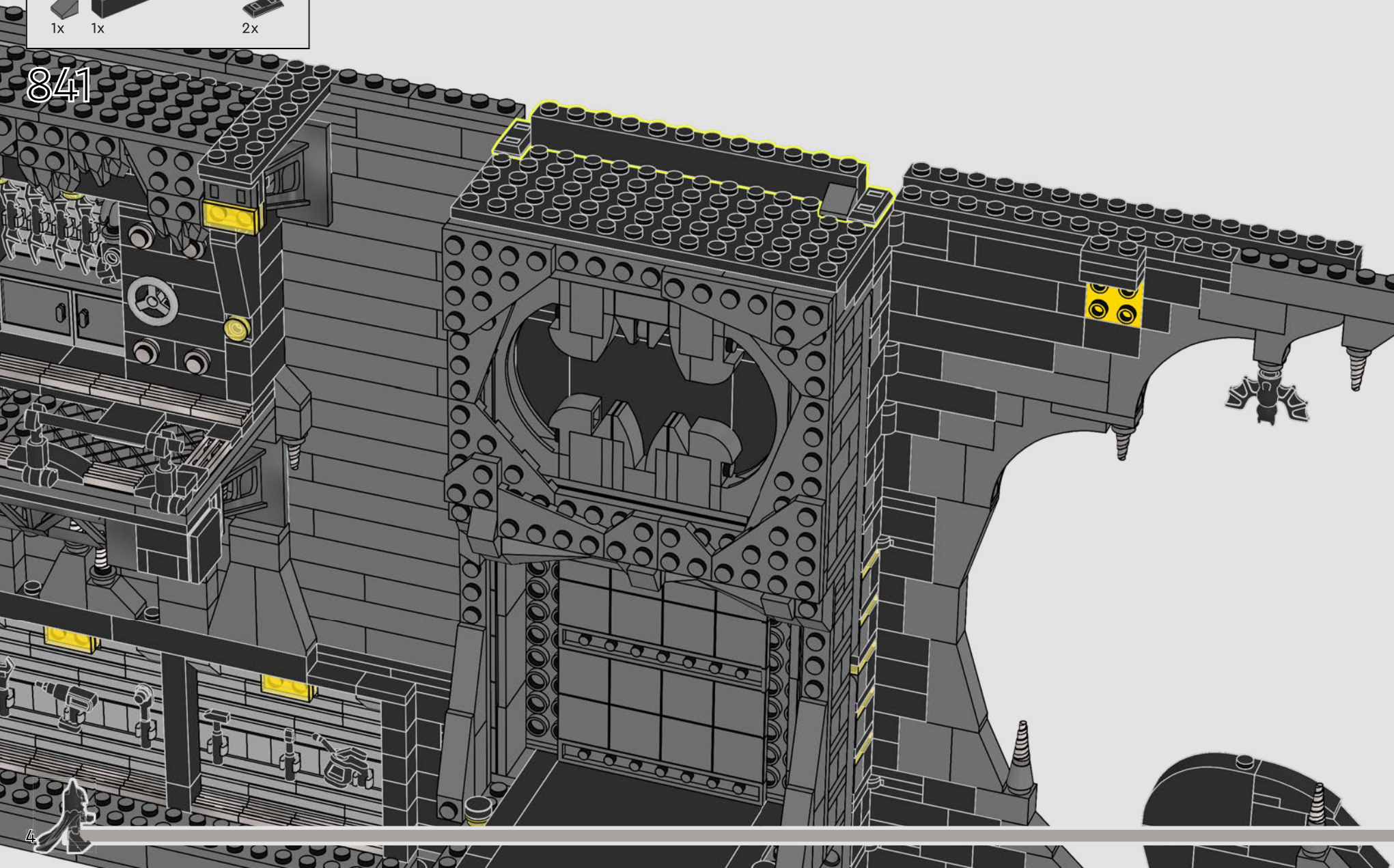

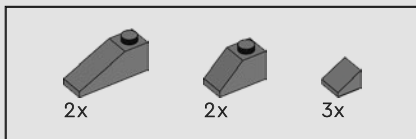

842

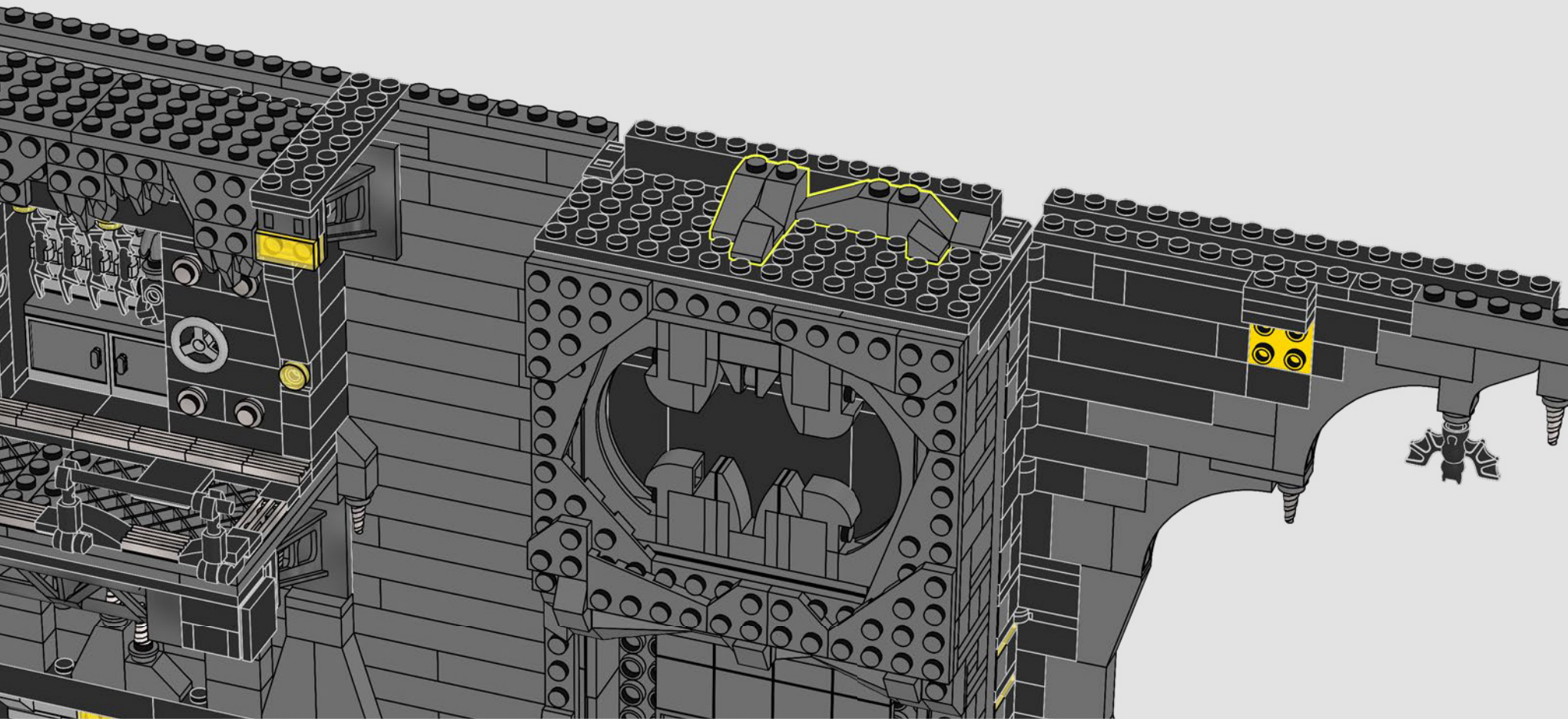



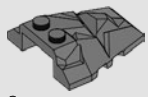

2x

843

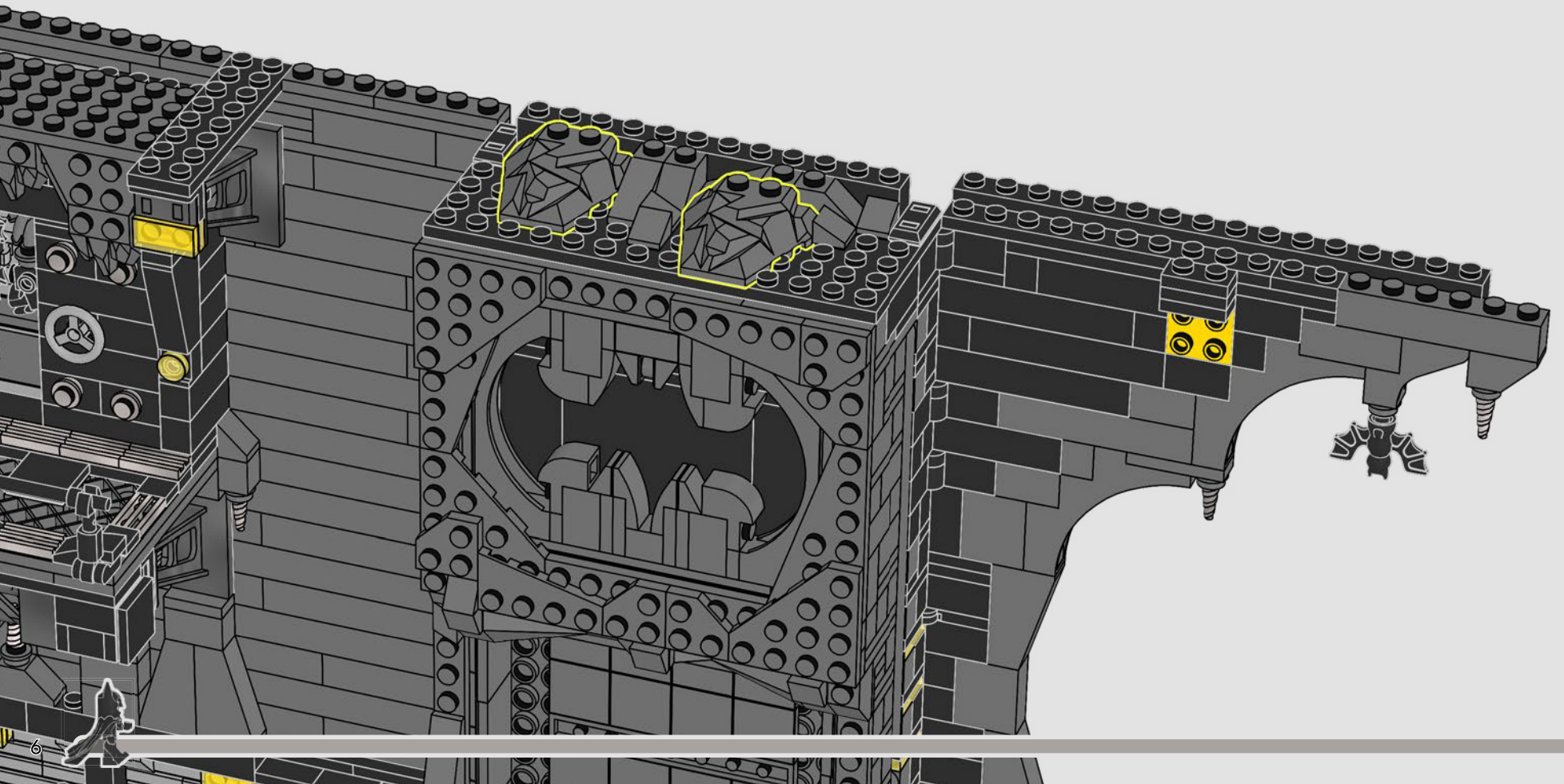



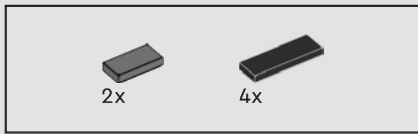

844

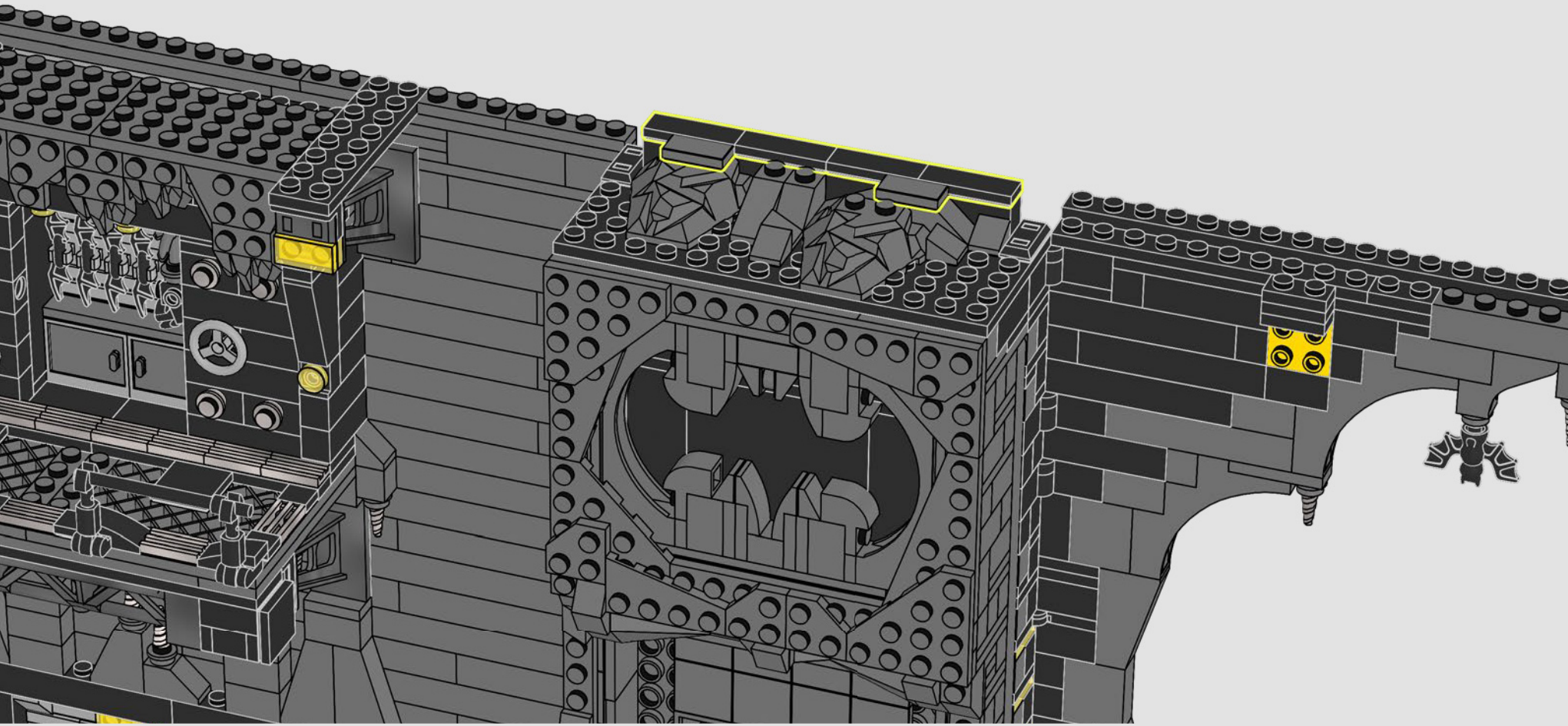

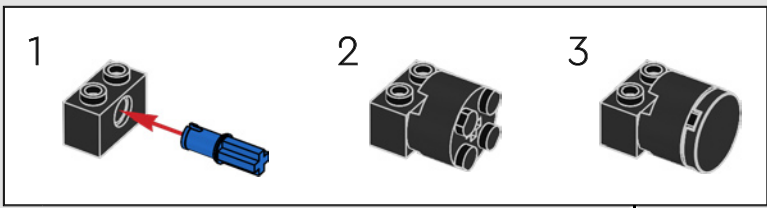
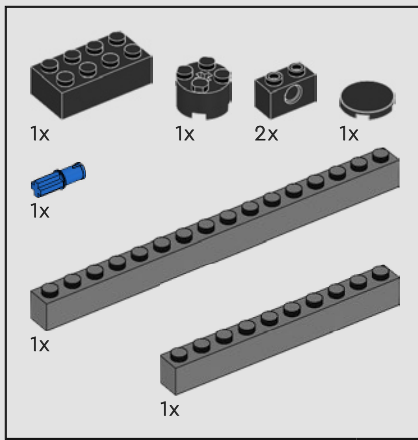

845

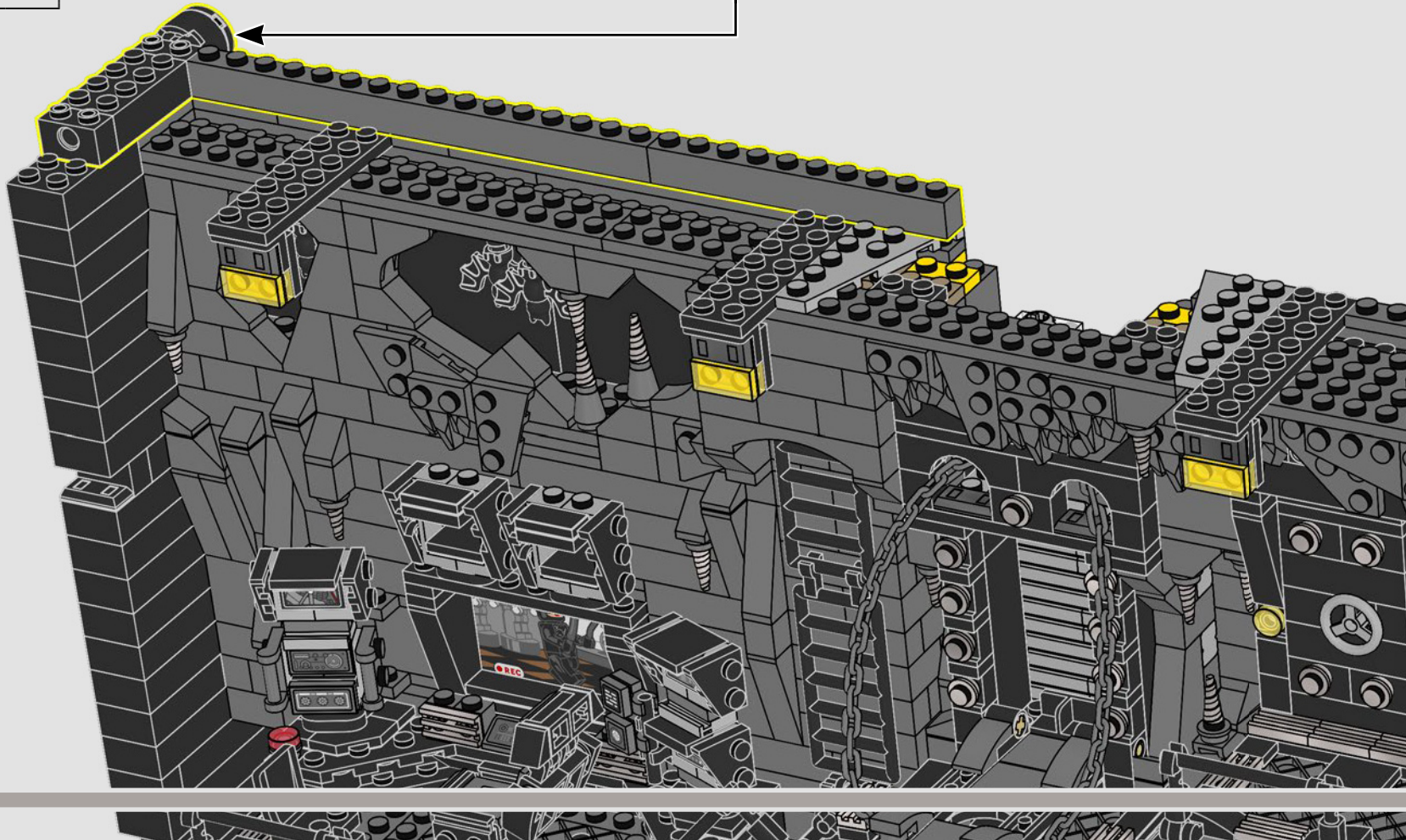



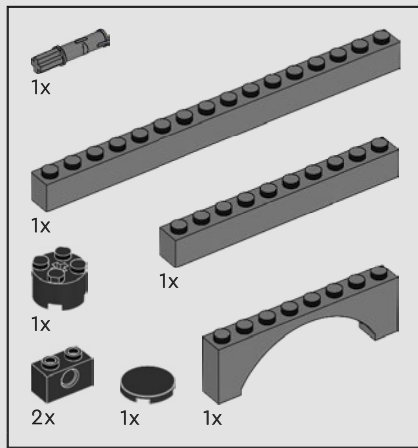

846

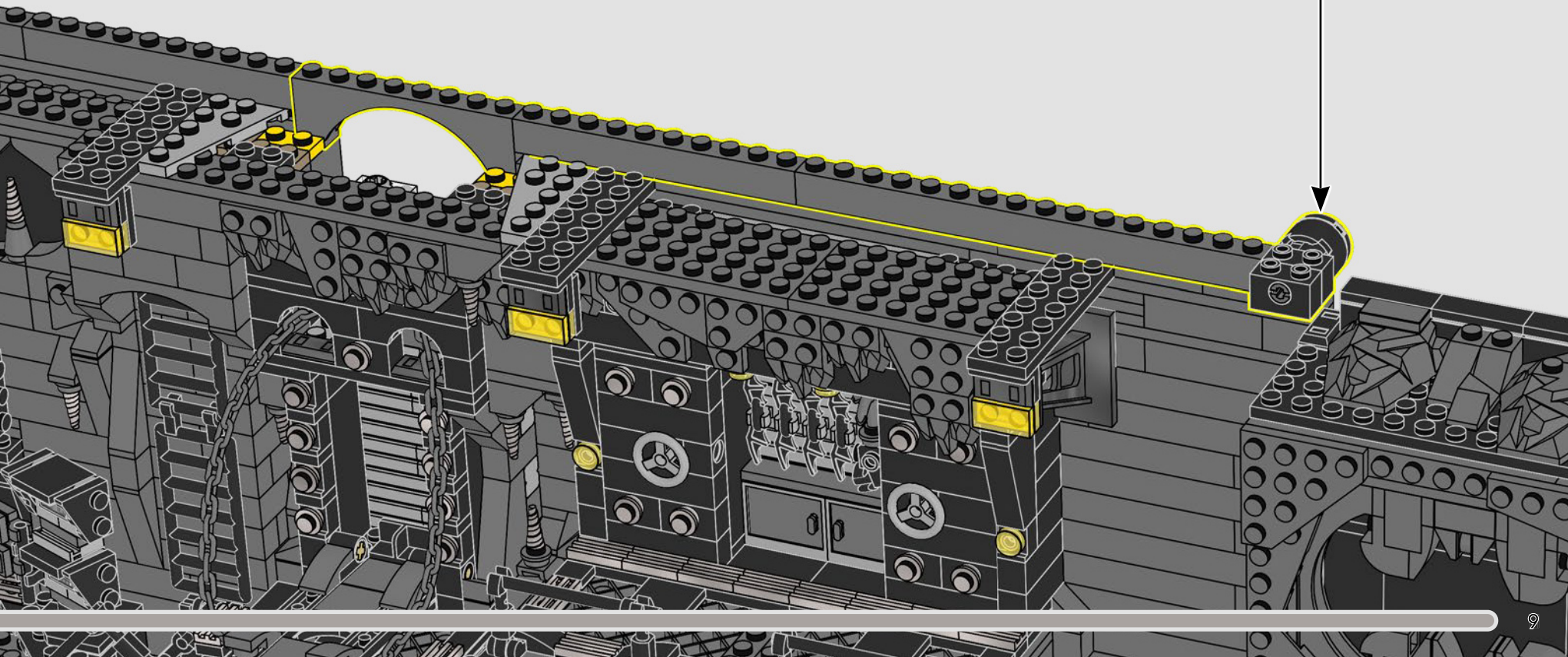
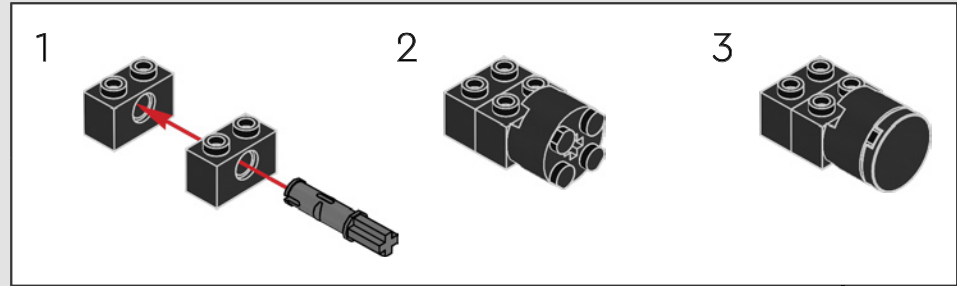



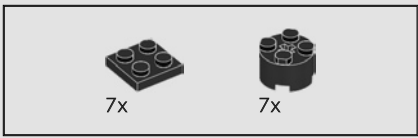

847

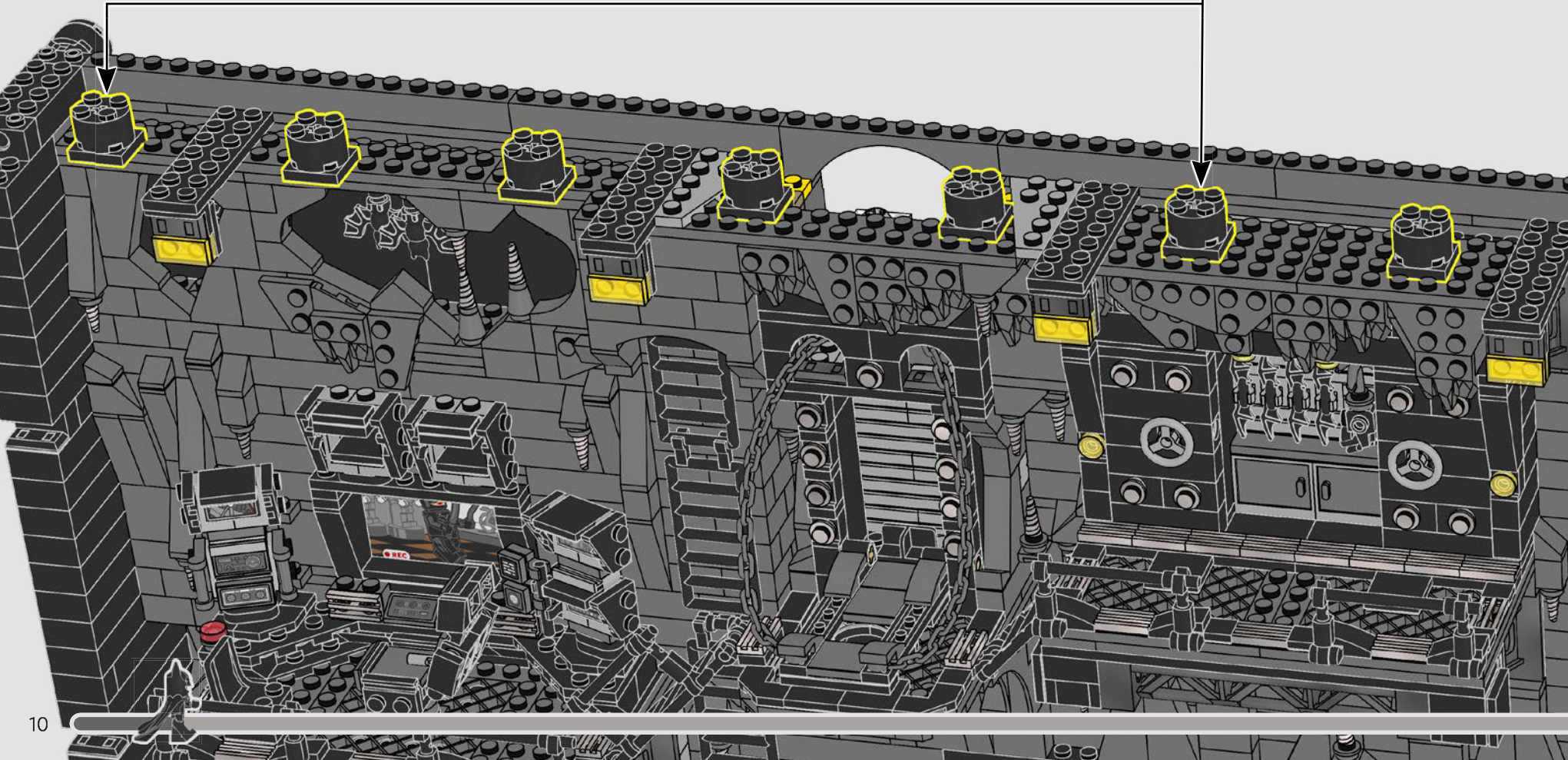
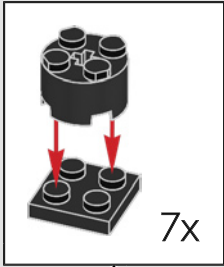



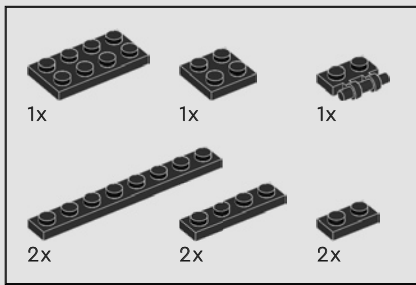

848

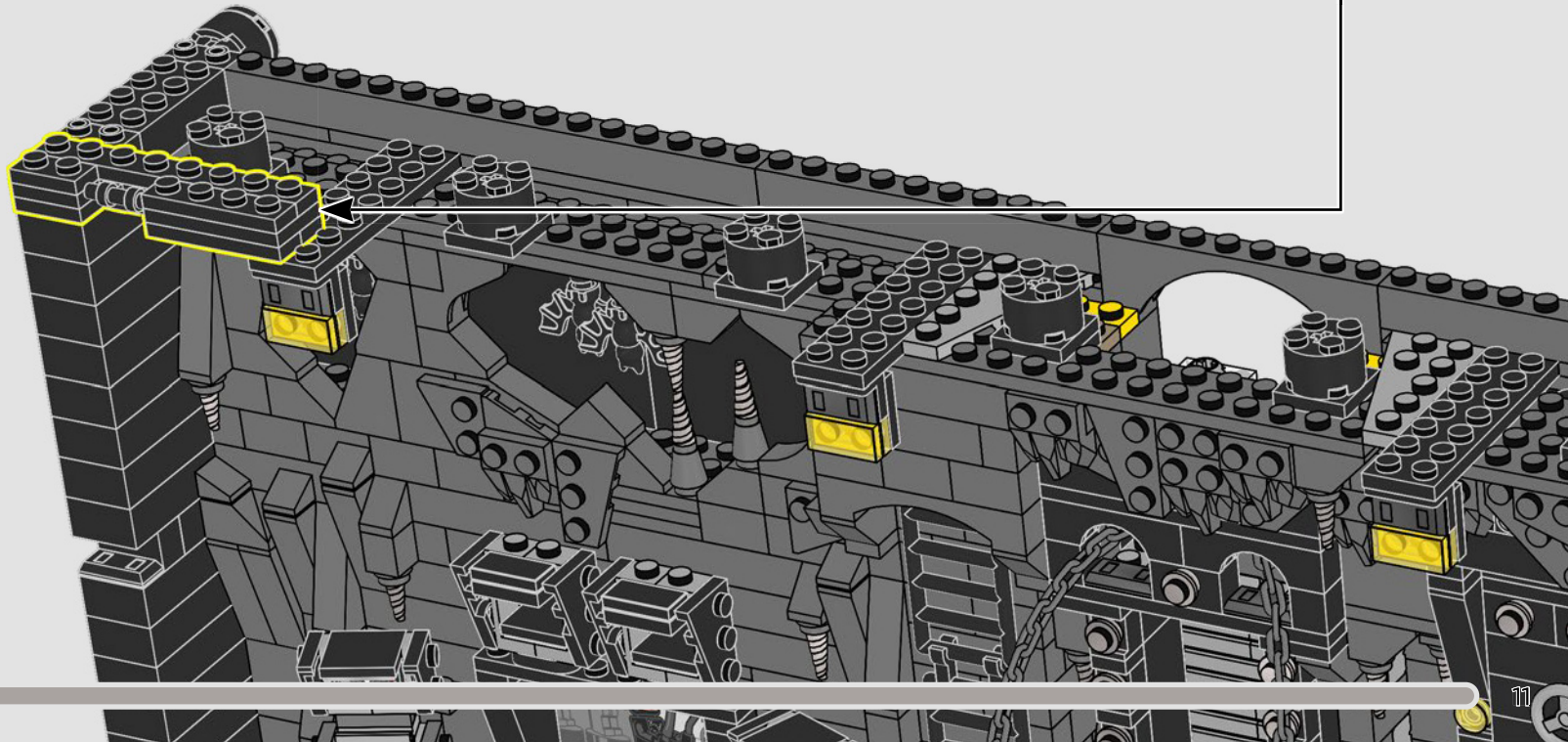
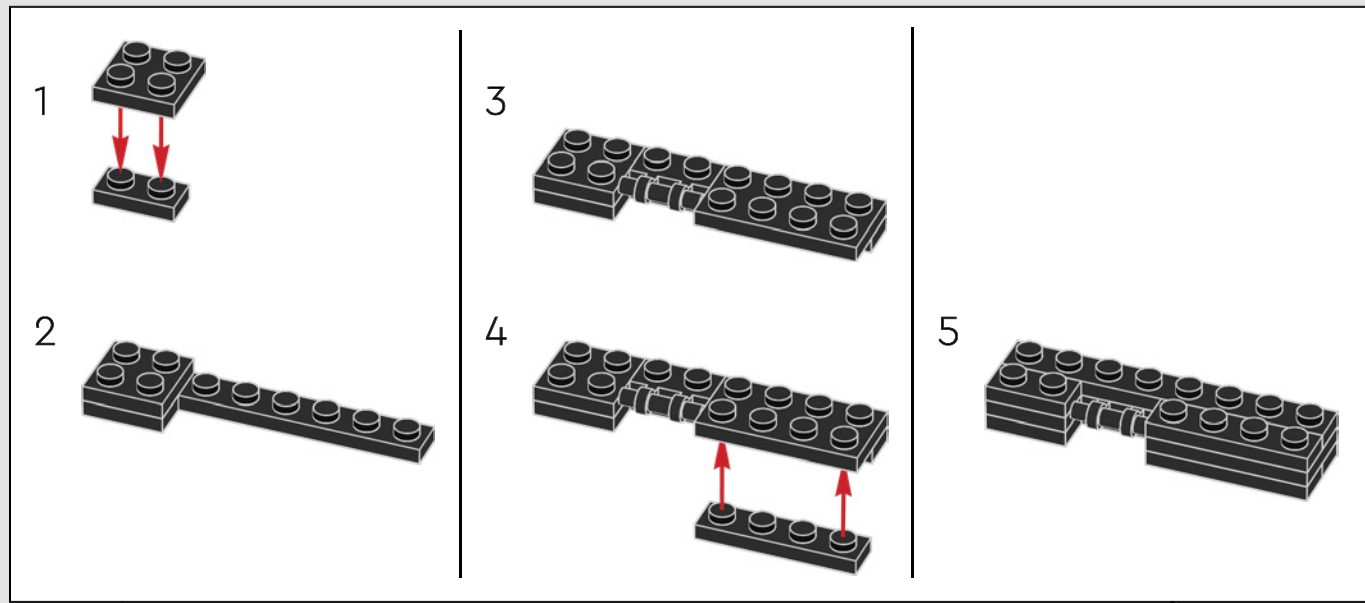

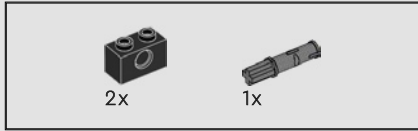
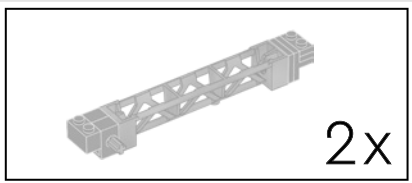

849

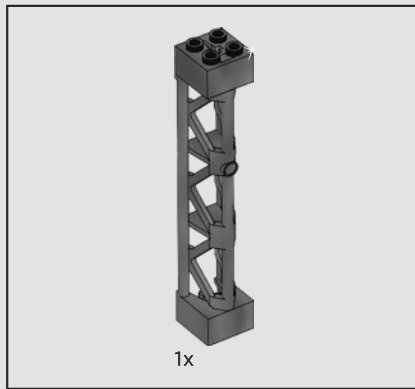
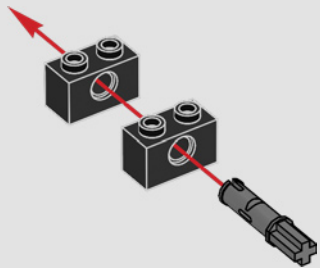

850

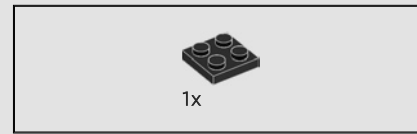
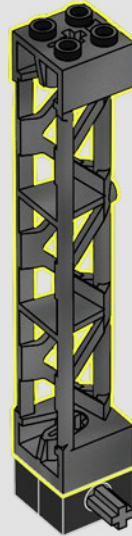

851

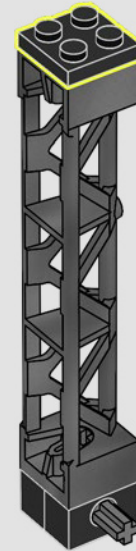

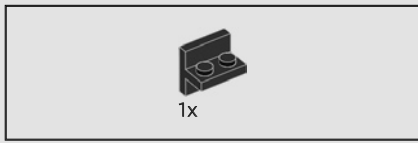

852

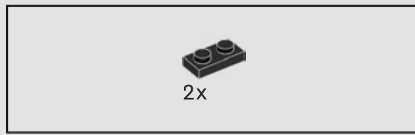
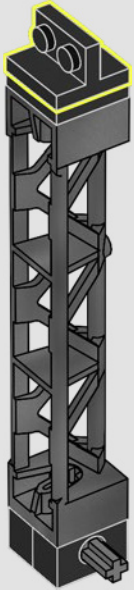

853

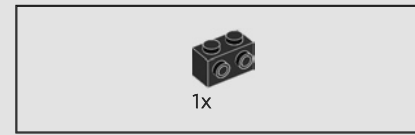
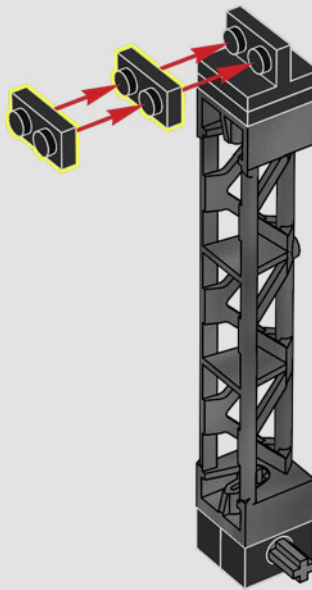

854

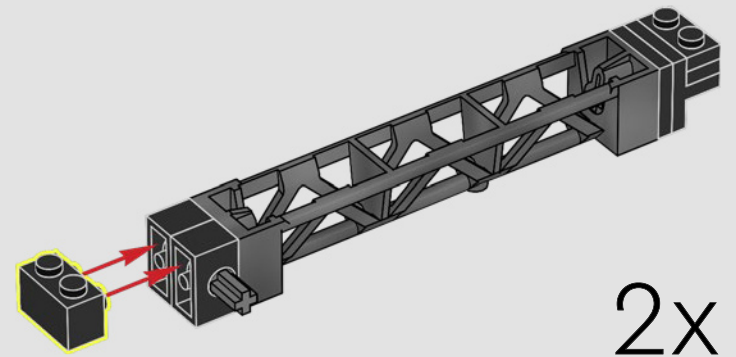
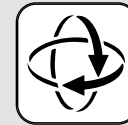

2x



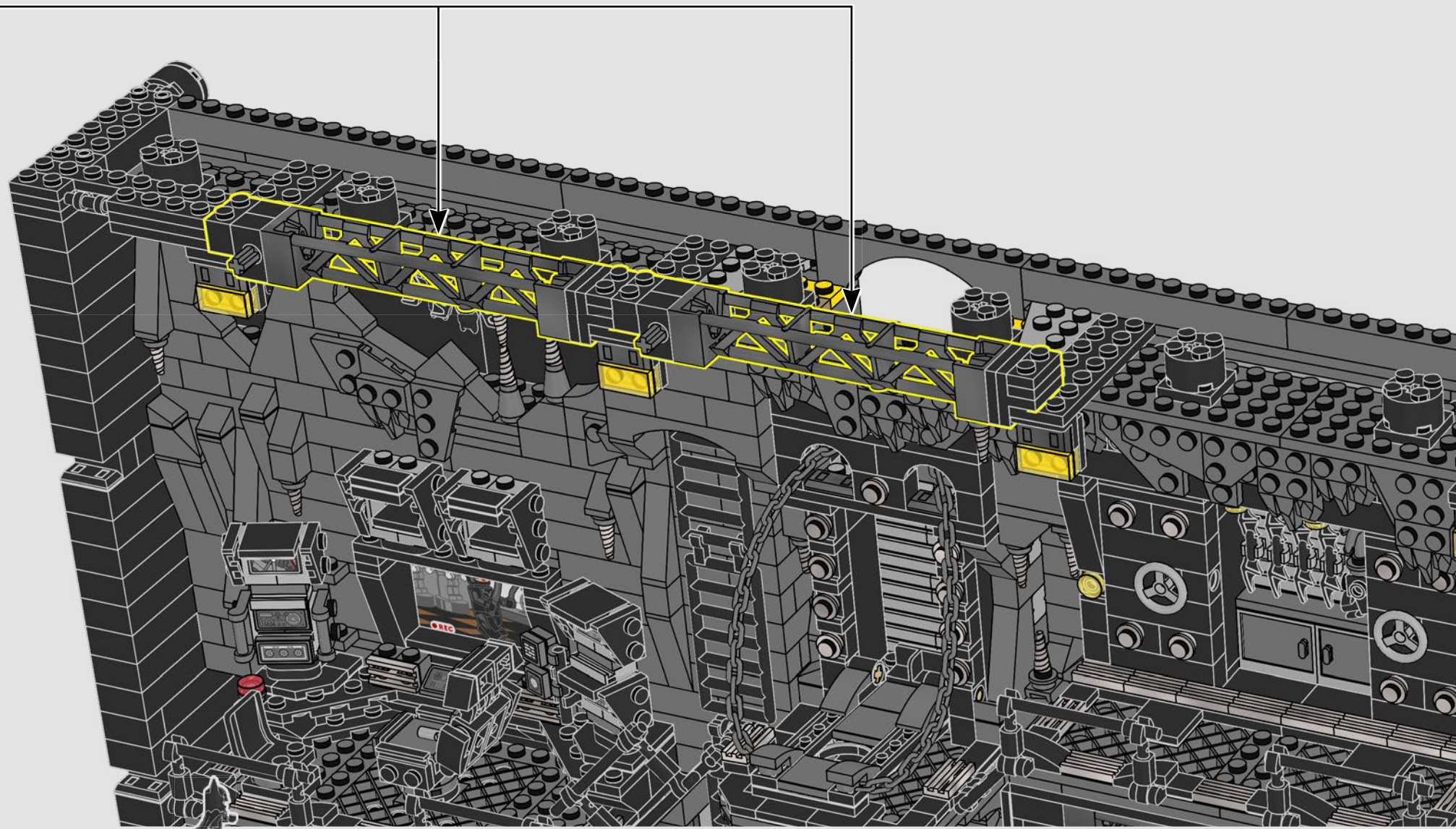



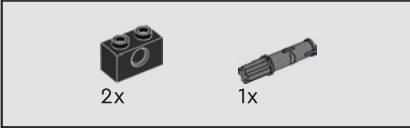
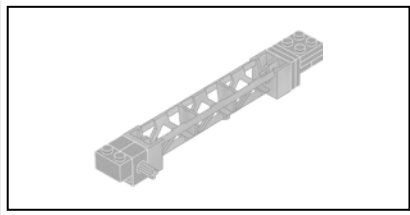

856

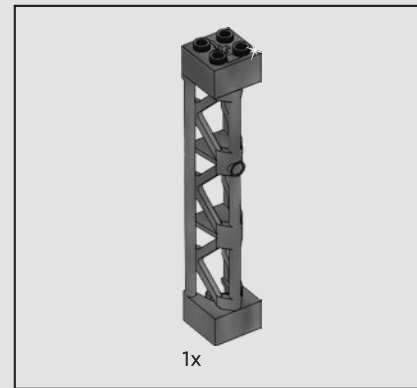
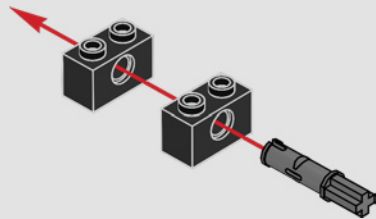

857

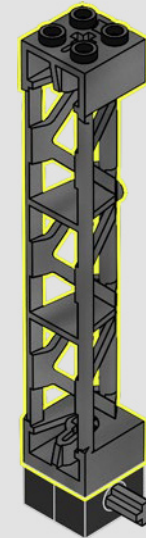



1x

858

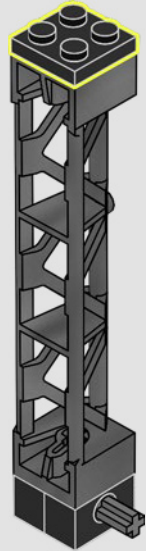

1x

859

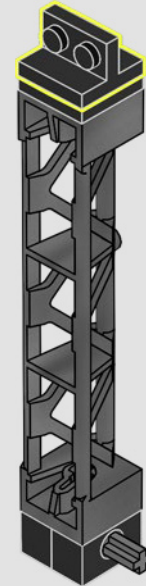

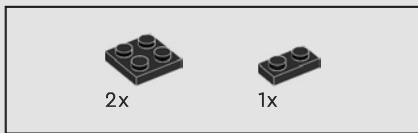

860

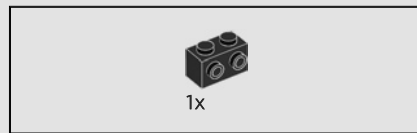
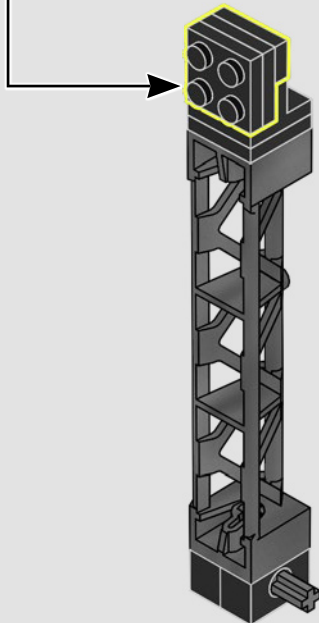
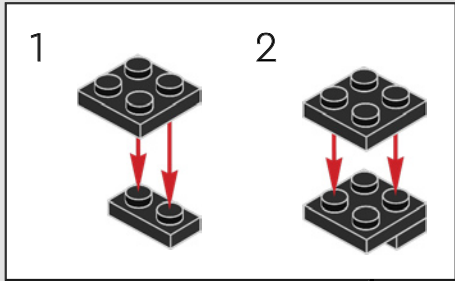

861

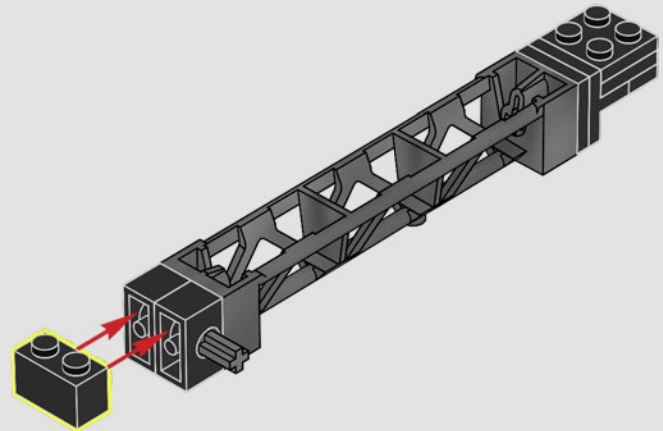
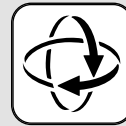

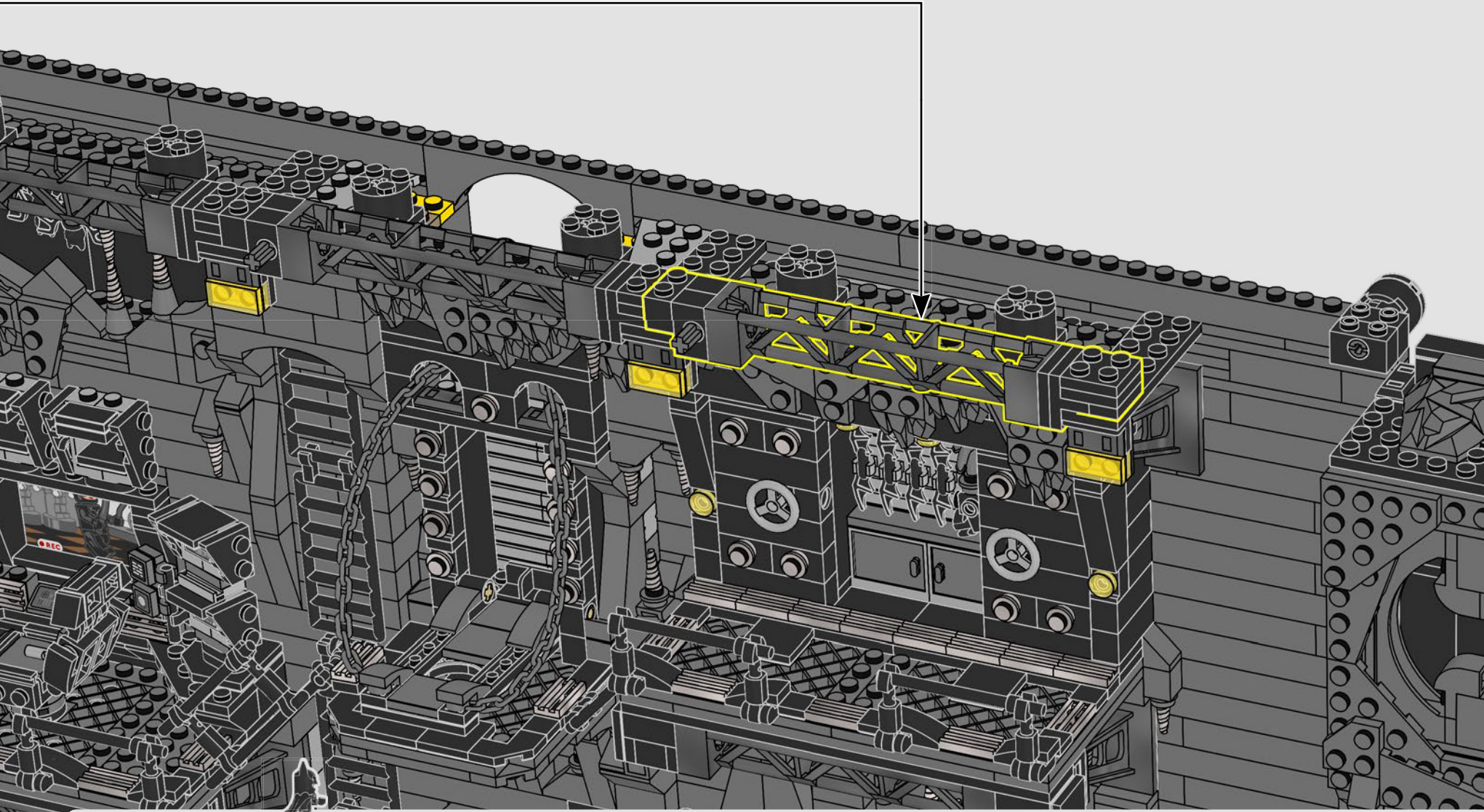



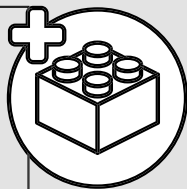
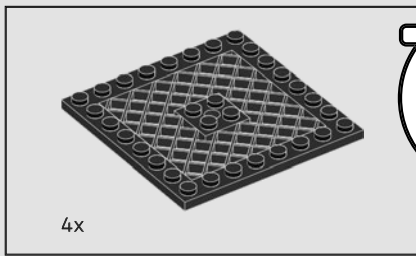

863

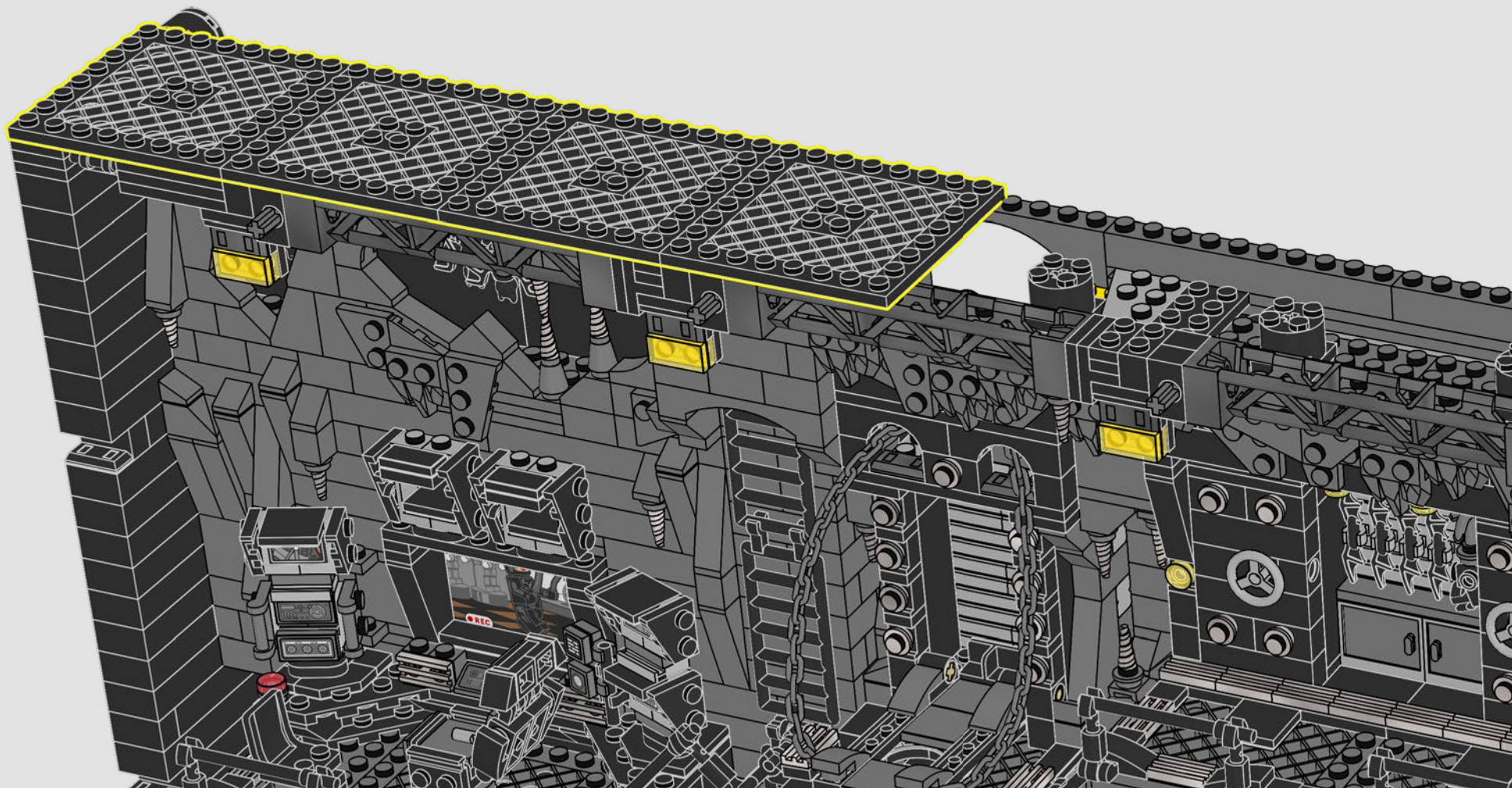



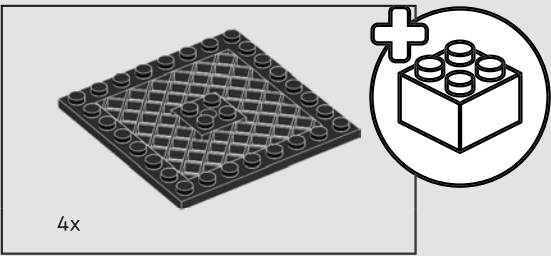

864

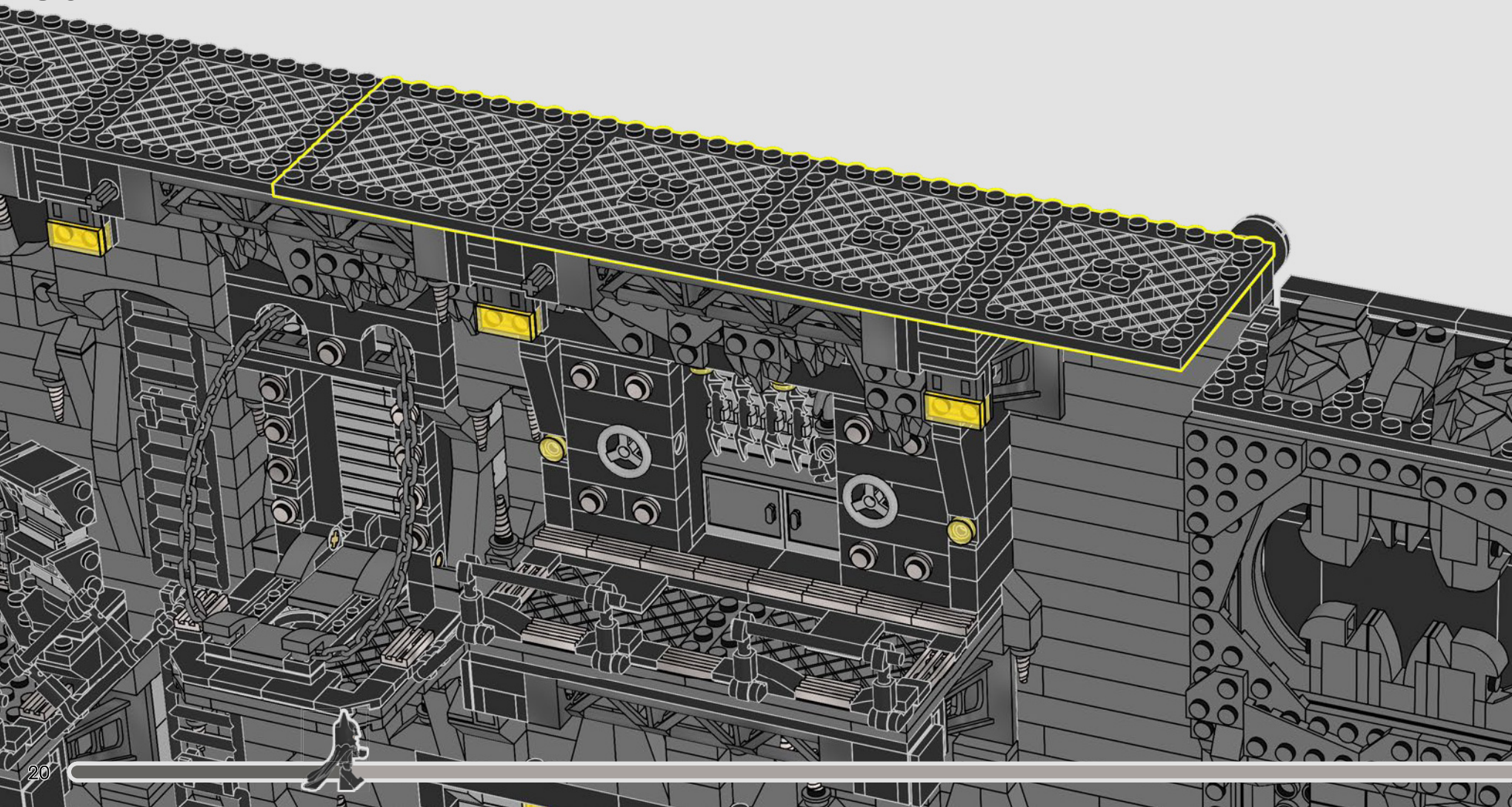



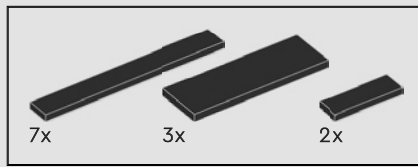

865

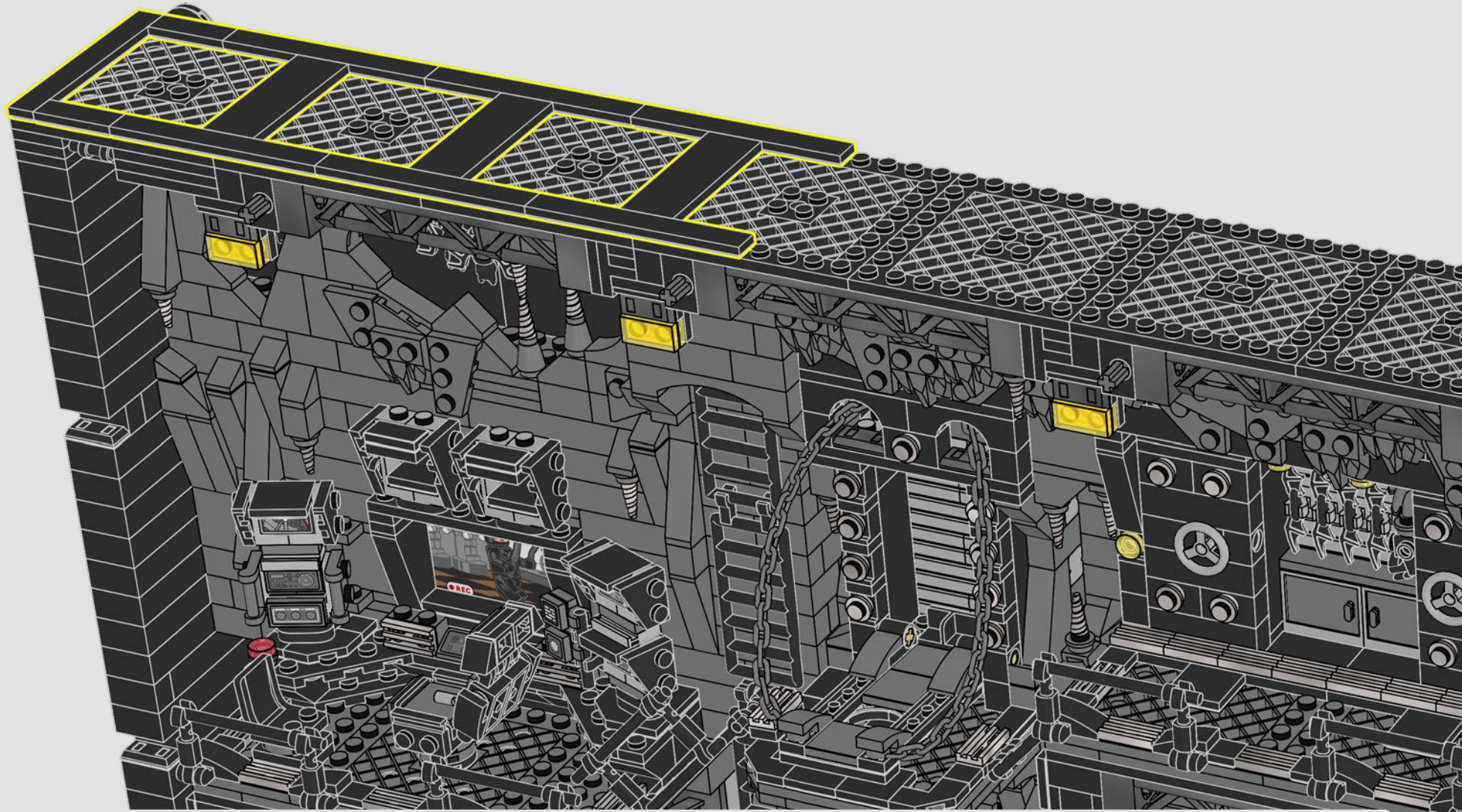



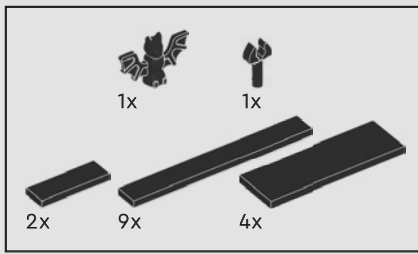

866

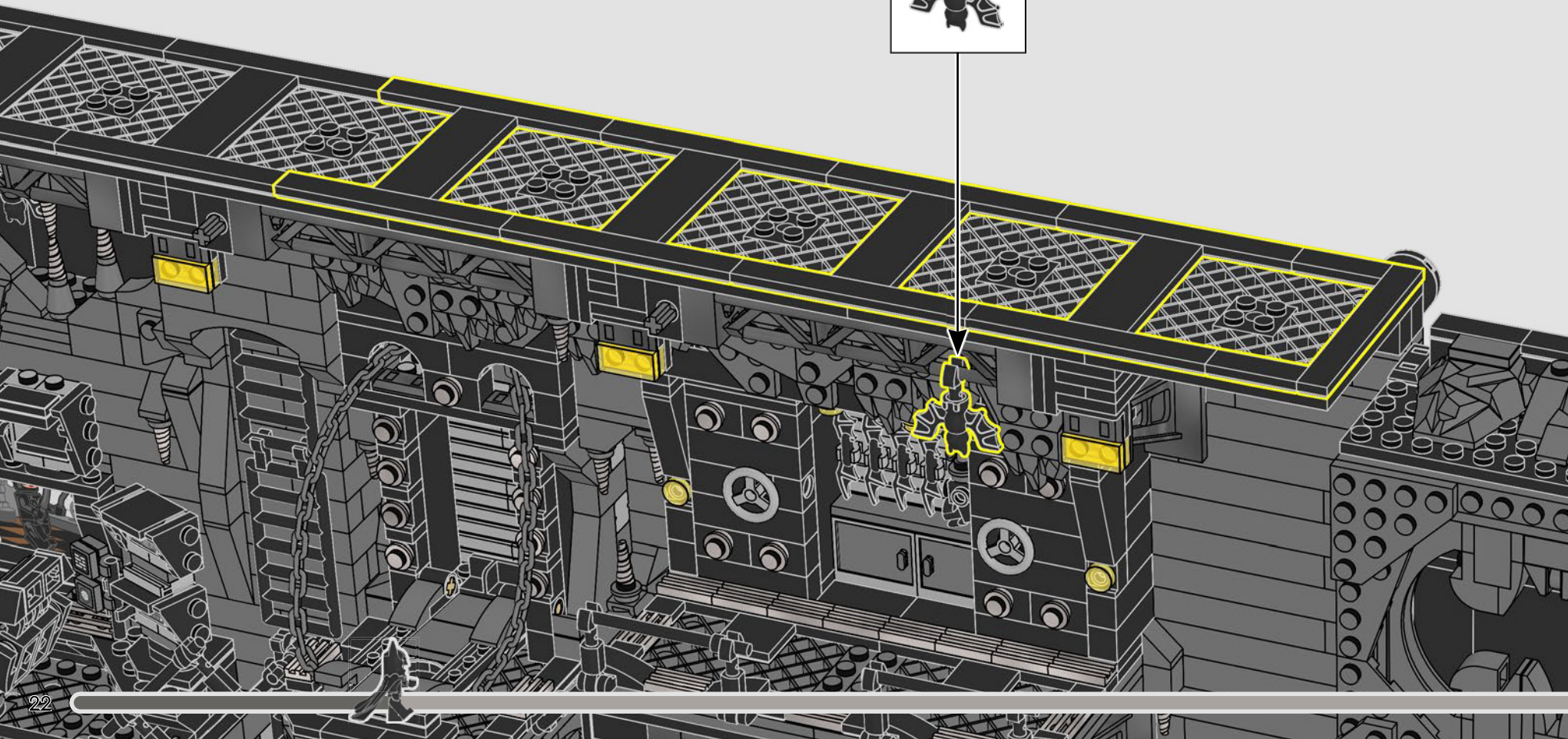
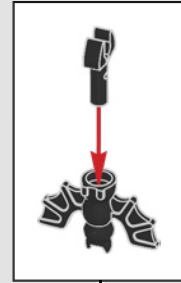





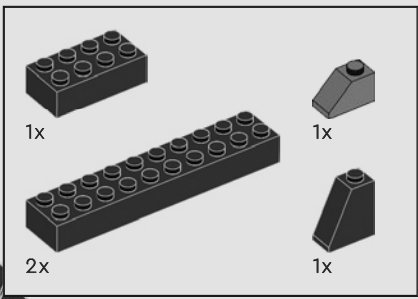

867

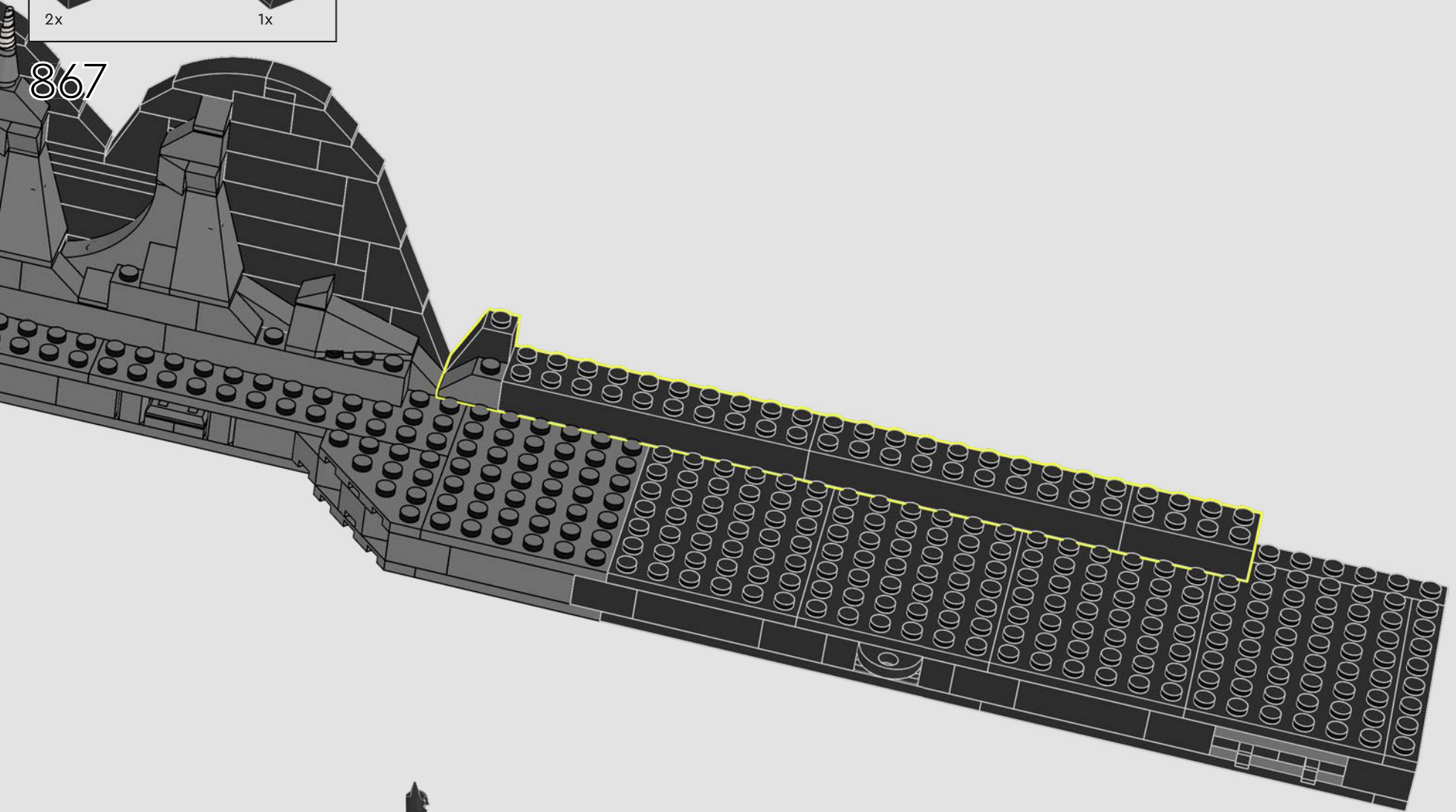

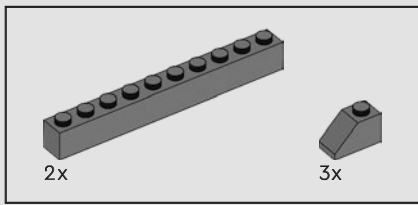

868

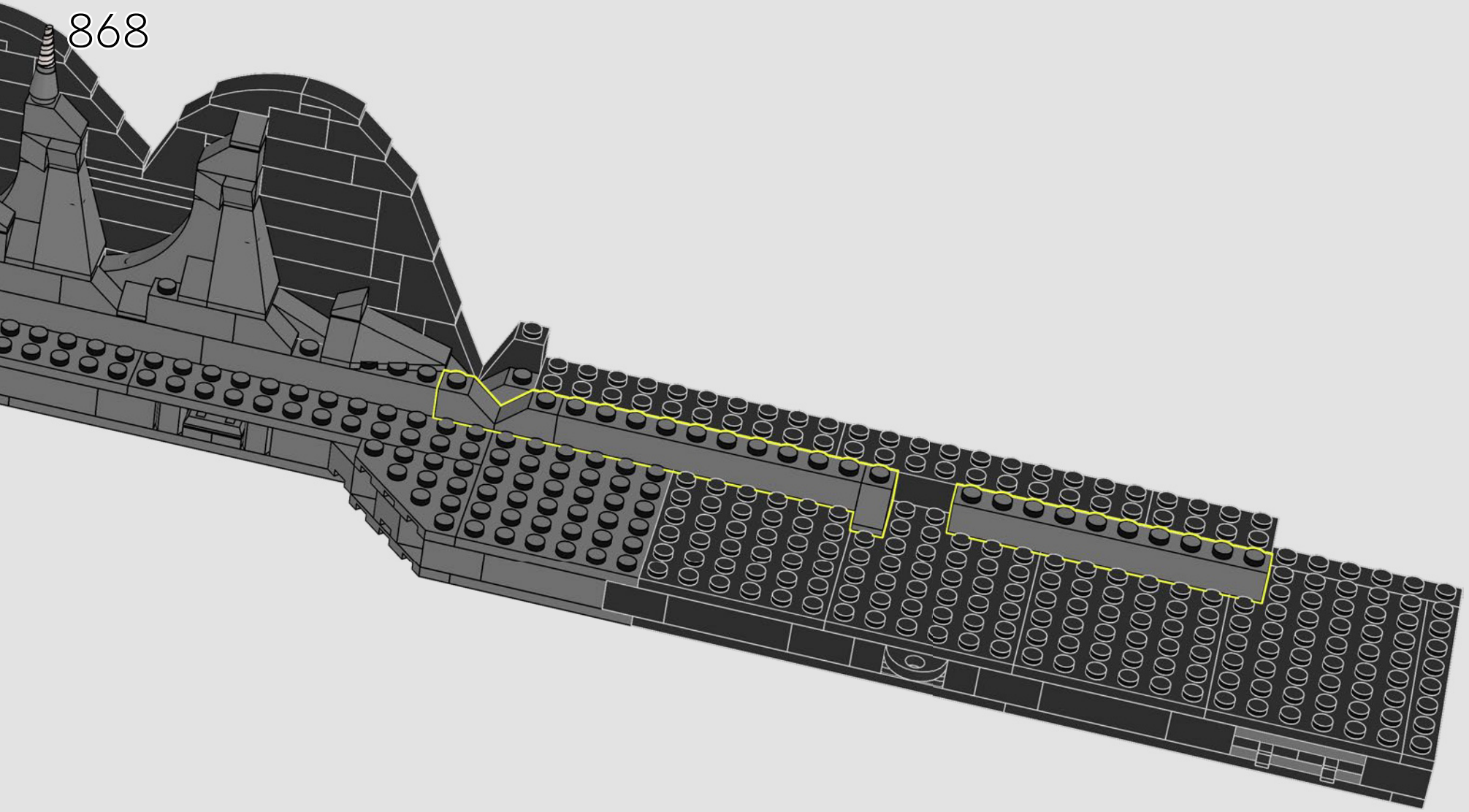



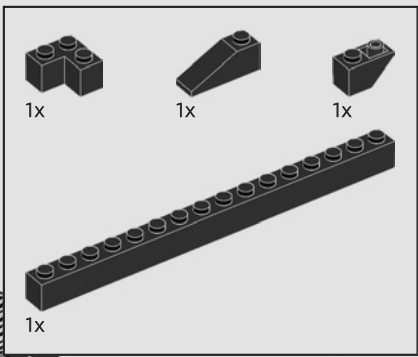

869

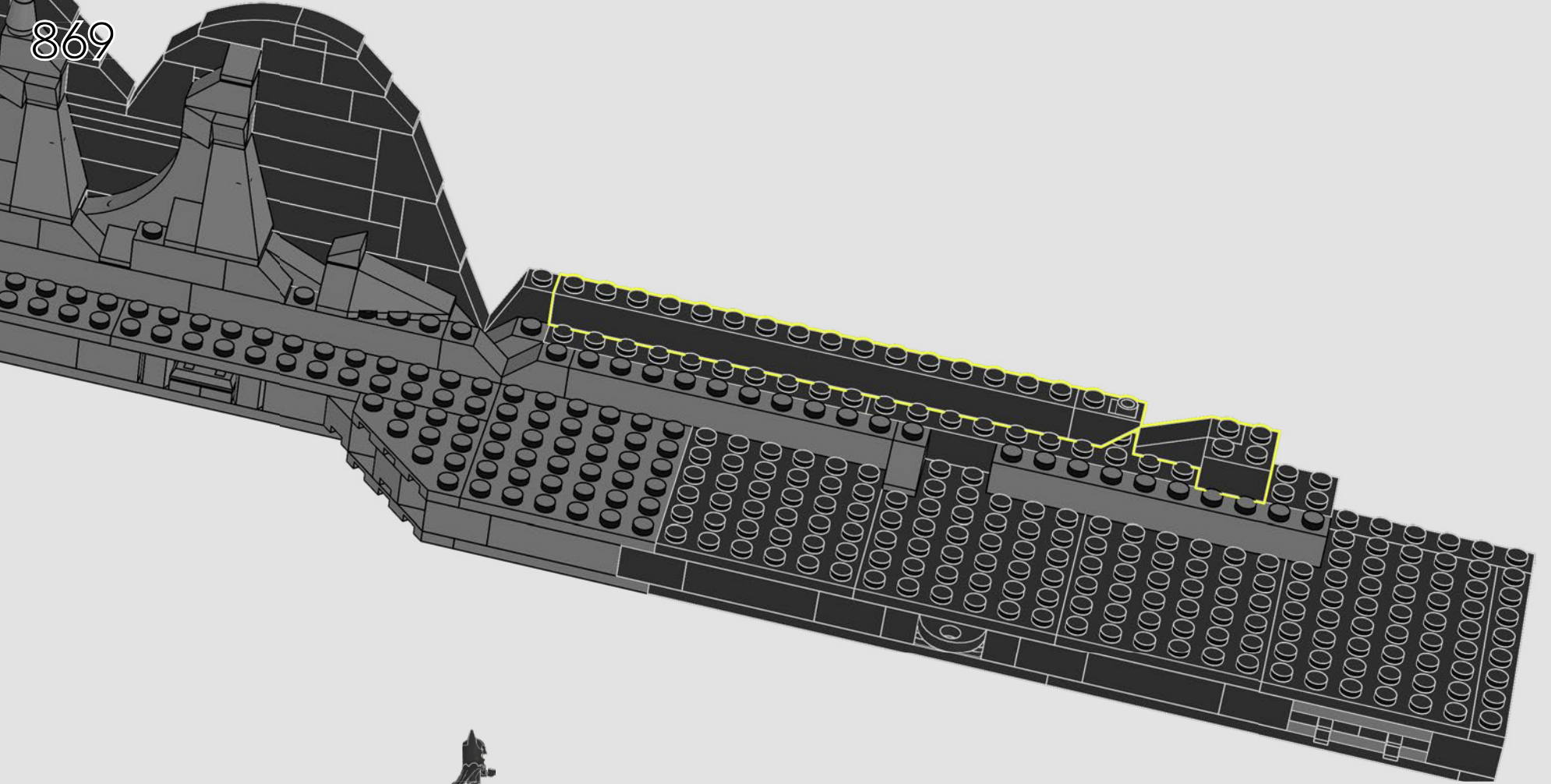

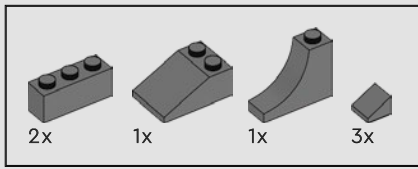

870

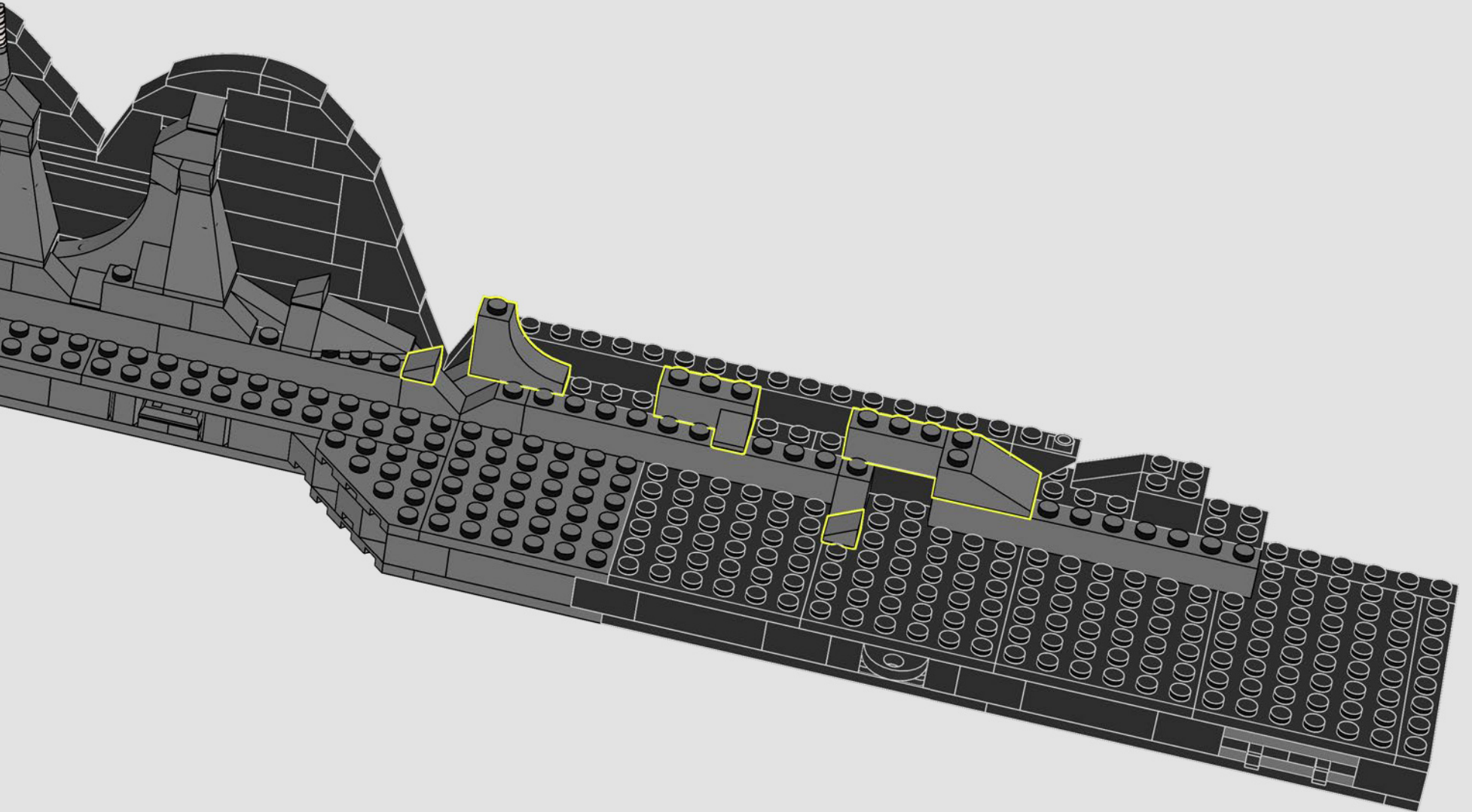

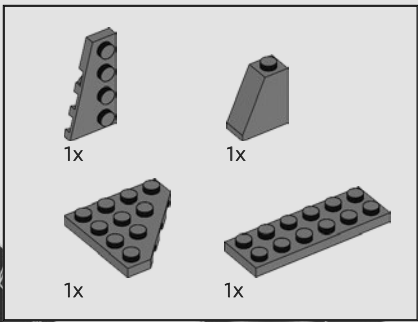

871

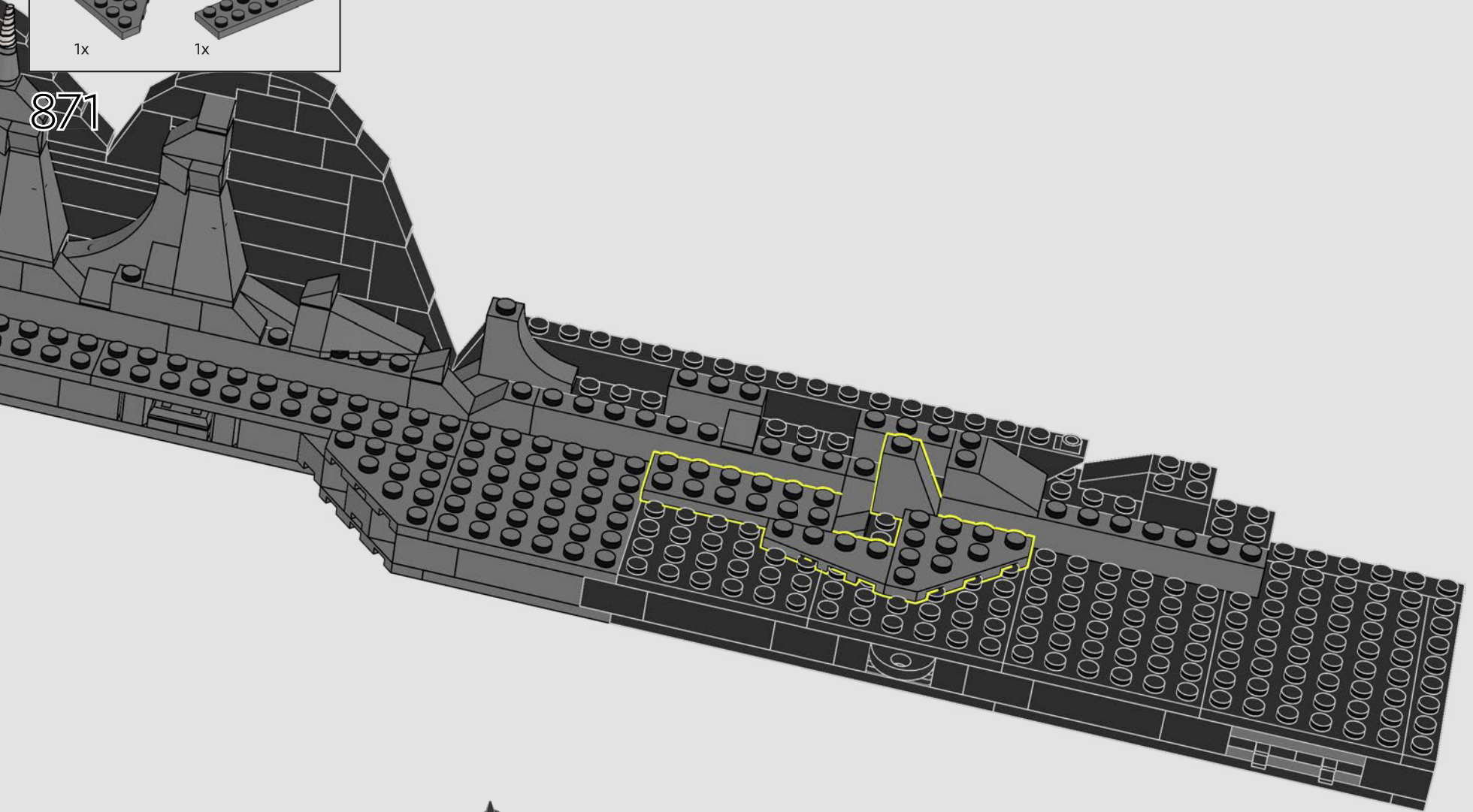



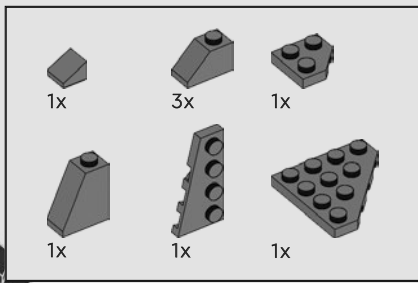

872

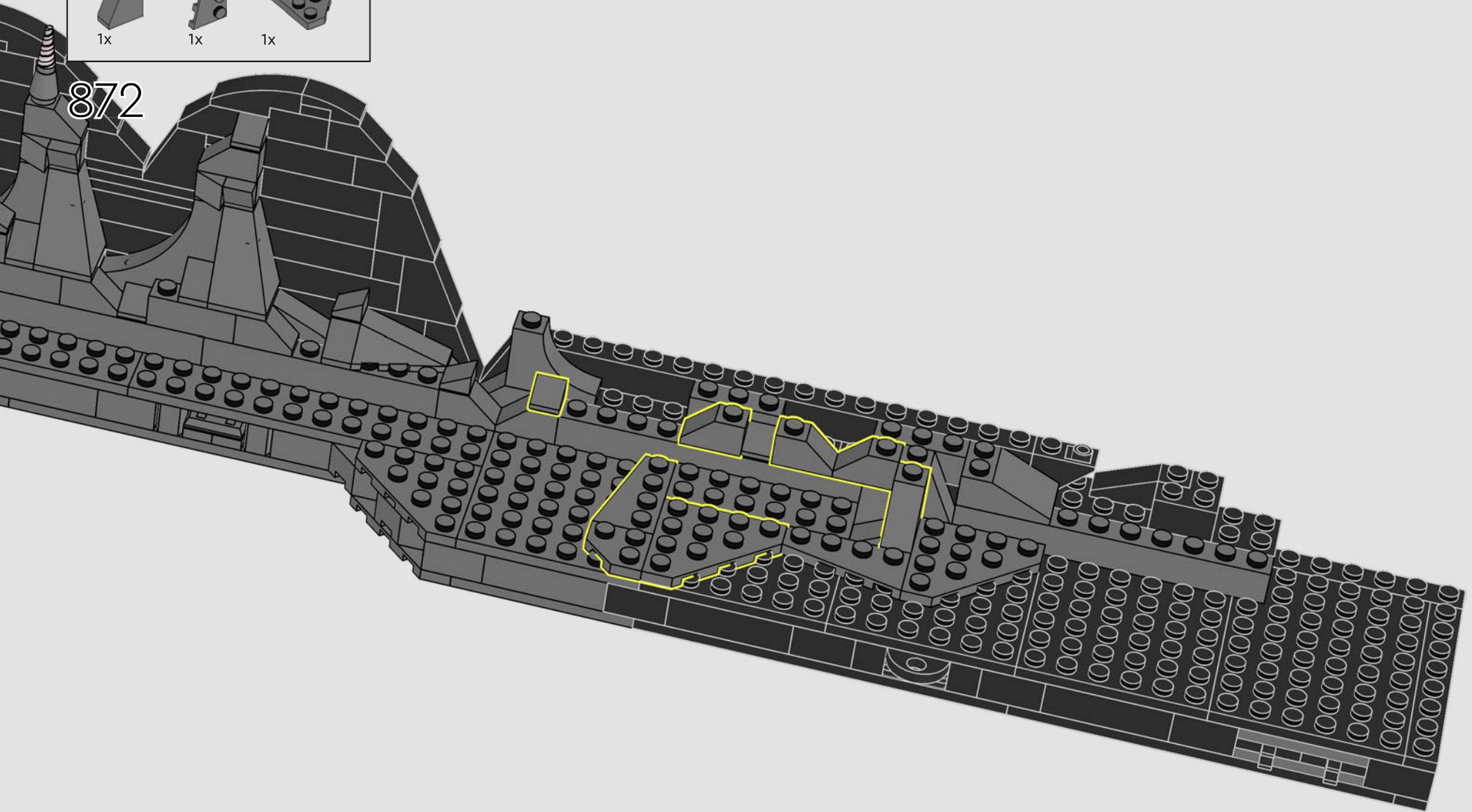

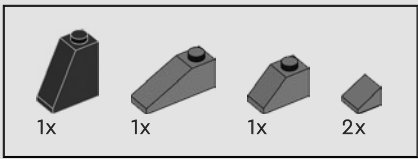

873

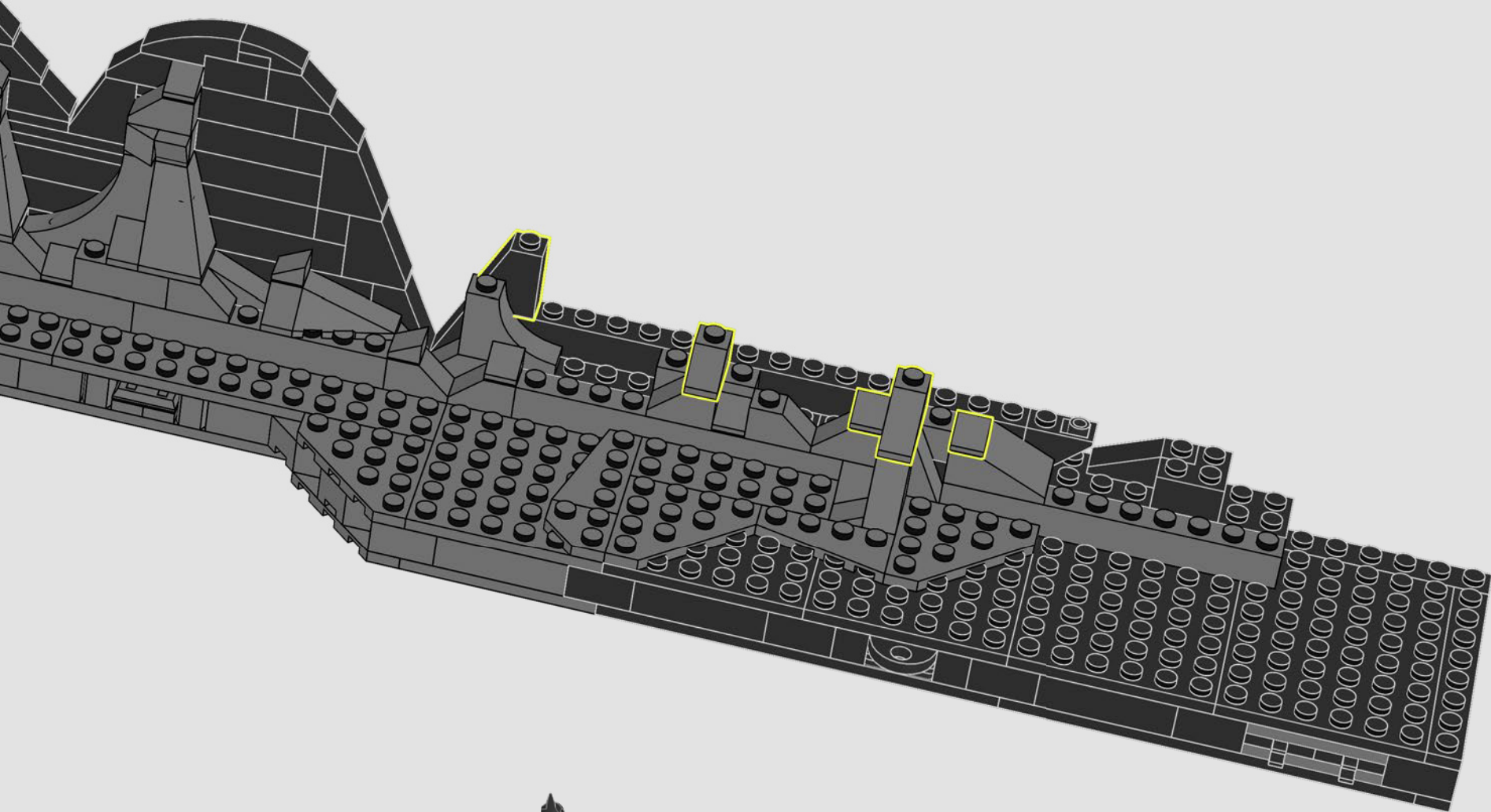

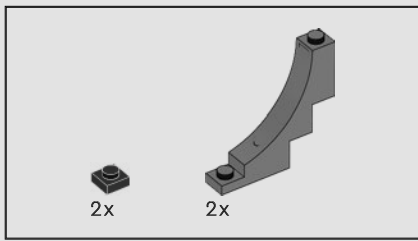

874

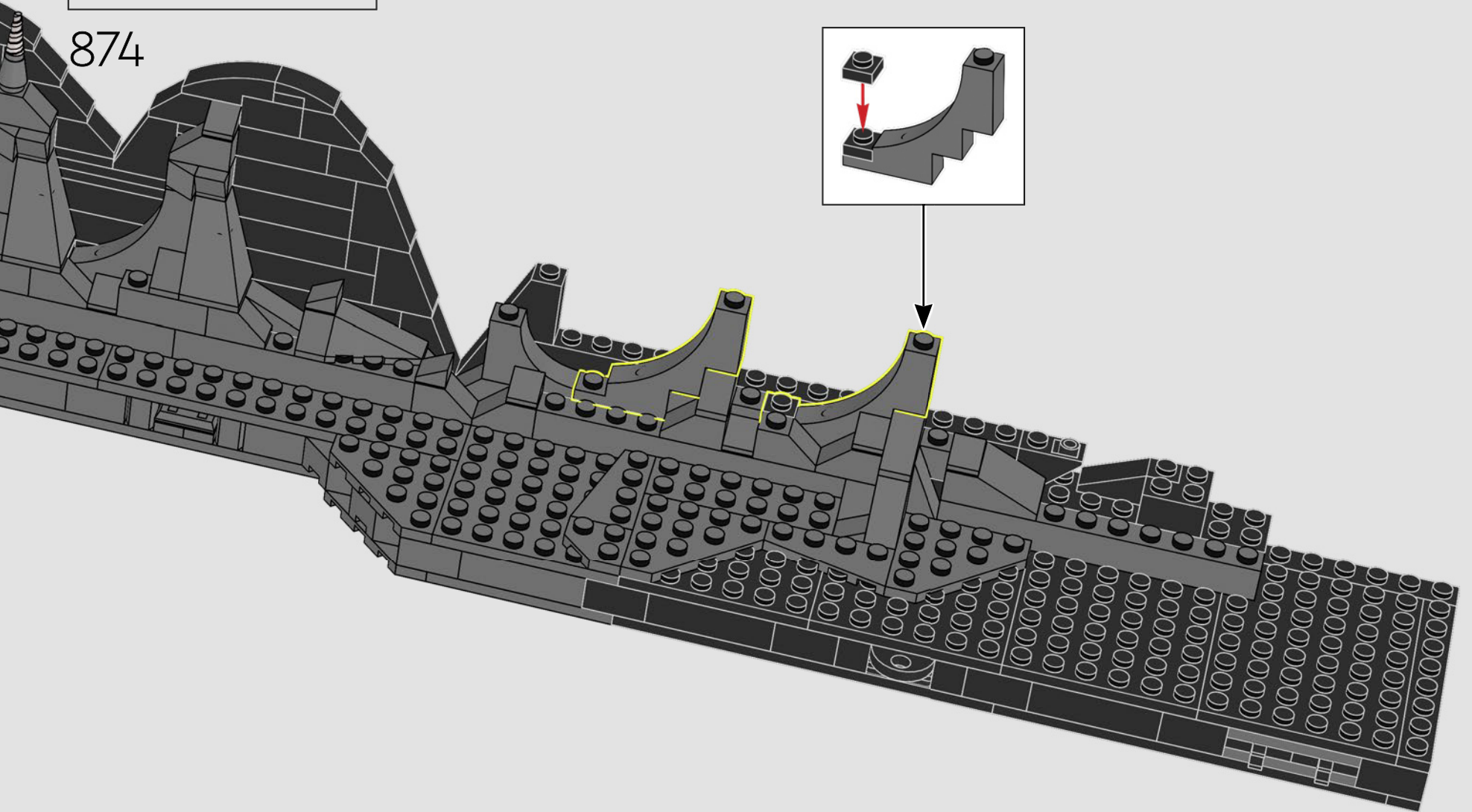
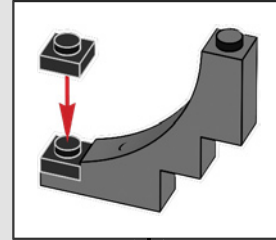



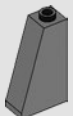

2x

875

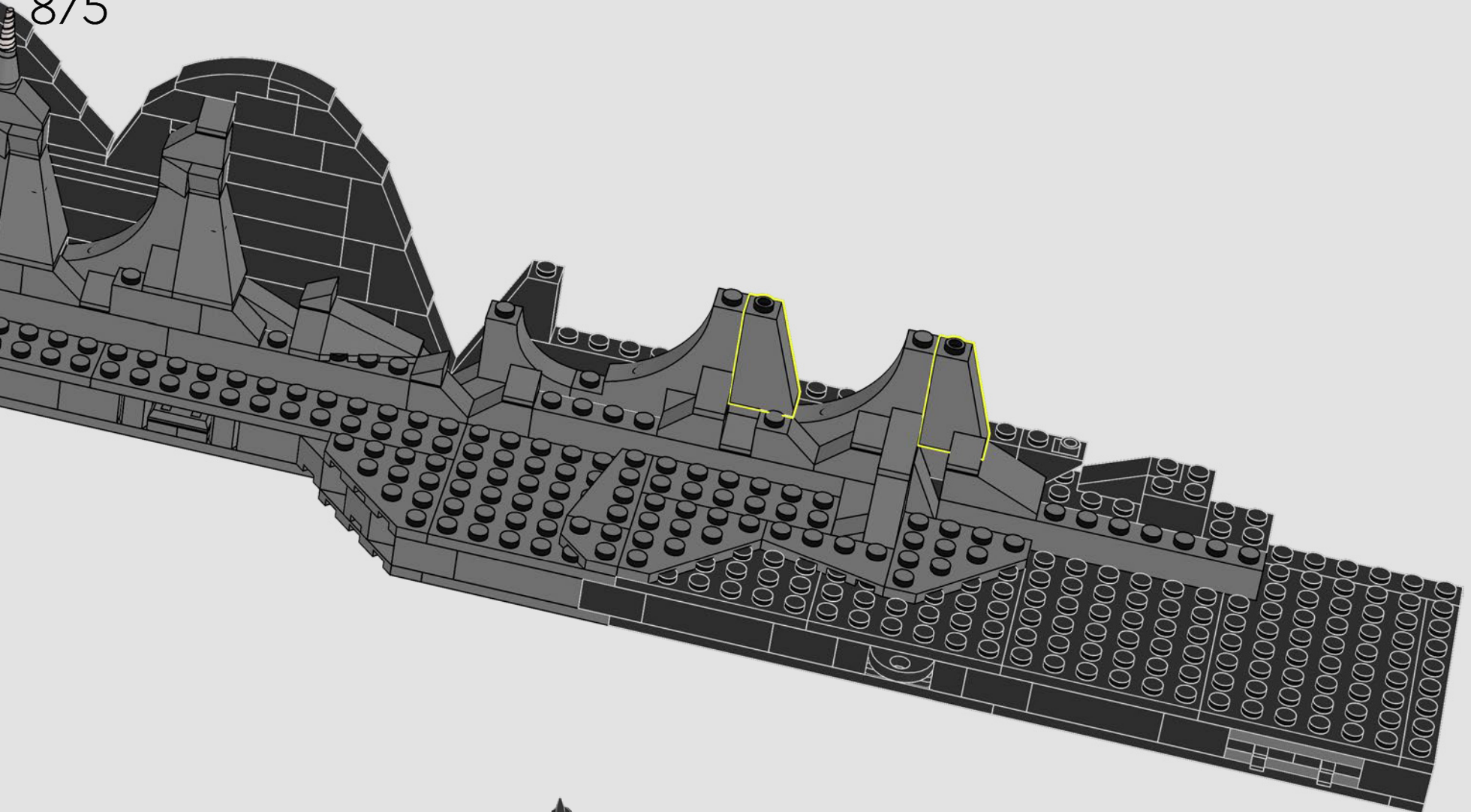

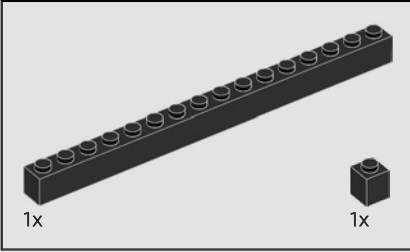
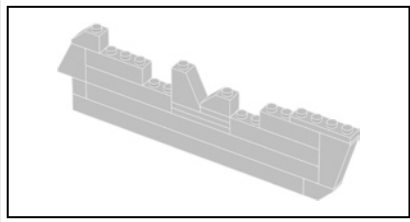

876

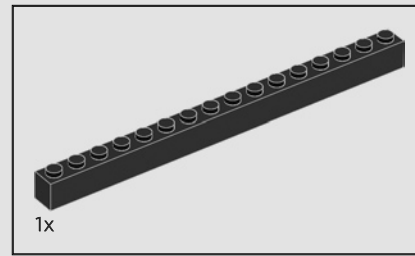
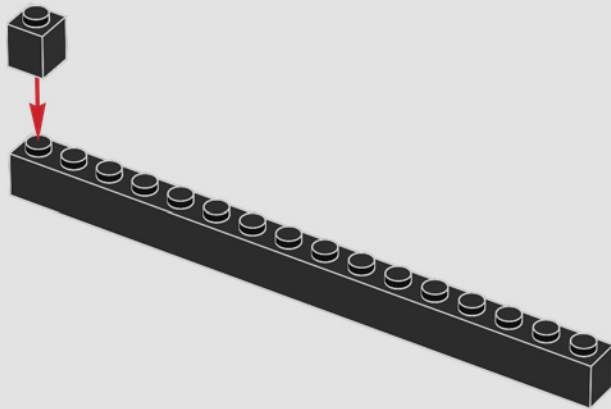

877

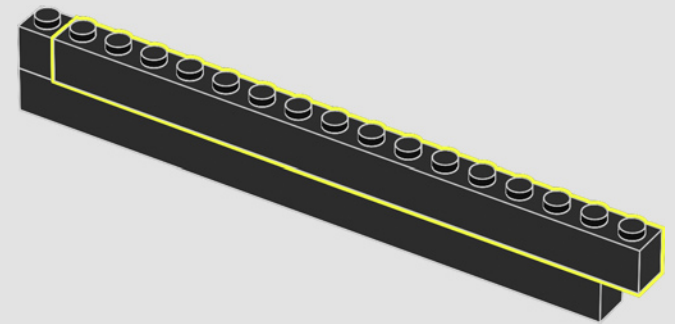

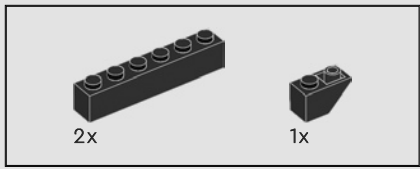

878

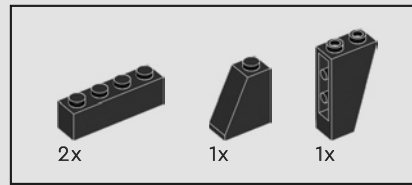
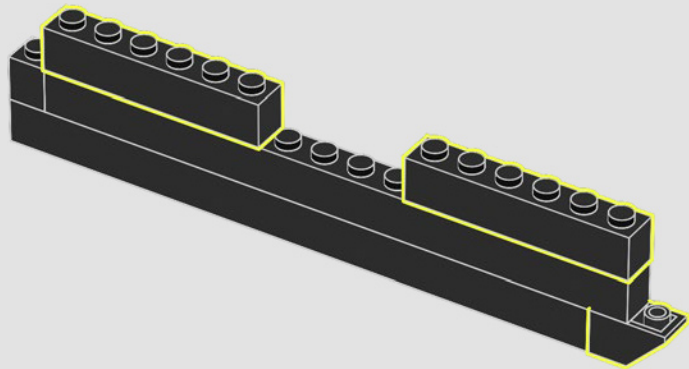

879

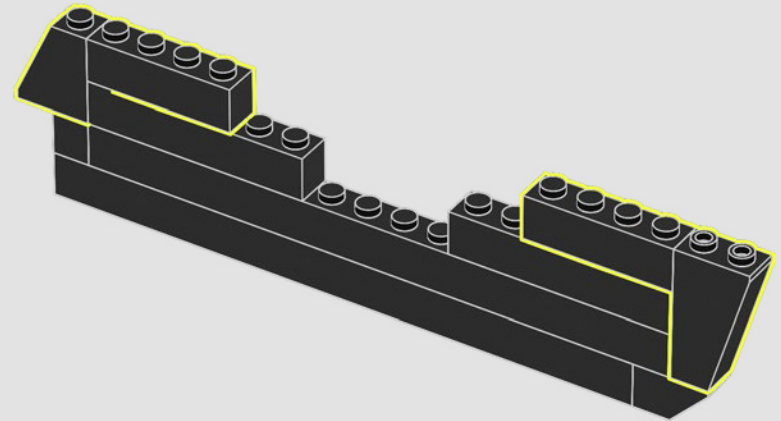



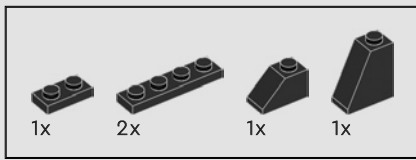

880

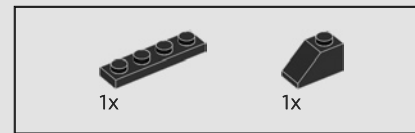
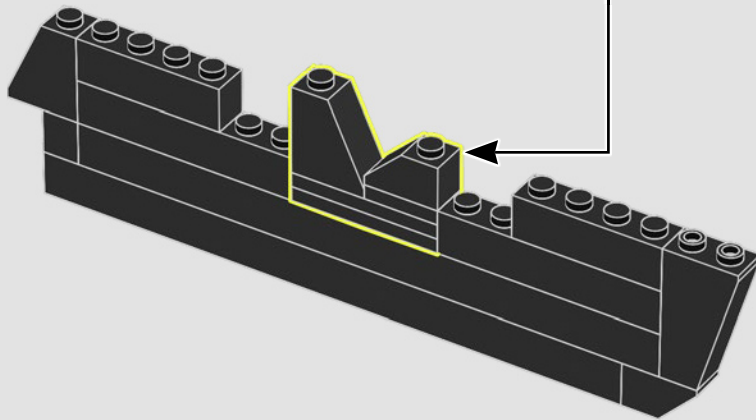
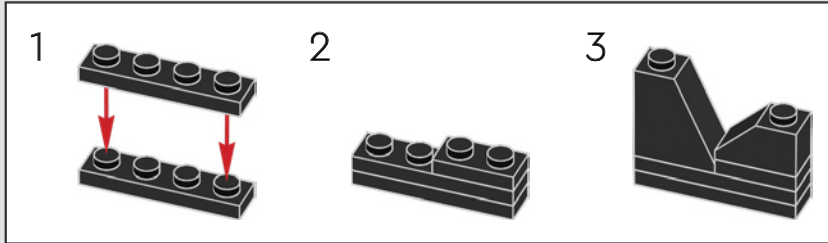

881

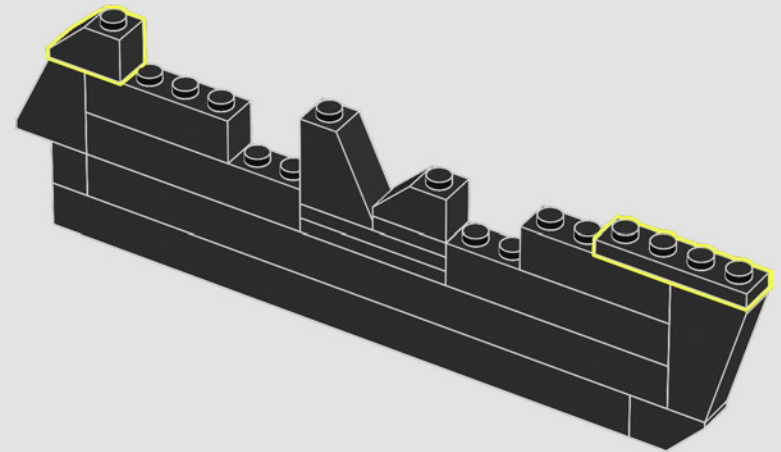

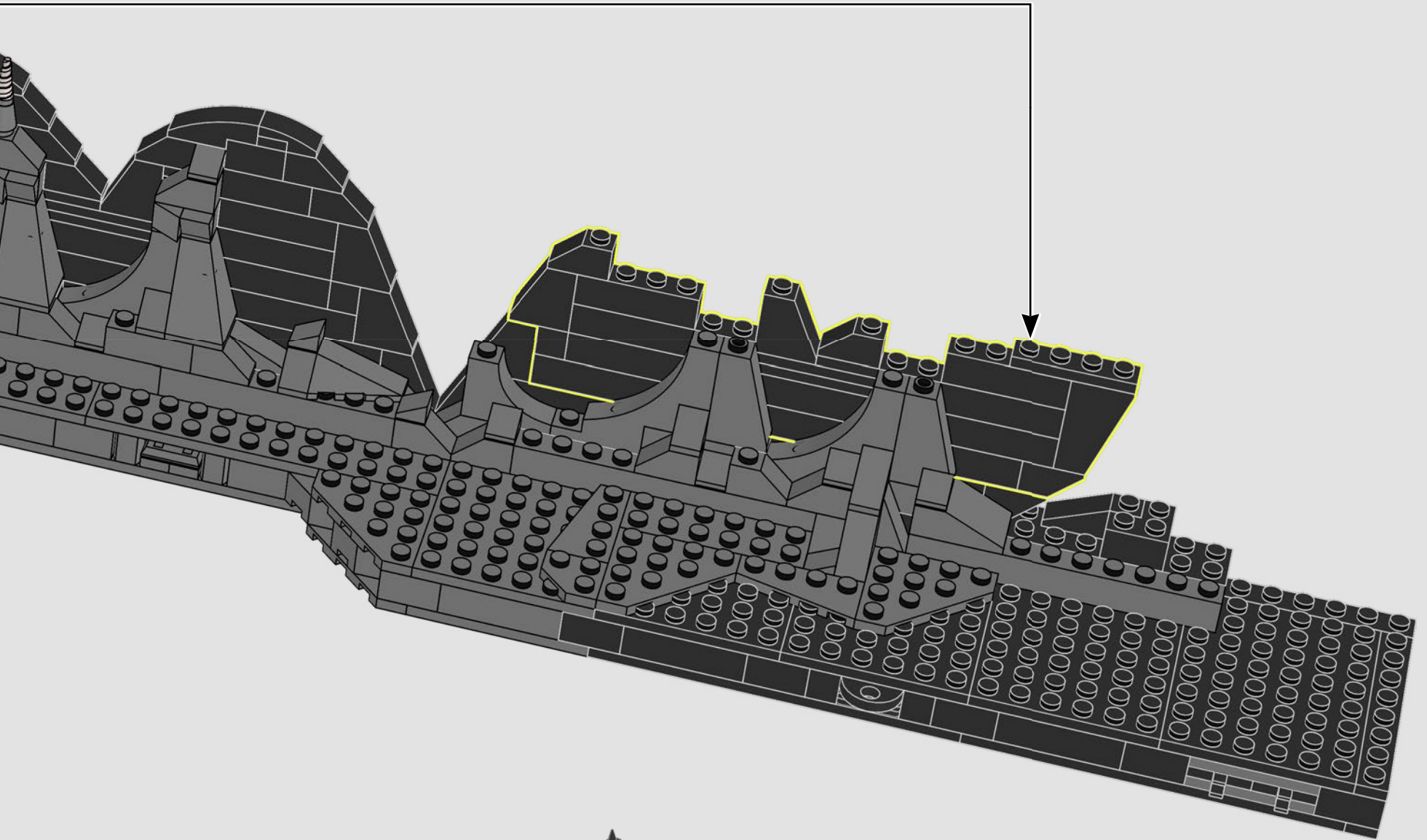



883

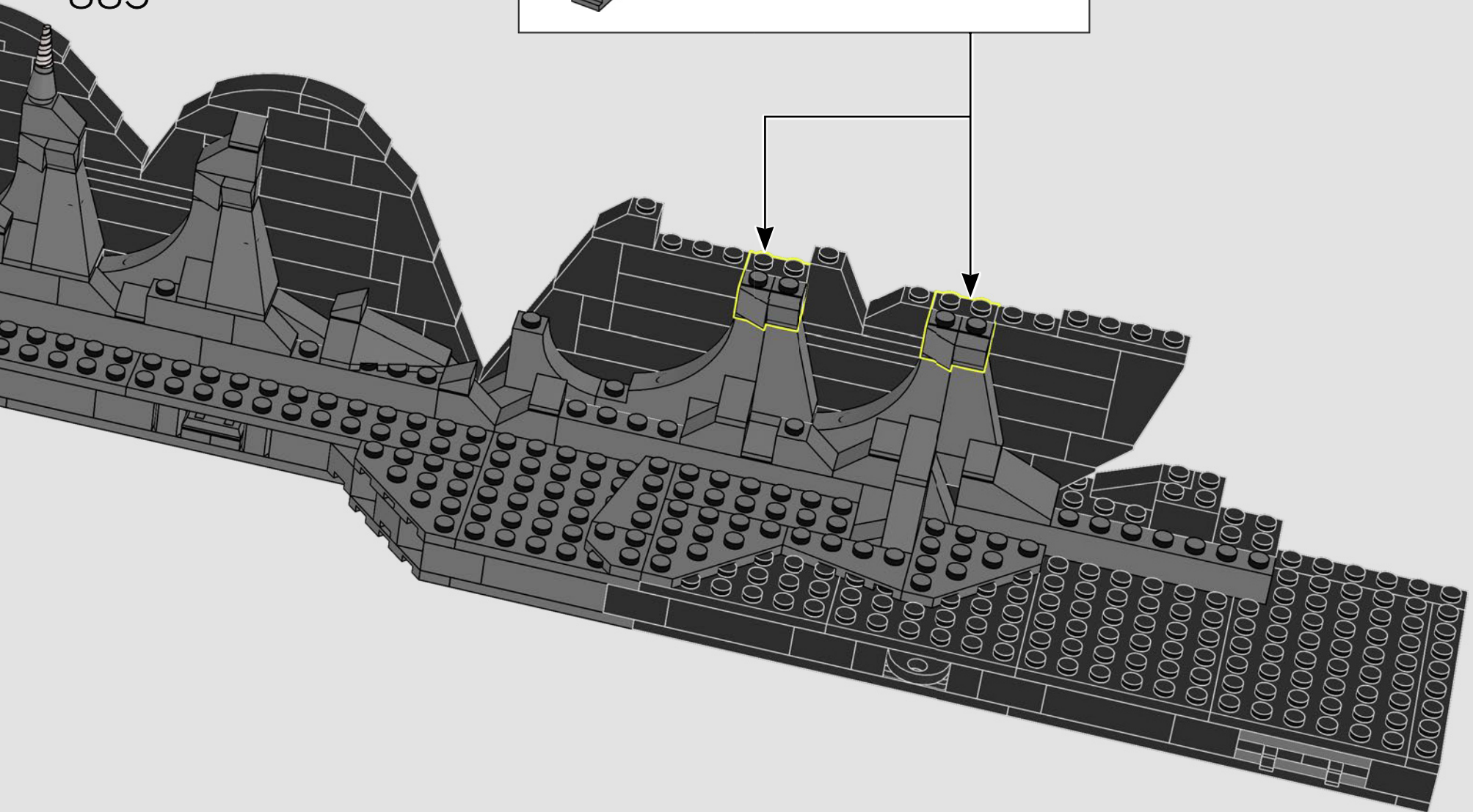
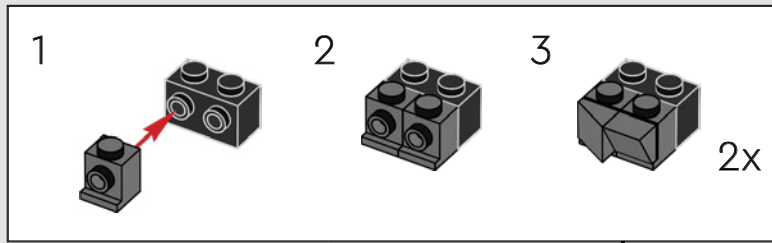



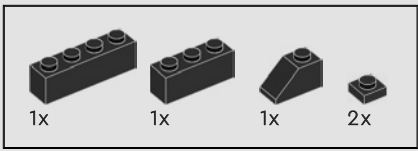

884

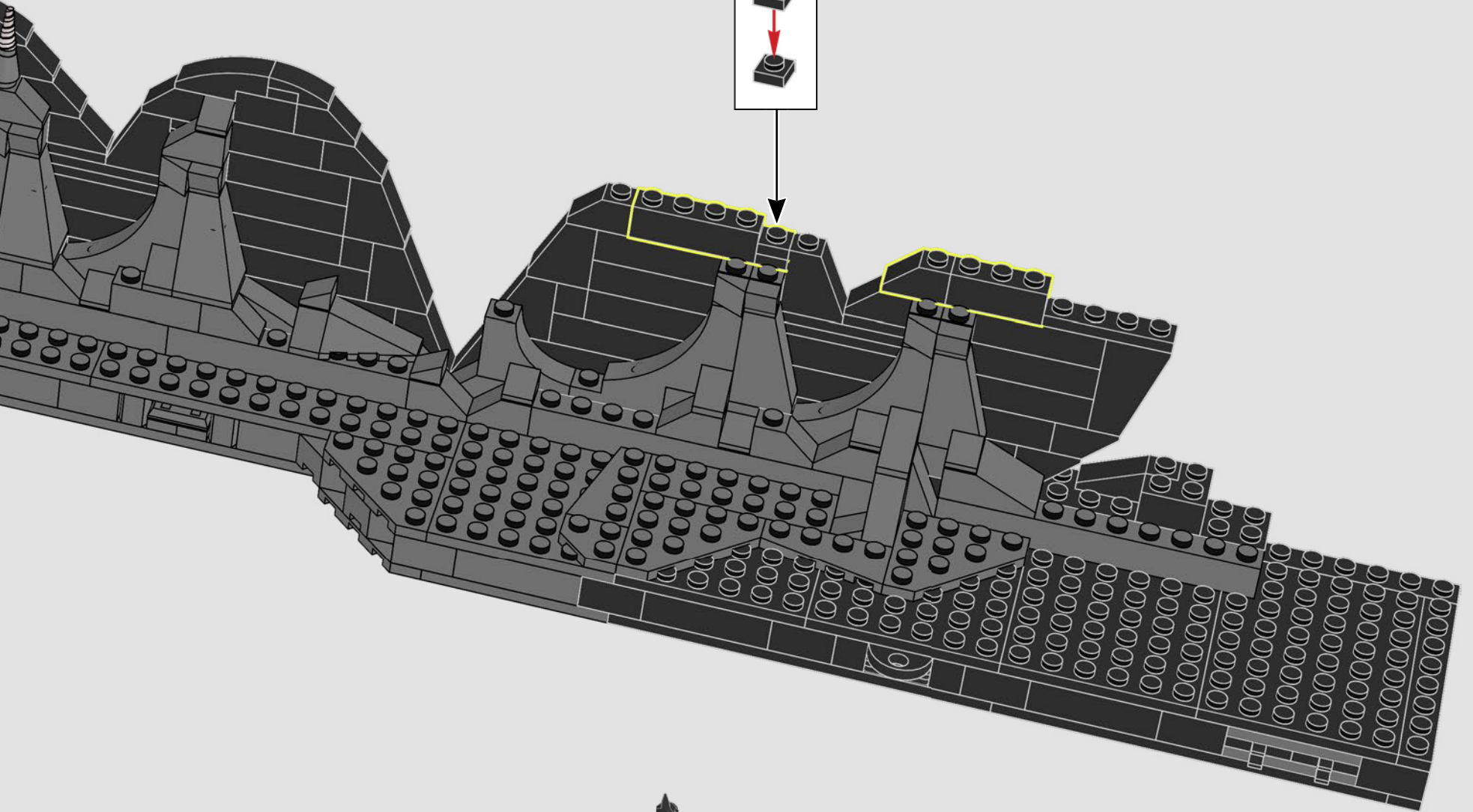
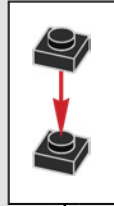



885

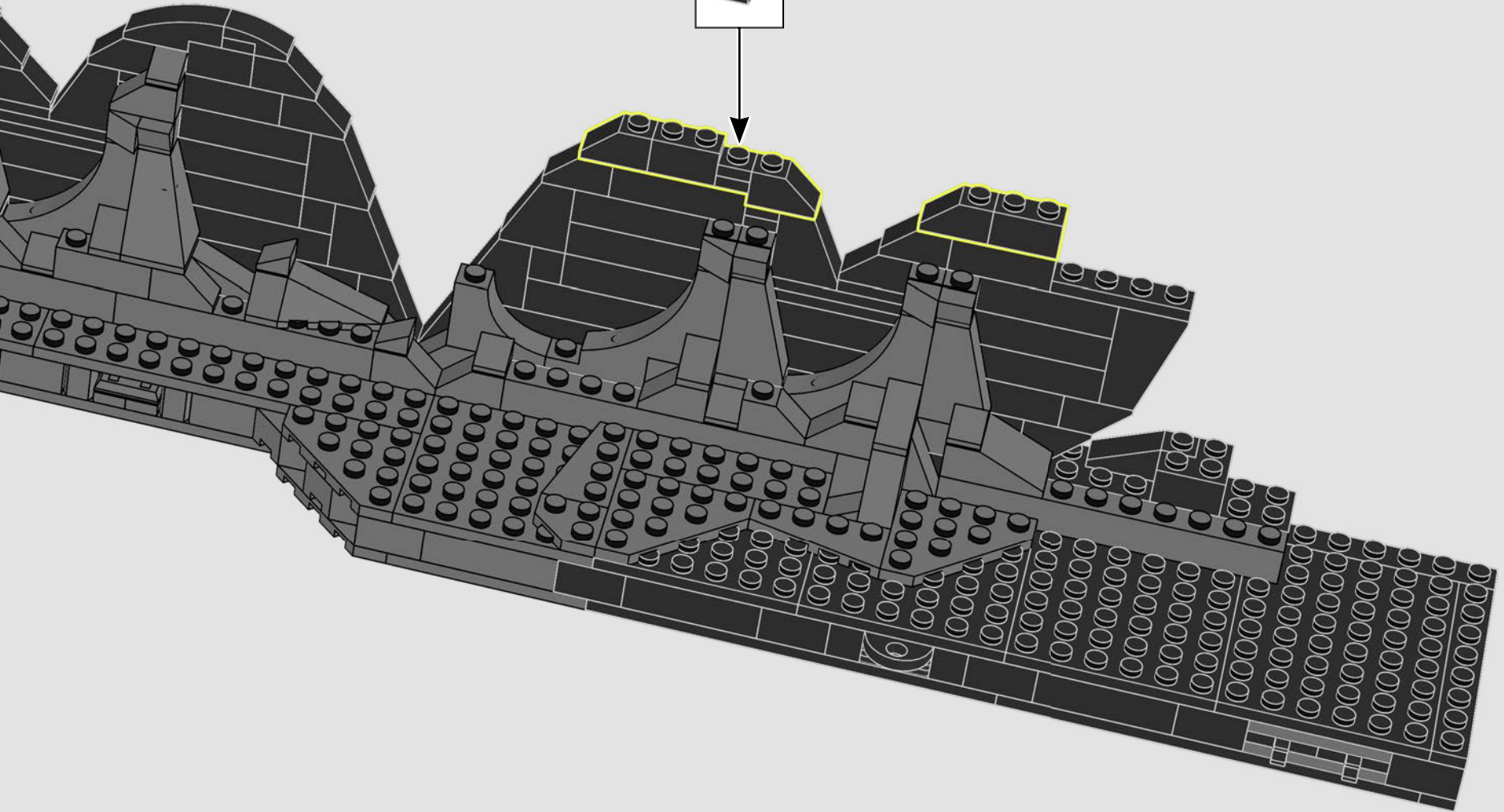
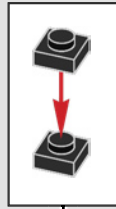

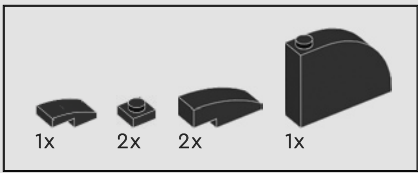

886

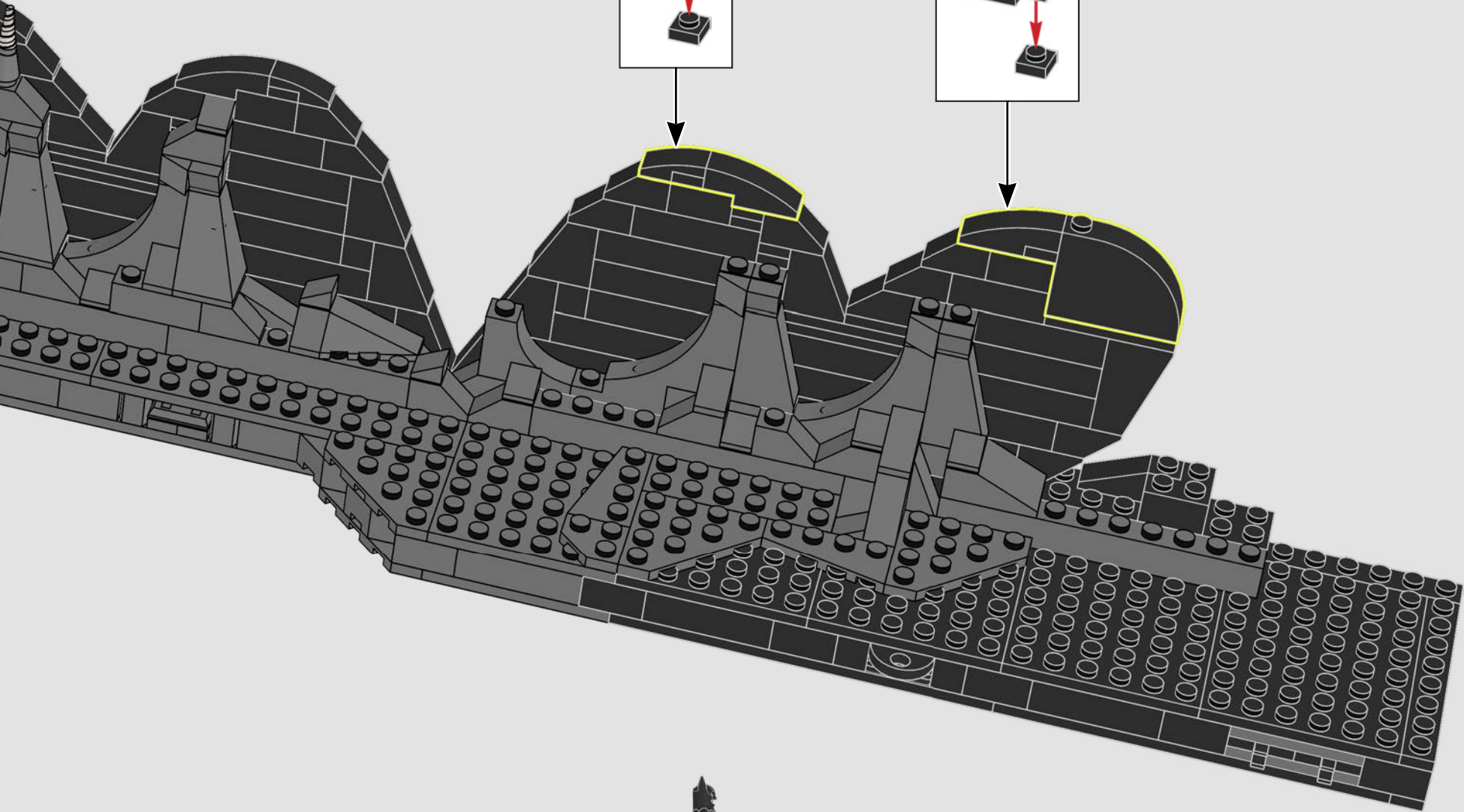
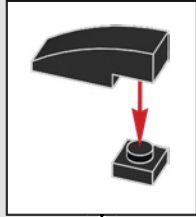
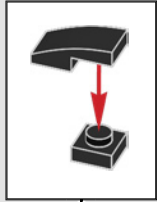



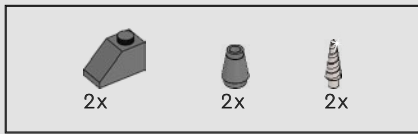

887

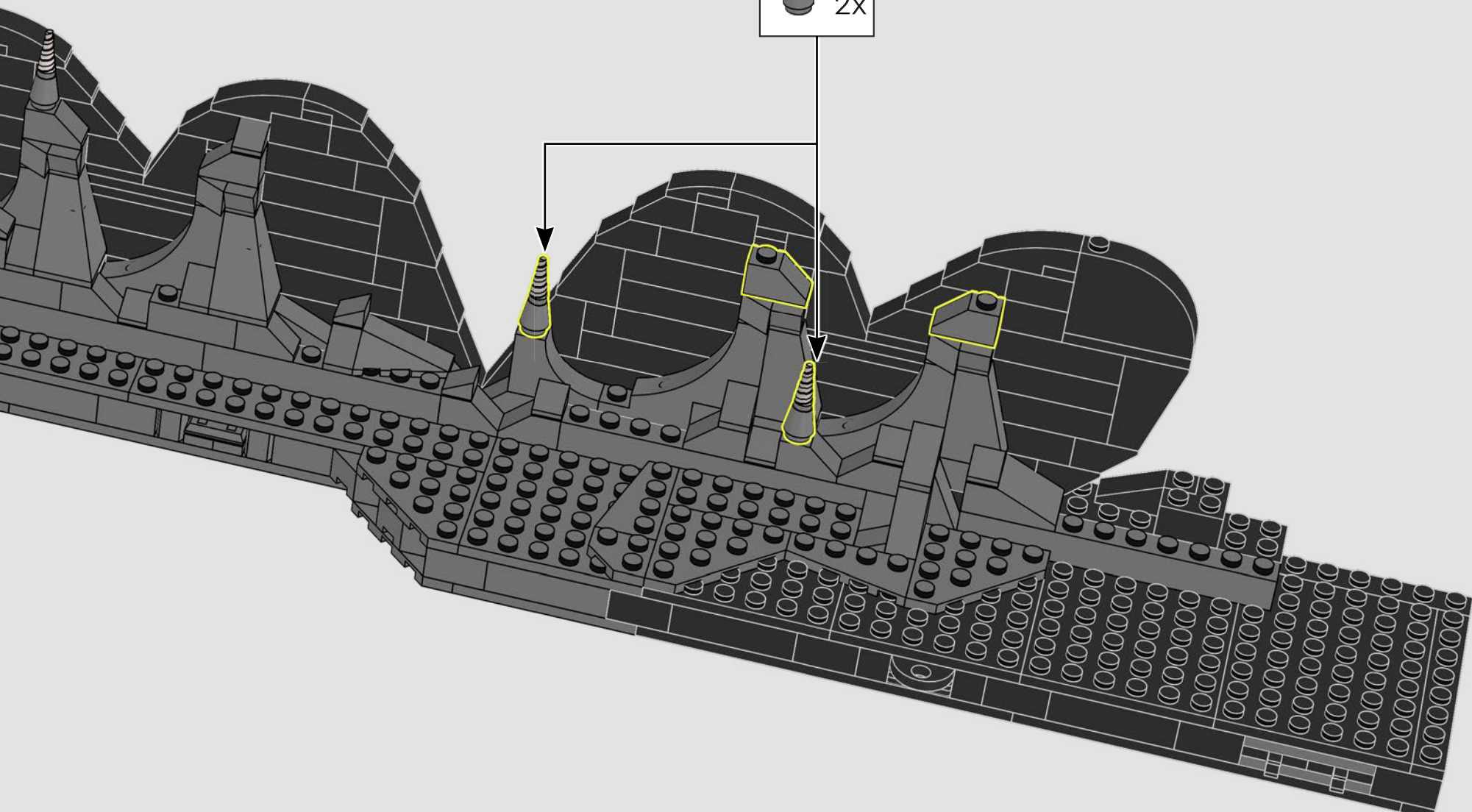
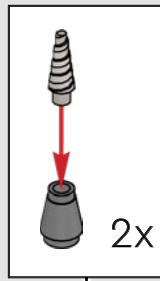

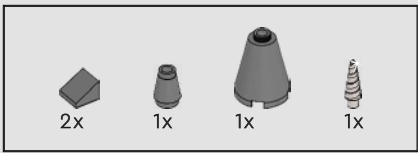

888

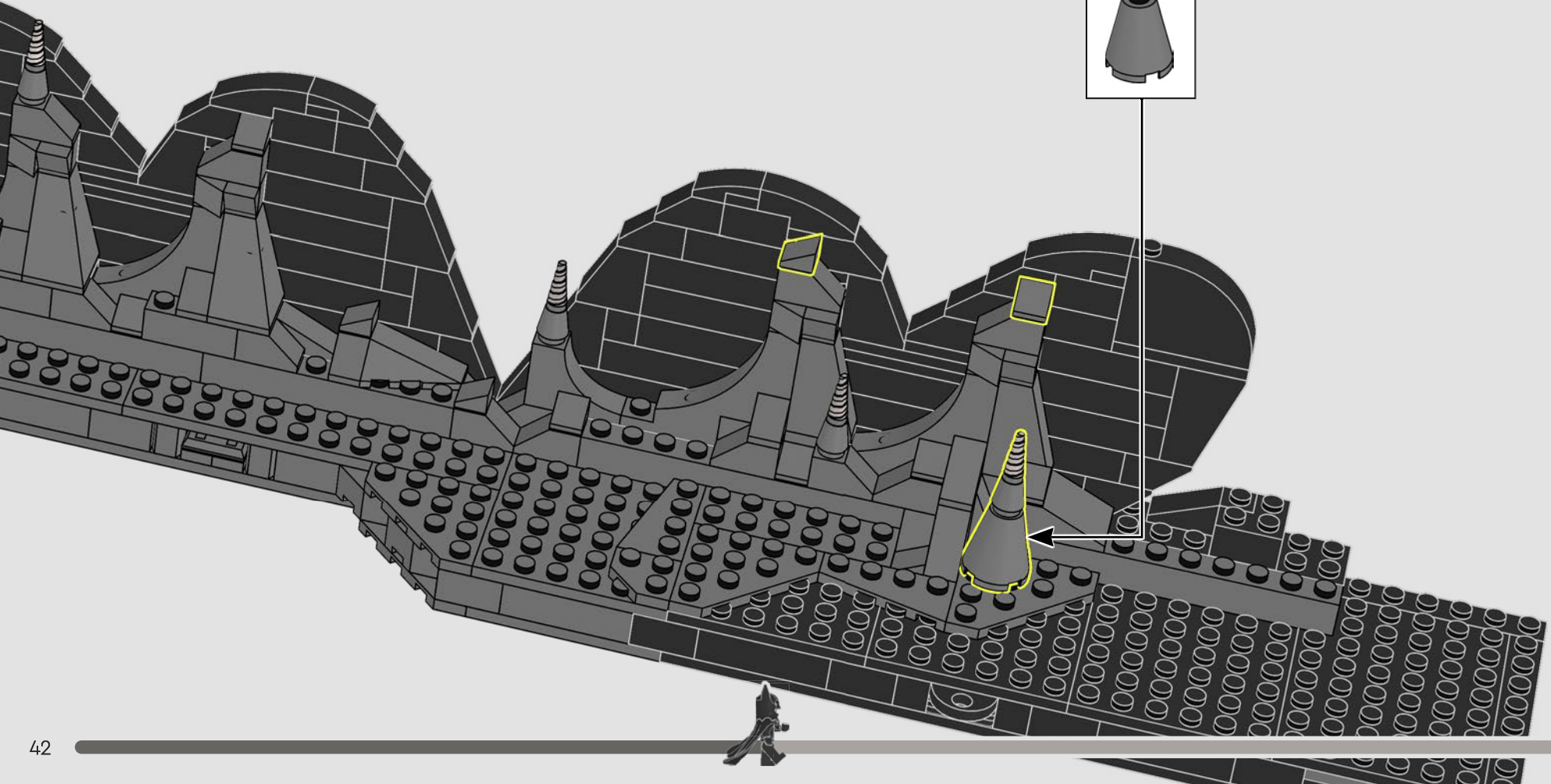
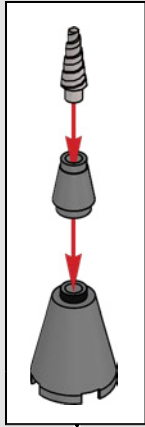



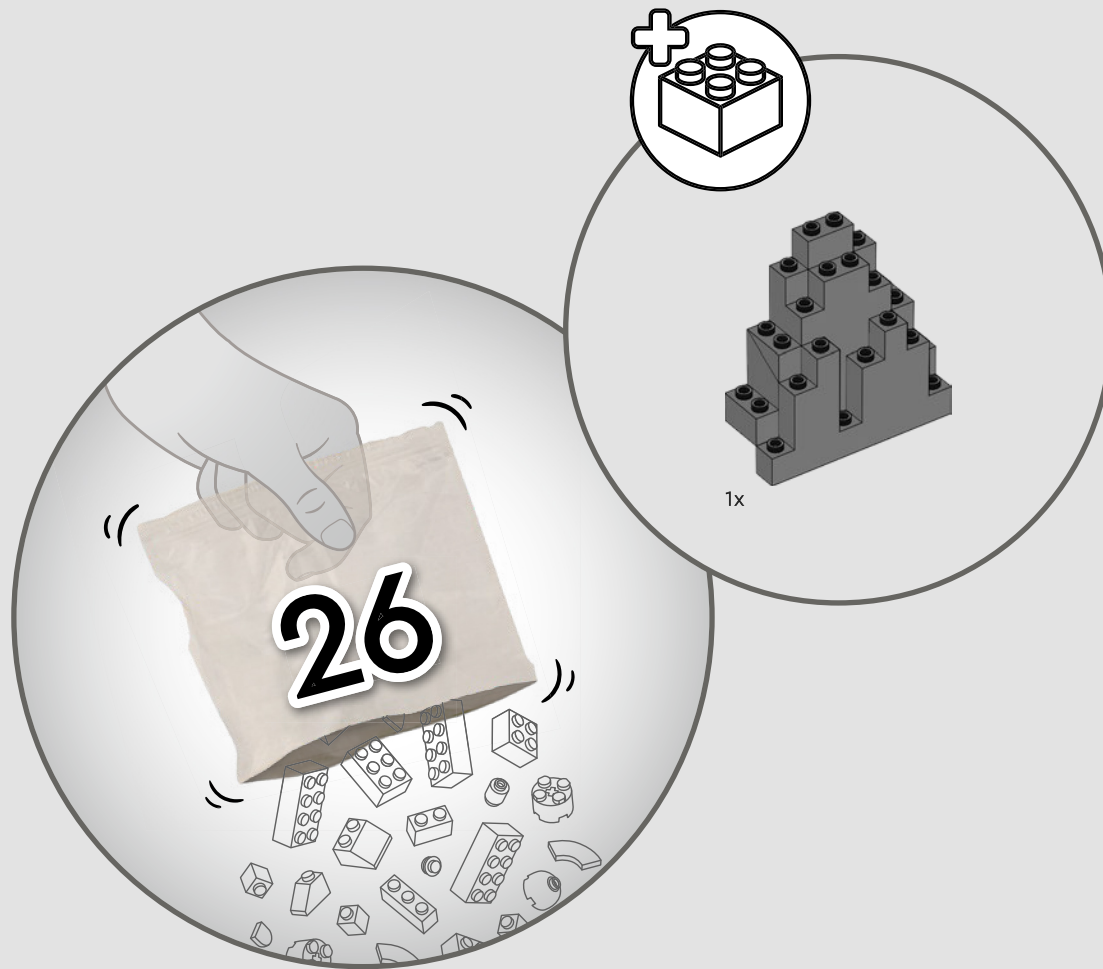

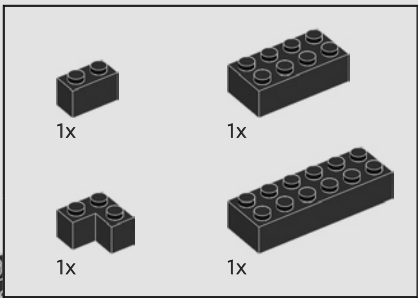

889

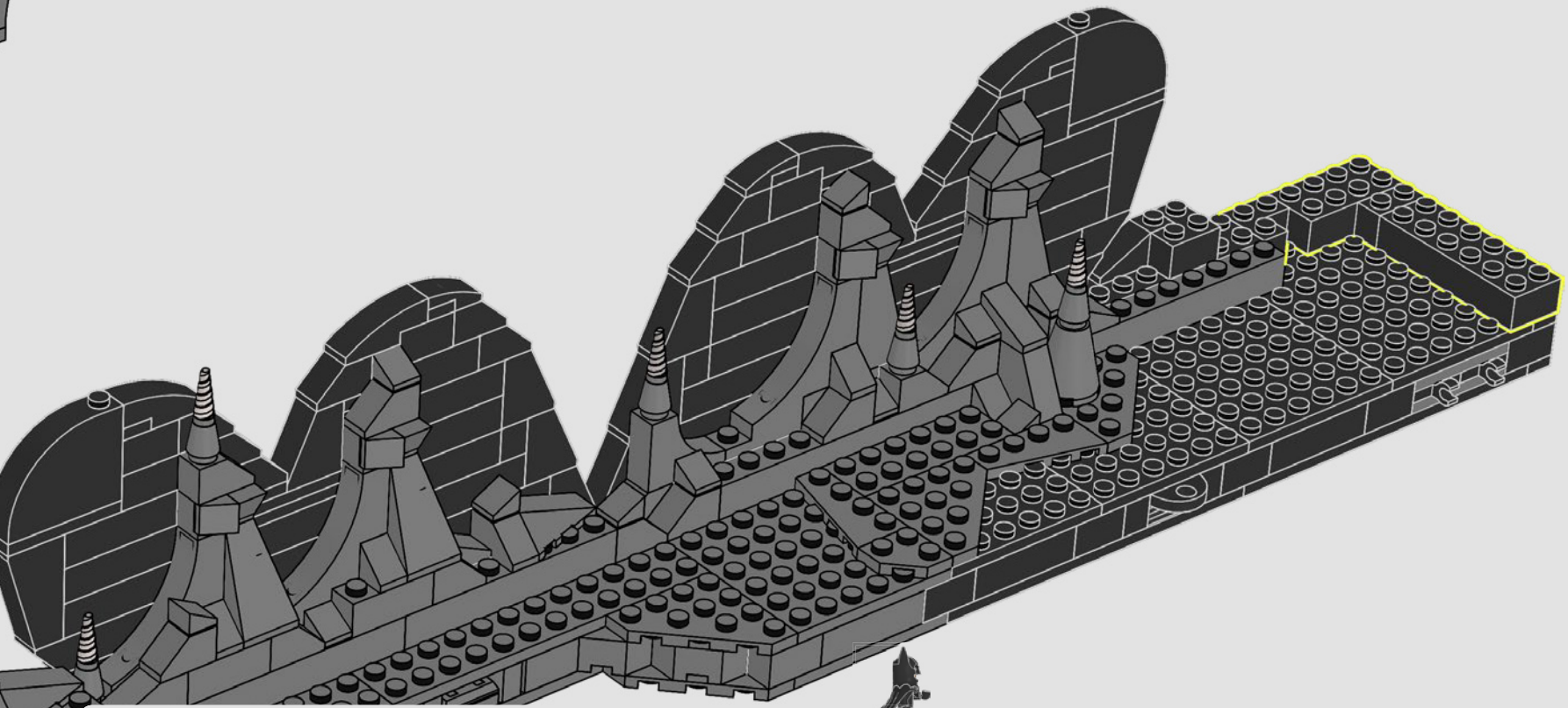

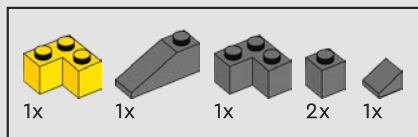

890

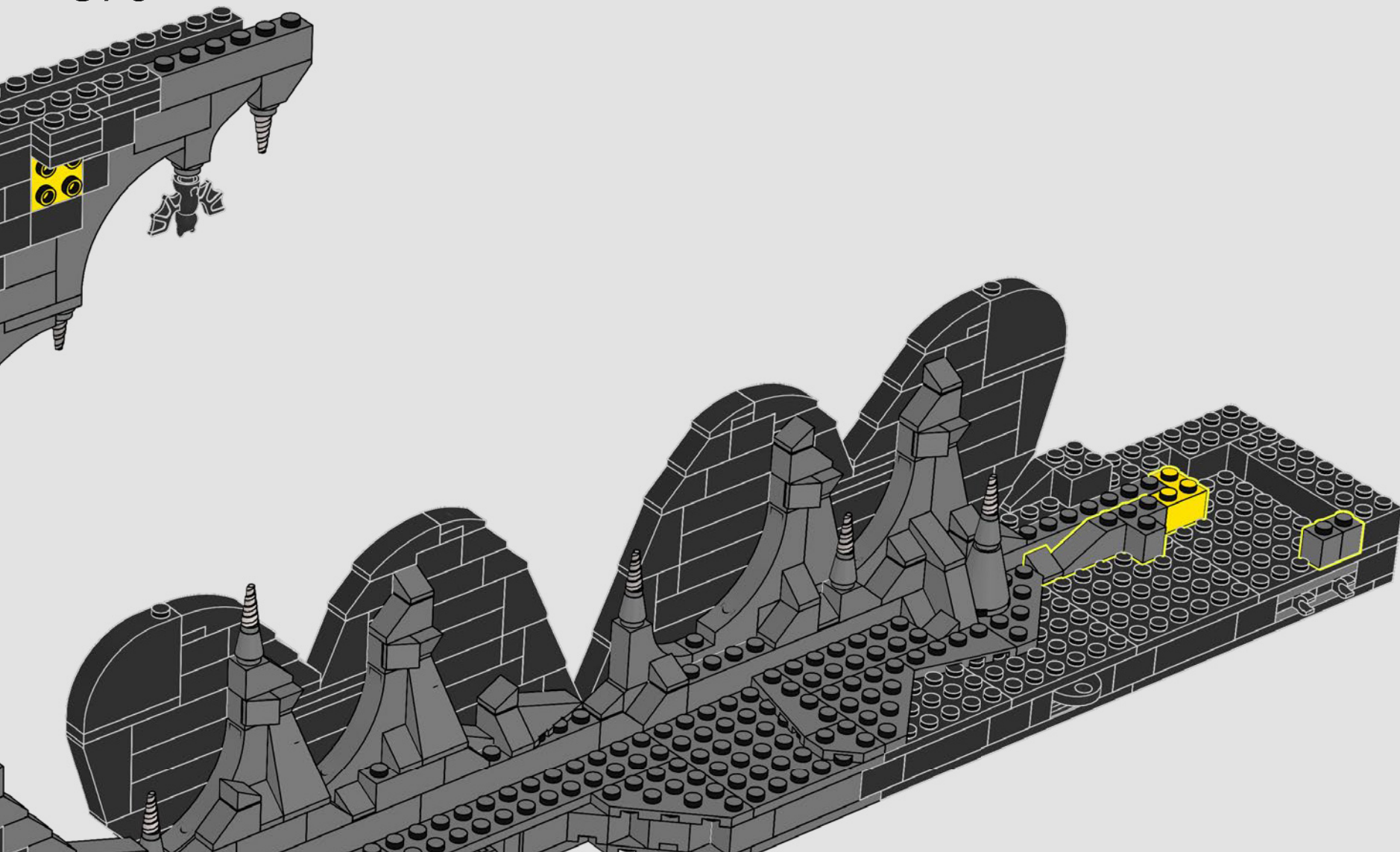



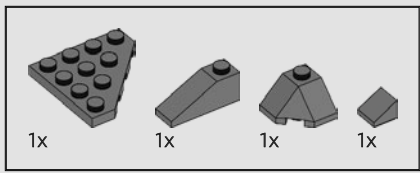

891

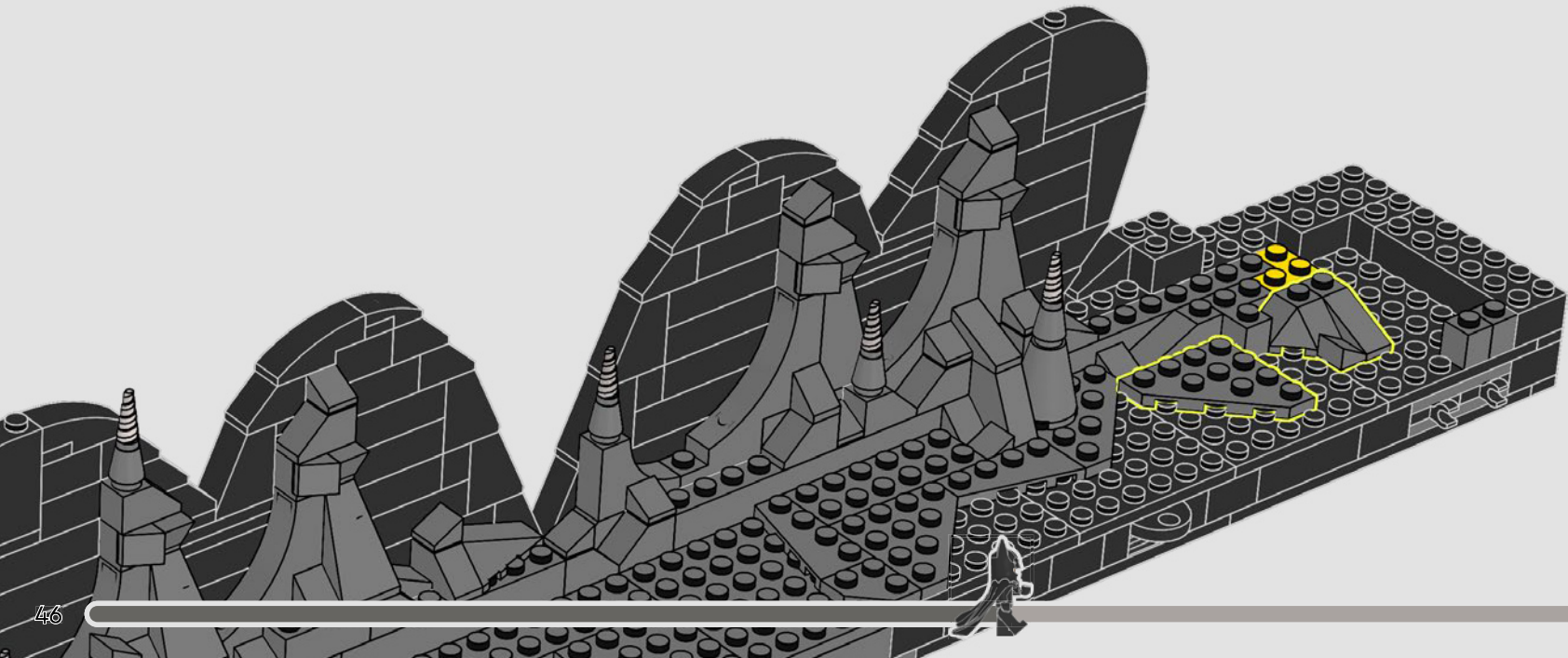
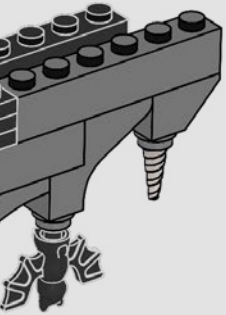

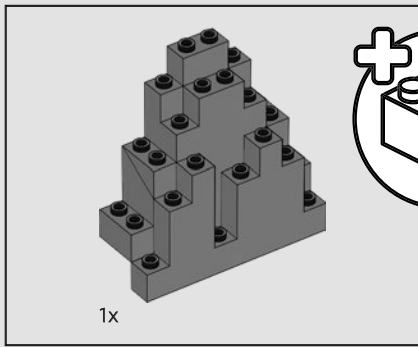

892

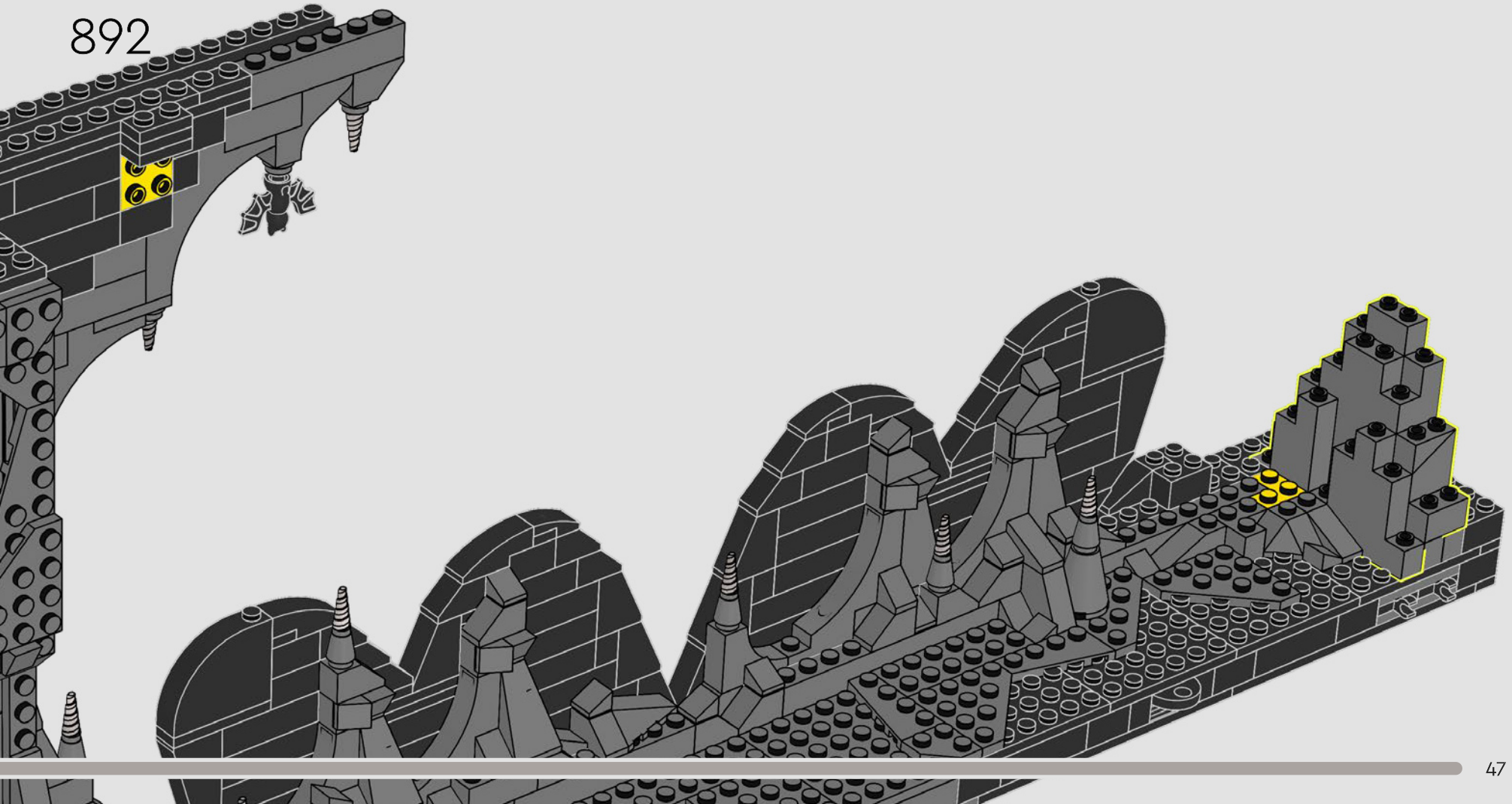

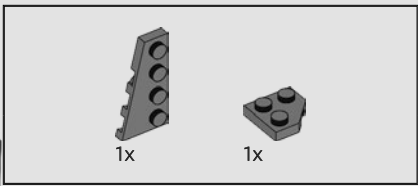

893

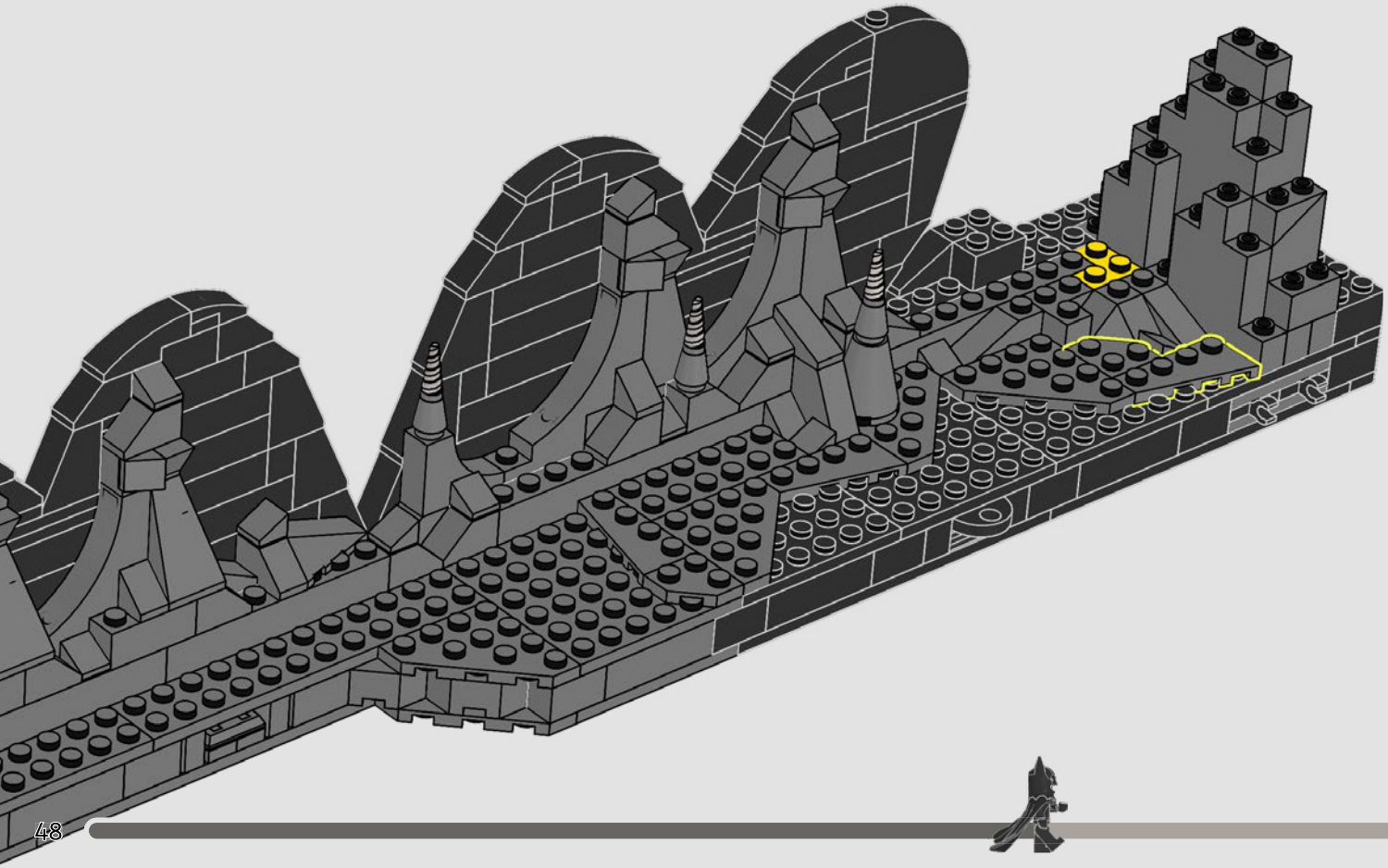



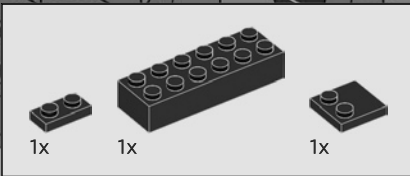

894

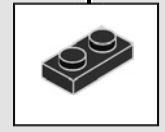

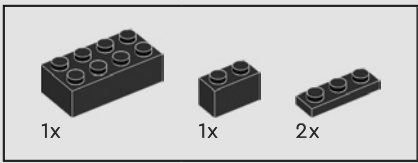

895

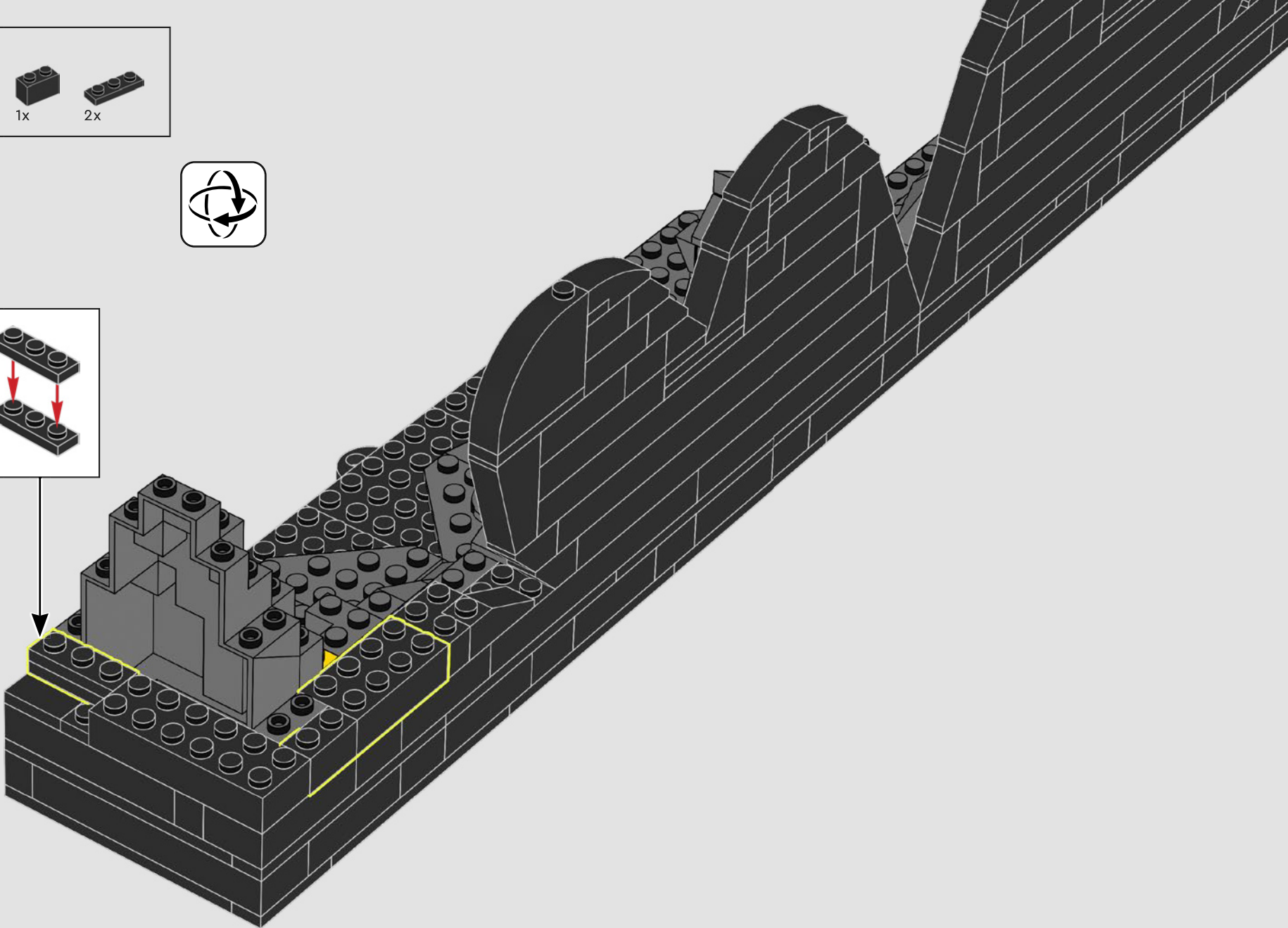
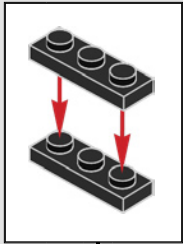

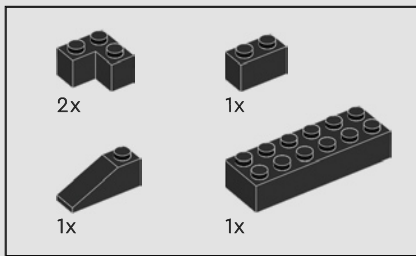

896

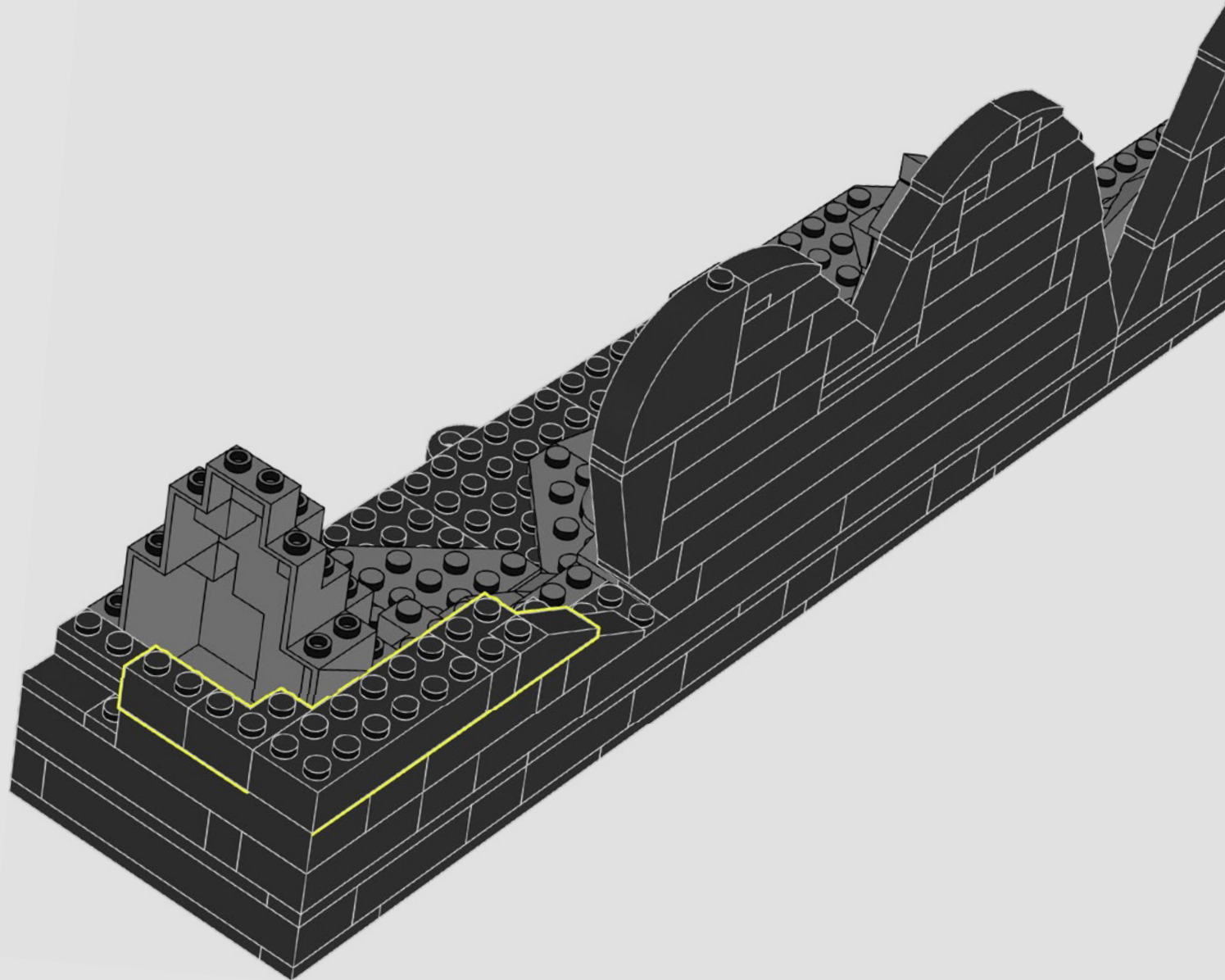



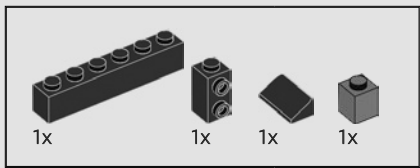

897

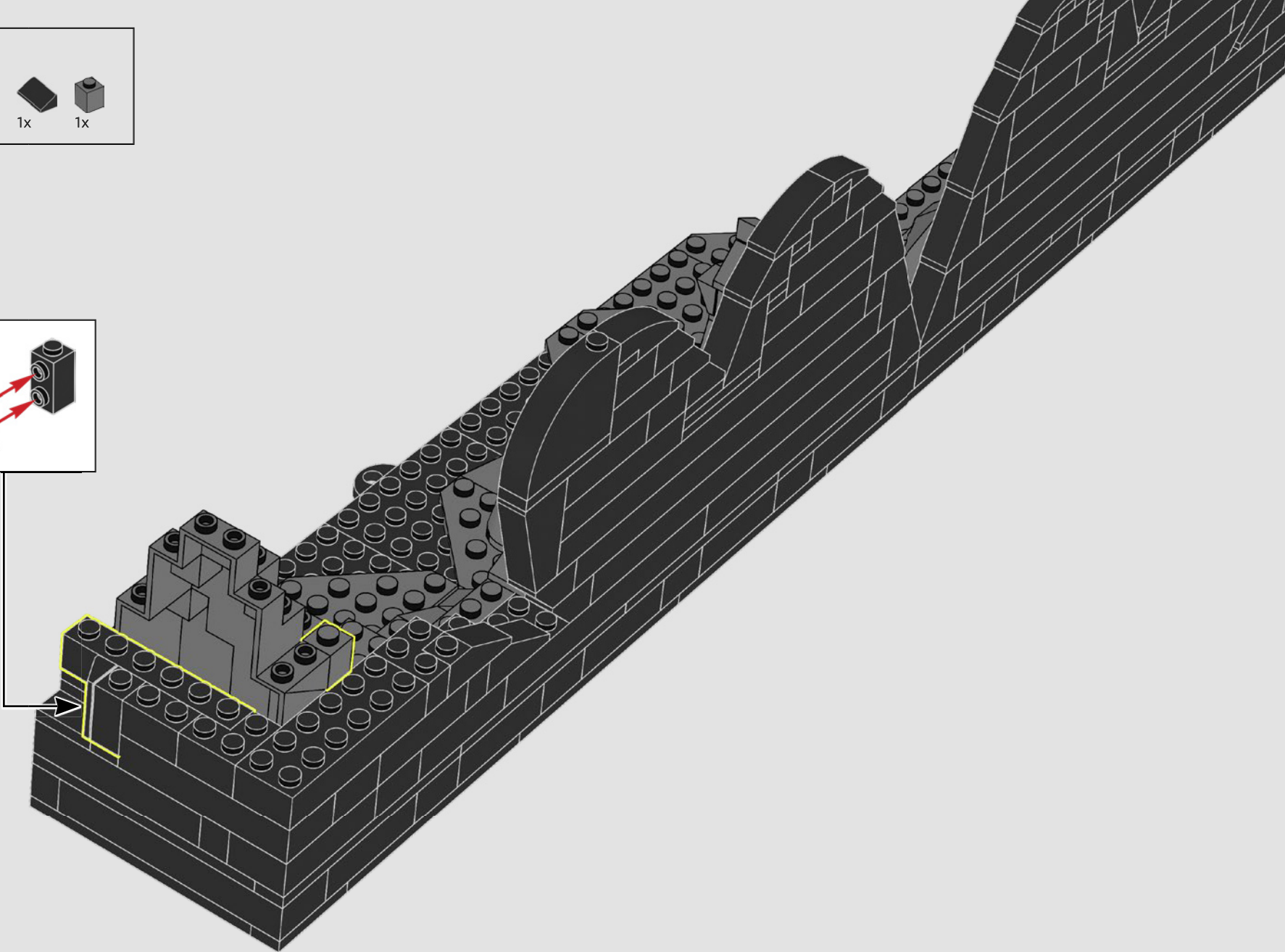
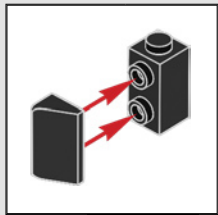

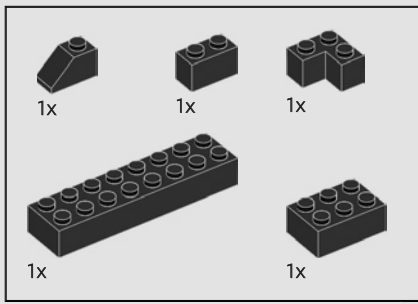

898

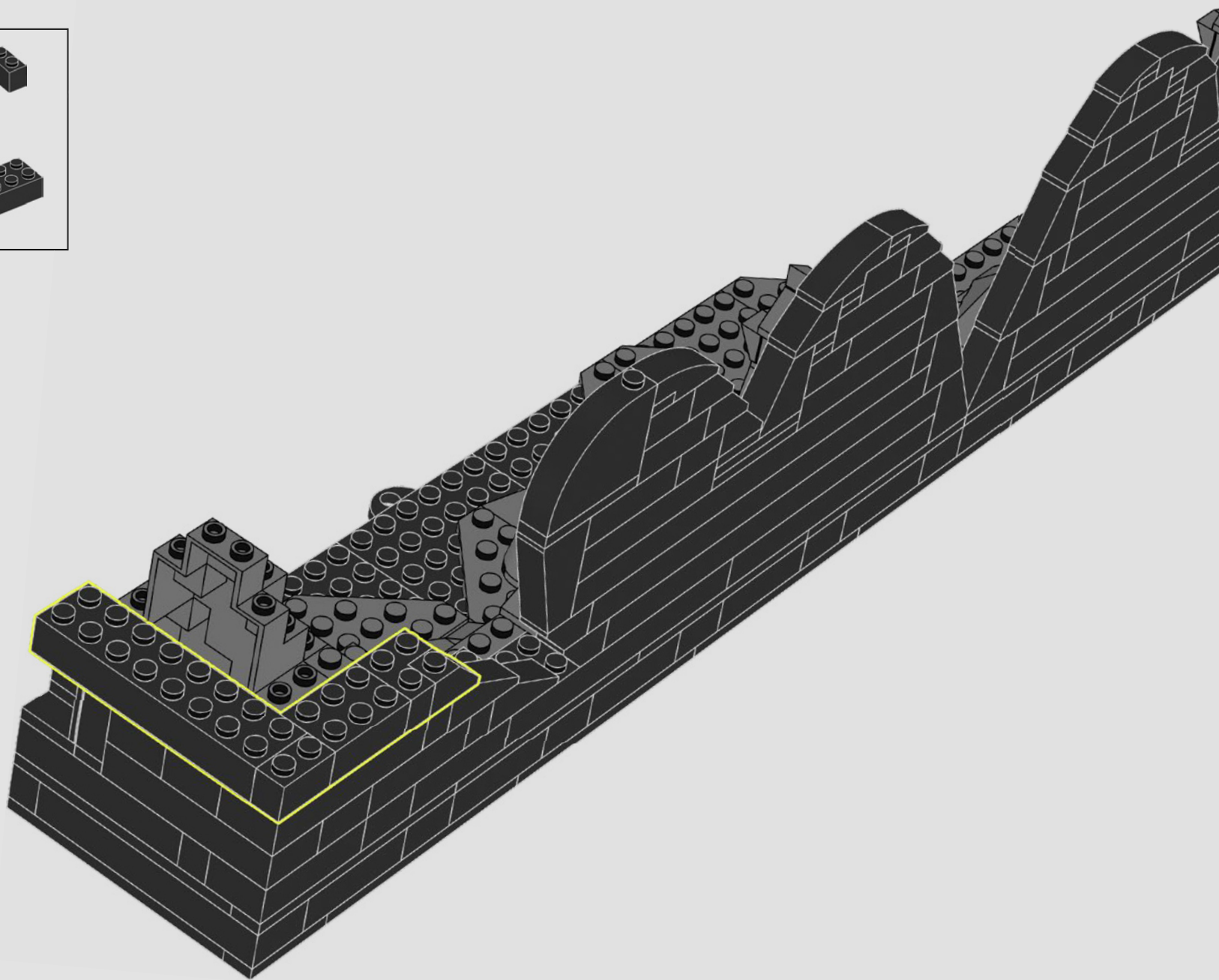

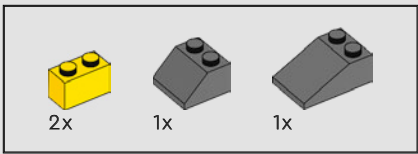

899

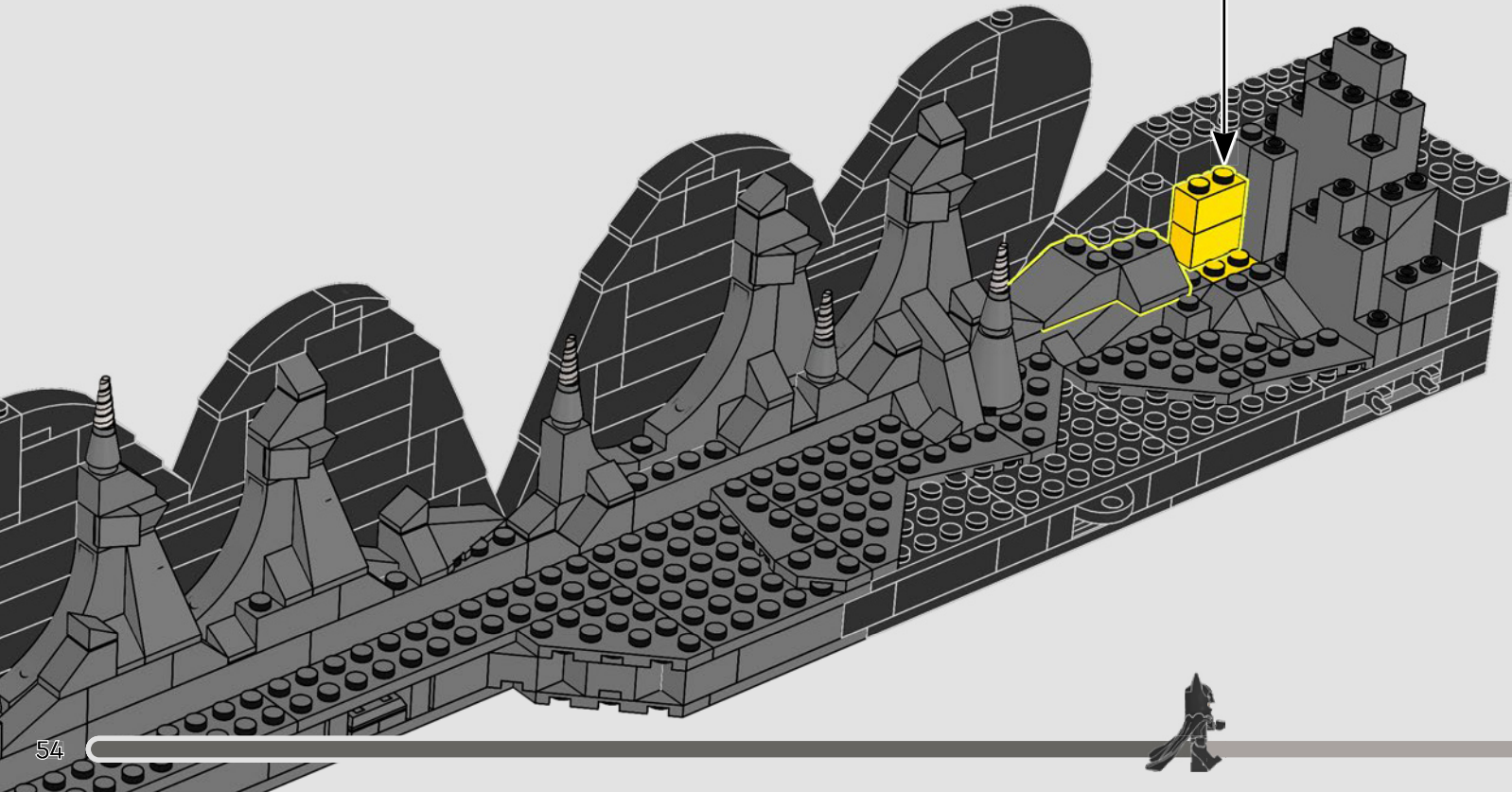
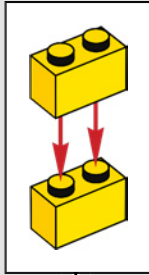



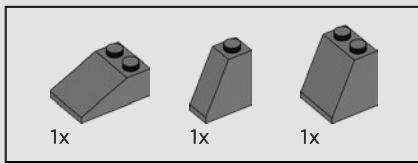

900

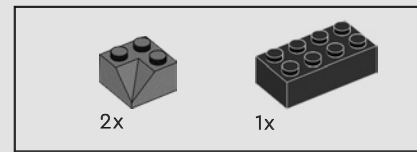
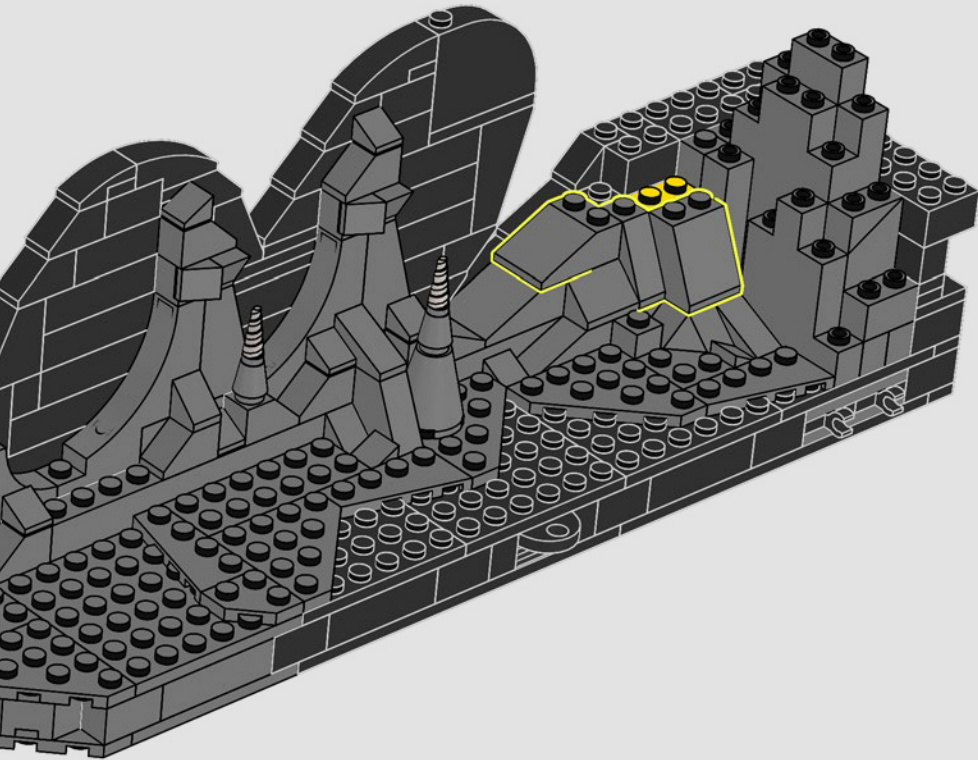

901

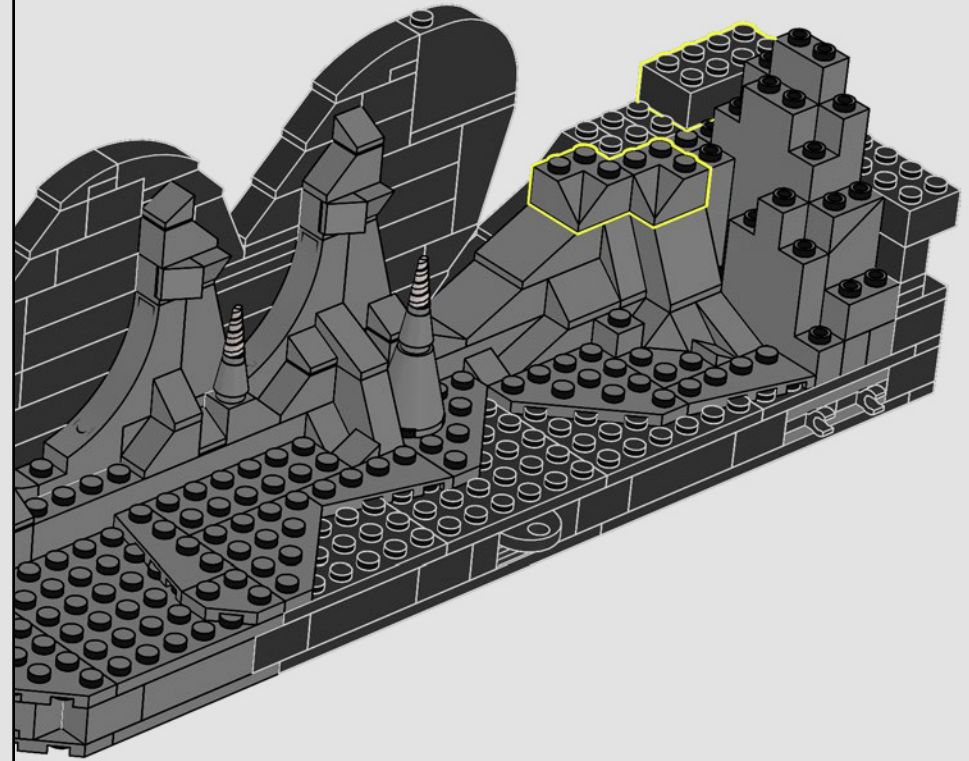

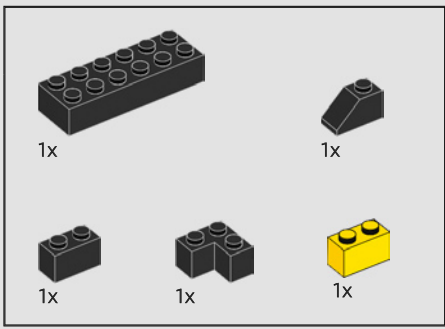

902

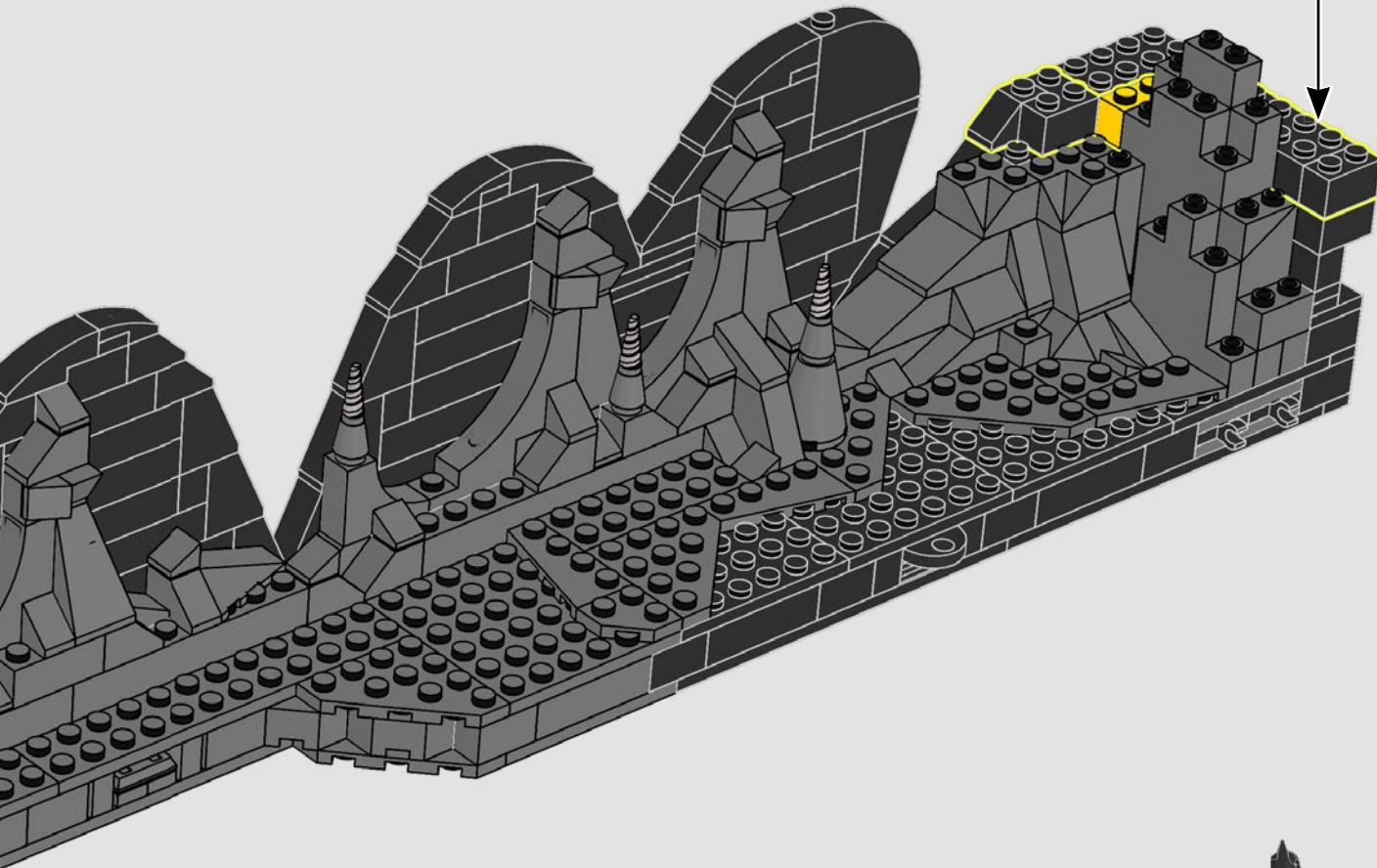
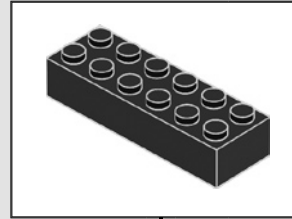

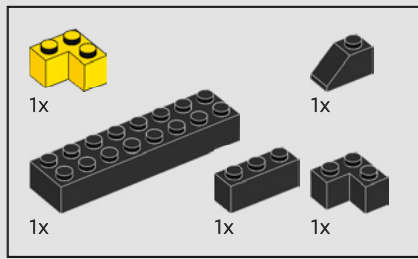

903

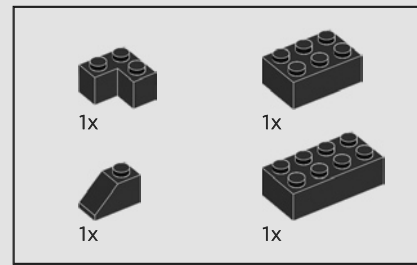
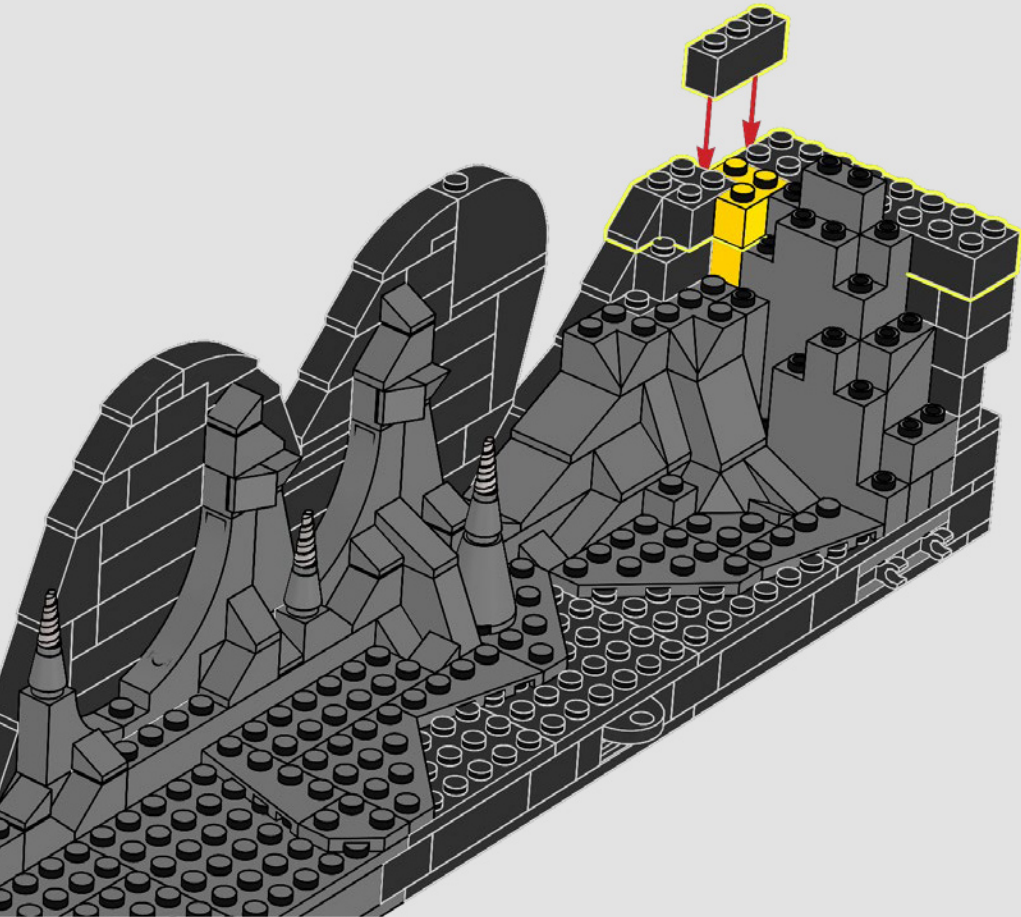

904

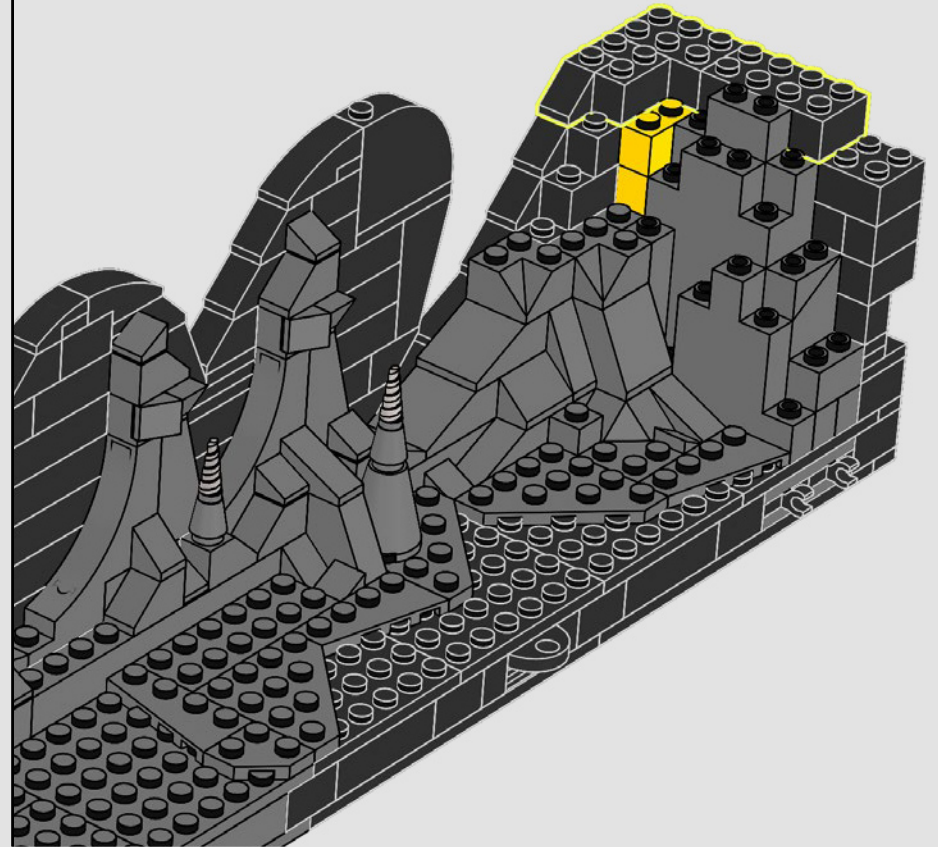



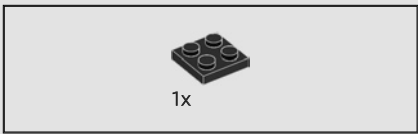

905

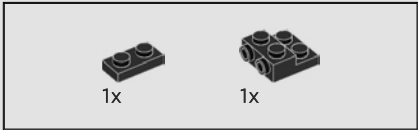

906

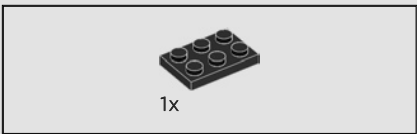

907

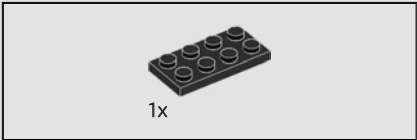
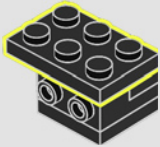

908

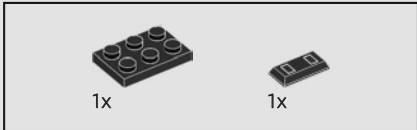
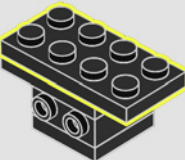

909

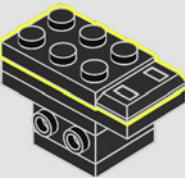

910

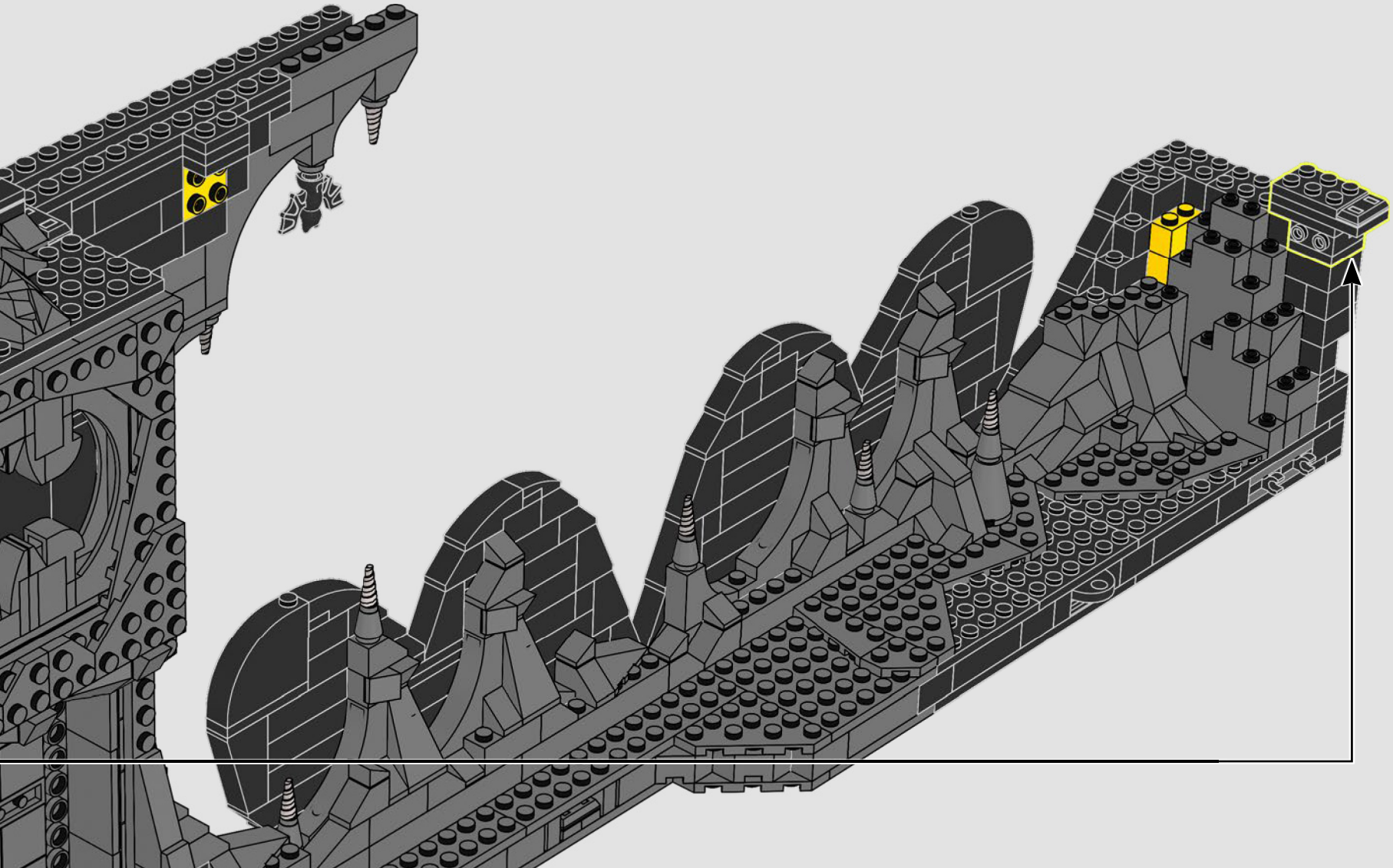

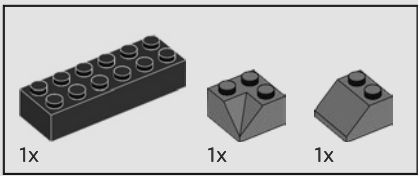

911

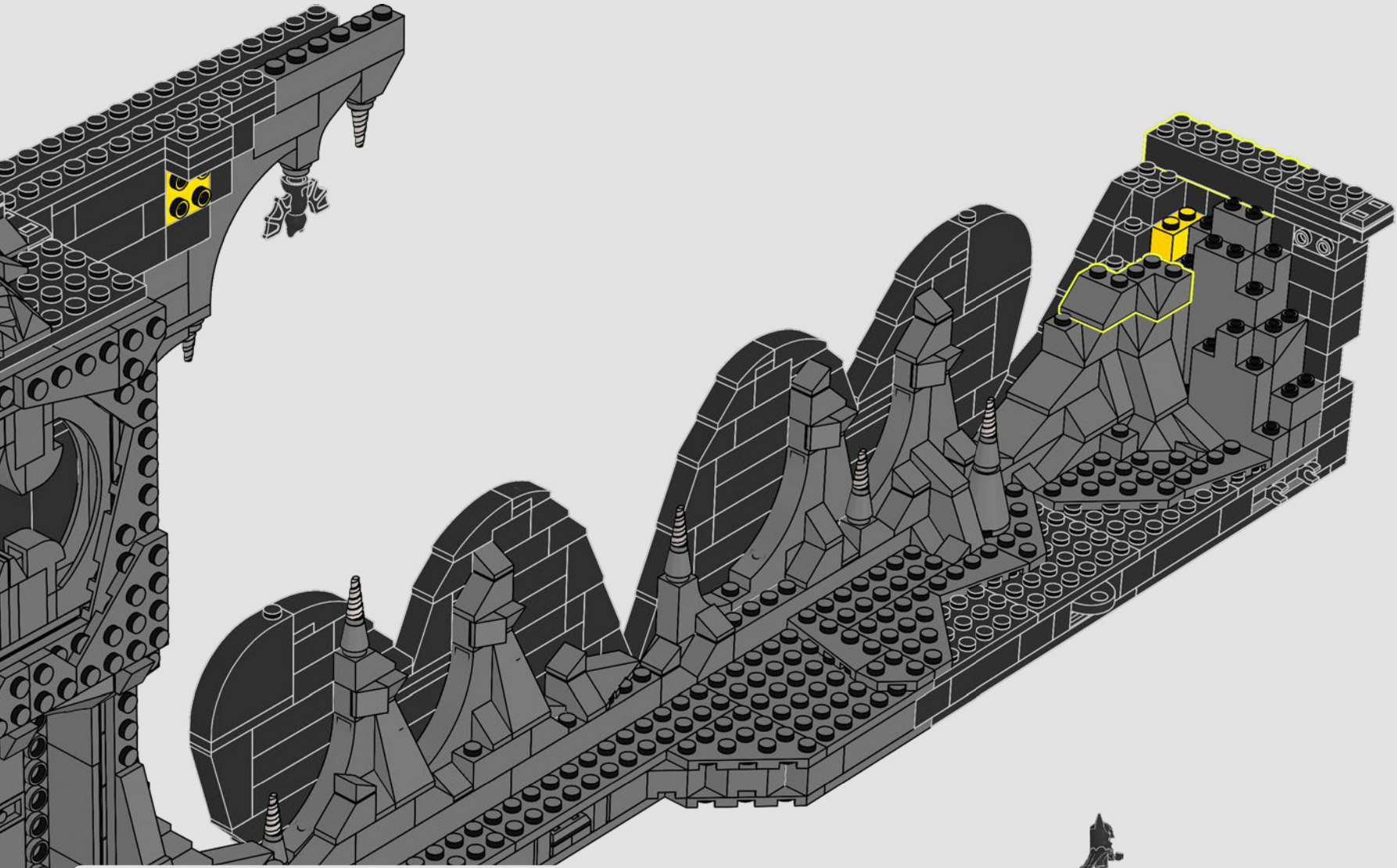



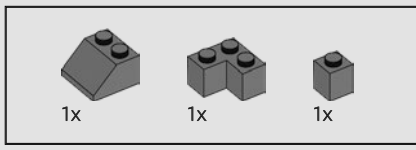

912

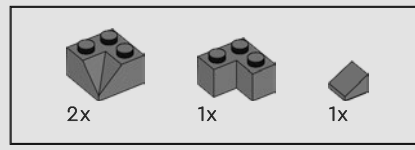
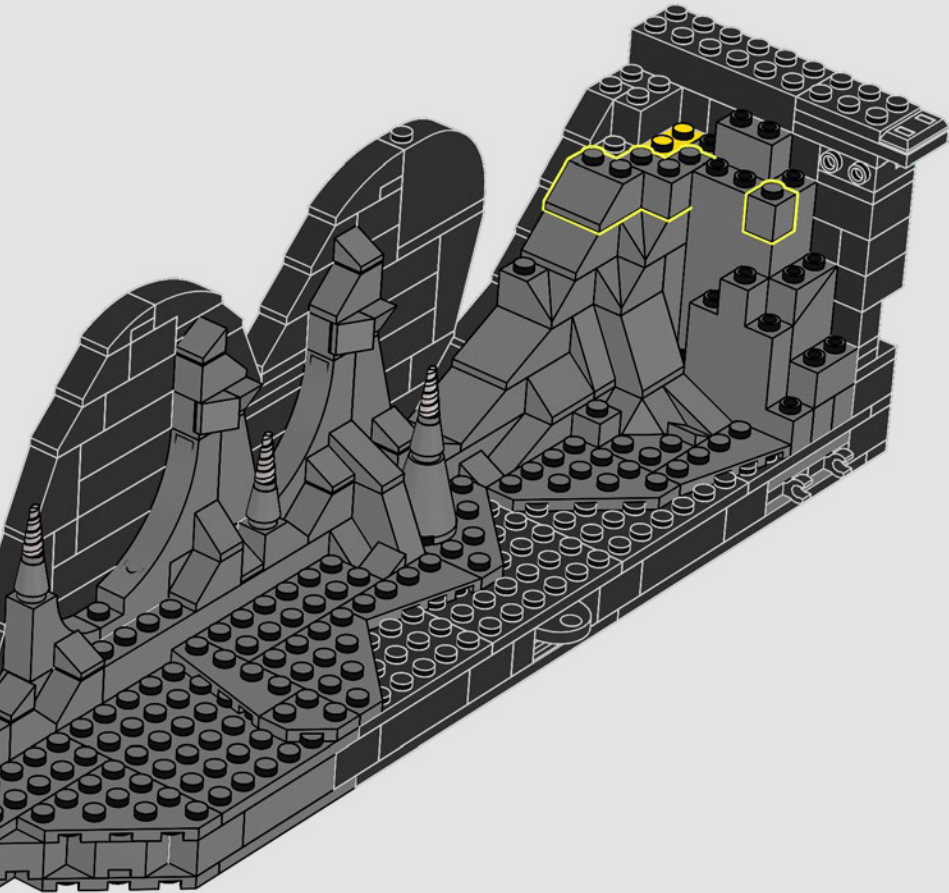

913

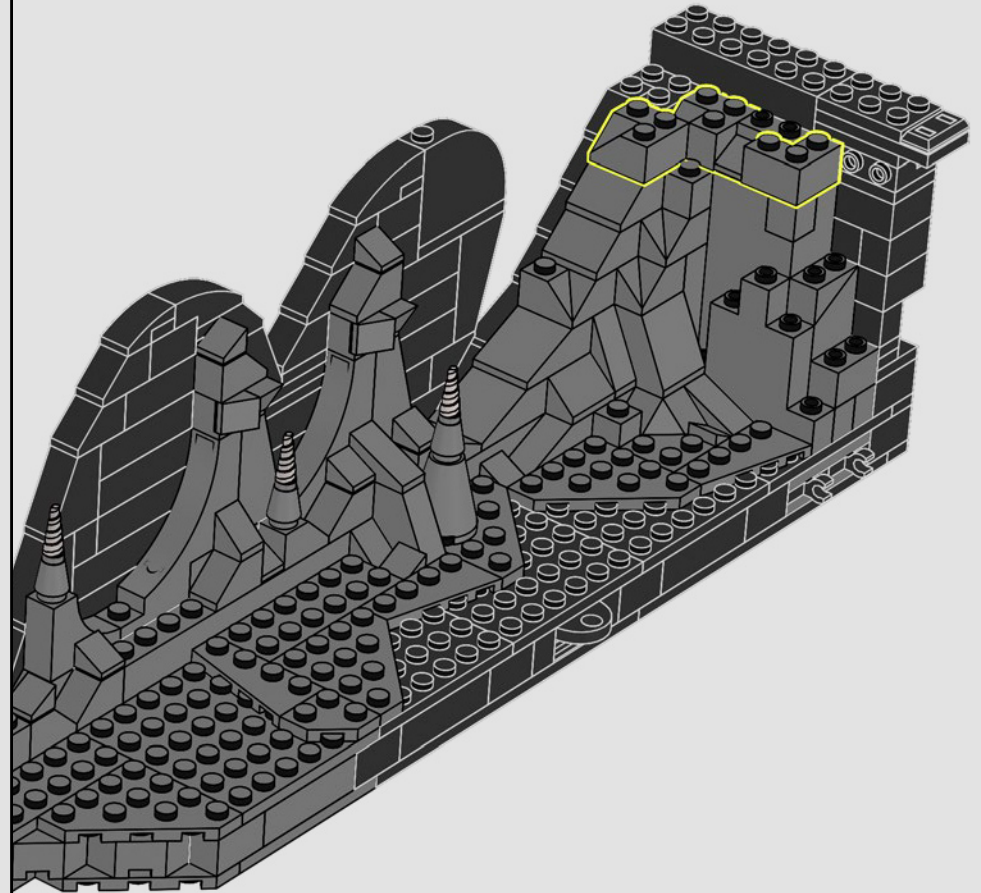

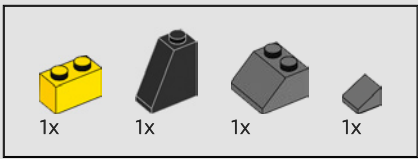

914

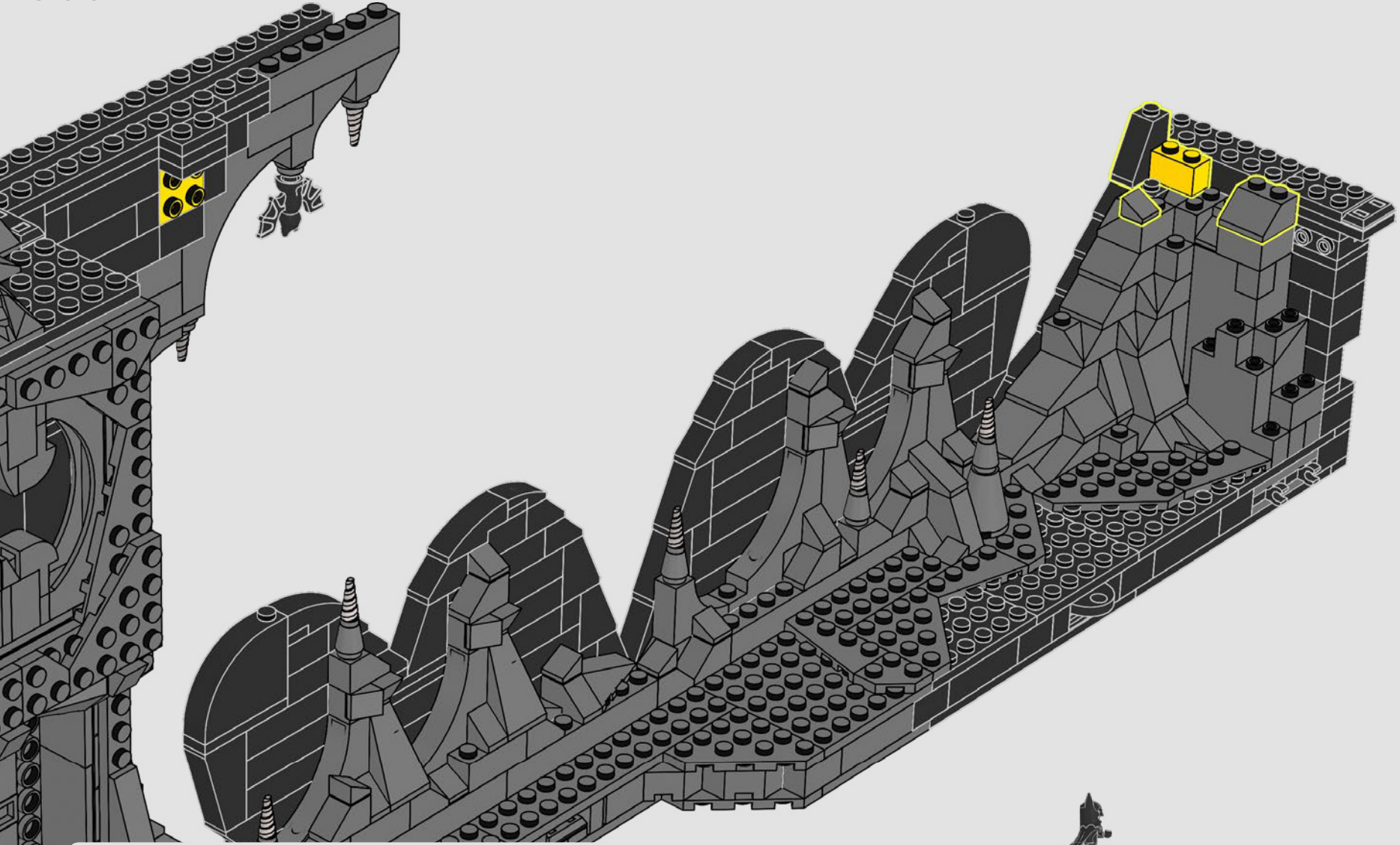



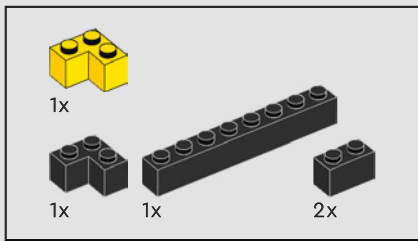

915

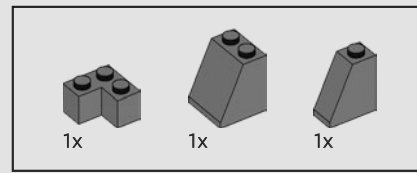
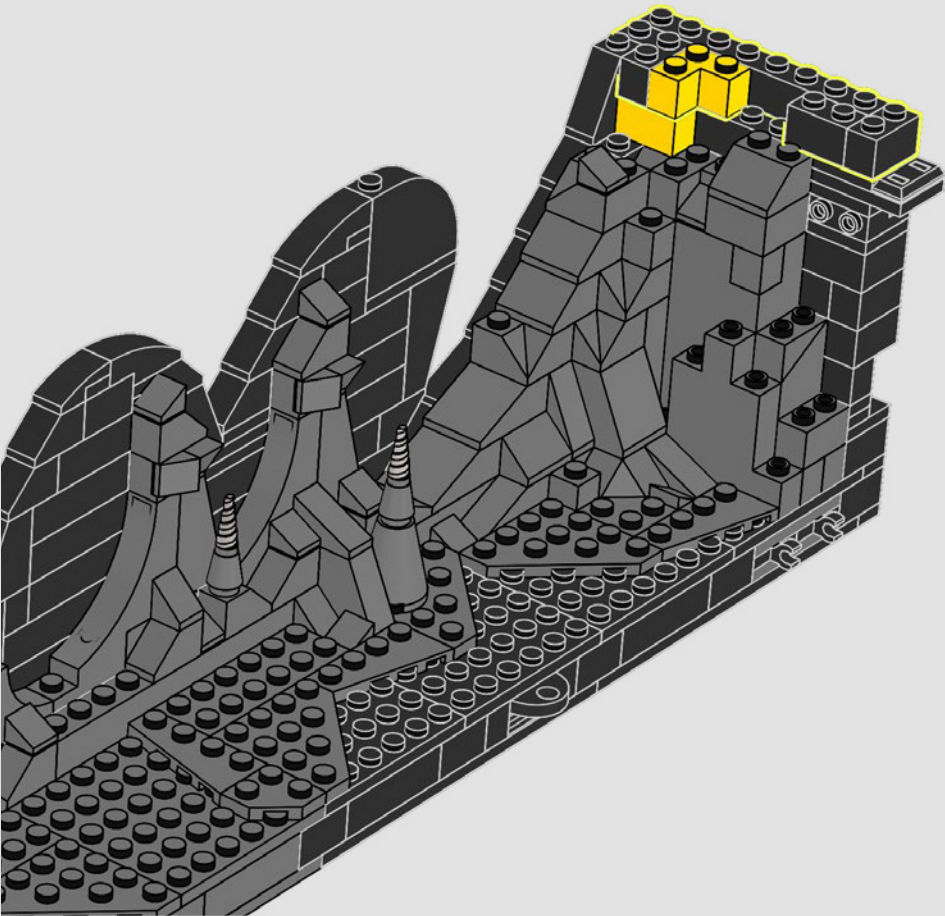

916

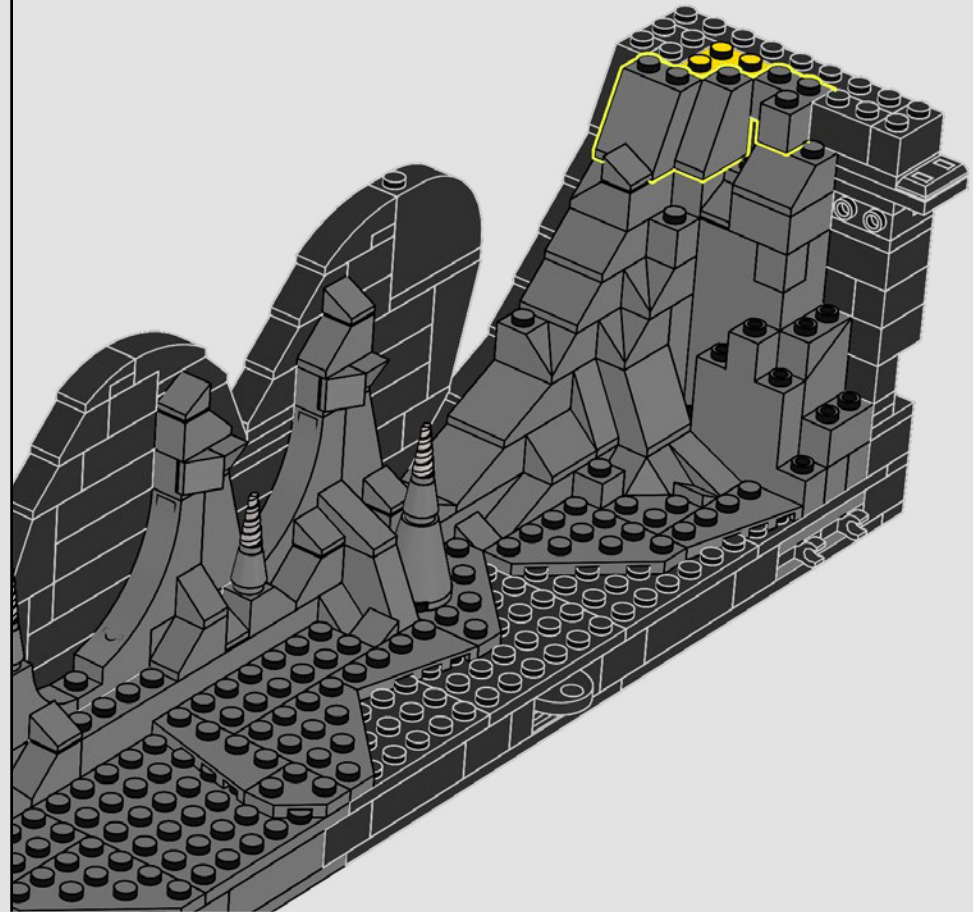



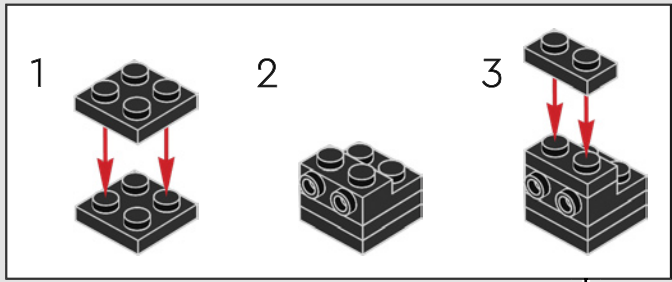
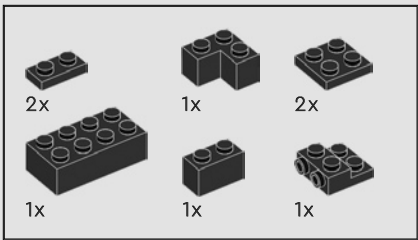

917

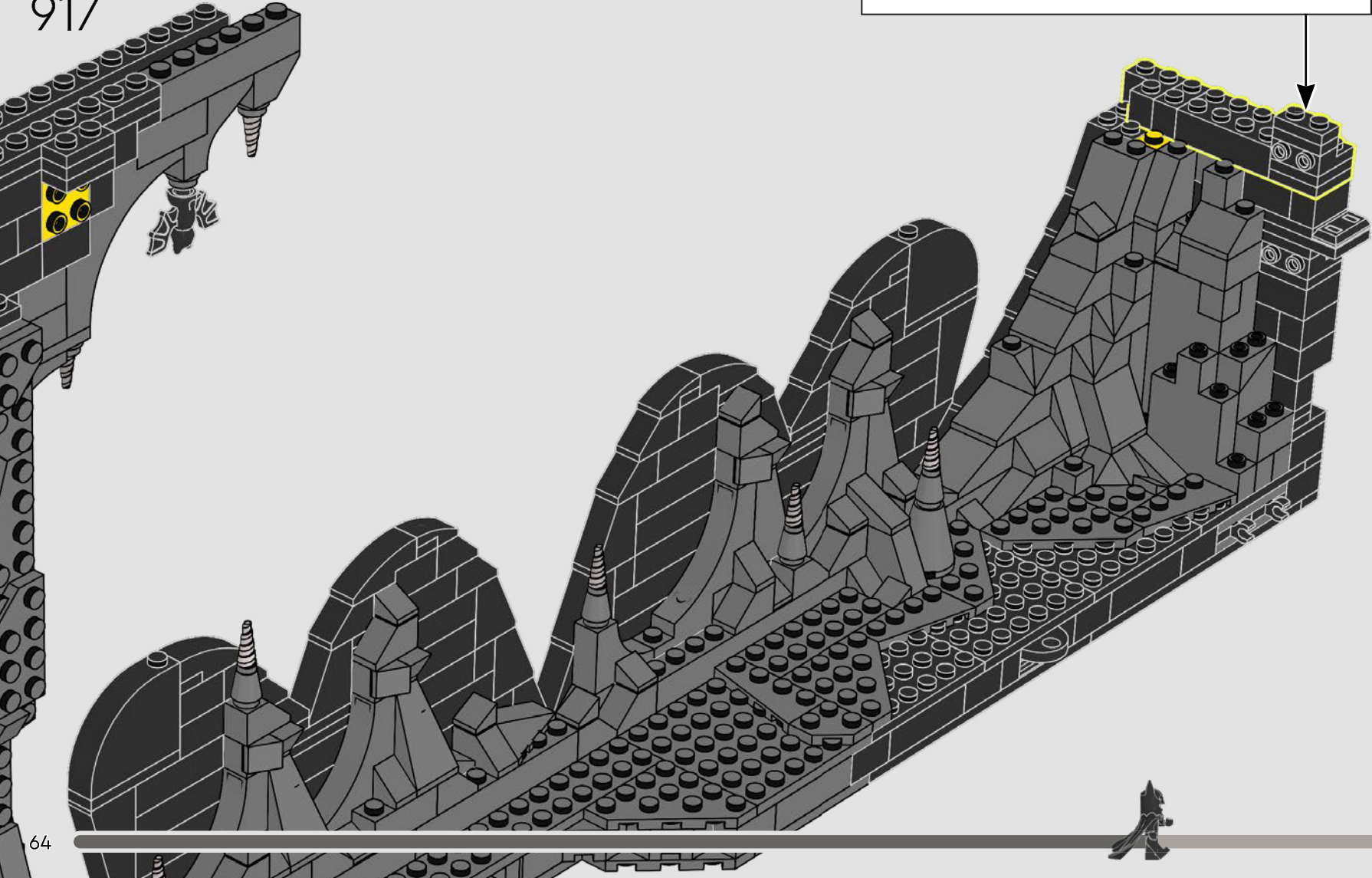

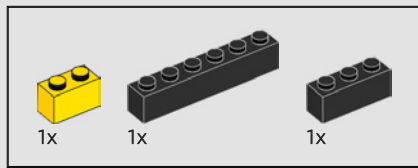

918

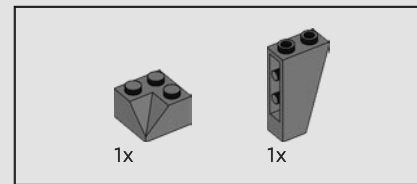
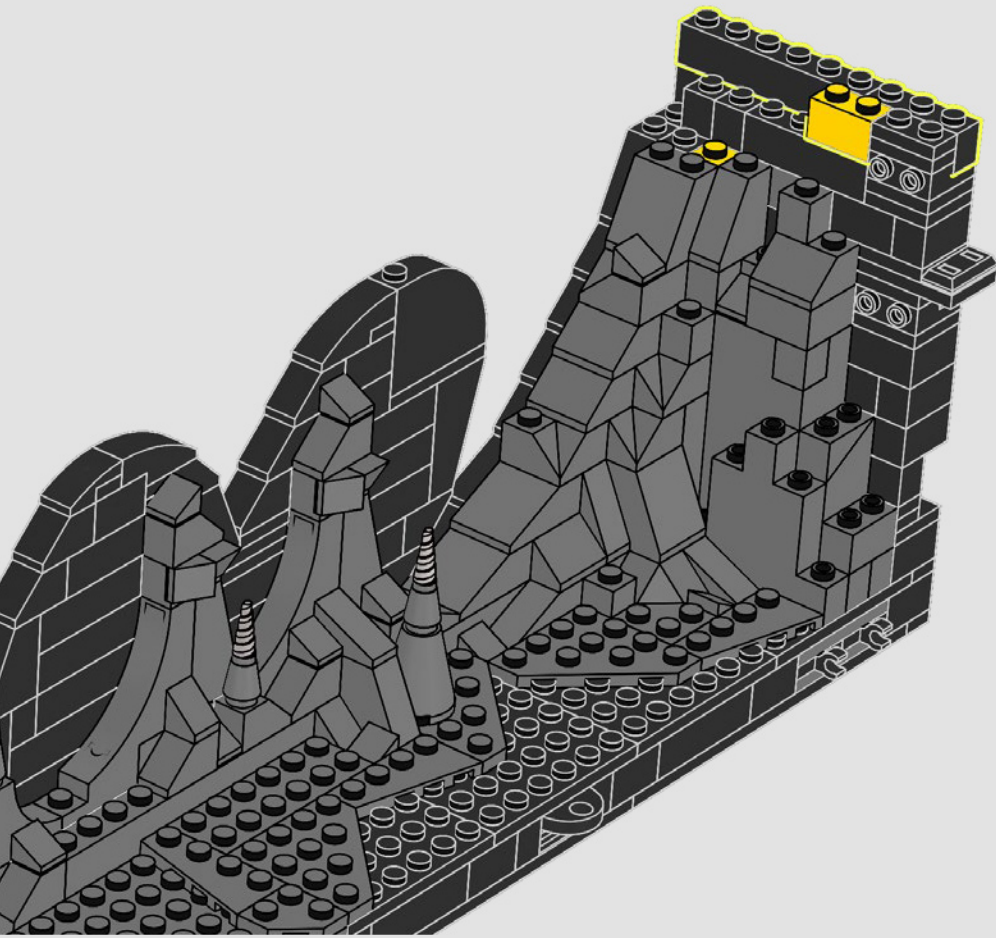

919

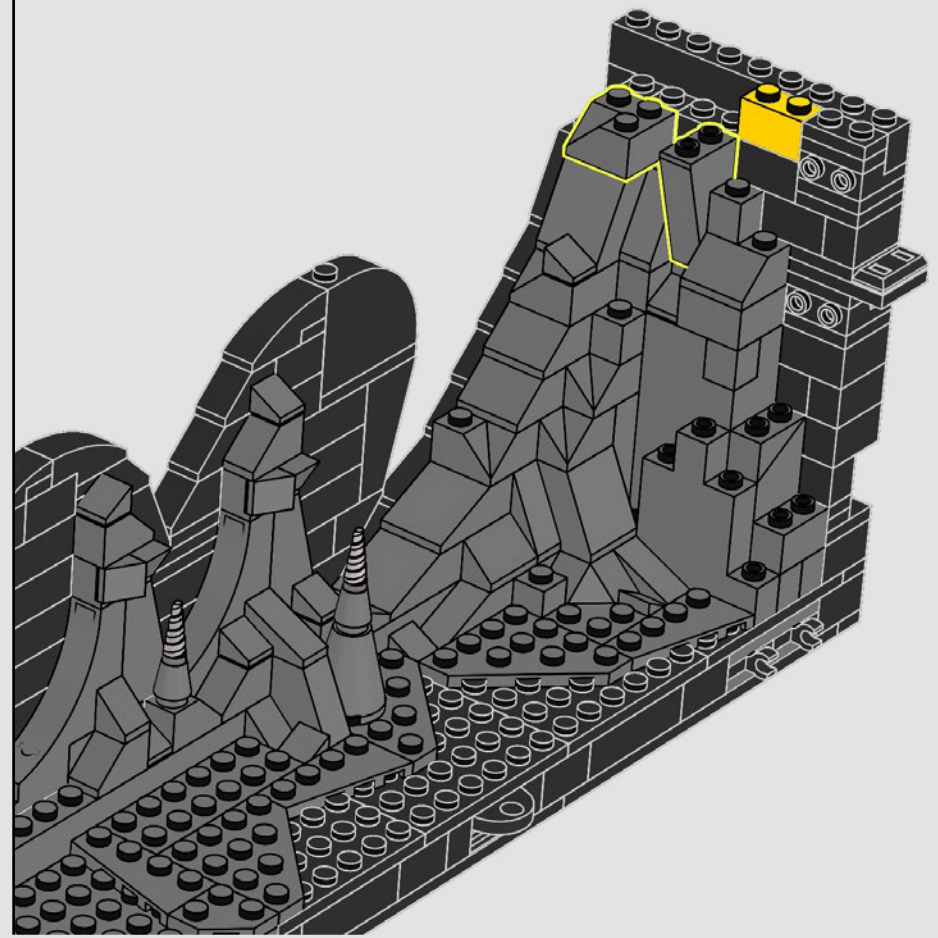

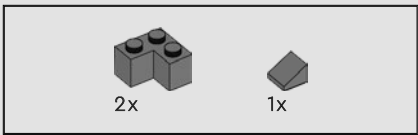

920

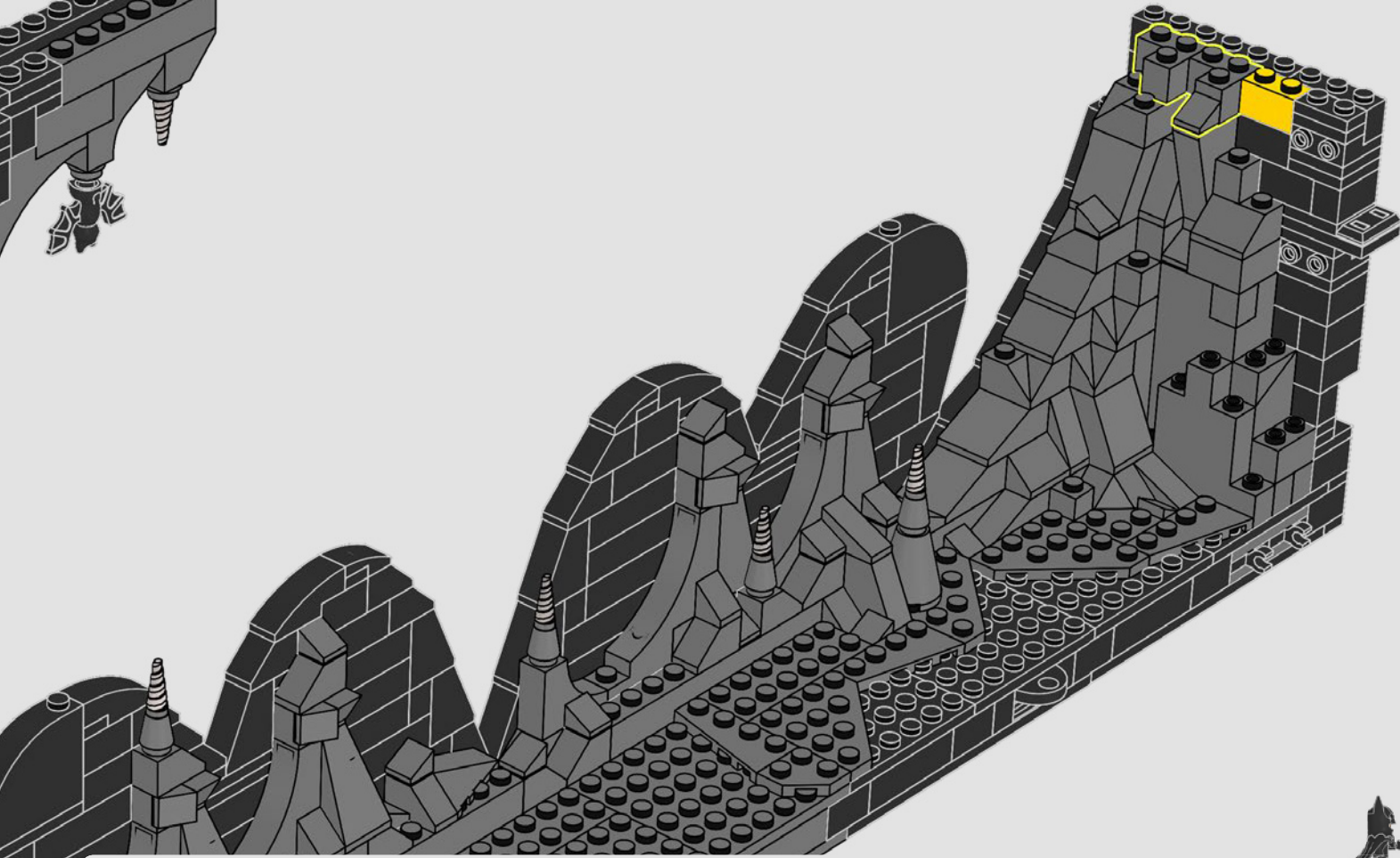
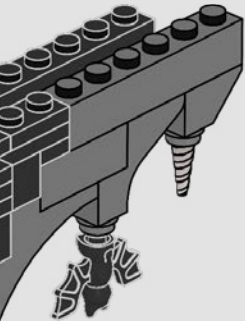



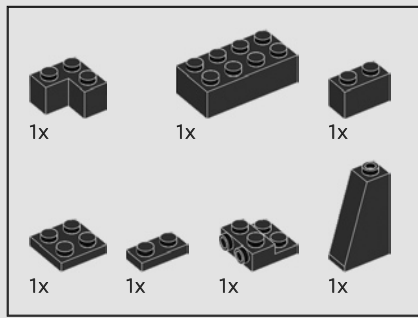

921

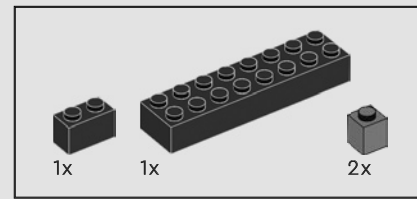
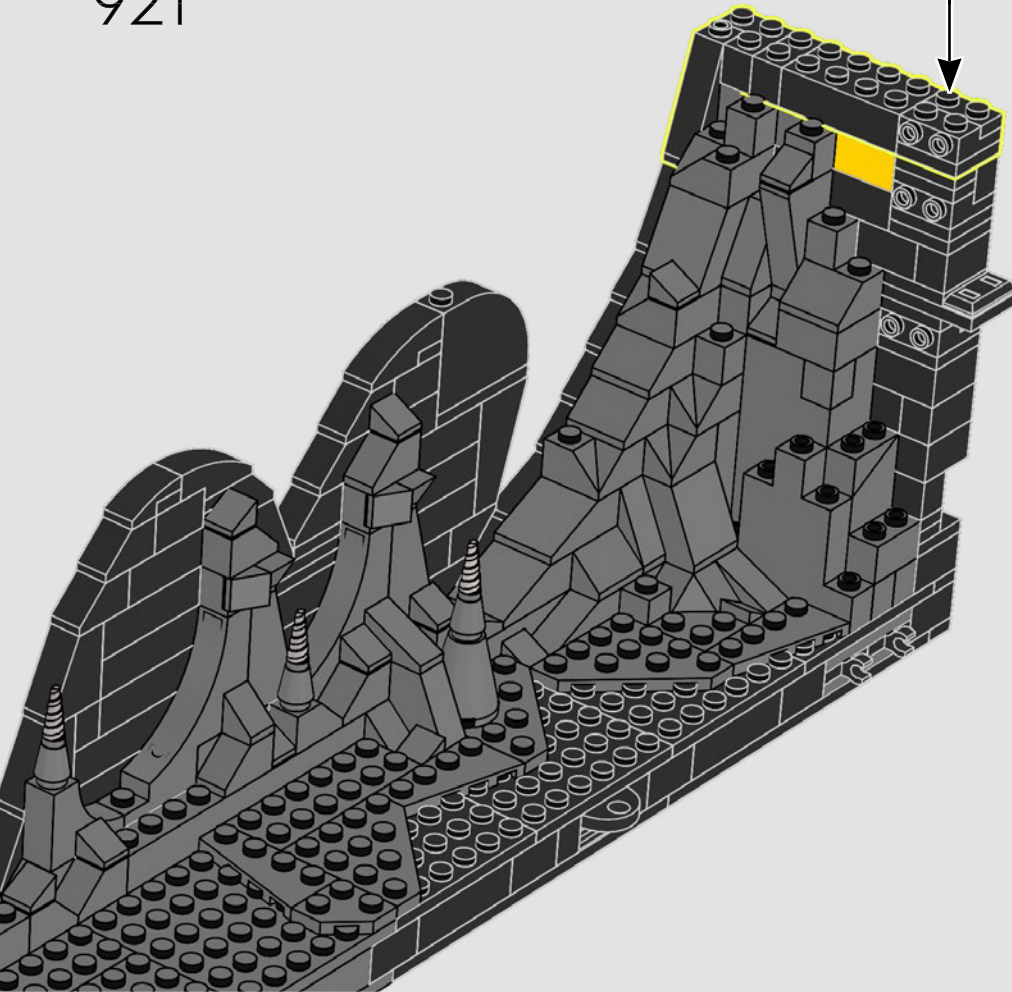
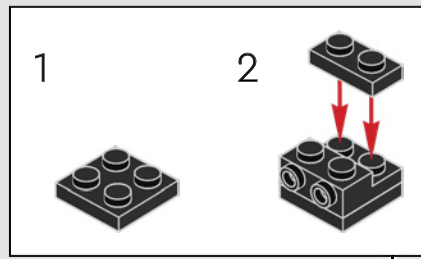

922

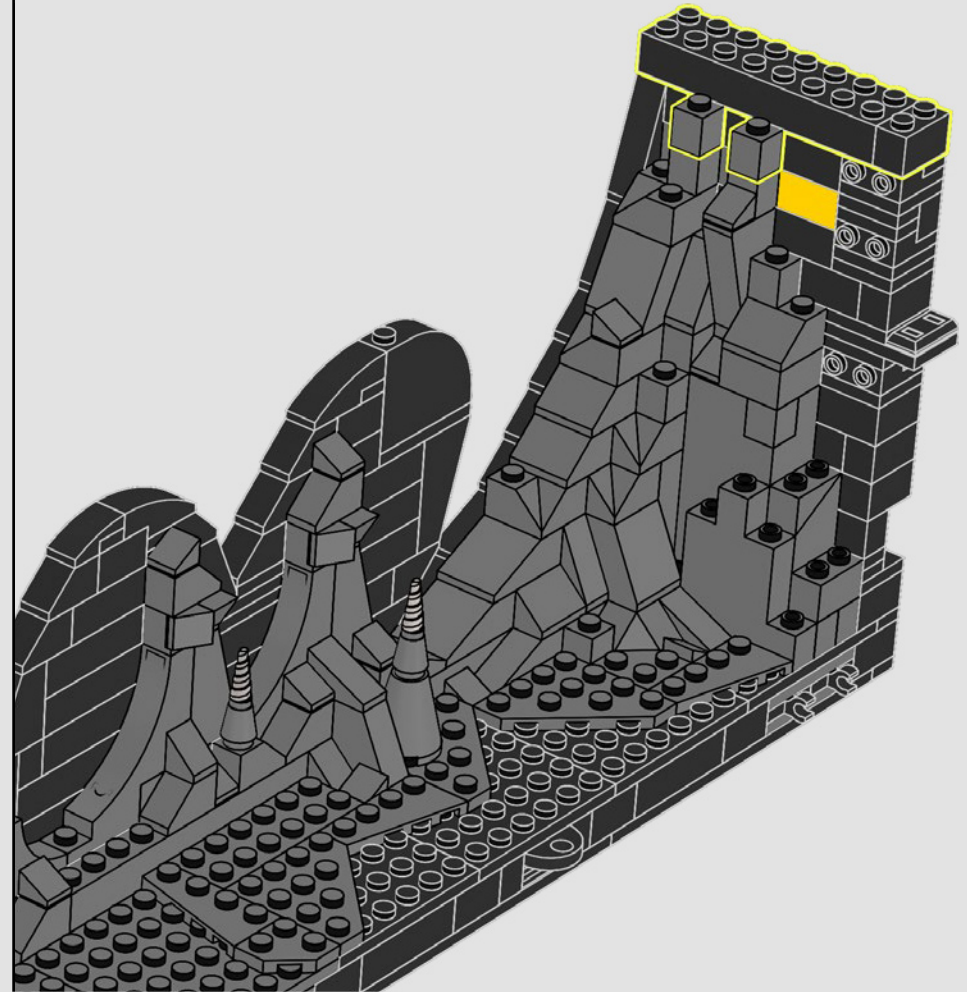

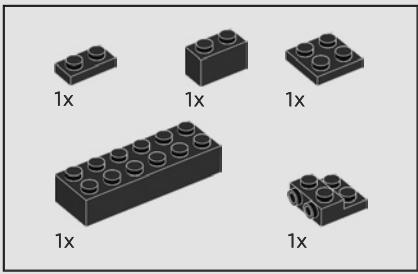

923

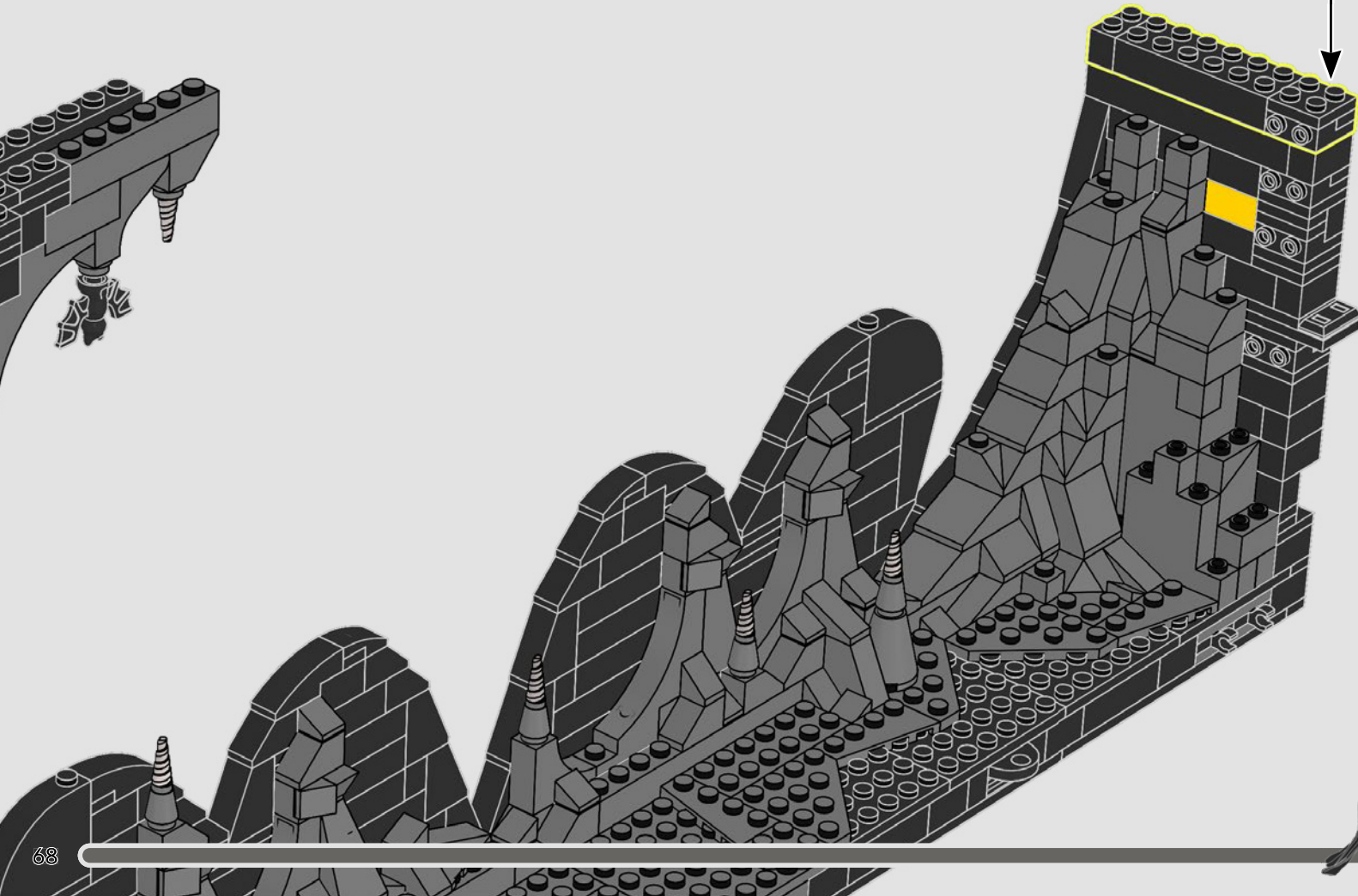
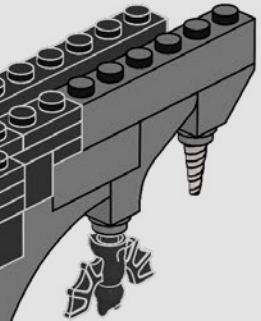
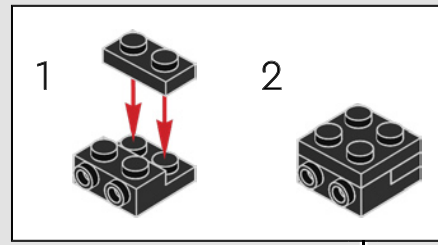



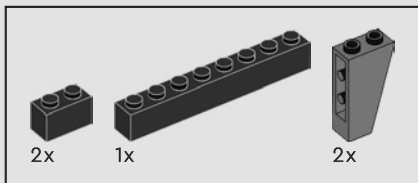

924

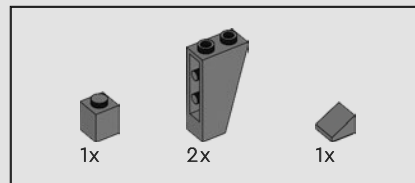
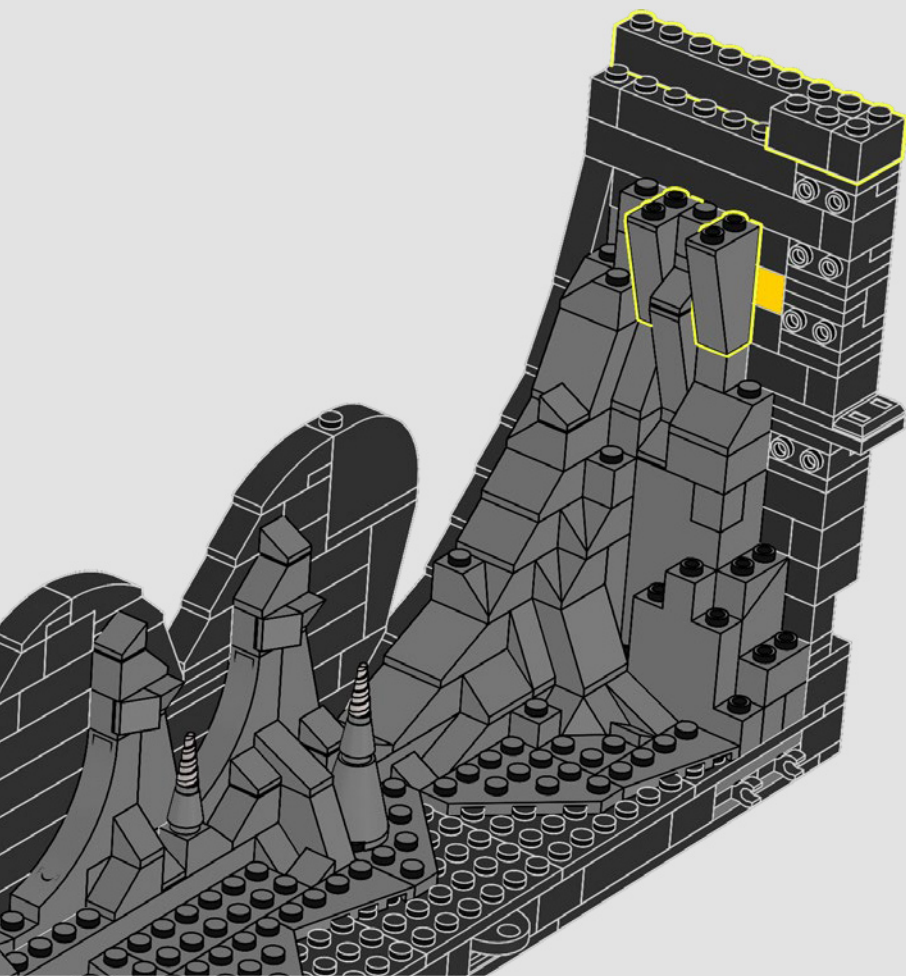

925

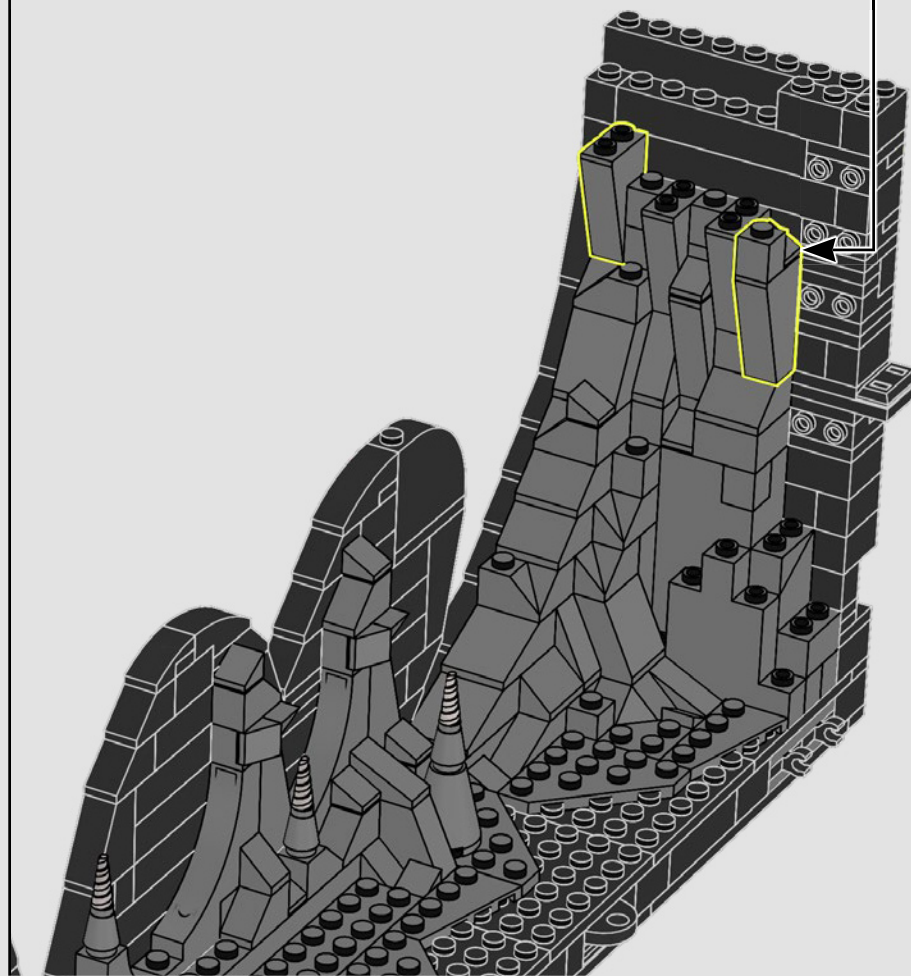
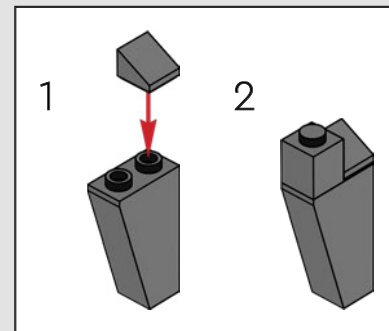



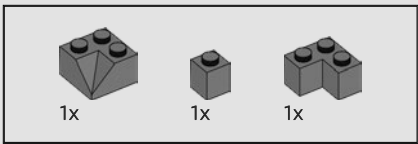

926

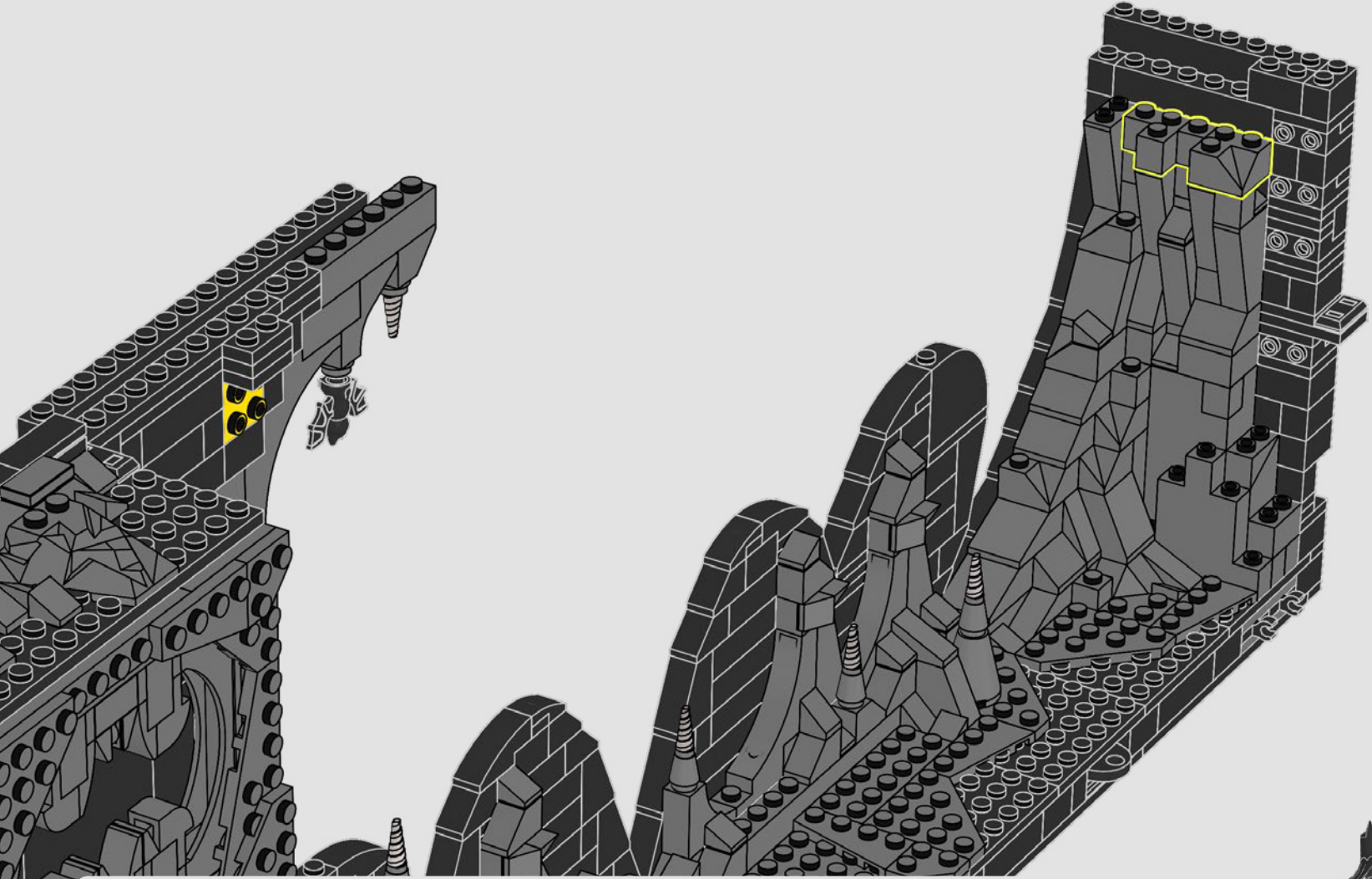

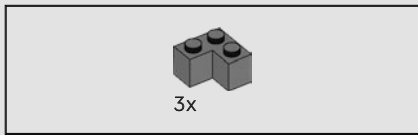

927

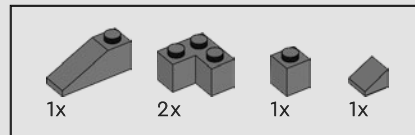
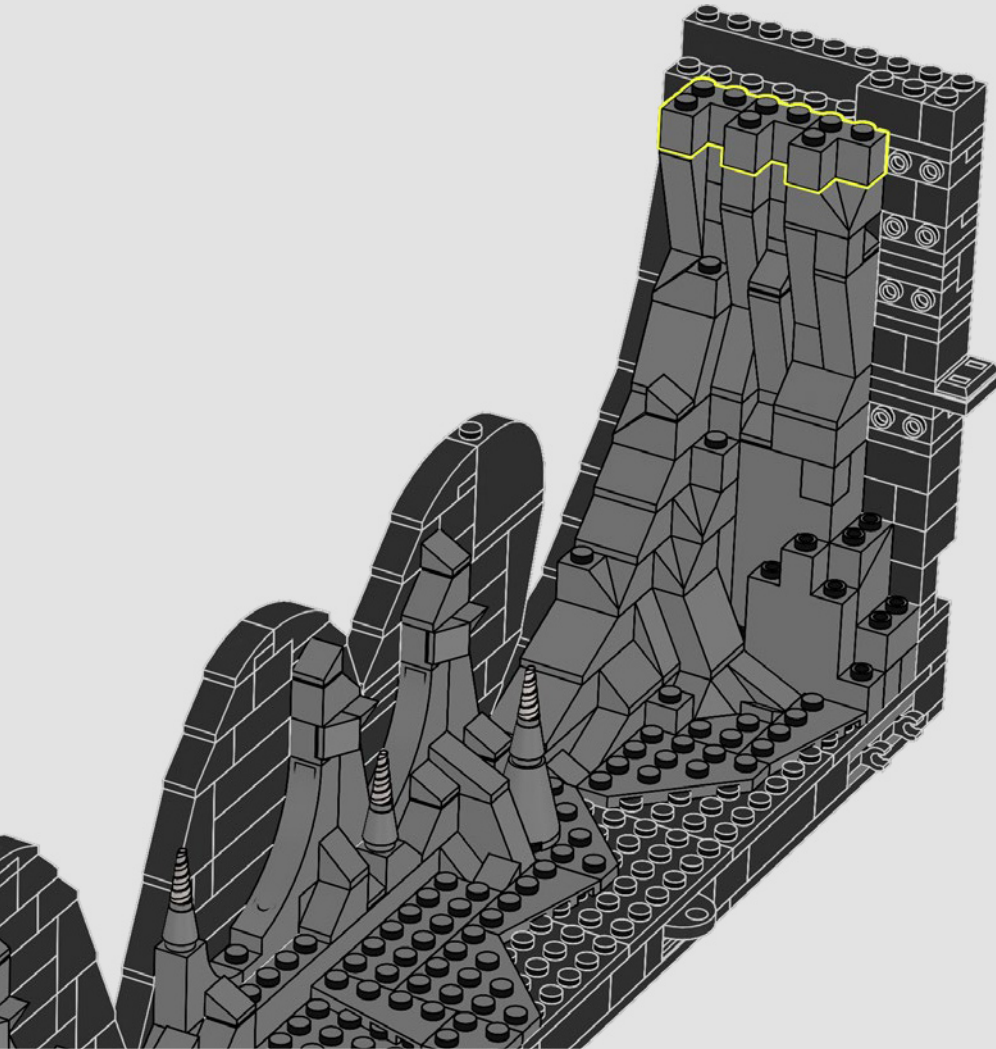

928

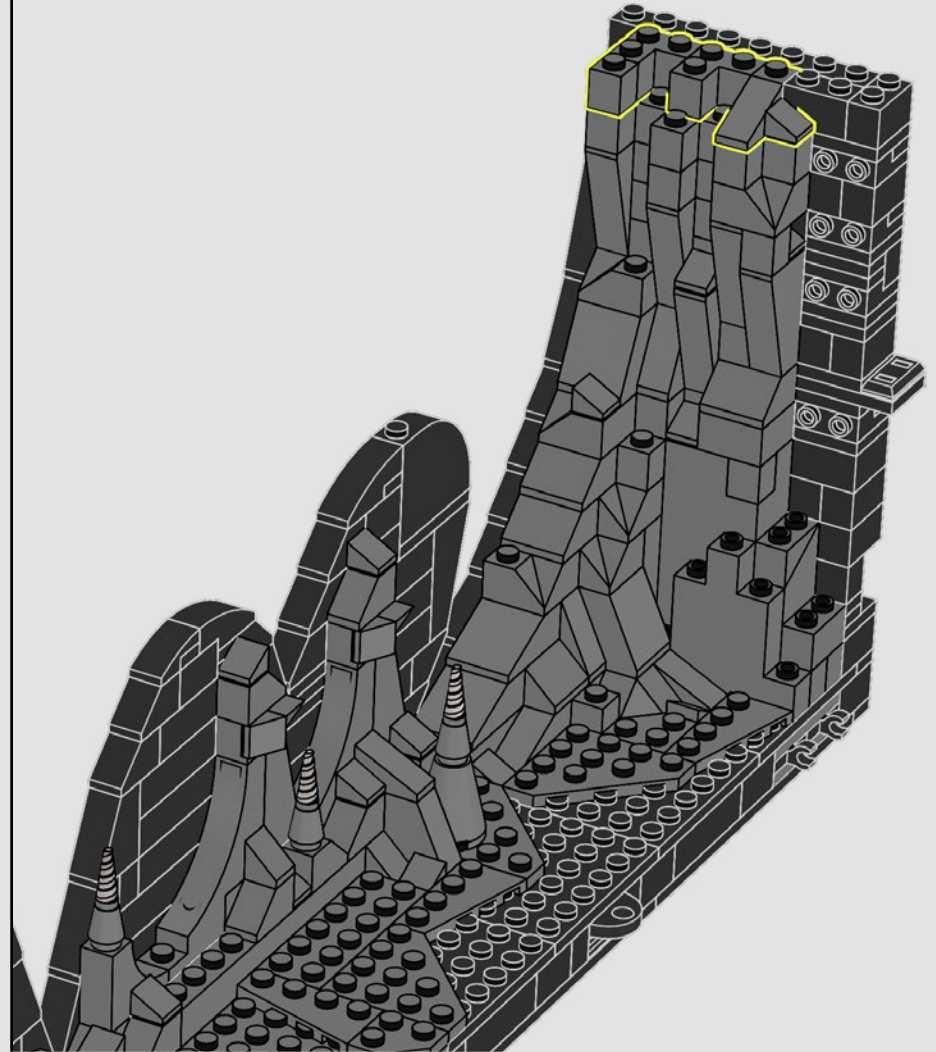



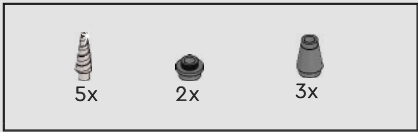

929

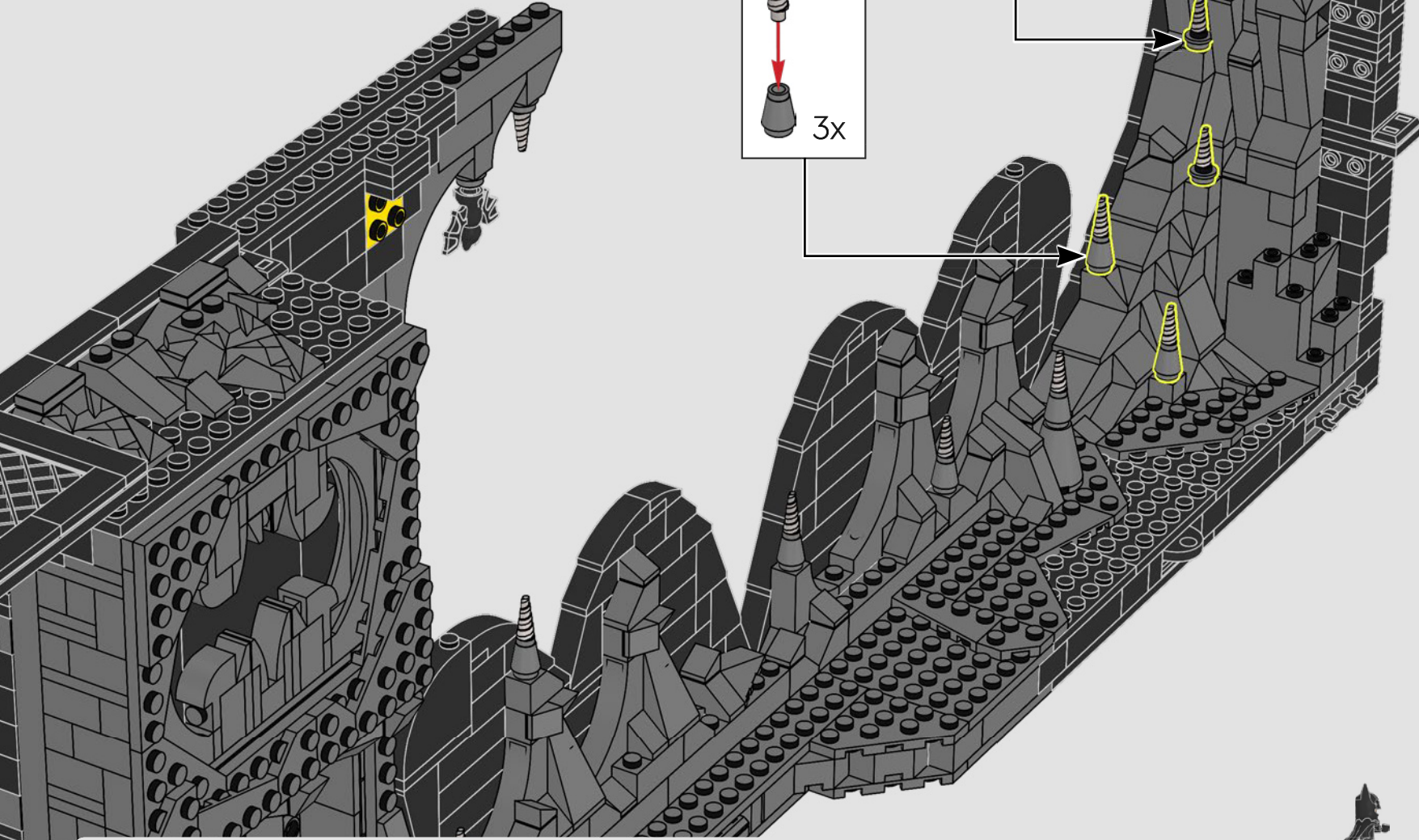
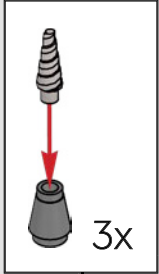
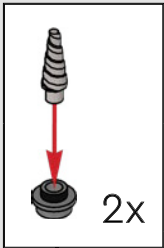



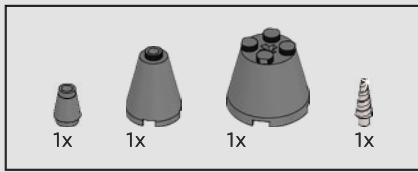

930

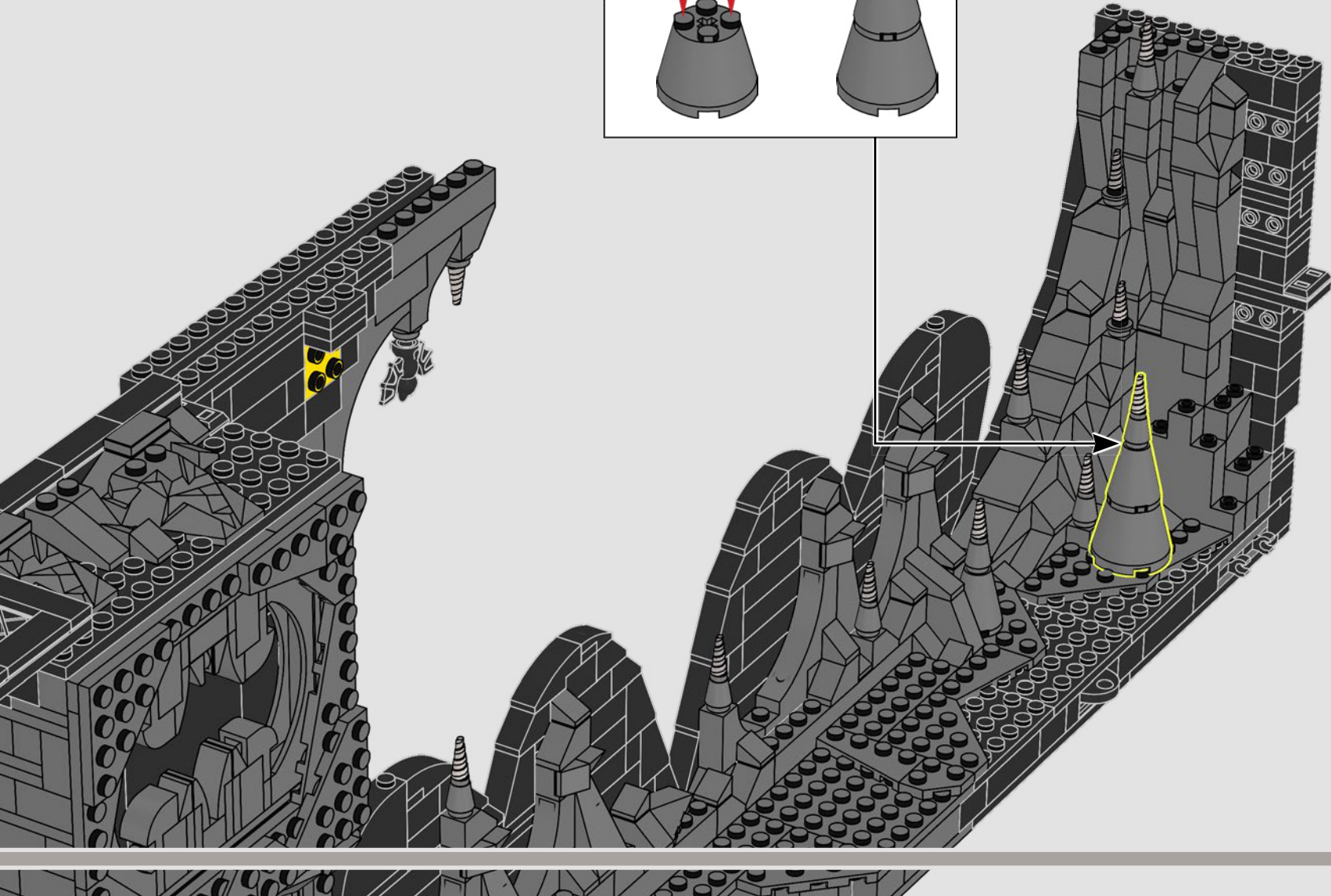
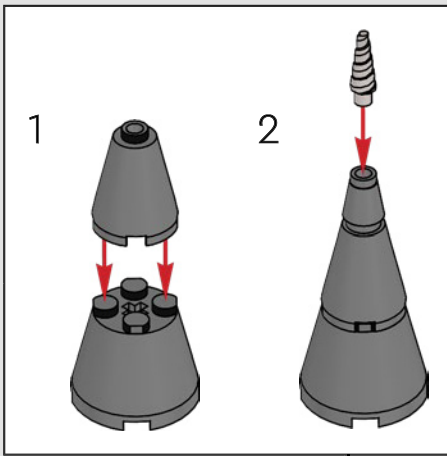



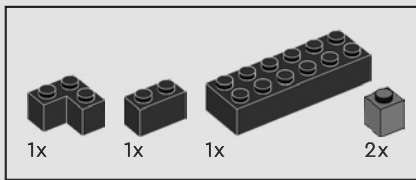

931

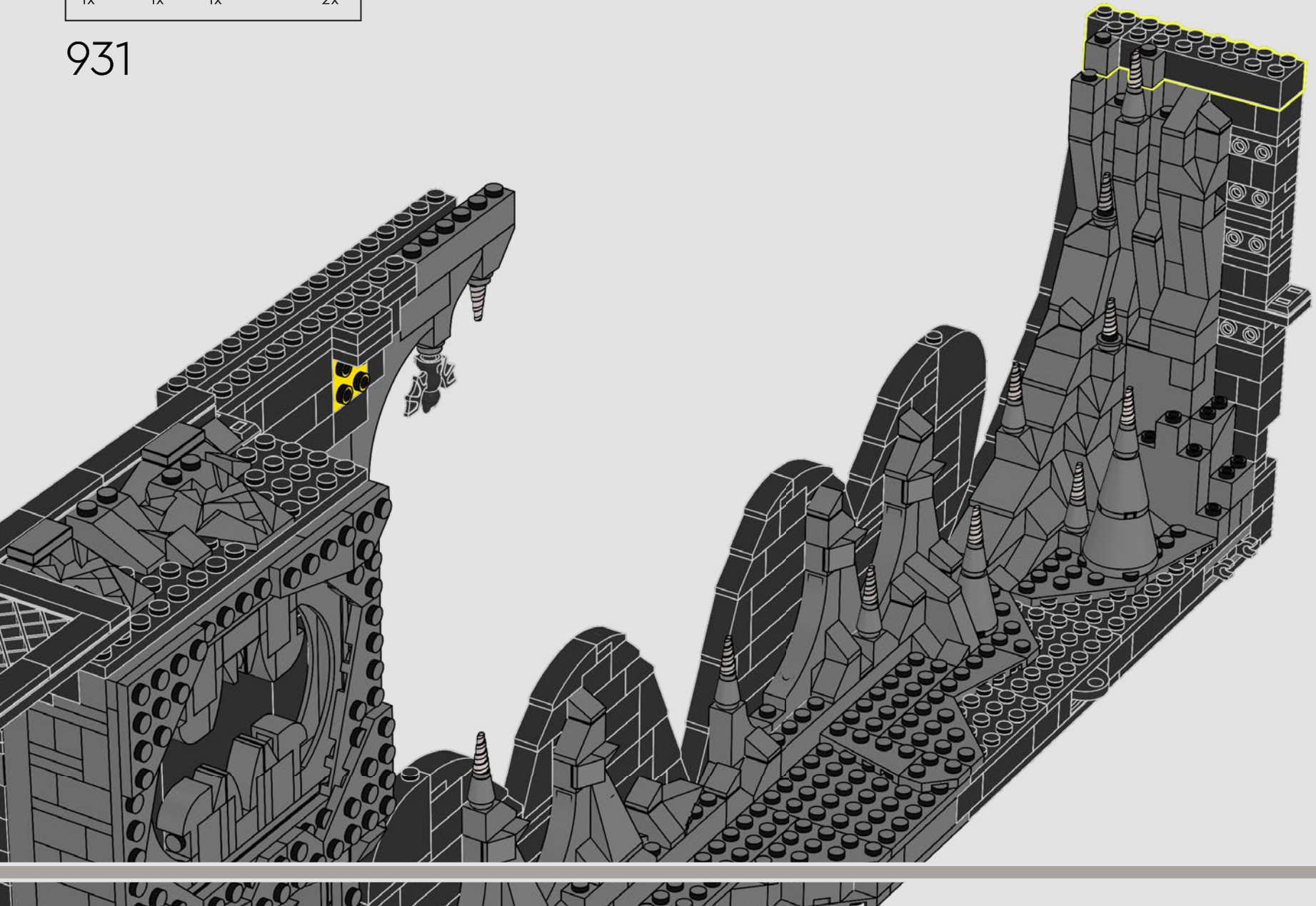



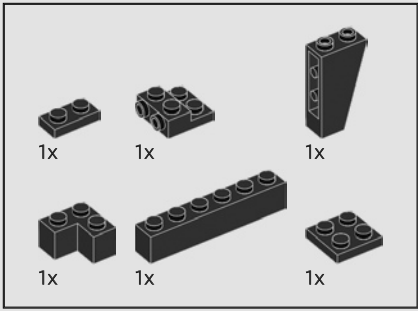

932

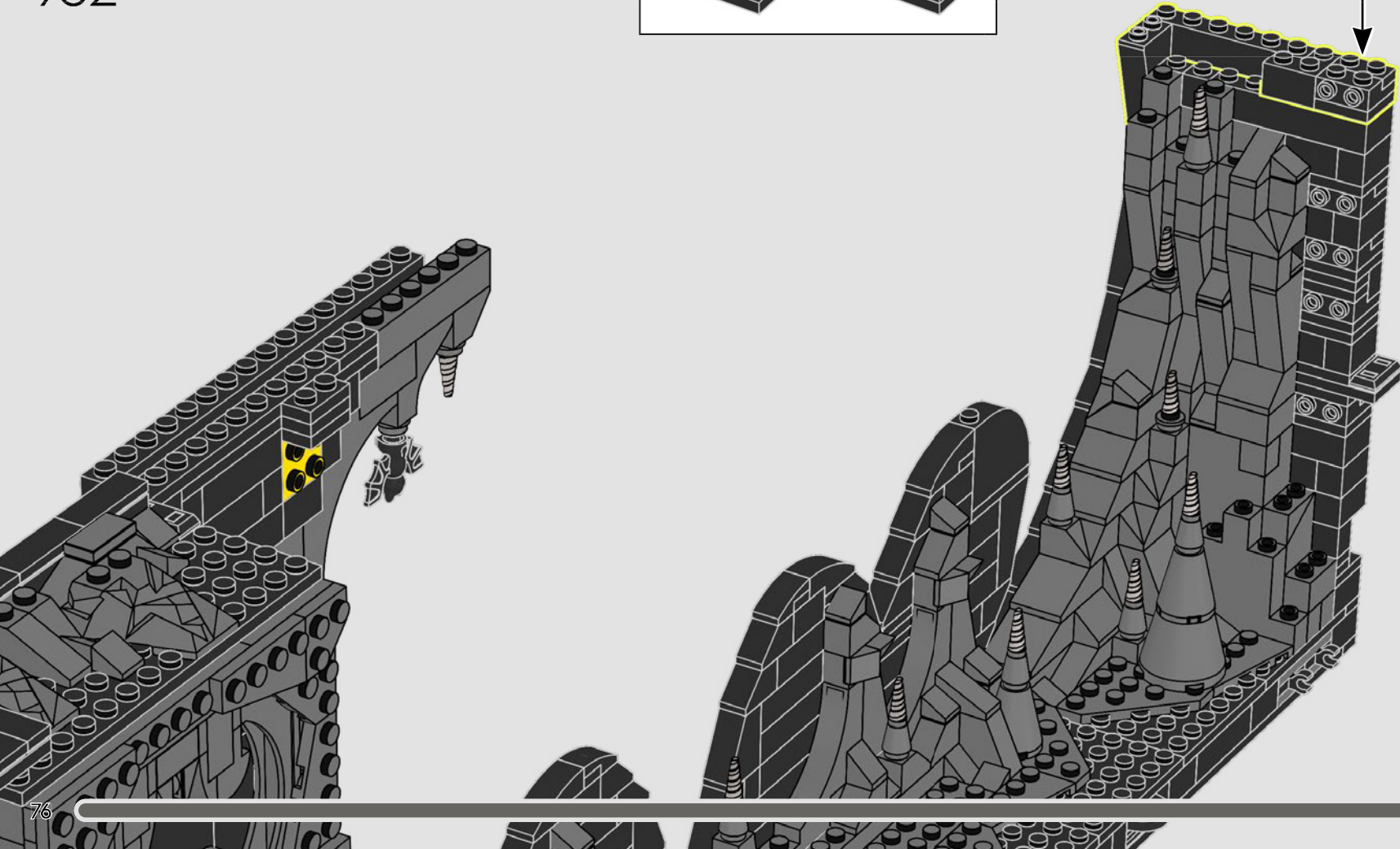
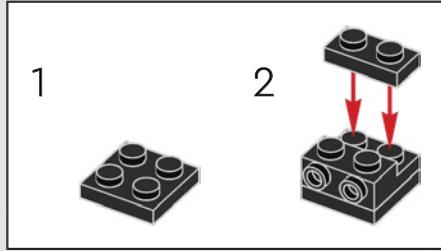

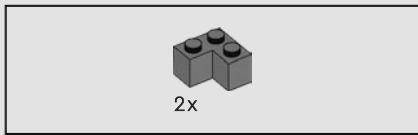

933

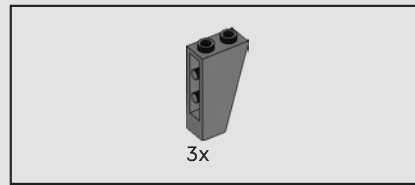
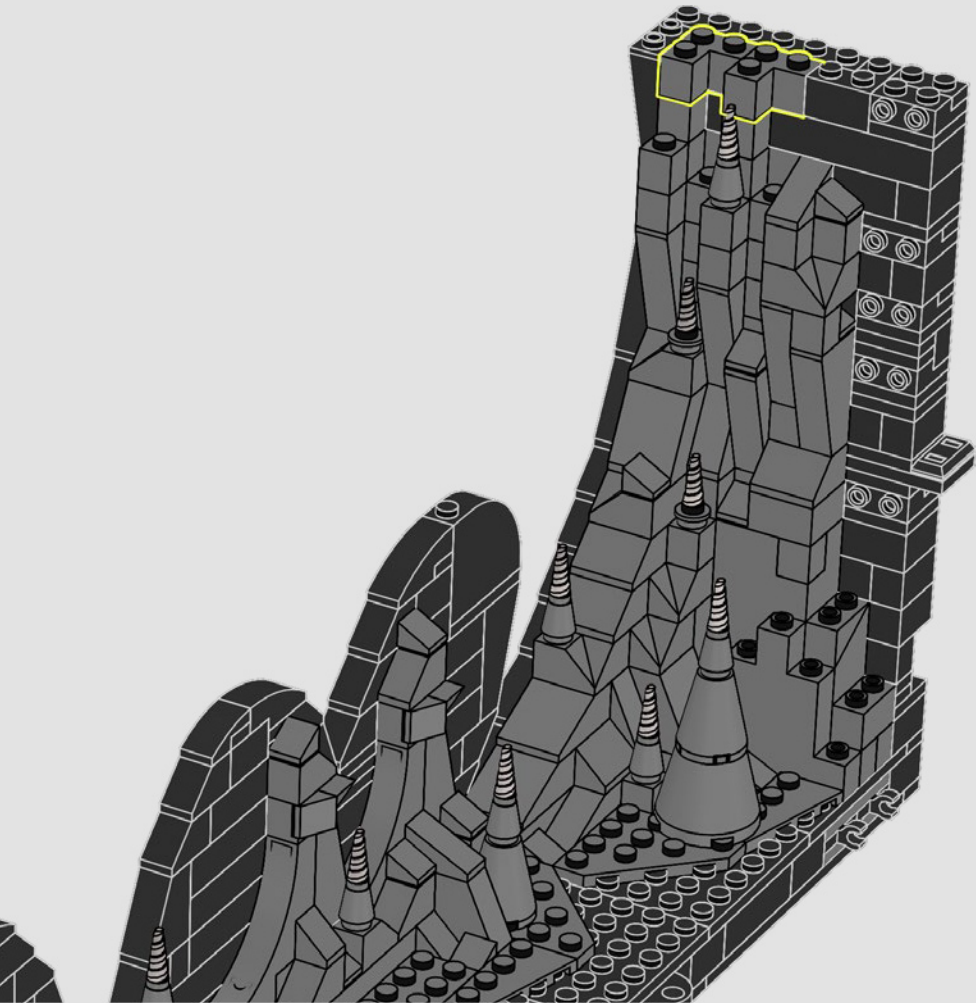

934

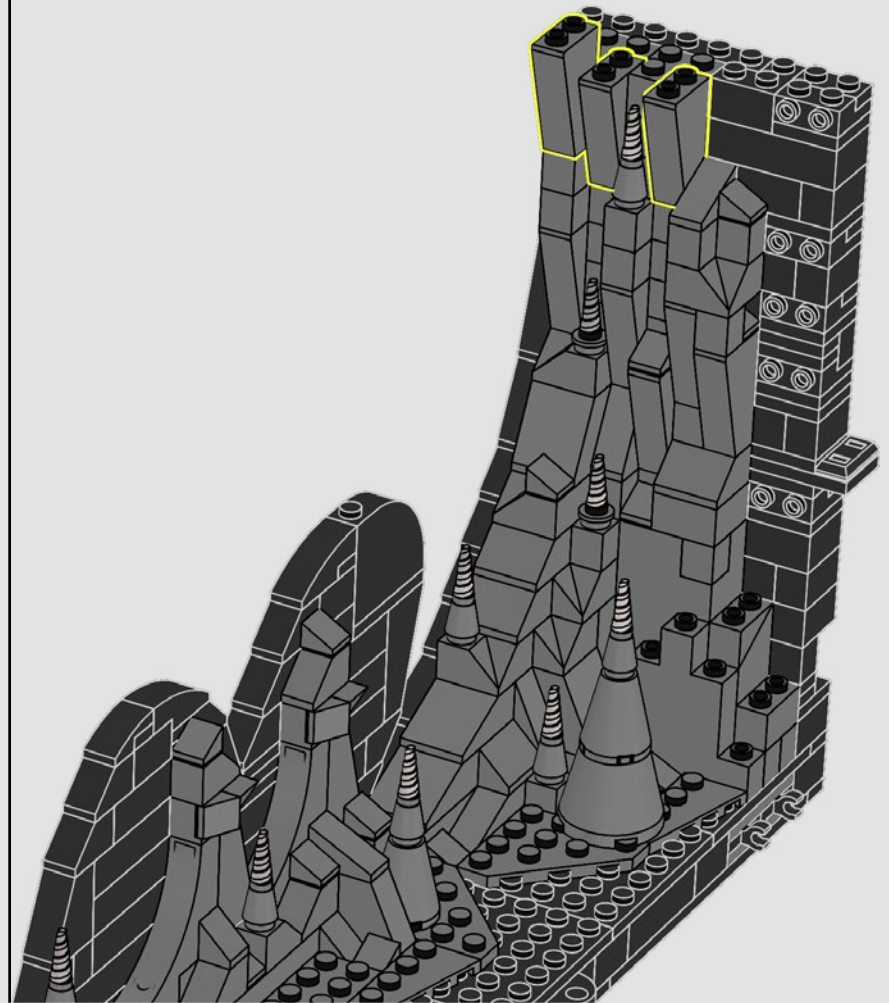

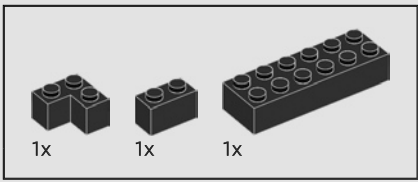

935

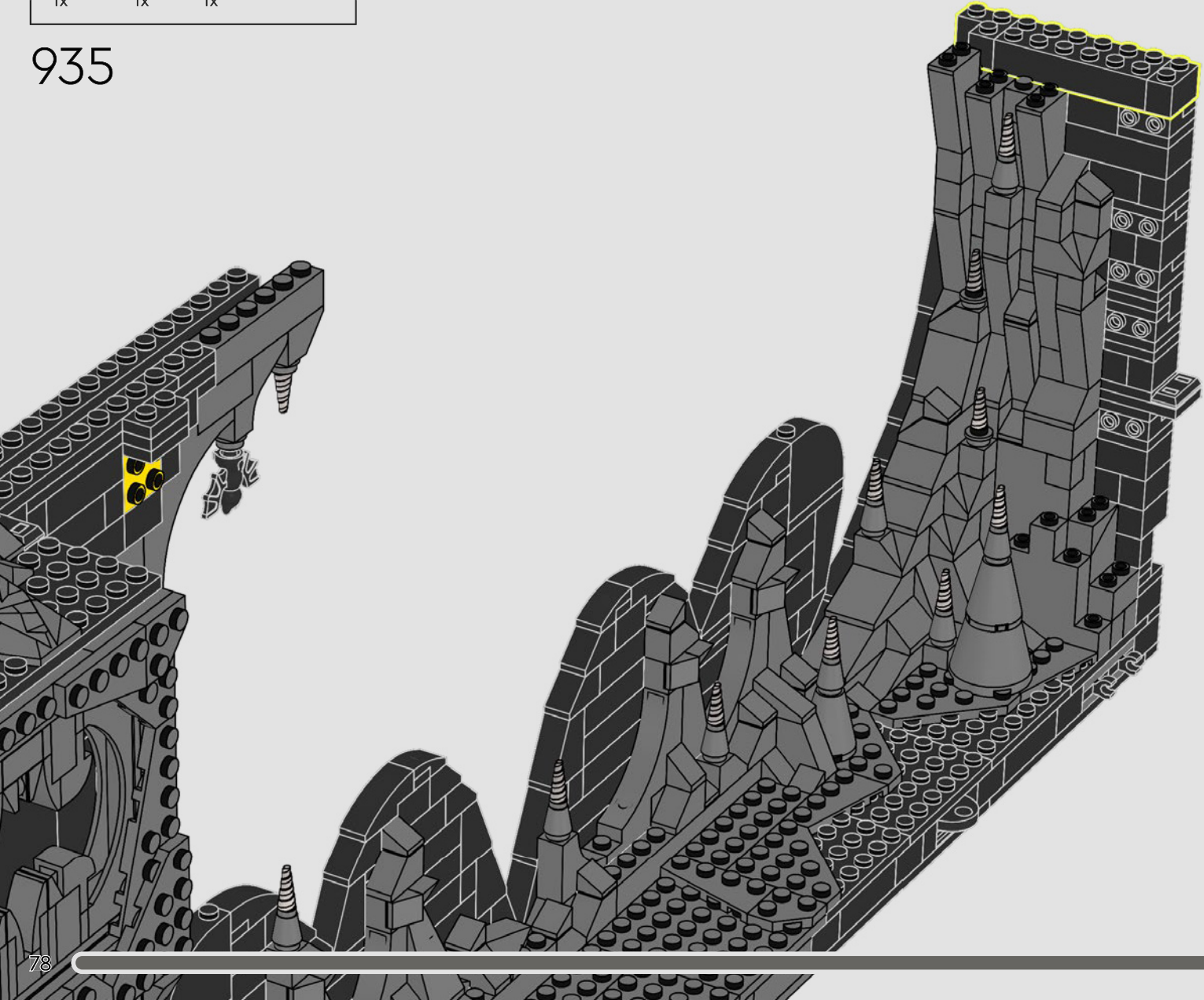



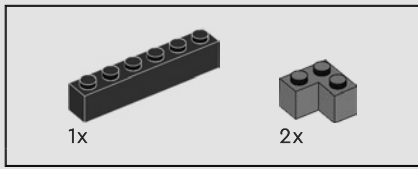

936

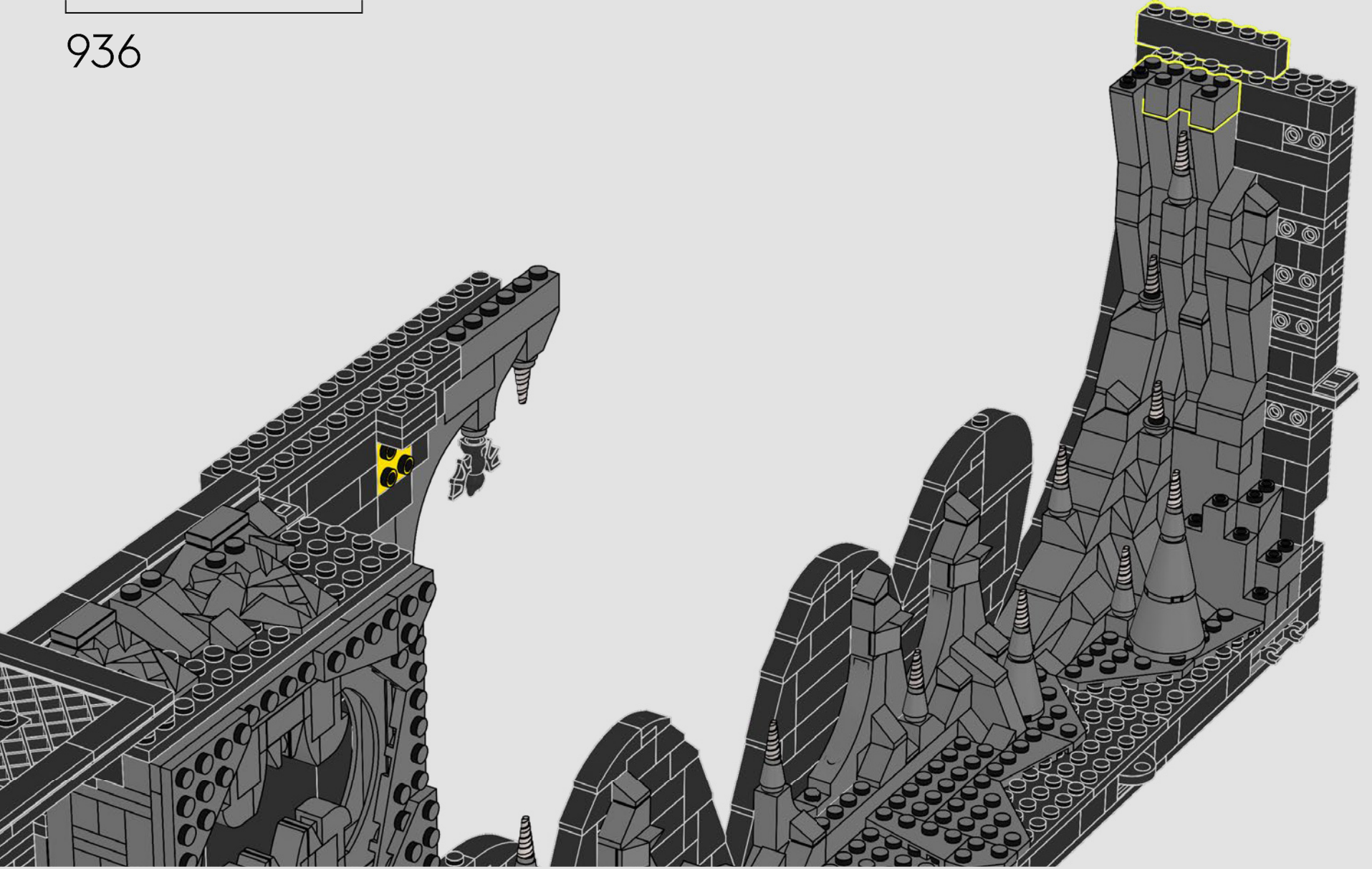

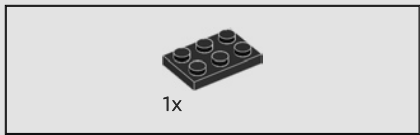

937

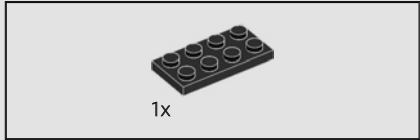
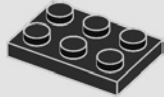

938

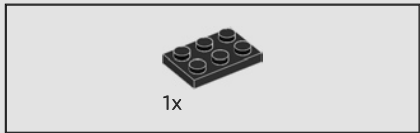
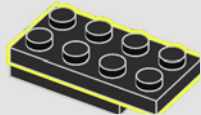

939

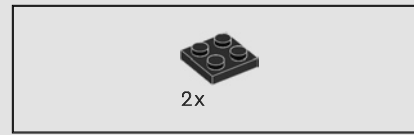
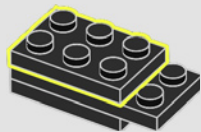

940

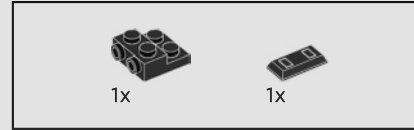
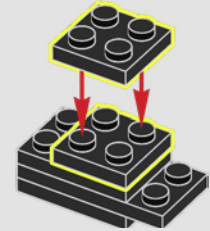

941

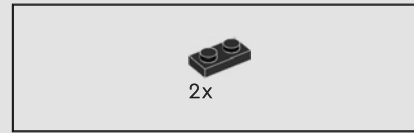
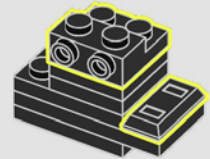

942

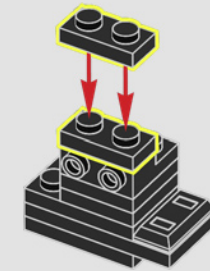

943

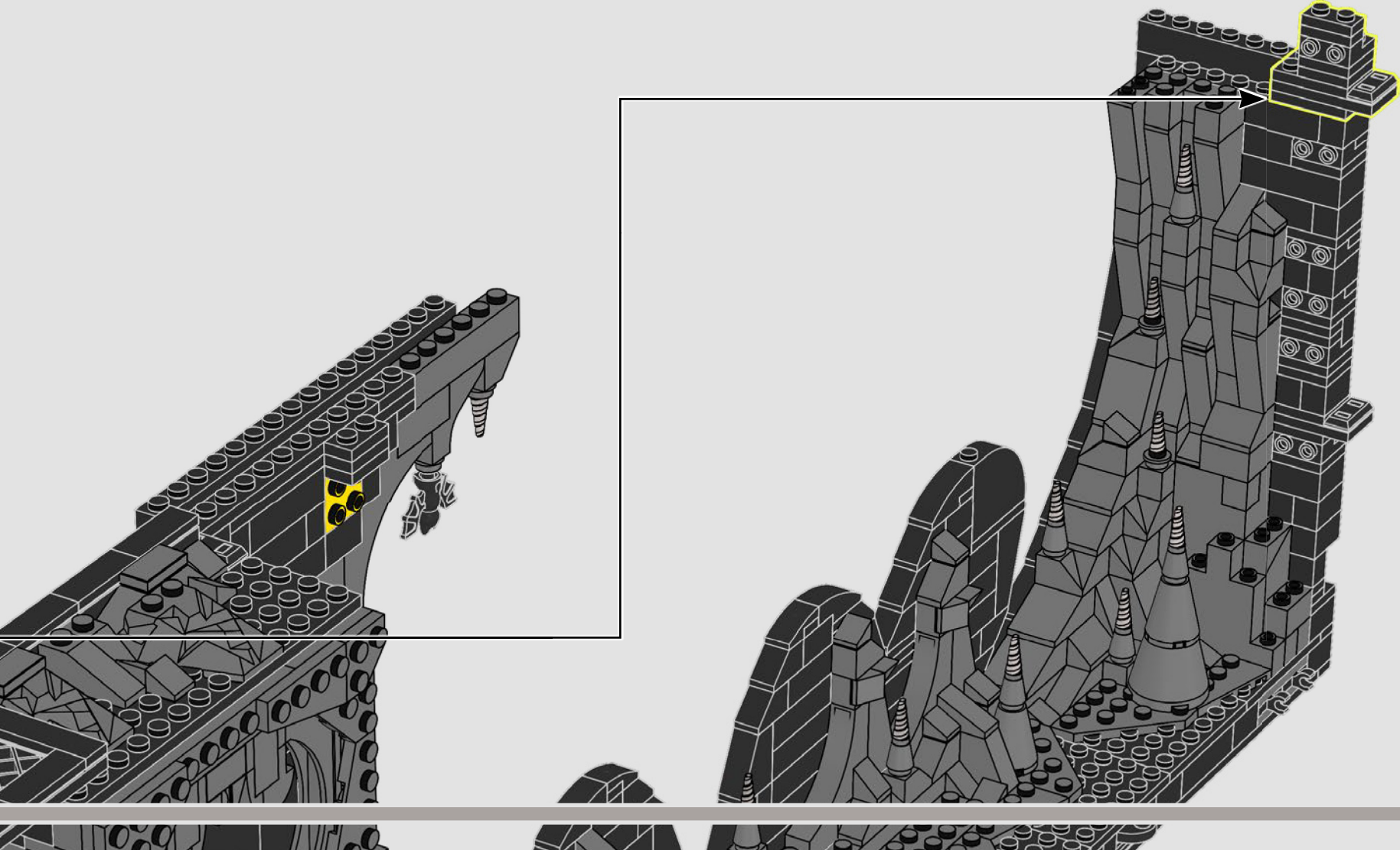



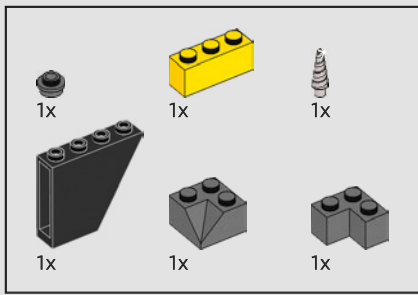

944

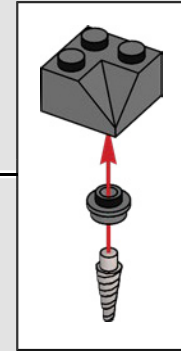
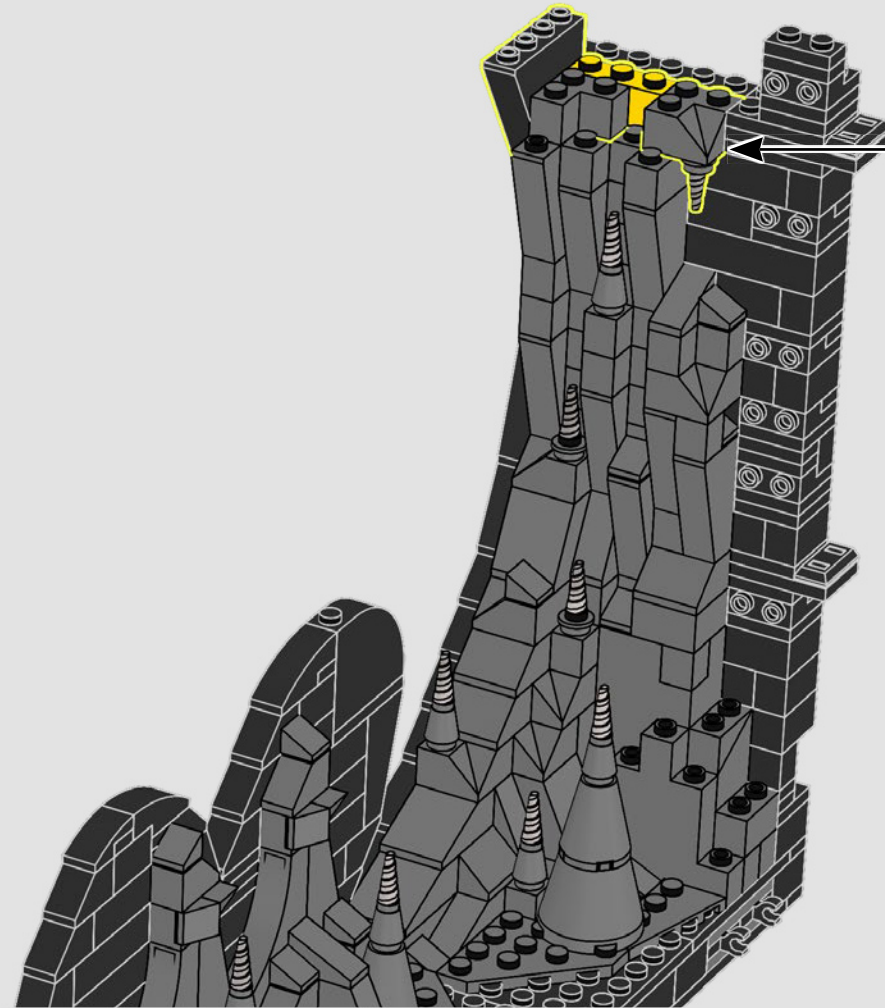
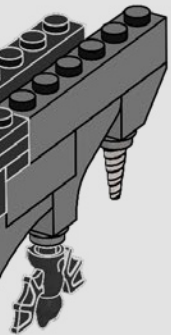

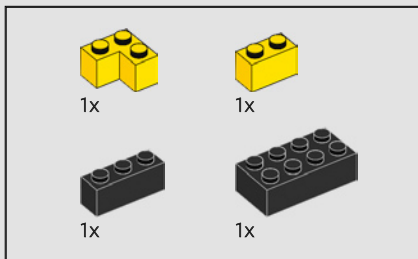

945

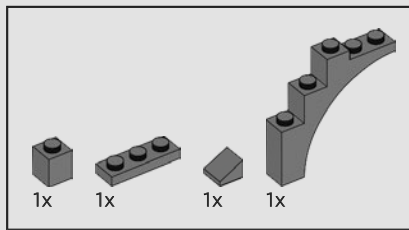
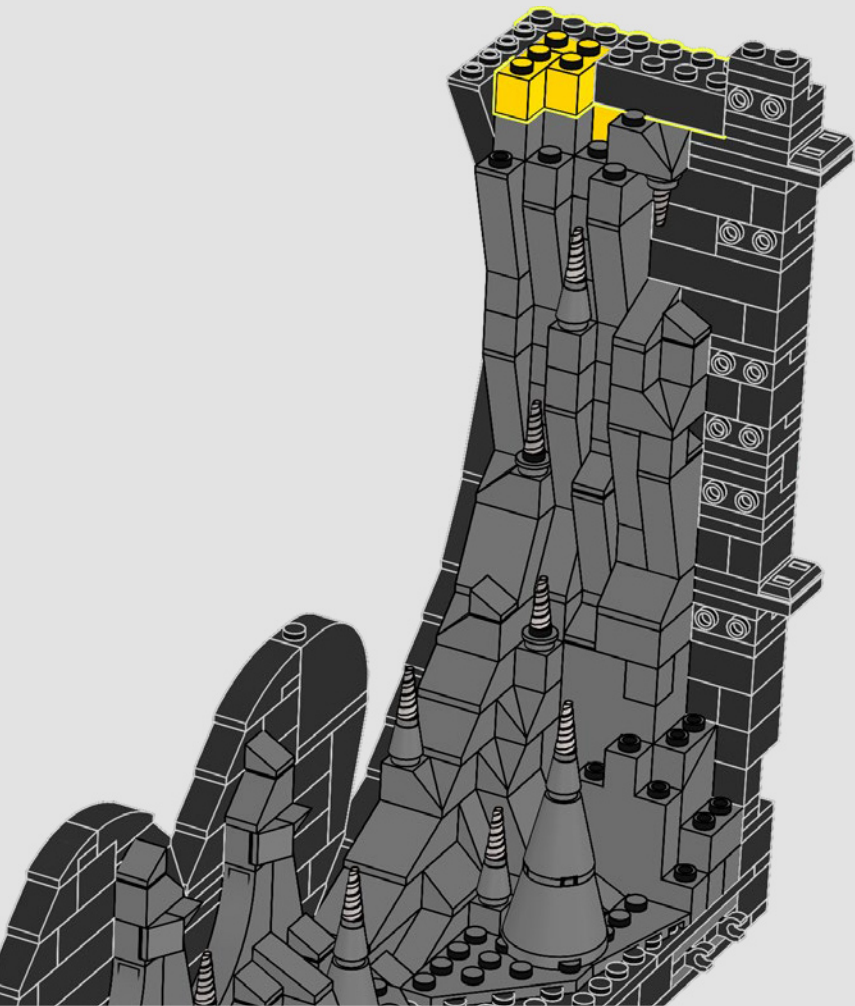

946

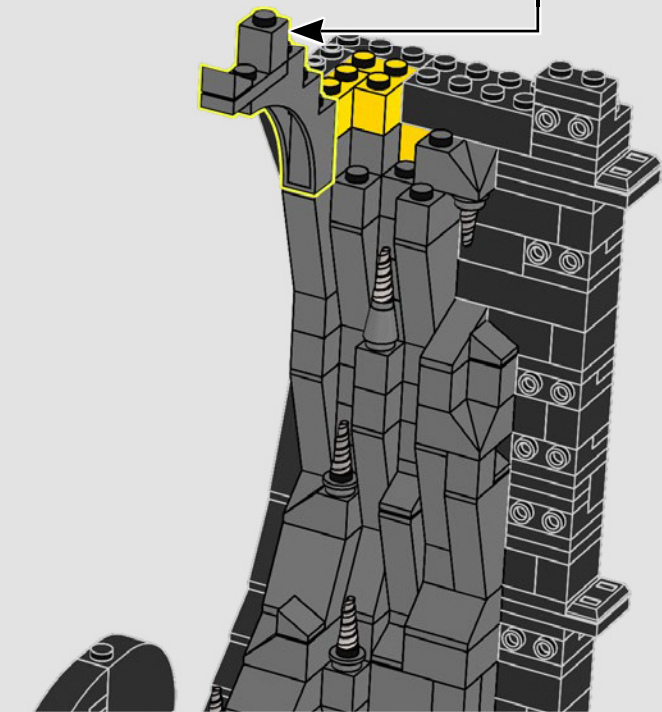
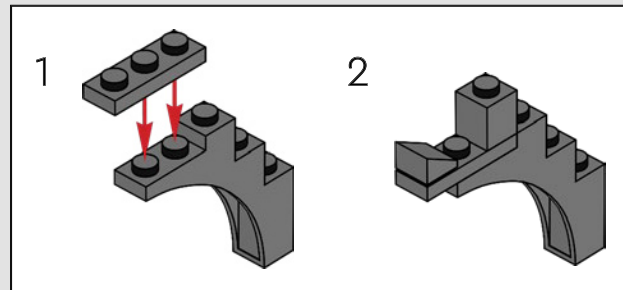

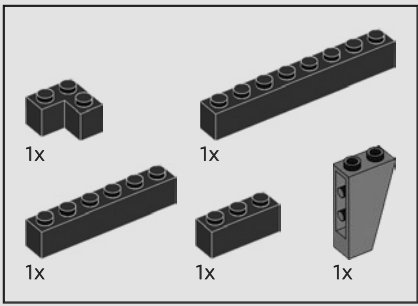

947





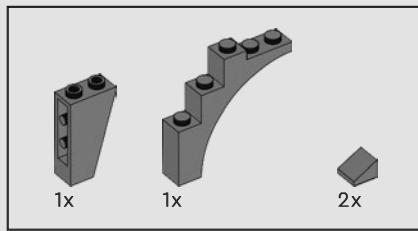

948

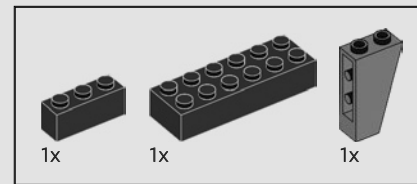
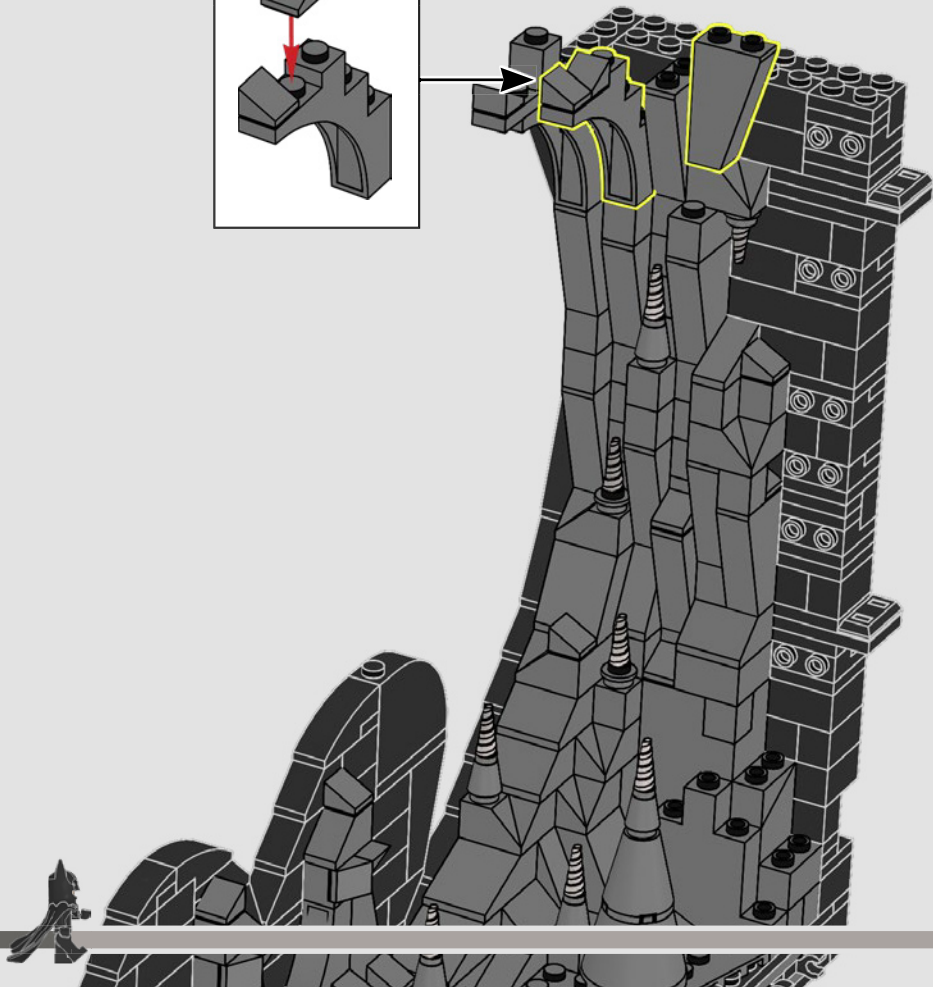
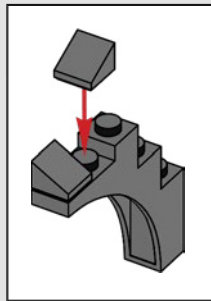

949

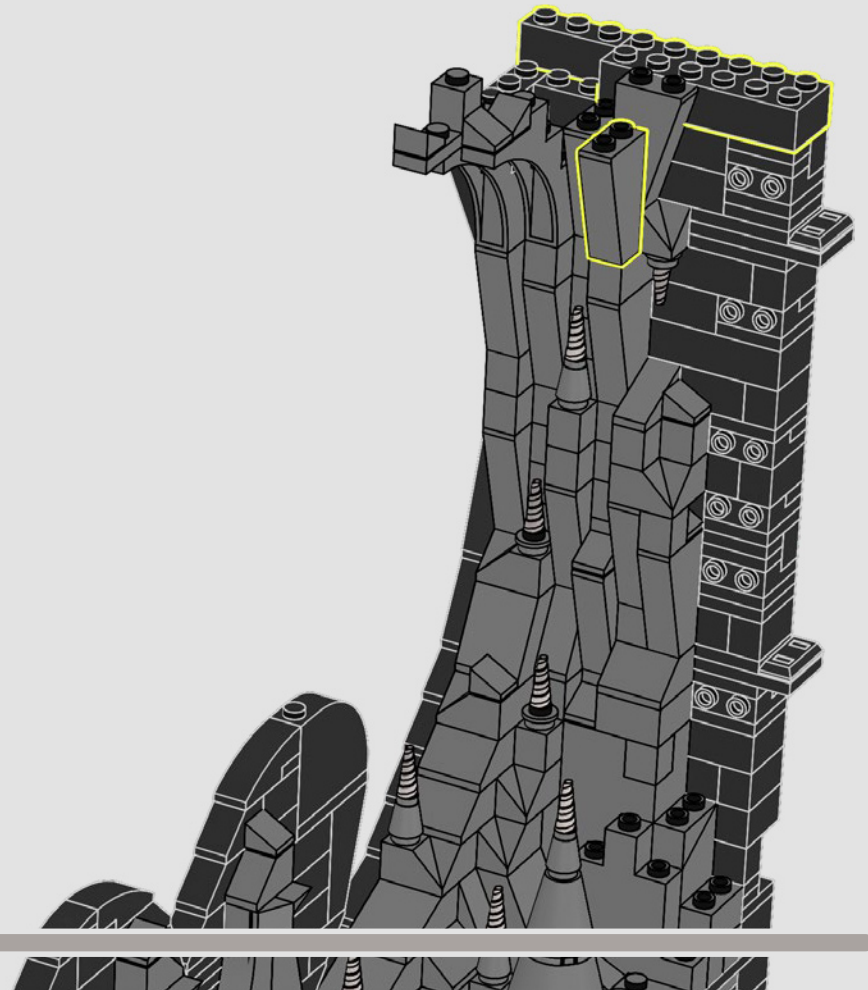

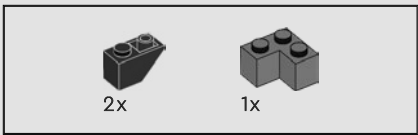

950

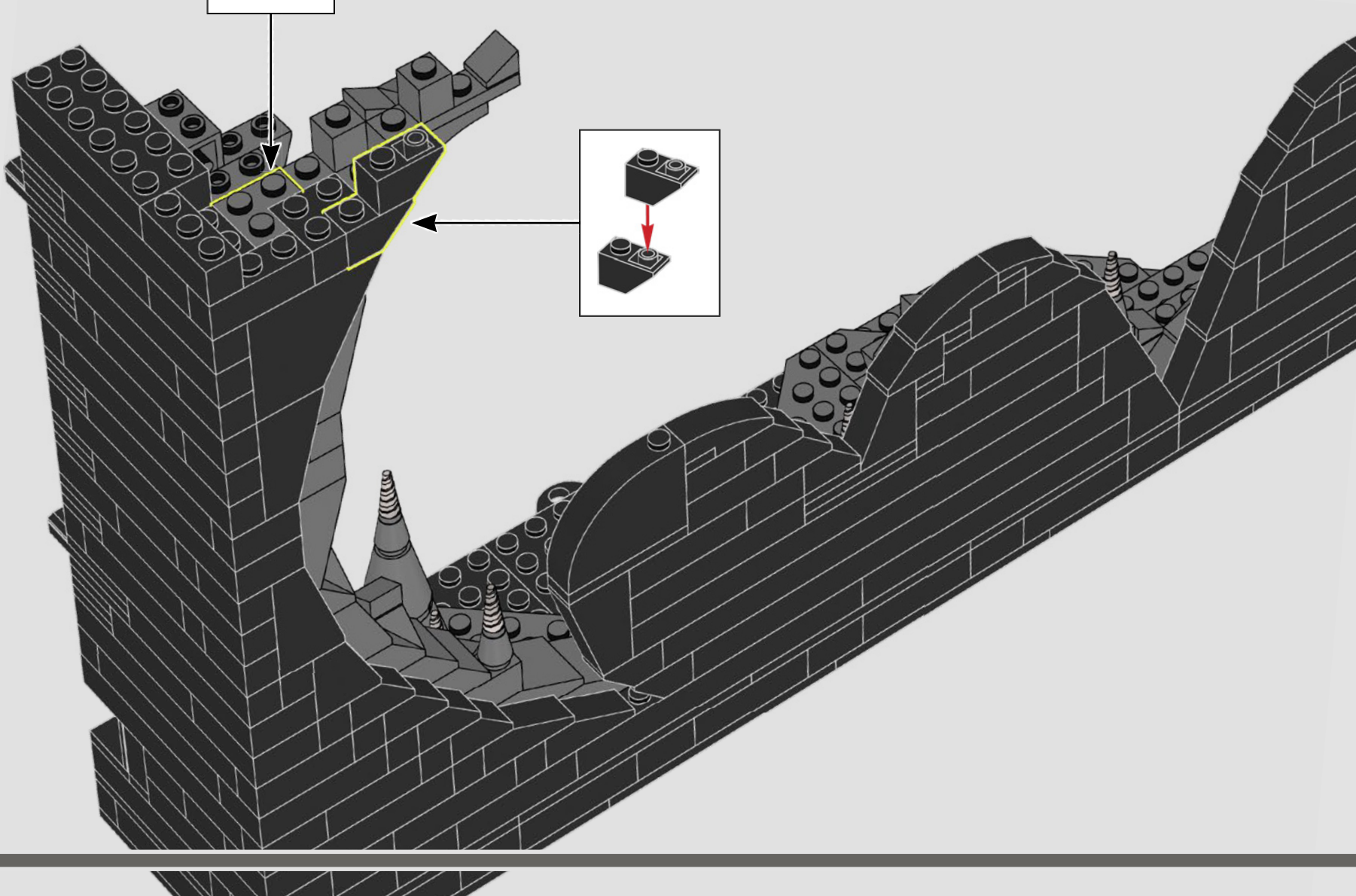
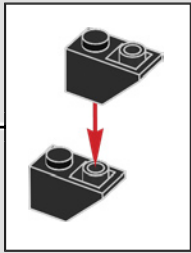
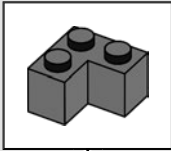

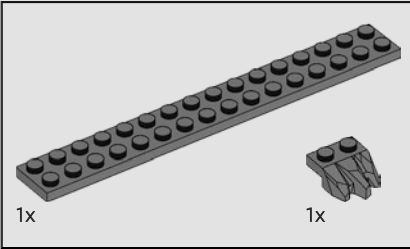
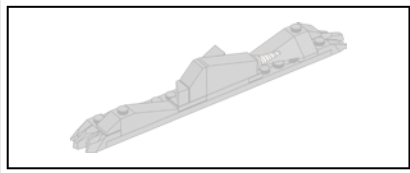

951

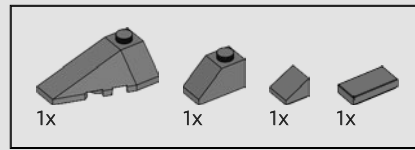
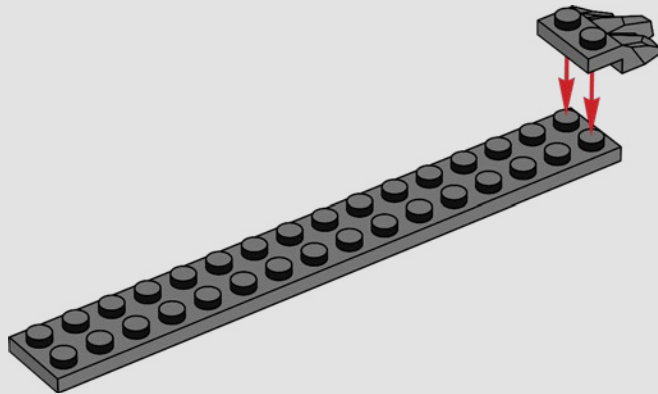

952

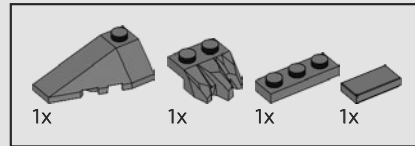
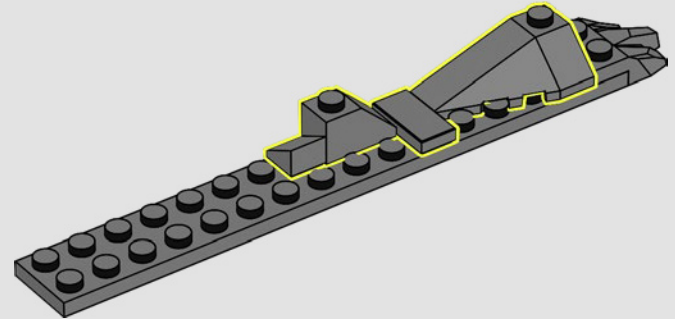

953

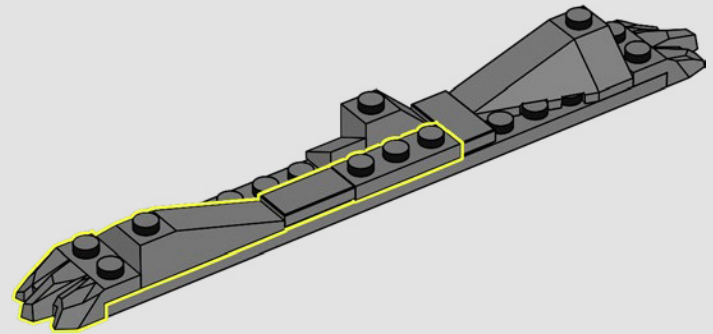





3x

954

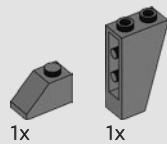
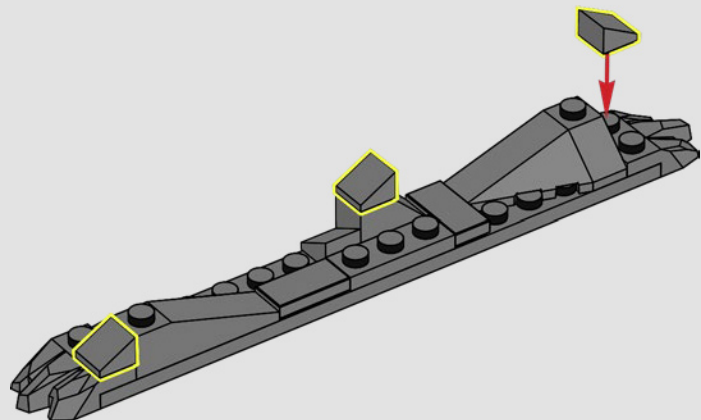

1x

1x

1x

1x

1x

955

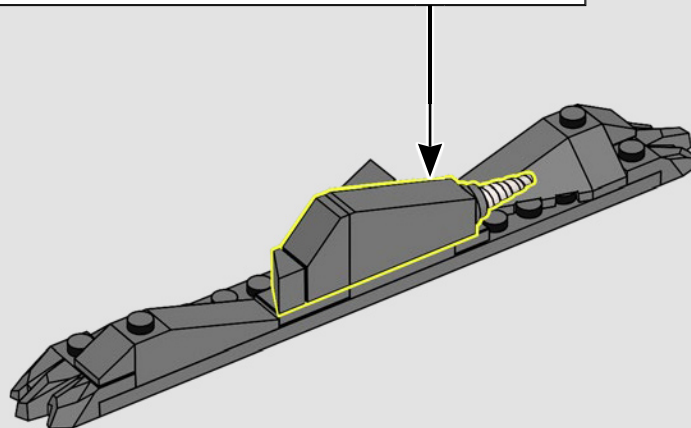
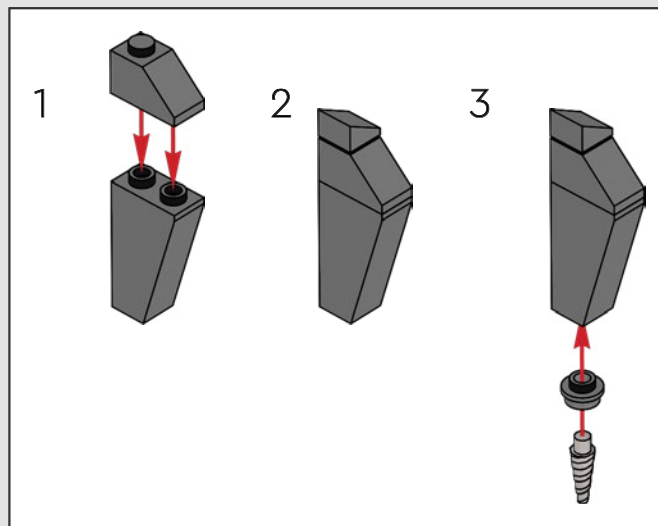

956

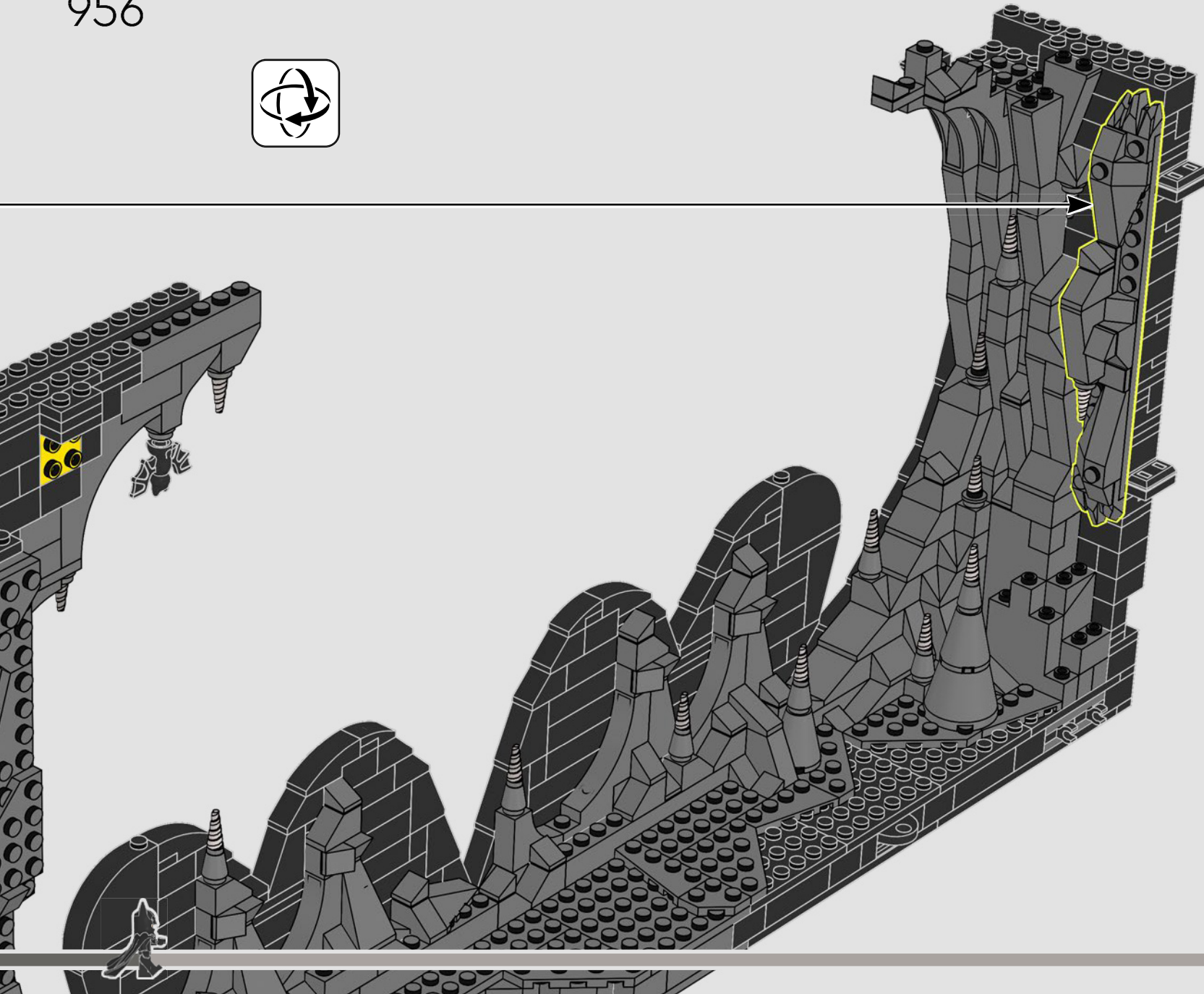

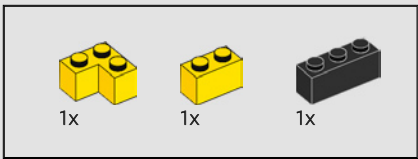

957

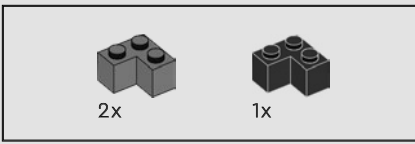
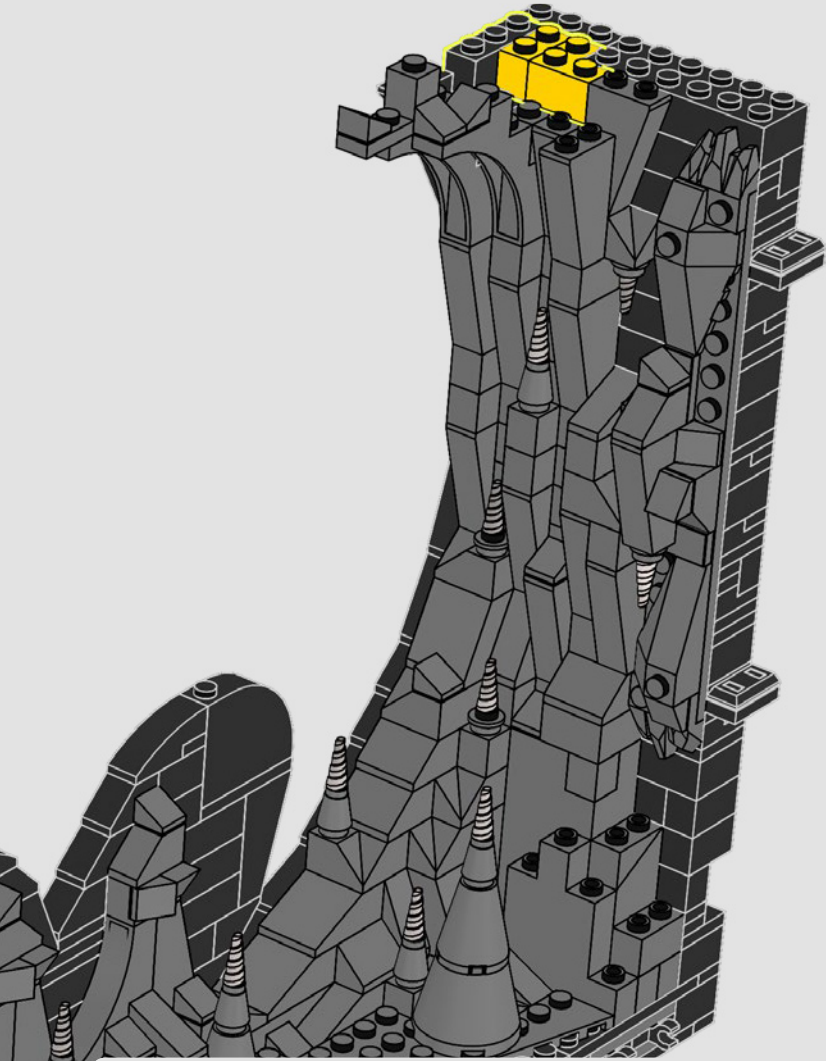

958

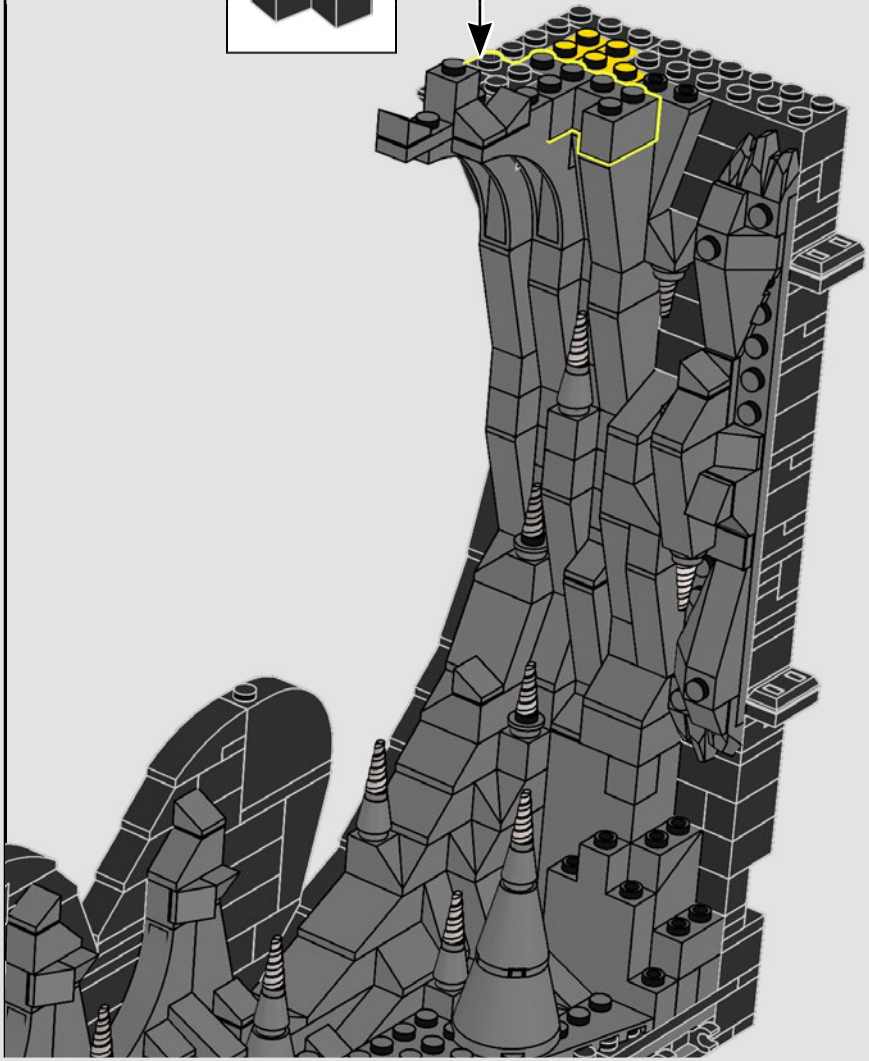
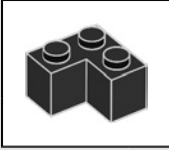



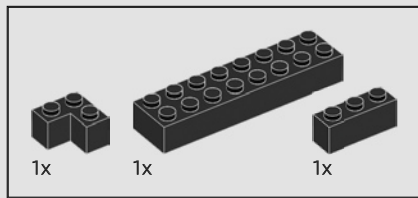

959

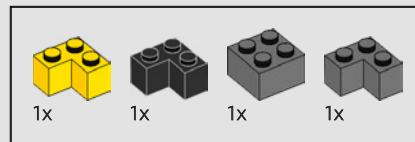
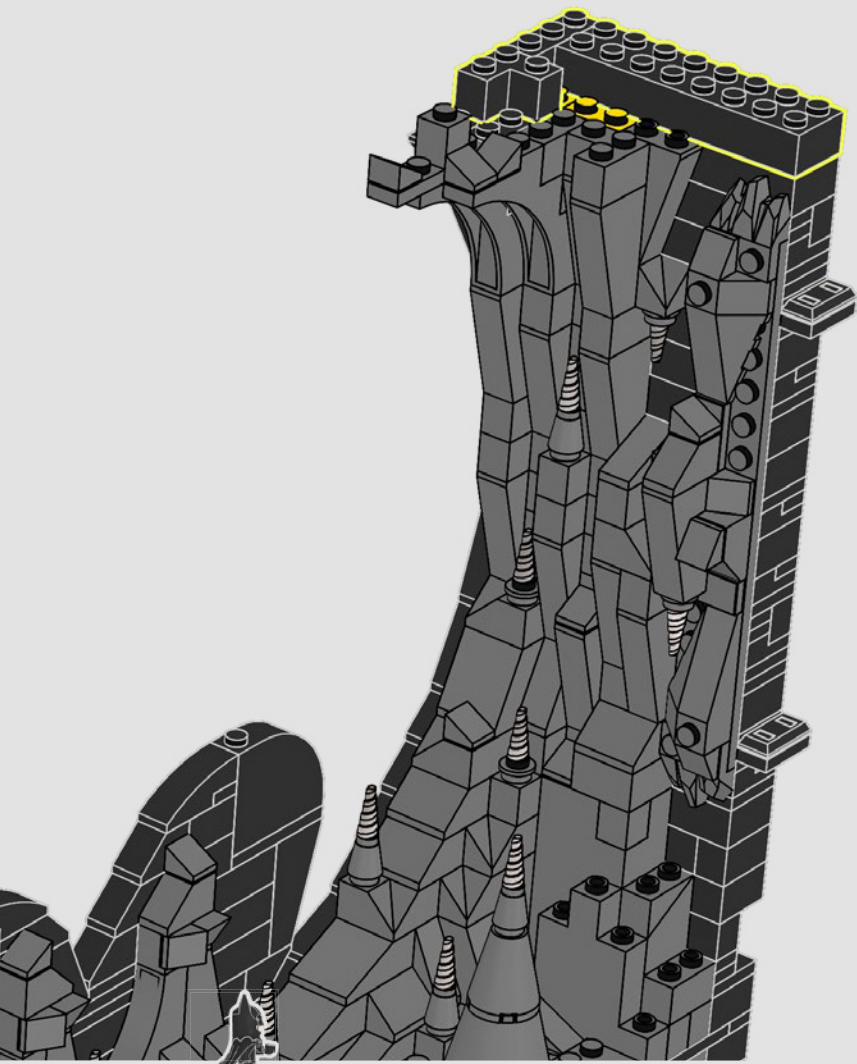

960

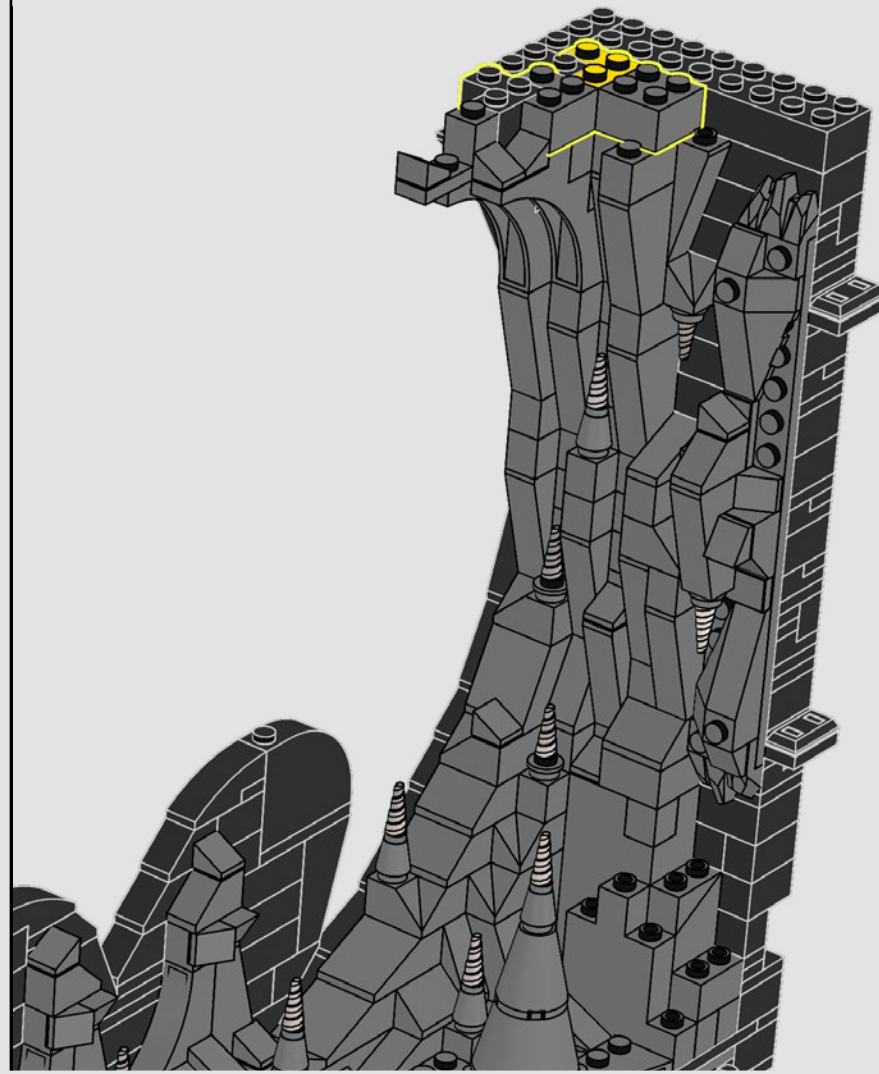

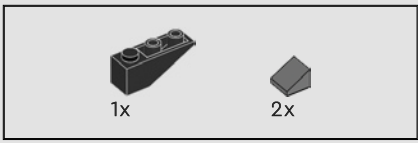

961

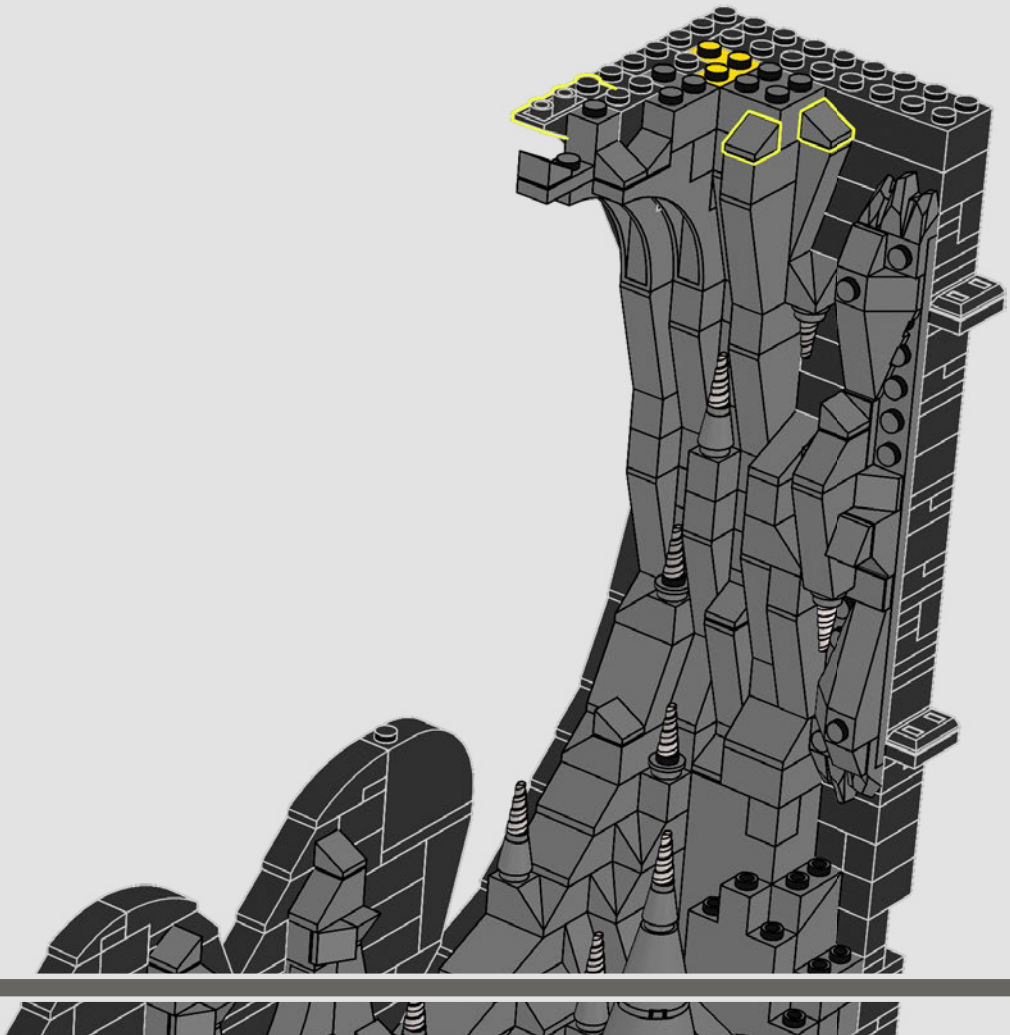

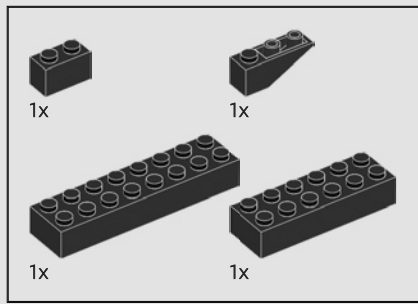

962

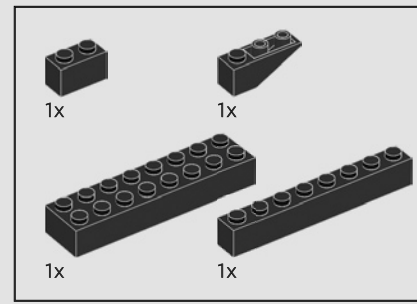
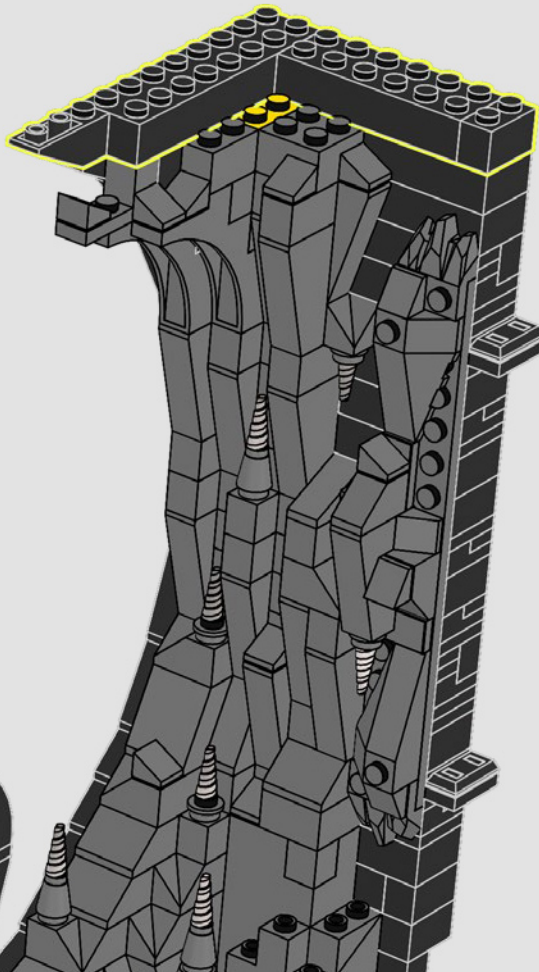

963

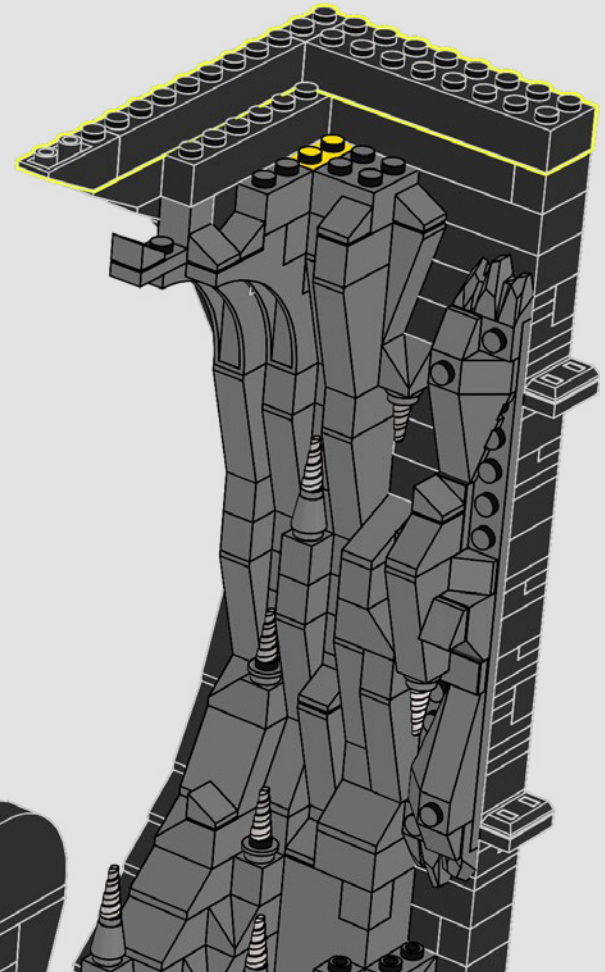



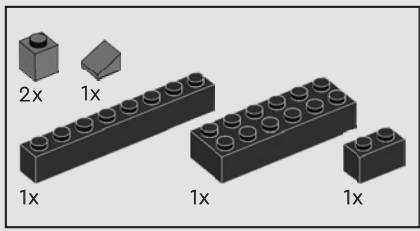

964

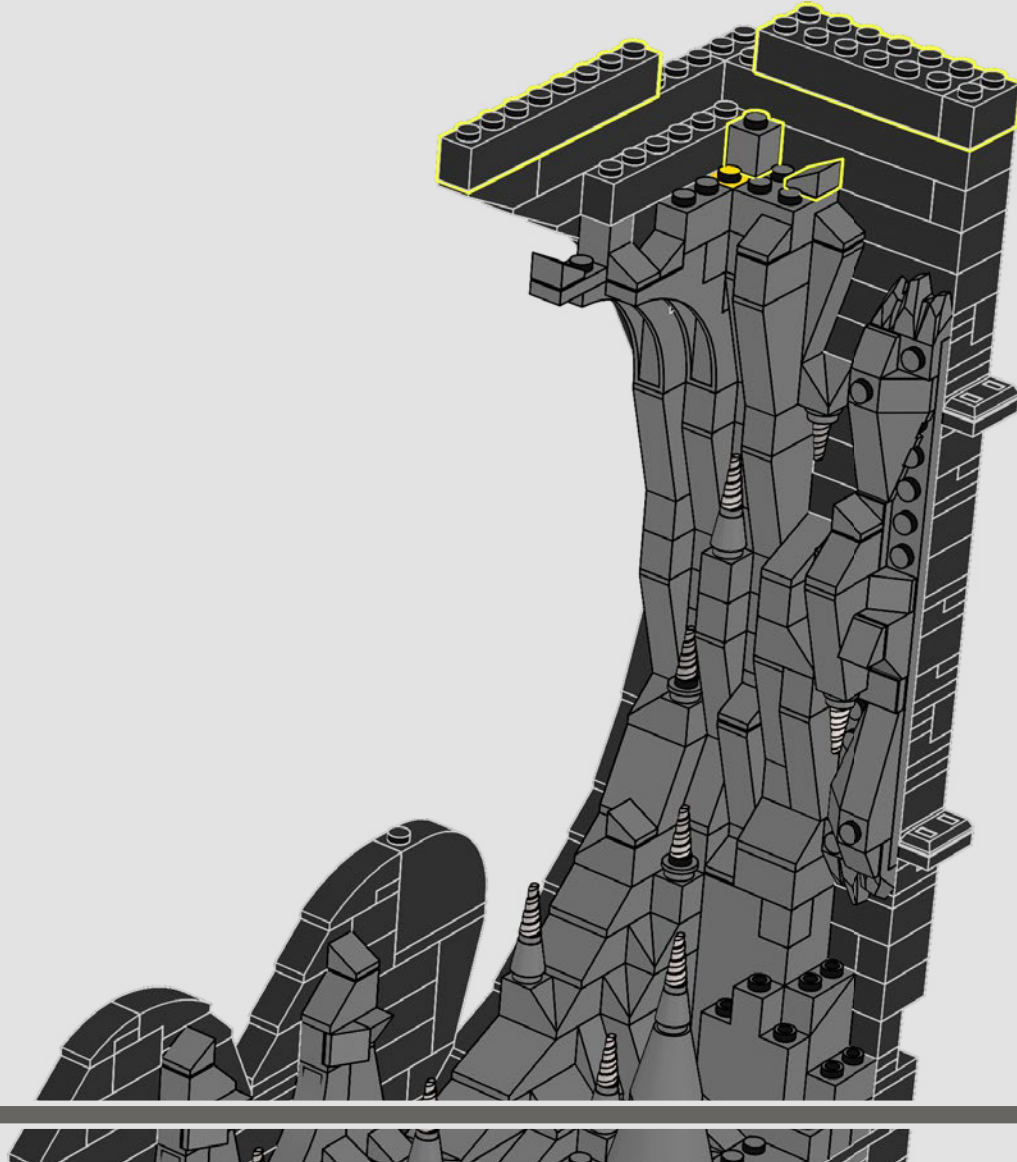

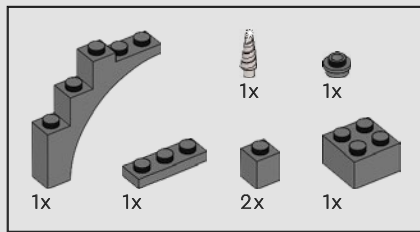

965

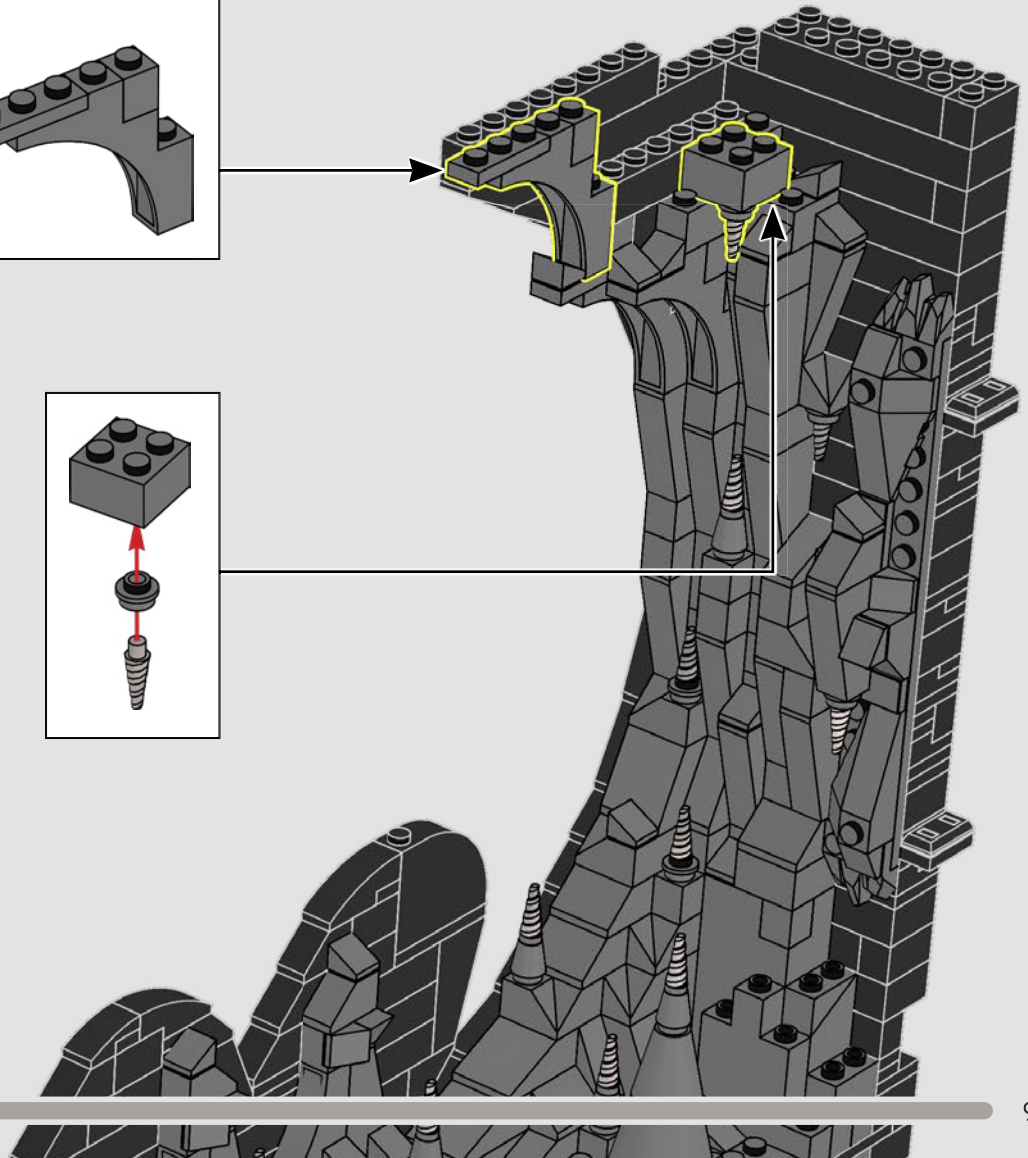
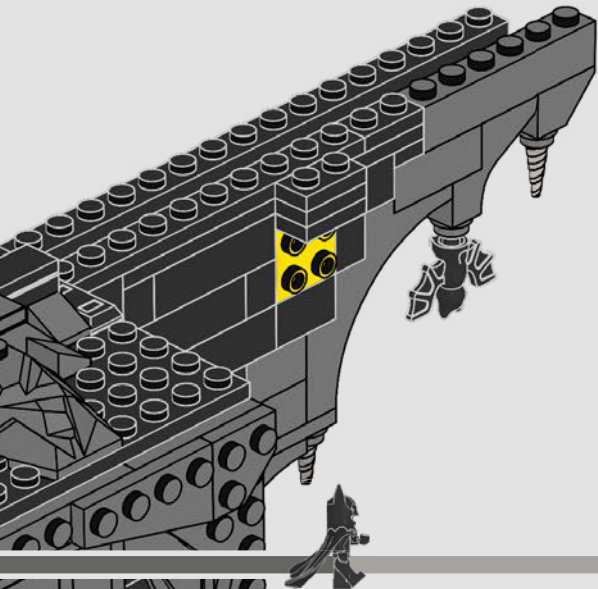
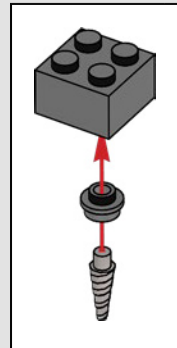
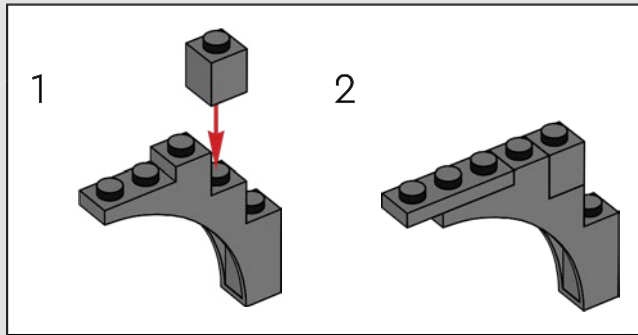

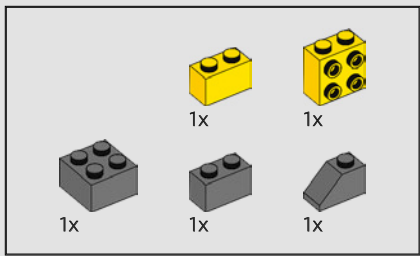

966

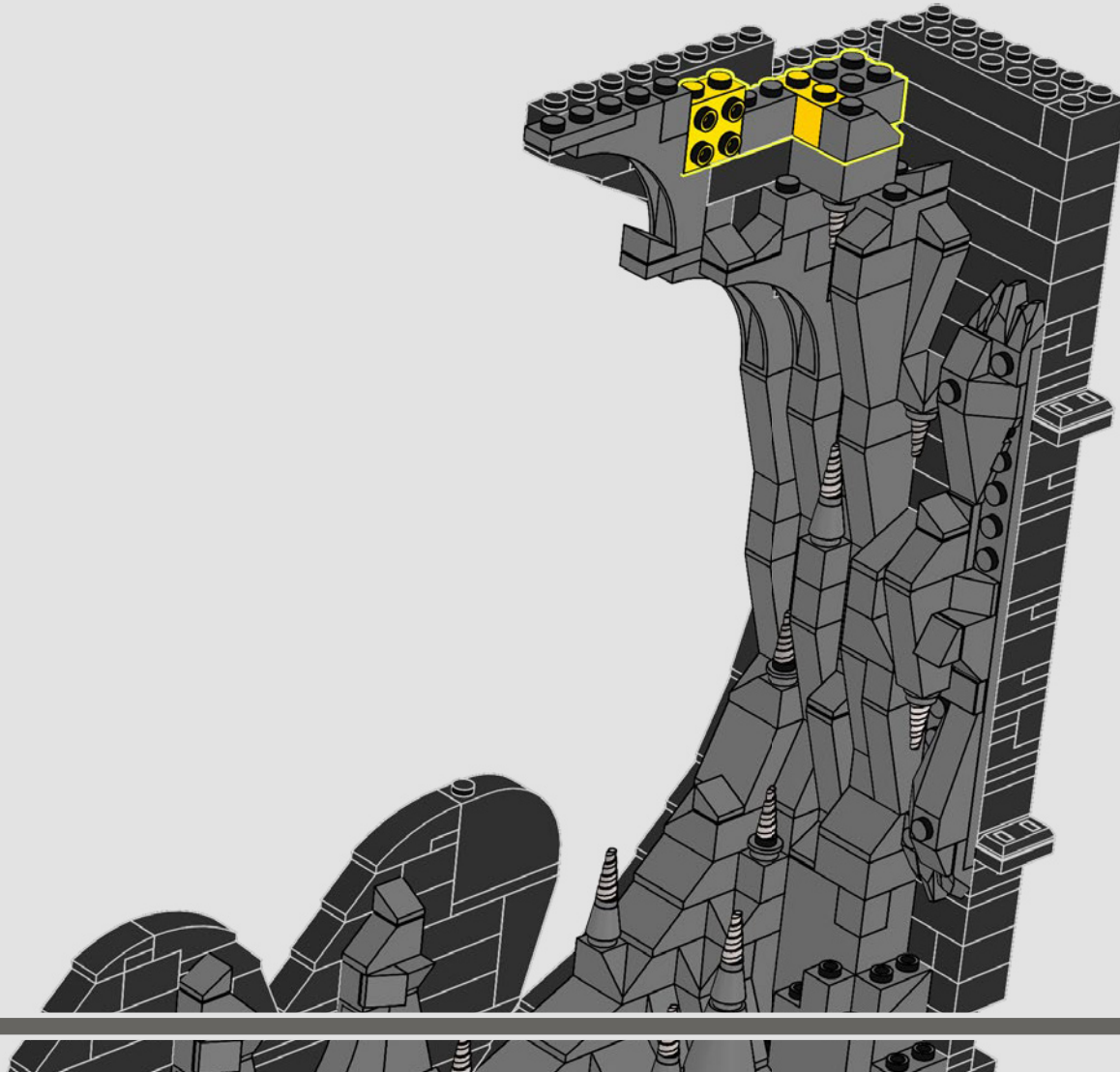





967

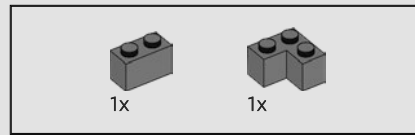
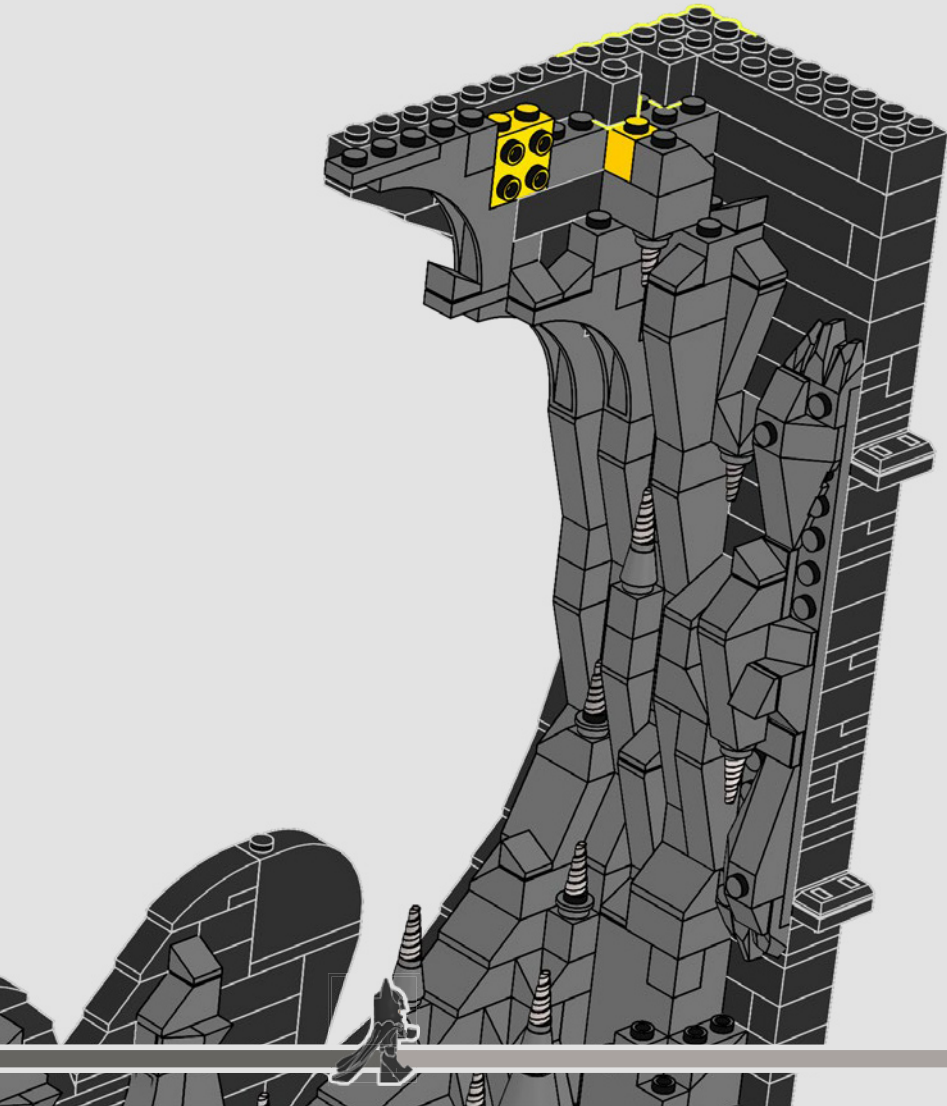

968

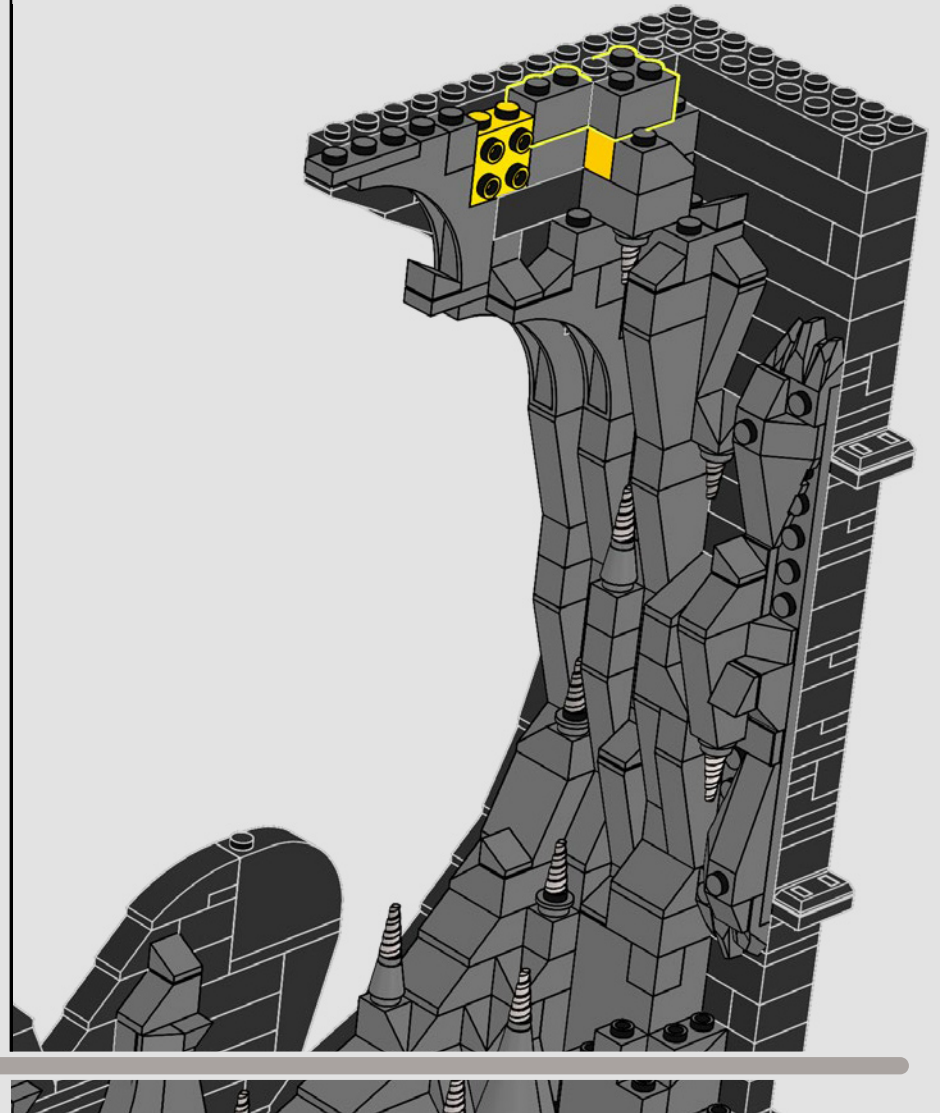

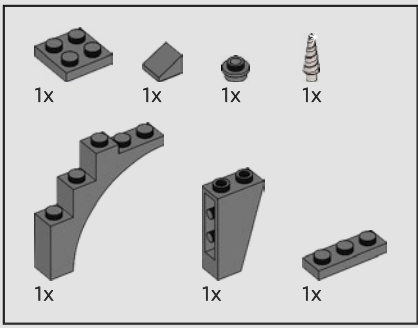

969

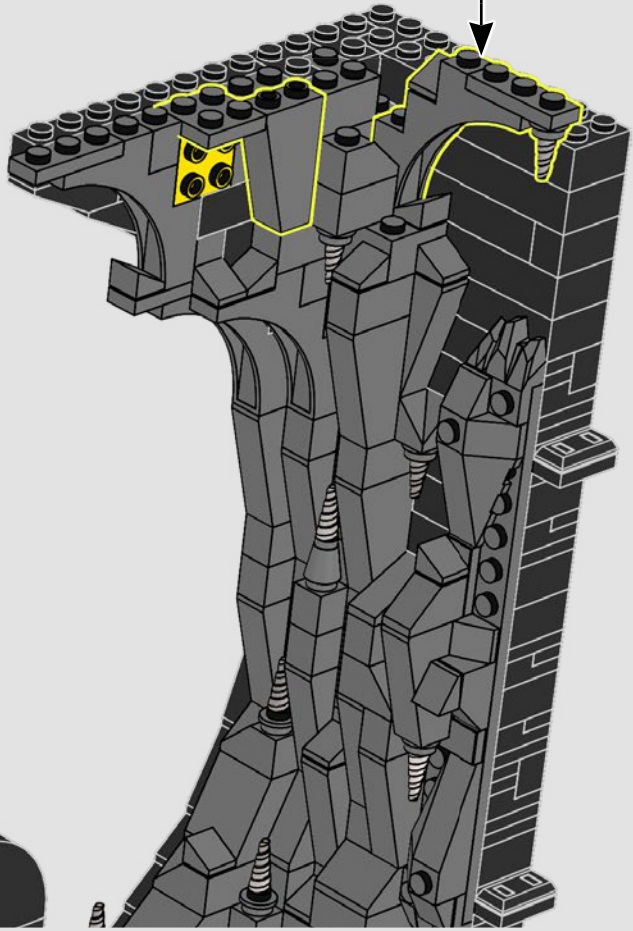
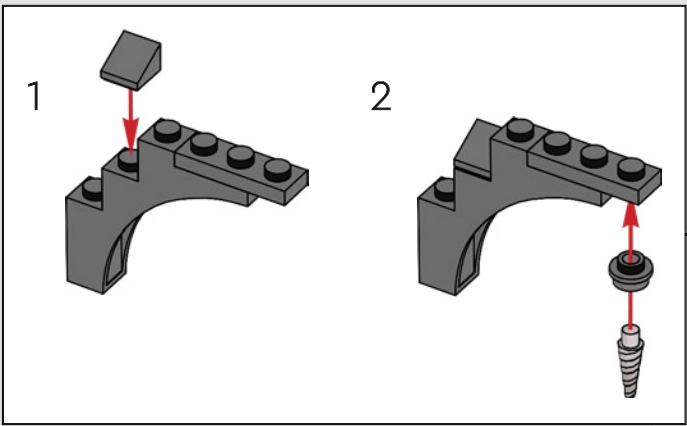

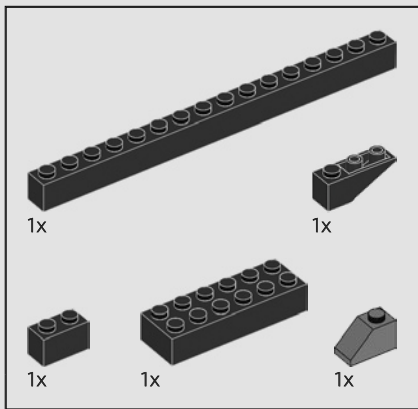

970

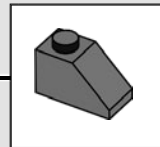
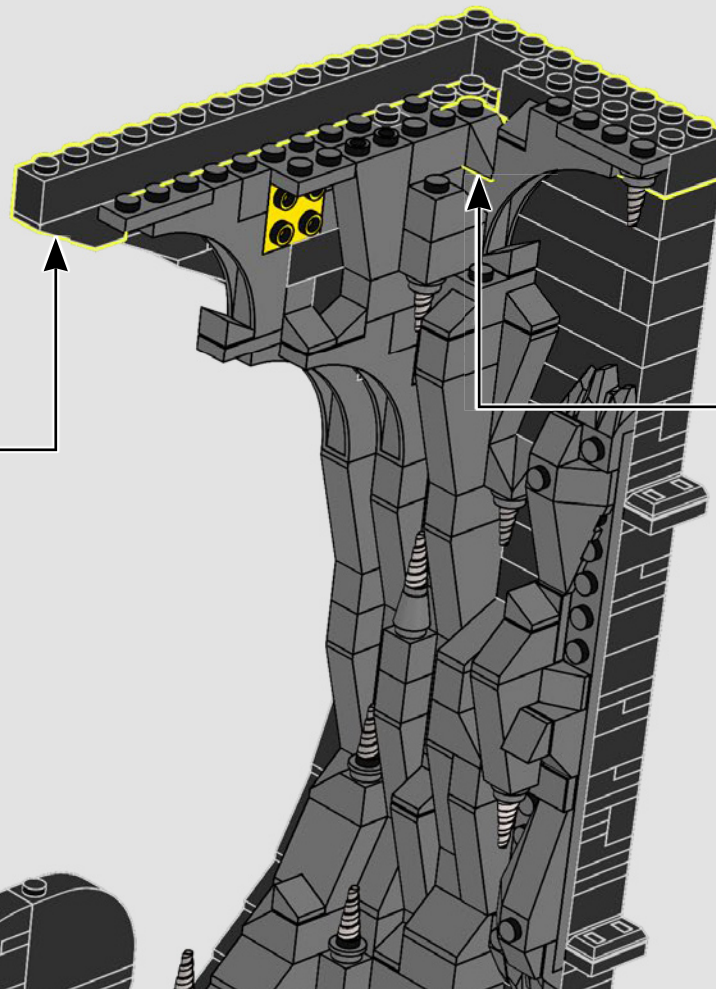
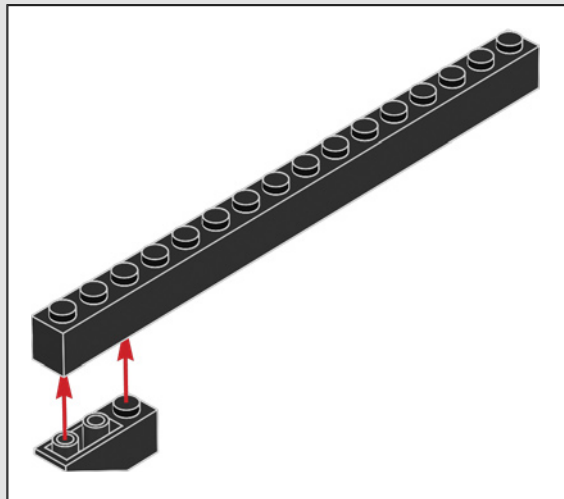



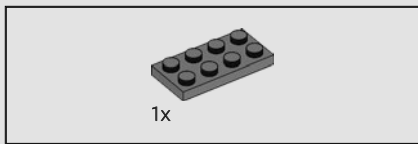

971

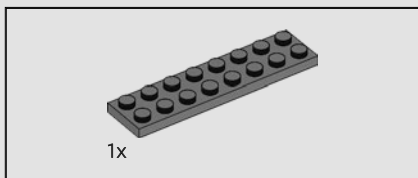
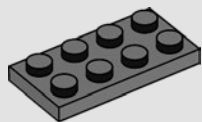

972

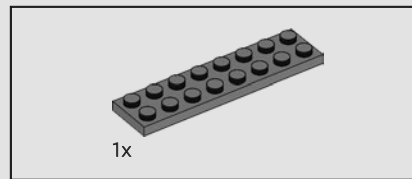
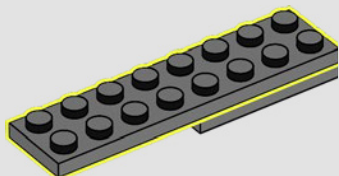

973

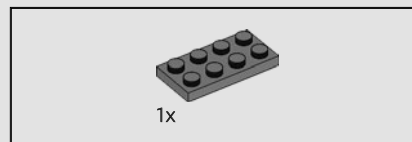
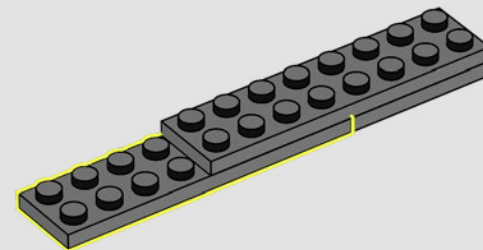

974

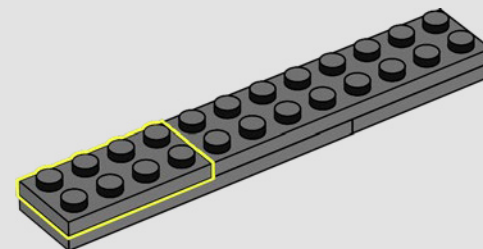

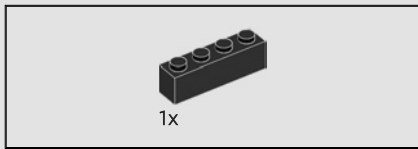

975

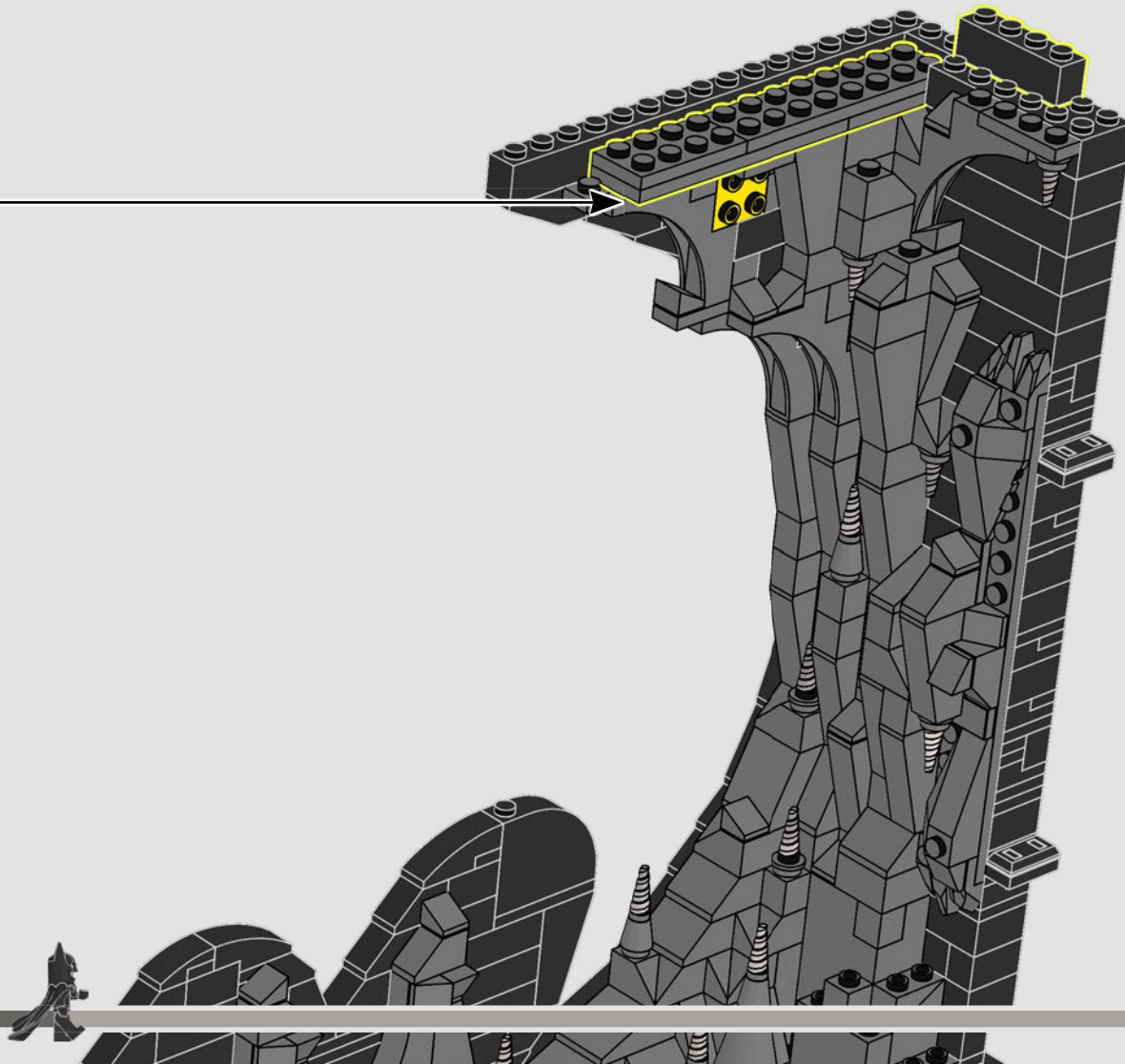



976

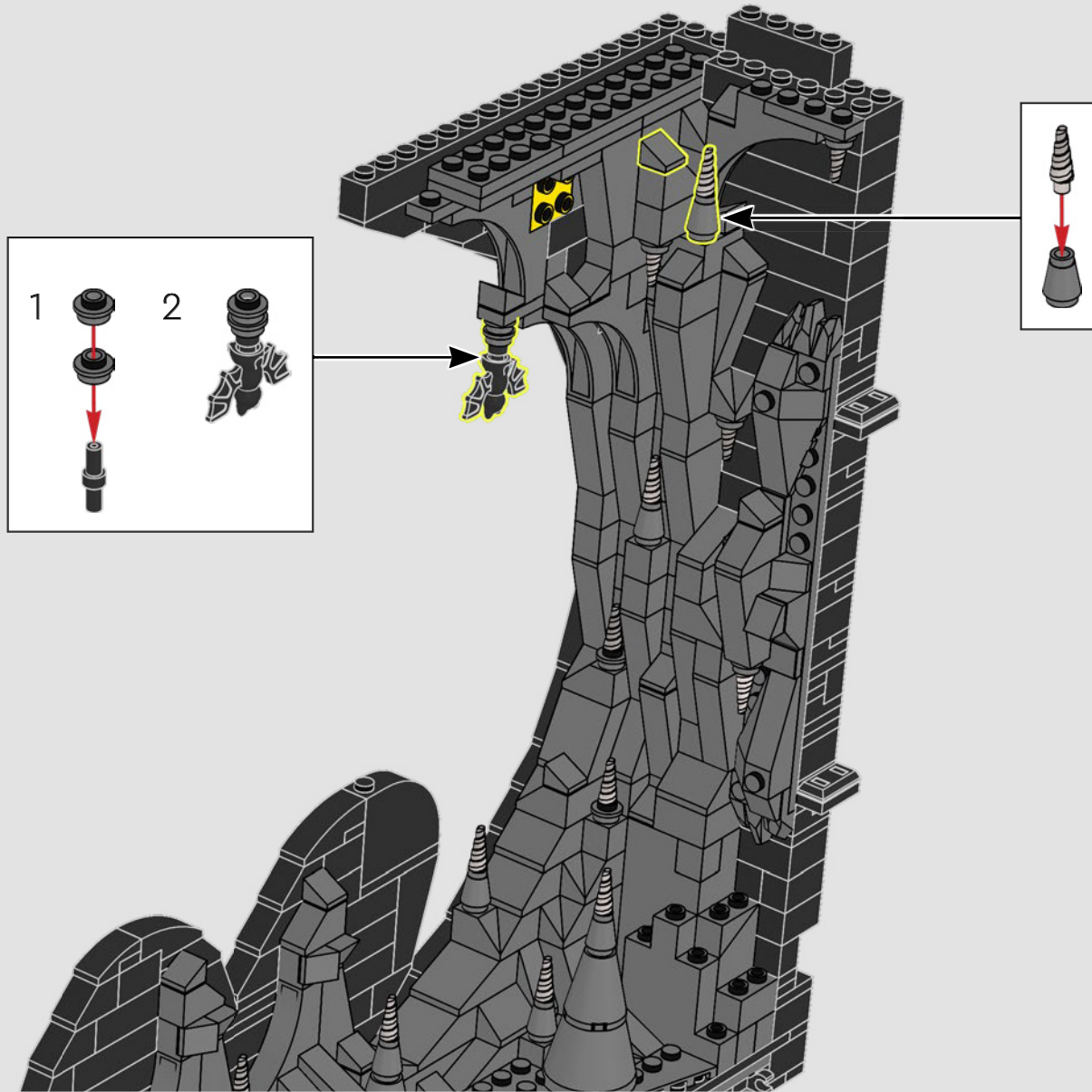



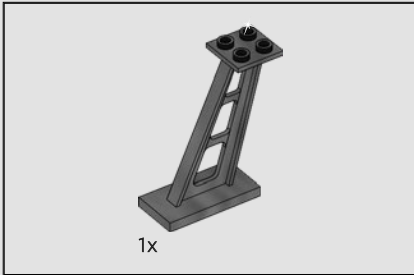

977

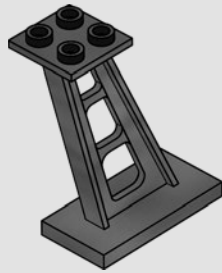

978

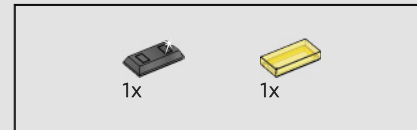
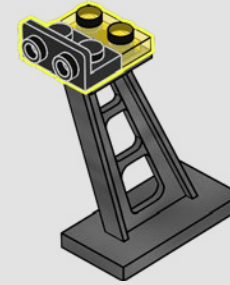

979



2x



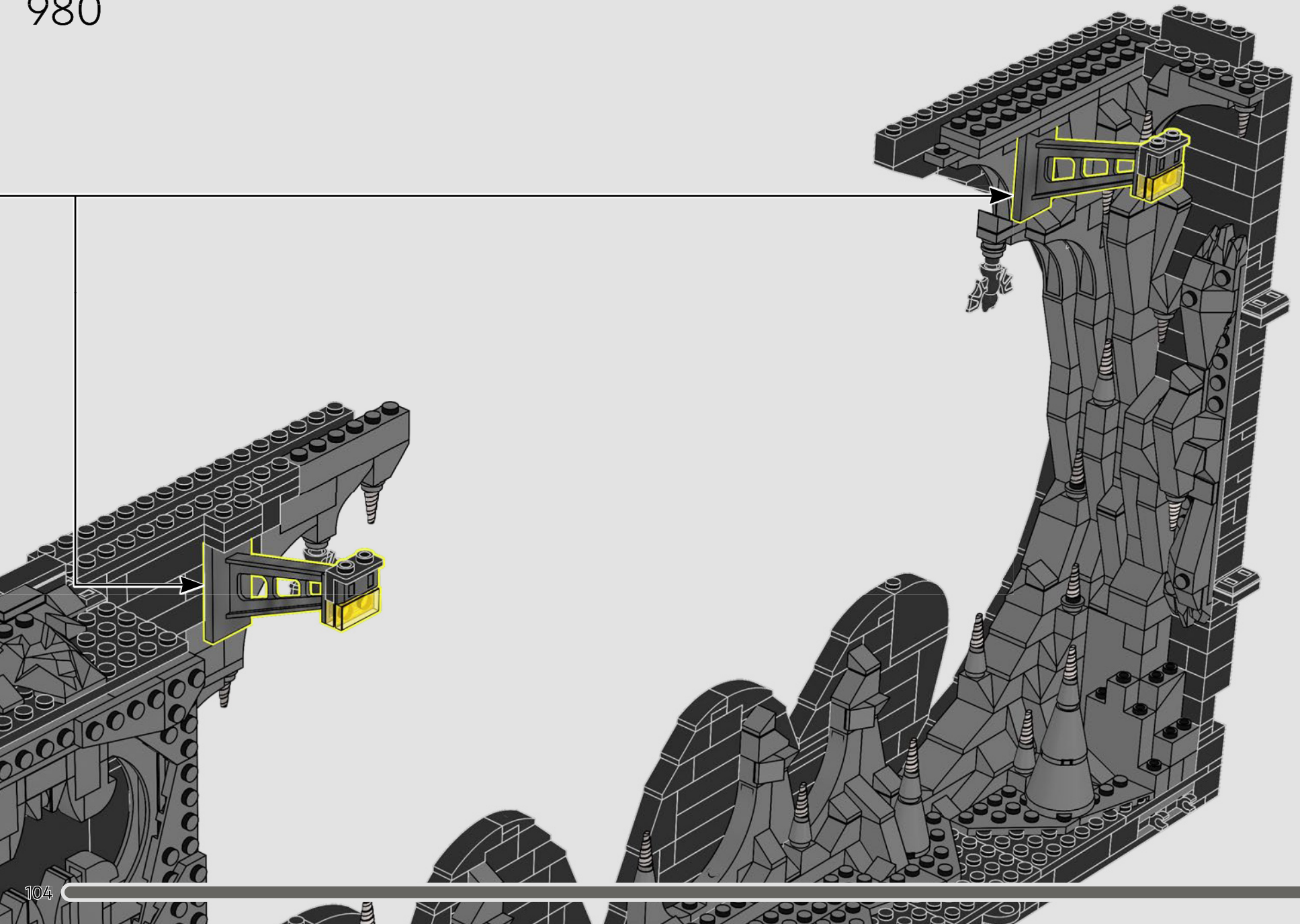

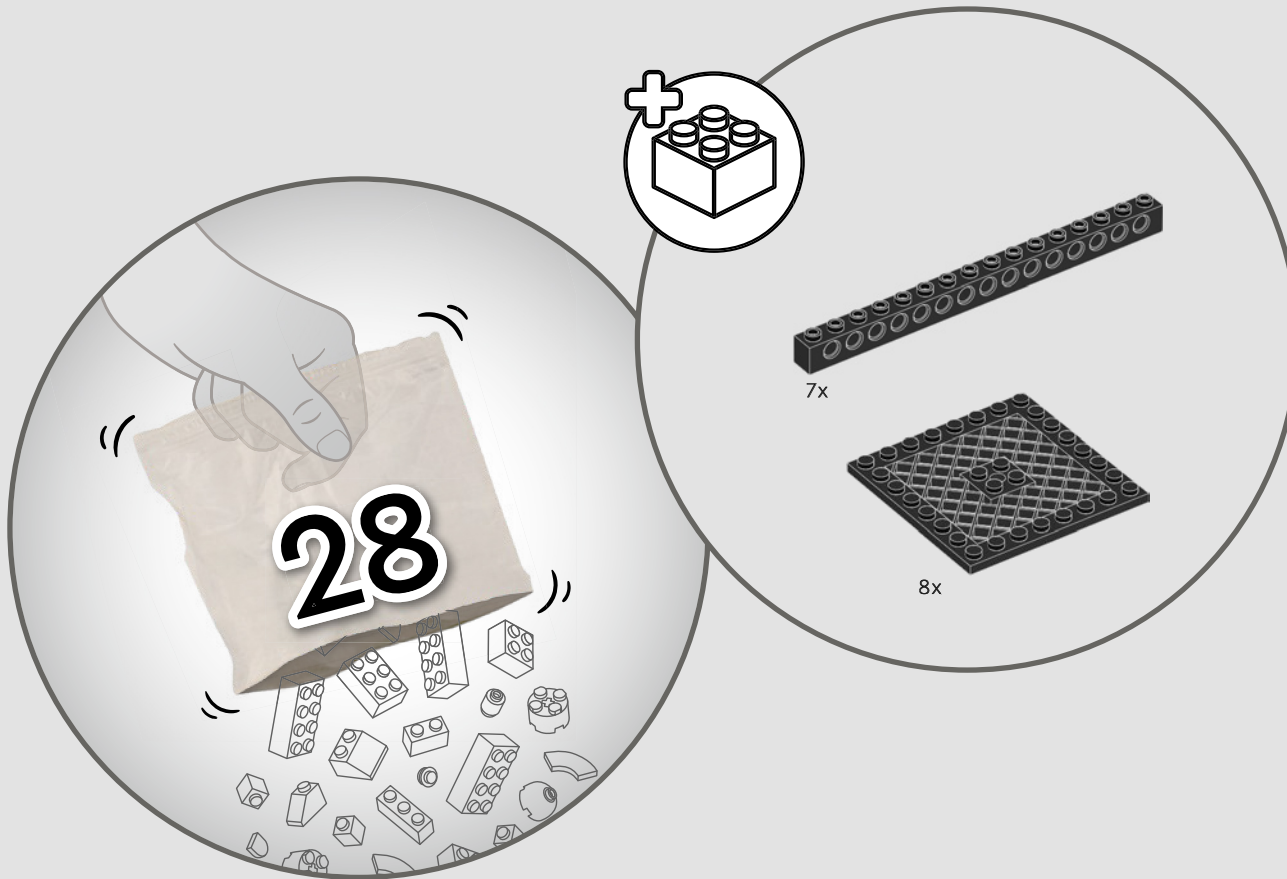



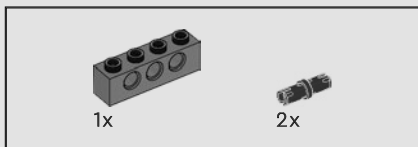
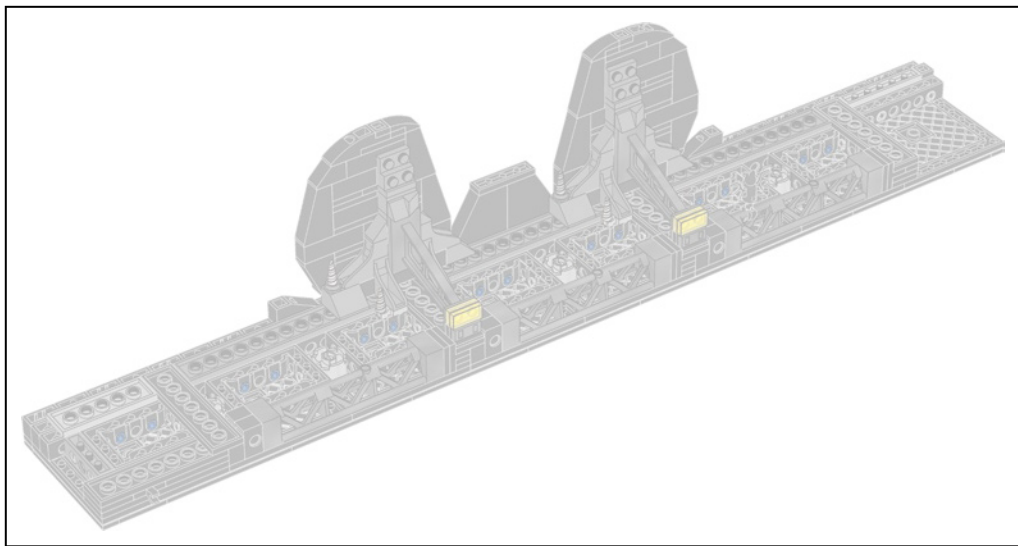

981

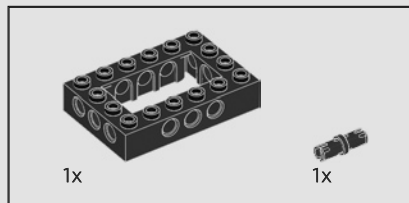
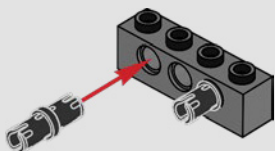

982

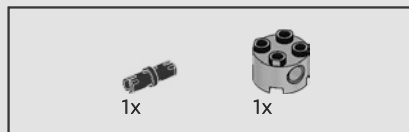
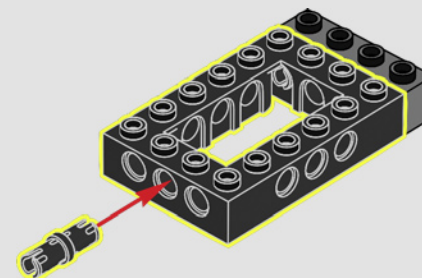

983

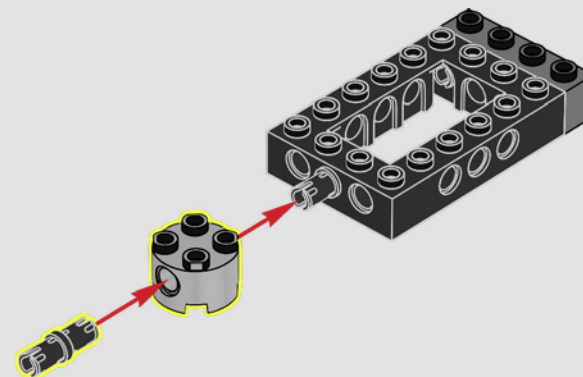

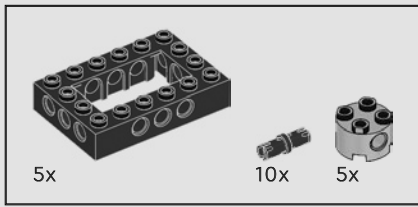

984

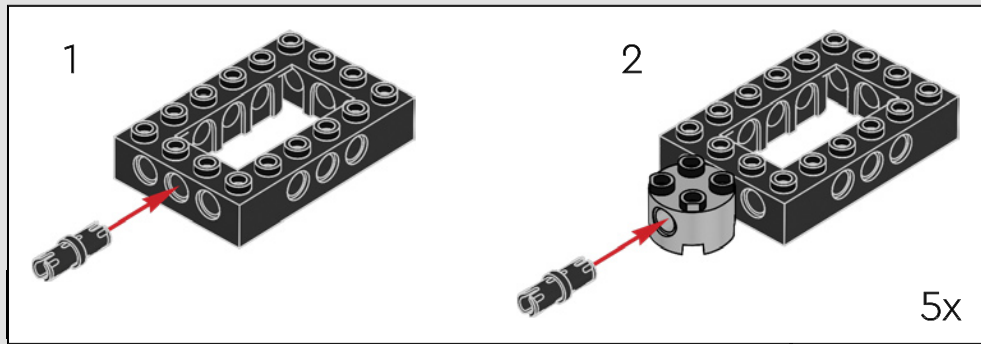

5x

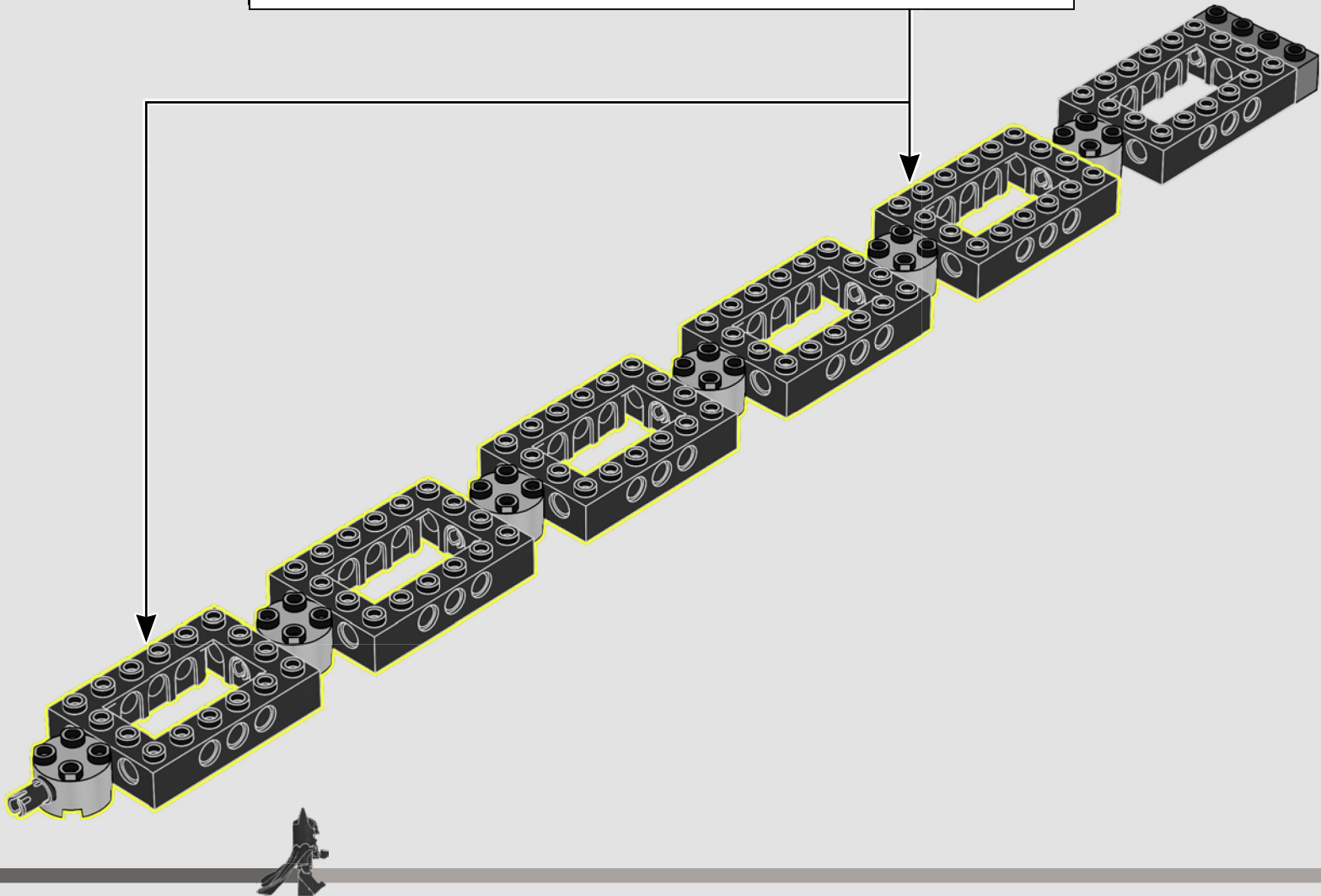

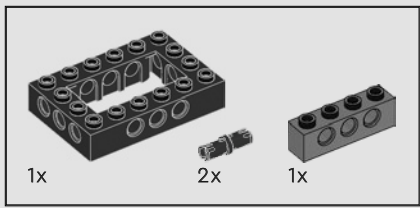

985

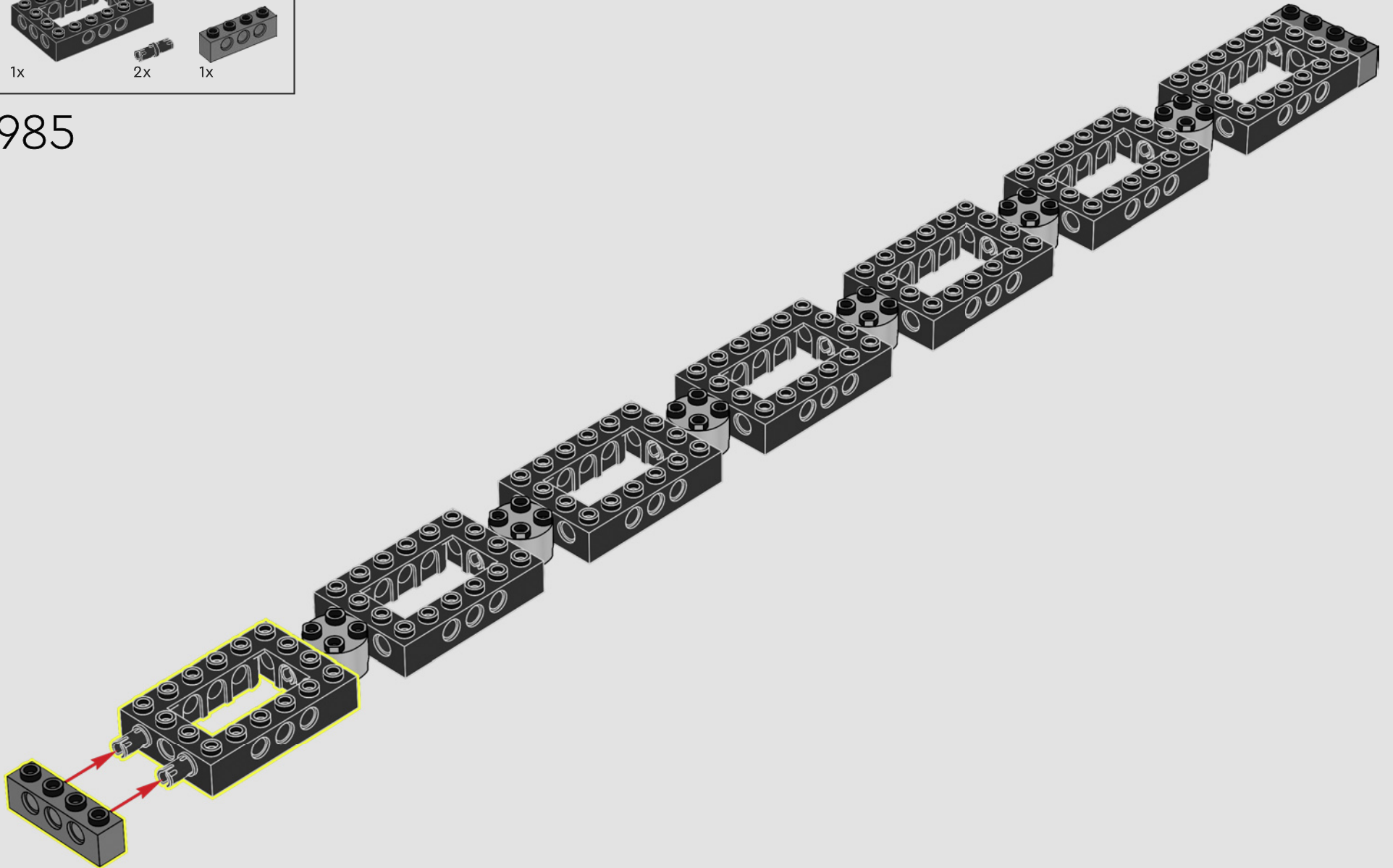



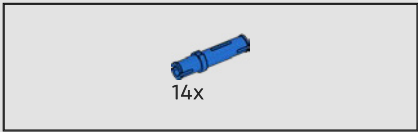

986

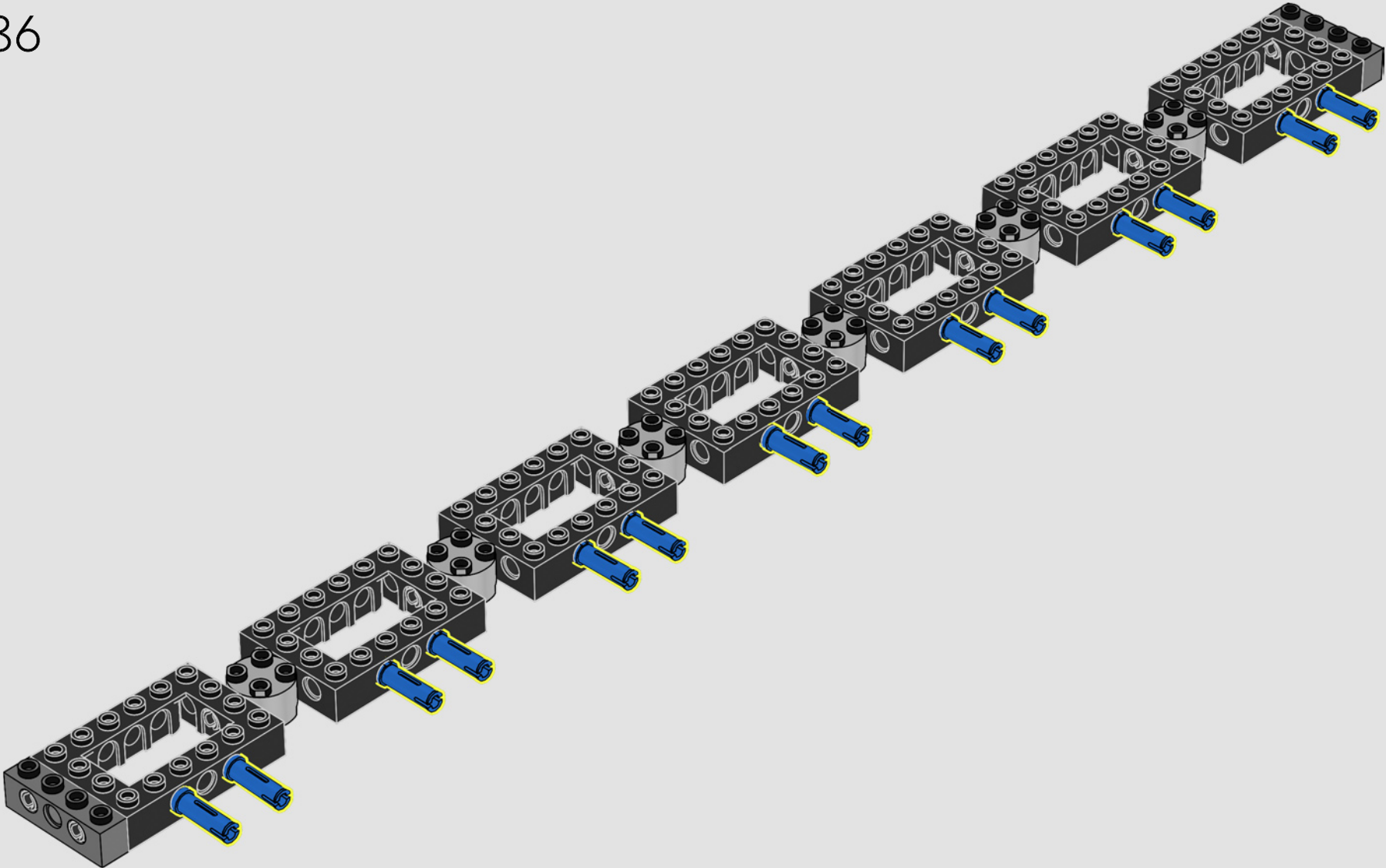

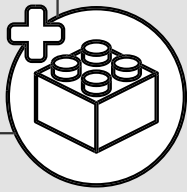
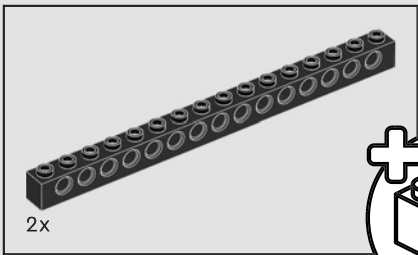

987

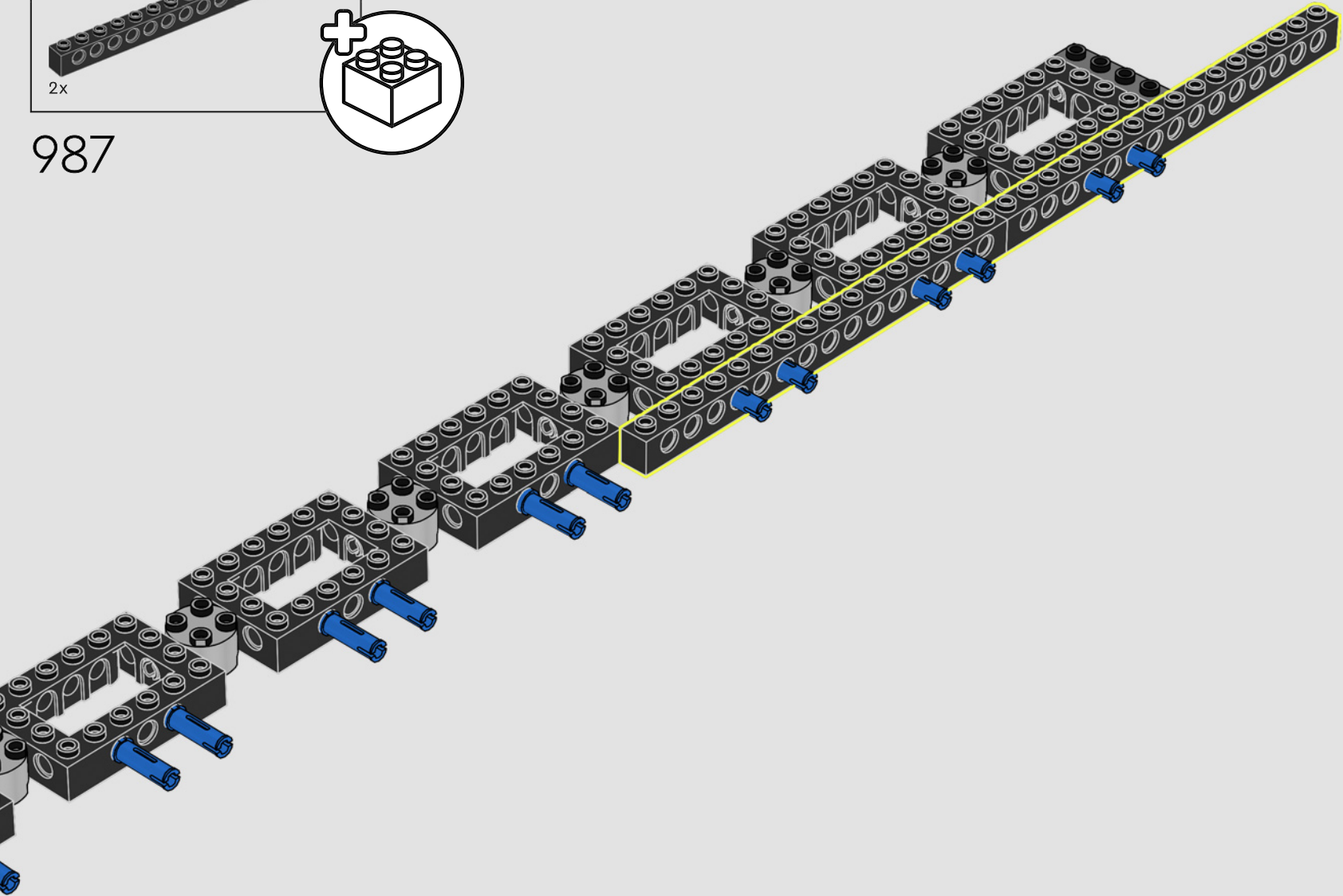

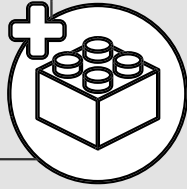
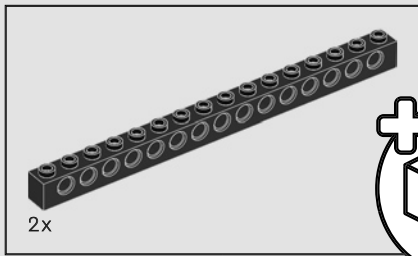

988

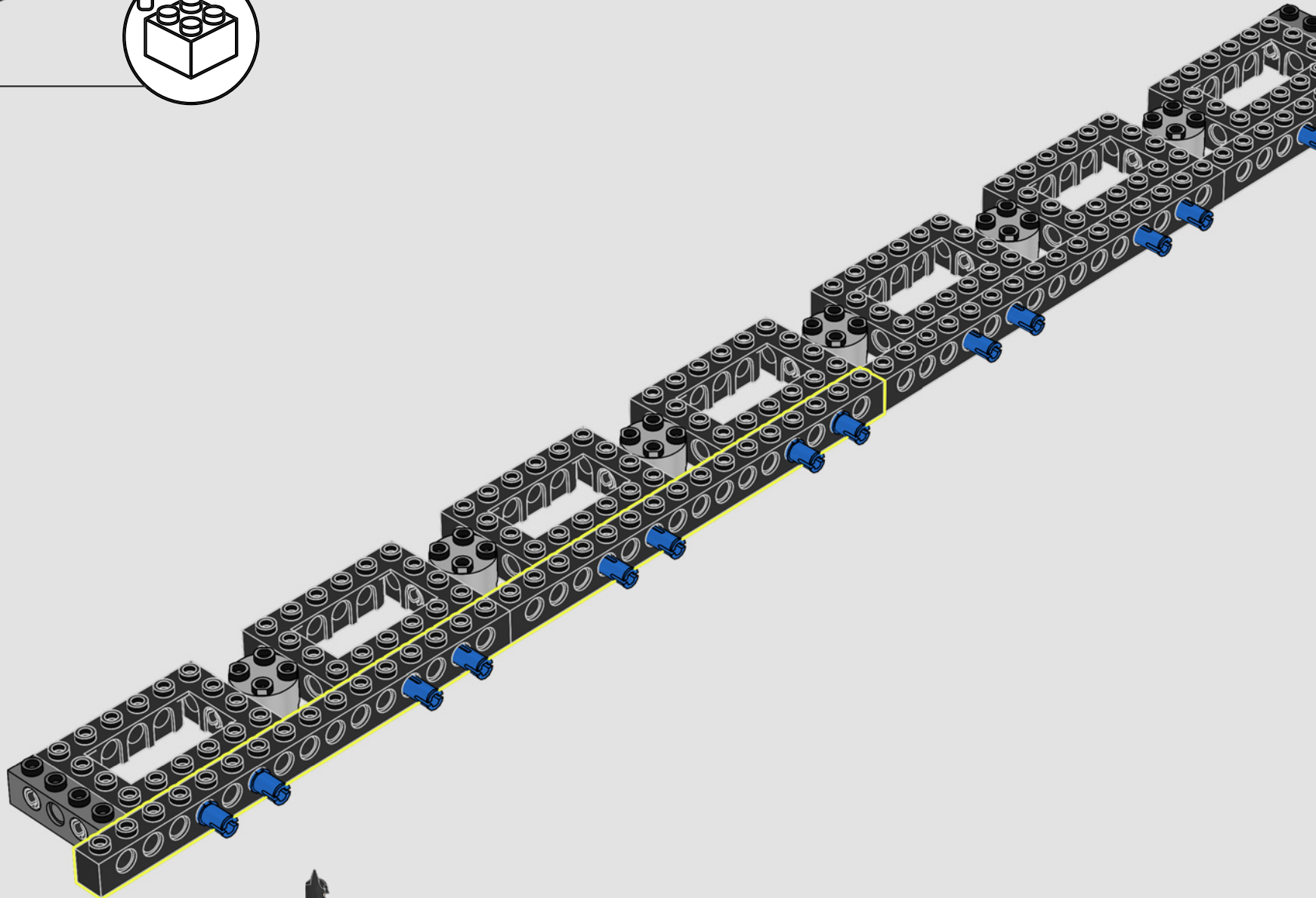



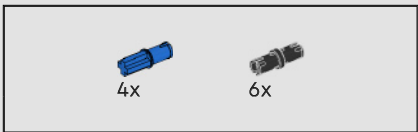

989

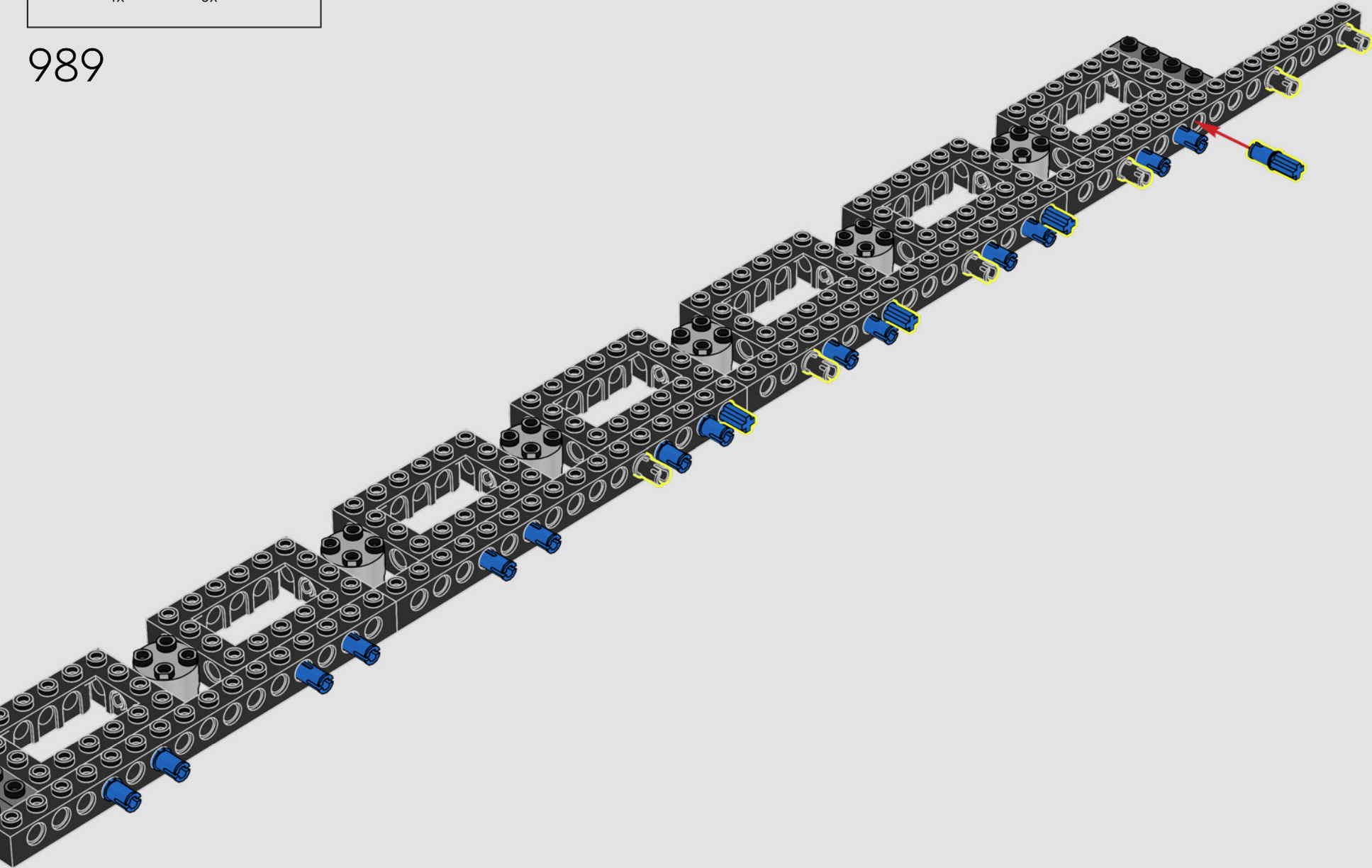

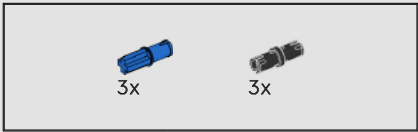

990

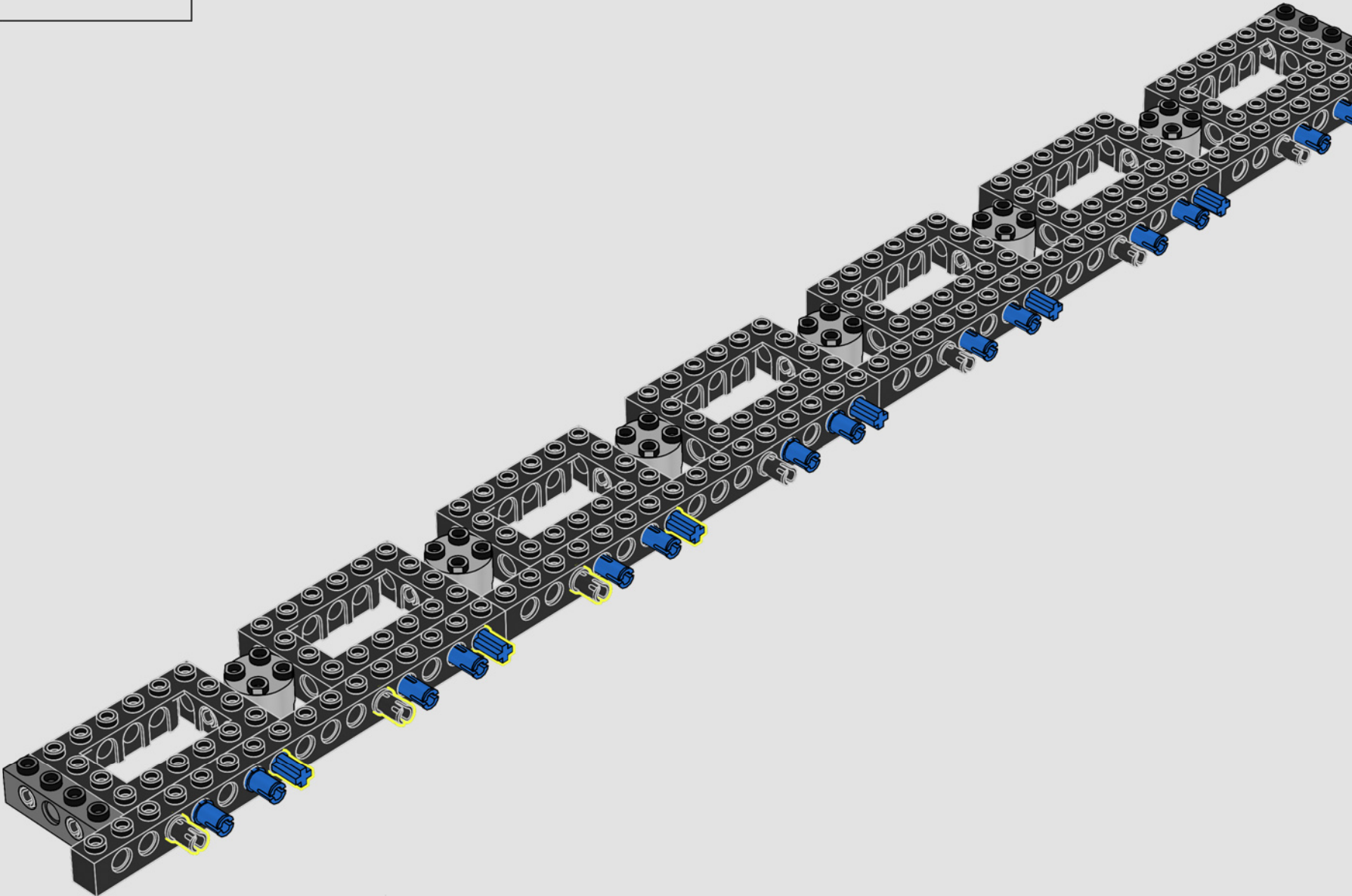

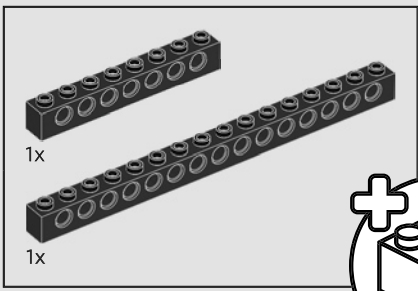

991

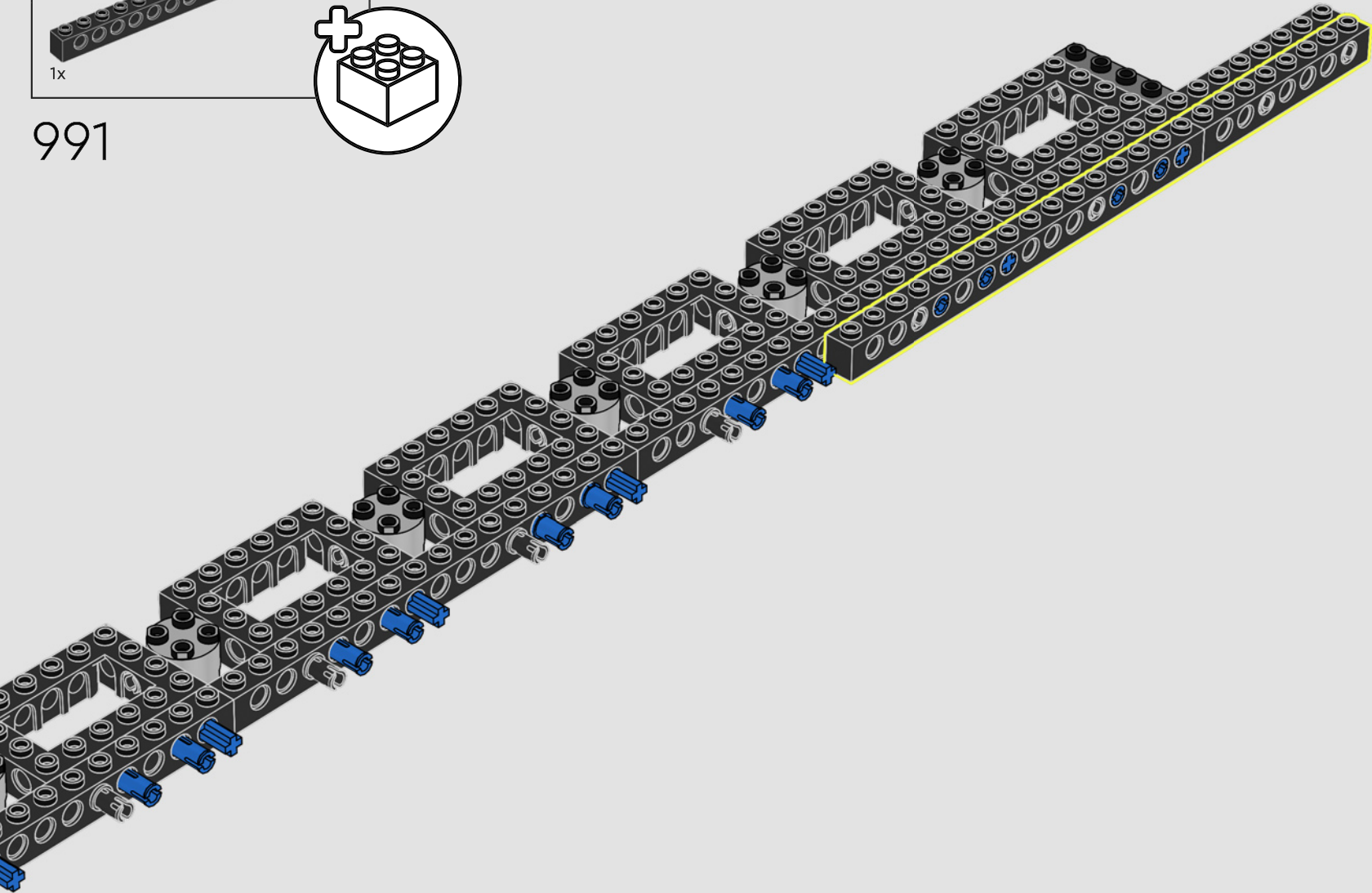
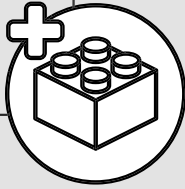



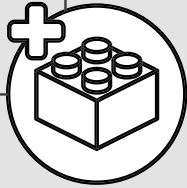
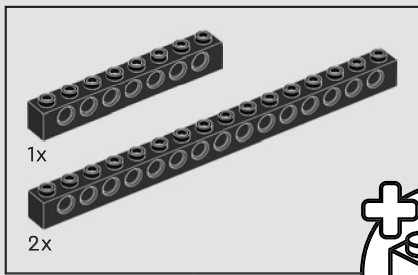

992

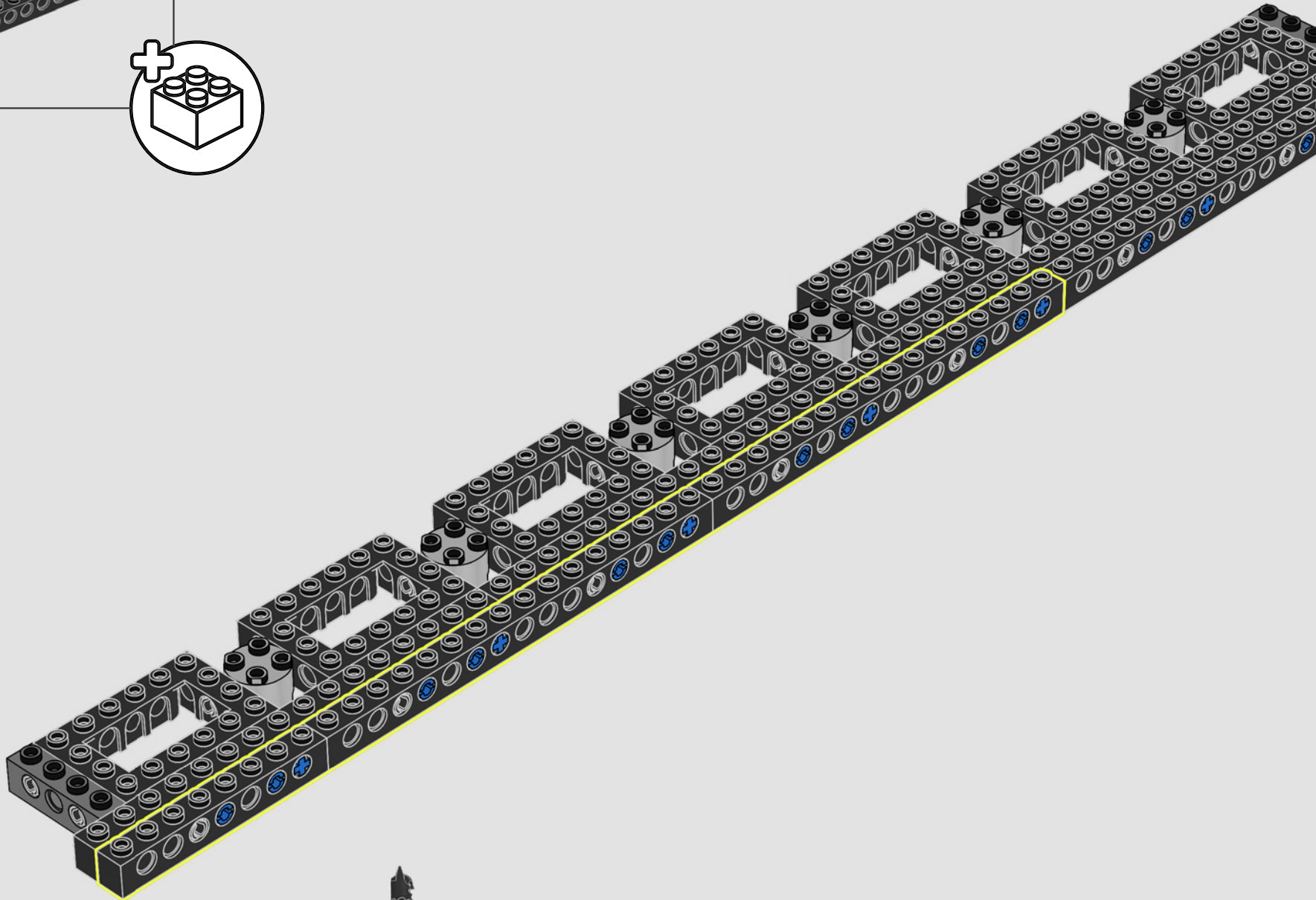

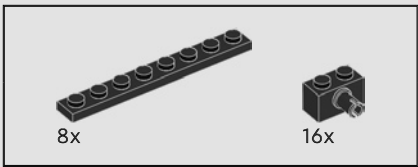

993

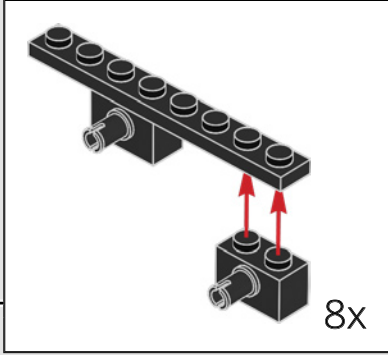
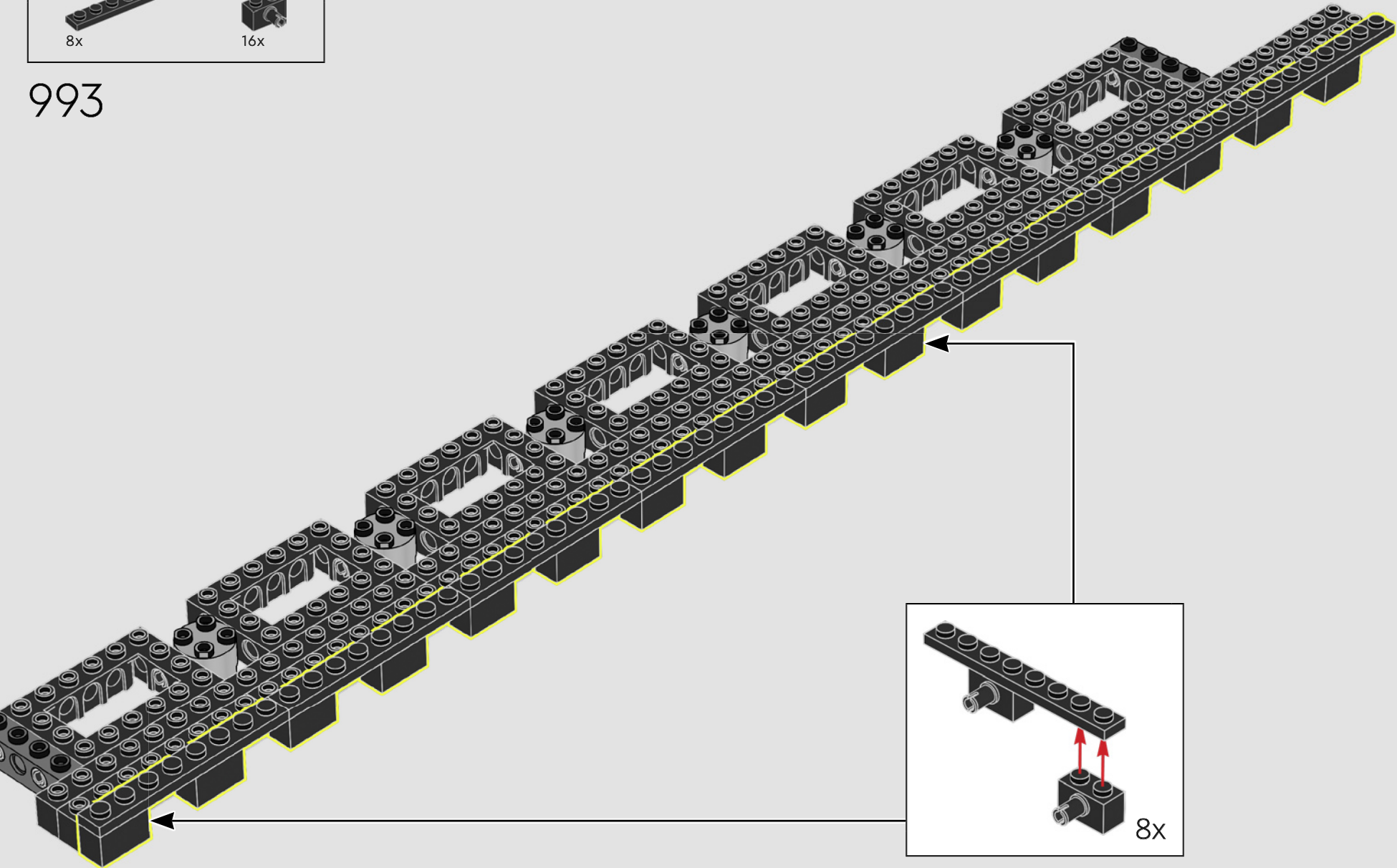

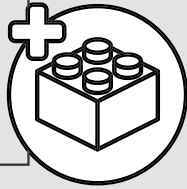
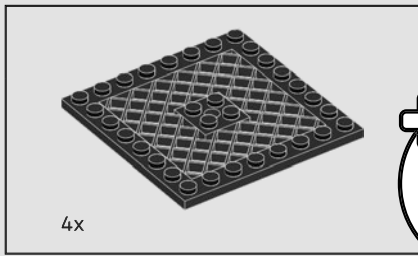

994

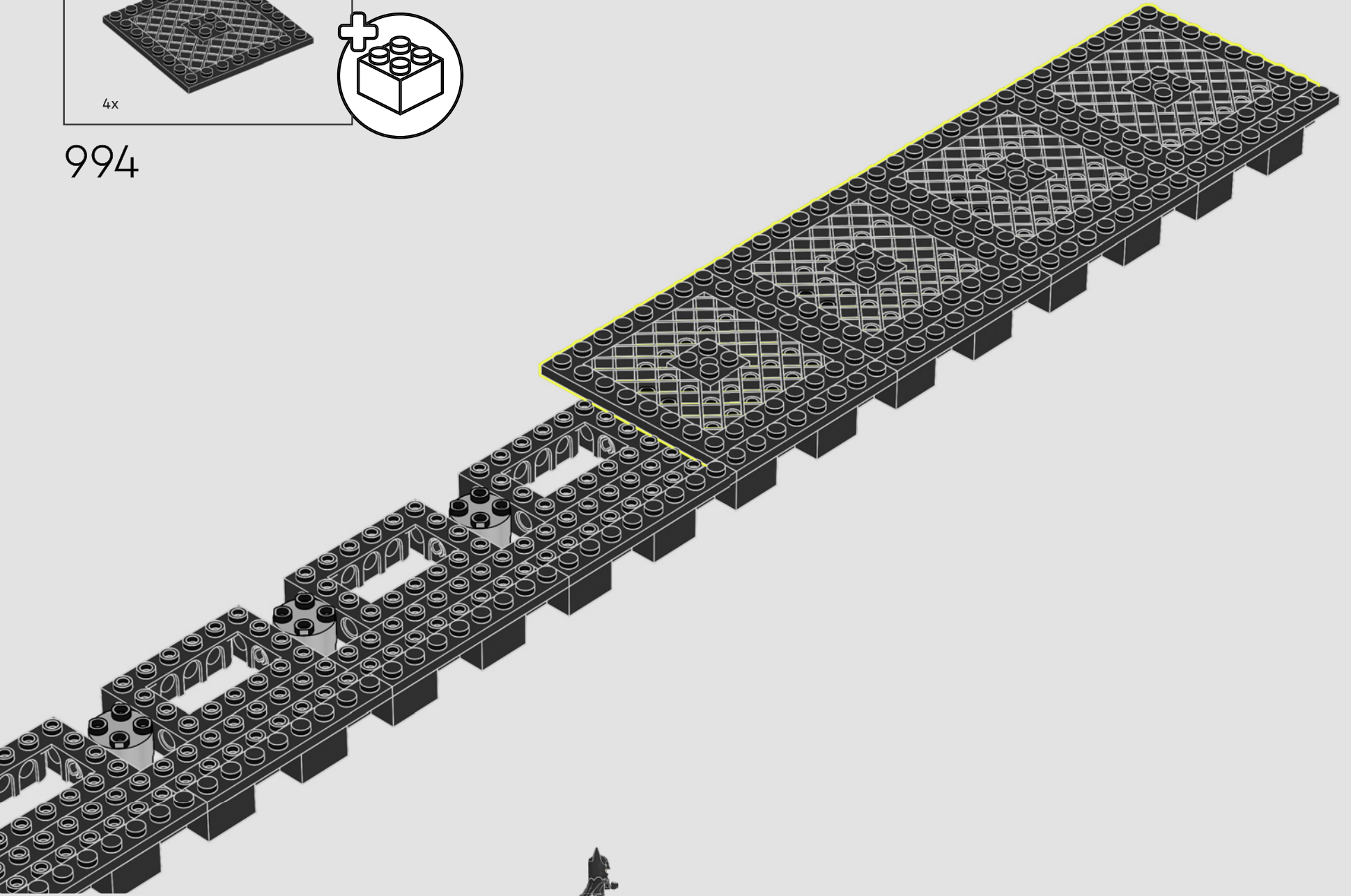



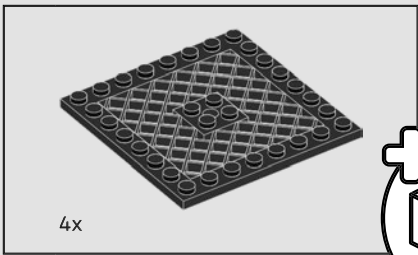

4x

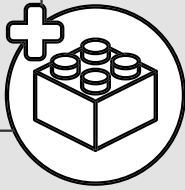

995

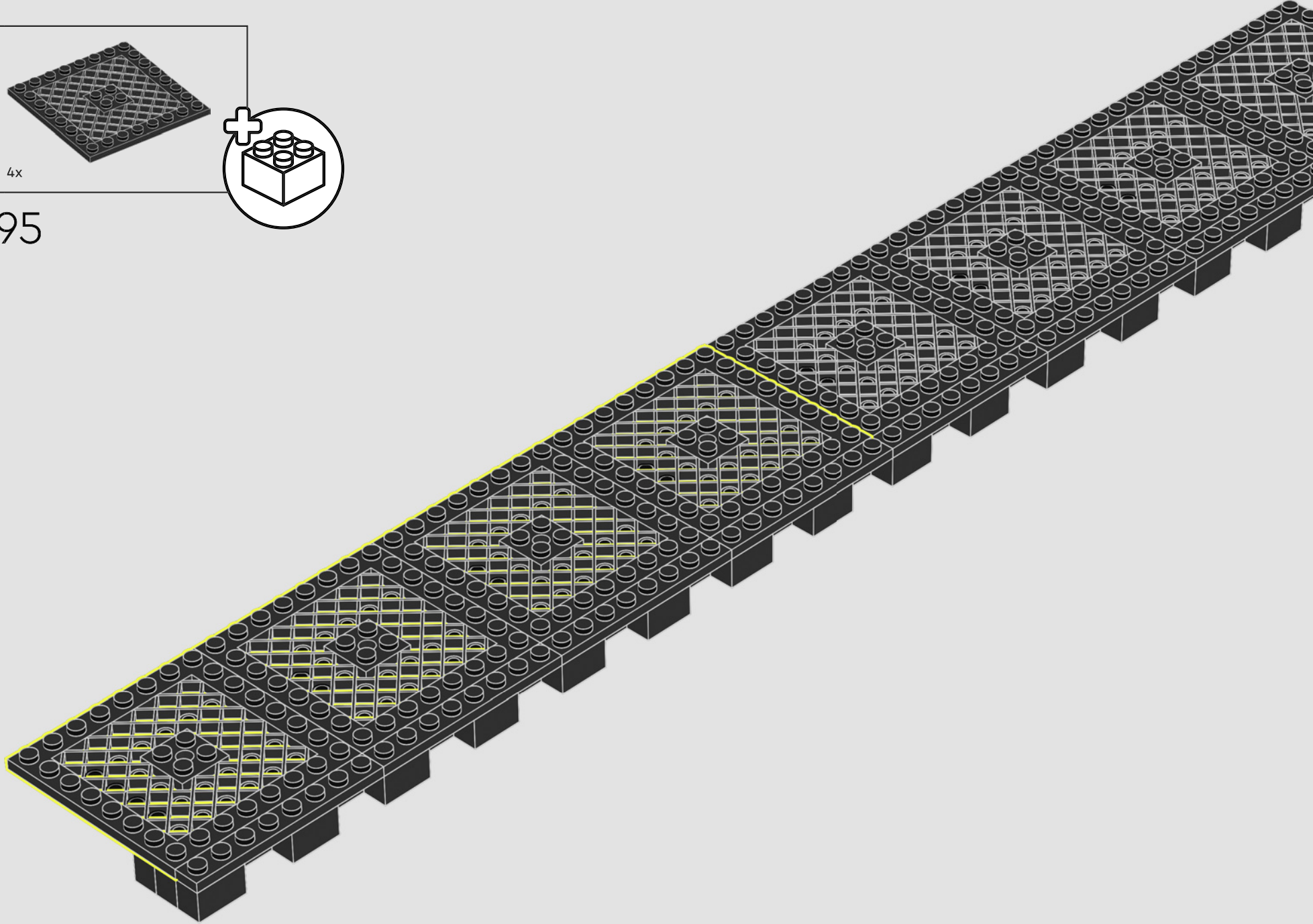

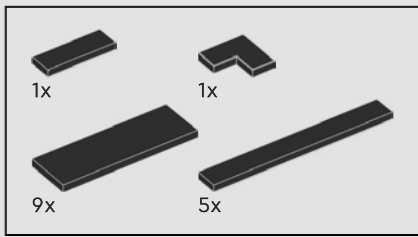

996

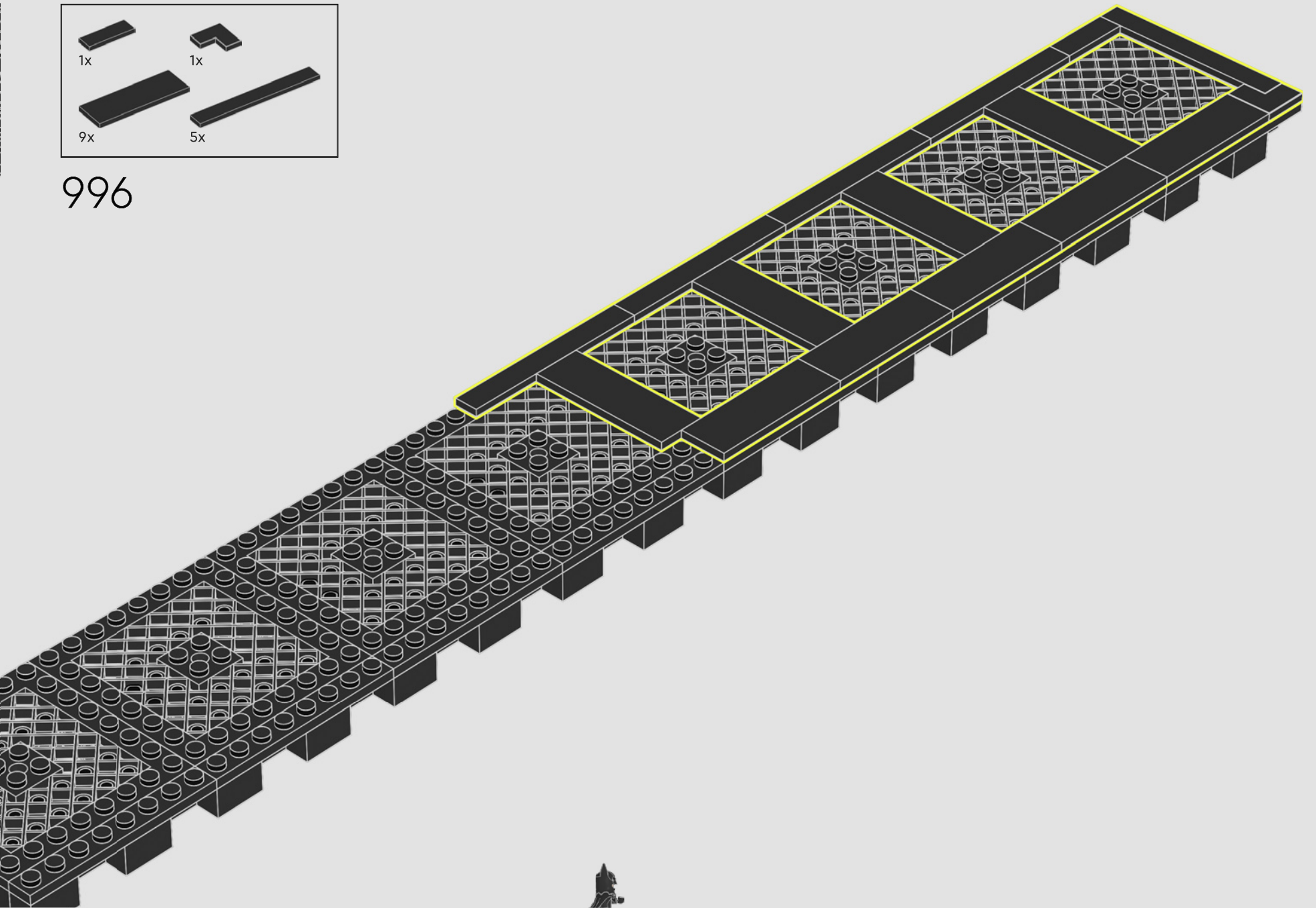

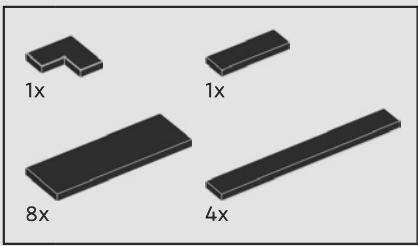

997

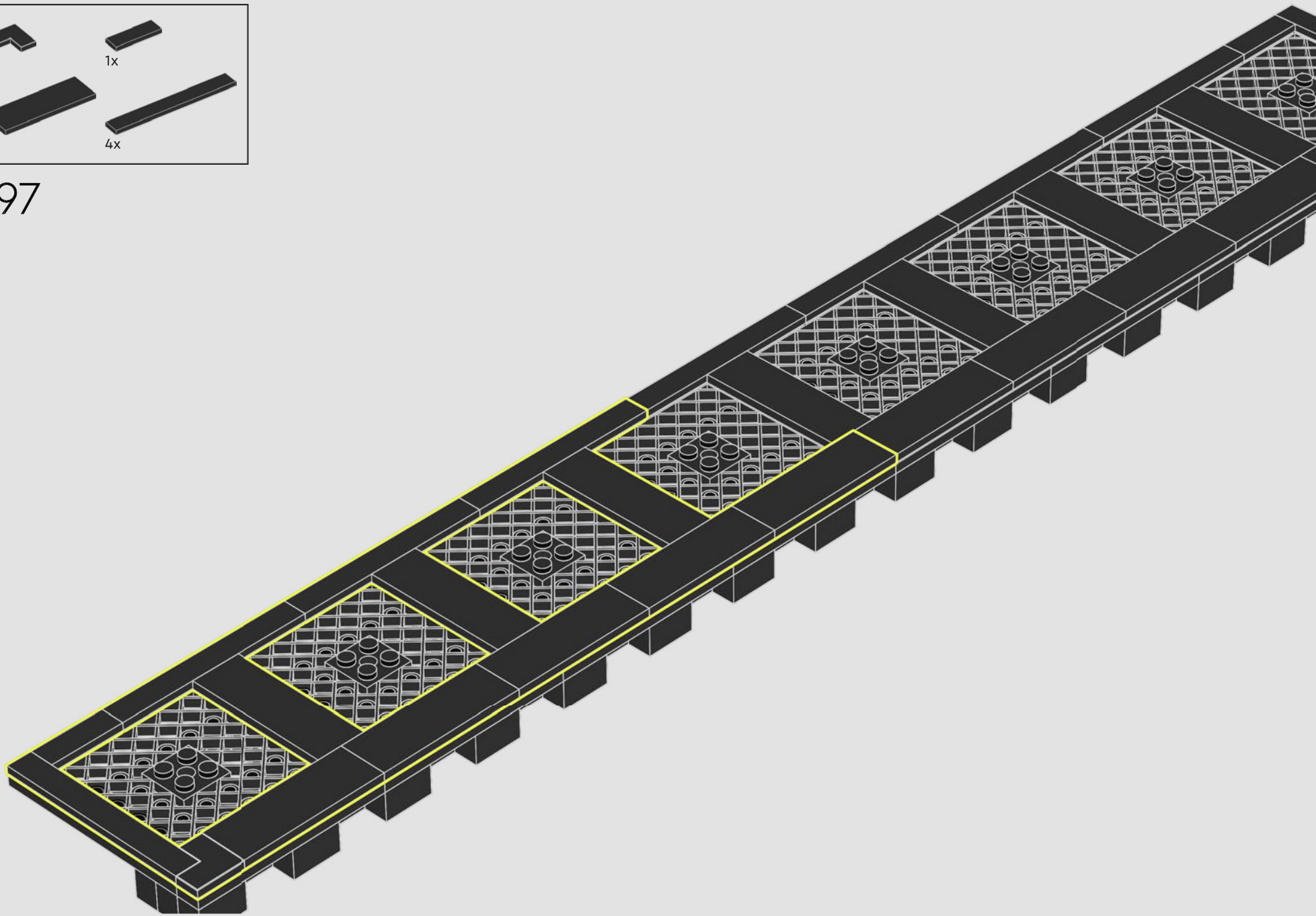



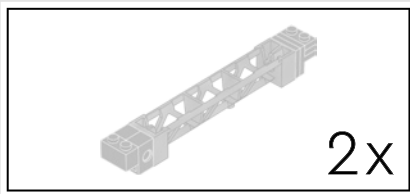

2x

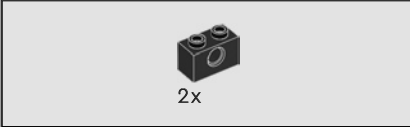

2x

998

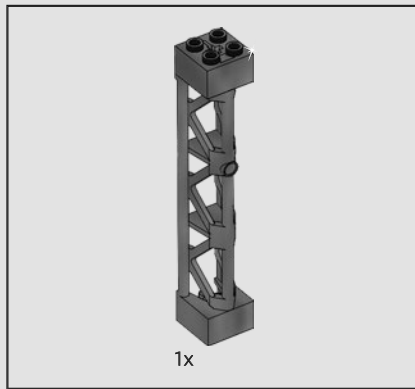
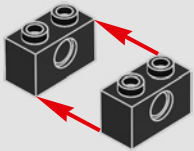

1x

999

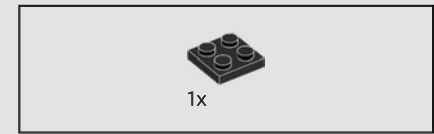
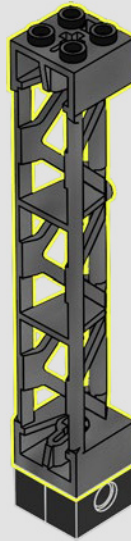

1x

1000

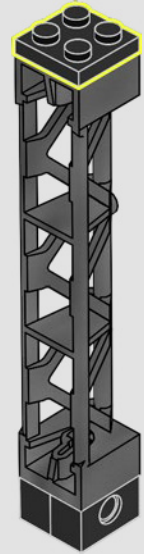



1x

1001

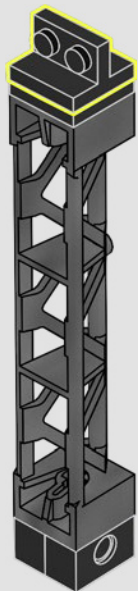

2x

1002

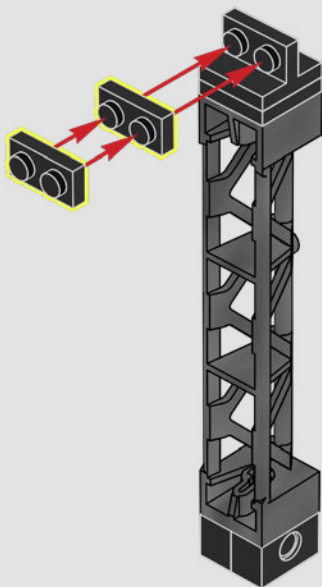

1x

1003

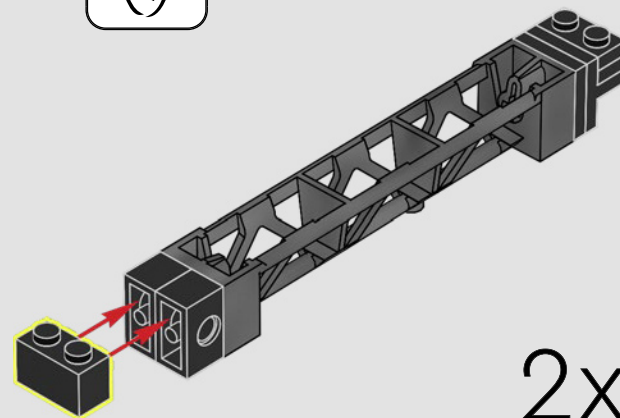

2x

1004

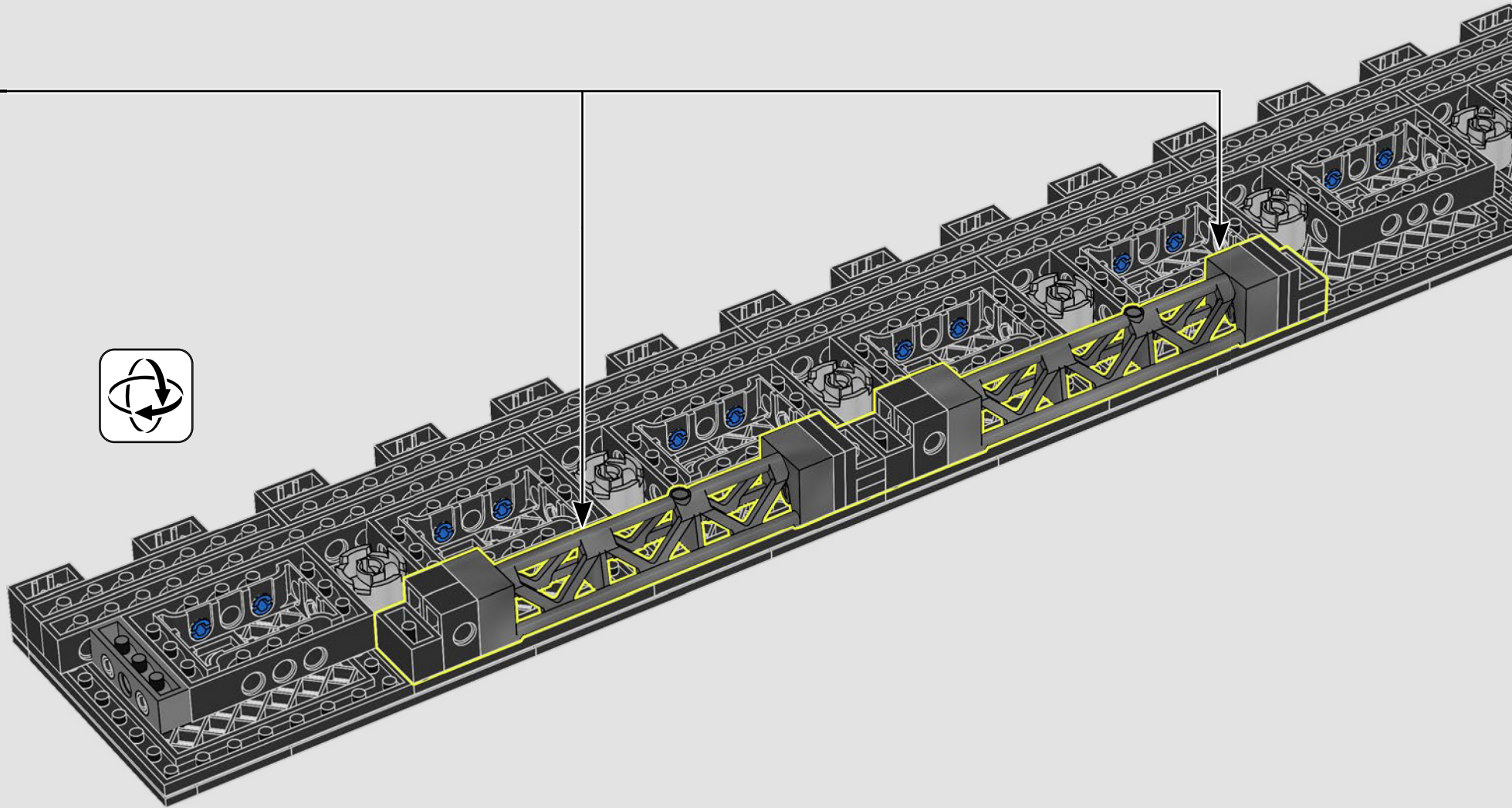



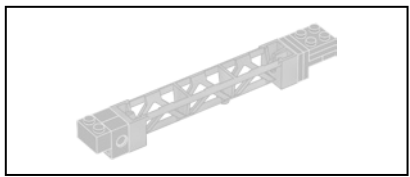

2x

1005

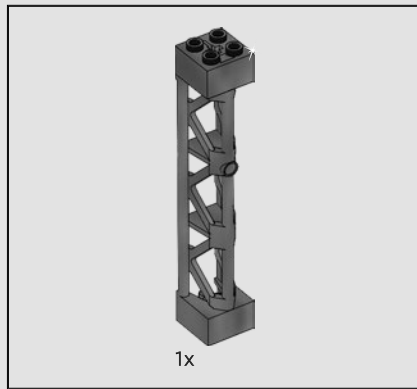
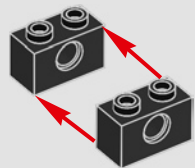

1x

1006

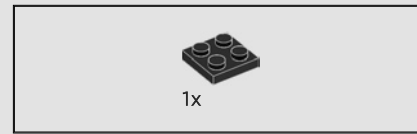
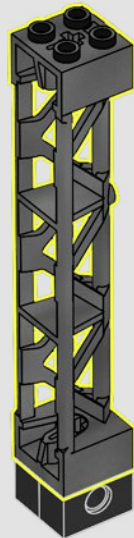

1x

1007

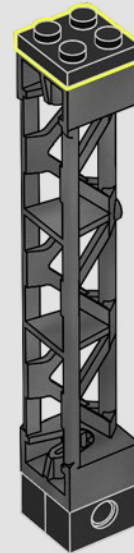

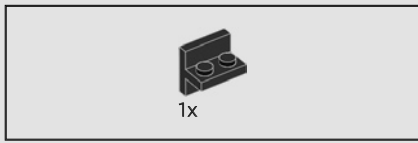

1008

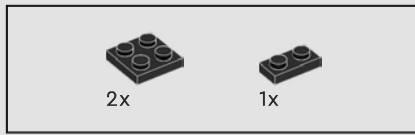
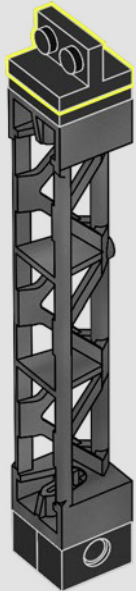

1009

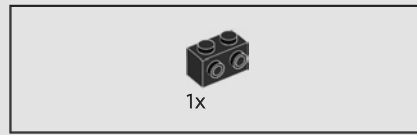
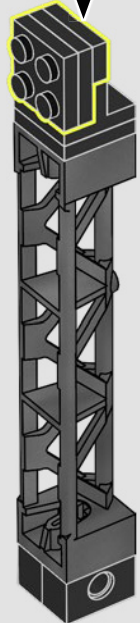
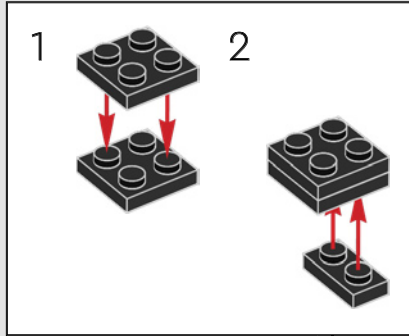

1010

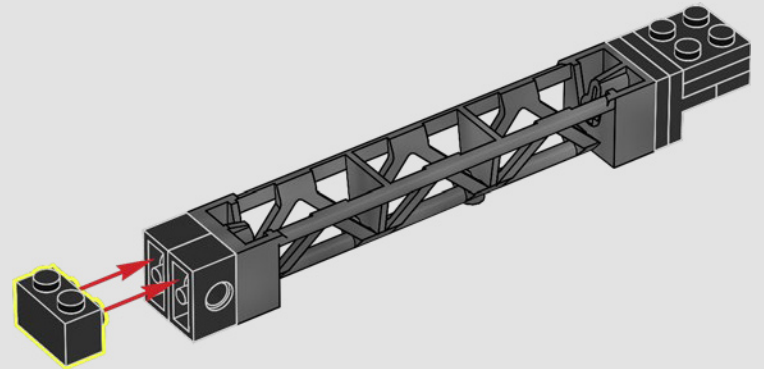
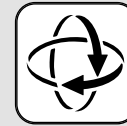

1011

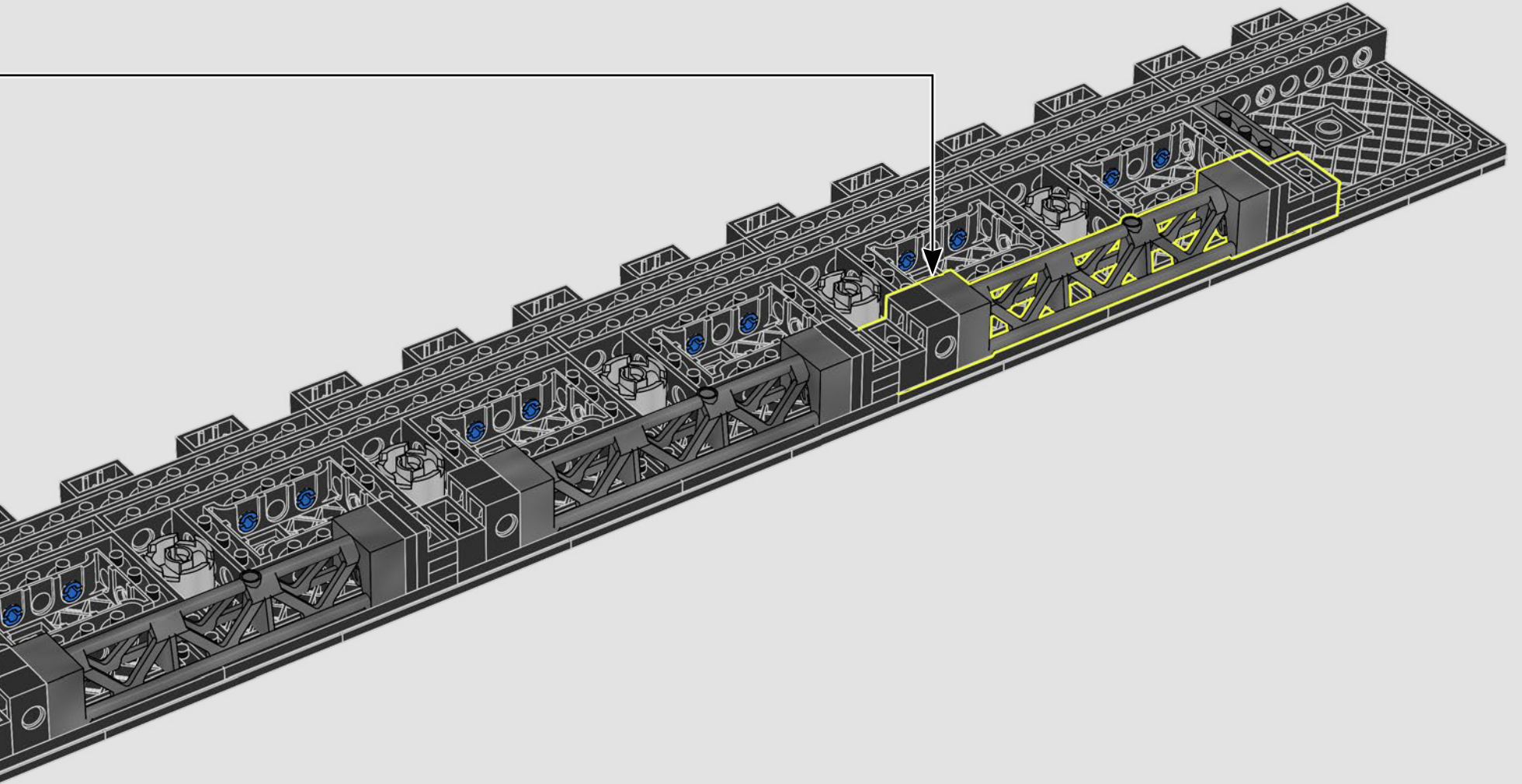



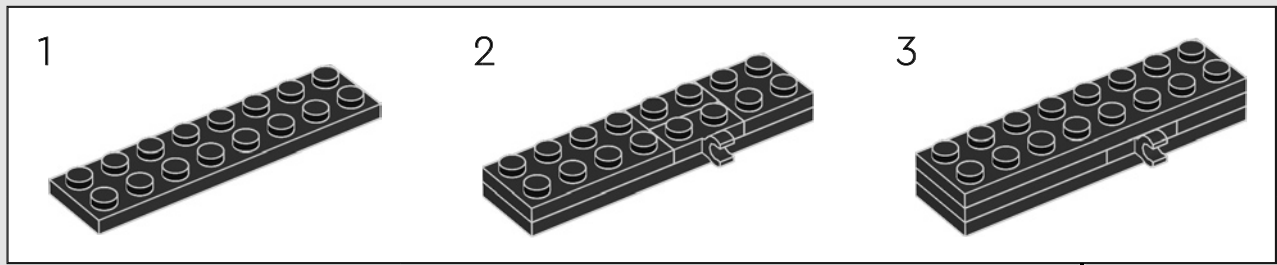
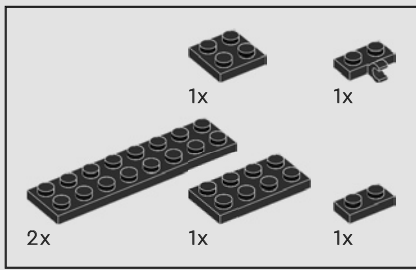

1012

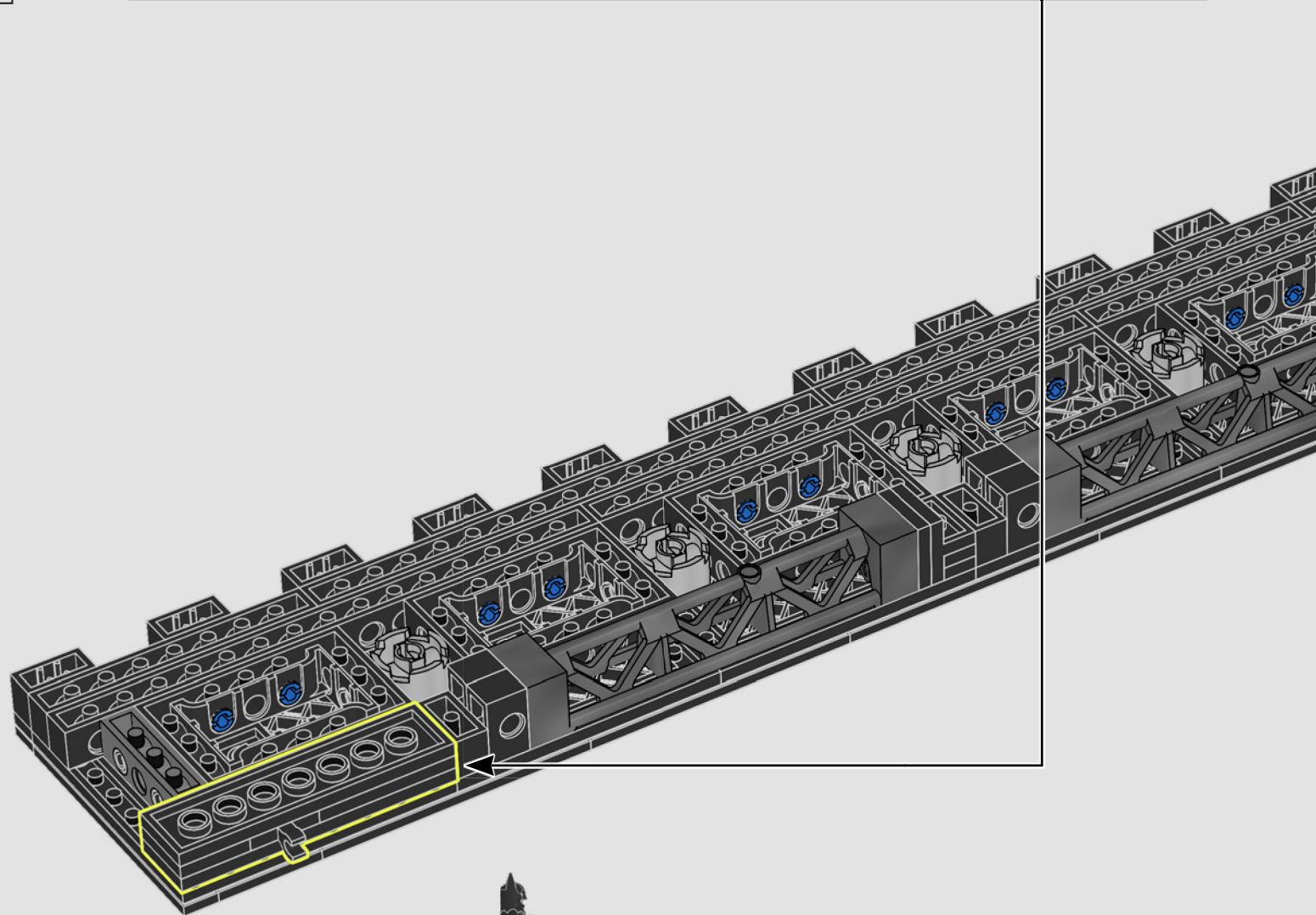

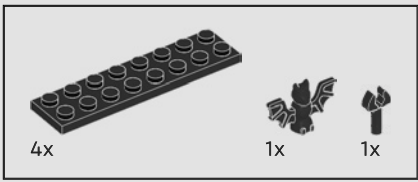

1013

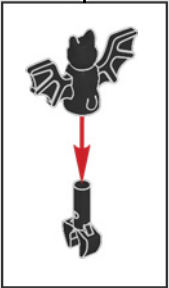
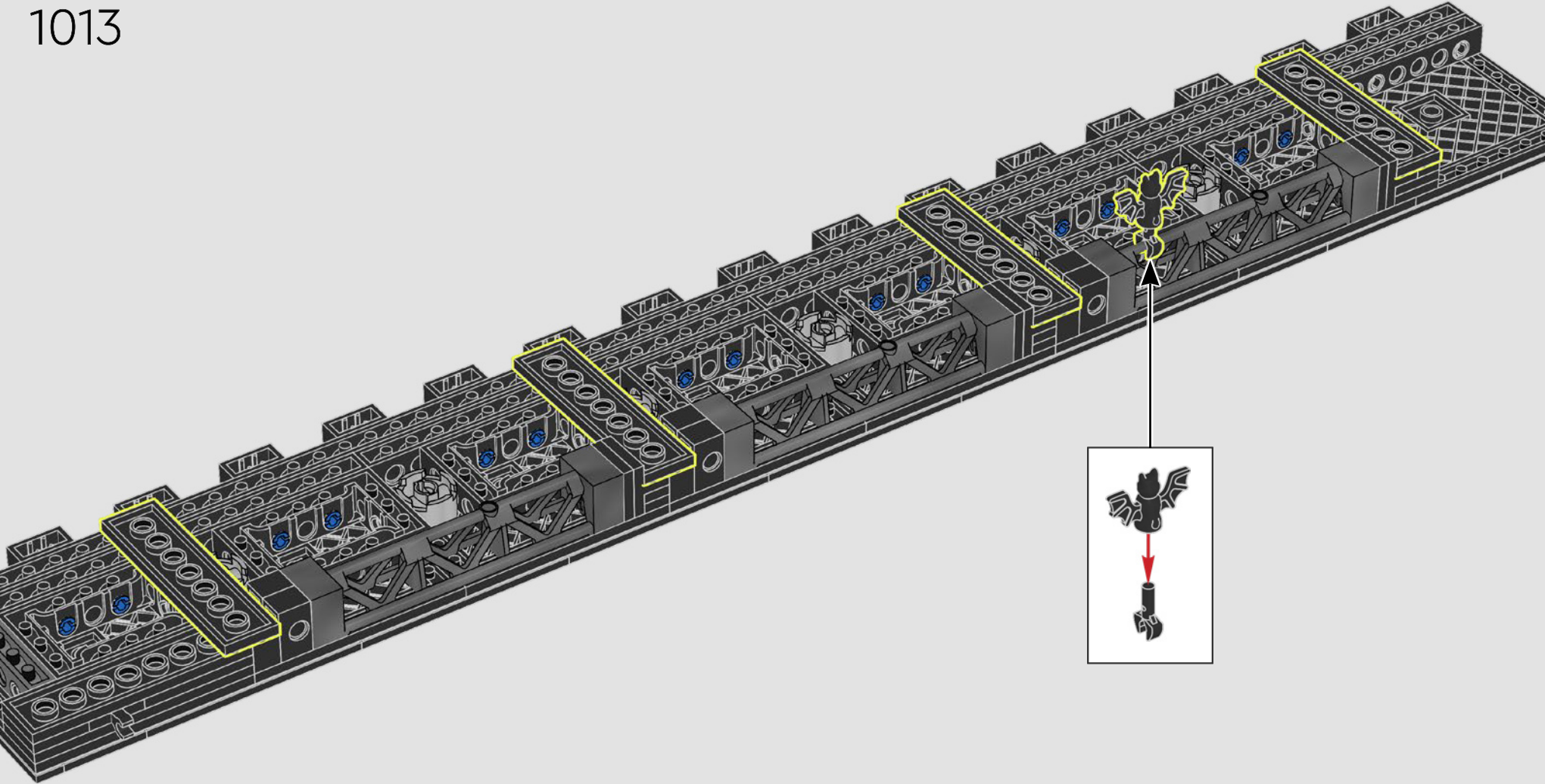

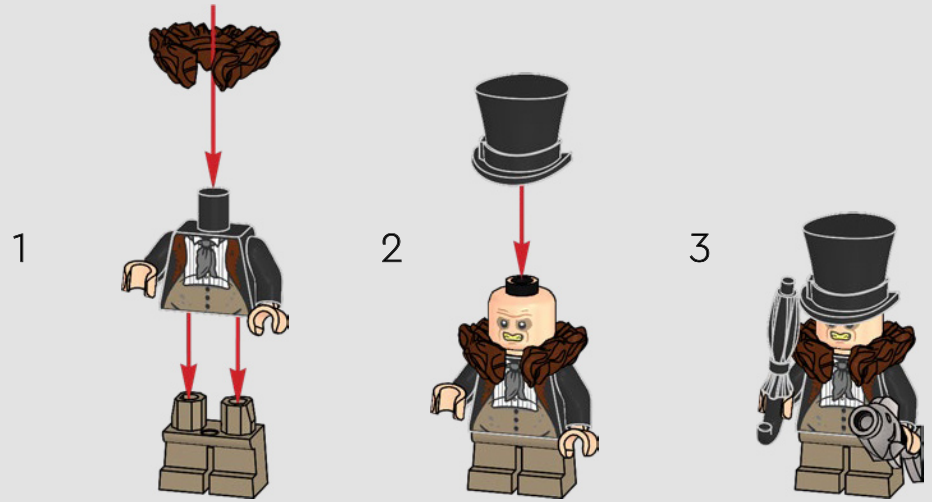





## THE PENGUIN™

Oswald Cobblepot, though a waddling, comical outcast from the literal underworld of GOTHAM CITY™, should not be underestimated. As he reinvents himself as The Penguin™, he channels his nose for finding dirt into a criminal empire fueled by a colony of deranged henchmen, blackmail, corruption – and weaponized umbrellas!

## LE PINGOUIN

Oswald Cobblepot, bien qu'il soit un paria comique et dandinant du monde souterrain de GOTHAM CITY™, ne doit pas être sous-estimé. Alors qu'il se réinvente en tant que Pingouin, il utilise son nez pour déterrer les sombres secrets d'un empire criminel alimenté par une colonie d'hommes de main dérangés, le chantage, la corruption – et des parapluies armés!

## EL PINGÜINO

A pesar de ser un extravagante y cómico marginado del bajo mundo (en un sentido muy literal) de CIUDAD GÓTICA, Oswald Cobblepot no es alguien a quien sea sensato subestimar. Renacido como el Pingüino, canaliza su extraordinario olfato por la podredumbre formando un imperio criminal alimentado por una colonia de secuaces trastornados, chantajes, corrupción, ¡y paraguas con armas!

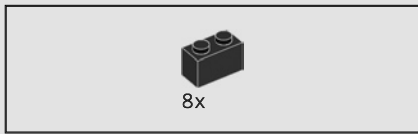

1014

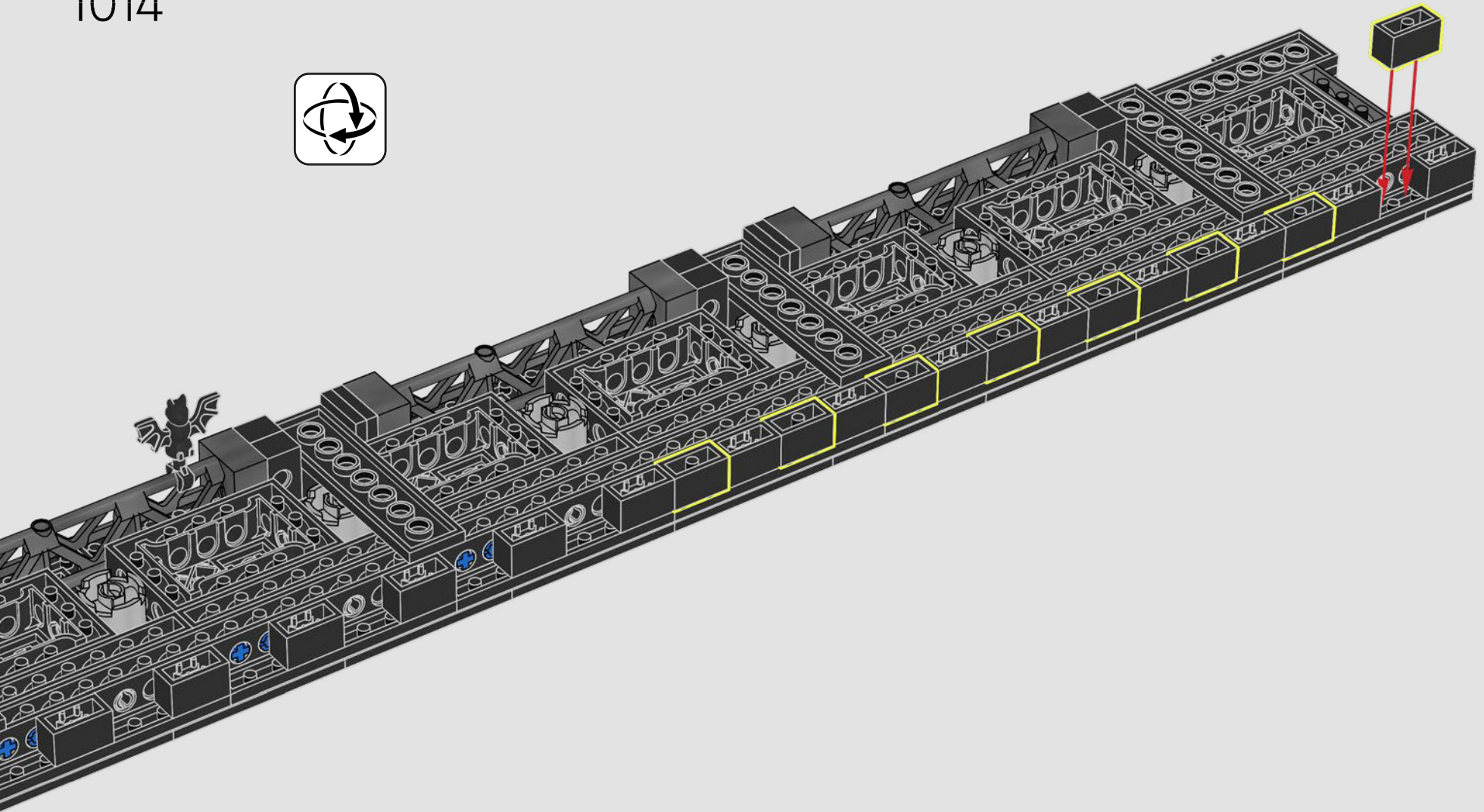



8x

1015

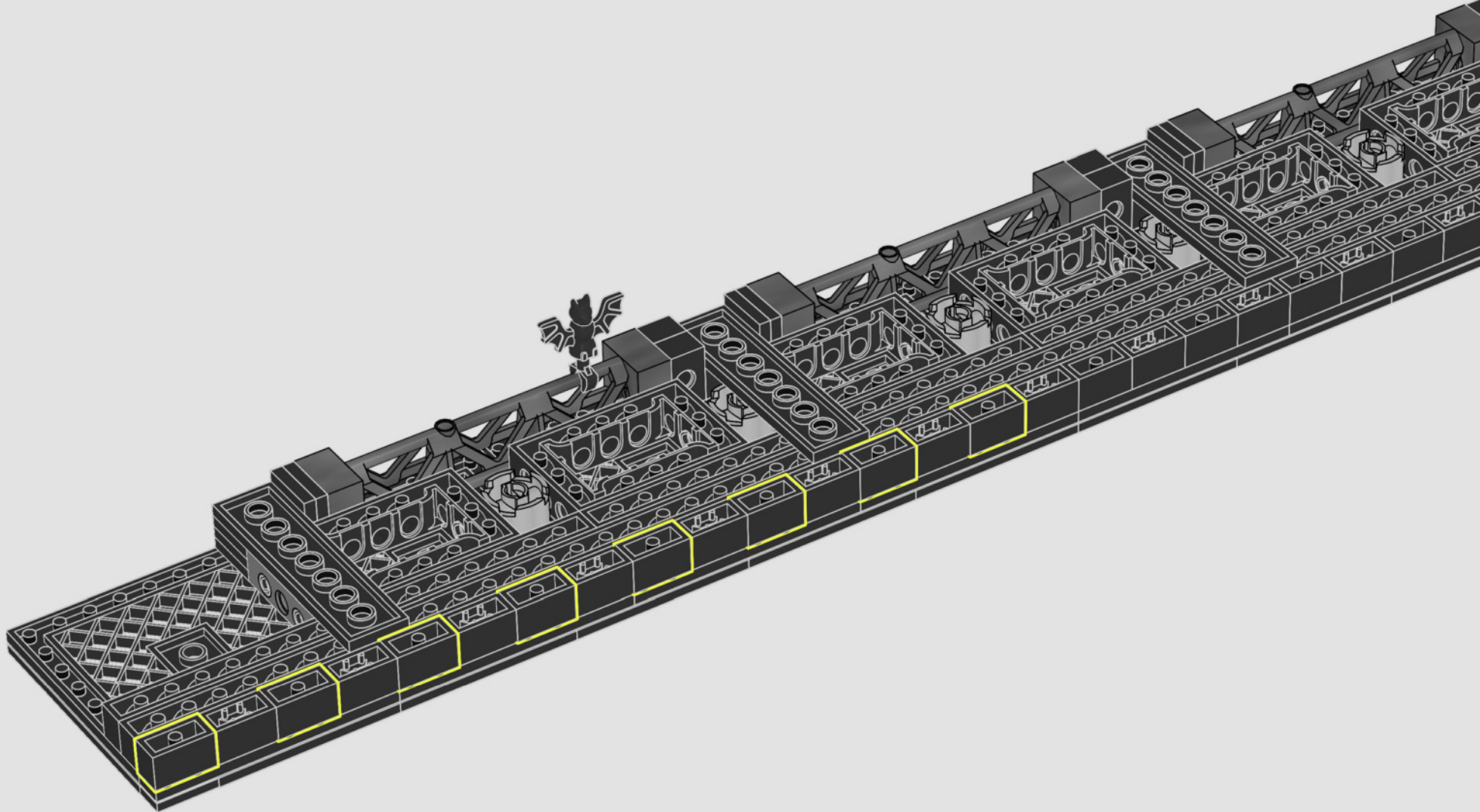



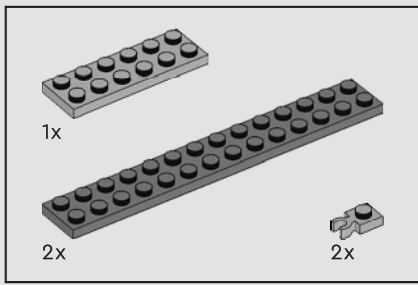

1016

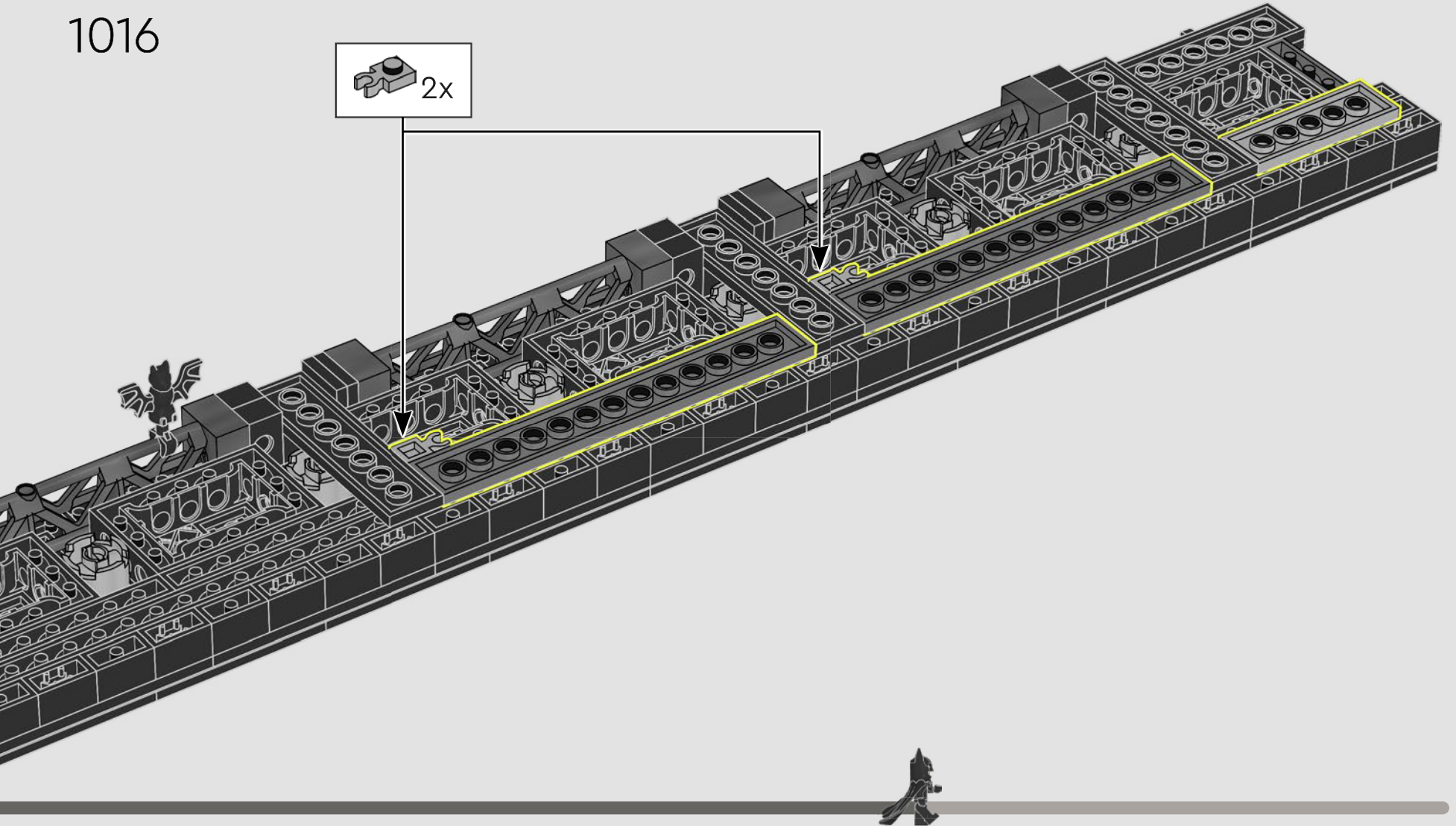
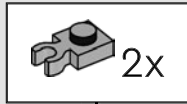

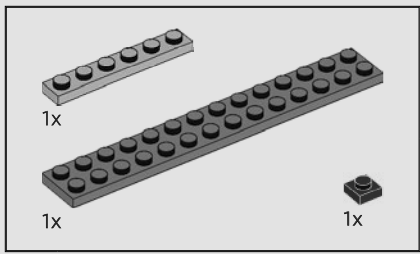

1017

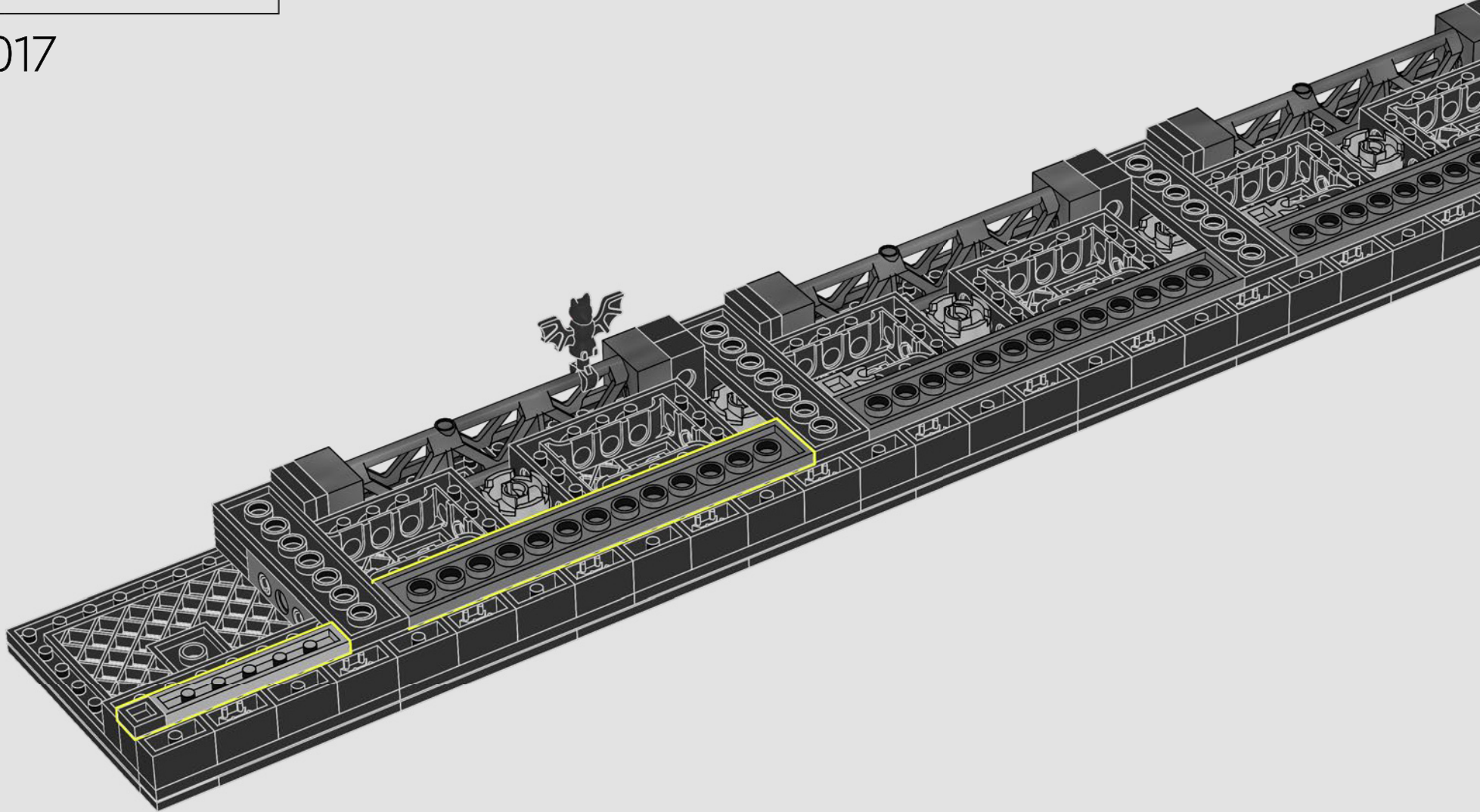

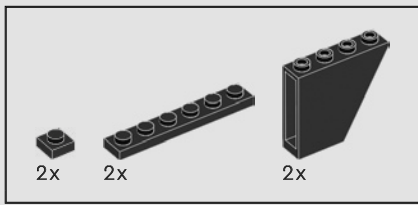

1018

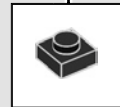
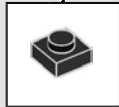
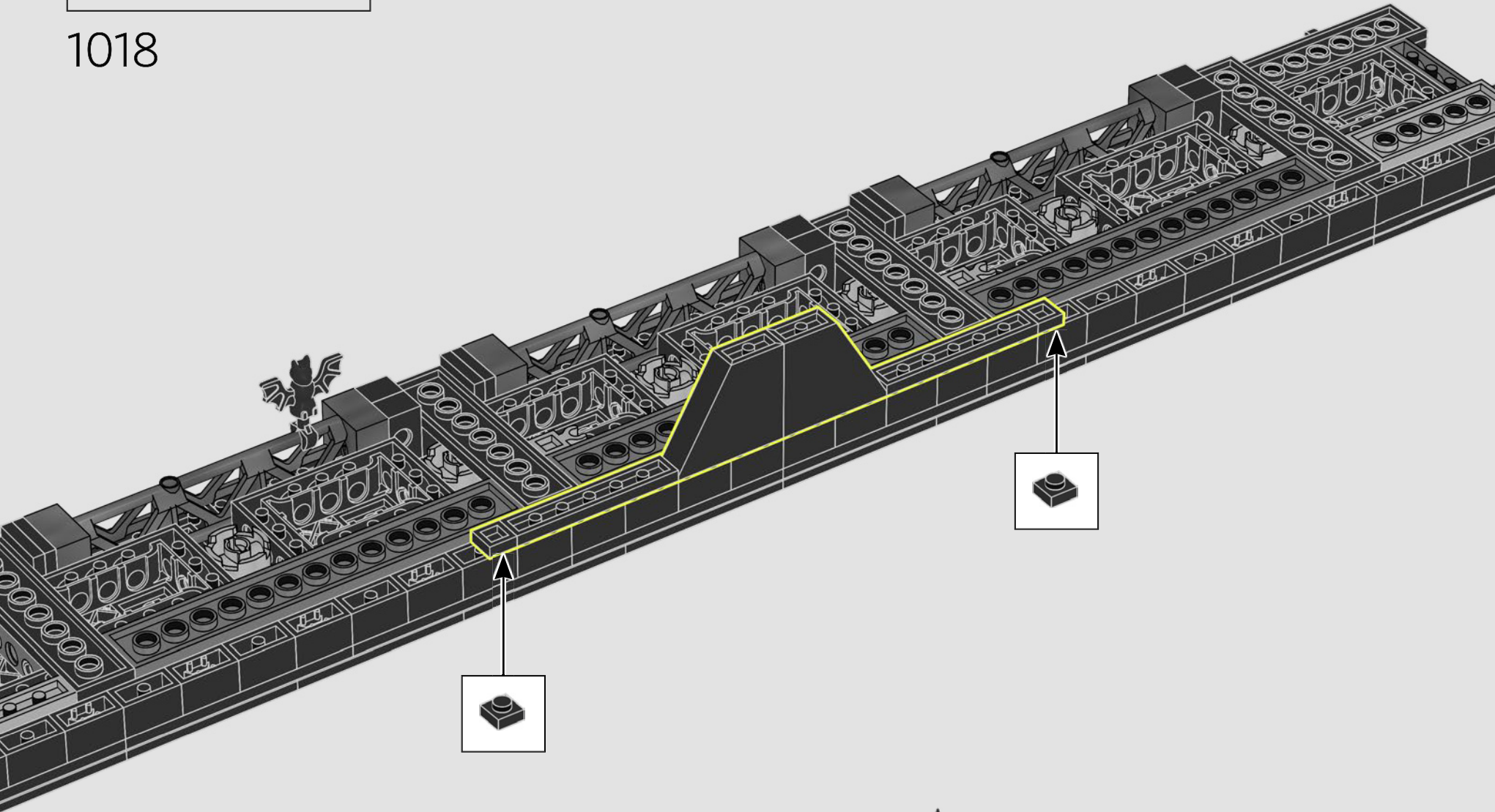



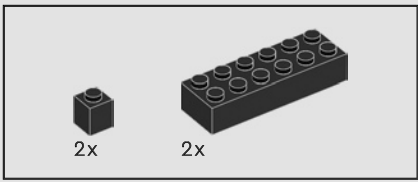

1019

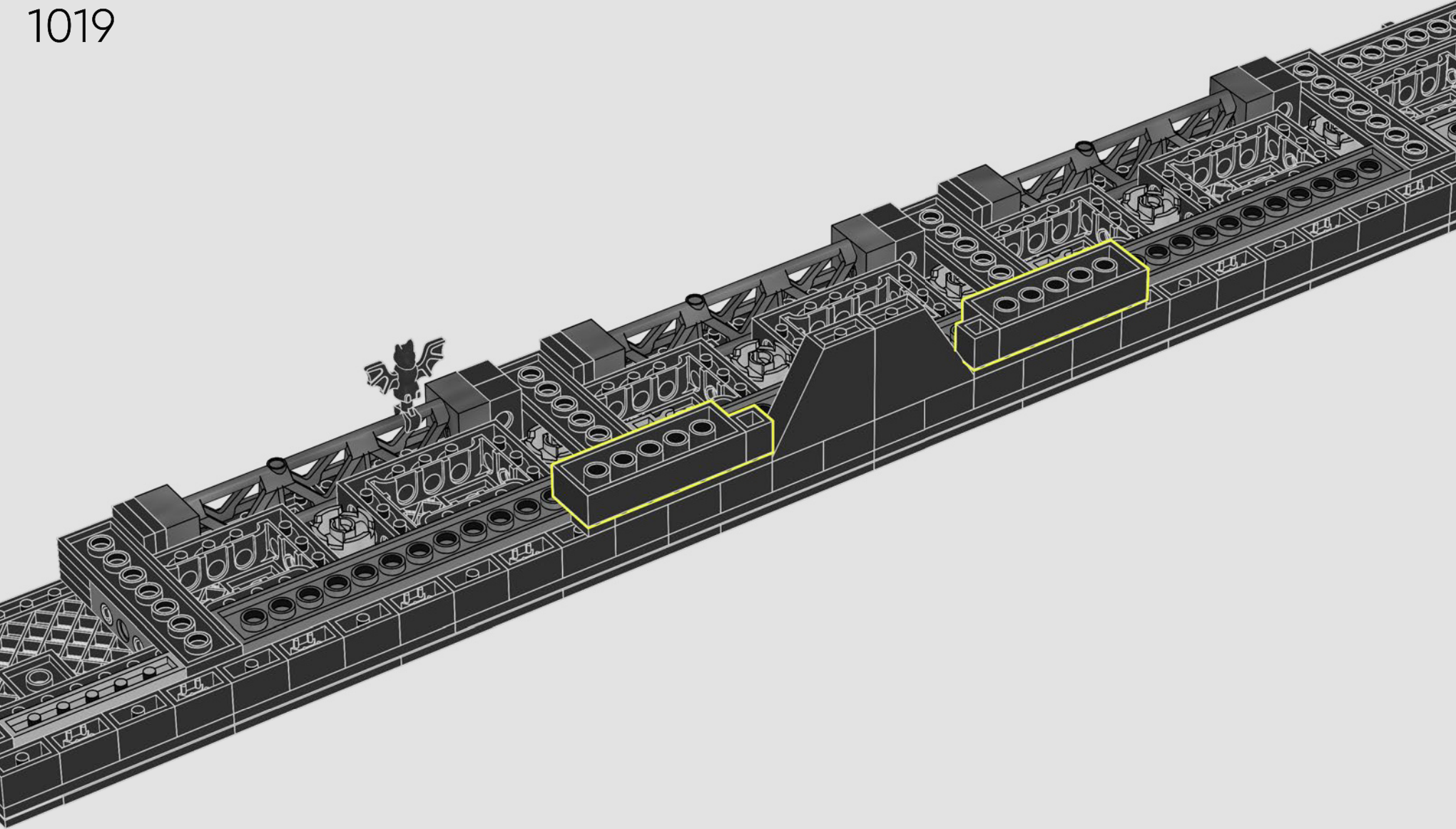



1020

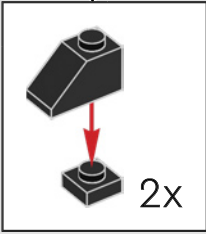
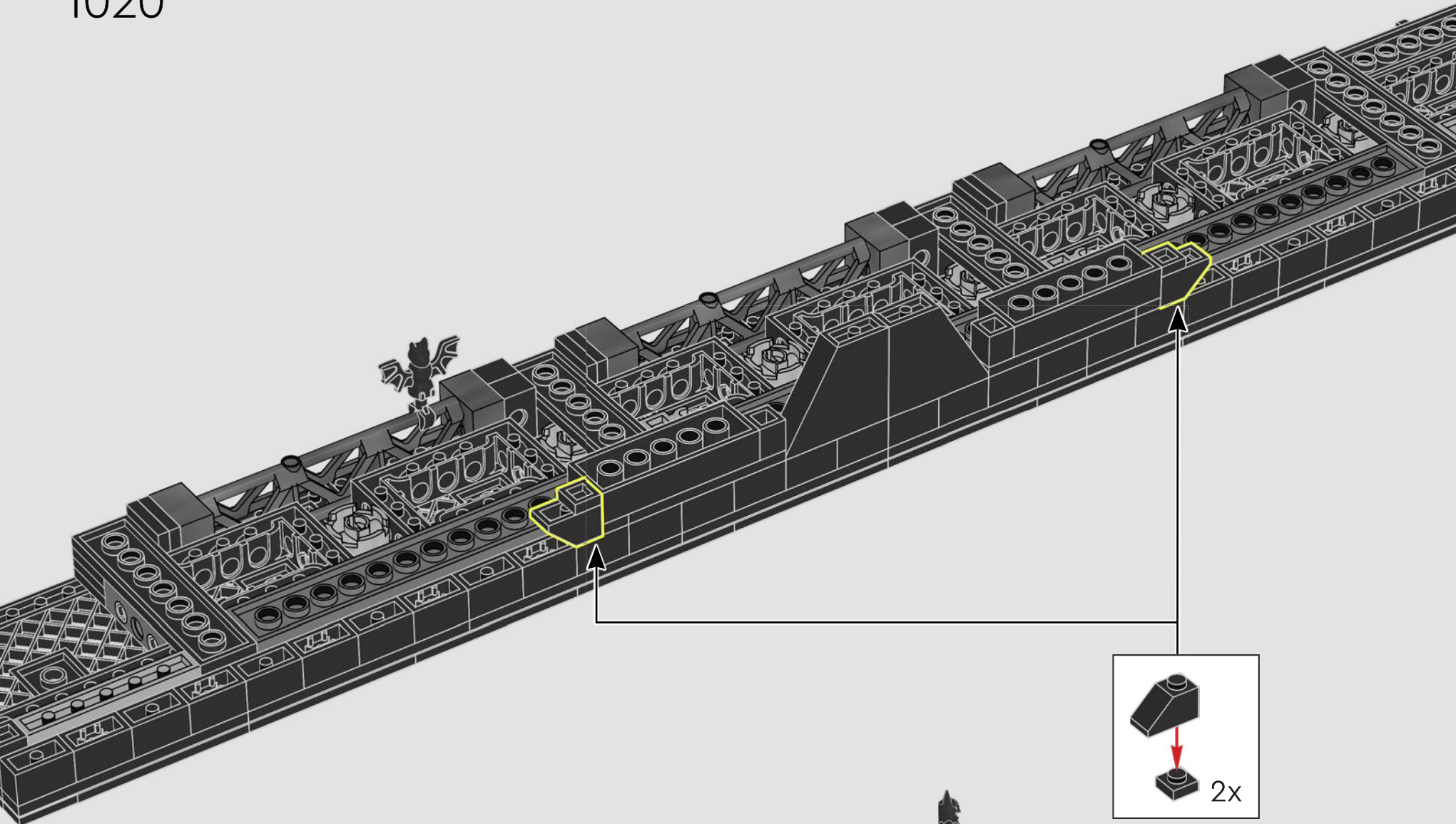

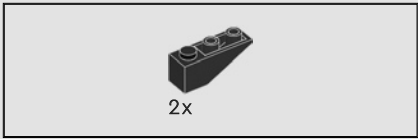

1021

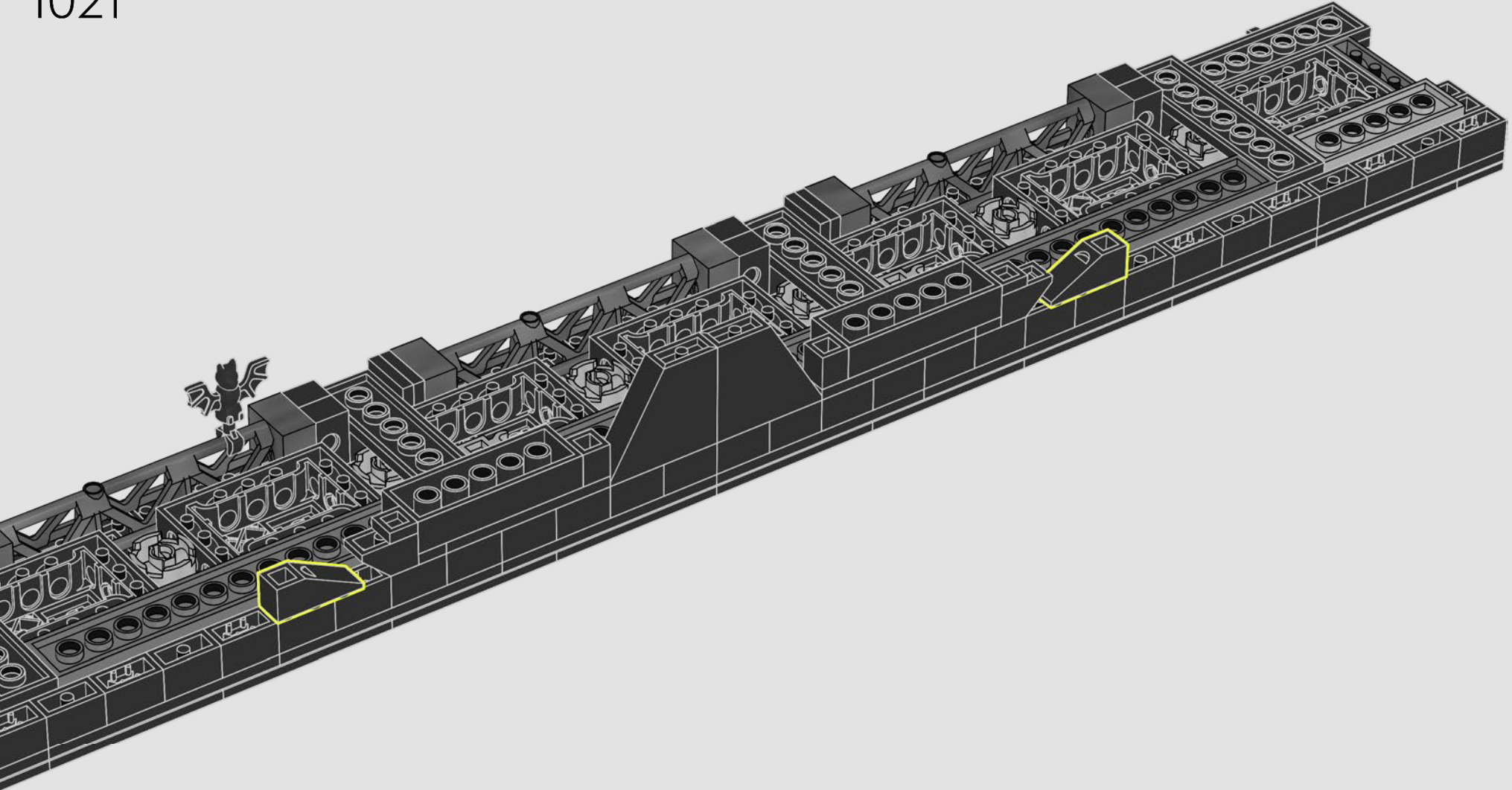



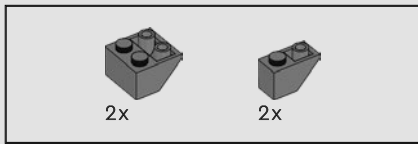

1022

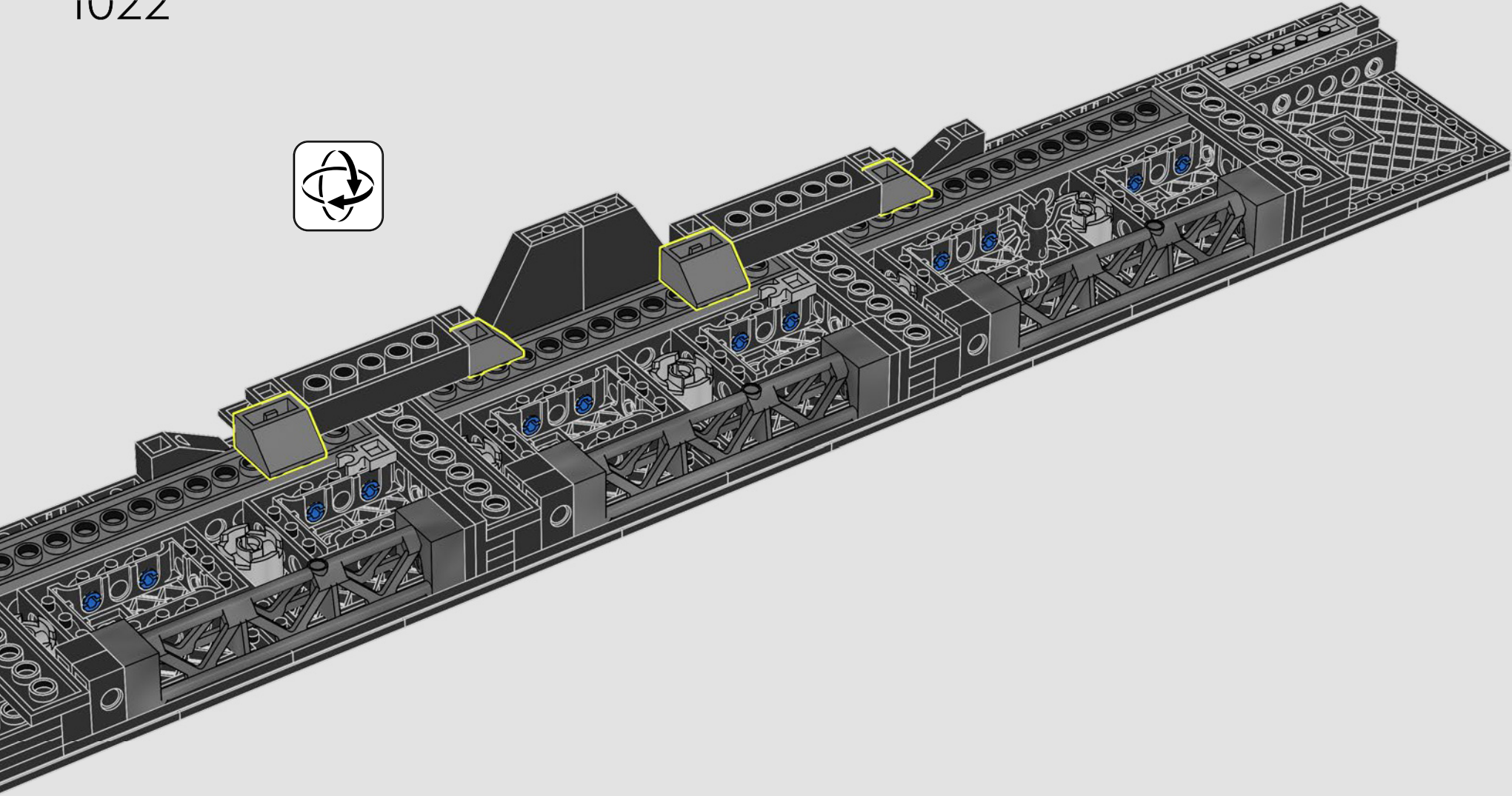

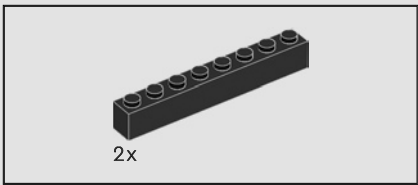

1023

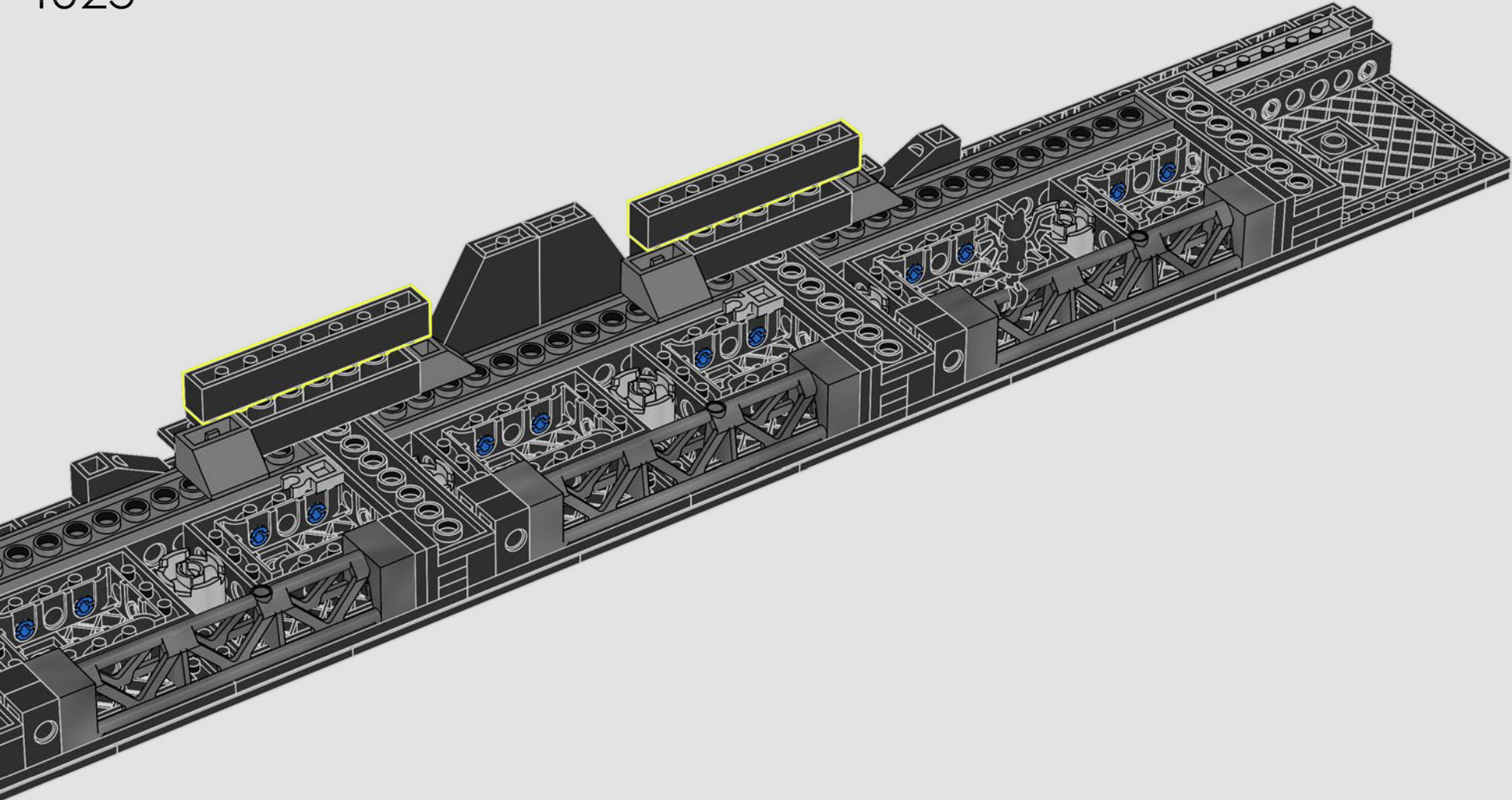



1024

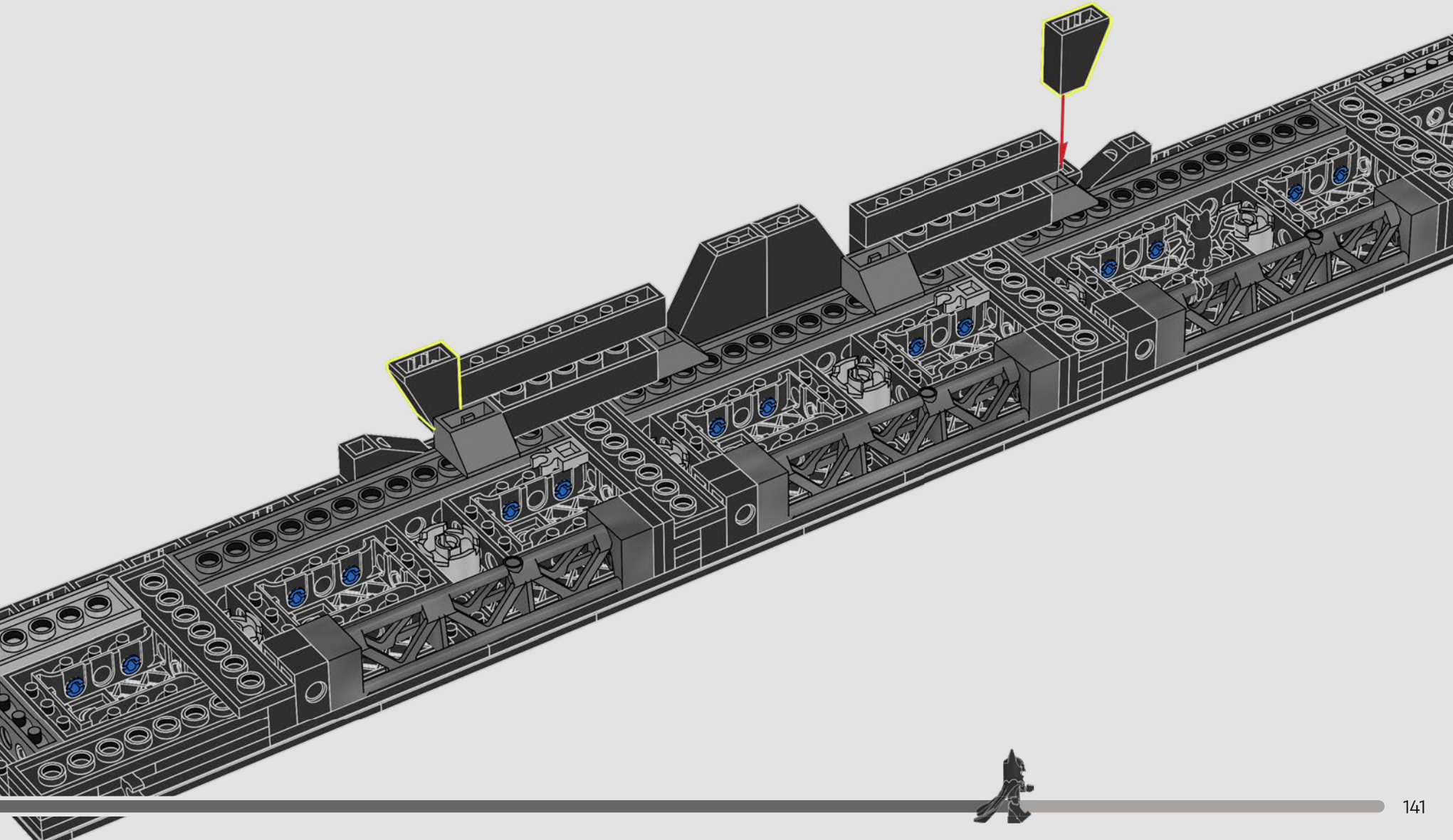



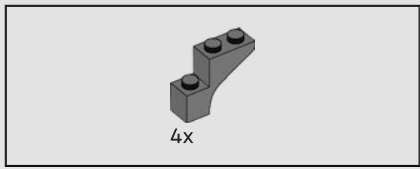

1025

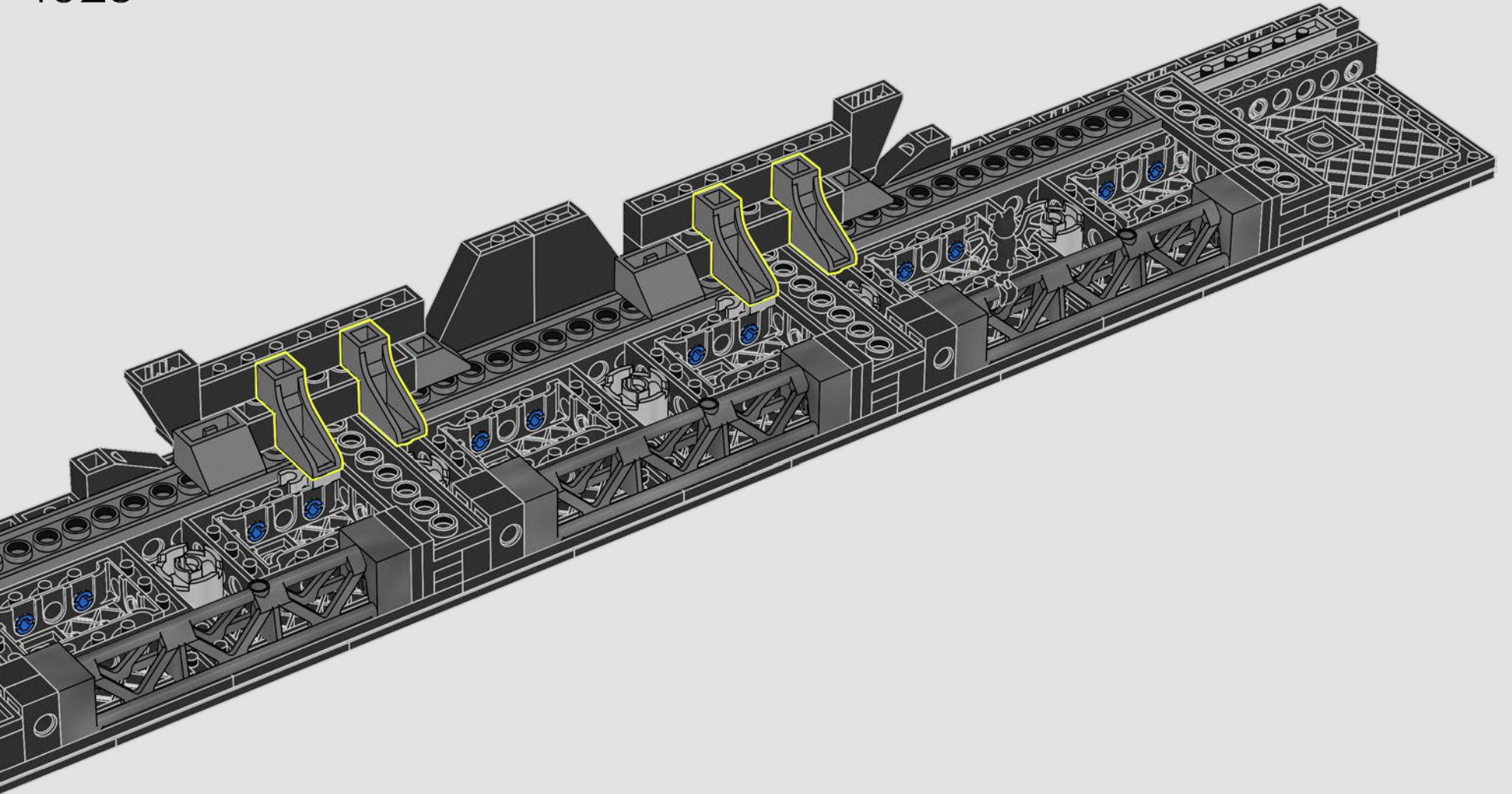

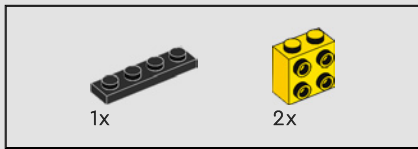

1026

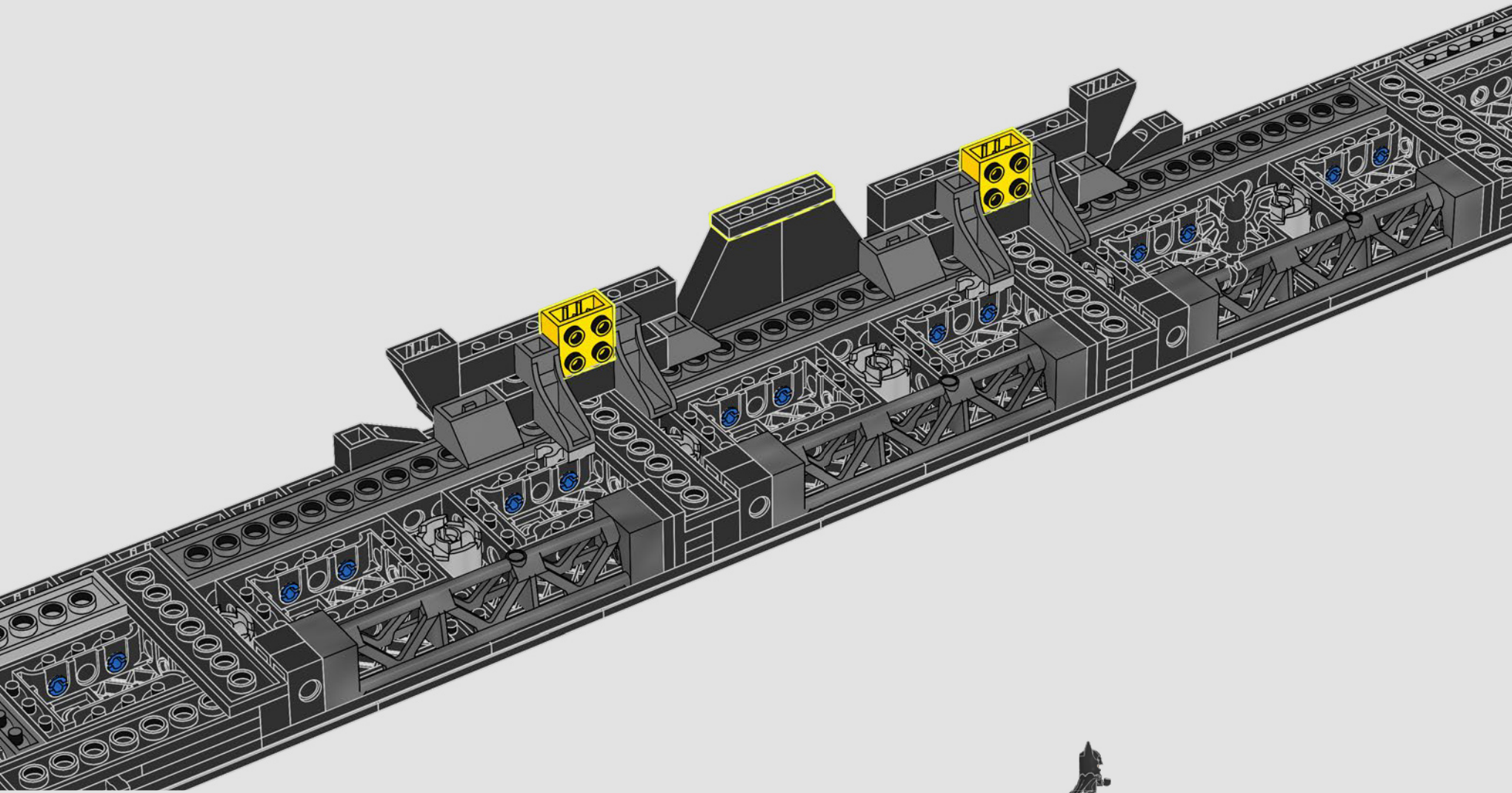

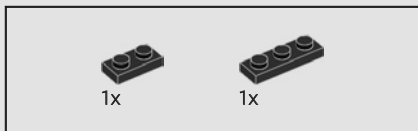

1027

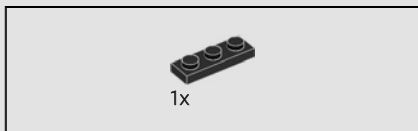
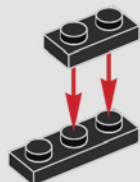

1028

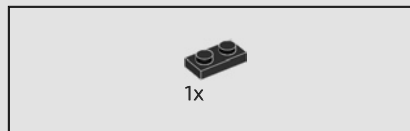
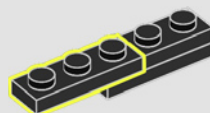

1029

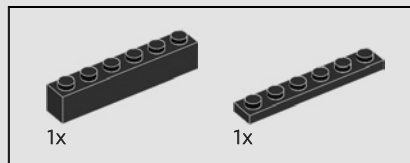
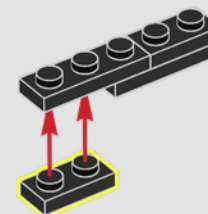

1030

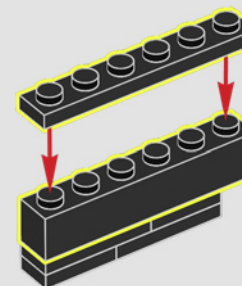



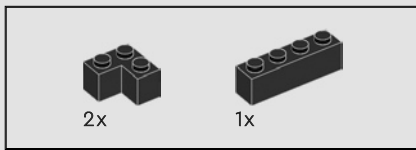

1031

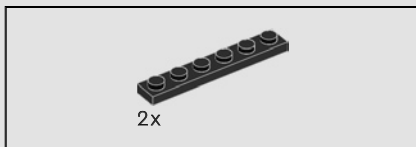
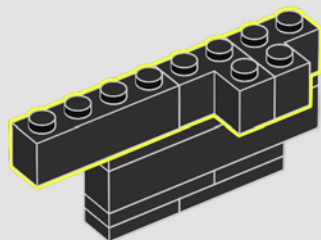

1032

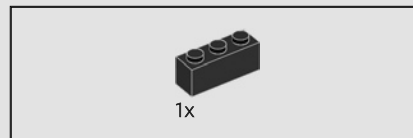
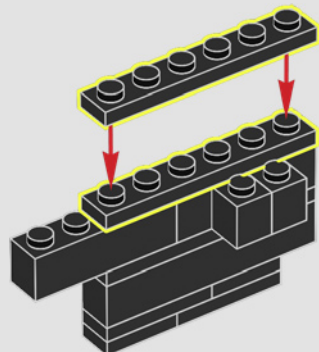

1033

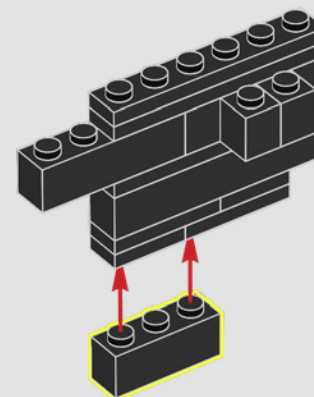

1034

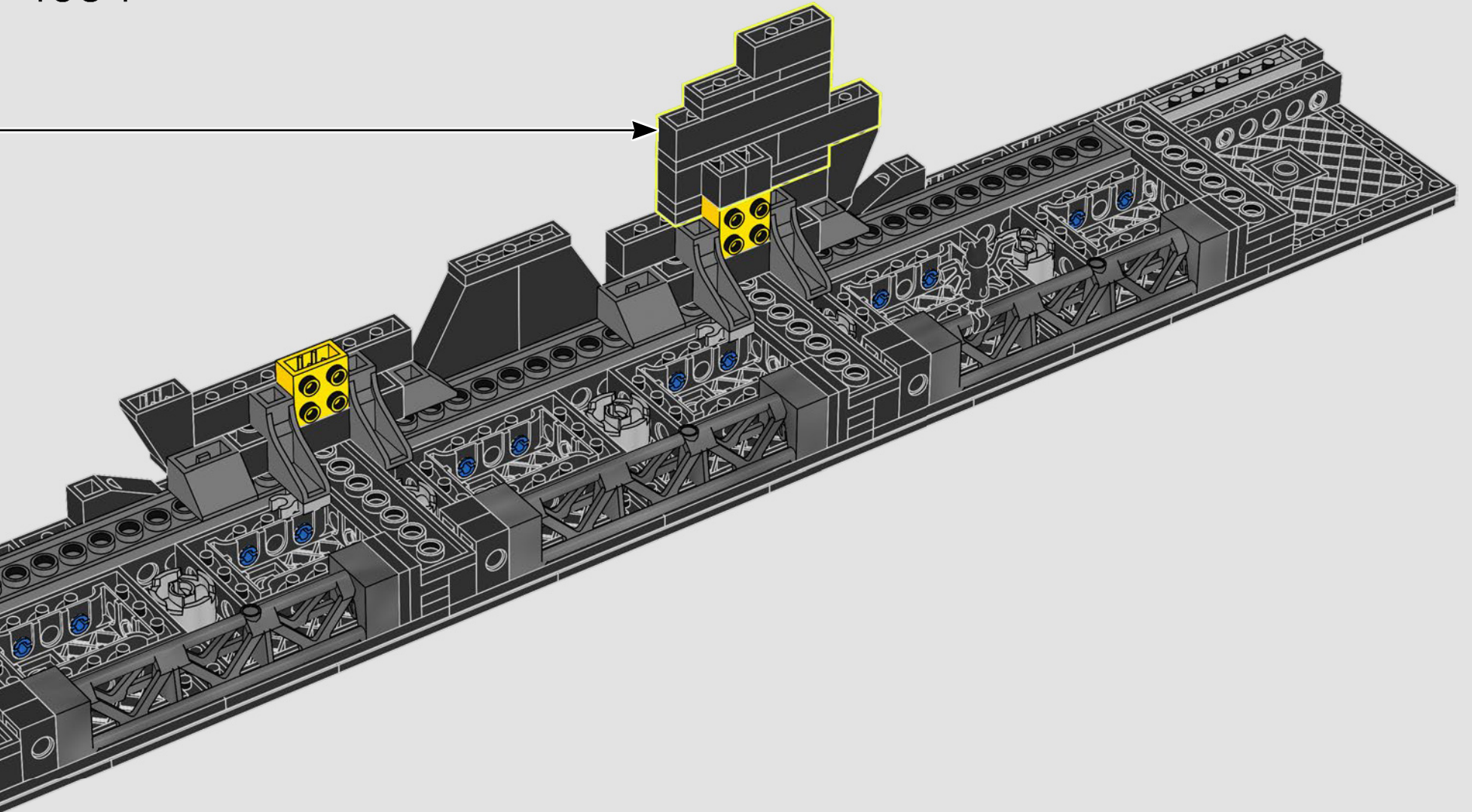

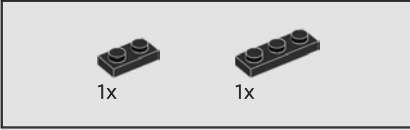
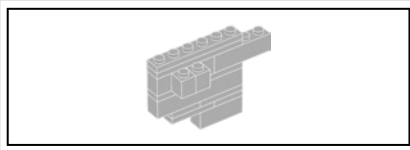

1035

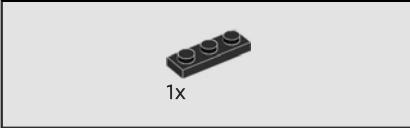
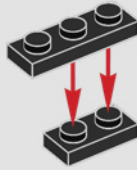

1036

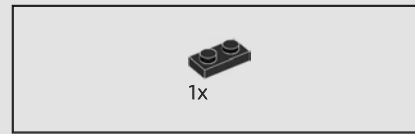
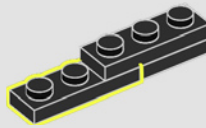

1037

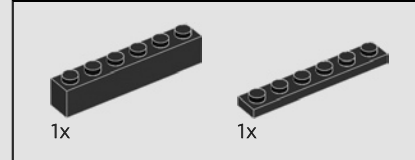
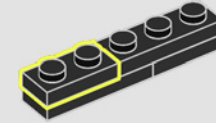

1038

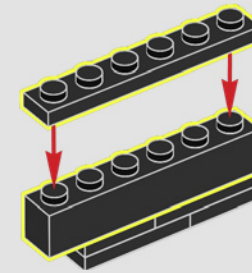



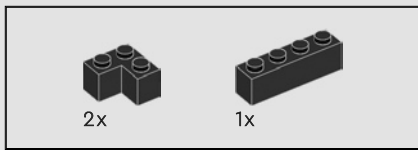

1039

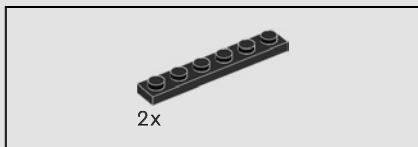
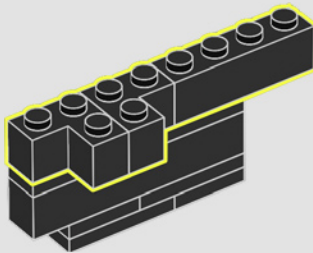

1040

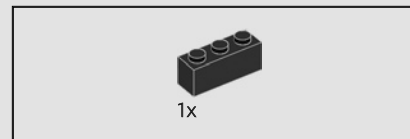
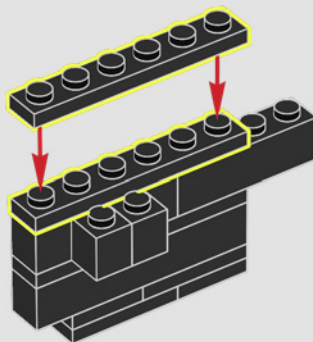

1041

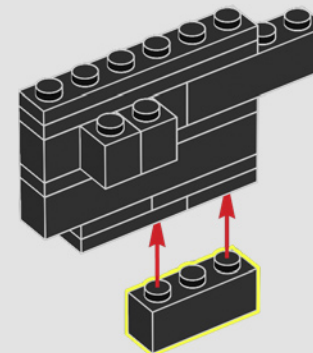

1042

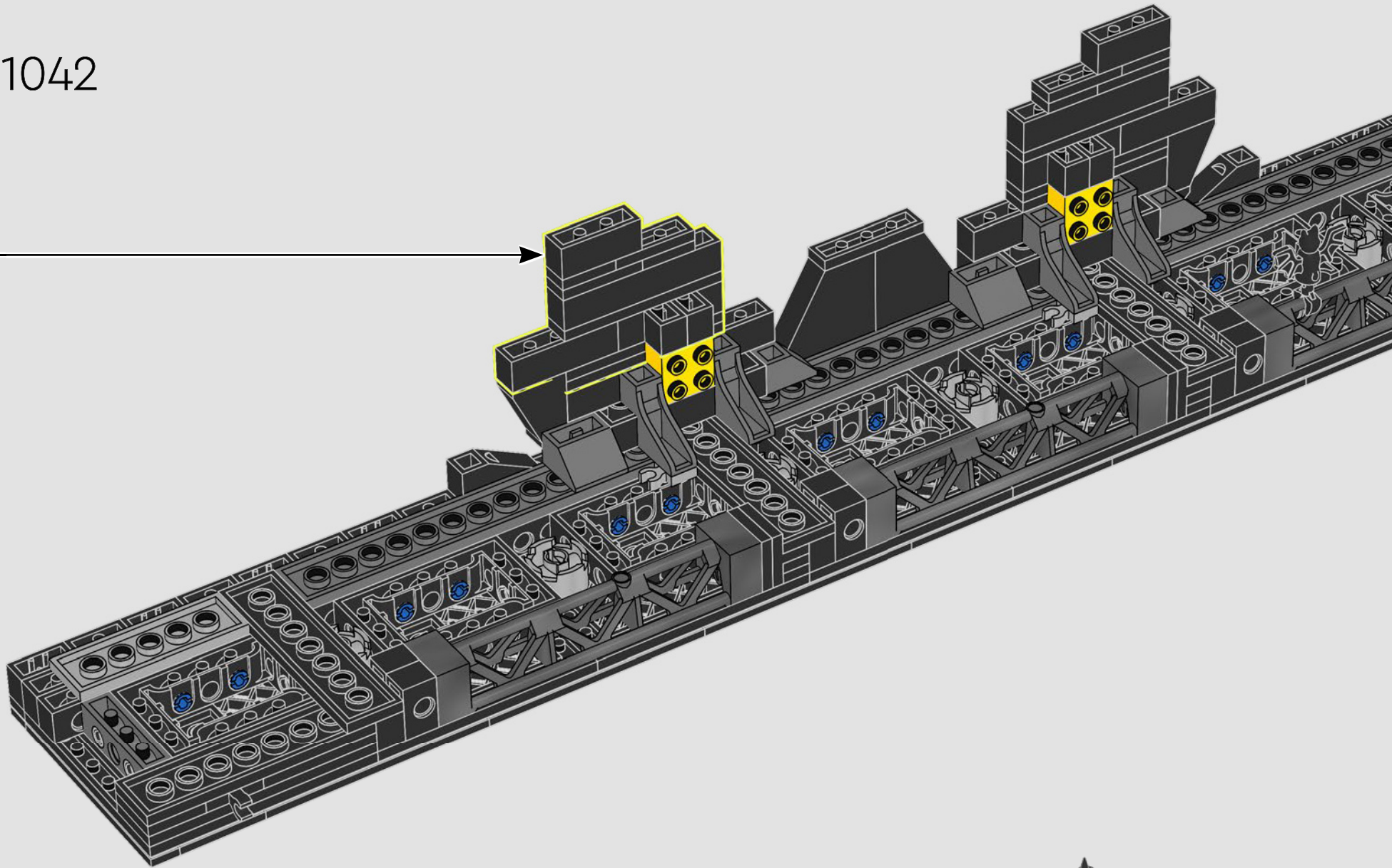



4x

1043

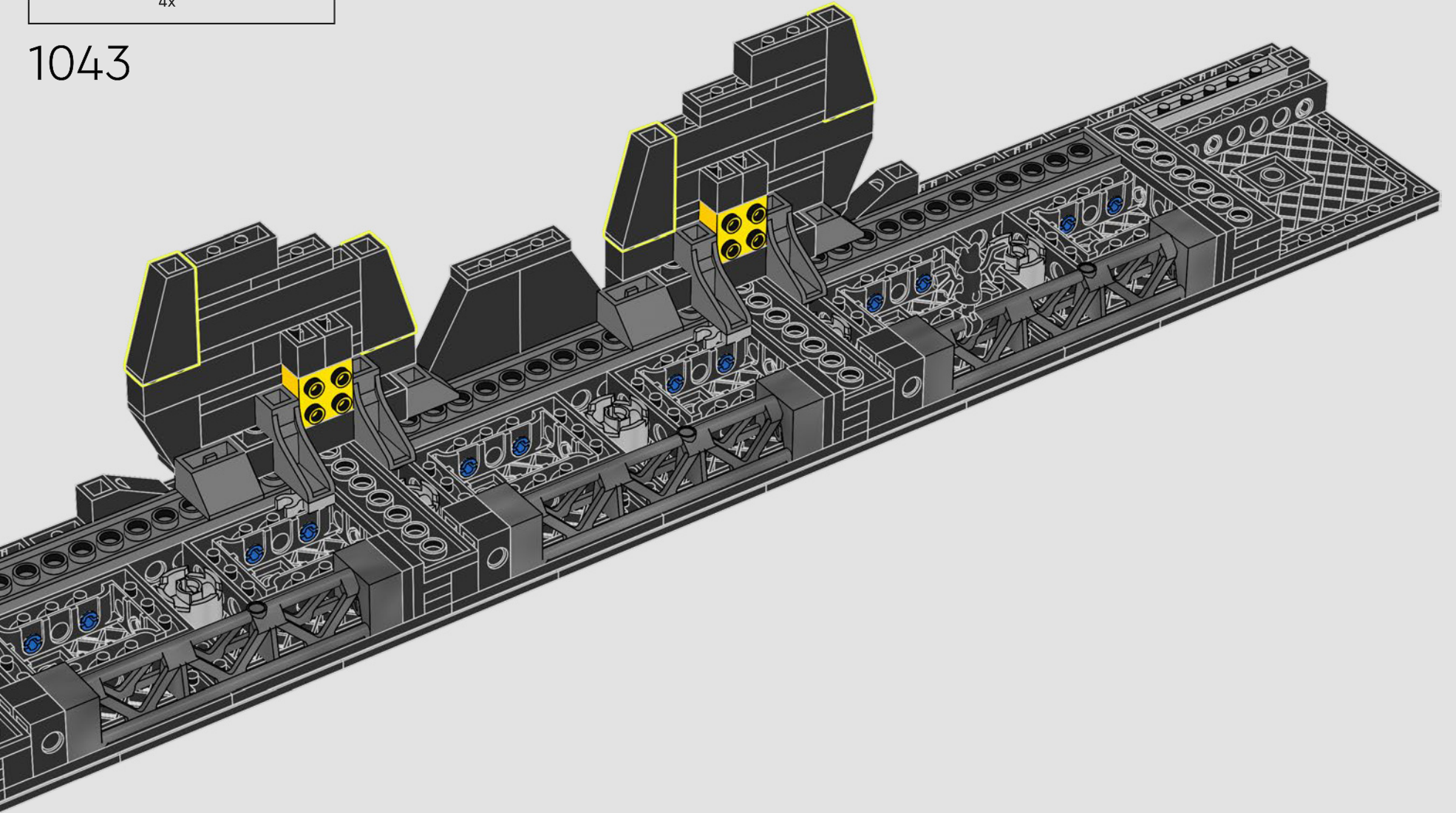



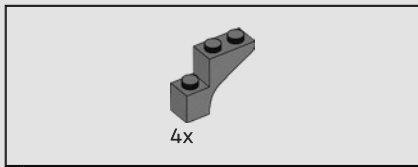

1044

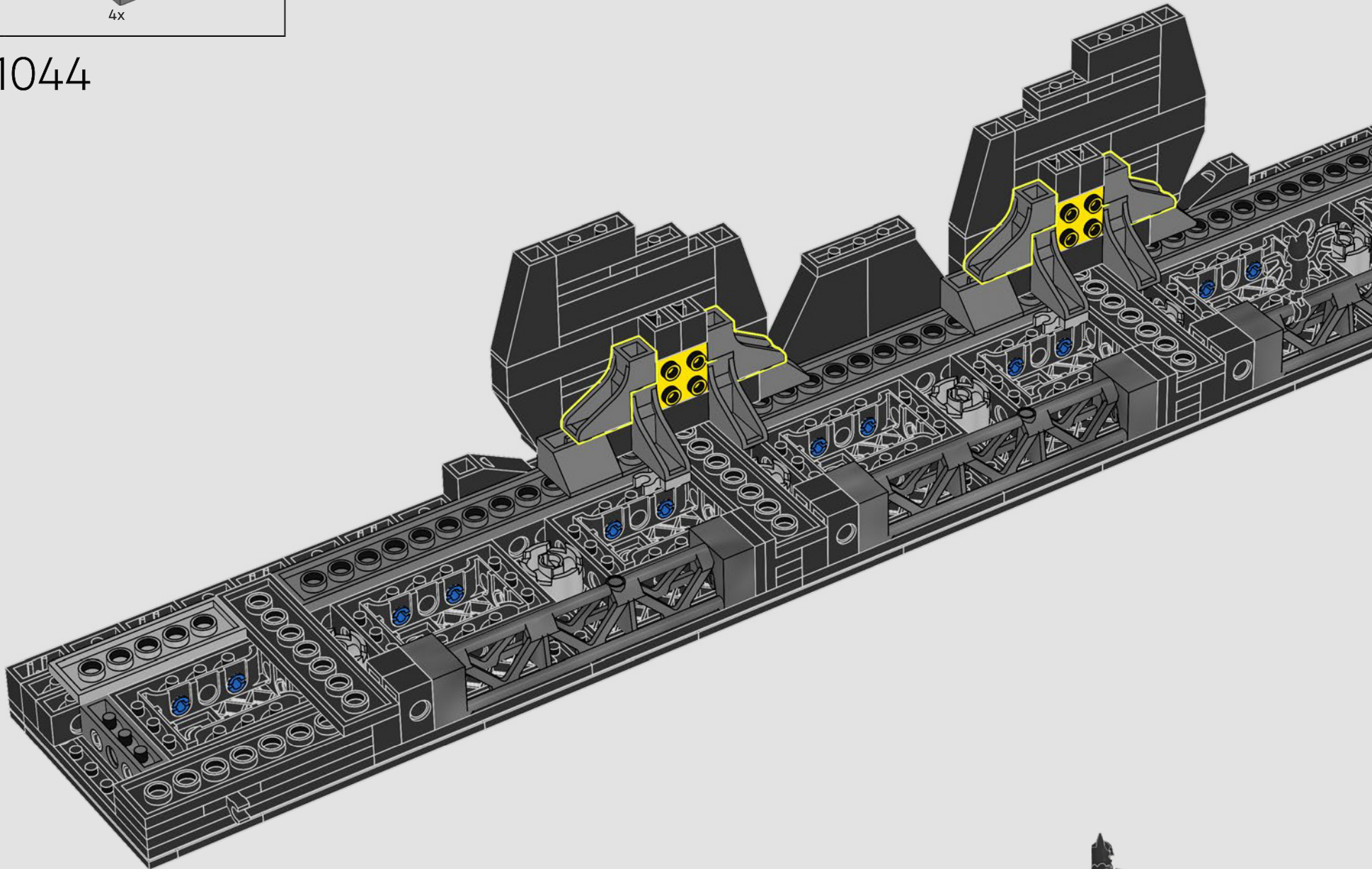

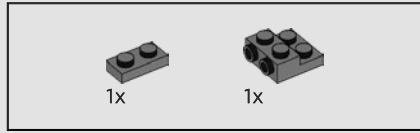
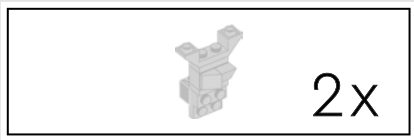

1045

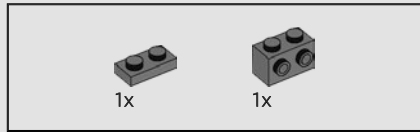
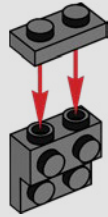

1046

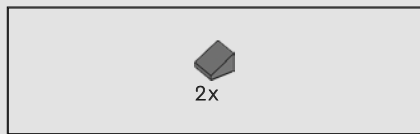
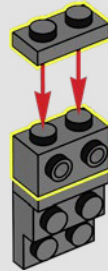

1047

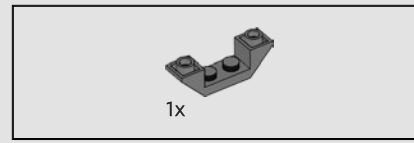
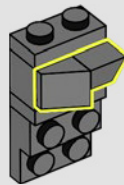

1048

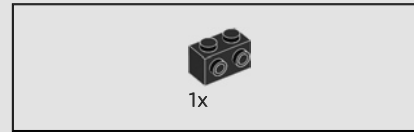
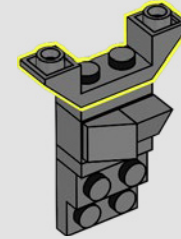

1049

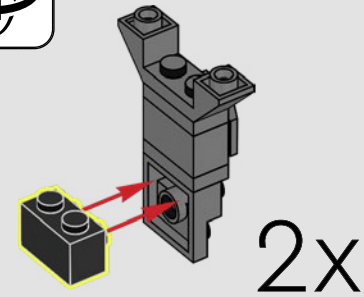
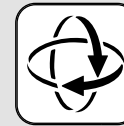

1050

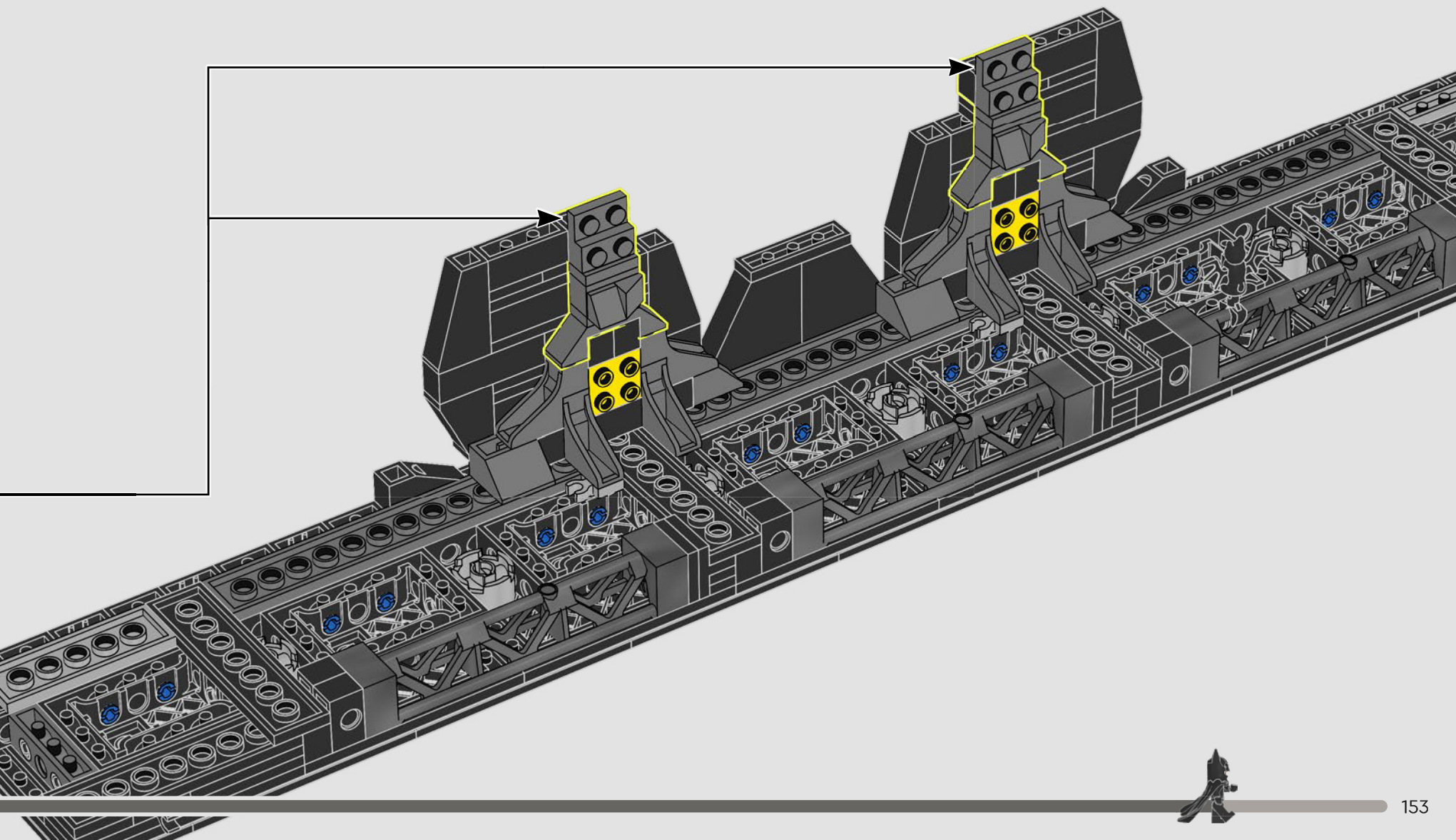



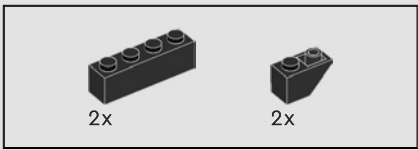

1051

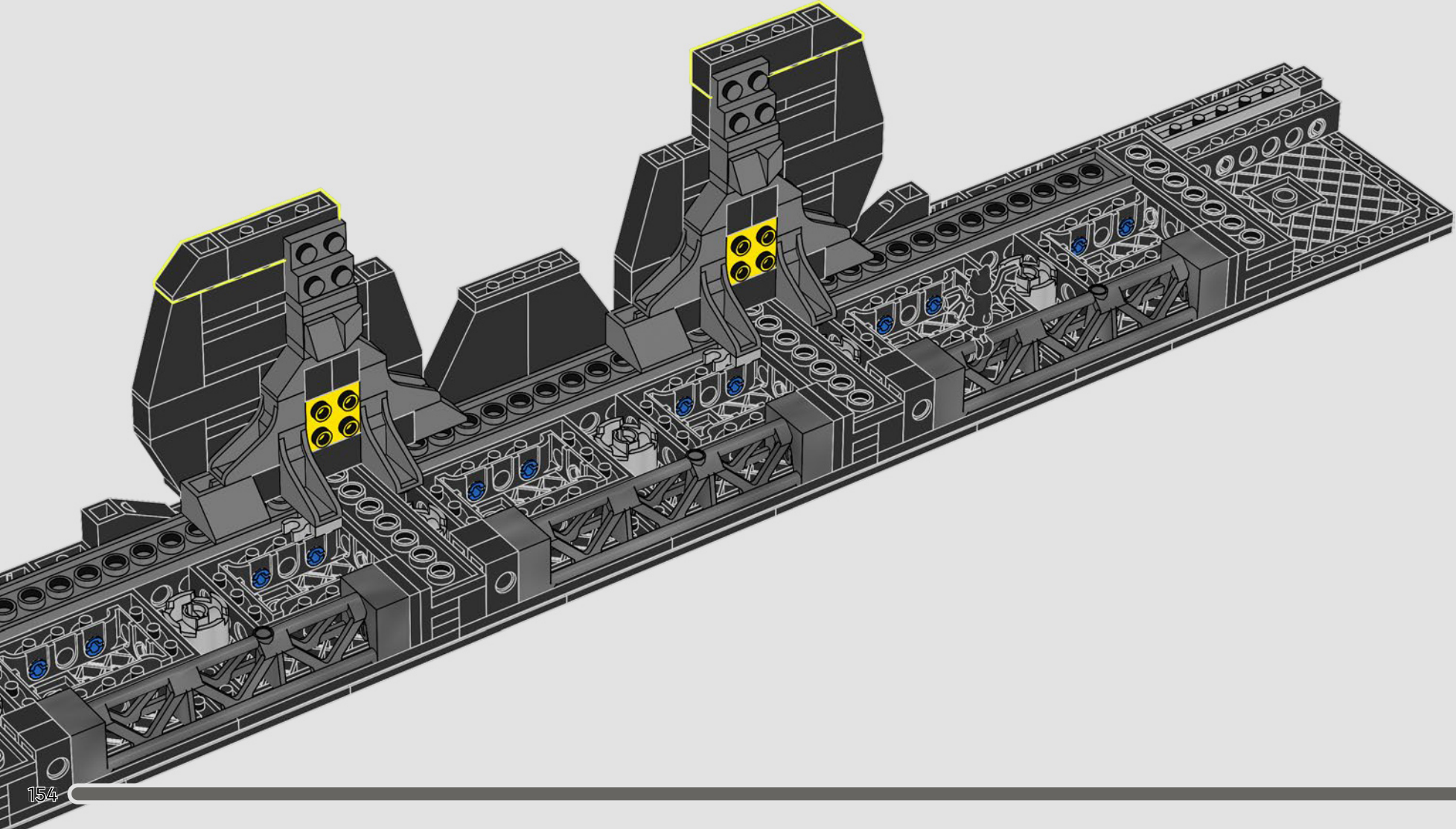

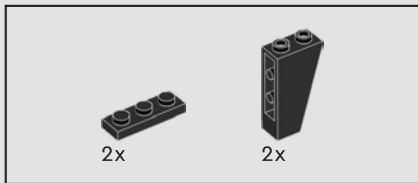

1052

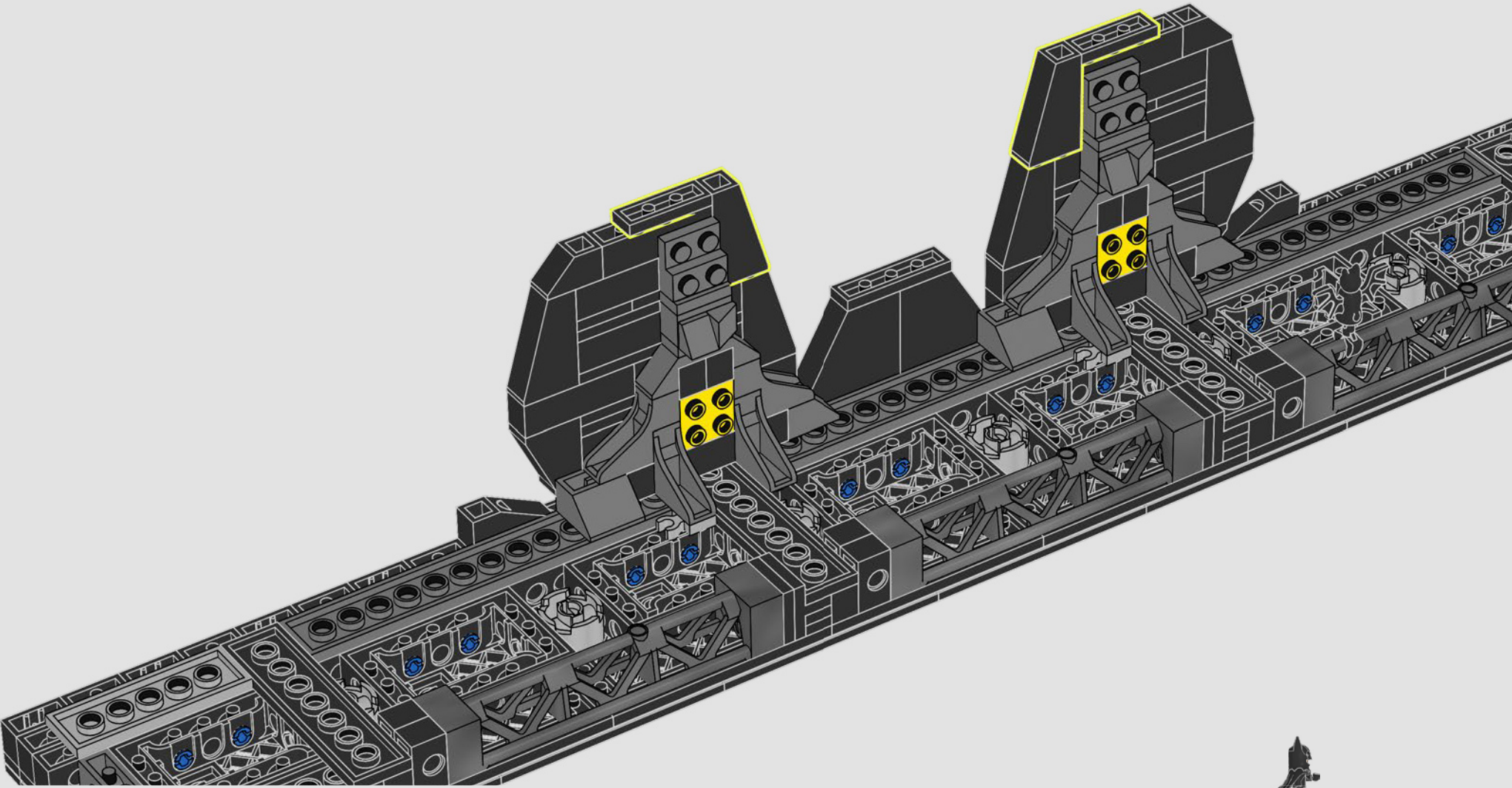



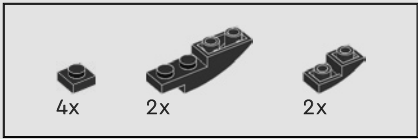

1053

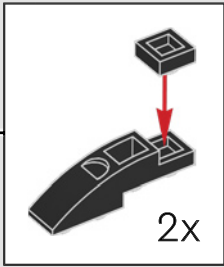
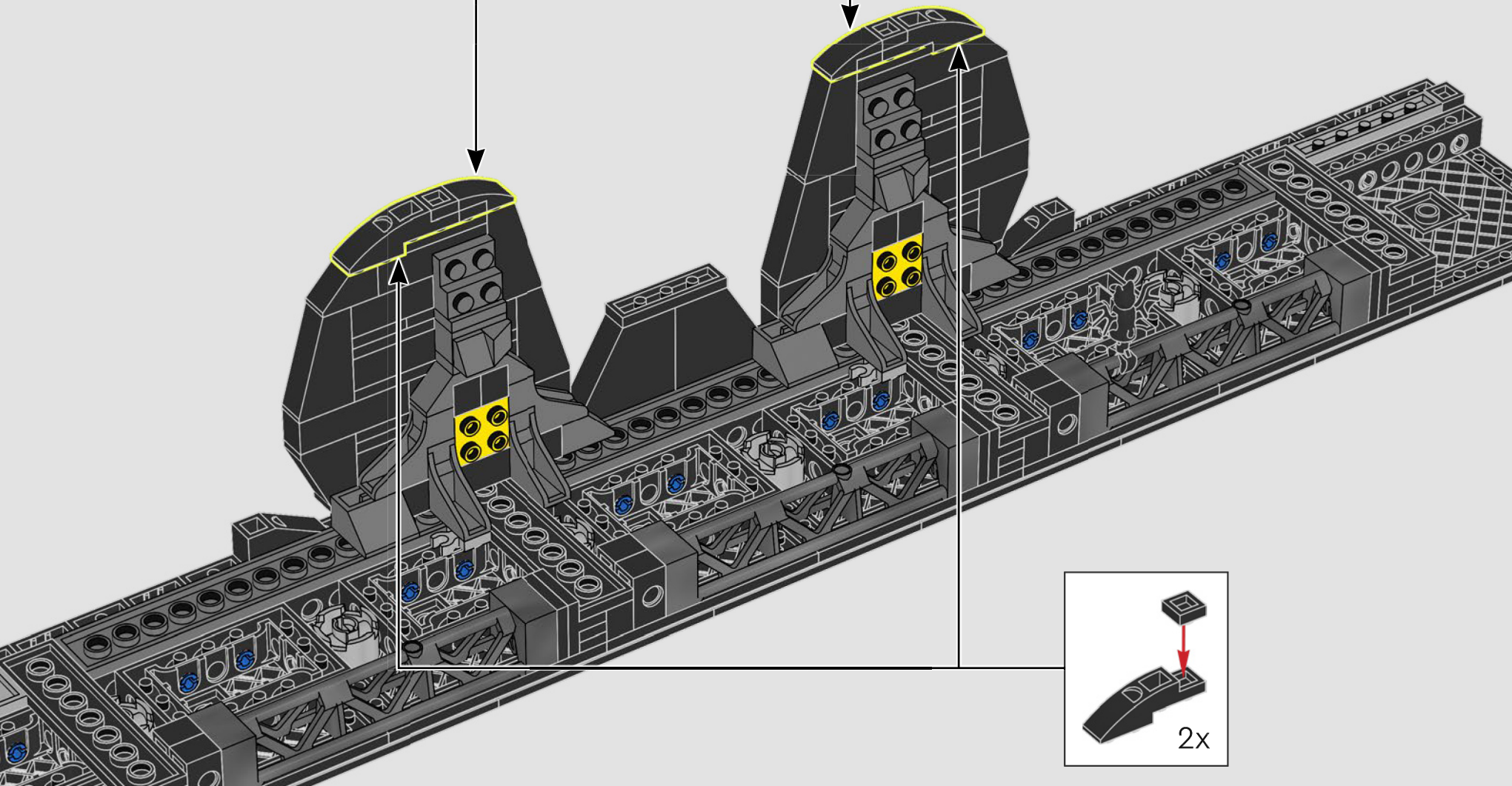
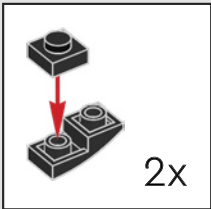



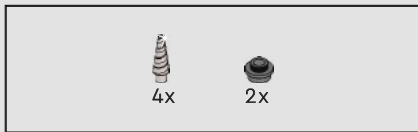

1054

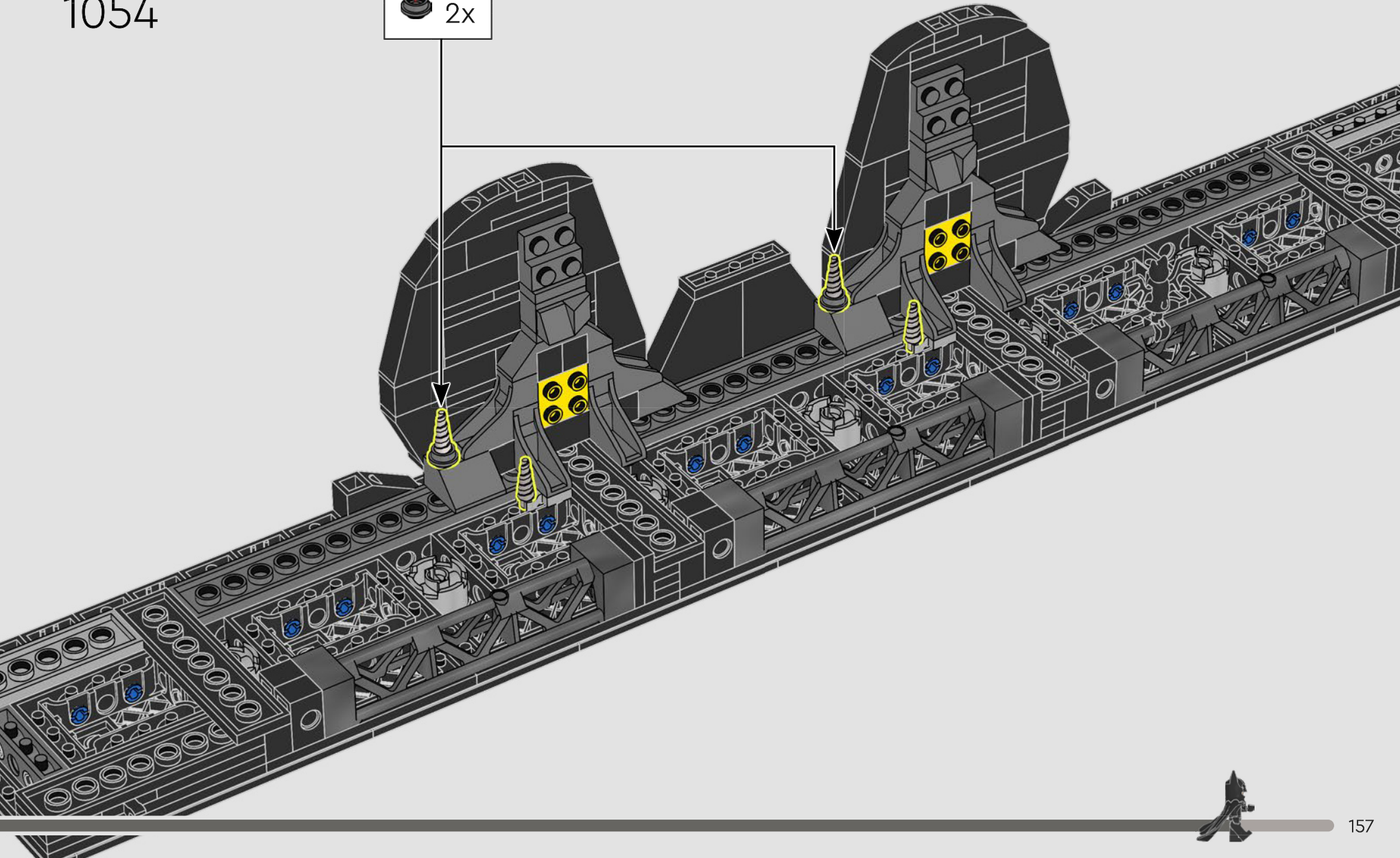
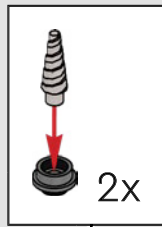

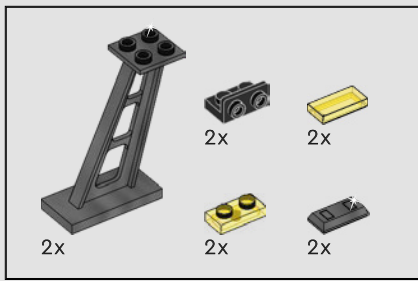

1055

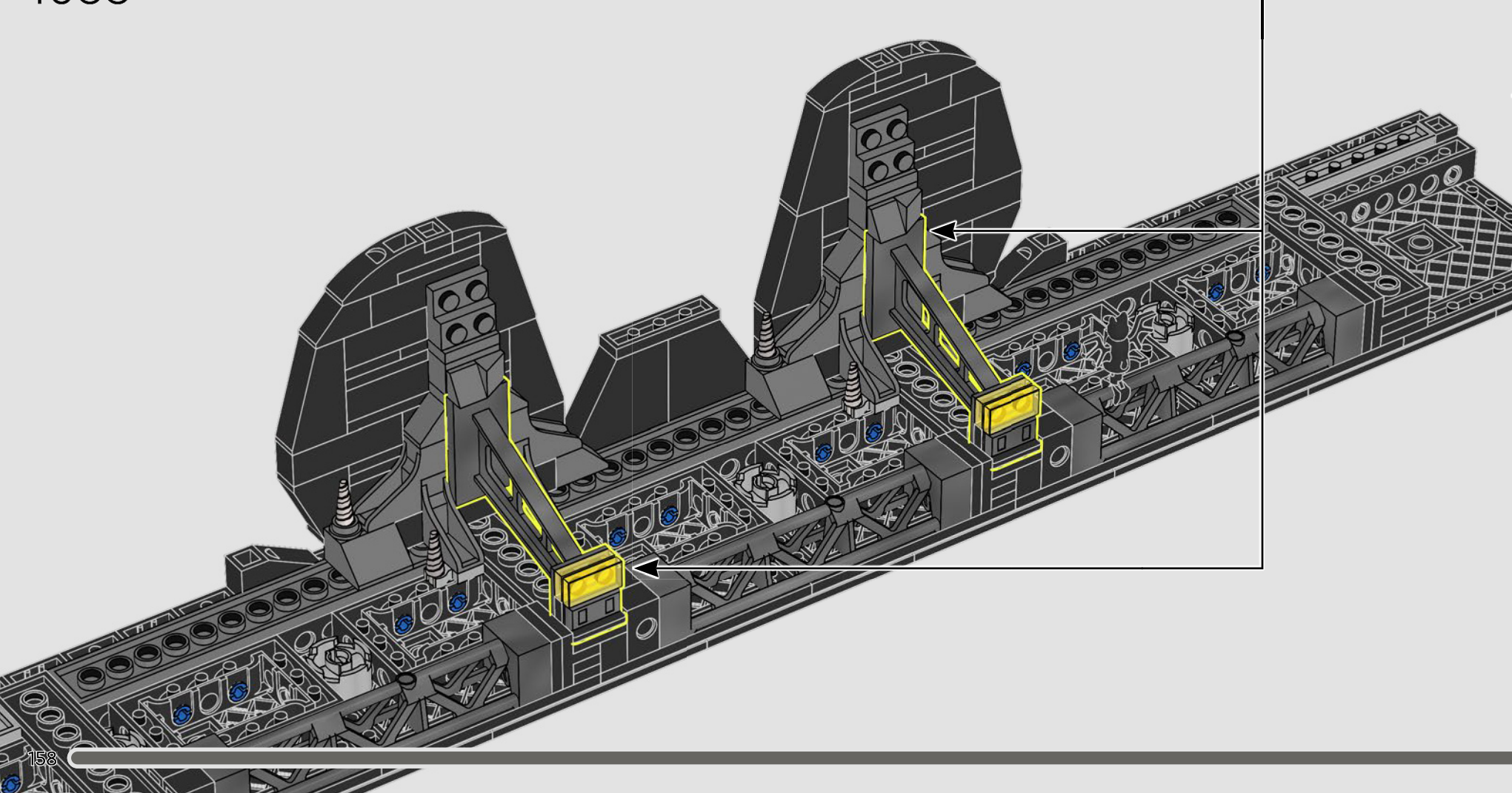
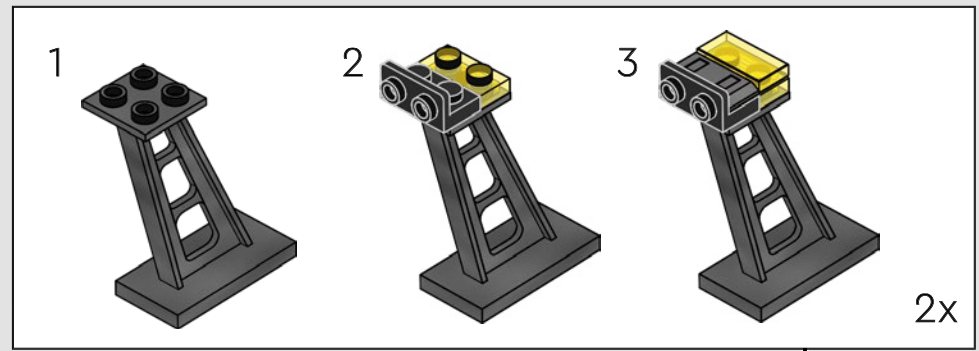



1056

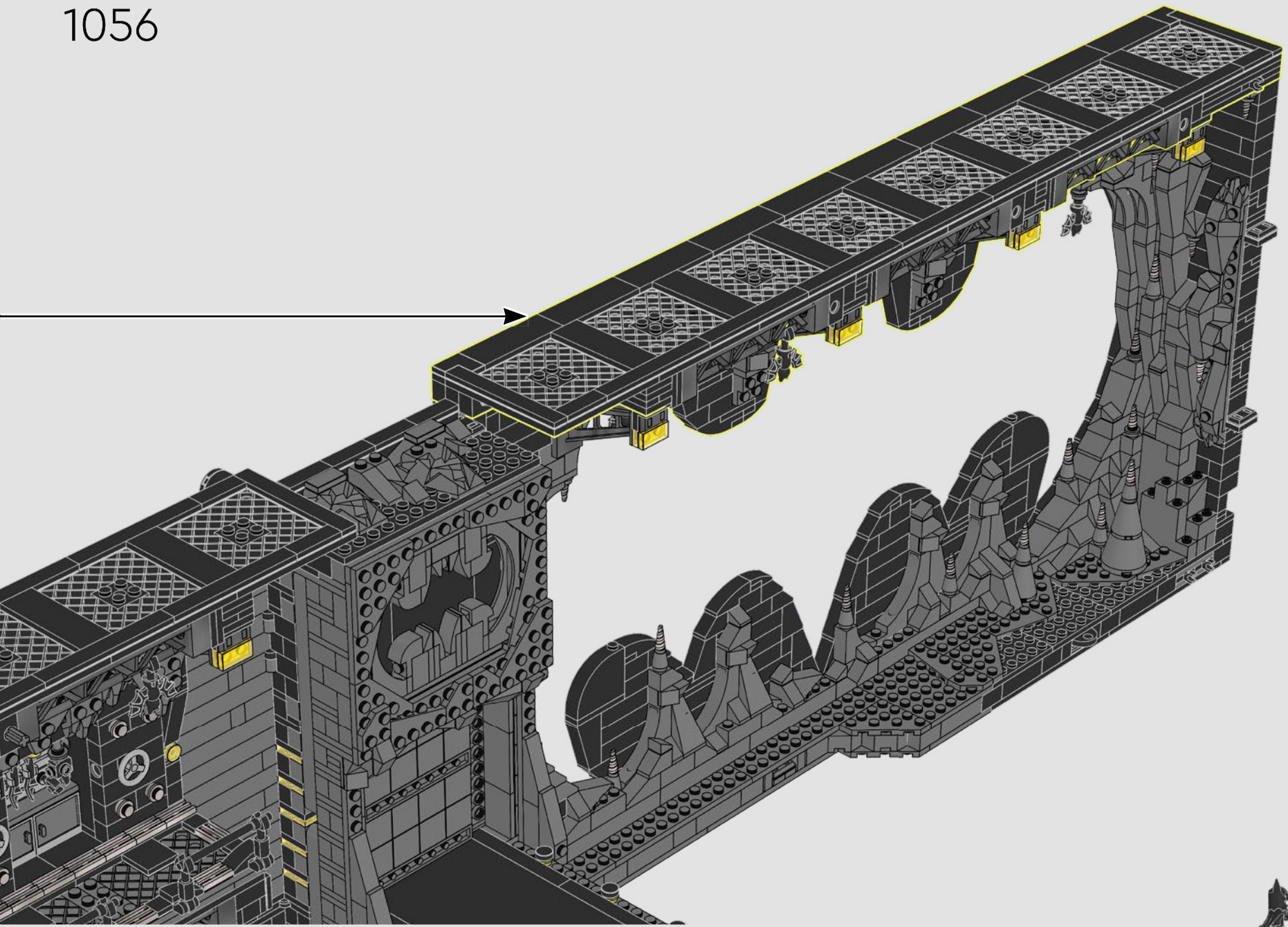



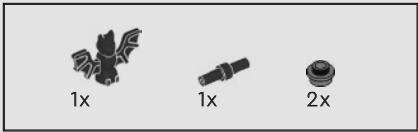

1057

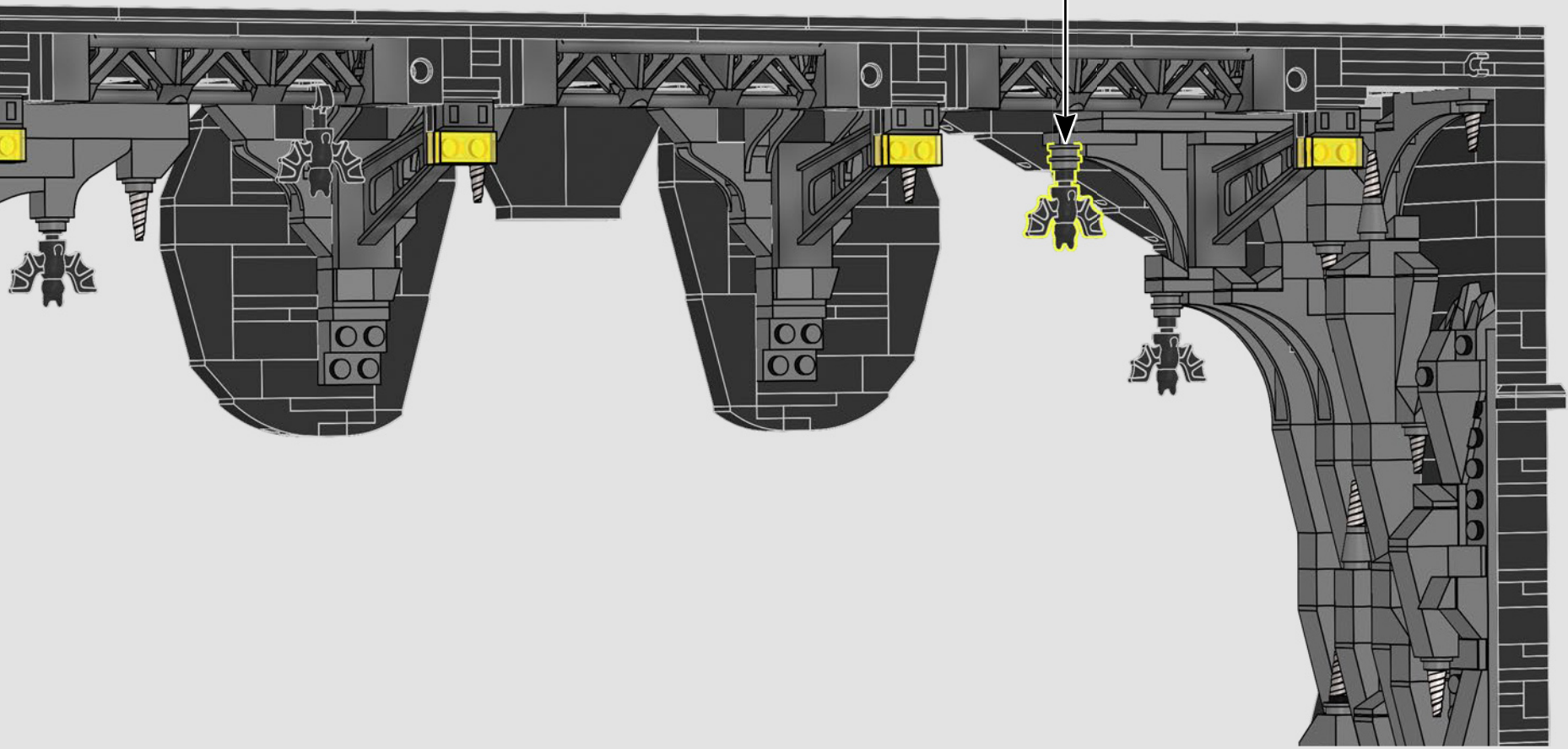
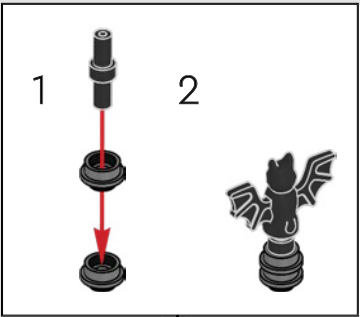

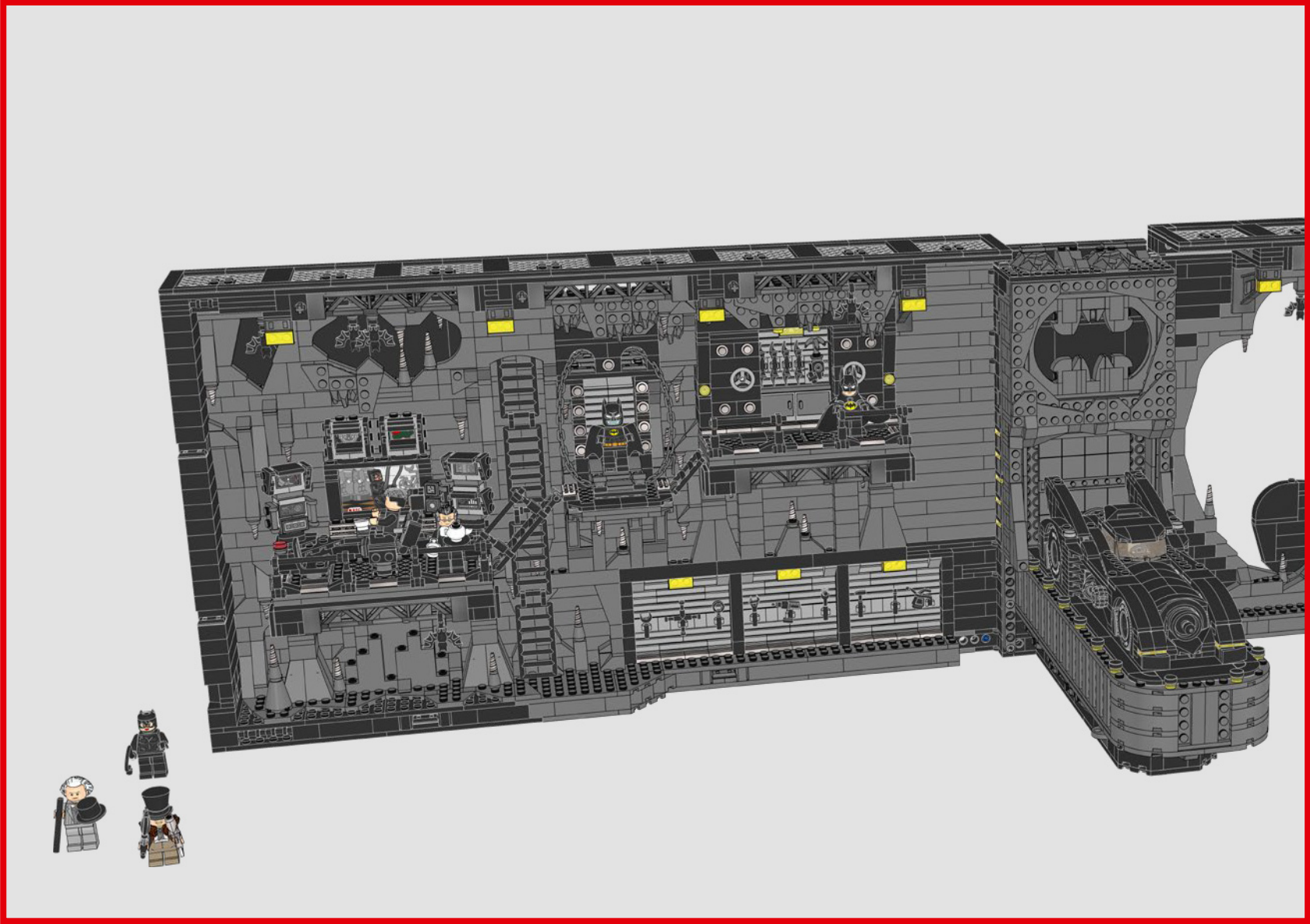

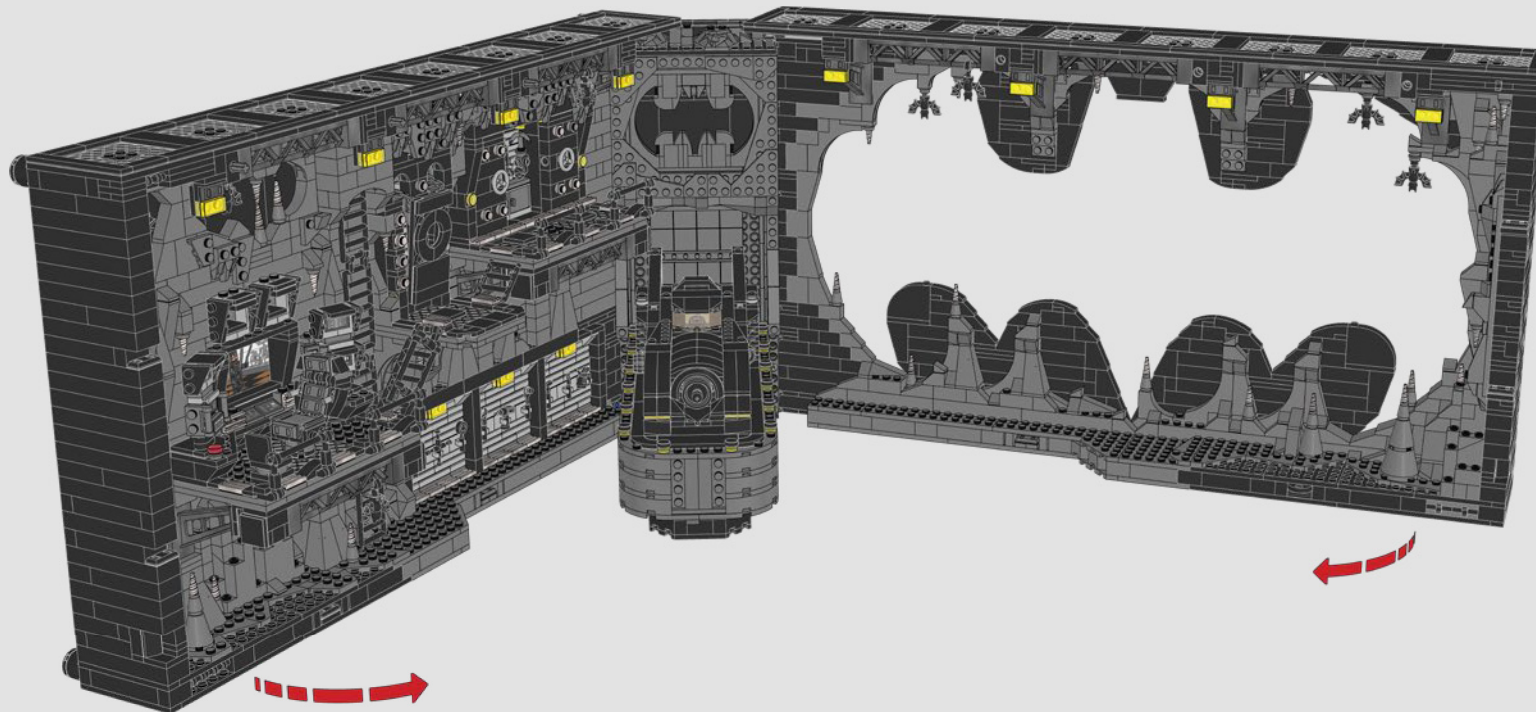

## HOW TO OPEN AND CLOSE THE SHADOW BOX

Pull the finger grooves on the lower left side of the Shadow Box (seen from the front) to open the box, partially or fully, and expand the display.

## COMMENT OUVRIR ET FERMER LA BOÎTE-CADRE

Tirez les rainures des doigts sur le côté inférieur gauche de la Boîte-cadre (vue de face) pour ouvrir la boîte, partiellement ou complètement, et agrandir l'écran.

## CÓMO ABRIR Y CERRAR LA CAJA SOMBRÍA

Coloca los dedos en las ranuras de la parte inferior izquierda de la Caja Sombría (vista por el frente) y sepáralos para abrir la caja parcial o totalmente y desplegar la exhibición de su interior.



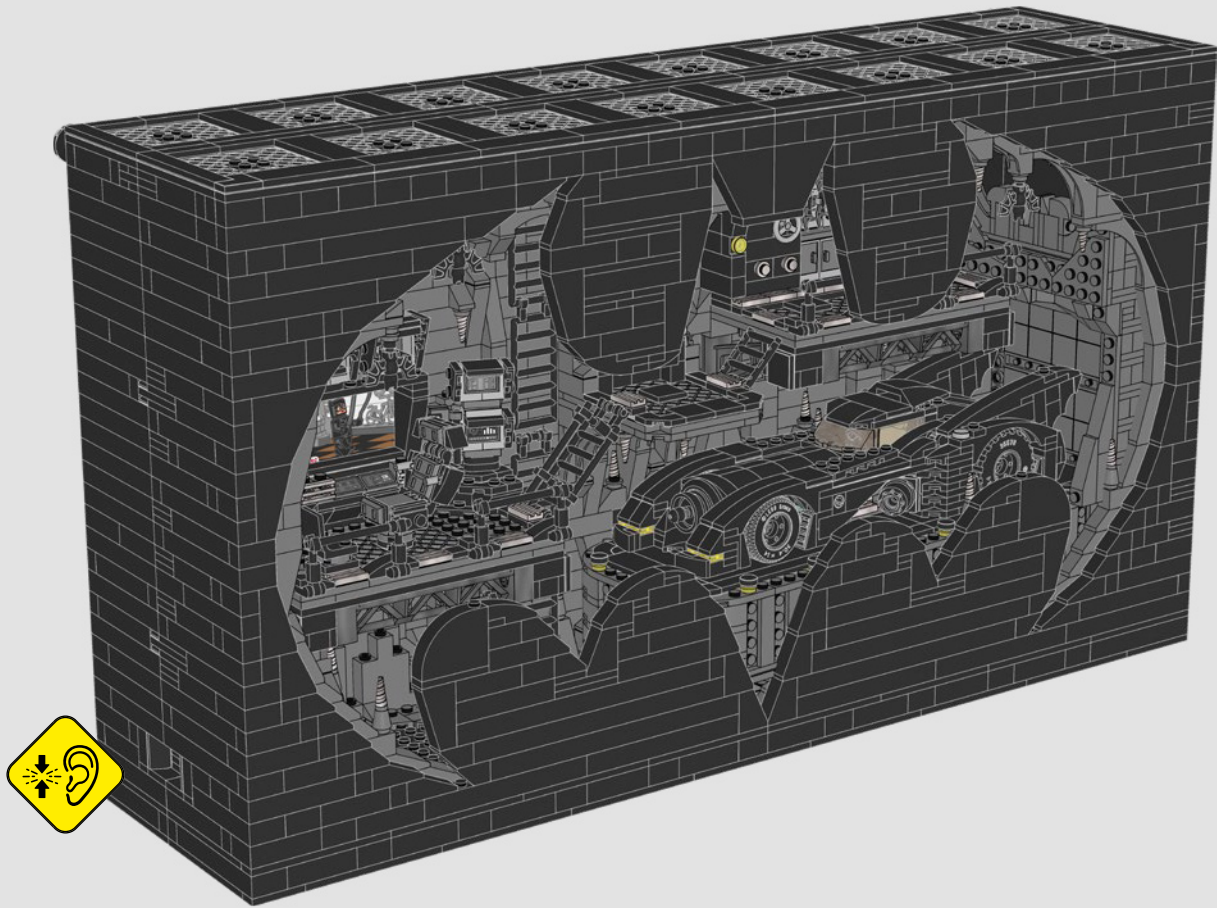

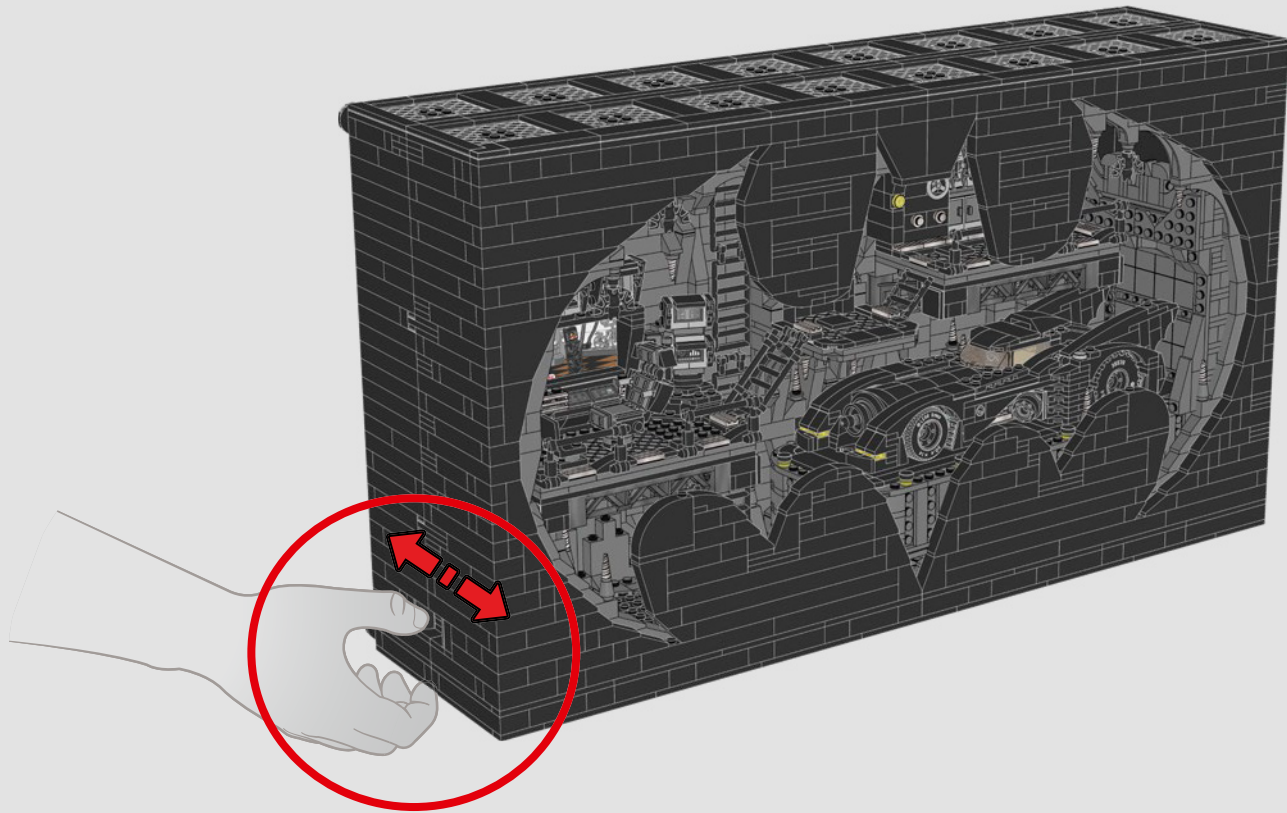

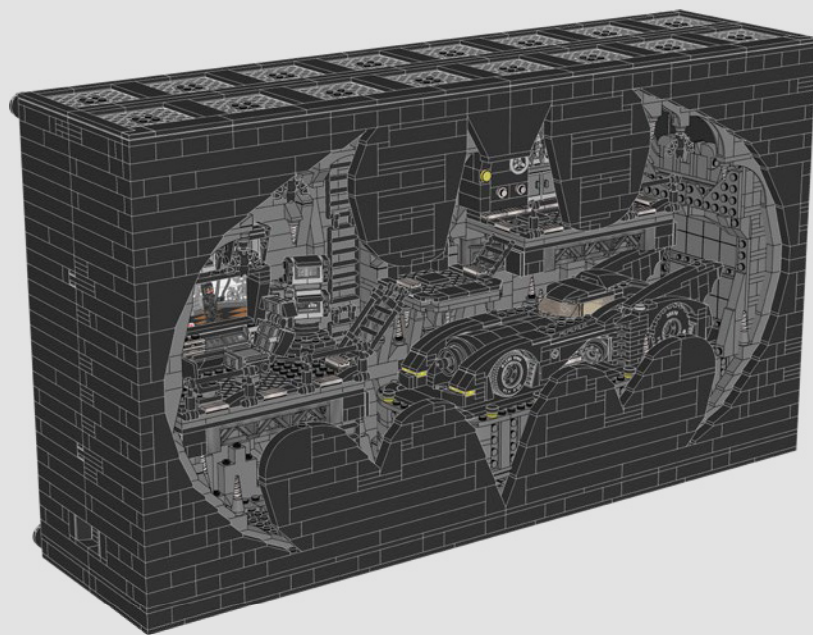

## A LEGENDARY LOGO

The legendary silhouette logo is one of the most recognized and beloved Super Hero icons ever. Simultaneously a cover and a window to the secret life and workings of Bruce Wayne™ and his caped crusader alter ego, it frames the model in a powerful mystery.

## UN LOGO LÉGENDAIRE

Le logo légendaire de la silhouette de chauve-souris est l'une des icônes de superhéros les plus reconnues et les plus appréciées. À la fois couverture et fenêtre sur la vie et les activités secrètes de Bruce Wayne™ et de son alter ego, le modèle est entouré d'un puissant mystère.

## UN LOGOTIPO LEGENDARIO

El legendario logotipo es uno de los íconos de más reconocidos y queridos de la historia de los superhéroes. Una cubierta y una ventana a la vida y el trabajo secretos de Bruno Díaz y su encapuchado alter ego, enmarca el modelo en un poderoso halo de misterio.





## EN

### Important information about batteries

Never use different types of batteries together, or a combination of old and new batteries. Always remove the batteries if the product is not to be used for a long time or if the batteries have run down. Never use damaged batteries. Only use alkaline type batteries. Insert the batteries so that the poles are correctly positioned. Never attempt to recharge non-rechargeable batteries. Never short-circuit the battery holder.

## DE

### Wichtige Informationen zu Batterien

Benutzen Sie niemals unterschiedliche Arten von Batterien oder alte und neue gleichzeitig. Nehmen Sie stets die Batterien heraus, wenn mit dem Modell längere Zeit nicht gespielt wird oder wenn die Batterien leer sind. Verwenden Sie niemals beschädigte Batterien. Verwenden Sie ausschließlich Alkali-Batterien. Achten Sie beim Einsetzen der Batterien auf die richtige Polung. Versuchen Sie unter keinen Umständen, „normale“ Batterien wieder aufzuladen. Schließen Sie das Batteriefach niemals kurz.

## FR

### Informations importantes concernant les piles

Ne jamais utiliser un mélange de différents types de piles, ou de piles neuves et de piles anciennes ou déjà utilisées. Toujours retirer les piles si le produit n'est pas utilisé durant une période prolongée ou si les piles sont vides. Ne jamais utiliser de piles endommagées. N'utiliser que des piles alcalines. En insérant les piles, respecter scrupuleusement le sens d'orientation des pôles (+/-). Ne jamais essayer de recharger des piles non rechargeables. Ne jamais court-circuiter le compartiment des piles.

## IT

### Importanti informazioni sulle batterie

Non usare mai contemporaneamente batterie di tipo diverso o batterie nuove e usate insieme. Rimuovere sempre le batterie qualora il prodotto non venga utilizzato per periodi prolungati, oppure se le batterie sono esauste. Non utilizzare mai batterie danneggiate. Utilizzare solo batterie di tipo alcalino. Inserire le batterie avendo cura che la loro polarità sia corretta. Non tentare mai di ricaricare batterie non ricaricabili. Non cortocircuitare mai il portabatterie.

## NL

### Belangrijke informatie over batterijen

Gebruik nooit verschillende soorten of een combinatie van oude en nieuwe batterijen tegelijkertijd. Verwijder de batterijen altijd als je het product lange tijd niet wilt gebruiken of als batterijen leeg zijn. Gebruik nooit beschadigde batterijen. Gebruik alleen alkalinebatterijen. Plaats de batterijen met de polen in de juiste richting. Probeer nooit niet-oplaadbare batterijen opnieuw op te laden. Laat de batterijhouder nooit kortsluiten.

## ES

### Información importante acerca de las pilas

No use pilas de diferentes tipos ni pilas nuevas y antiguas para alimentar el producto. Extraiga las pilas del producto si este va a permanecer sin uso durante un período prolongado de tiempo o aquellas se han agotado. No use pilas dañadas. Use solo pilas alcalinas. Inserte las pilas de modo que los polos queden situados en las posiciones correctas. No trate de cargar pilas no recargables. No cortocircuite el compartimento de las pilas.

## DA

### Vigtige oplysninger om batterier

Brug aldrig forskellige batterityper sammen eller en kombination af gamle og nye batterier. Fjern altid batterierne, hvis produktet ikke skal bruges i lang tid, eller hvis batterierne er flade. Brug aldrig beskadigede batterier. Brug kun alkaliske batterier. Sæt batterierne i, så polerne vender den rigtige vej. Forsøg aldrig at oplade ikke-genopladelige batterier. Kortslut aldrig batteriholderen.

## IS

### Mikilvægar upplýsingar um rafhlöður

Aldrei skal nota mismunandi gerðir rafhlaðna samtímis, né nýjar og eldri rafhlöður samtímis. Ef ekki á að nota tækið í lengri tíma eða ef rafhlöðurnar eru orðnar tómar skal fjarlægja rafhlöðurnar. Aldrei skal nota rafhlöður sem hafa skemmt. Eingöngu má nota alkaline-rafhlöður. Setja skal rafhlöðurnar í þannig að plús- og mínusskaut þeirra snúi rétt. Aldrei skal reyna að endurhlaða rafhlöður sem ekki eru endurhlaðanlegar. Aldrei ætti að valda skammhlaupi í rafhlöðuhólfinu.

## FI

### Tärkeää tietoa paristoista

Älä koskaan käytä erityyppisiä paristoja yhdessä. Älä myöskään käytä samassa laitteessa sekä vanhoja että uusia paristoja. Poista paristot tuotteesta aina, kun se on pitemmän aikaa käyttämättä, tai kun paristot ovat tyhjentyneet. Älä koskaan käytä viallisia paristoja. Käytä vain alkaliparistoja. Aseta paristot siten, että navat osoittavat oikeaan suuntaan. Älä koskaan aiheuta oikosulkuja pariston kosketin välillä.

## SV

### Viktig information om batterier

Använd aldrig olika sorters batterier samtidigt, och inte heller en kombination av gamla och nya batterier. Ta alltid ur batterierna om produkten inte ska användas under en längre tid eller om batterierna är slut. Använd aldrig skadade batterier. Använd endast alkaliska batterier. Sätt i batterierna så att polerna hamnar i rätt läge. Försök aldrig ladda icke-laddningsbara batterier. Kortslut aldrig batteriutrymmets kontaktytor.

## NO

### Viktig informasjon om batterier

Bruk aldri ulike typer batterier sammen og heller aldri gamle og nye batterier sammen. Ta alltid ut batteriene hvis produktet ikke skal brukes på lang tid, eller hvis batteriene er brukt opp. Bruk aldri skadde batterier. Bruk bare alkaliske batterier. Sett inn batteriene med polene vendt riktig vei. Forsøk aldri å lade opp ikke-oppladbare batterier. Kortslett aldri batteriholderen.

## PT

### Informação importante sobre as pilhas

Nunca use diferentes tipos de pilhas em simultâneo, ou uma combinação de pilhas usadas e novas. Retire sempre as pilhas se o produto não for usado durante muito tempo ou se as pilhas já não tiverem carga. Nunca use pilhas danificadas. Use apenas pilhas alcalinas. Insira as pilhas de forma a que os polos fiquem corretamente posicionados. Nunca tente recarregar pilhas não recarregáveis. Nunca deixe o compartimento das pilhas entrar em curto-circuito.

## EL

### Σημαντικές πληροφορίες για τις μπαταρίες

Μην χρησιμοποιείτε ποτέ διαφορετικούς τύπους μπαταριών μαζί και μην συνδυάζετε παλιές και καινούργιες μπαταρίες. Αφαιρείτε πάντα τις μπαταρίες αν δεν σκοπεύετε να χρησιμοποιήσετε το προϊόν για αρκετό καιρό ή αν οι μπαταρίες έχουν αδειάσει. Ποτέ μην χρησιμοποιείτε μπαταρίες που έχουν φθορές. Χρησιμοποιείτε μόνο αλκαλικές μπαταρίες. Τοποθετήστε τις μπαταρίες με τους πόλους στη σωστή θέση. Μην επιχειρήσετε ποτέ να επαναφορτίσετε μη επαναφορτιζόμενες μπαταρίες. Ποτέ μην βραχυκυκλώνετε τη θήκη των μπαταριών.

## JA

### 電池取扱いに関する重要事項

異なるタイプの電池や古い電池を混ぜて使用しないでください。商品を長時間使用しないときや電池が切れたときは、電池を必ず取り外してください。不具合のある電池は絶対に使用しないでください。アルカリタイプの電池のみを使用してください。電極を確認して電池を正しい向きに入れてください。充電式ではない電池は絶対に充電しないでください。電池ホルダをショートさせないでください。

## ZH

### 電池使用注意事項

请勿同时使用不同类型的电池，或把新旧程度不同的电池混合使用。如果产品将有长时间不会使用，或者电池已经没电，请注意取出电池。切勿使用已破损的电池。仅可使用碱性电池。装入电池时请注意正负极。请勿尝试给非充电电池充电。切勿对电池仓进行短路连接。

## KO

### 배터리 사용 시 주의사항

다른 종류의 배터리를 함께 사용하거나, 새 전지와 오래된 전지를 혼용하지 마세요. 배터리가 방전되었거나 장기간 제품을 작동하지 않을 때에는 반드시 배터리를 분리하세요. 파손된 배터리는 사용하지 마세요. 알칼라인 타입의 배터리만을 사용하세요. 양극과 음극의 위치를 잘 맞춰서 넣으세요. 일반 배터리는 충전해서 사용할 수 없습니다. 배터리 홀더의 접촉부에 배터리를 정확히 끼워서 사용하세요.

## RU

### Необходимая информация об элементах питания

Ни в коем случае не используйте одновременно элементы питания различных типов, а также элементы питания с разным сроком годности. В обязательном порядке вынимайте элементы питания из терминалов в случае, если вы не пользуетесь прибором в течение долгого времени, либо в случае, если в элементах питания закончился заряд. Ни в коем случае не используйте поврежденные элементы питания. Используйте только элементы питания щелочного типа. Установите элементы питания, соблюдая указанную полярность. Ни в коем случае не пытайтесь подзаряжать перезаряжаемые элементы питания. Ни в коем случае не пытайтесь замкнуть полюса в устройстве для элементов питания.

## PL

### Ważne informacje dotyczące baterii

Nigdy nie należy stosować razem różnych rodzajów baterii ani stosować równocześnie starych i nowych baterii. Jeżeli produkt nie jest używany przez dłuższy czas lub jeżeli baterie się wyczerpały, należy wyjąć baterie. Nigdy nie należy stosować uszkodzonych baterii. Należy używać wyłącznie baterii alkalicznych. Przy wkładaniu baterii należy zwrócić uwagę na właściwe położenie biegunów. Nigdy nie należy próbować ładowania baterii jednorazowych. Nigdy nie należy doprowadzać do zwarcia w gnieździe baterii.

## CZ

### Důležitá informace o bateriích

Nikdy nepoužívejte najednou různé typy baterií nebo kombinaci starých a nových baterií. Nebude-li se výrobek delší dobu používat nebo jsou-li baterie vybité, vždy je vyjměte z výrobku. Nikdy nepoužívejte poškozené baterie. Používejte pouze alkalické baterie. Baterie instalujte se správnou orientací pólů. Nikdy se nesnažte nabíjet baterie, které nejsou nabíjitelné. Nikdy nezkratujte kontakty v prostoru pro baterie.

## SK

### Dôležitá informácia o batériách

Nikdy nepoužívajte naraz odlišné typy batérií ani nekombinujte staré batérie s novými. Batérie vždy vyberte, ak sa výrobok nebude dlhšie používať, alebo ak sa batérie vybili. Nikdy nepoužívajte poškodené batérie. Používajte iba alkalické batérie. Batérie vkladajte so správnou orientáciou pólov. Nikdy sa nesnažte nabíjať batérie, ktoré nie sú nabíjateľné. Nikdy neskratujte kontakty v priestore pre batérie.

## HU

### Fontos tudnivalók az elemekről

Soha ne használjon különböző típusú elemeket, illetve ne használjon vegyesen új és használt elemeket. Mindig távolítsa el az elemeket, ha a készüléket előre láthatóan hosszabb ideig nem fogják használni, vagy ha az elemek lemerültek. Soha ne használjon megrongálódott elemeket. Csak alkáli elemeket használjon! Az elemeket helyesen helyezze be, a polaritásuknak megfelelően. Soha ne próbálja meg feltölteni a nem tölthető elemeket. Soha ne hozzon létre rövidzárlatot az elemtartó kivezetésein.

## UA

### Необхідна інформація про батареїки

Ніколи не використовуйте одночасно батареїки різних типів або батареїки з різним терміном придатності. Обов'язково вилучайте батареїки з приладу, якщо довго не користуетесь ним, або якщо в батареїках уже скінчився заряд. Ніколи не використовуйте пошкоджені батареїки. Використовуйте лише лужні батареїки. Вставляйте батареїки, враховуючи задану полярність. У будь-якому випадку не намагайтеся підзарядити батареїки, що не підлягають підзарядці. У будь-якому випадку не намагайтеся зробити коротке замикання в приладі для батарей.

## HR

### Važne obavijesti o bateriji

Nikada nemoj koristiti različite vrste baterija zajedno, isto tako ni kombinaciju starih i novih baterija. Uvijek izvadite baterije ako dugo nećeš koristiti proizvod ili ako su one potrošene. Nikada nemoj koristiti oštećene baterije. Upotrebļjavajte samo alkalne baterije. Umetni baterije pazeci da dobro okreneš polove. Nikada ne pokušavaj puniti baterije koje nisu predviđene za punjenje. Nikada ne izazivaj kratki spoj u držaču baterija.

## SR

### Важне информације о батеријама

Никада не користите различите типове батерија заједно нити комбинацију старих и нових батерија. Увек извадите батерије уколико производ нећете дуже време користити или уколико су батерије празне. Никада не користите оштећене батерије. Користите само алкалне батерије. Ставите батерије тако да су полови правилно позиционирани. Никада не покушавајте да пуните батерије које не могу да се пуне. Никада не изазивајте кратак spoj у кућишту за батерије.

## MK

### Важни информации за батериите

Никогаш не користете различни типови батерији заедно или комбинација од стари и нови батерији. Секогаш отстранувајте ги батериите доколку не го користите производот подолго време или доколку се потрошиле. Никогаш не користете оштетени батерији. Користете само алкални батерији. Вметнете ги батериите така што точно ќе ги наместите половите. Никогаш не обидувајте се да ги полните батериите за еднократна употреба. Никогаш не предизвикувајте краток spoj на држачот за батерији.

## SL

### Pomembne informacije o baterijah

Nikoli ne uporabljajte skupaj različnih baterij ali kombinacije starih in novih baterij. Vedno odstranite baterije, če izdelka dlje časa ne boste uporabljali ali če so iztrošene. Nikoli ne uporabljajte poškodovanih baterij. Uporabljajte le alkalne baterije. Baterije vstavite tako, da so njihovi polji pravilno obrnjeni. Nikoli ne poskušajte polniti baterij, ki niso akumulatorske. Pazite, da ležišč za baterije ne boste spravili v kratek stik.

## RO

### Informații importante despre baterii

Nu folosiți niciodată împreună tipuri diferite de baterii, sau o combinație de baterii vechi și noi. Îndepărtați întotdeauna bateriile dacă produsul nu este folosit timp îndelungat sau dacă bateriile s-au epuizat. Nu folosiți niciodată baterii deteriorate. Utilizați numai baterii de tip alcalin. Introduceți bateriile astfel ca polișii să fie poziționați corect. Nu încercați niciodată să reîncărcați bateriile nereîncărcabile. Nu scurtcircuitați niciodată suportul bateriei.

## BG

### Важна информация за батериите

Никога не използвайте едновременно различни типове батерии или комбинация от стари и нови батерии. Винаги изваждайте батериите, ако издेलително няма да се използва продължително време или ако батериите са се изтощили. Никога не използвайте повредени батерии. Използвайте само алкални батерии. Поставете батериите така, че полюсите да са разположени правилно. Никога не опитвайте да зареждате батерии, които не са акумулаторни. Никога не свързвайте на късо контактите на отделението за батериите.

## LV

### Svarīga informācija par baterijām

Nekad vienlaikus nelietojiet dažādu tipu, kā arī vecas un jaunās baterijas. Vienmēr izņemiet baterijas, ja tās ir izlādējušās vai ja produktus ilgāku laiku netiek lietots. Nekad nelietojiet bojātas baterijas. Izņemiet tikai sārna tipa baterijas. Ievietojiet baterijas, ievērojiet pareizu polaritāti. Nekad nemēģiniet uzlādēt baterijas, kas nav uzlādējamas. Nepieļaujiet issavienojumu bateriju nodalījumā.

## ET

### Oluline teave patareide kohta

Ära kunagi kasuta koos erinevat tüüpi patareisid, samuti vanu ja uusi patareisid. Kui mänguasja ei kasutata pika aja jooksul, võta patarei sellest välja. Ära kunagi kasuta kahjustatud patareisid. Kasuta ainult leelispatareisid. Pane patareid mänguasja sisse nii, et pluss- ja miinusklemmi asend oleks õige. Ära kunagi proovi akulaadijaga laadida tavalisi patareisid. Patareipesa klemmide vahel ei tohi tekkida lühist.

## LT

### Svarbi informacija apie elementus

Vienu metu nenaudokite skirtingų elementų, taip pat su naujais elementais nenaudokite senų. Jei nenaudosite gaminio ilgesnį laiką arba jei elementai išseko, visuomet išimkite juos iš gaminio. Niekada nenaudokite pažeistų elementų. Naudokite tik šarminius elementus. Elementus dėkite atsižvelgdami į jų poliškumą. Niekada nebandykite įkrauti vienkartinių elementų. Saugokitės, kad elementų dėklė nesukeltumėte trumpojo jungimo.

## TR

### Piller hakkında önemli bilgiler

Hiçbir zaman farklı tipte pilleri ya da eski pillerle yeni pilleri bir arada kullanmayın. Ürün uzun süre kullanılmayacaksa ya da piller bitmişse, pilleri ürünün içinden çıkarın. Hiçbir zaman zedelenmiş piller kullanmayın. Sadece alkalin piller kullanın. Pilleri kutupları doğru konumda olacak şekilde yerleştirin. Hiçbir zaman, şarj edilebilir olmayan pilleri şarj etmeye çalışmayın. Hiçbir zaman pil kutusuna kısa devre yaptırmayın.

## AR

### معلومات مهمة عن البطاريات

يحظر استخدام أنواع مختلفة من البطاريات معا أو مزيج من البطاريات القديمة والجديدة. أحرص دائما على نزع البطاريات في حال عدم استخدام المنتج لفترة طويلة أو إذا نفذت طاقة البطاريات. تجنب استخدام البطاريات التالفة. لا تستخدم إلا البطاريات القلوية فقط. قم بتركيب البطاريات بحيث تكون الأقطاب في موضعها الصحيح. يحظر إعادة شحن البطاريات غير القابلة لإعادة الشحن. تجنب إحداث دائرة قصر في حامل البطارية.

## ID

### Informasi penting tentang baterai

Jangan gunakan baterai yang jenisnya berlainan, atau mencampur baterai lama dan baterai baru. Lepas baterai jika produk tidak akan digunakan untuk waktu lama atau jika baterai sudah lemah. Jangan gunakan baterai yang rusak. Gunakan hanya baterai alkali. Masukkan baterai dengan posisi kutub yang tepat. Jangan pernah coba mengisi ulang baterai biasa. Jangan pernah membuat arus pendek pada dudukan baterai.

## MS

### Maklumat penting tentang bateri

Jangan guna jenis bateri yang berbeza bersama-sama, atau gabungan bateri baharu dan lama. Tanggalkan bateri jika produk tidak akan digunakan untuk tempoh masa yang lama atau jika bateri telah habisian kuasa. Jangan guna bateri yang rosak. Guna bateri jenis alkali sahaja. Selitkan bateri supaya paksi berada pada kedudukan yang betul. Jangan cuba untuk mengecap semula bateri yang tidak boleh dicaskan semula. Jangan pintas litar pemegang bateri.

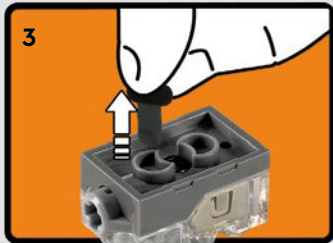

1:1  
2x LR 41 1.5V





EN

**WARNING:** This product contains a Button or Coin Cell Battery. A swallowed Button or Coin Cell battery can cause internal chemical burns in as little as two hours and lead to death. Dispose of used batteries immediately. Keep new and used batteries away from children. If you think batteries might have been swallowed or placed inside any part of the body, seek immediate medical attention.

DE

**ACHTUNG:** Dieses Produkt enthält eine Knopfzellenbatterie. Eine verschluckte Knopfzellenbatterie kann innere chemische Verbrennungen verursachen und in weniger als zwei Stunden zum Tod führen. Entsorge umgehend gebrauchte Batterien. Halte neue und gebrauchte Batterien von Kindern fern. Wenn du glaubst, dass Batterien verschluckt wurden oder sich in einem Körperteil befinden, hole umgehend medizinische Hilfe.

FR

**AVERTISSEMENT :** Ce produit contient une pile bouton. L'ingestion d'une pile bouton peut provoquer des brûlures chimiques internes en seulement deux heures et provoquer la mort. Jeter immédiatement les piles usagées. Conserver les piles neuves et usagées hors de portée des enfants. Si vous suspectez l'ingestion d'une pile ou sa présence où que ce soit à l'intérieur du corps, consultez immédiatement un médecin.

IT

**ATTENZIONE:** questo prodotto contiene una batteria a bottone. Se inghiottita, una batteria a bottone può causare ustioni chimiche interne in sole due ore, con possibile morte. Smaltire immediatamente le batterie usate. Tenere le batterie nuove e usate lontano dai bambini. Se si pensa che una batteria sia stata inghiottita o inserita in una parte del corpo, rivolgersi immediatamente a un medico.

NL

**WAARSCHUWING:** dit product bevat een knoopcelbatterij. Als een knoopcelbatterij wordt ingeslikt, kan deze binnen twee uur chemische brandwonden veroorzaken in het lichaam. Het inslikken van een dergelijke batterij kan zelfs leiden tot overlijden. Gooi gebruikte batterijen onmiddellijk weg. Bewaar nieuwe en gebruikte batterijen buiten bereik van kinderen. Als je denkt dat een kind batterijen heeft ingeslikt of ze in een lichaamsopening heeft gestopt, raadpleeg je direct een arts.

ES

**ADVERTENCIA:** Este producto contiene una pila de botón. Ingerir una pila de botón puede dar lugar a quemaduras químicas internas en tan sólo dos horas y provocar la muerte. Las pilas usadas deben desecharse inmediatamente. Mantenga las pilas nuevas y usadas fuera del alcance de los niños. Si sospecha de la ingestión o la introducción de pilas en cualquier parte del cuerpo, busque atención médica inmediatamente.

DA

**ADVARSEL:** Dette produkt indeholder et knap- eller møntcellebatteri. Hvis et knap- eller møntcellebatteri sluges, kan det forårsage indvendige ætsninger på blot to timer og medføre døden. Bortskaf brugte batterier omgående. Hold både nye og brugte batterier uden for børns rækkevidde. Hvis du har mistanke om, at batterierne kan være blevet slugt eller kommet ind i nogen del af kroppen, skal du omgående søge lægehjælp.

IS

**VÍÐVÖRUN:** Þessi vara inniheldur hnapparahlöðu eða flata rafhlöðu. Ef hnapparahláða eða flöt rafhláða er gleypt getur hún valdið innvortis efnabruna á innan við tveimur klukkustundum og leitt til dauða. Fargaðu notuðum rafhlöðum tafarlaust. Geymdu nýjar og notaðar rafhlöður þar sem börn ná ekki til. Ef þú telur að rafhlöður hafi verið gleyptar eða á annan hátt komist inn í einhvern hluta líkamans skaltu tafarlaust leita læknaðstoðar.

FI

**VAROITUS:** Tämä tuote sisältää pienen tai isokokoisen nappipariston. Nieltynä pieni tai isokokoinen nappiparisto voi aiheuttaa sisäisiä kemiallisia palovammoja jo kahden tunnin kuluessa ja johtaa kuolemaan. Käytetyt paristot on toimitettava heti keräyspisteeseen. Pidä uudet ja käytetyt paristot poissa lasten ulottuvilta. Jos epäilet jonkun nieleisseen pariston tai laittaneensa pariston kehoonsa, vie hänet välittömästi lääkäriin.

SV

**VARNING:** Denna produkt innehåller ett knapp- eller myntcells batteri. Förtäring av ett knapp- eller myntcells batteri kan orsaka inre kemiska brännskador på så kort tid som två timmar och leda till döden. Kassera förbrukade batterier omedelbart. Förvara nya och använda batterier utom räckhåll för barn. Om du tror att batterierna kan ha svalts eller placerats inuti någon del av kroppen, sök omedelbart läkarvård.

NO

**ADVARSEL:** Dette produktet inneholder et knapp- eller myntcellebatteri. Ved svelging kan knapp- eller myntcellebatterier gi kjemisk brannskade innvendig på bare to timer og føre til død. Brukte batterier skal avhendes øyeblikkelig. Nye og brukte batterier skal oppbevares utilgjengelig for barn. Hvis du tror at batterier har blitt svelget eller puttet inn andre steder i kroppen, må du kontakte lege øyeblikkelig.

PT

**AVISO:** Este produto contém uma pilha tipo botão ou moeda. Uma pilha tipo botão ou moeda que tenha sido engolida pode provocar queimaduras químicas internas em menos de duas horas e levar à morte. Elimine as pilhas usadas imediatamente. Mantenha as pilhas novas e usadas fora do alcance das crianças. Se pensa que as pilhas podem ter sido engolidas ou colocadas no interior de alguma parte do corpo, procure de imediato assistência médica.

EL

**ΠΡΟΕΙΔΟΠΟΙΗΣΗ:** Αυτό το προϊόν περιέχει μία Στρογγυλή Μπαταρία Μεγέθους Κουμπιού ή Κέρματος. Η κατάποση μιας Στρογγυλής Μπαταρίας Μεγέθους Κουμπιού ή Κέρματος μπορεί να προκαλέσει εσωτερικά χημικά εγκαύματα σε μόλις δύο ώρες και να οδηγήσει σε θάνατο. Πελάξτε αμέσως τις χρησιμοποιούμενες μπαταρίες. Κρατήστε τις καινούργιες και τις χρησιμοποιούμενες μπαταρίες μακριά από τα παιδιά. Εάν νομίζετε ότι κάποια μπαταρία έχει καταποθεί ή τοποθετηθεί εντός οποιουδήποτε μέρους του σώματος, ζητήστε αμέσως ιατρική βοήθεια.

JA

**警告:** 本製品には、ボタン型またはコイン型の電池が使用されています。ボタン型またはコイン型電池は誤飲すると2時間以内に体内で科学火傷を起こし、死に至る恐れがあります。使用済みの電池は直ちに廃棄してください。新しい電池および使用済み電池は、どちらもお子様の手の届かないところに保管してください。電池を誤飲した恐れがある。または電池が身体のどこかに入った恐れがある場合は、直ちに医師の診察を受けてください。

ZH

**警告:** 本品内含一颗纽扣电池。吞咽的纽扣电池仅在两小时内就会引起体内化学灼伤并导致死亡!请立即处理使用过的电池。请将新、旧电池放置到儿童接触不到的地方。如果电池被不慎吞下,或被置入身体的任何一个部位,请立即就医!

KO

경고: 이 제품에는 버튼 또는 코인 셀 배터리가 포함되어 있습니다. 코인 셀 배터리를 삼킬 경우, 빠르면 2시간 이내에 체내에서 화학적 화상이 일어나고 심하면 사망에 이를 수 있습니다. 다 쓴 배터리는 즉시 폐기하십시오. 배터리를 어린이의 손에 닿지 않는 곳에 보관하십시오. 배터리를 삼켰거나 신체 어느 부위에든 들어간 것으로 판단될 경우, 즉각 의사의 도움을 구하십시오.

RU

**ПРЕДОСТЕРЕЖЕНИЕ.** Эта игрушка работает от батарейки таблеточного или кнопочного типа. Проглатывание батарейки таблеточного или кнопочного типа может (в течение двух часов) вызвать химические ожоги внутренних органов и привести к летальному исходу. Своевременно утилизируйте использованные батарейки. Храните новые и использованные батарейки в местах, недоступных для детей. Если у вас есть основания полагать, что ребенок проглотил батарейку или она попала внутрь какой-либо части его тела, немедленно обратитесь за медицинской помощью.

PL

**OSTRZEŻENIE:** w tym produkcie znajduje się płaska okrągła bateria. Połknięcie takiej baterii może spowodować chemiczne oparzenia wewnętrzne już po dwóch godzinach, a także doprowadzić do śmierci. Gdy bateria się zużyje, należy ją natychmiast zutylizować. Nowe i używane baterie należy przechowywać z dala od dzieci. W przypadku stwierdzenia, że baterie mogły zostać połknięte lub inaczej trafić do organizmu, należy natychmiast poszukać pomocy lekarskiej.



**CZ**  
VAROVÁNÍ: Tento výrobek obsahuje knoflíkovou nebo mincovou baterii. Spolknutí knoflíkové nebo mincové baterie může během pouhých 2 hodin způsobit vnitřní poleptání sliznice a v některých případech mít za následek smrt. Použité baterie ihned vyměňte a zlikvidujte. Nové i použité baterie uchovávejte mimo dosah dětí. V případě spolknutí či uvíznutí baterie v některé části těla okamžitě vyhledejte lékařskou pomoc.

**SK**  
UPOZORNENIE: Tento produkt obsahuje gombíkovú alebo mincovú batériu. Prehltnutie gombíkovej alebo mincovej batérie môže spôsobiť vnútorné chemické popáleniny už do dvoch hodín a viesť k úmrtiu. Použité batérie ihneď vyhodte. Nové aj použité batérie uchovávajte mimo dosahu detí. Ak si myslíte, že mohlo dôjsť k prehltnutiu batérie alebo sa batéria mohla dostať do vnútra ktorejkoľvek časti tela, okamžite vyhľadajte lekársku pomoc.

**HU**  
FIGYELMEZTETÉS: Ez a termék gombelemet illetve lapos gombelemet tartalmaz!

A lenyelt gombelem vagy lapos gombelem akár két óra alatt is belső vagy sérüléseket okozhat, ami halálhoz vezethet. Az elhasznált elemeket azonnal dobja ki! Az új és a használt elemeket ne adja gyermekek kezébe! Ha úgy gondolja, hogy valaki lenyelt egy elemet, vagy bekerült valakinek valamely testrészébe, akkor azonnal kérjen orvosi segítséget!

**UA**  
ОБЕРЕЖНО. Продукт містить мініатюрну батарейку типу «таблетка». Якщо проковтнути мініатюрну батарейку, вона може спричинити внутрішні хімічні опіки протягом двох годин і призвести до смерті. негайно утилізуйте використані батарейки. Зберігайте нові та використані батарейки недосяжними для дітей. Якщо вам здається, що дитина проковтнула батарейку чи вона опинилася в будь-якій частині тіла дитини, негайно зверніться до лікаря.

**HR**  
UPOZORENJE: Ovaj proizvod sadrži gumbastu bateriju ili bateriju oblika kovanice. Ako se gumbasta baterija ili baterija oblika kovanice proguta, za samo dva sata može uzrokovati unutarnje kemijske opekline i izazvati smrt. Iskorištene baterije odmah odložite u otpad. Čuvajte nove i stare baterije dalje od djece. Ako mislite da je baterija progutana ili je dospjela u bilo koji dijela tijela, odmah zatražite liječničku pomoć.

**SR**  
УПОЗОРЕЊЕ: Овај производ садржи дугмасту батерију. Прогутања дугмаста батерија може да доведе до интерних хемијских опекотина већ за два сата и доводи до смрти. Одмах одложите искоришћене батерије у отпад. Чувајте нове и искоришћене батерије ван домаћаја деце. Ако мислите да је дошло до гутања батерија или стављања у било који део тела, одмах потражите помоћ лекара.

**МК**  
ПРЕДУПРЕДУВАЊЕ: Овој производ содржи батерија тип копче или тип монета. Проголтувањето на батерија тип копче или тип монета може да предизвика внатрешно хемиско горење во рок од два часа и да доведе до смрт. Исфрлете ги веднаш искористените батери. Држете ги новите и користените батери подалеку од деца. Ако мислите дека е можно батериите да се проголтани или поставени во кој било дел на телото, веднаш побарајте медицинска помош.

**SL**  
OPOZORILO: Ta izdelek vsebuje gumbasto baterijo. Če oseba požre gumbasto baterijo, lahko to povzroči kemične opekline notranjih organov že v dveh urah po zaužitju. Tovrstne poškodbe lahko vodijo v smrt. Iztržene baterije takoj zavržite. Pazite, da nove ali iztržene baterije ne bodo v dosegu otrok. Če menite, da je oseba zaužila baterijo ali si jo vstavila v kateri koli del telesa, takoj poiščite zdravniško pomoč.

**RO**  
AVERTIZARE: Acest produs conține o baterie de tip pastilă. Înghițirea unei baterii de tip pastilă poate cauza arsuri chimice interne în doar două ore, ducând la deces. Debarașiți-vă imediat de bateriile uzate. Nu lăsați bateriile noi și uzate la îndemâna copiilor. Dacă credeți că bateriile ar fi putut fi înghițite sau ar fi putut ajunge în interiorul oricărei părți a corpului, solicitați imediat asistență medicală.

**BG**  
ПРЕДУПРЕЖДЕНИЕ: Този продукт съдържа батерия тип „копче“ или „монета“. При поглъщане батериите тип „копче“ или „монета“ могат да предизвикат вътрешни химически изгаряния в рамките на по-малко от два часа и да доведат до смърт. Незабавно изхвърляйте използваните батерии. Дръжте новите и стари батерии далеч от деца. Ако смятате, че е възможно батериите да са били поглънати или да са попаднали където и да е вътре в тялото, потърсете незабавно медицинска помощ.

**LV**  
BRĪDINĀJUMS. Šim produktam ir pogas jeb monētas tipa akumulators. Ja pogas jeb monētas tipa akumulators tiek norīts, tas jau divu stundu laikā var izraisīt iekšējus ķīmiskus apdegumus un izraisīt nāvi. Nekavējoties izlietotus akumulatorus. Jaunus un lietotus akumulatorus glabājiet bērniem nepieejamā vietā. Ja uzskatāt, ka akumulators varētu būt norīts vai ievietots kādā ķermeņa daļā, nekavējoties vērsieties pēc medicīniskās palīdzības.

**ET**  
HOIATUS! See toode sisaldab nõõp- või müntpatareid. Alla neelatud nõõp- või müntpatareid võib tekitada sisemisi keemilisi põletusi kõigest kahe tunniga ning põhjustada surma. Kõrvaldage kasutatud patareid viivitamatult. Hoidke uusi ja kasutatud patareisid lastele kättesaamatus kohas. Kui arvate, et keegi on patareid alla neelanud või need on sattunud mõnda kehaosasse, pöörduge kohe arsti poole.

**LT**  
ĮSPĖJIMAS. Šiame gaminyje yra sagos arba monetos formos baterija. Praryta sagos arba monetos formos baterija gali sukelti vidinius cheminius nudegimus greičiau nei per dvi valandas ir galiausiai sukelti mirtį. Panaudotas baterijas nedelsiant utilizuokite. Naujas ir panaudotas baterijas laikykite atokiau nuo vaikų. Jei manote, kad vaikas galėjo praryti arba įsprauti bateriją sau į kūną, nedelsdami kreipkitės medicininės pagalbos.

**TR**  
UYARI: Bu ürün bir düğme pil içerir. Yutulmuş düğme pil, iki saat gibi kısa bir sürede iç kimyasal yanıklara neden olabilir ve ölüme yol açabilir. Kullanılmış pilleri derhal atın. Yeni ve kullanılmış pilleri çocuklardan uzak tutun. Pillerin yutulmuş ya da vücudun başka bir yerine sokulmuş olabileceğini düşünürseniz derhal doktora başvurun.

**AR**  
تحذير: يحتوي هذا المنتج على بطارية خلايا قرصية أو بطارية خلايا على شكل عملة. قد يؤدي ابتلاع بطارية خلايا قرصية أو بطارية خلايا على شكل عملة إلى حدوث حروق كيميائية داخلية خلال فترة قصيرة لا تتجاوز ساعتين وقد يؤدي إلى الوفاة. يرجى التخلص من البطاريات المستعملة على الفور. مع الاحتفاظ بالبطاريات الجديدة والمستعملة بعيداً عن متناول الأطفال. إذا كنت تعتقد أن البطاريات تم ابتلاعها أو إدخالها إلى أي جزء من أجزاء الجسم، فاطلب المساعدة الطبية على الفور.

**ID**  
PERINGATAN: Produk ini berisi Baterai Sel Kancing. Baterai Sel Kancing yang tertelan dapat mengakibatkan luka bakar kimiawi dalam tubuh minimal setelah dua jam dan dapat mengakibatkan kematian. Segera buang baterai yang sudah tidak digunakan. Jauhkan baterai baru maupun bekas dari jangkauan anak-anak. Jika Anda curiga baterai telah tertelan atau masuk ke dalam tubuh, segeralah minta bantuan dokter.

**MS**  
AMARAN: Produk ini mengandungi Bateri Sel Butang atau Syiling. Tertelan bateri Sel Butang atau Syiling boleh mengakibatkan lecuran kimia dalaman dalam tempoh sekurang-kurangnya dua jam dan menyebabkan kematian. Buang bateri terpakai dengan serta-merta. Jauhkan bateri baharu dan terpakai daripada kanak-kanak. Jika anda mendapati bateri mungkin telah ditelan atau termasuk ke dalam mana-mana bahagian badan, dapatkan rawatan perubatan dengan segera.

EN	Please retain the leaflet and packaging as they contain important information	UA	Будь ласка, зберігайте вкладиш та упаковку, оскільки вони містять важливу інформацію
DE	Broschüre und Verpackung bitte aufbewahren, sie enthalten wichtige Informationen	HR	Spremite letak i ambalažu jer sadrže važne obavijesti
FR	Veuillez conserver le dépliant et l'emballage, car ils contiennent des informations importantes	SR	Молимо да сачувате упутство и паковање јер се на њима налазе важне информације
IT	Conserva l'opuscolo e la confezione in quanto contengono informazioni importanti	MK	Чувајте ги брошурата и амбалажата бидејќи содржат важна информација
NL	Bewaar a.u.b. de folder en verpakking: die bevatten belangrijke informatie	SL	Prosimo, da brošurico in embalažo shranite, saj vključujeta pomembne informacije
ES	Conserve el folleto y el embalaje; contienen información importante	RO	Vă rugăm să păstrați prospectul și ambalajul întrucât conțin informații importante
DA	Gem hæftet og emballagen, da de indeholder vigtige oplysninger	BG	Запазете листовката и опаковката, тъй като съдържат важна информация
IS	Geymið bæklinginn og umbúðirnar þar sem þau innihalda mikilvægar upplýsingar	LV	Lūdzu, saglabājiet bukletu un iepakojumu, jo uz tā ir norādīta svarīga informācija
FI	Säilytä esite ja pakkaus, koska ne sisältävät tärkeää tietoa	ET	Hoidke infoleht ja pakend alles, sest nendele on märgitud oluline teave
SV	Spara broschyren och förpackningen eftersom de innehåller viktig information	LT	Išsaugokite informacinį lapelį ir pakuotę, nes ant jų pateikiama svarbi informacija
NO	Hæftet og emballasjen inneholder viktig informasjon og skal beholdes	TR	Önemli bilgiler içerdiği için broşürü ve ambalajı saklayın
PT	Por favor guarde o folheto e a embalagem, pois contém informação importante	AR	الرجاء الاحتفاظ بالنشرة والغلاف لاحتوائهما على معلومات هامة
EL	Κρατήστε το φυλλάδιο και τη συσκευασία γιατί περιέχουν σημαντικές πληροφορίες	ID	Harap simpan brosur dan kemasan ini karena berisi informasi penting
JA	説明書とパッケージには重要な情報が含まれていますので保管しておいてください	MS	Sila simpan risalah dan pembungkusan kerana ia mengandungi maklumat penting
ZH	说明书和包装均包含重要信息, 请妥善保存		
KO	중요한 정보가 담겨 있으므로 리플릿과 포장을 보관해주세요		
RU	Пожалуйста, сохраните эту брошюру и упаковку, поскольку они содержат важную информацию		
PL	Prosimy zachować ulotkę i opakowanie, ponieważ zawierają one ważne informacje		
CZ	Ponechte si prosím leták i obal, neboť obsahují důležité informace		
SK	Ponechajte si prosím leták aj obal, pretože obsahujú dôležité informácie		
HU	Kérjük, őrizze meg a szórólapot és a csomagolást, mert fontos tudnivalókat tartalmaznak		
			LEGO System A/S Aastvej 1 DK-7190 Billund





EN  
Protect the environment by not disposing of this product with your household waste.  
Check with your local authority for recycling advice and facilities. Penalties may apply for improper disposal.

DE  
Schützen Sie die Umwelt und entsorgen Sie dieses Produkt nicht mit Ihrem Hausmüll.  
Informationen zu Recycling-Möglichkeiten erhalten Sie bei den örtlichen Behörden. Bei unsachgemäßer Entsorgung können Strafen verhängt werden.

FR  
Protégez l'environnement : ne jetez pas ce produit avec vos autres déchets ménagers.  
Contactez les autorités locales pour obtenir des informations sur le recyclage et connaître les points de collecte.  
Des sanctions peuvent être appliquées en cas d'élimination inappropriée.



IT  
Proteggi l'ambiente! Non smaltire questo prodotto con i rifiuti domestici.  
Per consulenza sul riciclaggio dei rifiuti e le strutture di riciclaggio, rivolgersi alle proprie autorità locali.  
Uno smaltimento improprio può comportare sanzioni.

NL  
Bescherm het milieu: gooi dit product niet samen met het andere huisvuil weg.  
Raadpleeg de plaatselijke instanties voor locaties van milieustations en advies over hergebruik. In geval van onjuiste verwijdering kunnen boetes worden opgelegd.

ES  
Proteja el medio ambiente no deshaciéndose de este producto junto con sus residuos domésticos.  
Solicite asesoramiento e información sobre instalaciones de reciclaje a las autoridades locales. La eliminación inadecuada puede ser objeto de sanciones.

DA  
Beskyt miljøet! Smid ikke dette produkt ud sammen med husholdningsaffaldet.  
Få vejledning om genbrug og genbrugsstationer hos din kommune. Ukorrekt bortskaffelse kan medføre bøde eller straf.

IS  
Stuðlið að umhverfisvernd með því að farga þessari vöru ekki með heimilissorpi.  
Leitið upplýsinga um endurvinnslu- og förgunarstaði hjá yfirvöldum á hverjum stað. Viðurlögum kann að vera beitt ef förgun er ekki með réttum hætti.

FI  
Tämä tuote on hävitettävä ympäristöstävällisesti ja erillään muusta talousjätteestä.  
Tietoja kierrätyksestä ja keräyspisteiden sijainnista saat paikkakuntasi teknisestä virastosta. Epäasianmukaisesta hävittämisestä saattaa aiheutua seuraamuksia.

SV  
Skydda miljön genom att inte kasta denna produkt bland ditt hushållsavfall.  
Kontakta din kommun för frågor om återvinning och miljöstationer. Påföljder kan tillkomma för felaktig avyttring.

NO  
Beskytt miljøet. Ikke kast dette produktet i husholdningsavfallet.  
Kontakt kommunen for veiledning om gjenbruk og miljøstasjoner. Feil avfallshåndtering kan være straffbart.

PT  
Proteja o ambiente não eliminando este produto com o seu lixo doméstico.  
Consulte as autoridades locais para informação sobre reciclagem e sistemas de recolha. Podem ser aplicadas coimas por eliminação inadequada.

EL  
Προστατέψτε το περιβάλλον. Μην πετάτε αυτό το προϊόν μαζί με τα συνηθισμένα οικιακά απορρίμματα.  
Επικοινωνήστε με τις τοπικές αρχές σχετικά με συμβουλές και εγκαταστάσεις ανακύκλωσης. Ενδέχεται να επιβάλλονται κυρώσεις για ακατάλληλη διάθεση απορριμμάτων.

JA  
環境保護のため、本製品は家庭ごみとは別に処分してください。  
リサイクルに関する指示や施設については、お住まいの地方自治体にお問い合わせください。  
不適切な廃棄を行った場合、罰則が適用されることがあります。

ZH  
注意保护环境，请勿将本产品与生活垃圾一起丢弃处理。  
请咨询当地相关部门，了解与回收相关的设施与建议。处理不当可能会导致处罚。

KO  
환경 보호를 위해 이 제품을 생활폐기물과 함께 버리지 마십시오.  
재활용 방법 및 시설에 관한 사항은 현지 관계 당국에 문의하십시오. 부적절하게 폐기할 경우 벌칙이 부과될 수 있습니다.

RU  
Позаботьтесь об окружающей среде: не утилизируйте этот продукт вместе с бытовым мусором.  
Узнайте в органах местного самоуправления правила вторичной переработки и утилизации таких отходов.  
В случае ненадлежащей утилизации могут быть наложены штрафы.



PL

Aby chronić środowisko naturalne, nie należy wyrzucać tego produktu wraz z odpadkami z gospodarstwa domowego. W celu uzyskania wskazówek dotyczących recyklingu oraz adresów zakładów należy skontaktować się z lokalnym urzędem. Za nieprzestrzeganie zasad związanych z utylizacją odpadów grożą kary.

CZ

Nevyhazujte tento produkt do domácího odpadu, chráňte životní prostředí. Zjistěte si prosím u místních úřadů možnosti recyklace a dostupná zařízení. Nesprávná likvidace může být pokutová

SK

Nevyhadzujte tento produkt do domáceho odpadu, chráňte životné prostredie. Zistite si na miestnych úradoch možnosti recyklácie a dostupné zariadenia. Za nesprávnu likvidáciu môžu byť uložené sankcie.

HU

Környezetét óvja, ha ettől a terméktől nem a háztartási hulladékkal együtt válik meg. Érdeklődjék a lakóhelyéhez közel eső hatóságánál az újrahasznosítás módjáról és lehetőségeiről. A nem megfelelő hulladékelhelyezésért büntetés járhat.

UA

Допоможіть захистити довкілля: не утилізуйте цей виріб разом із побутовим сміттям. Вказівки з утилізації та відомості про пункти прийому з'ясуйте в місцевих компетентних органів. У разі неналежної утилізації можуть застосовуватися штрафи.

HR

Zaštitite okoliš tako da ovaj proizvod ne odložite u otpad zajedno s kućanskim otpadom. Od lokalnih vlasti zatražite savjet ili informacije o pogonima za recikliranje. Moguća je kazna za nepropisno zbrinjavanje.

SR

Zaštite životnu sredinu tako što nećete da odlažete ovaj proizvod sa kućnim otpadom. Raspitajte se kod lokalnog nadležnog organa o načinu reciklaže i o sabirnom centru. U slučaju nepravilnog odlaganja u otpad, mogu biti izrečene kazne.

MK

Zaštite ja okolinata tako što nema da se oslobodite od proizvodot so domashniot otpad. Konsultirajte se so lokalnite vlasti za da doznaete za sovetite i objektite za recikliranje. Vozmožno e da bidat primeneti kazni za nepravilno isfrlanje.

SL

Zaščitite okolje! Okolje varujte tako, da tega izdelka ne zavržete skupaj z gospodinjstvi odpadki. Pri krajevni upravi preverite, kakšne možnosti in kateri obrati za recikliranje obstajajo v vaši okolici. Za nepravilno odlaganje odpadkov vas lahko doleti kazen.

RO

Protejați mediul înconjurător și nu vă debarașiți de acest produs împreună cu deșeurile menajere. Consultați autoritățile locale pentru îndrumări și facilități de reciclare. Dezafectarea necorespunzătoare poate atrage sancțiuni.

BG

Защитете околната среда и не изхвърляйте този продукт заедно с битовите си отпадъци. Свържете се с местните власти относно съвети и съоръжения за рециклиране. Възможно е да има глоби за неправилно изхвърляне.

LV

Laī saudzētu vidi, neizmetiet šo izstrādājumu kopā ar sadzīves atkritumiem. Vērsieties vietējās varas iestādēs, lai noskaidrotu, kur un kā tas nododams pārstrādei. Par neatbilstošu likvidēšanu var tikt piemērots sods.

ET

Keskkonda saate kaitsta nii, et ei kõrvalda seda toodet koos olmejäätmetega. Nõuandeid toote taaskasutusse võtmise ja ümbertöötlemispunktide kohta saate asjaomaselt kohalikult asutuselt. Nõuetele mittevastav kasutuselt kõrvaldamine võib kaasa tuua trahvid.

LT

Saugokite aplinką: nemeskite šio produkto kartu su buitinėmis atliekomis. Atsižvelkite į savo vietos valdžios rekomendacijas dėl pakartotinio panaudojimo ir sąlygas. Už netinkamą šalinimą gali būti taikomos baudos.

TR

Bu ürünü, evsel atıklarla birlikte atmayarak çevreyi koruyun. Geri dönüşüm tavsiyeleri ve tesisler hakkında bilgi için yerel yönetimle iletişim kurun. Uygunsuz atılması durumunda cezalar uygulanabilir.

البيئة بعدم التخلص من هذا المنتج مع المخلفات المنزلية. تُؤد السلطة المحلية لديك للحصول على نصح بخصوص إعادة تدوير المخلفات ومرافقه. قد يتم تطبيق عقوبات على التخلص غير السليم.

ID

Jagalah lingkungan dengan tidak membuang produk ini bersama sampah rumah tangga Anda. Periksa peraturan pemerintah setempat tentang saran dan fasilitas daur ulang. Pembuangan yang tidak sesuai ketentuan dapat dikenakan denda.

MS

Lindungi alam sekitar dengan tidak melupuskan produk ini bersama sisa isi rumah anda. Rujuk pihak berkuasa tempatan anda tentang nasihat dan kemudahan kitar semula. Penalti boleh dikenakan untuk pelupusan yang tidak wajar.

13x  
6388018  
 2x  
302401  
 2x  
6235083  
 1x  
6132824  
 1x  
6334236  
 18x  
6059185  
 2x  
4249563  
 5x  
6457281  
 3x  
4501853  
 4x  
383201  
 2x  
4125253  
 4x  
4565452  
 1x  
6397819  
 5x  
4666579  
 6x  
4218749  
 1x  
4114026  
 174

1x  
6117975  
 4x  
6221467  
 1x  
6046924  
 9x  
6055783  
 9x  
4185177  
 1x  
4114306  
 2x  
6061575  
 4x  
4121921  
 1x  
4113233  
 1x  
6093950  
 1x  
6173922  
 2x  
4142865  
 2x  
4513174  
 1x  
302321  
 1x  
306821





































































































1x  
6129995  
 2x  
6130002  
 6x  
346021  
 15x  
4206482  
 2x  
6194724  
 14x  
6299413  
 2x  
6271167  
 6x  
300524  
 3x  
302424  
 5x  
6078279  
 4x  
614324  
 6x  
370024  
 4x  
302324  
 2x  
6069170  
 4x  
6313592  
 8x  
300424

2x  
6208753  
 2x  
6117938  
 1x  
6185994  
 1x  
4140587  
 2x  
242024  
 6x  
235724  
 4x  
6130007  
 1x  
362224  
 1x  
302124  
 9x  
4164073  
 6x  
371024  
 1x  
302024  
 4x  
300924  
 3x  
379524

8x  
4189400  
 1x  
303424  
 4x  
6079138  
 1x  
6174075  
 10x  
6315887  
 1x  
6359833  
 14x  
6284070  
 14x  
6278152  
 1x  
6424059  
 1x  
6406666  
 14x  
654126  
 6x  
6388352  
 8x  
6228987  
 53x  
302426  
 8x  
4504382

2x  
6181720  
 38x  
300526  
 2x  
6172383  
 12x  
407026  
 18x  
307026  
 6x  
6299338  
 2x  
6234695  
 1x  
6356861  
 1x  
6359865  
 1x  
6421732  
 3x  
4177431  
 1x  
6253695  
 6x  
6210270  
 2x  
6141554  
 1x  
6344427



 3x 6141556	 11x 614326	 12x 3200026	 2x 446026	 2x 4288212	 6x 6425507	 1x 6438664
 1x 6344428	 1x 6143850	 7x 6156991	 10x 366526	 3x 4140588	 1x 368026	 4x 4159550
 2x 6181713	 2x 4644456	 26x 370026	 2x 6192309	 1x 6290263	 4x 6166859	 19x 362326
 2x 6181713	 5x 9339	 21x 6275806	 1x 6146220	 1x 6093525	 2x 6133722	 12x 4558170
 2x 4180508	 3x 4198367	 14x 4636202	 8x 245426	 3x 6325254	 2x 300326	 28x 362226
 2x 4180536	 95x 302326	 12x 6138173	 6x 6016172	 6x 6192346	 1x 6089119	 4x 428626
 7x 6371584	 6x 6174243	 74x 300426	 14x 6000650	 9x 6053077	 8x 6052126	 4x 4251161
 8x 6157554	 2x 6347310	 6x 306926	 23x 6020193	 13x 242026	 2x 4515368	 1x 317626
 2x 6051508	 10x 4541191	 1x 6115086	 2x 6117973	 19x 306826	 1x 407926	 1x 4521681
 5x 4548180	 1x 6308912	 1x 4618852	 5x 6310268	 4x 4517737	 2x 6438609	 4x 4650620
 1x 6440253	 4x 6069000	 16x 6393322	 2x 4107761	 2x 4124096	 2x 4227684	 6x 6344999
 36x 6279875	 22x 6047276	 12x 4515373	 6x 6250020	 43x 302226	 16x 428726	 1x 6030875
 4x 6070695	 1x 4226995	 22x 4121966	 10x 4106513	 6x 6191630	 1x 6374765	 1x 6116604
 3x 6195325	 6x 6147050	 3x 6313116	 3x 383126	 48x 235726	 1x 6438648	
 2x 6291069	 4x 6369578			 2x 6013867		
 1x 4105175						

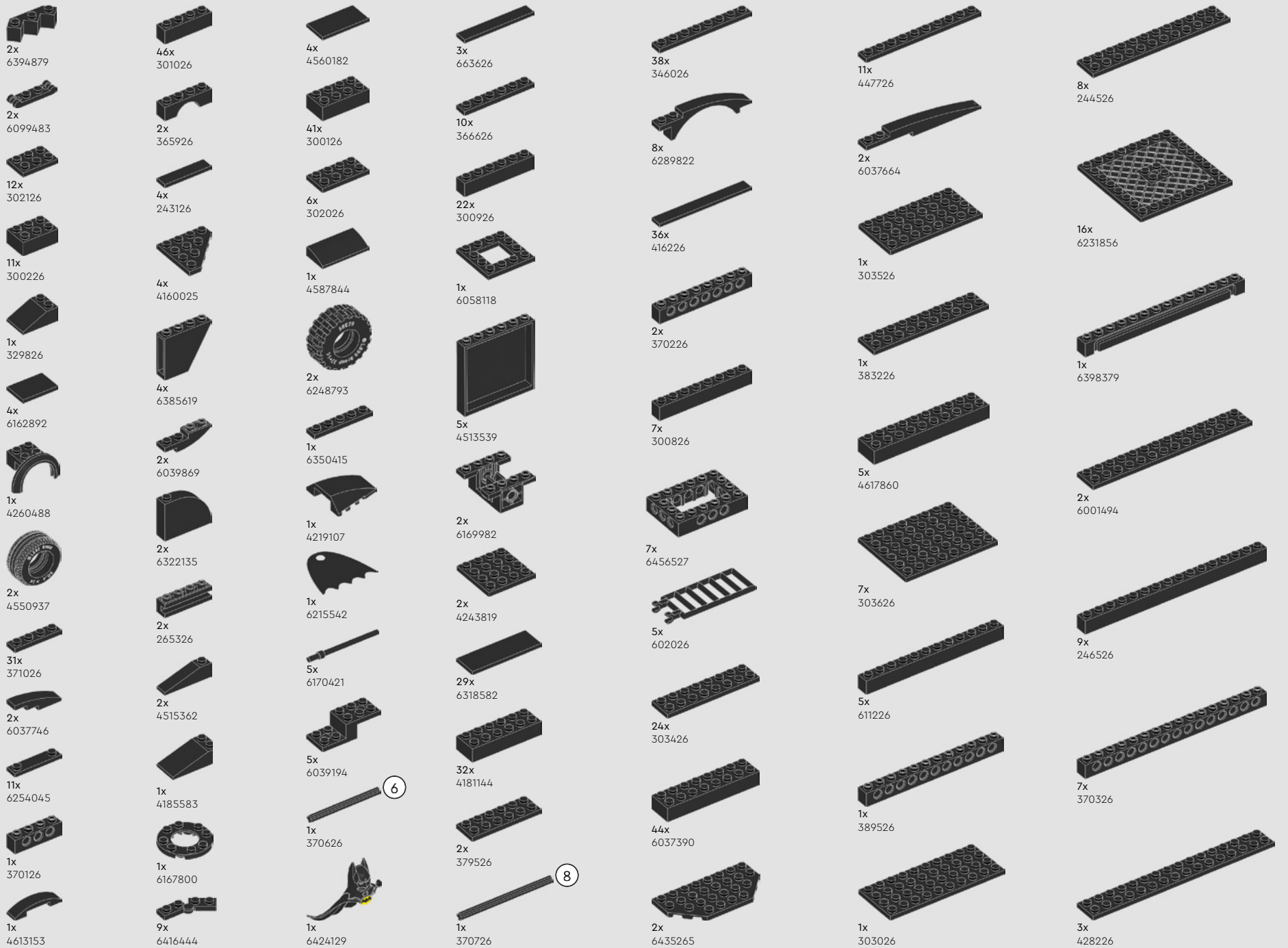

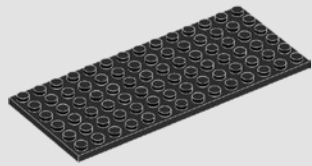

1x  
345626

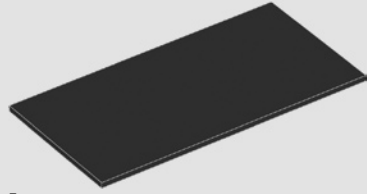

3x  
4603646



18x  
6117971



4x  
6382577



5x  
6258607



1x  
6168667



16x  
6240216



2x  
6274740



1x  
6172283



12x  
6251291



23x  
6240211



2x  
6251292



2x  
6239388



1x  
6408579



1x  
6016059



2x  
6396392



5x  
6015424

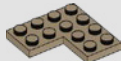

2x  
6151537



5x  
6003033



1x  
6440256



16x  
6135494



1x  
6159763

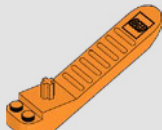

1x  
6240515



2x  
6284071



2x  
4211476



2x  
4521921



2x  
6336539



1x  
4558953



6x  
4211389



4x  
6335328



18x  
6345639



4x  
6248078



1x  
6123037



4x  
6345426



2x  
4550170



2x  
6227897



2x  
6296894



4x  
4568637



2x  
6407767



1x  
4278273



2x  
6271165



1x  
4540203



6x  
6372076



2x  
6092956



2x  
4640536



1x  
4227657



4x  
4211440



8x  
4211541



2x  
6206249



16x  
6123809



1x  
6066097



7x  
6015344



9x  
6320297



20x  
6000066



6x  
4211437



2x  
4211568



1x  
4282789



1x  
4282786



2x  
4211349



2x  
6346487



1x  
6404779



2x  
4211396



2x  
4610112



1x  
4211441



31x  
6314891



2x  
4211395



1x  
4211639



2x  
4211651



1x  
6171067



3x  
4211438

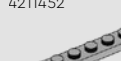

1x  
4211452



10x  
4211425

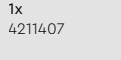

1x  
4211407

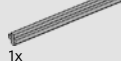

1x  
6178172



1x  
4662161



4x  
6359069

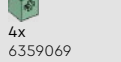

52x  
6231765

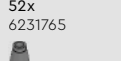

18x  
4529240



2x  
6395635

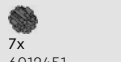

7x  
6012451

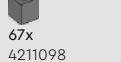

67x  
4211098



88x  
4504378



14x  
4210639



10x  
4558955



4x  
6228923



13x  
4210719



22x  
6362259



14x  
4211044



6x  
4210848



2x  
6360111



1x  
6270008



1x  
6143423



2x  
6143417



8x  
4210872



5x  
4210788



7x  
4210869



1x  
4210782



5x  
4567887



1x  
4226221



4x  
4211042



3x  
6092666



1x  
6281996



2x  
6310174



4x  
4211095



2x  
4211066



10x  
6215212



65x  
4211063



54x  
4211135



21x  
4221745



20x  
4211096



14x  
6164073



68x  
4211088



2x  
4210762



7x  
4211052



4x  
6411327



6x  
6331866



17x  
4210978



31x  
4500975



16x  
6013658



2x  
6230233



2x  
4210811



6x  
6452530



12x  
6117972



2x  
4210665



3x  
4210795

1x  
4211128

17x  
6168609

2x  
6146321

2x  
4290149

22x  
4210635

8x  
6411395

22x  
4210702

2x  
4210862

7x  
6227909

10x  
6309059

53x  
4211109

2x  
6247784

1x  
4211055

21x  
4211060

6x  
4211000

4x  
6000853

3x  
4218696

6x  
6035351

4x  
4211054

2x  
4234534

1x  
4211094

19x  
6013082

4x  
6015356

4x  
4624186

2x  
6352694

1x  
6201630

39x  
4211133

23x  
4211104

11x  
4211045

3x  
4210897

17x  
6186635

2x  
6172811

2x  
4225733

2x  
4211064

2x  
6271127

4x  
4527082

4x  
6187008

14x  
4211105

3x  
4211106

3x  
6083620

33x  
4211053

7x  
4210725

11x  
4210728

19x  
4211001

4x  
6092649

29x  
4211103

1x  
6257592

2x  
6211916

2x  
4213607

5x  
4210867

4x  
4535930

2x  
6185675

4

1x  
4222113

2x  
6039176

4x  
6416526

28x  
4211085

5x  
4210866

8x  
4211065

2x  
4560184

12x  
6075060

4x  
6005321

2x  
6172134

10x  
4211056

50x  
4211100

2x  
4210651

1x  
4620760

4x  
4505068

6x  
4243831

4x  
4222042

7x  
4211002

2x  
6401210

1x  
4210875

11x  
4211008

6x  
4210998



14x  
4211099



3x  
6313652



2x  
4211115



3x  
4210997



5x  
6187438

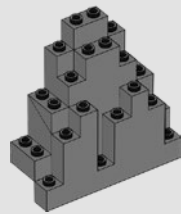

2x  
4216709



4x  
4500517



6x  
4257526



2x  
6435266



25x  
4211107



5x  
4211061

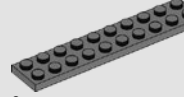

8x  
4210678



1x  
4210794



6x  
6133611



18x  
4211122



7x  
4211067

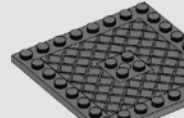

4x  
4299022



1x  
4210802



2x  
4211114

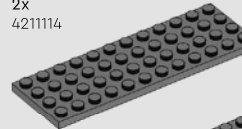

11x  
4210706



4x  
6000970

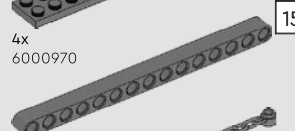

4x  
4542576



2x  
6258887

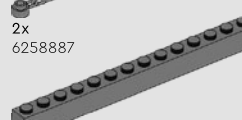

12x  
4210783



5x  
4210796



3x  
6424078



1x  
6227597



1x  
6424074



1x  
6424072



10x  
6208447



1x  
6429472

15

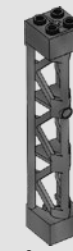

8x  
6263553



9x  
6263550



2x  
6445394



56x  
6214214



2x  
6336564



29x  
4633691



4x  
6215447



38x  
4619636



2x  
6132264



1x  
4611885

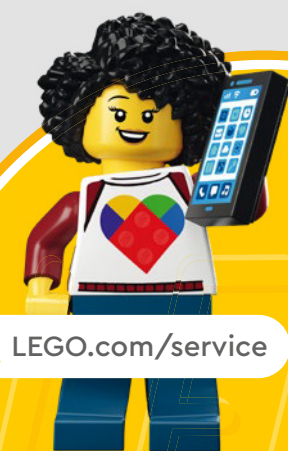

LEGO.com/service



## 76252

LEGO and the LEGO logo are trademarks of the/son des marques de commerce du/son marcas registradas de LEGO Group. ©2023 The LEGO Group.

BATMAN RETURNS and all related characters and elements © & ™ DC and Warner Bros. Entertainment Inc. (s23)

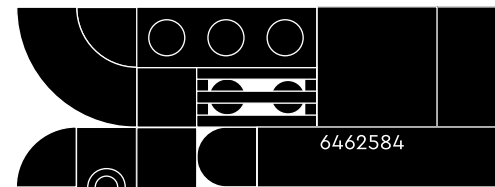

6462584