



MARVEL

76276



Q LEGO® Builder



Get excited about our new packaging!

We're switching from plastic to paper-based packaging. That's why you might find a mix of paper and plastic in our boxes!

Nos nouveaux emballages vous emballeront !

Nous passons des emballages en plastique aux emballages à base de papier. C'est pourquoi vous pourriez trouver un mélange de papier et de plastique dans nos boîtes !

¡Te presentamos nuestros nuevos empaques!

Estamos sustituyendo las bolsas de plástico por bolsas con base de papel. ¡Por eso, puedes encontrar una mezcla de papel y de plástico en nuestras cajas!

[LEGO.com/sustainable-packaging](https://www.lego.com/sustainable-packaging)



Q LEGO® Builder

BUILDER



Apple and the Apple logo are trademarks of Apple Inc., registered in the U.S. and other countries and regions. App Store is a service mark of Apple Inc. Google Play and the Google Play logo are trademarks of Google LLC. Tencent and the Tencent logo are trademarks of Tencent Inc.

Q LEGO.com/devicecheck

EN Ask parents' permission before going online | **DE** Eltern um Erlaubnis bitten, bevor du online gehst | **FR** Demande l'autorisation d'un parent avant d'aller en ligne | **IT** Chiedi il permesso ai tuoi genitori prima di andare online | **ES** Pídeles permiso a tus papás antes de conectarte a Internet | **PT** Pede autorização aos pais antes de acederes online | **ZH** 上网前应先征得父母的同意 | **PL** Poproś rodziców o zgodę, zanim wejdiesz do Internetu | **CS** Než půjdeš na internet, požádej rodiče o svolení | **SK** Skôr než pôjdeš na internet, vypýtaj si povolenie od rodičov | **HU** Kérj szülői engedélyt, mielőtt online csatlakoznál! | **RO** Cere permisiunea părinților înainte de a te conecta online | **BG** Поискайте разрешение от родител, преди да влезете онлайн | **LV** Pirms došanās tiešsaistē palūdz atļauju vecākiem | **ET** Enne Interneti kasutamist küsi vanematelt luba | **LT** Prieš prisijungdami prie interneto, atsiklauskite tėvų





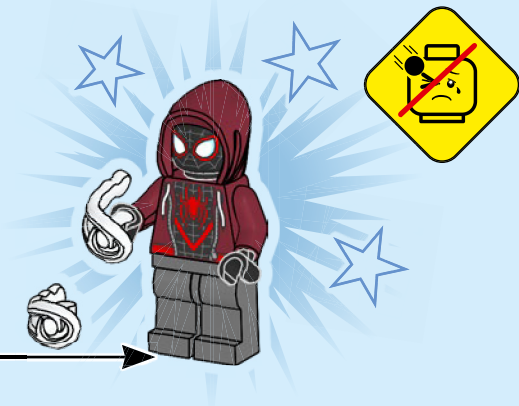
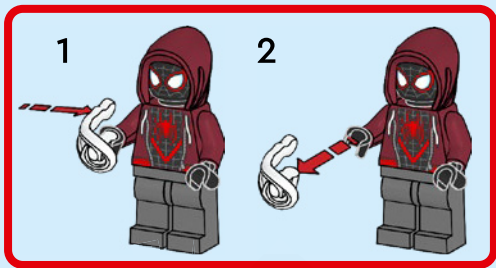
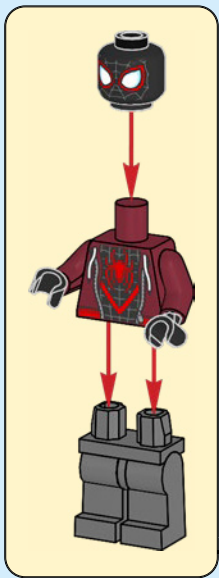

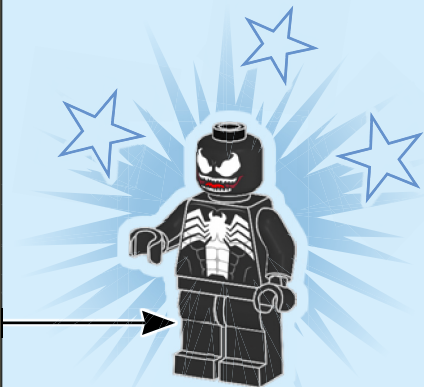
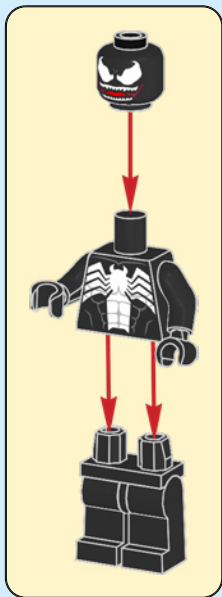

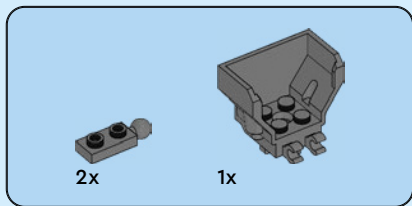

1

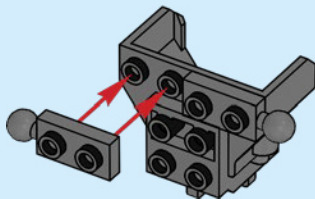



1x



1x

2

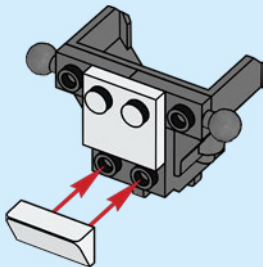



2x

3

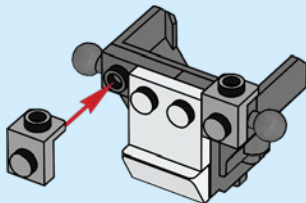



1x

4

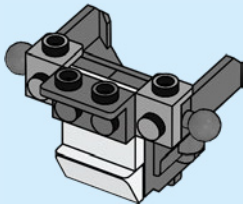

10



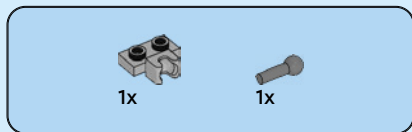

5

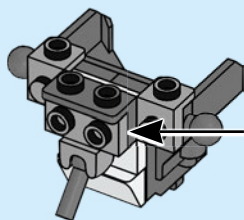
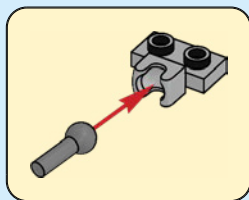



2x

6

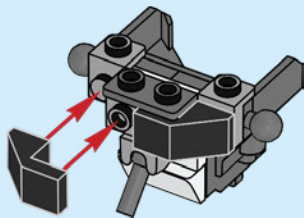

2x

7

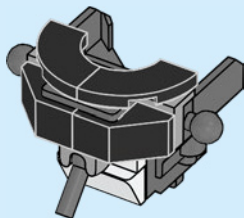

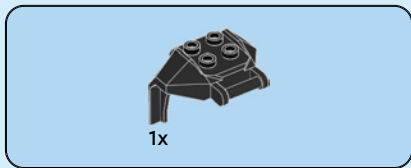

8

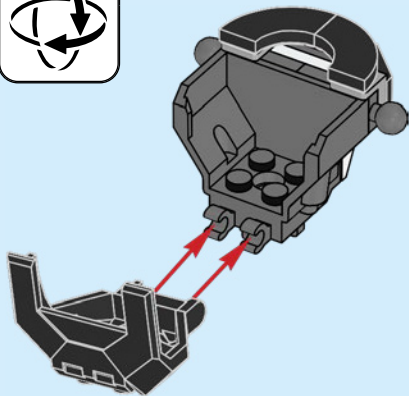
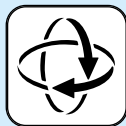



1x

9

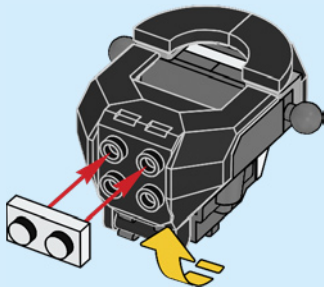



1x

10

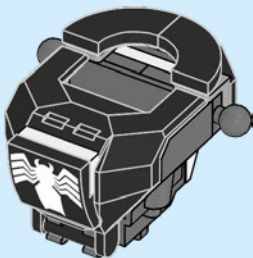



1x

11

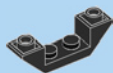
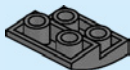

1x

12

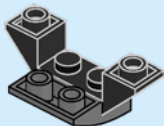



1x

13

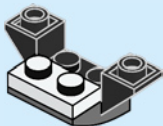

1x

14

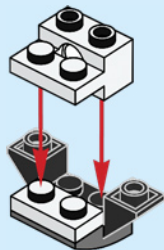



2x

15

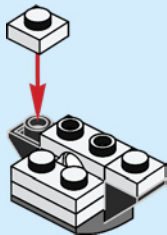



1x

16

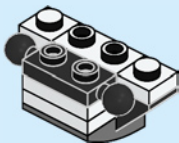



1x

17



20





2x

18

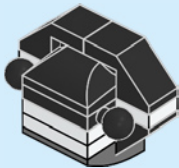



1x

19

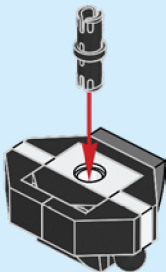

20

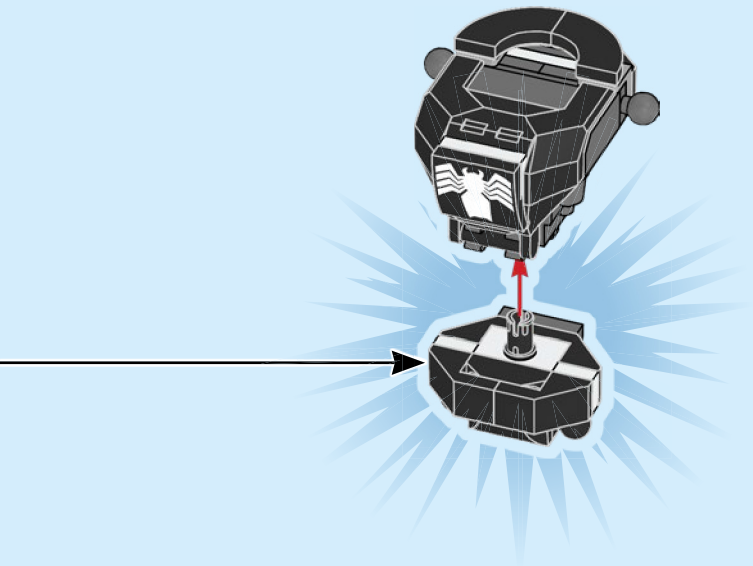

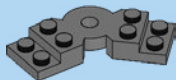

1x

21

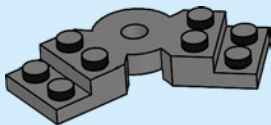



2x

22

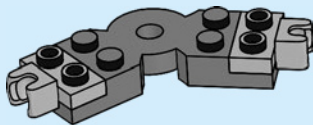



1x



1x

23

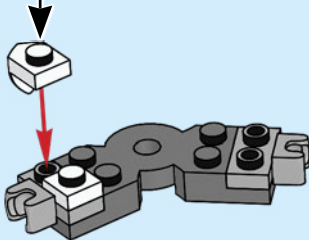



1x



1x

24

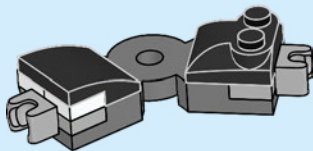



1x

25

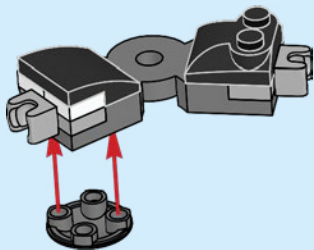



1x

26

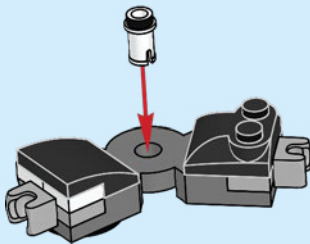



1x

27

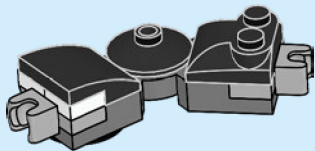

28

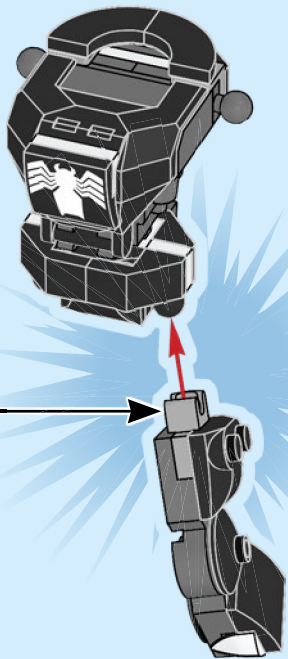

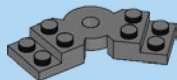

1x

29

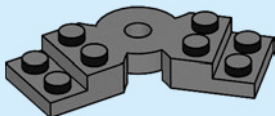



2x

30

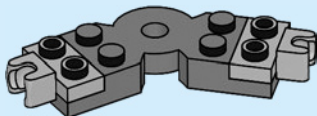

1x



1x

31

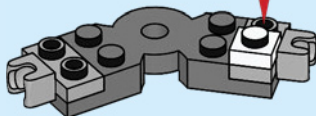



1x



1x

32

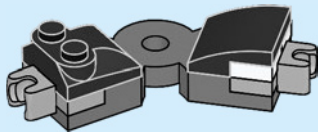



1x

33

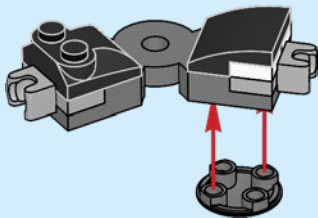



1x

34

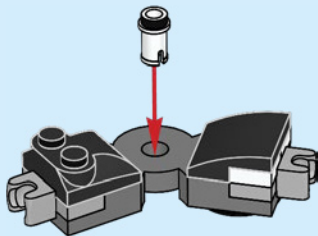



1x

35

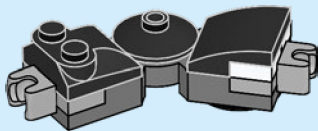

36

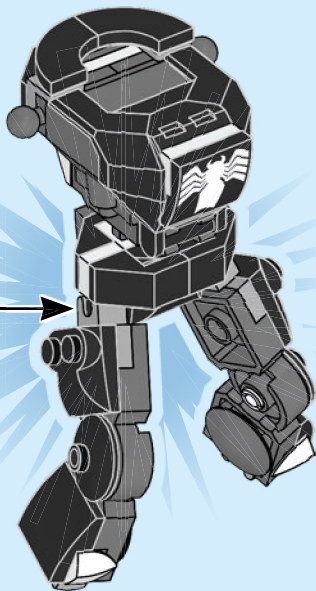



2x

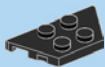

1x

37

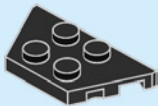

1x

38



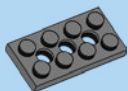

1x

39

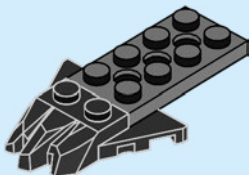



1x



1x

40

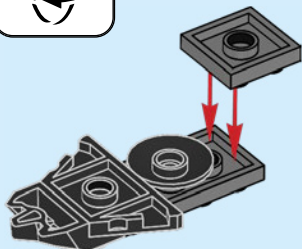
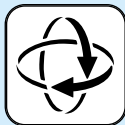



1x



1x

41

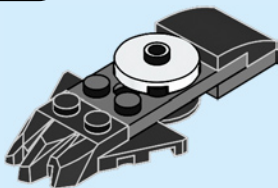

1x

42

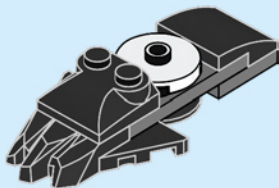



1x

43

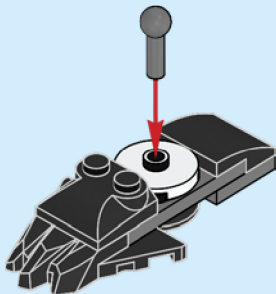

2x



44

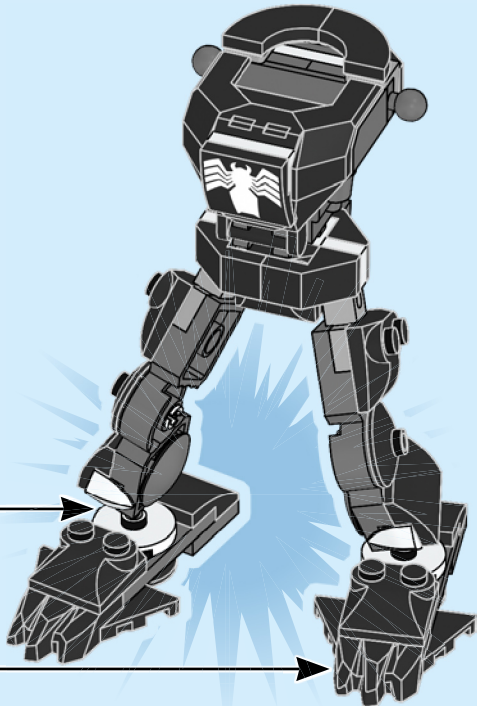

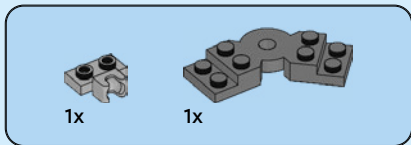
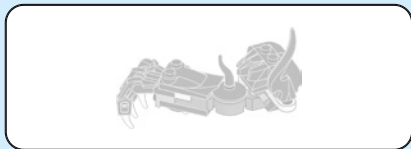

45

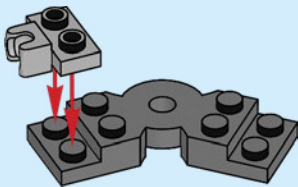

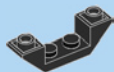

1x

46

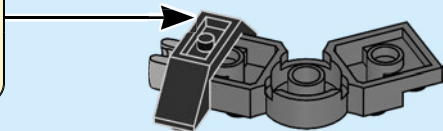
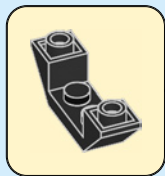
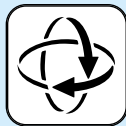

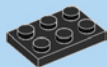

1x



1x

47

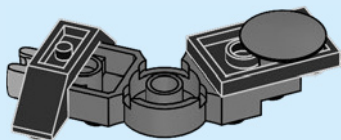
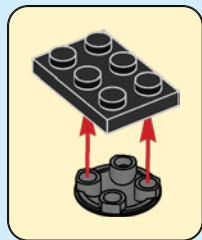



1x



1x



1x

48

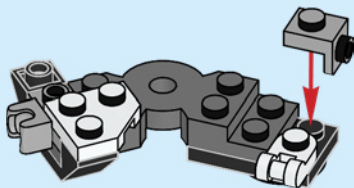
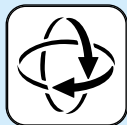



1x



1x



1x

49

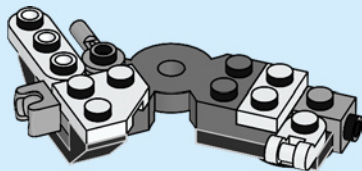



1x



1x

50

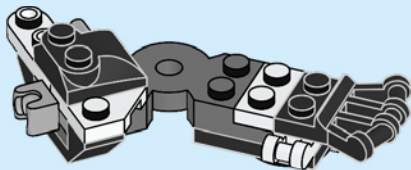



1x



1x

51

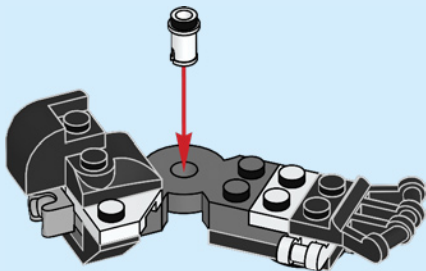



1x



1x

52

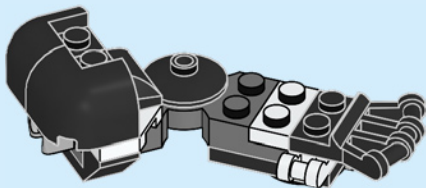



1x

53

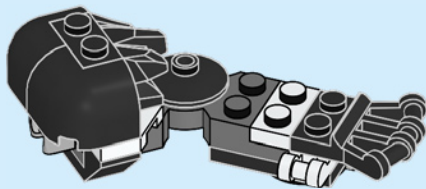

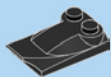

1x

54

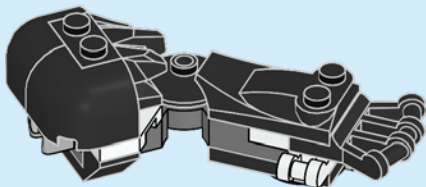



55

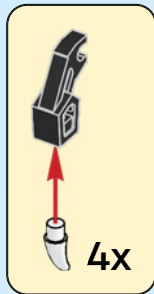
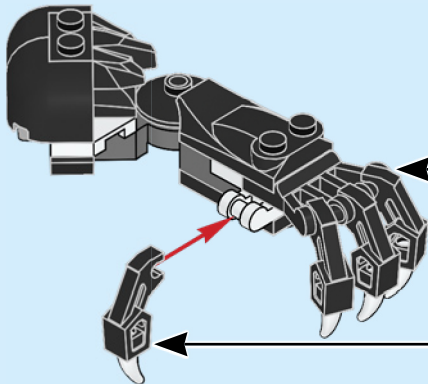



1x



1x

56

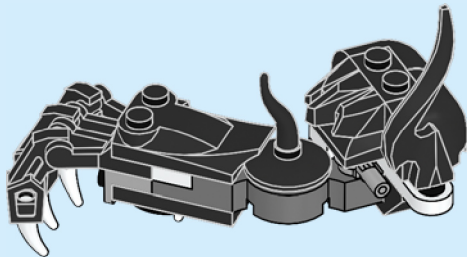

57

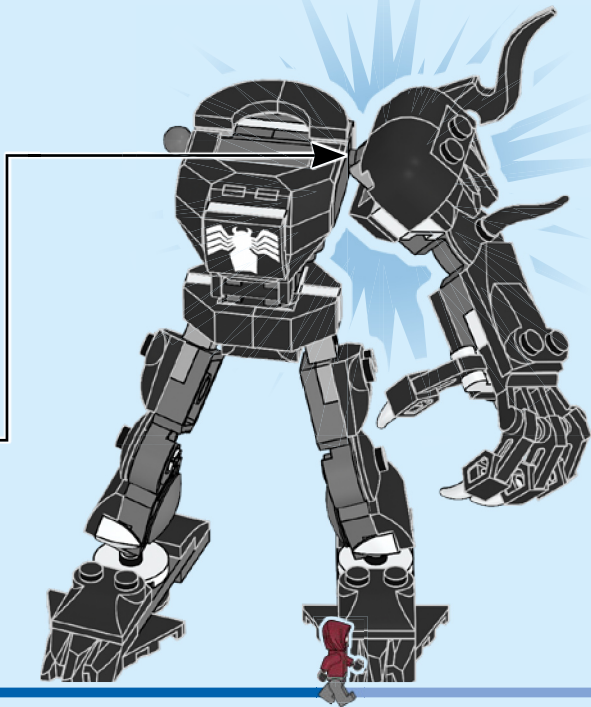

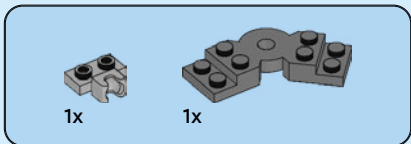
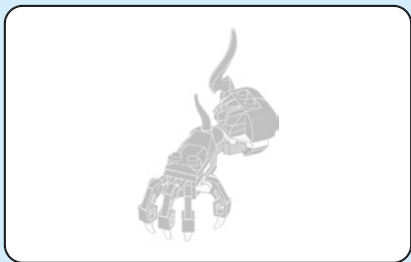

58

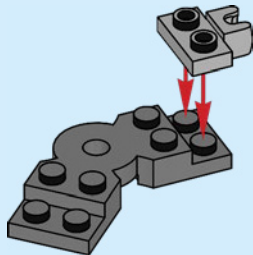

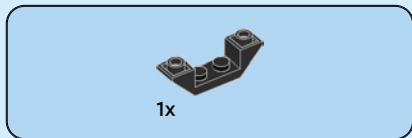

59

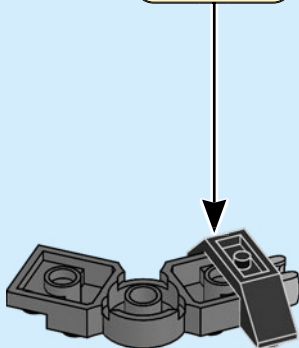
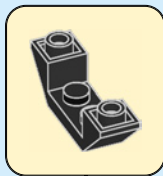

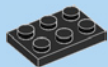

1x



1x

60

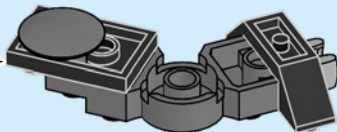
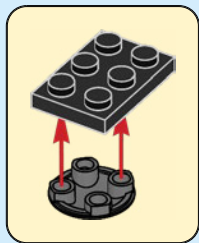



1x



1x



1x

61

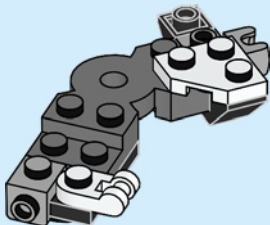
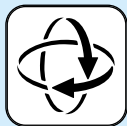



1x



1x



1x

62

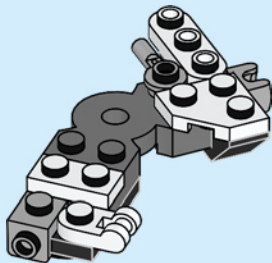



1x



1x

63

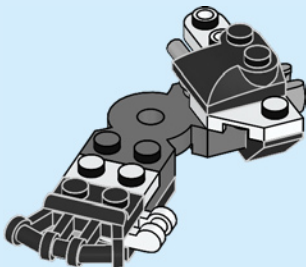



1x



1x

64

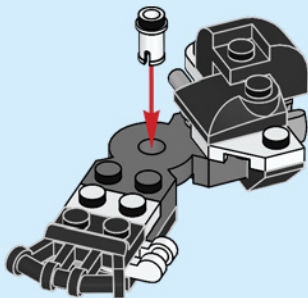



1x



1x

65

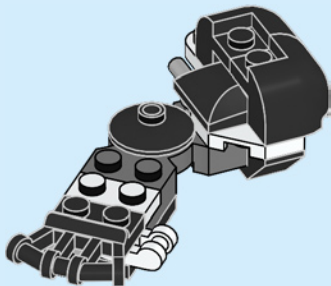



1x

66

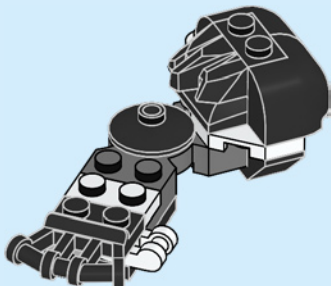

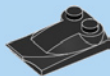

1x

67

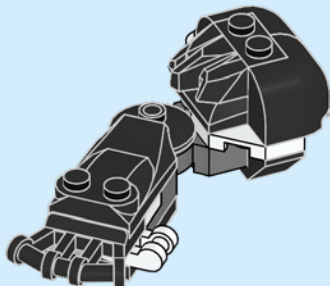



4x



4x

68

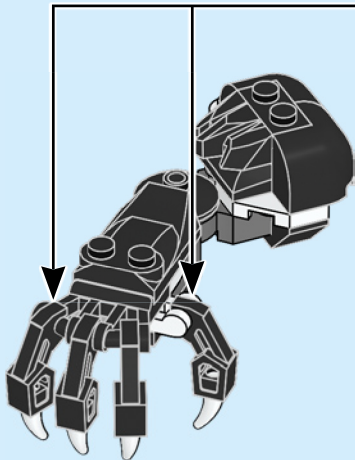

4x

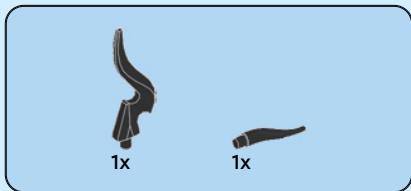

69

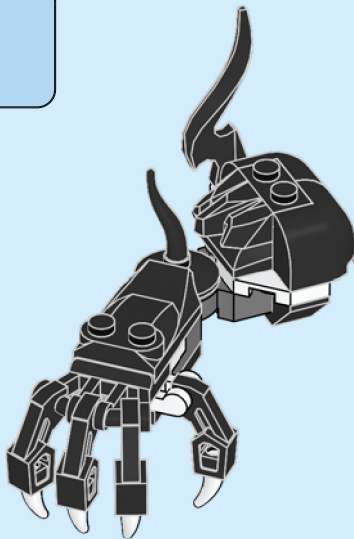

70

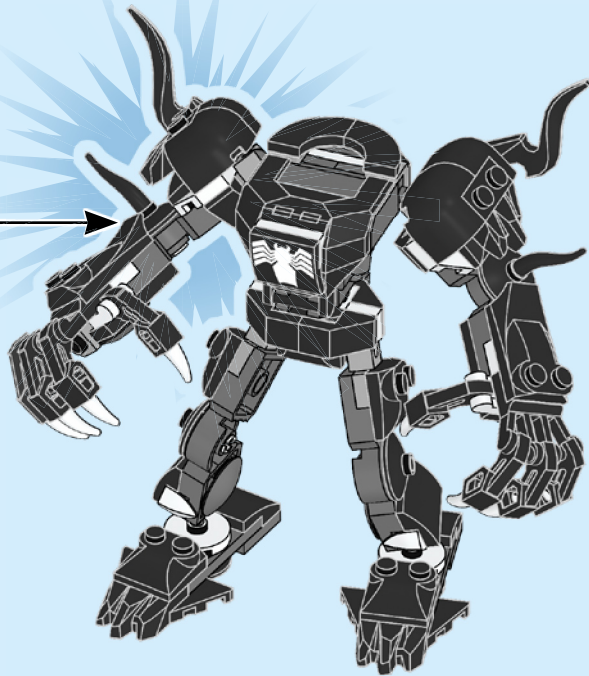

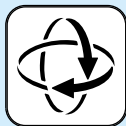
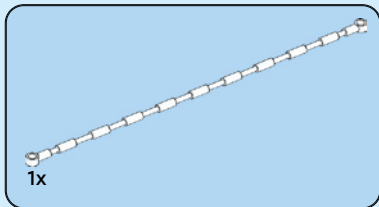

71

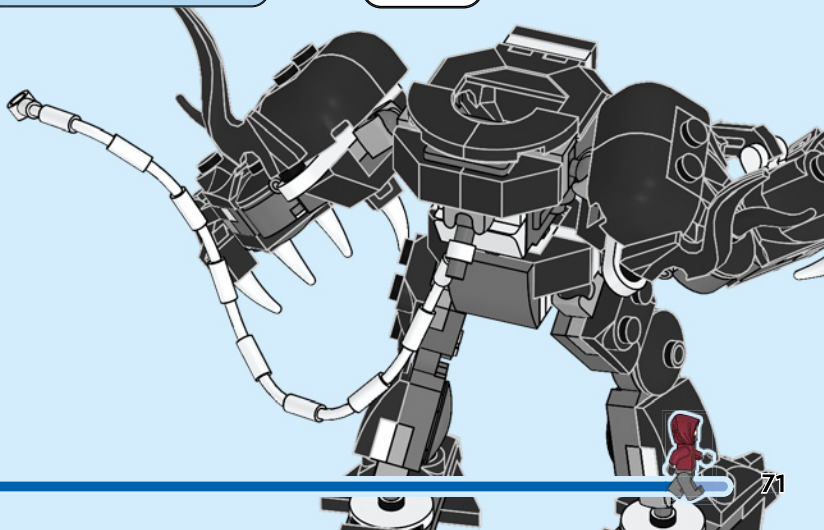

72

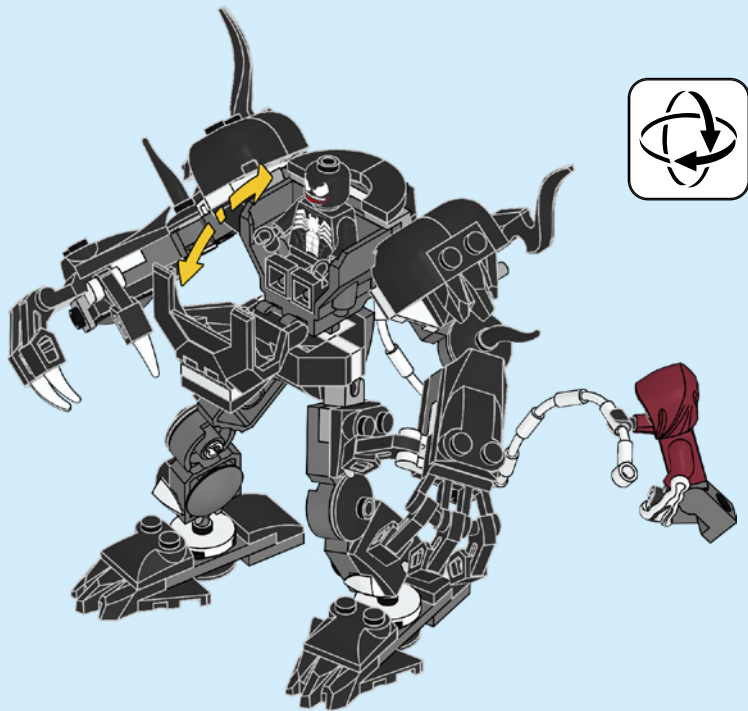

72

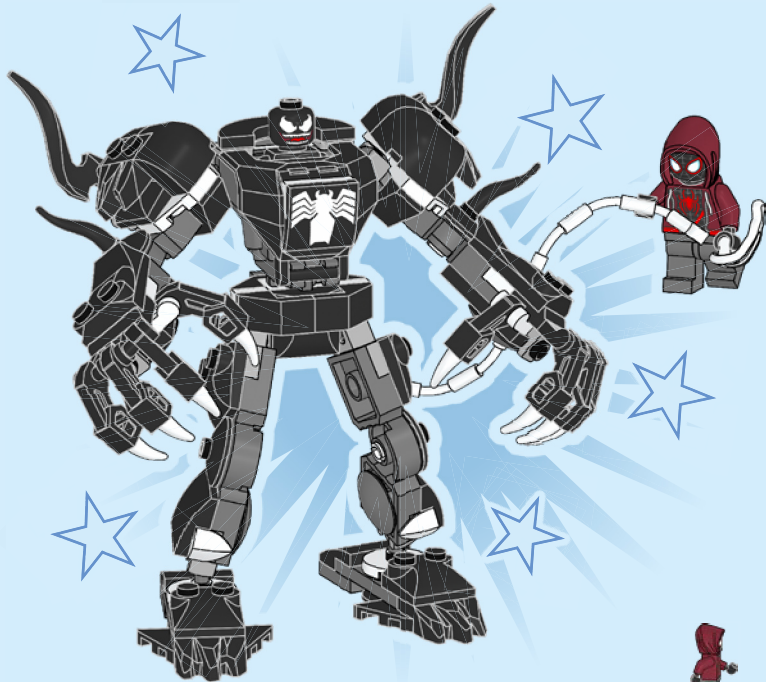





2x
4604304



1x
6467541



2x
4531412



2x
302126



2x
4285883



3x
6267482



1x
6470126



1x
6288460



1x
6331698



4x
6248078



2x
6227897



7x
6043656



3x
6364352



4x
4278274



1x
4222693



1x
6000606



2x
6123814



1x
6344820



2x
4211094



2x
4227398

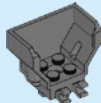

1x
6384443



4x
6395097



[LEGO.com/service](https://www.LEGO.com/service)

YOU COULD
WIN



Scan this QR code or go to
LEGO.COM/PRODUCTFEEDBACK and give us
your short feedback about this LEGO® set
for a chance to win a cool LEGO prize.

Terms and Conditions apply*

EN: YOU COULD WIN. Terms and Conditions apply* **DE: Du könntest GEWINNEN.** Es gelten die Teilnahmebedingungen* **FR: Tu pourrais GAGNER.** Des conditions s'appliquent* **IT: Potresti VINCERE tu.** Termini e condizioni sono applicabili* **ES: Puedes GANAR.** Aplican términos y condiciones* **PT: Poderá GANHAR.** Aplicam-se termos e condições* **ZH: 轻松获奖.** 条款和条件适用* **PL: Szansa na WYGRANĄ.** Obowiązują warunki korzystania* **CS: Máte šanci VYHRÁT.** Platí všeobecné smluvní podmínky* **SK: Máte šancu VYHRÁT.** Platia všeobecné zmluvné podmienky* **HU: TE IS NYERHETSZ.** Felhasználási feltételek érvényesek* **RO: Ai putea CÂȘTIGA.** Se aplică termenii și condiții* **BG: Можете да СПЕЧЕЛИТЕ.** Има определени правила и условия* **LV: Tu vari LAIMĒT.** Ir spēkā noteikumi un nosacījumi.* **ET: Sul on võimalus VÕITA.** Kehtivad tingimused* **LT: Jūs galite LAIMĖTI.** Taikomos sąlygos*

*[LEGO.com/productfeedback-terms](https://www.lego.com/productfeedback-terms)

LEGO and the LEGO logo are trademarks of the/son des marques de commerce du/
son marcas registradas de LEGO Group. ©2024 The LEGO Group.

© 2024 MARVEL

6499625