

The LEGO logo is positioned in the top left corner, featuring the word "LEGO" in white, bold, sans-serif font with a black outline, set against a red square background.

THE HOBBIT

AN UNEXPECTED JOURNEY

79004



Special The Hobbit Trilogy
Preview Set!

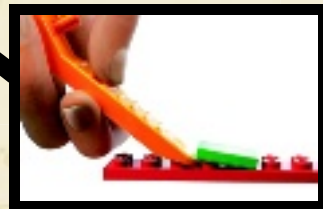
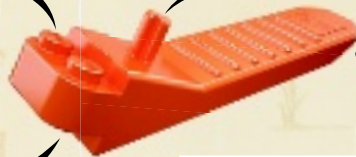

East lie the Iron Hills
where is Dair



Here was Girion
lord in Dale

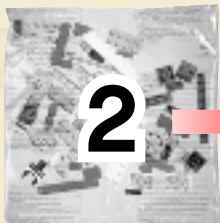

Here is
the gateway
of the Long
Lake

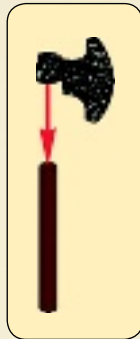
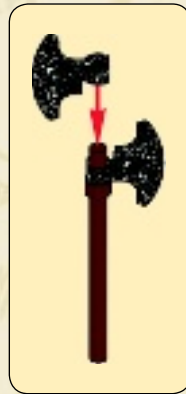
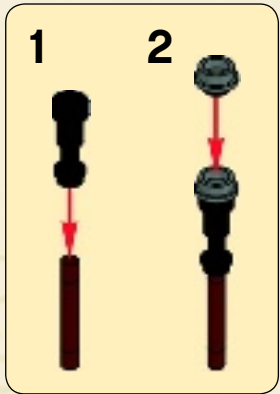
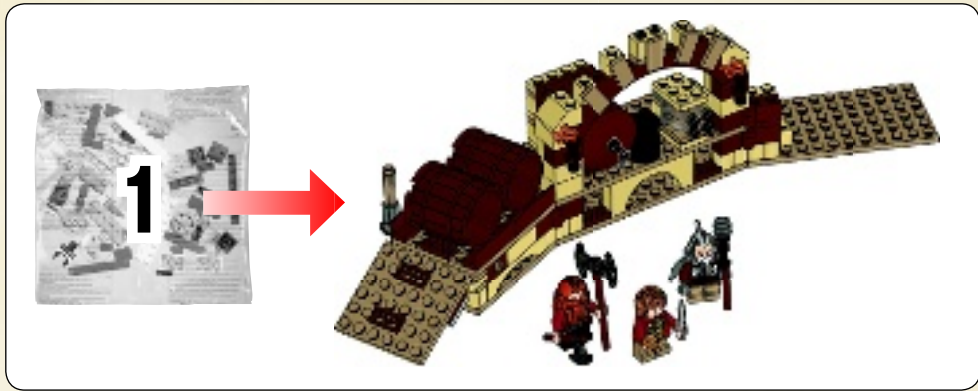

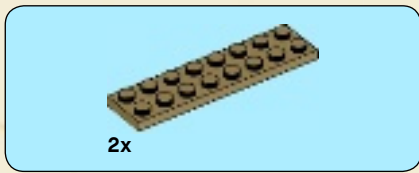

1

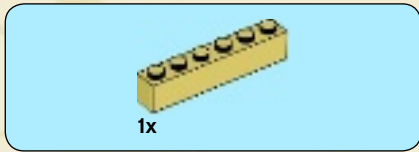

2

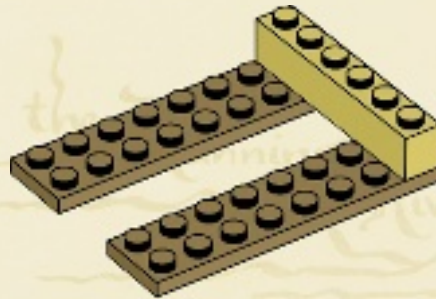

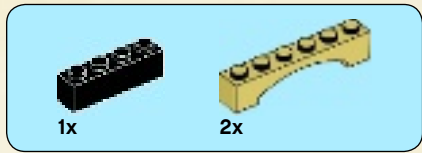

3

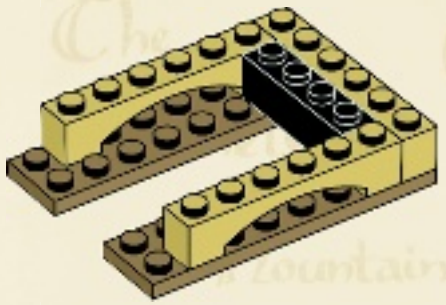

4

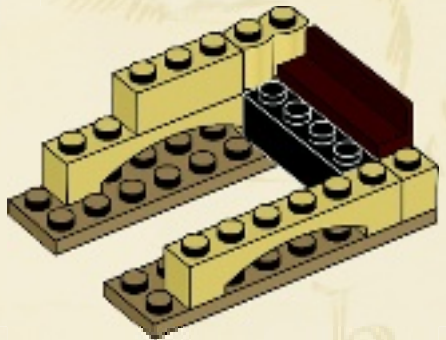

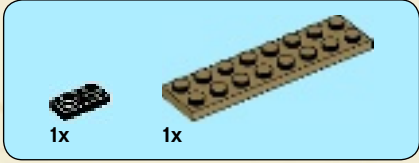
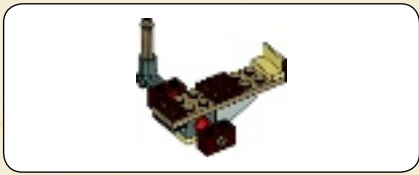

1

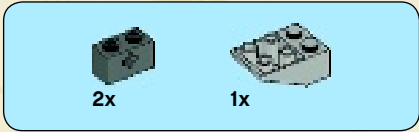
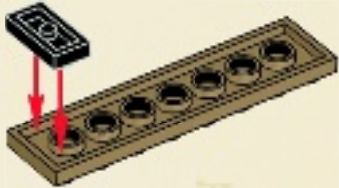

2

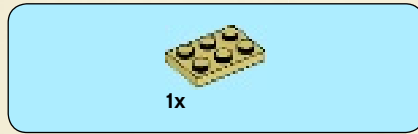
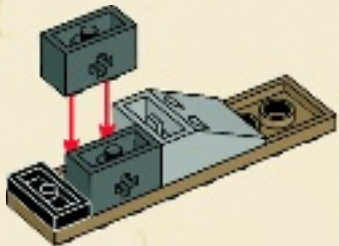

3

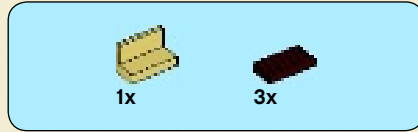
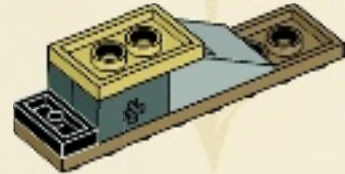

4

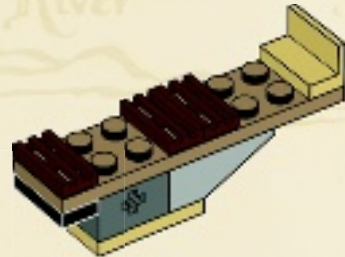
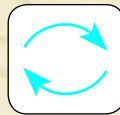



5

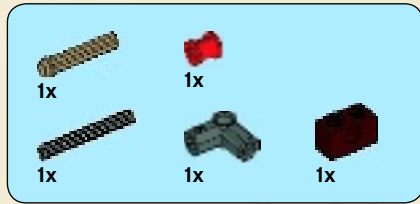
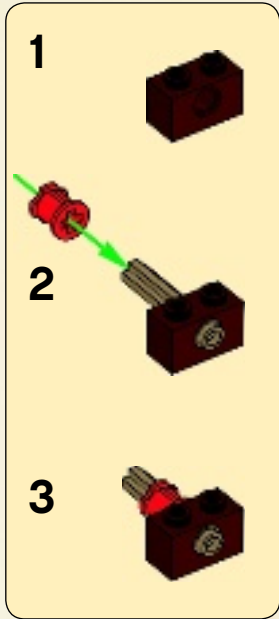

6

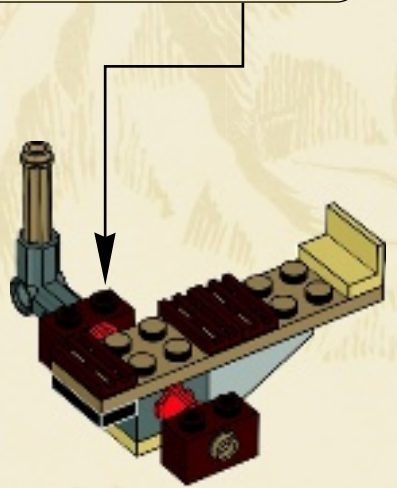
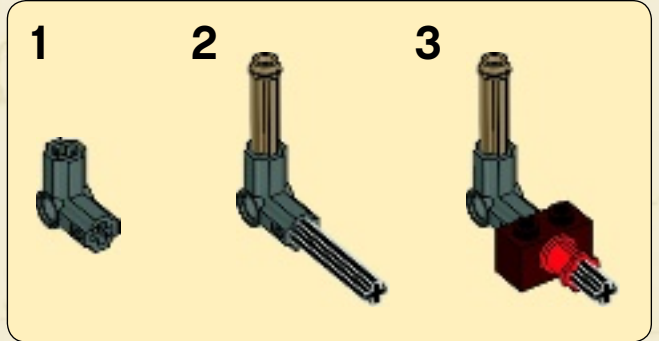

7

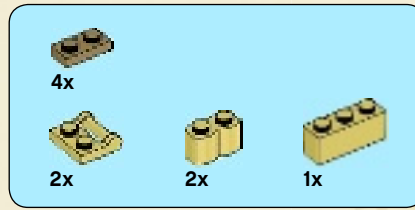
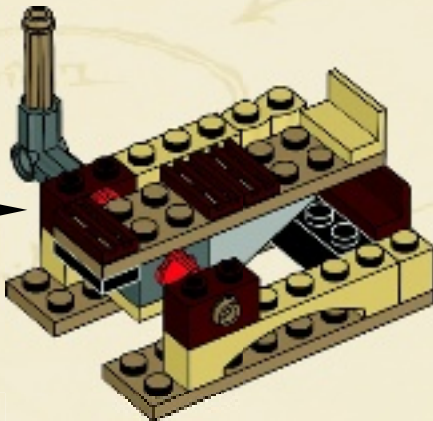

8

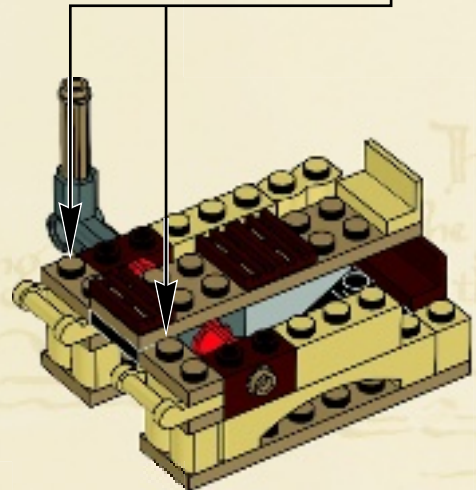
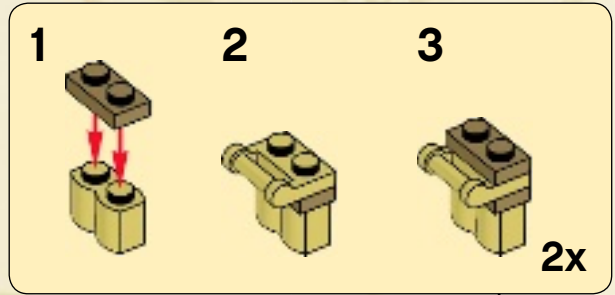

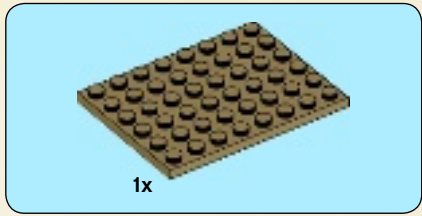
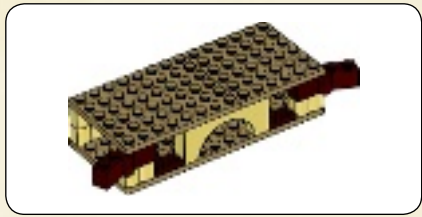

1



2

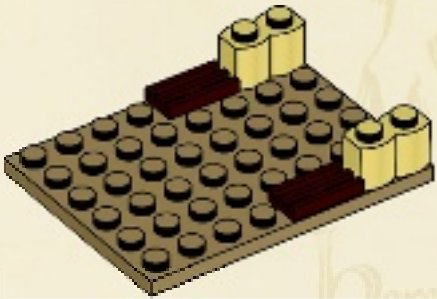

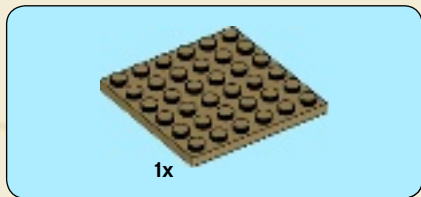

3

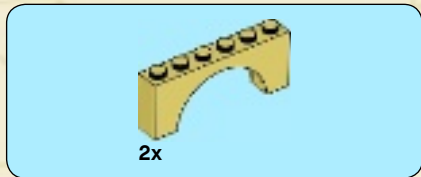
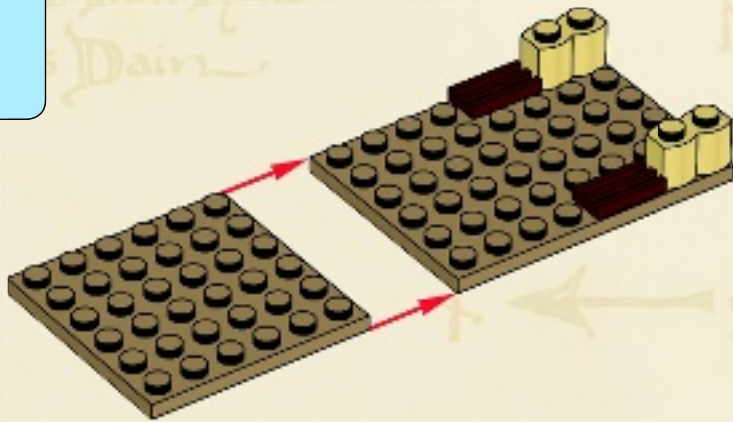

4

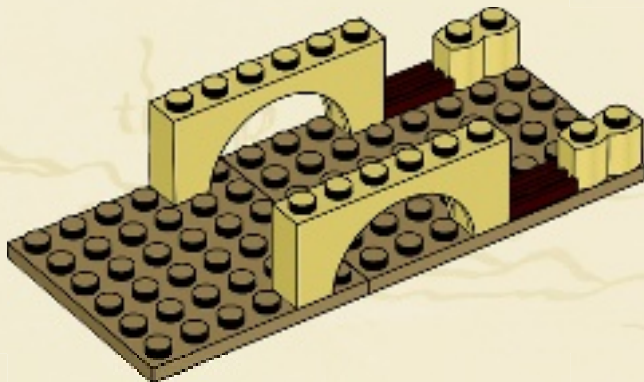

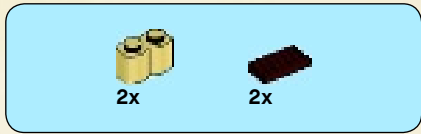

5

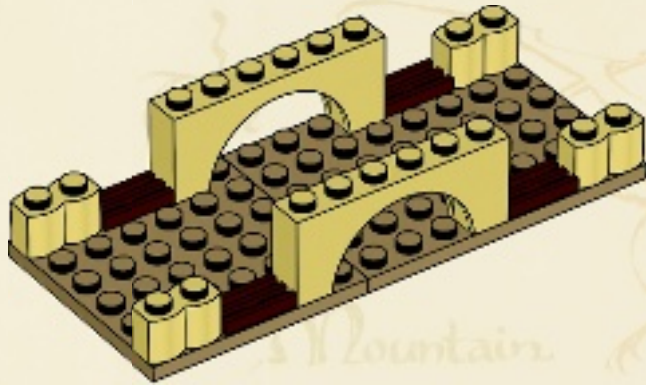

6

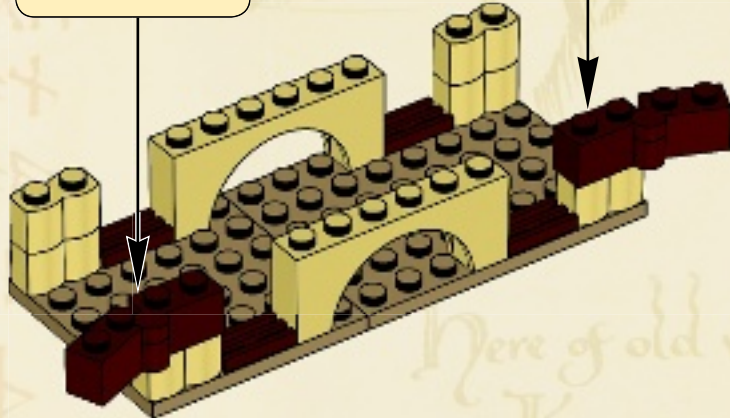
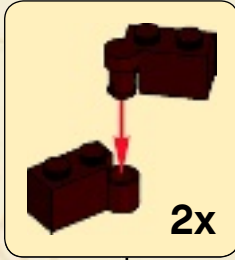

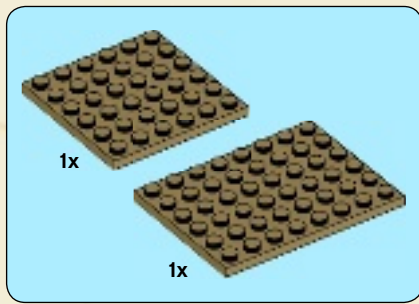

7

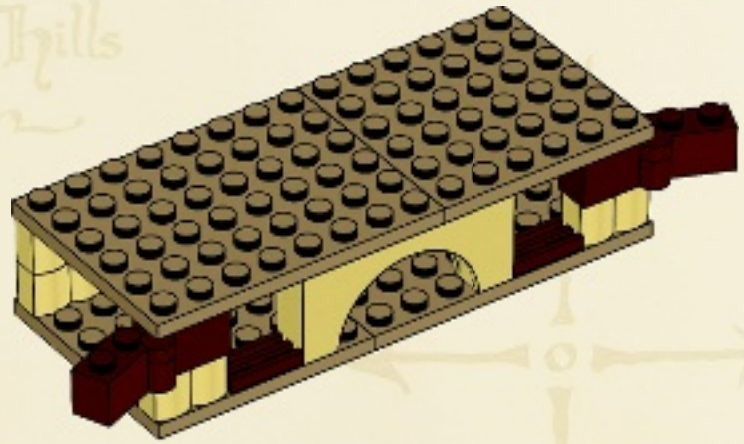

8

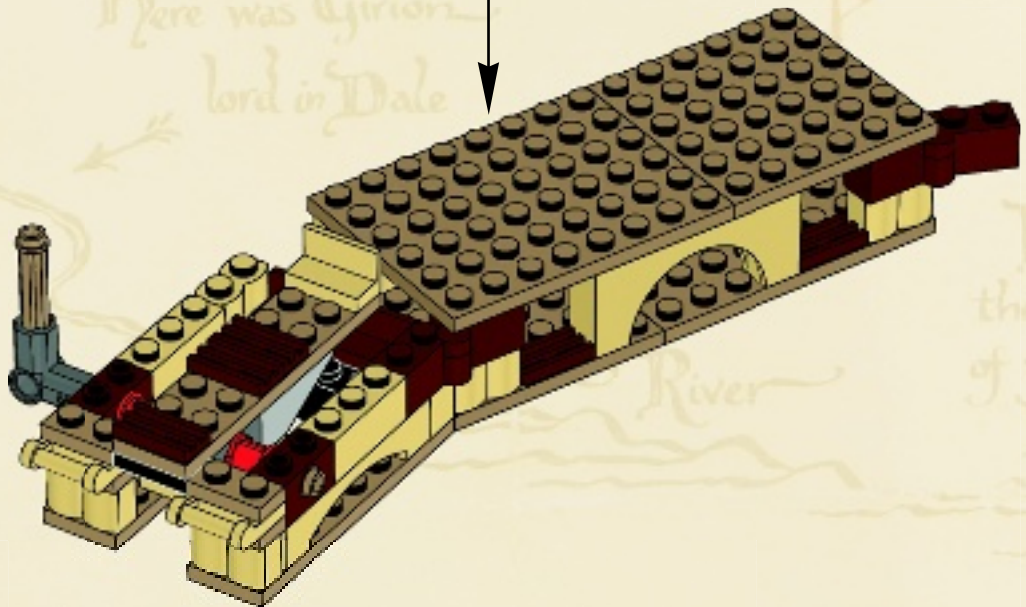

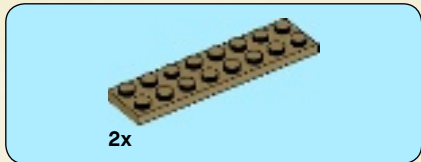

9

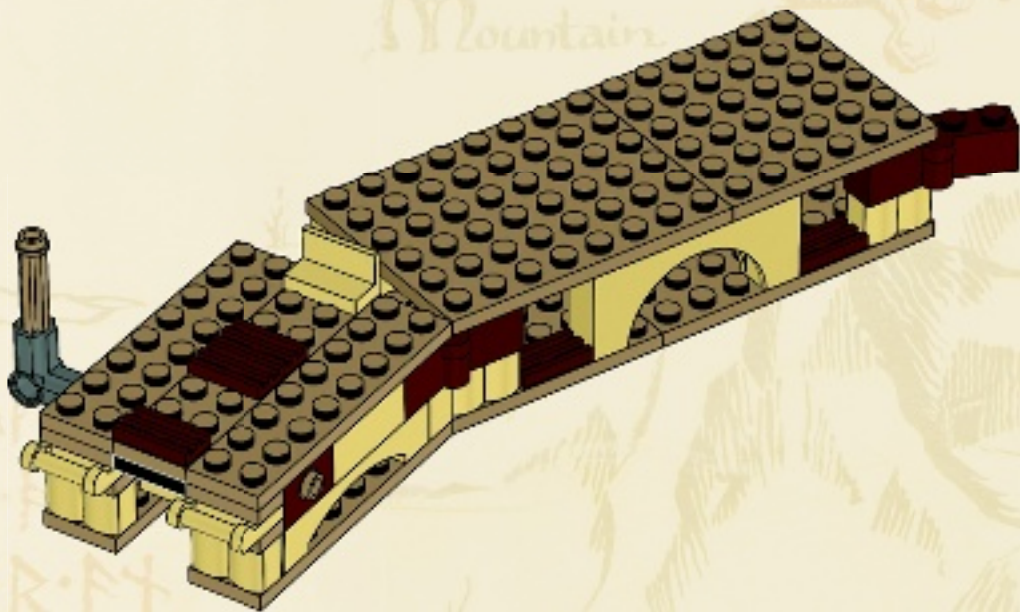



10

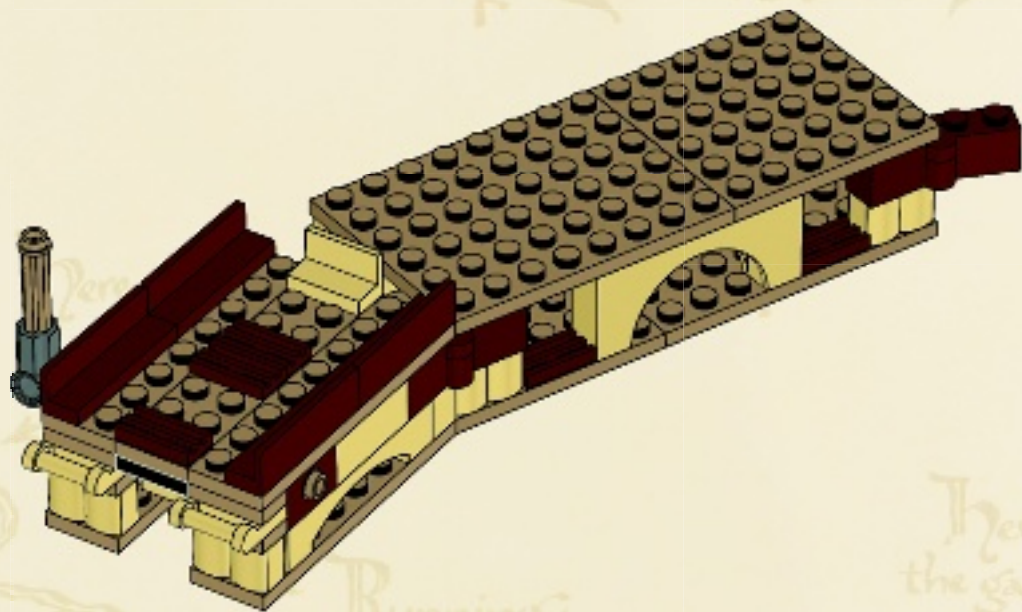

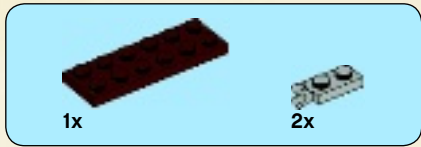

11

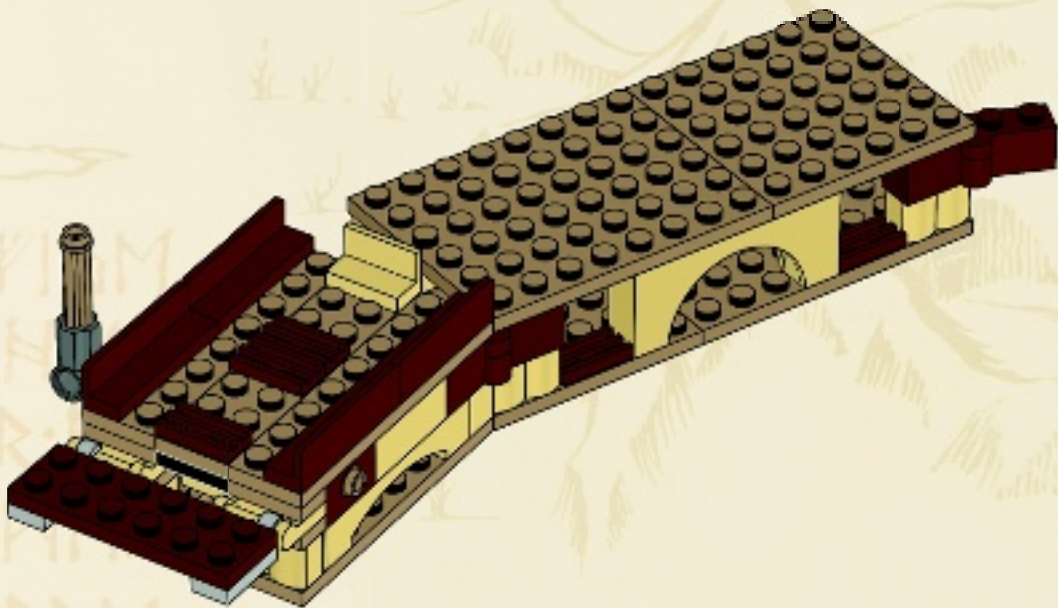
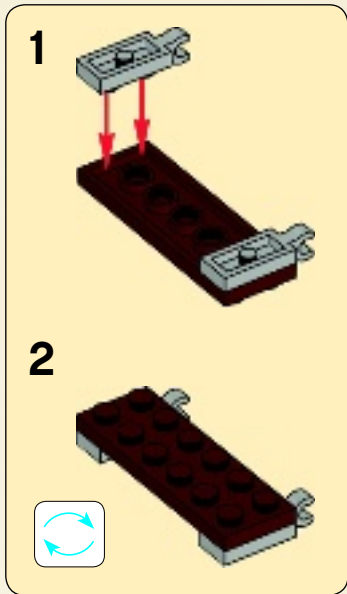

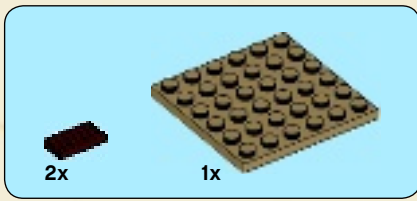

12

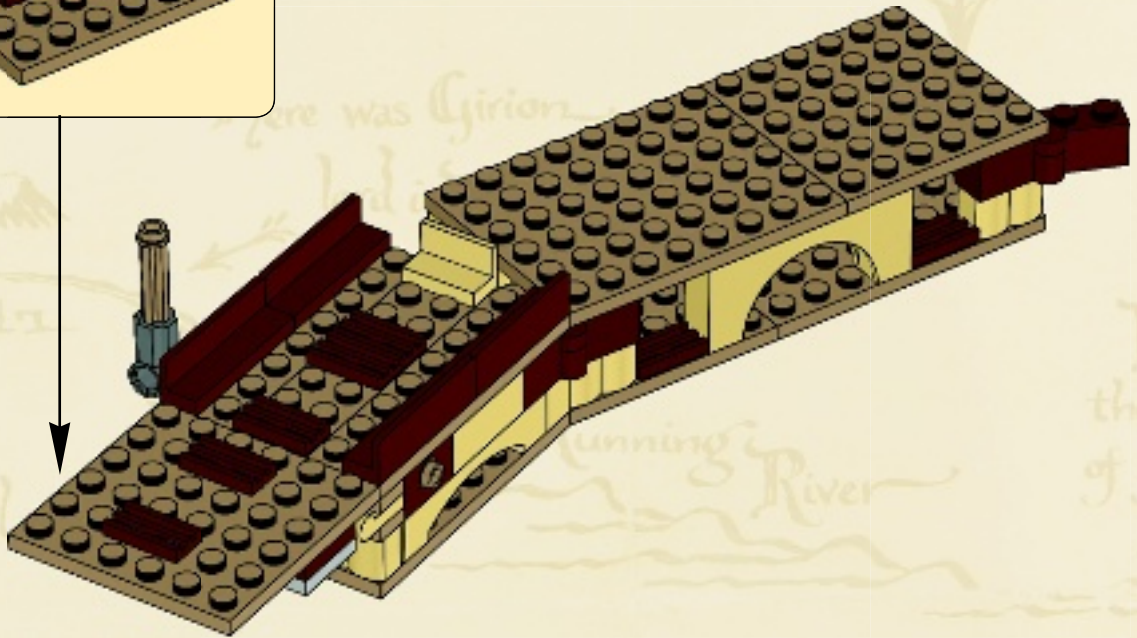
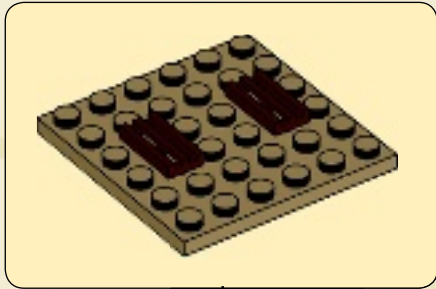

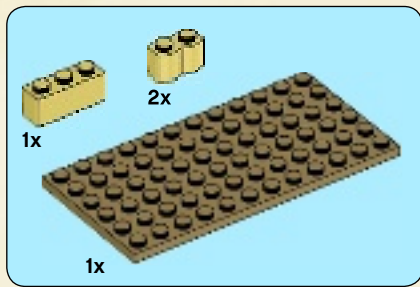

13

1

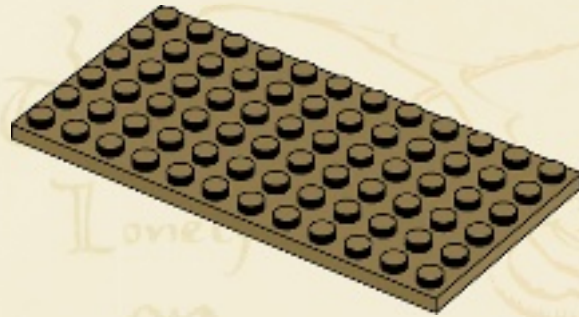

2



3



↑ East lie the Iron Hills
where is Dair

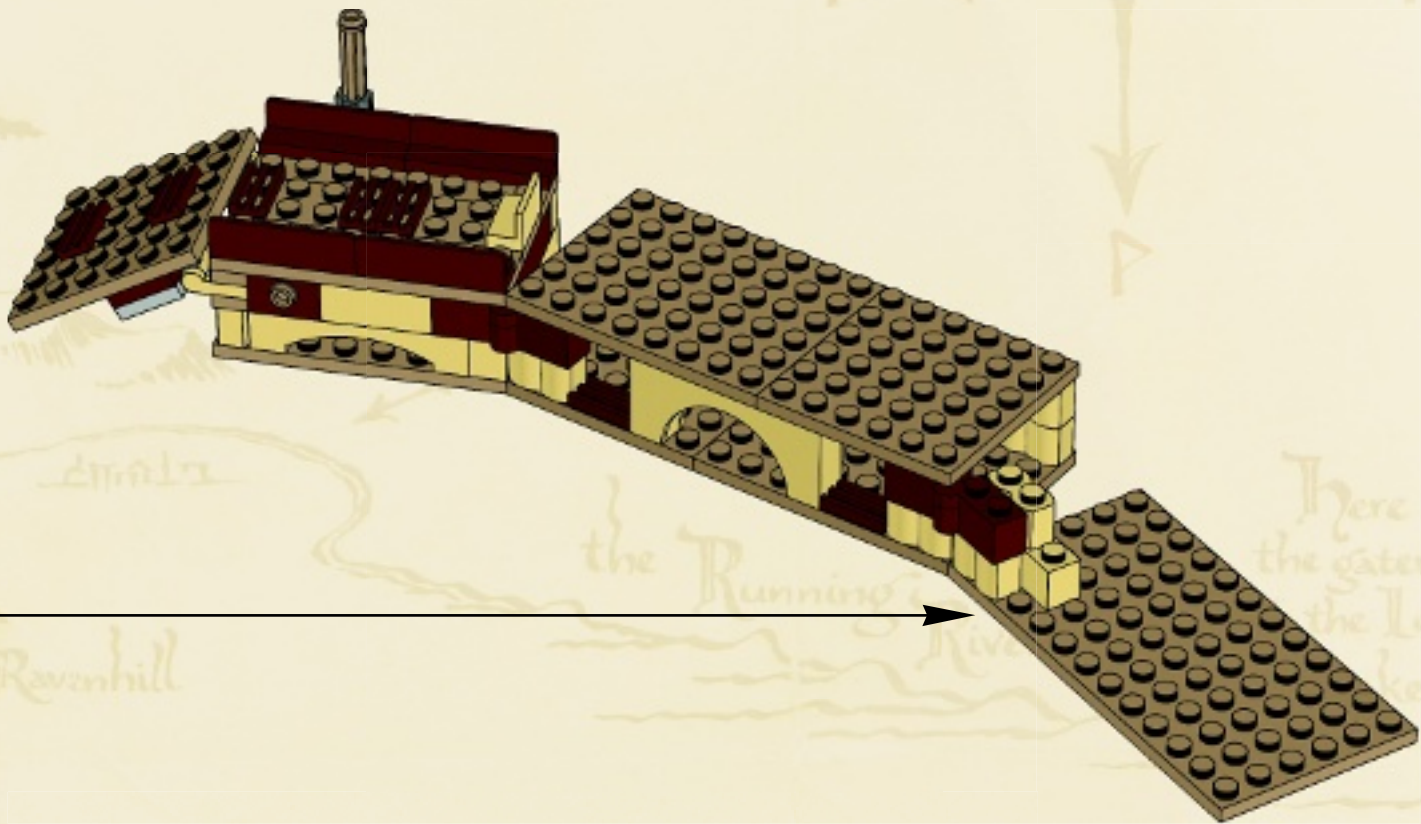



1x

14

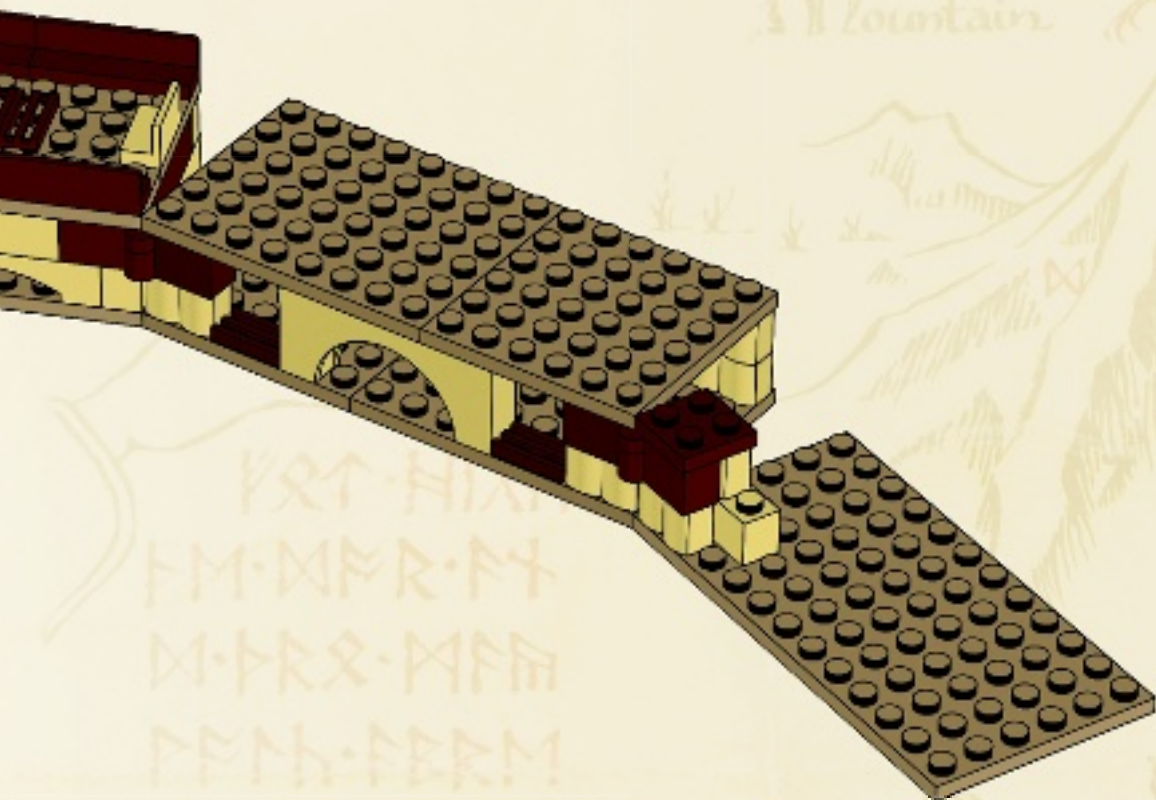

1x 2x 1x

15

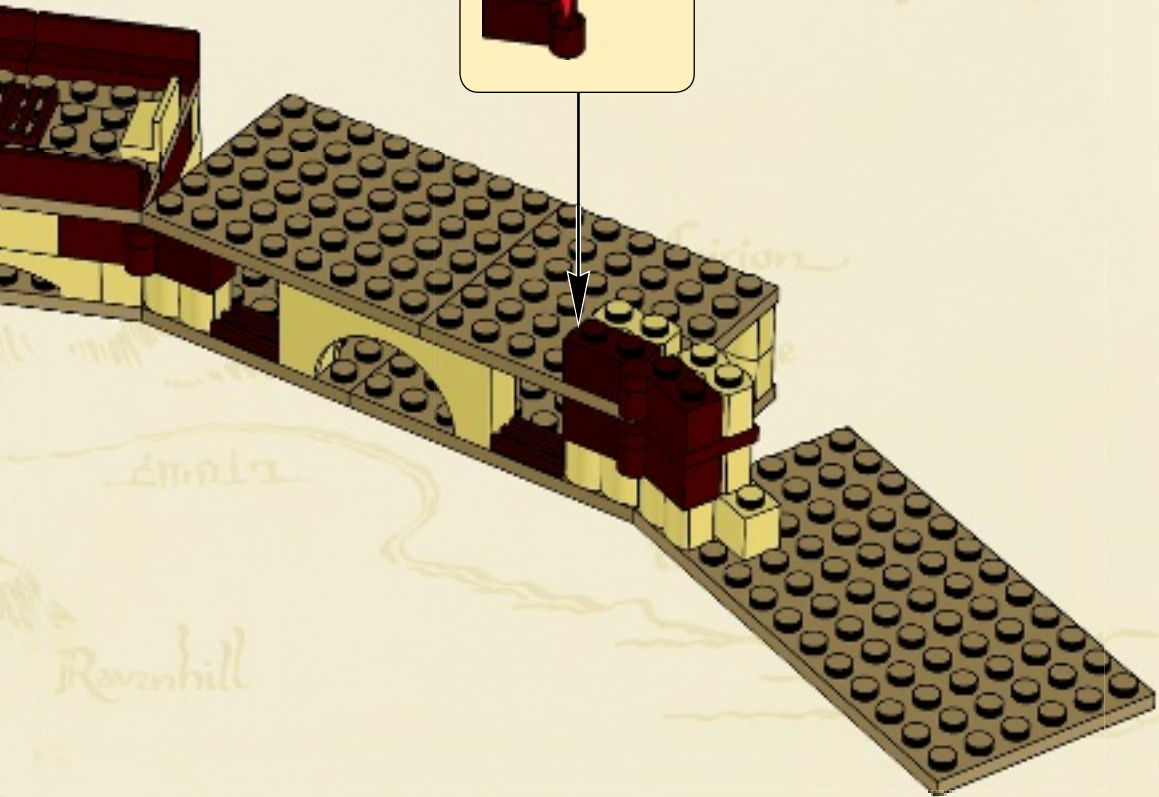
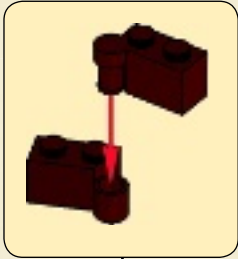

		
1x	1x	2x

16

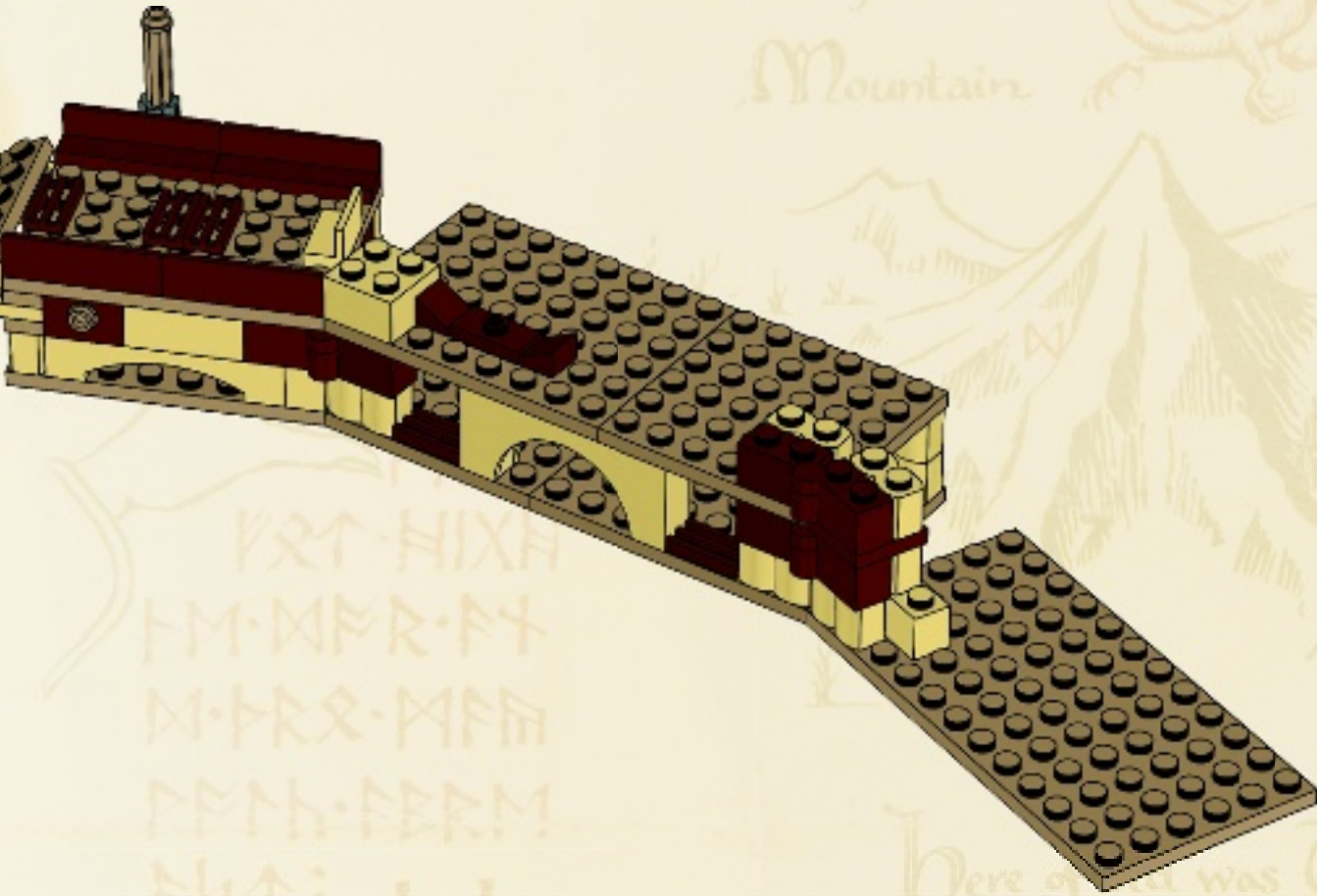



2x

17

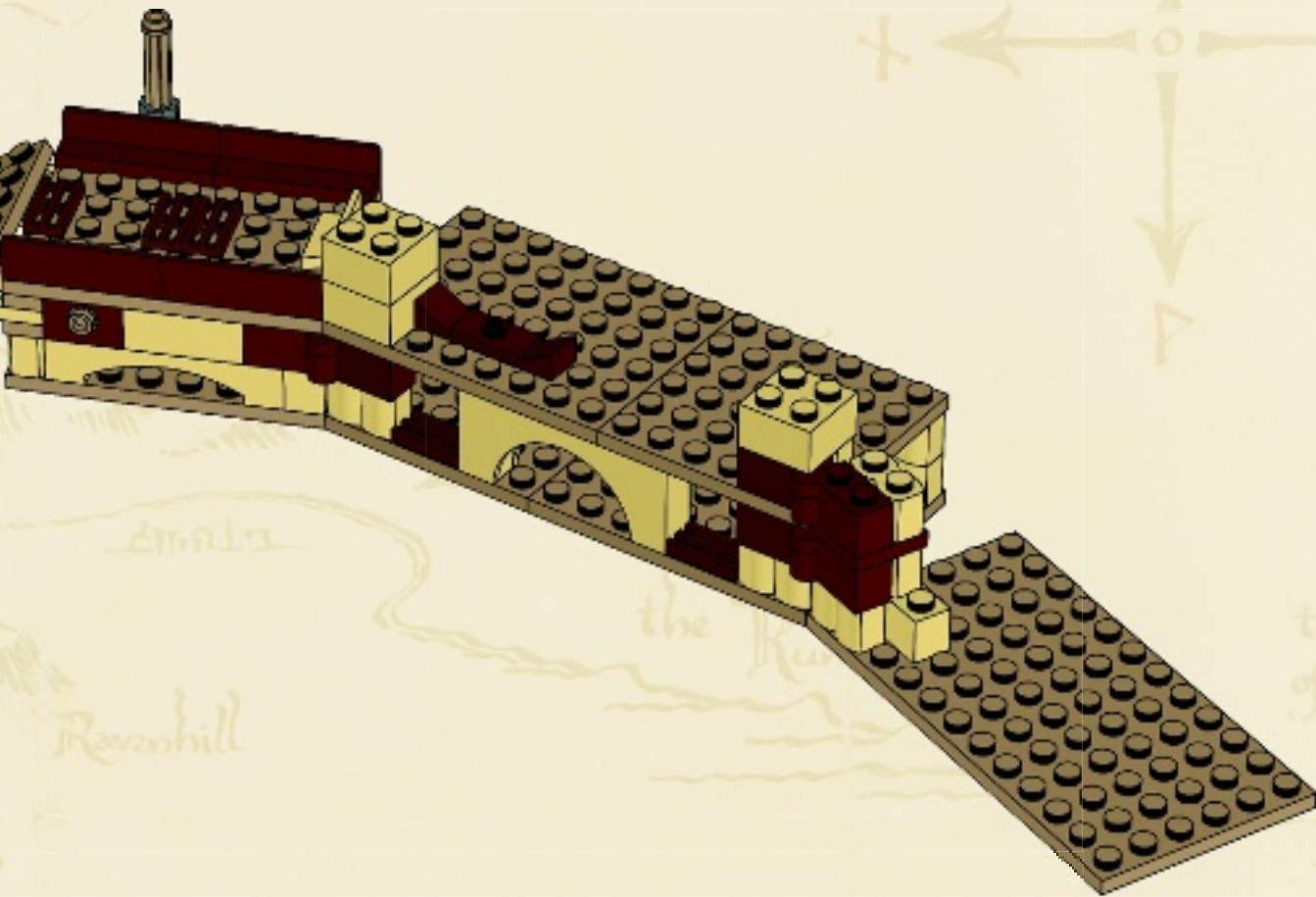



2x



2x

18

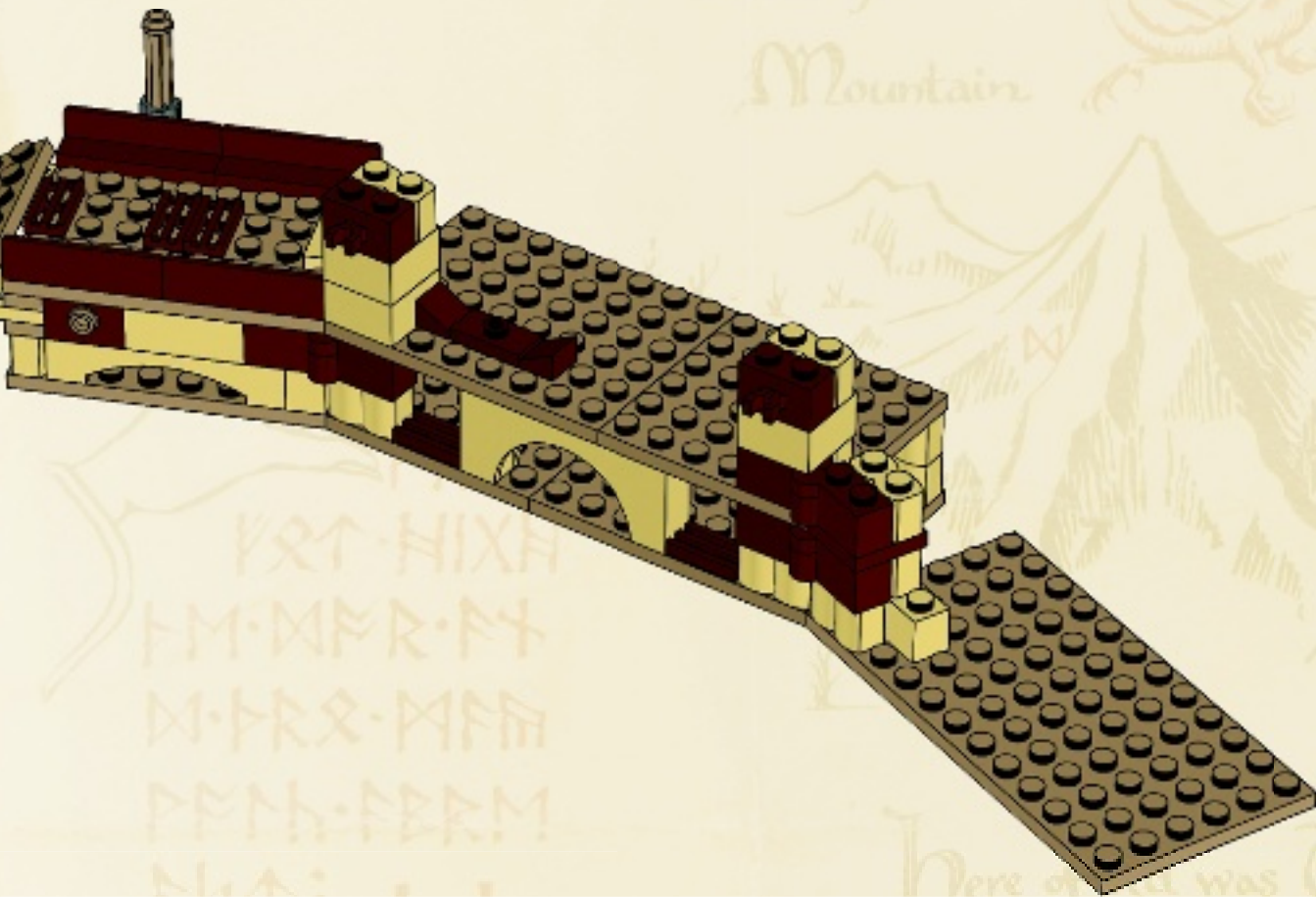



2x

19

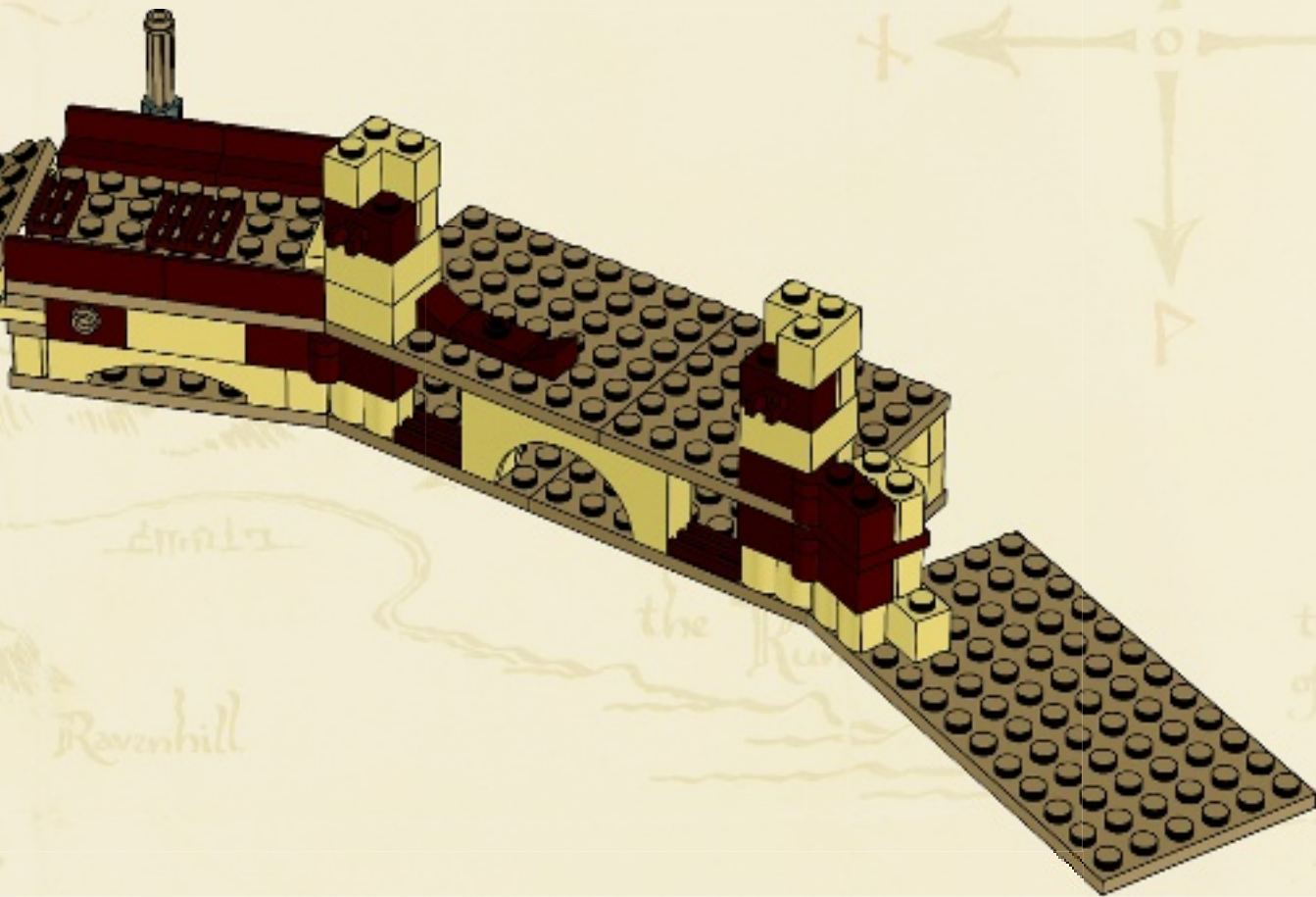

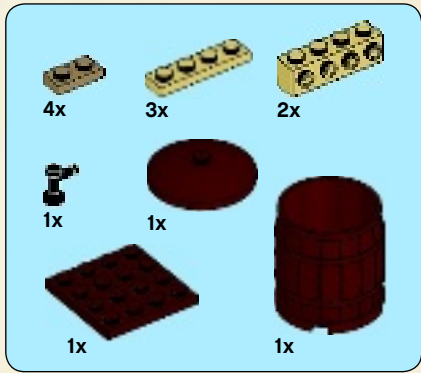

20

1

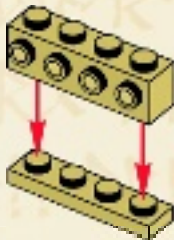

2

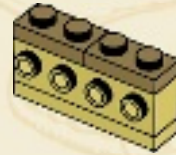

3



4

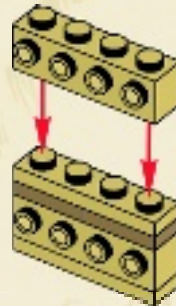

5



6

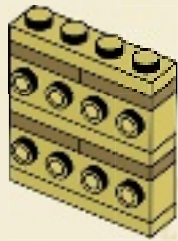

7



1



2



8

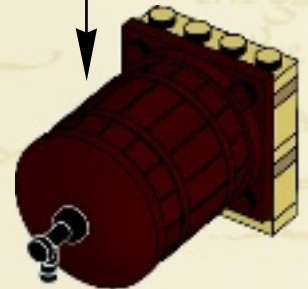

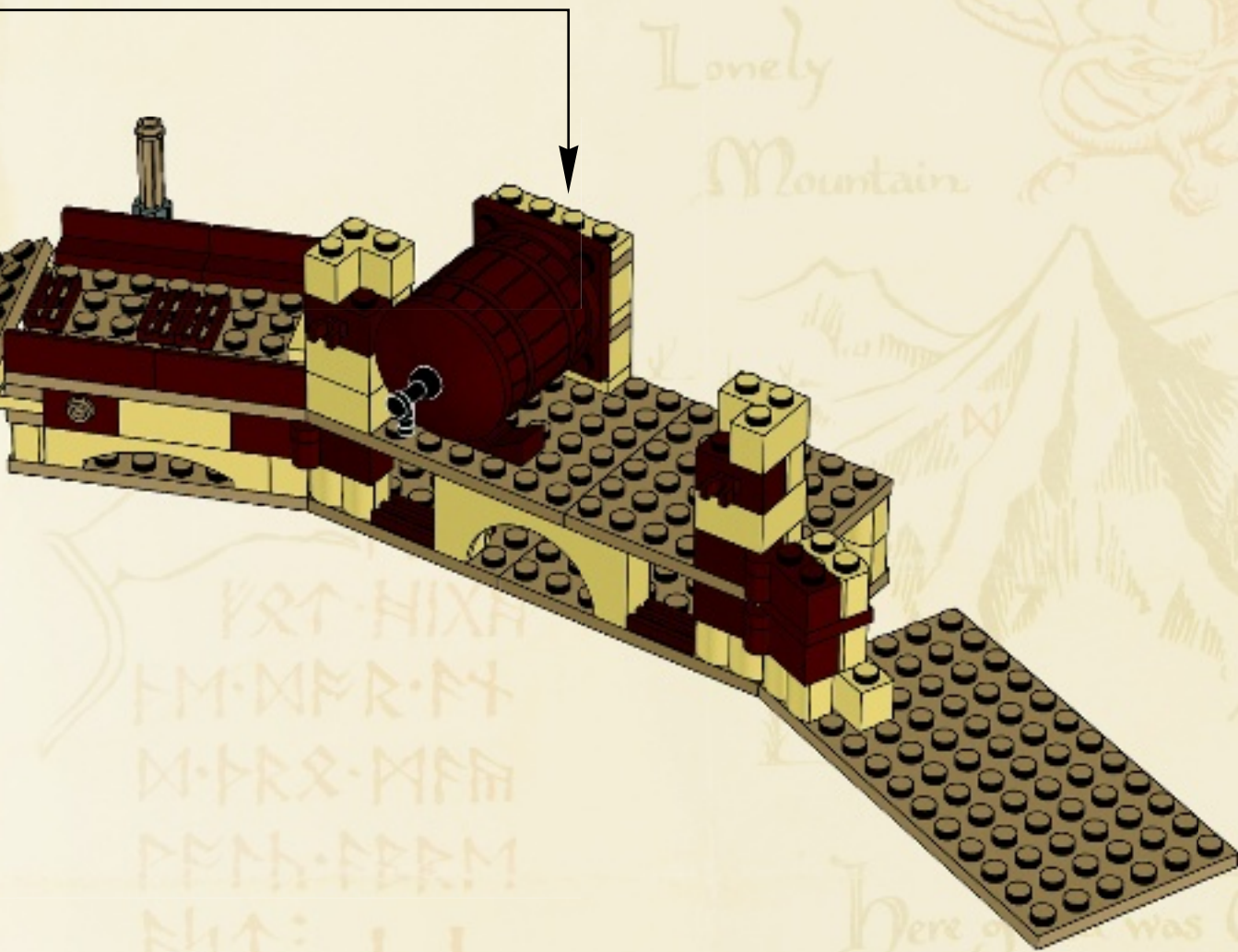

The
Lonely
Mountain

YRT·HIXA
EM·NFR·FY
M·PRQ·NFM
PEM·FERM
M↑: .P.P.

Here was Chror
King under the Moun

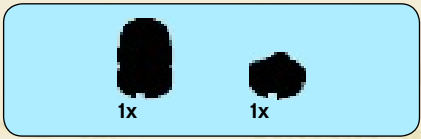

21

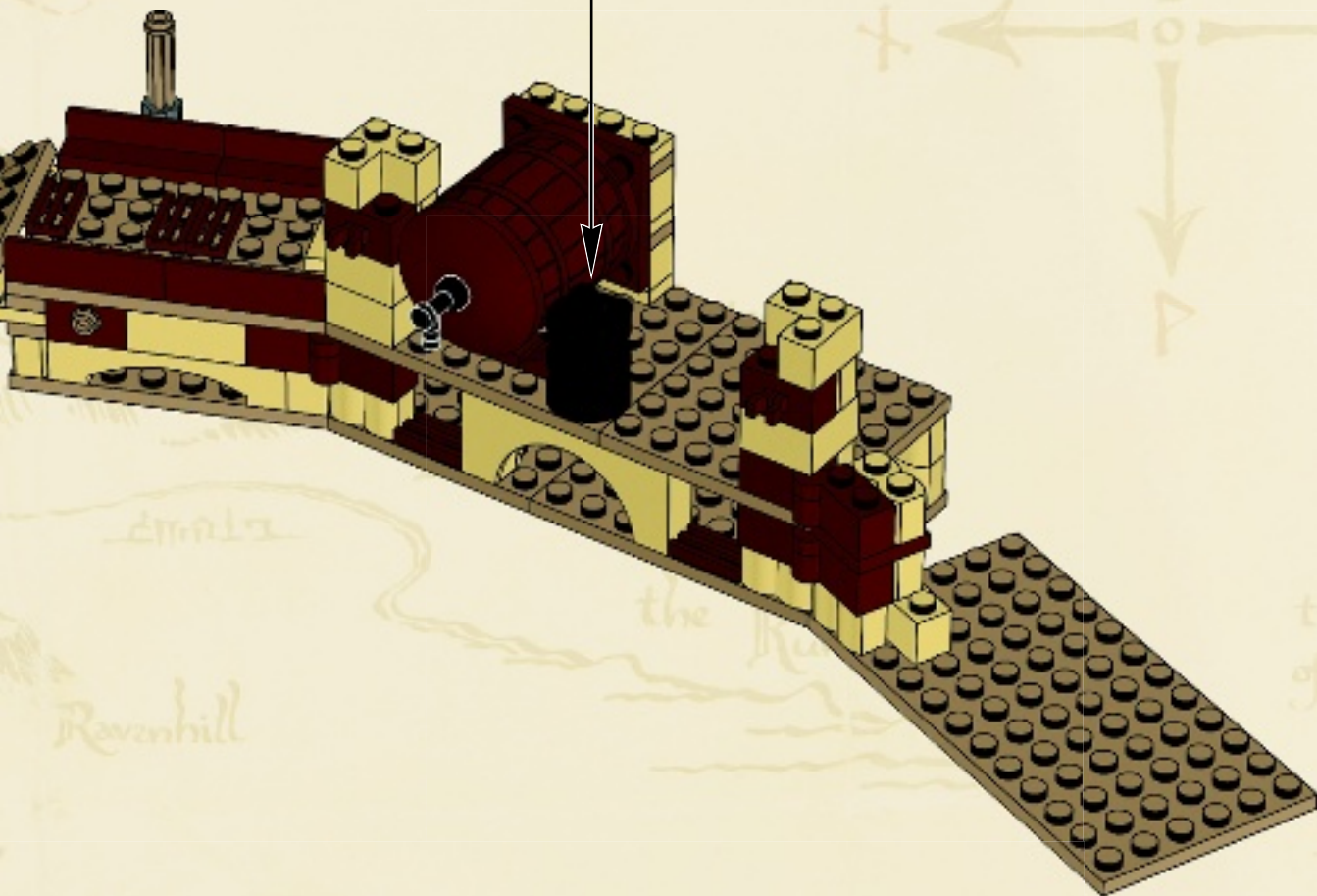
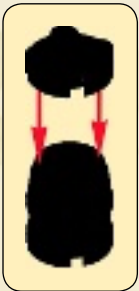

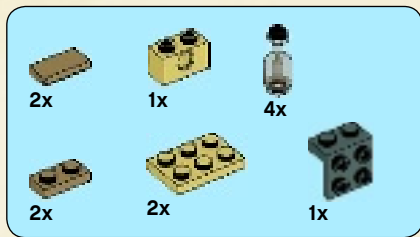

22

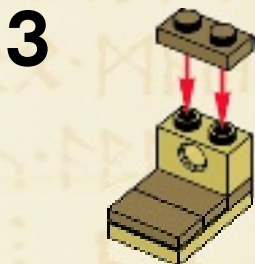

↑ East lie the Iron Hills
where is Dair

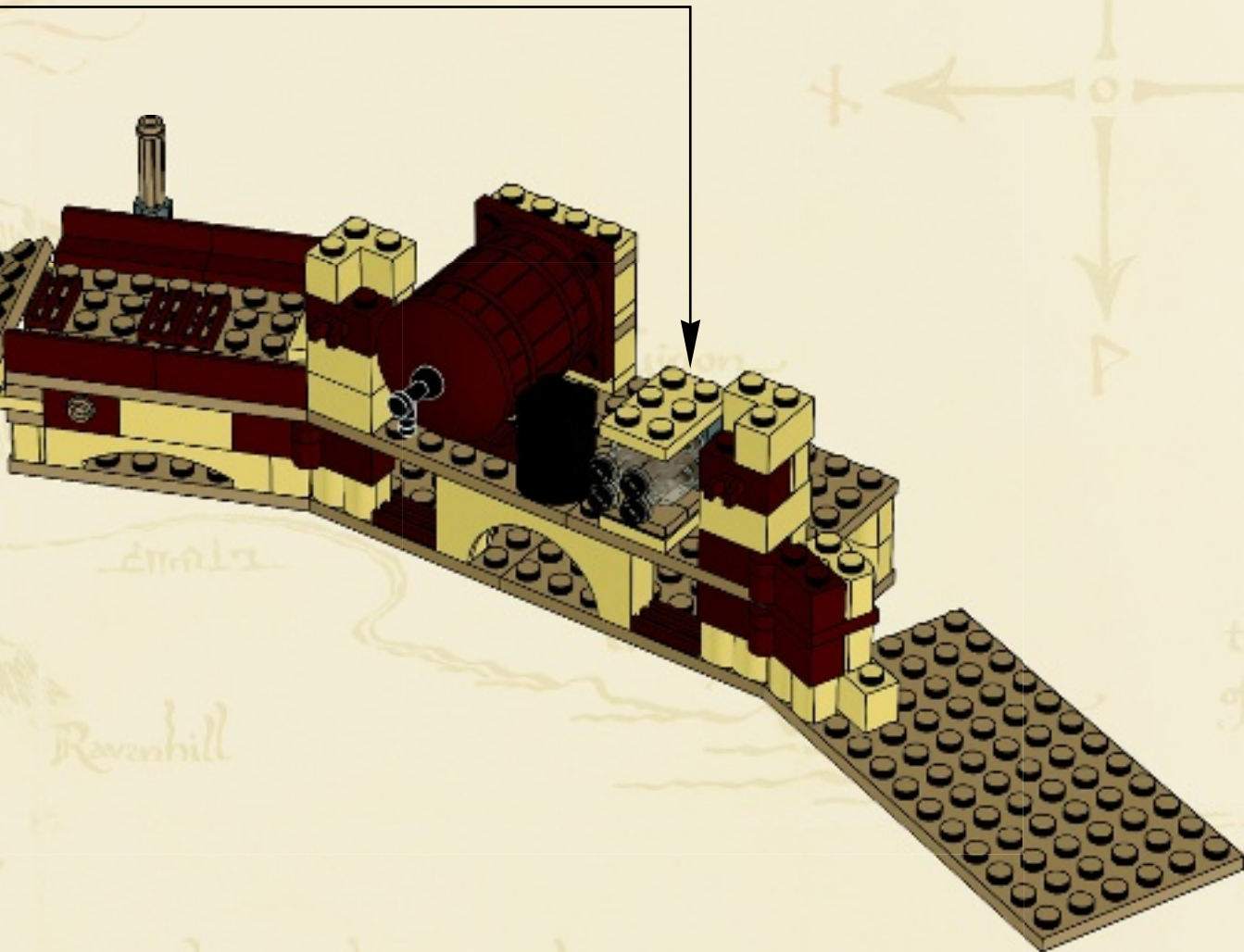

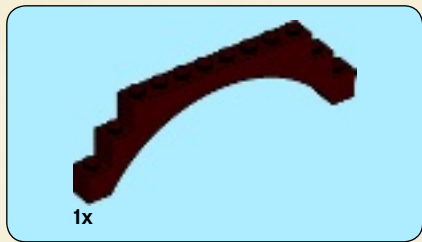

23

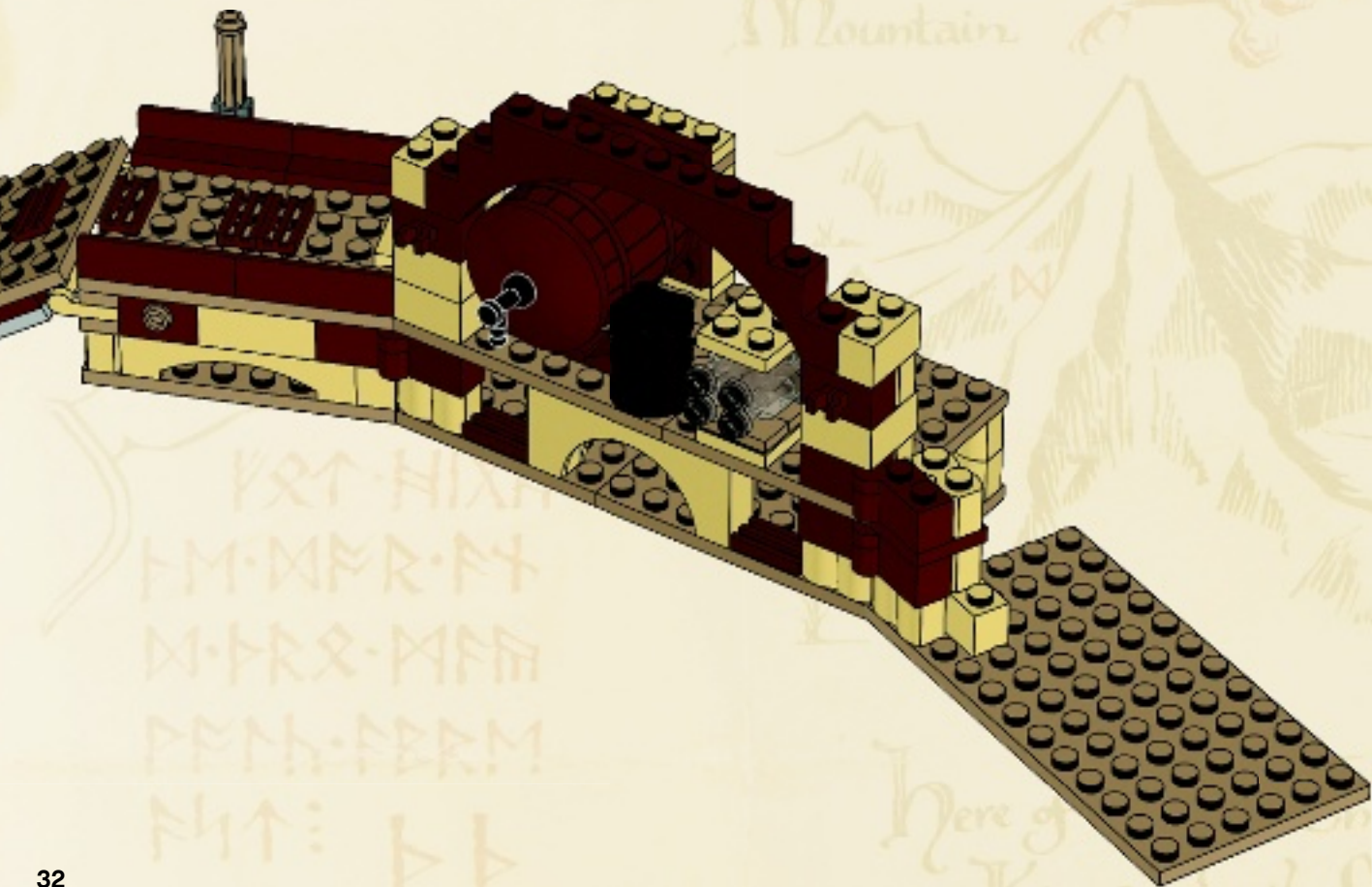



2x

24

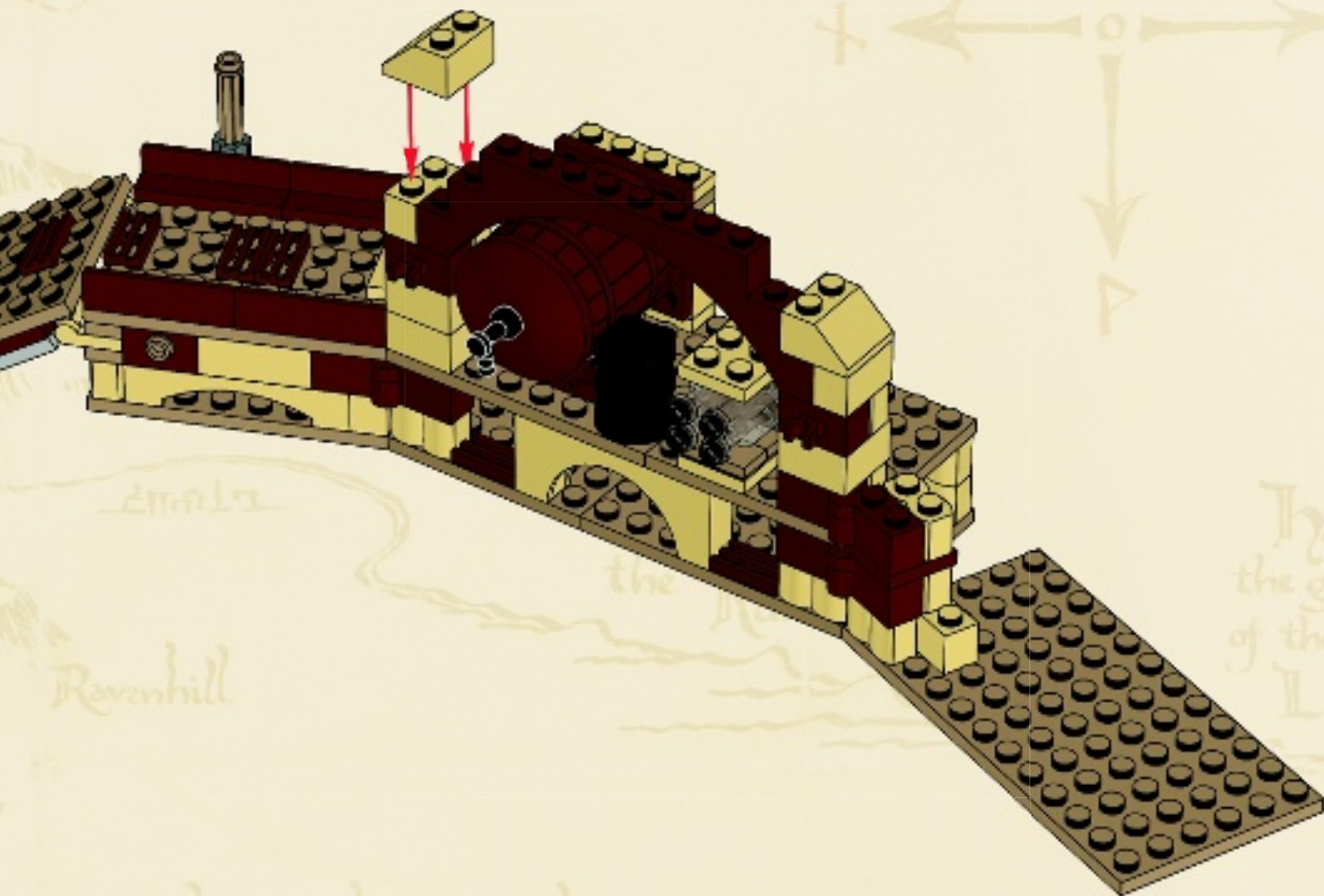



4x

25

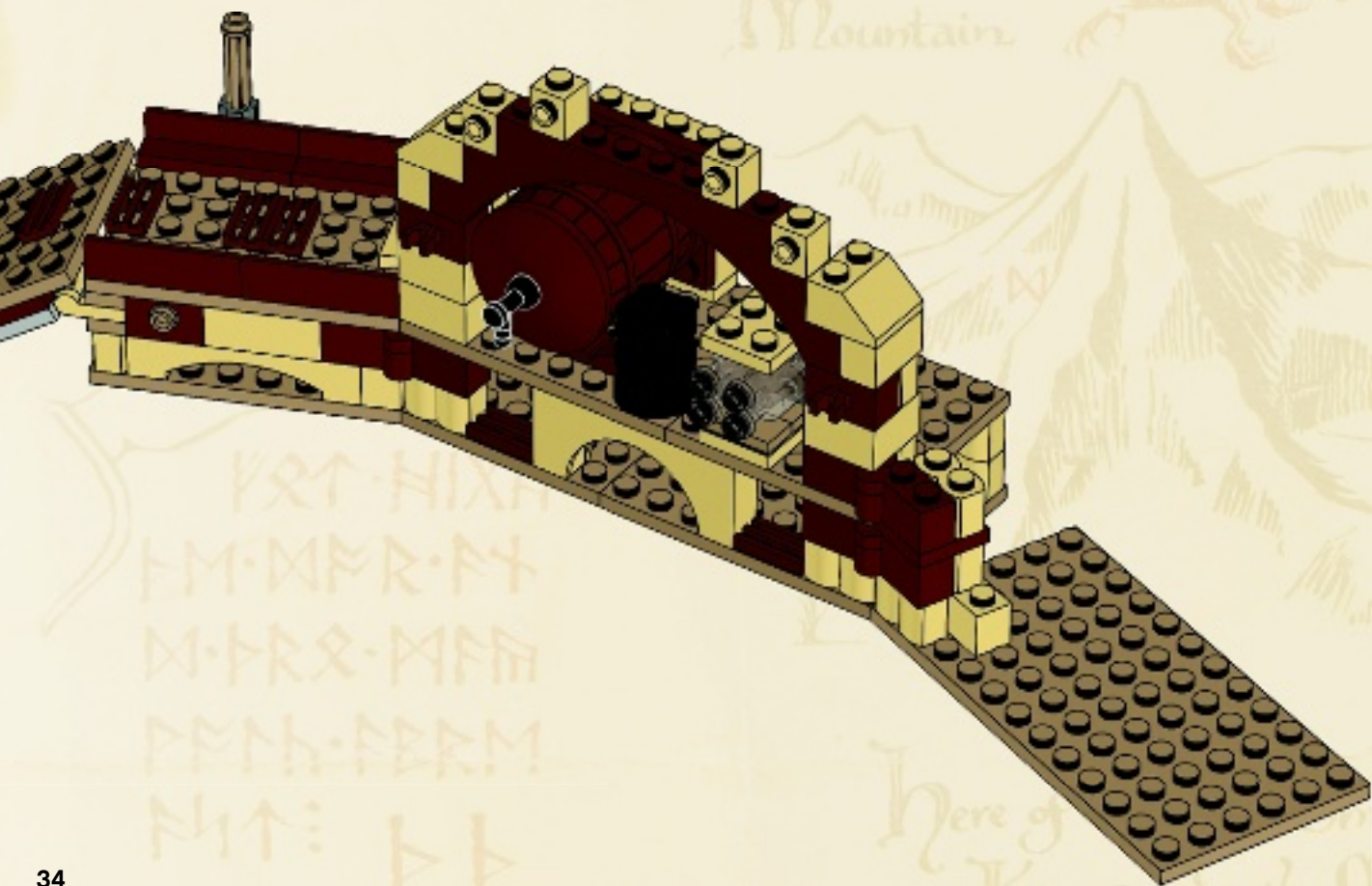

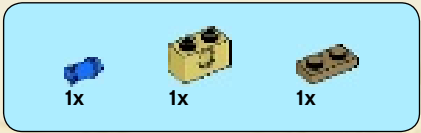

26

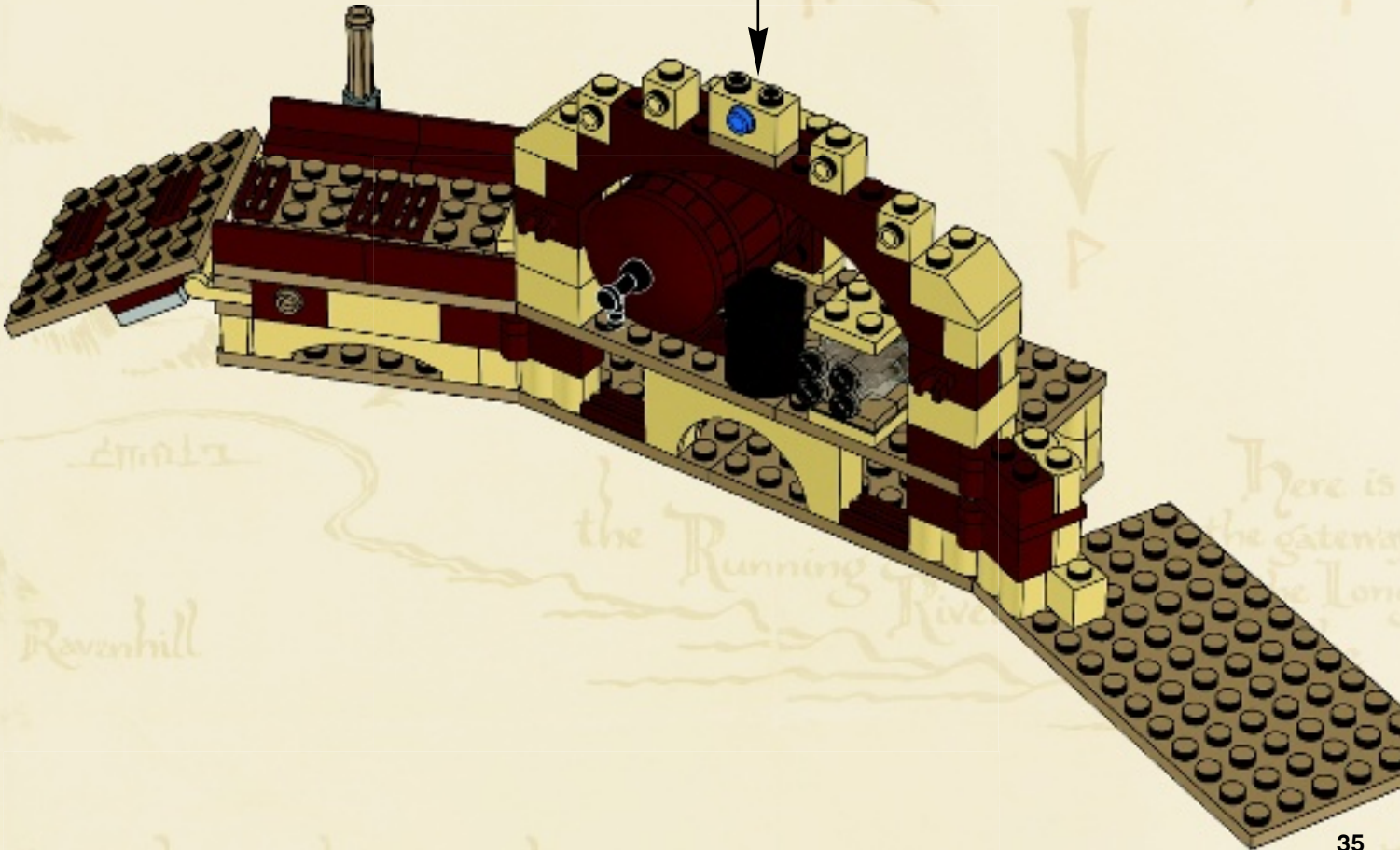
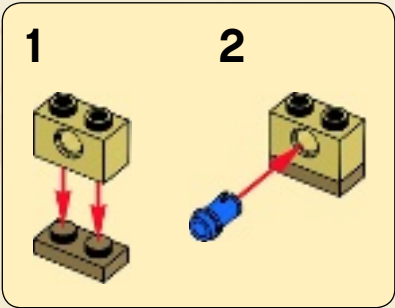

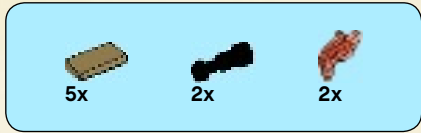

27

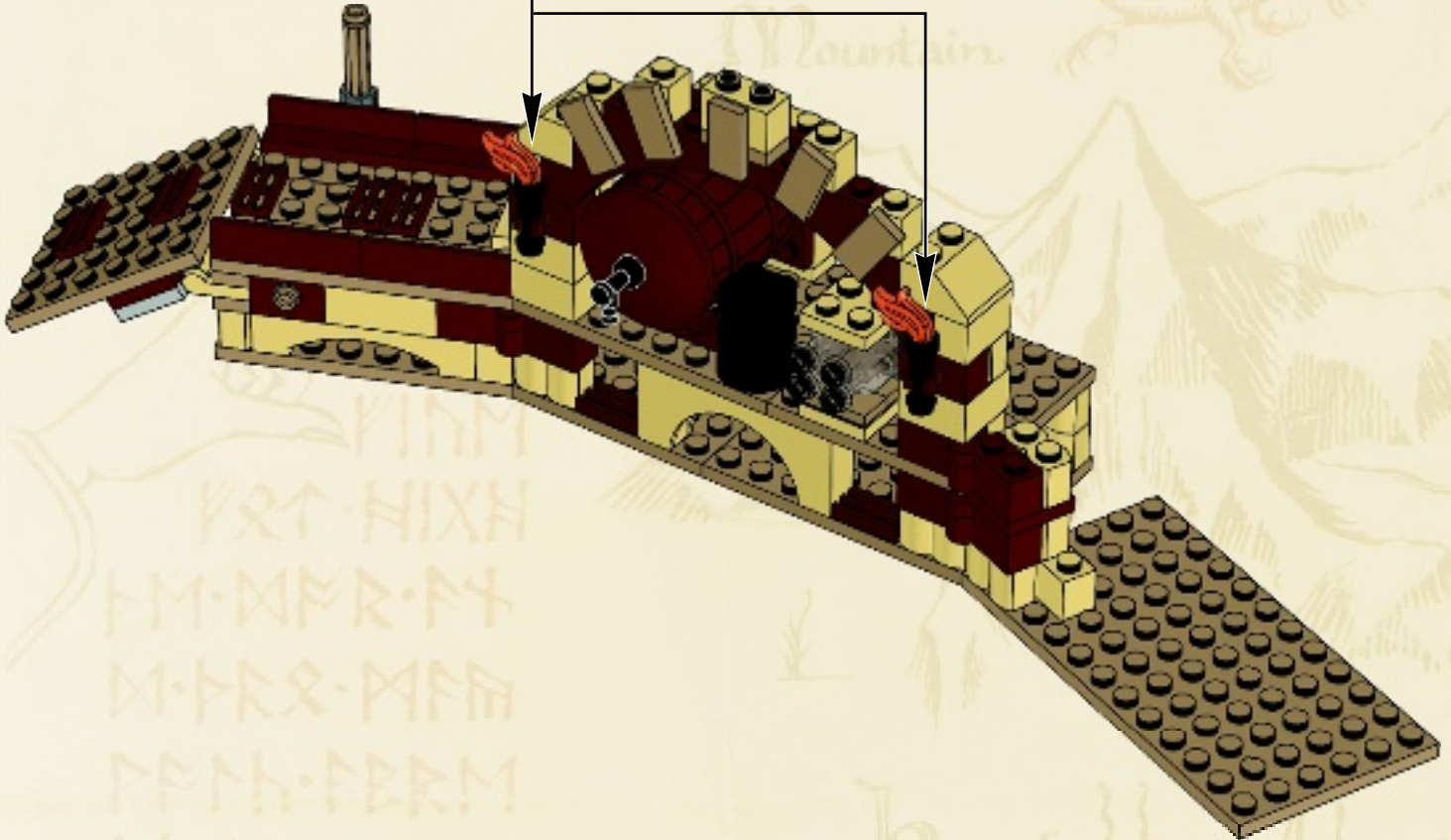



28

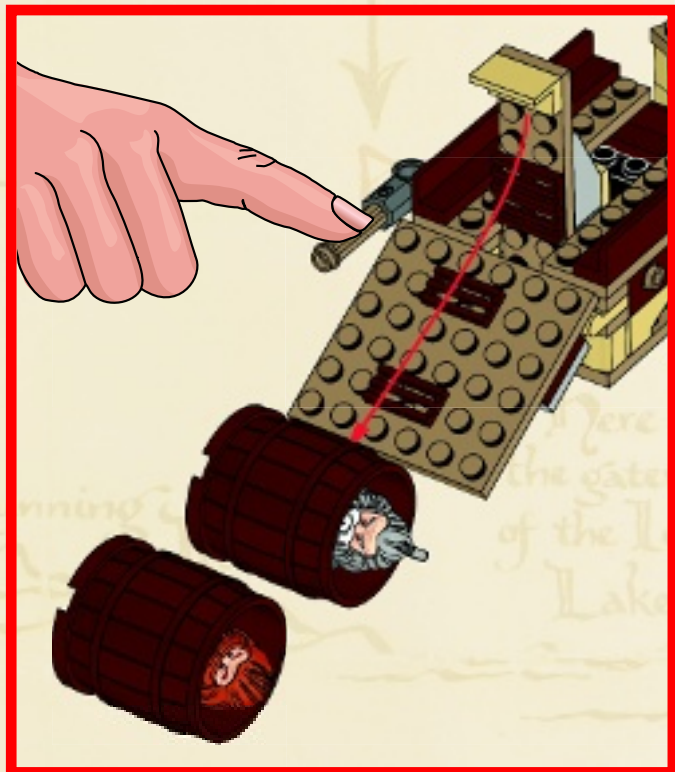
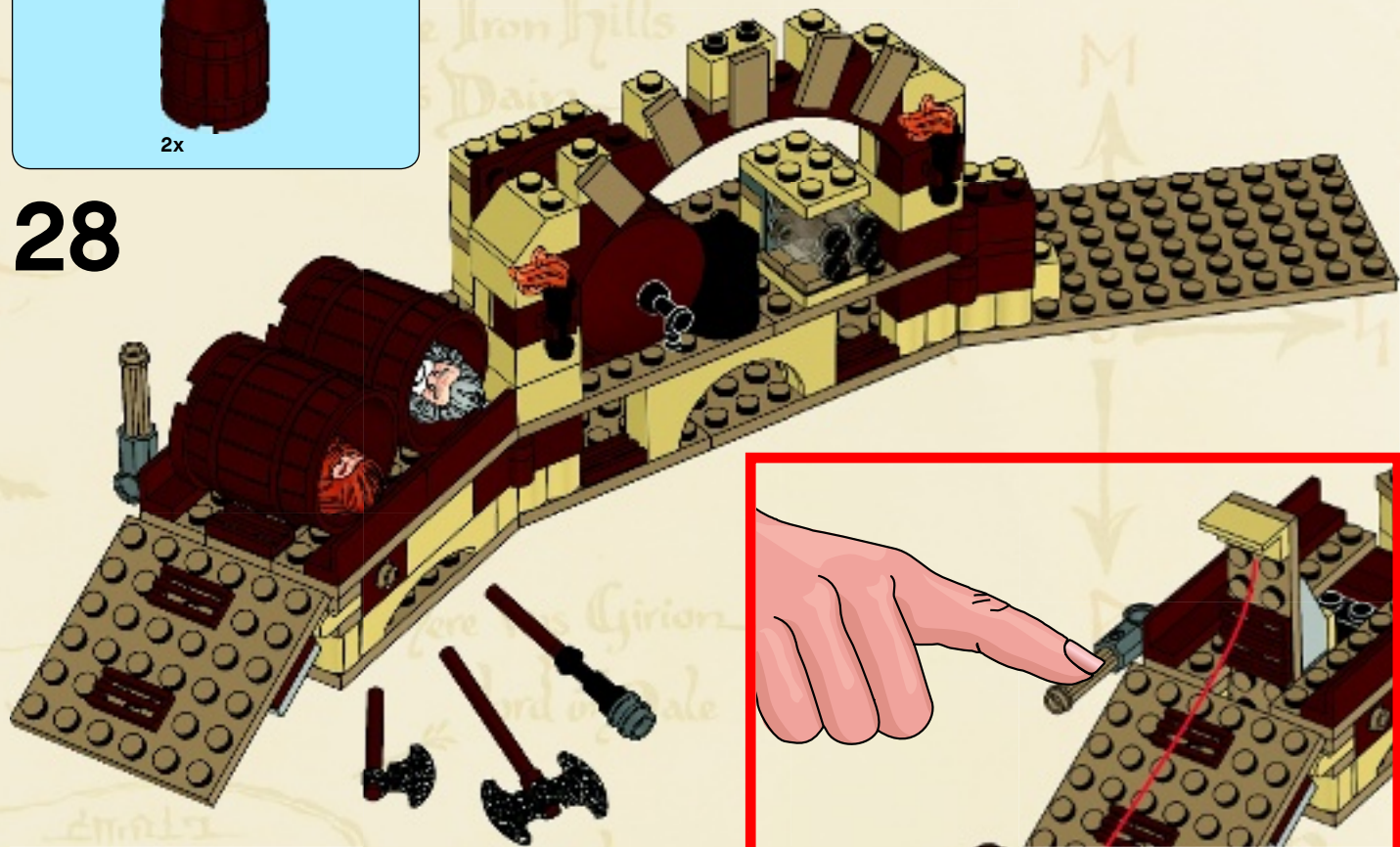

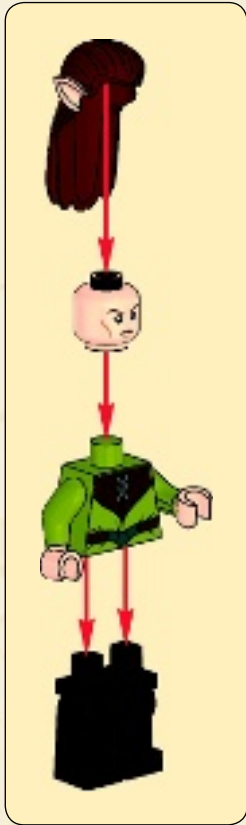

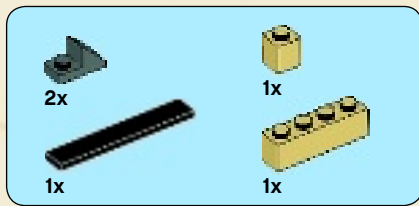

29

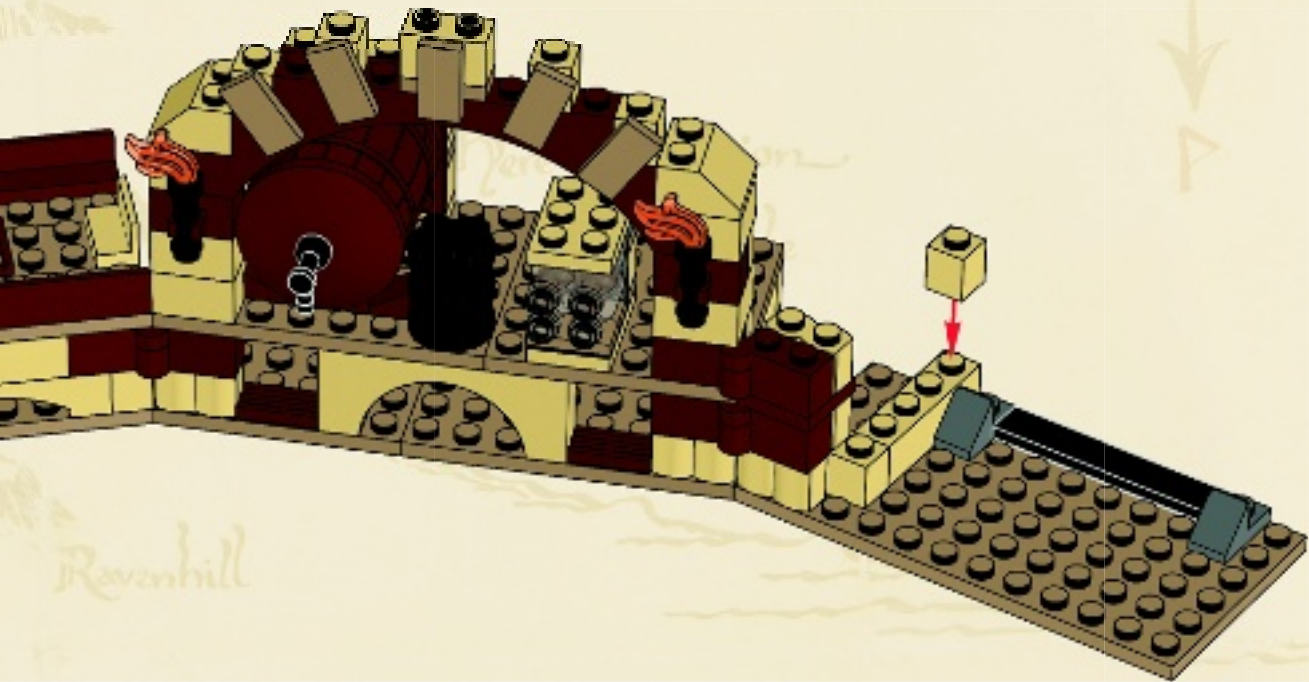



30

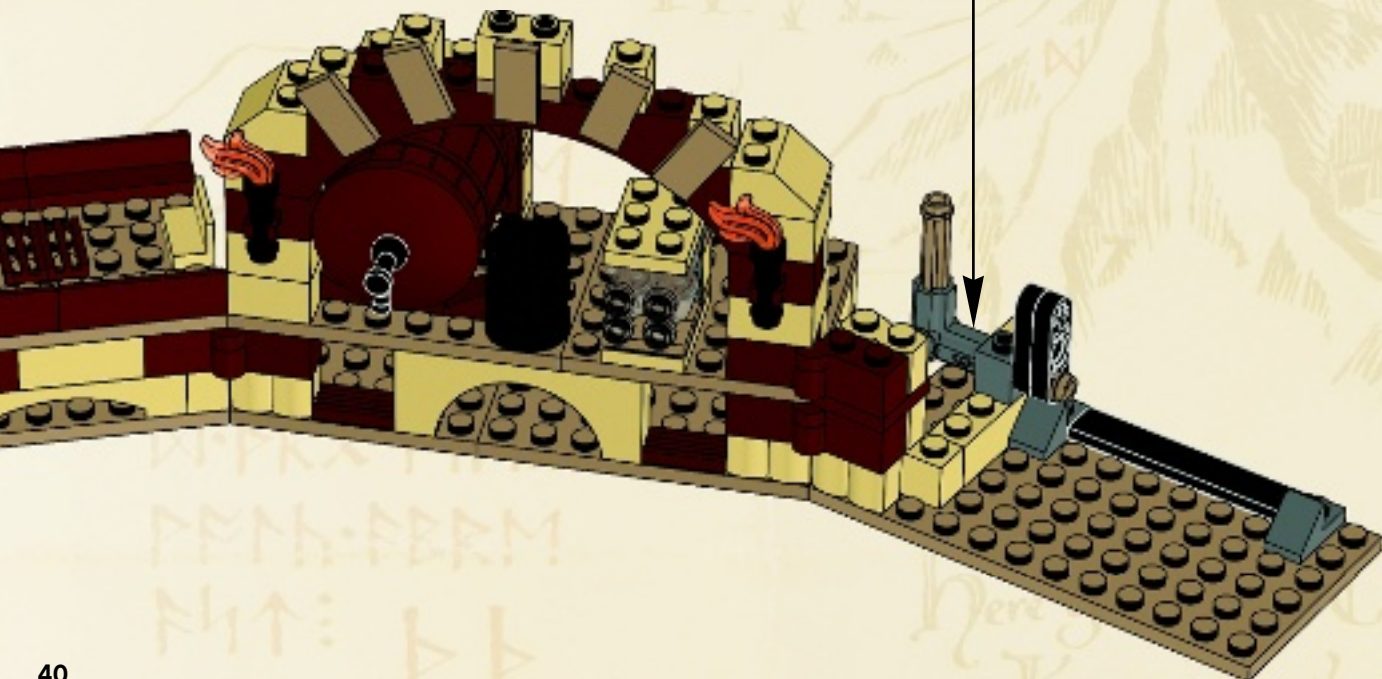
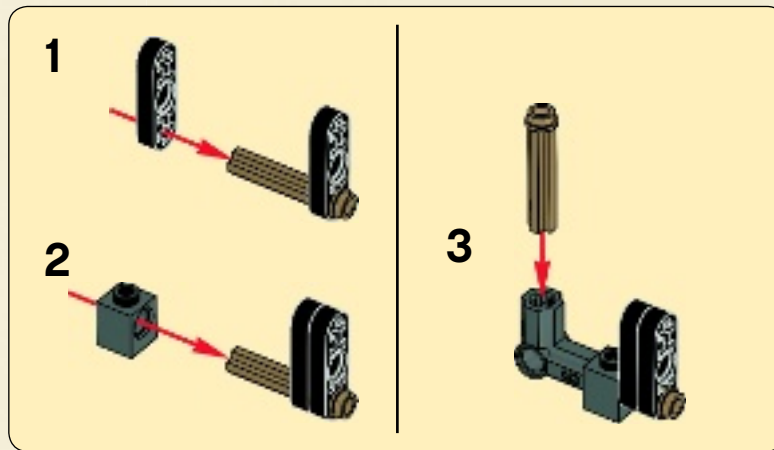

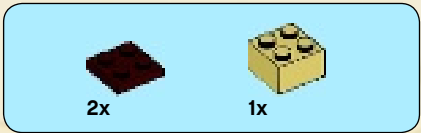

31

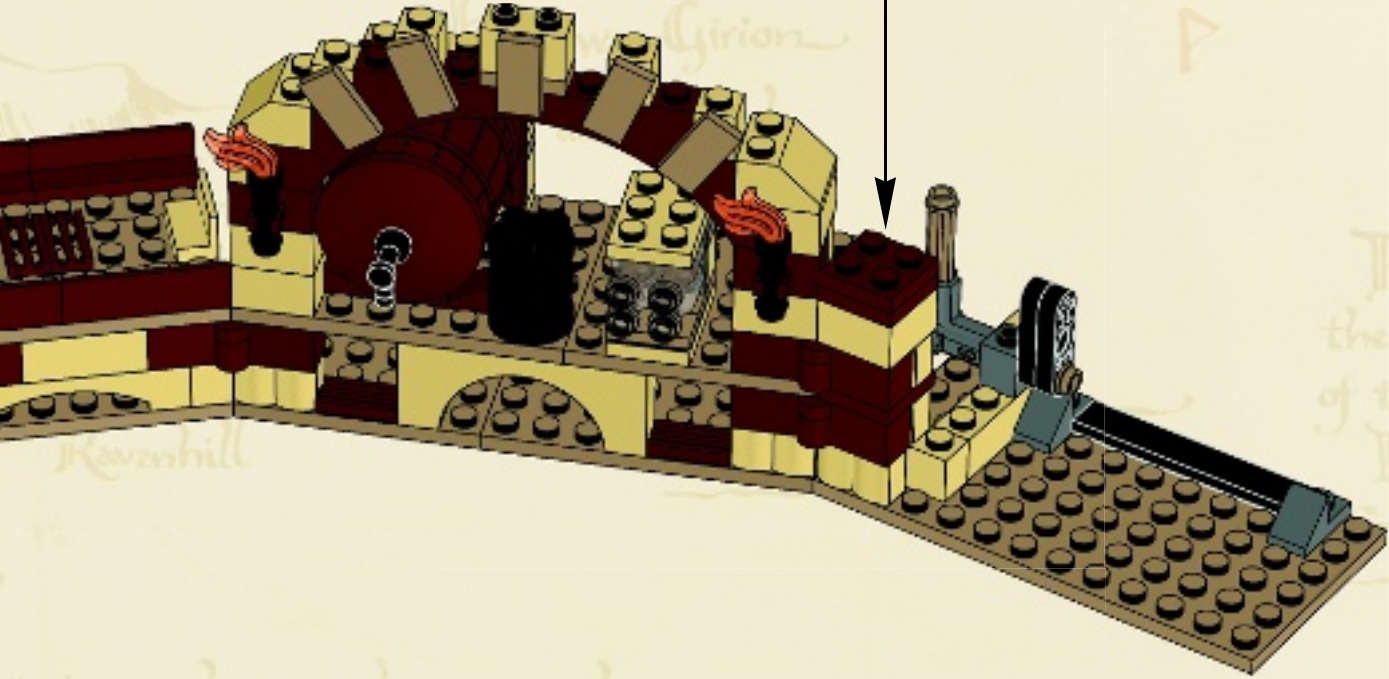
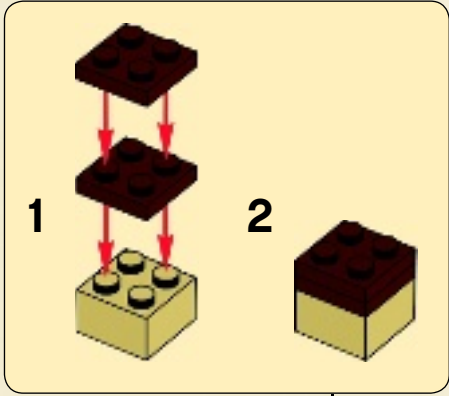



1x

32

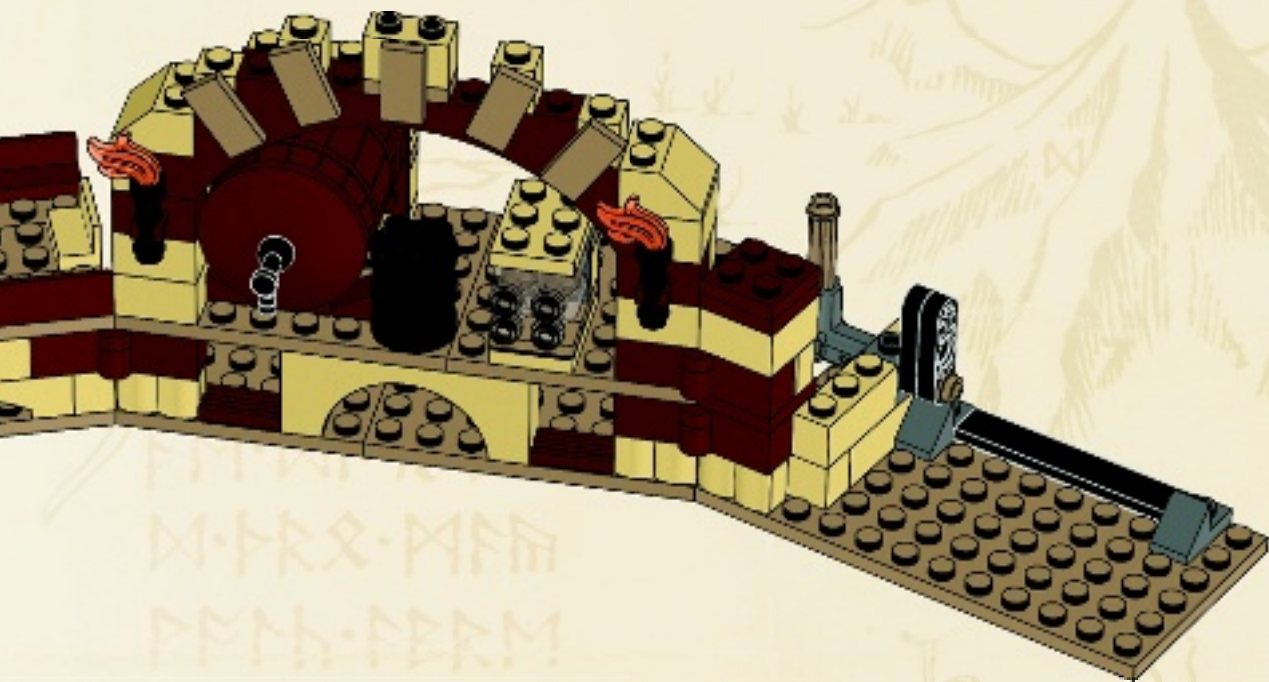



3x

33

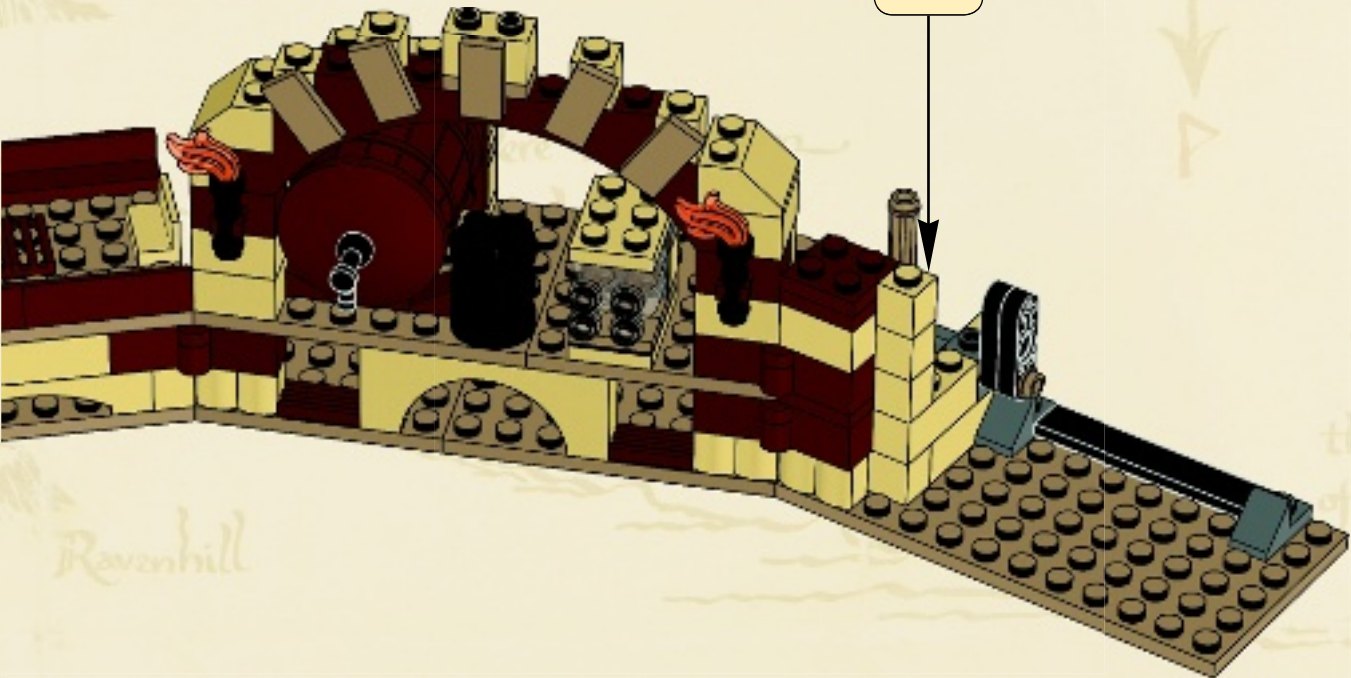
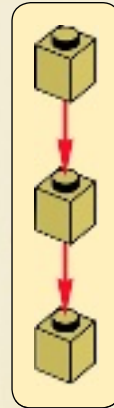

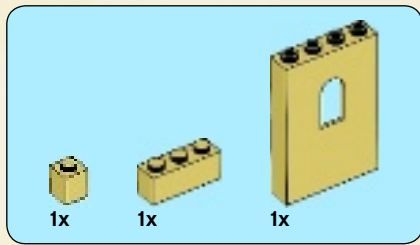

34

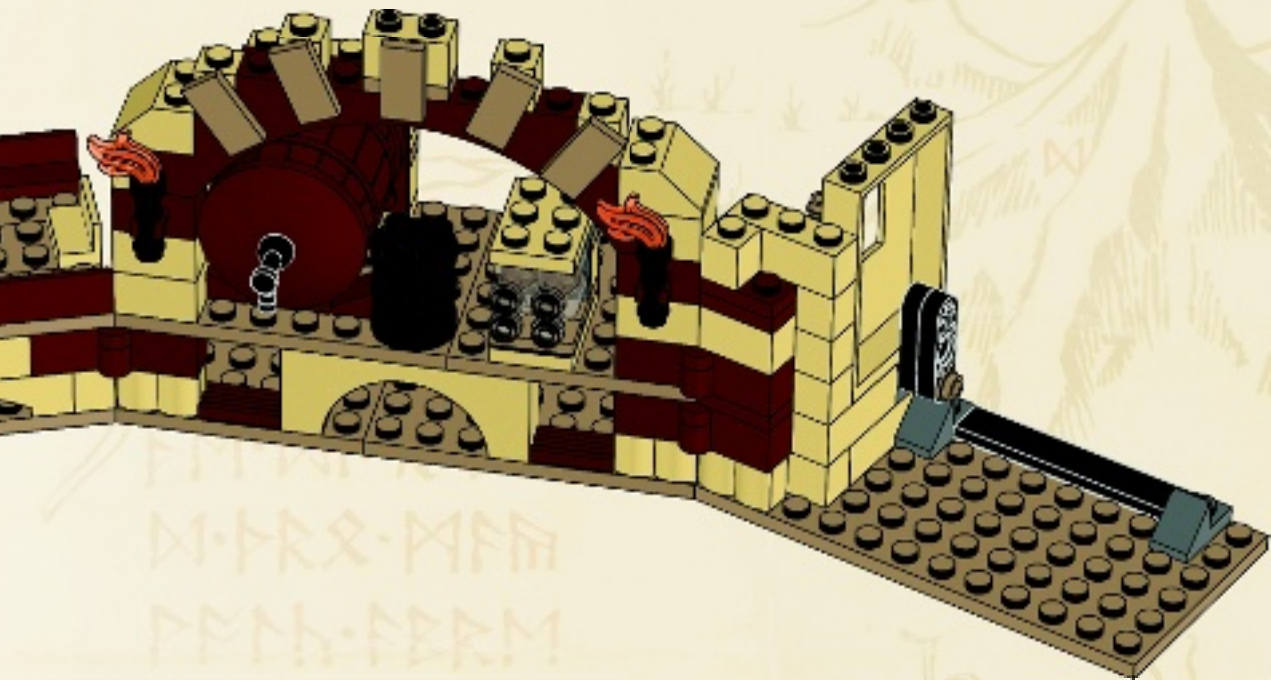



35

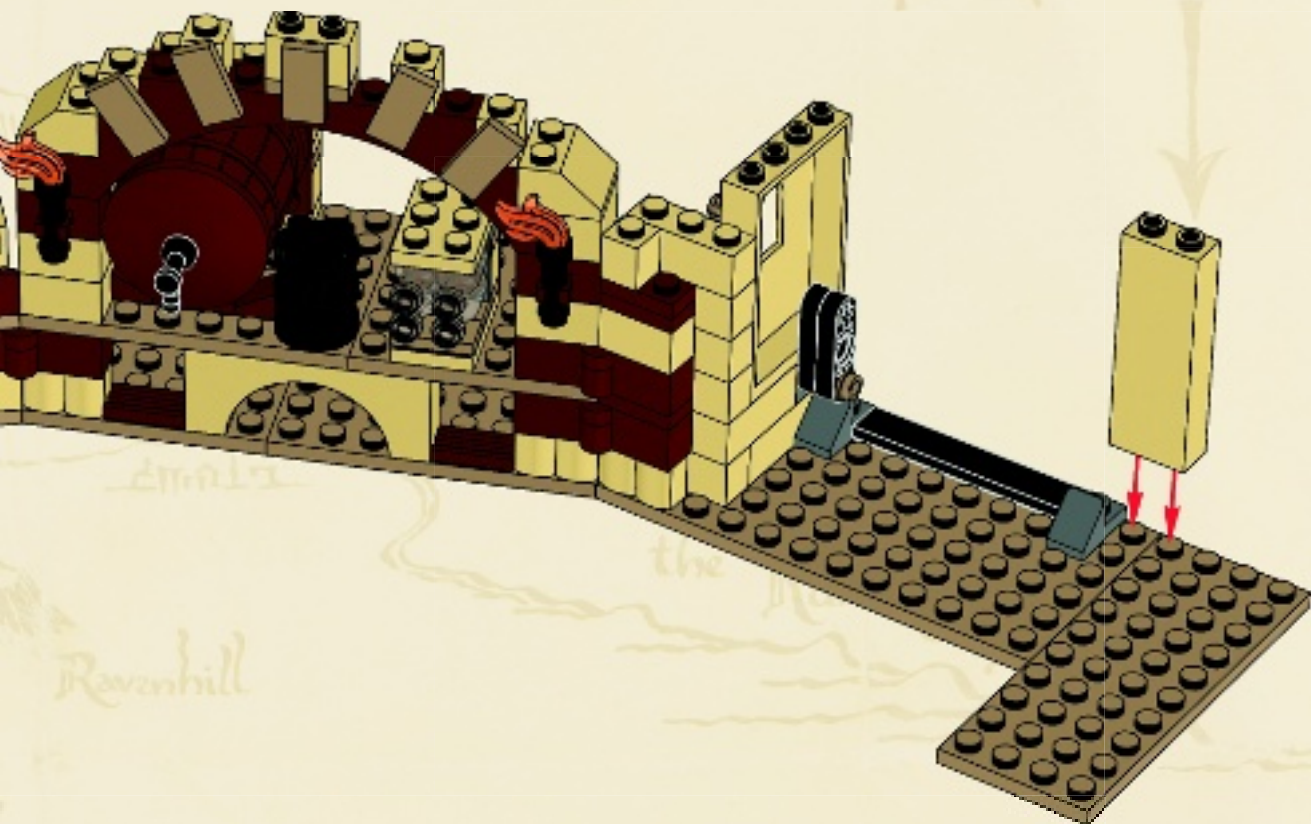

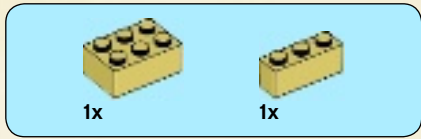

36

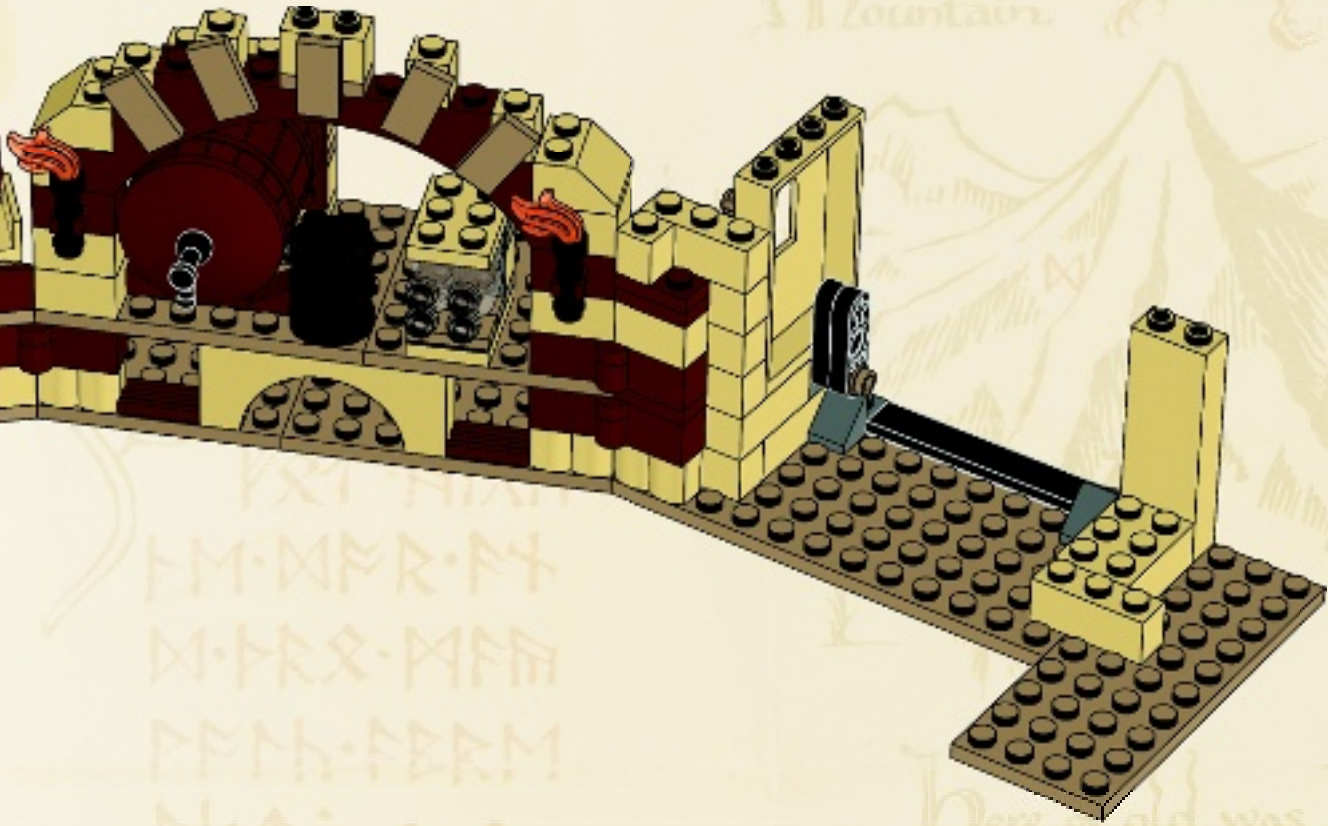

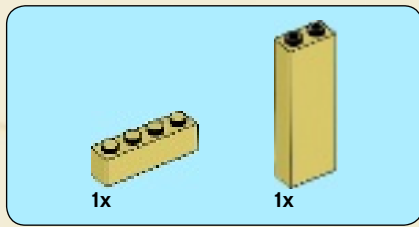

37

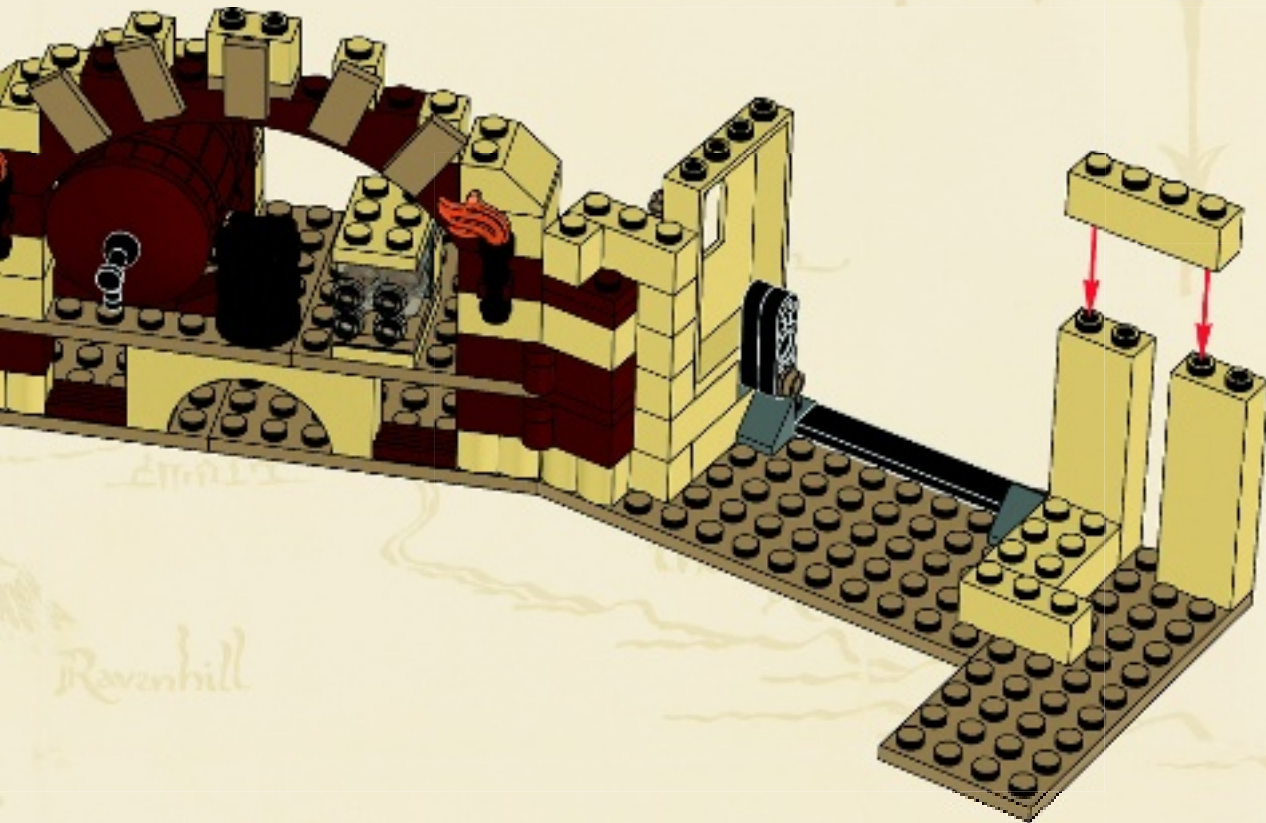

*Iron Hills
Dair*

*Here is
the gateway
of the Long
Lake*

Ravenhill

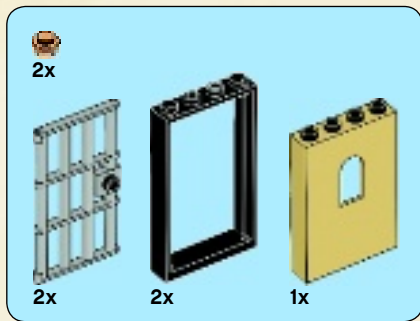

38

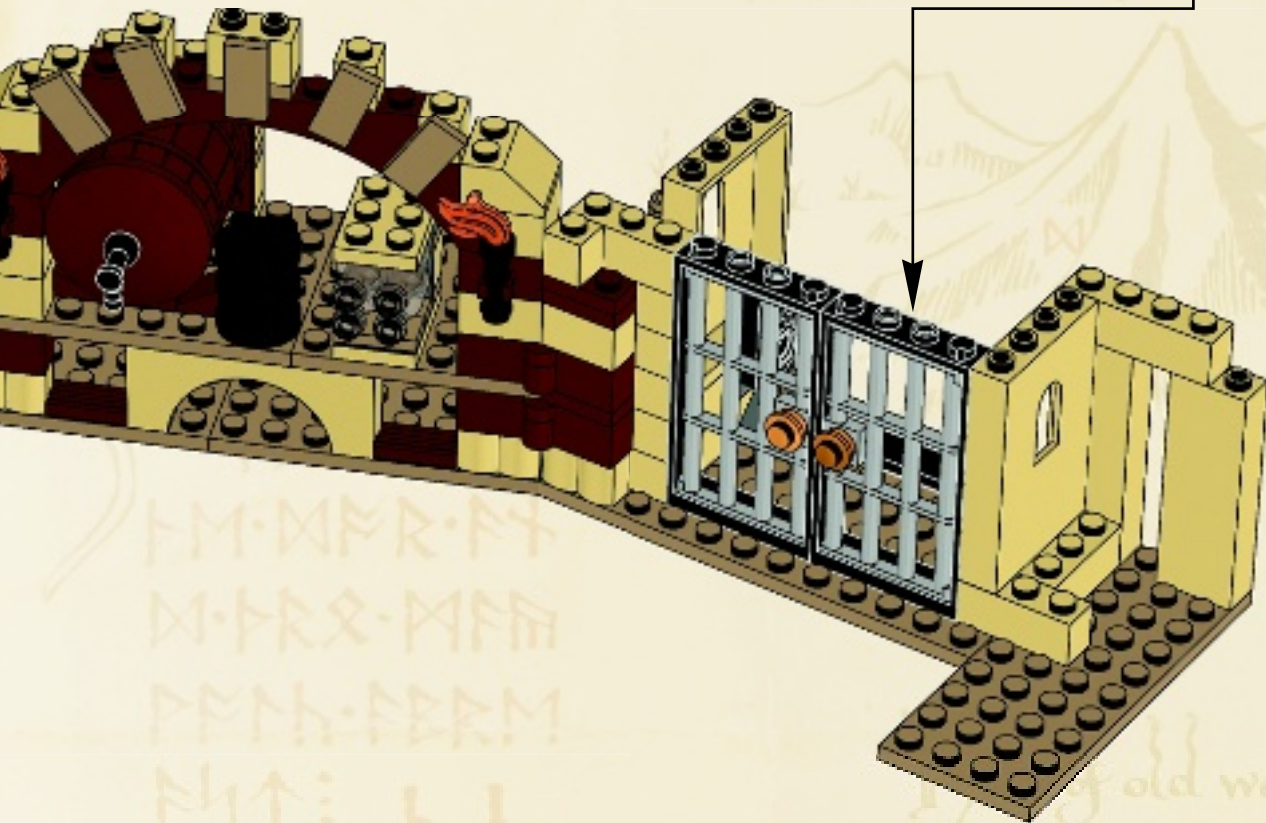
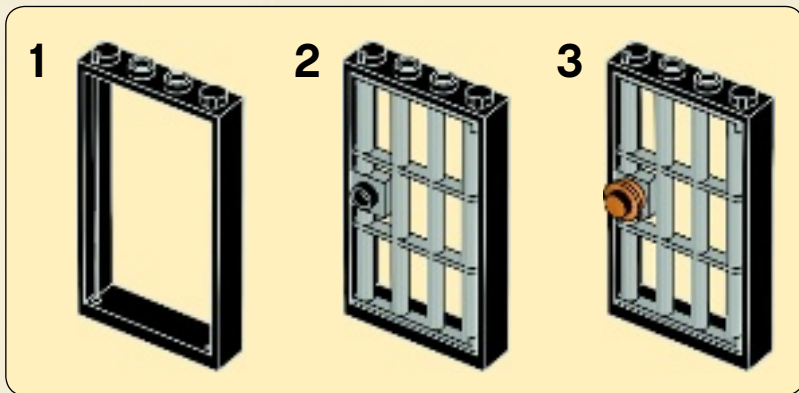

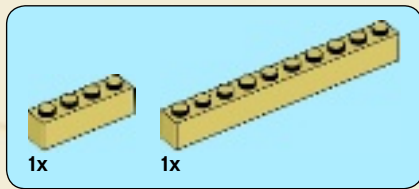

39

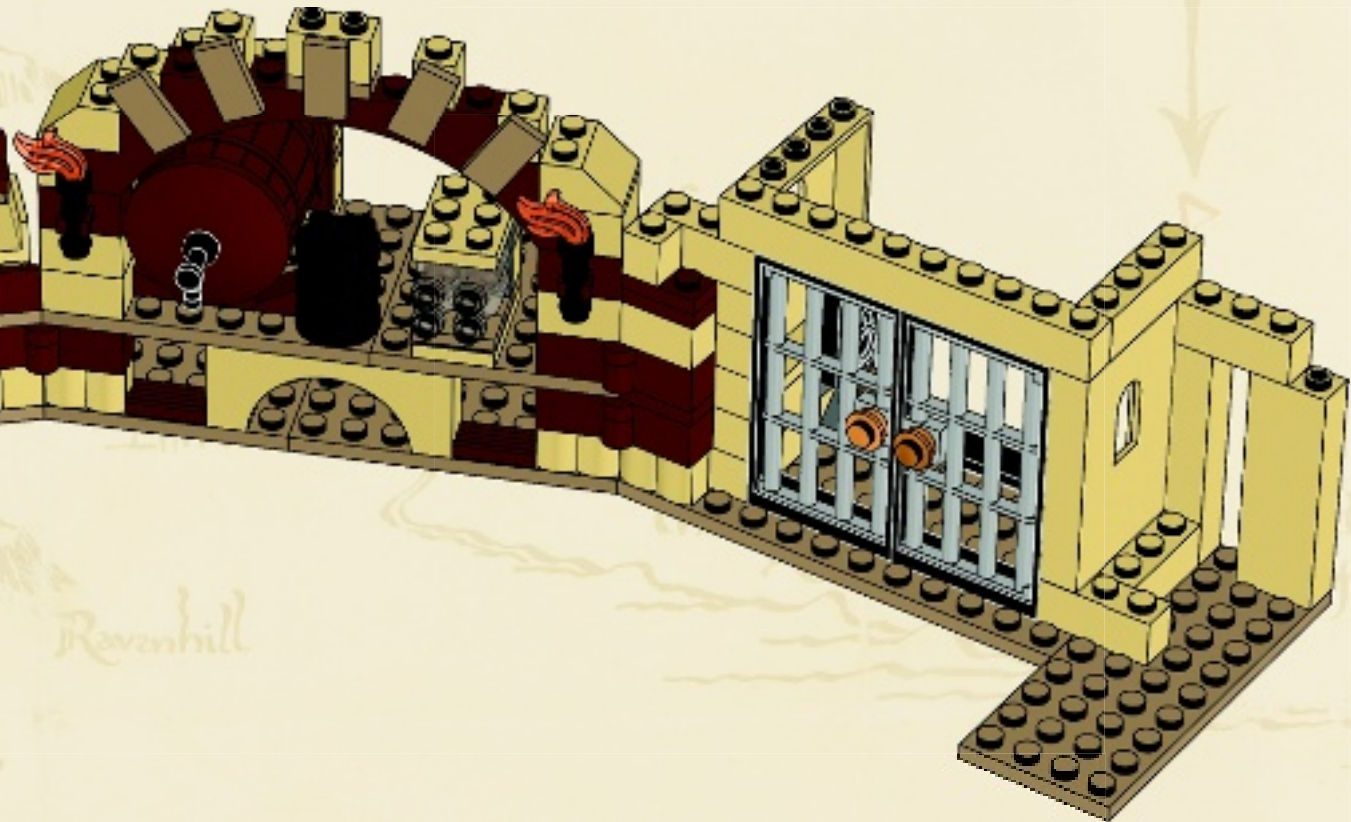

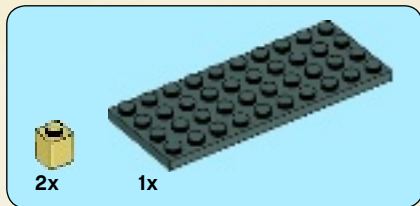

40

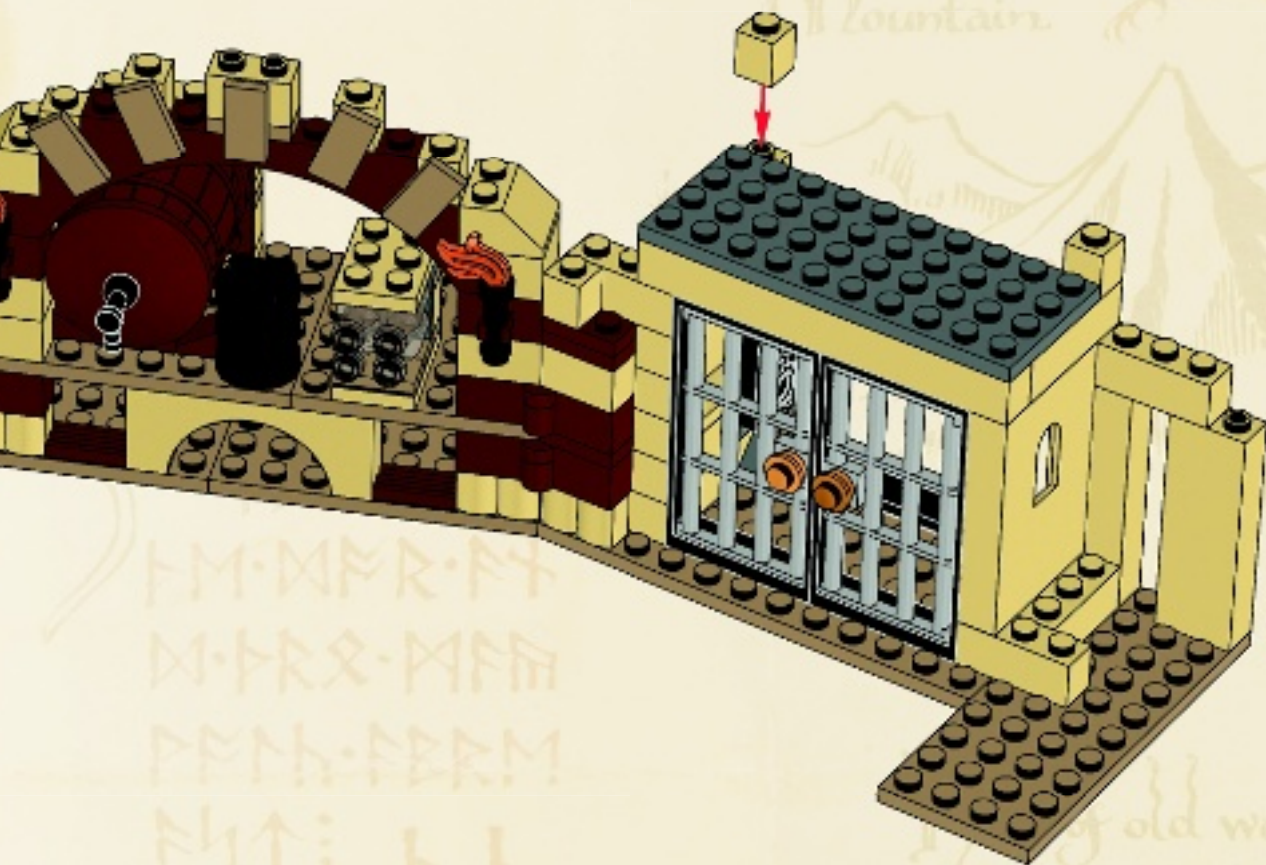



41

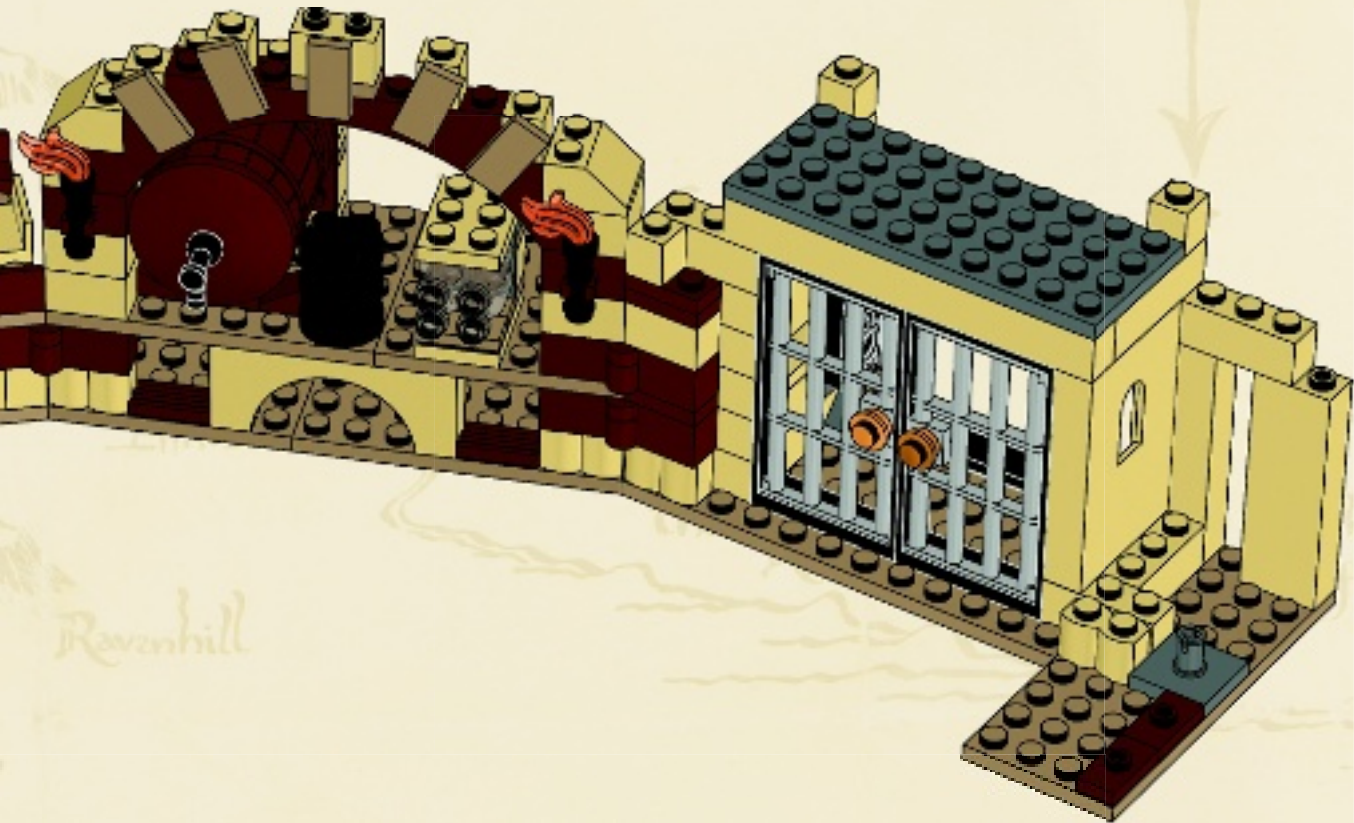

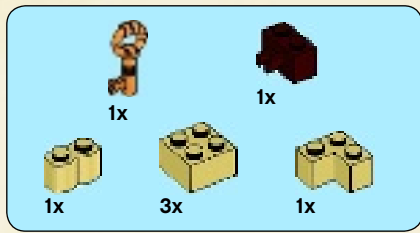

42

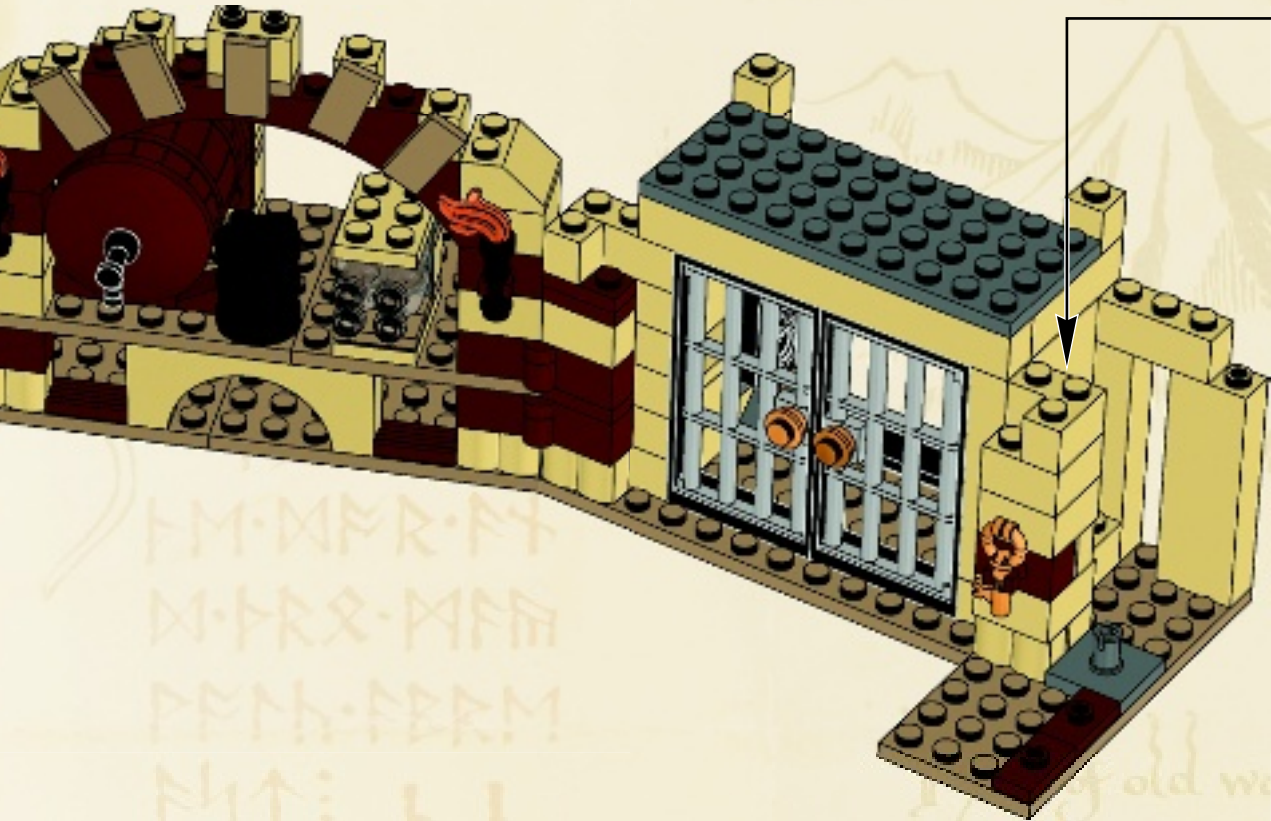
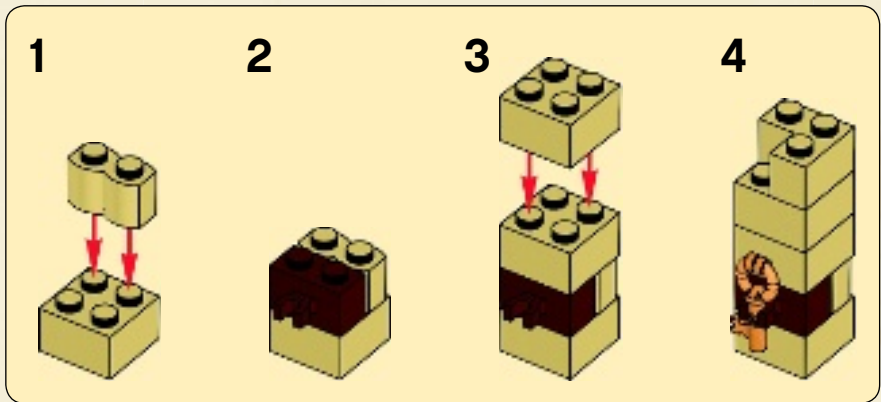

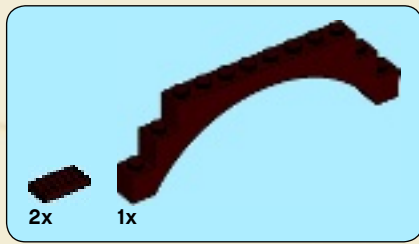

43

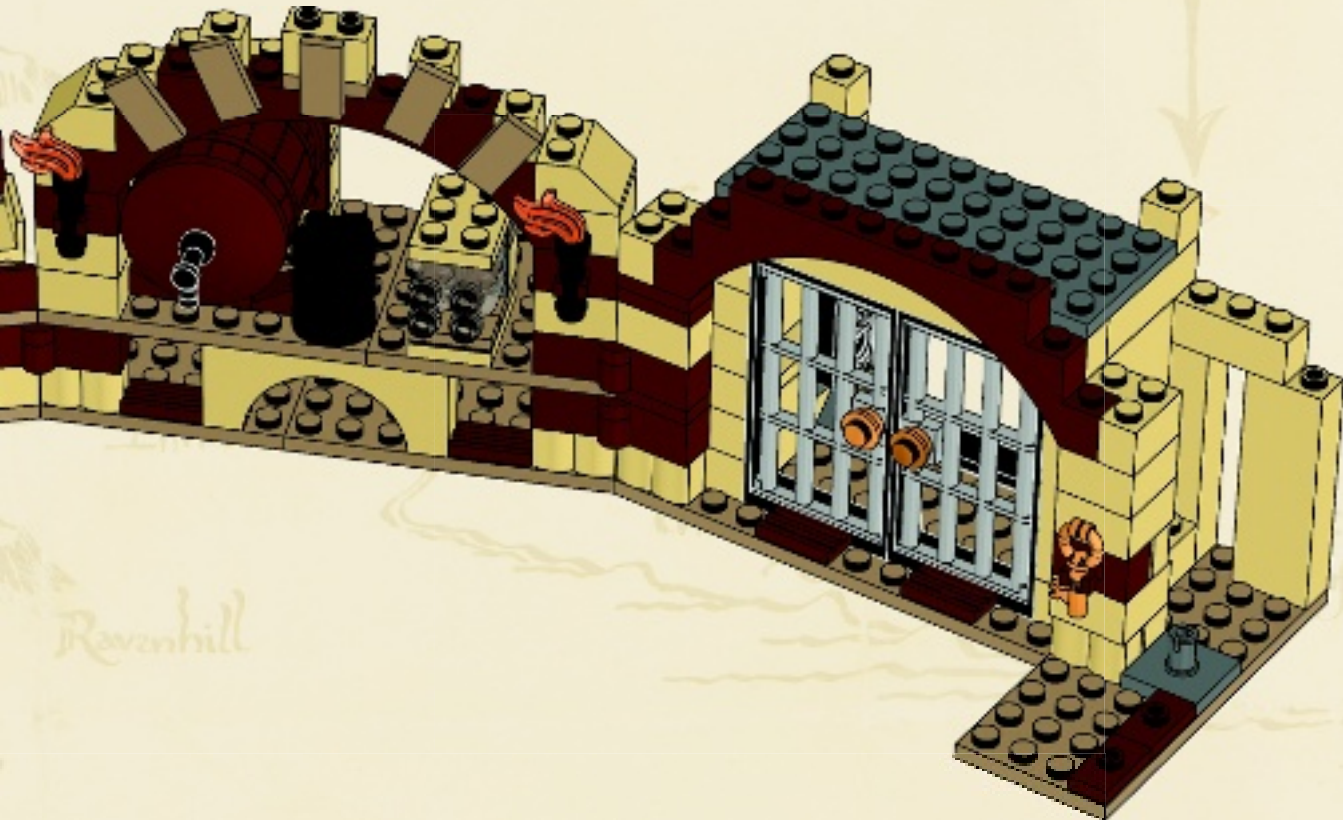

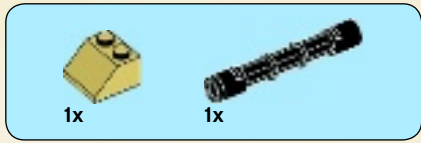

44

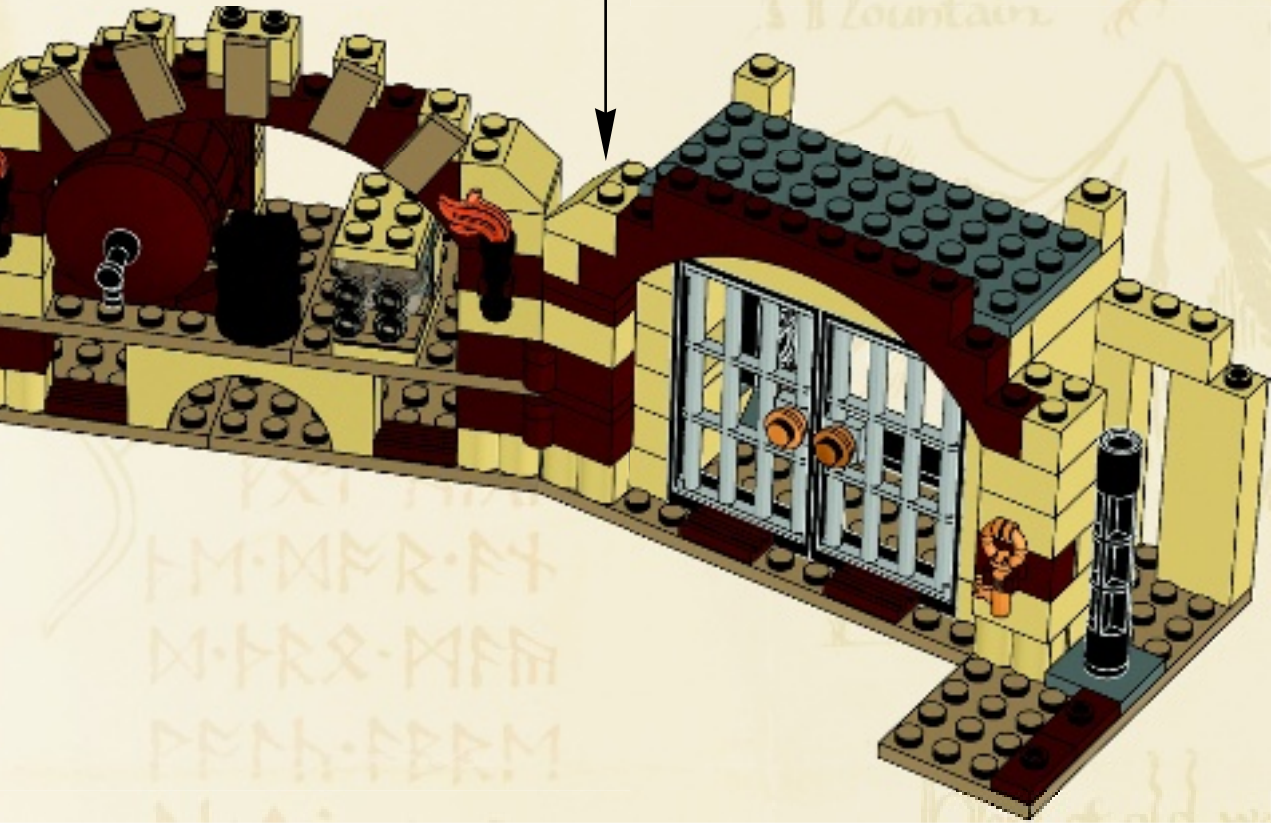
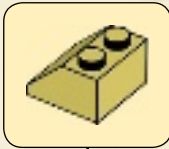

King of old was Thror
King under the Moun



1x

45

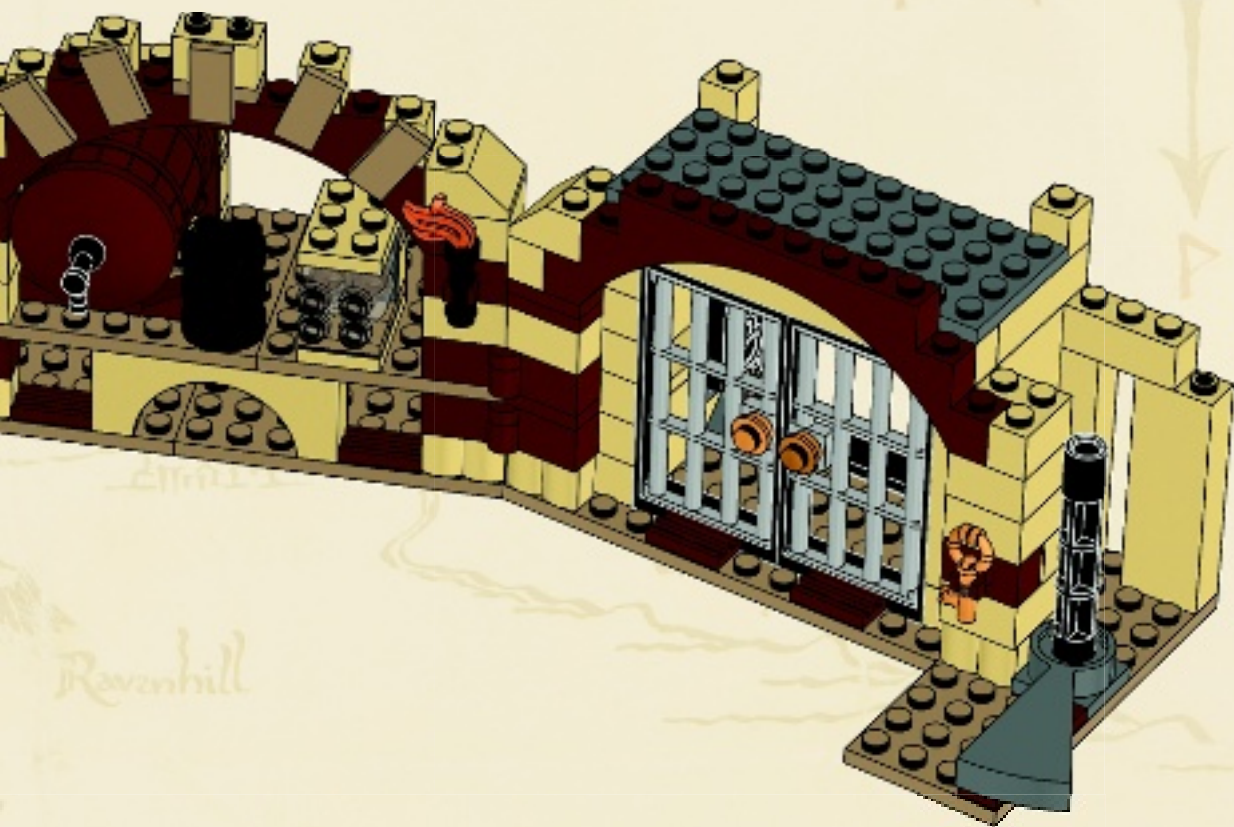

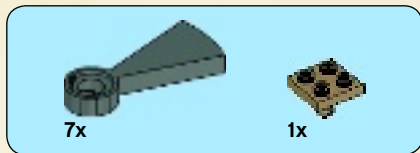

46

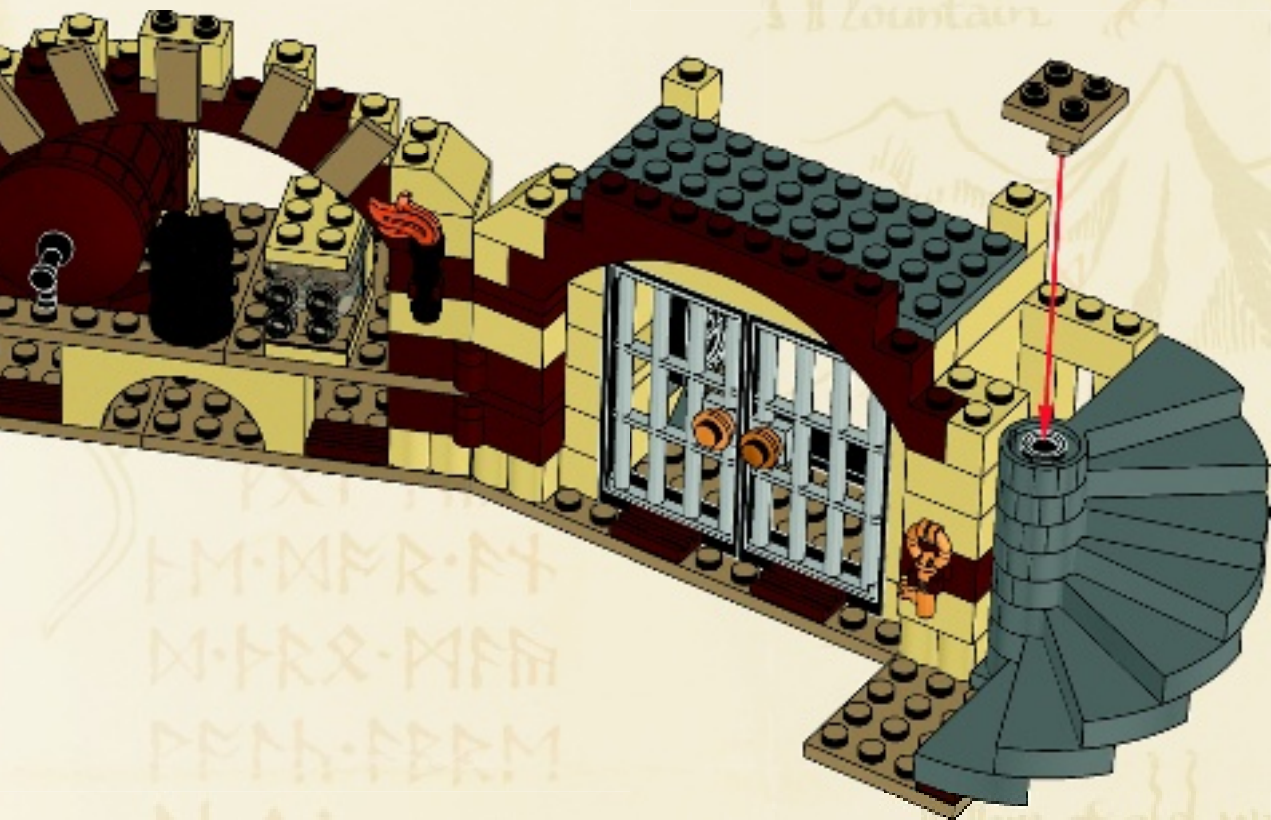



1x

47

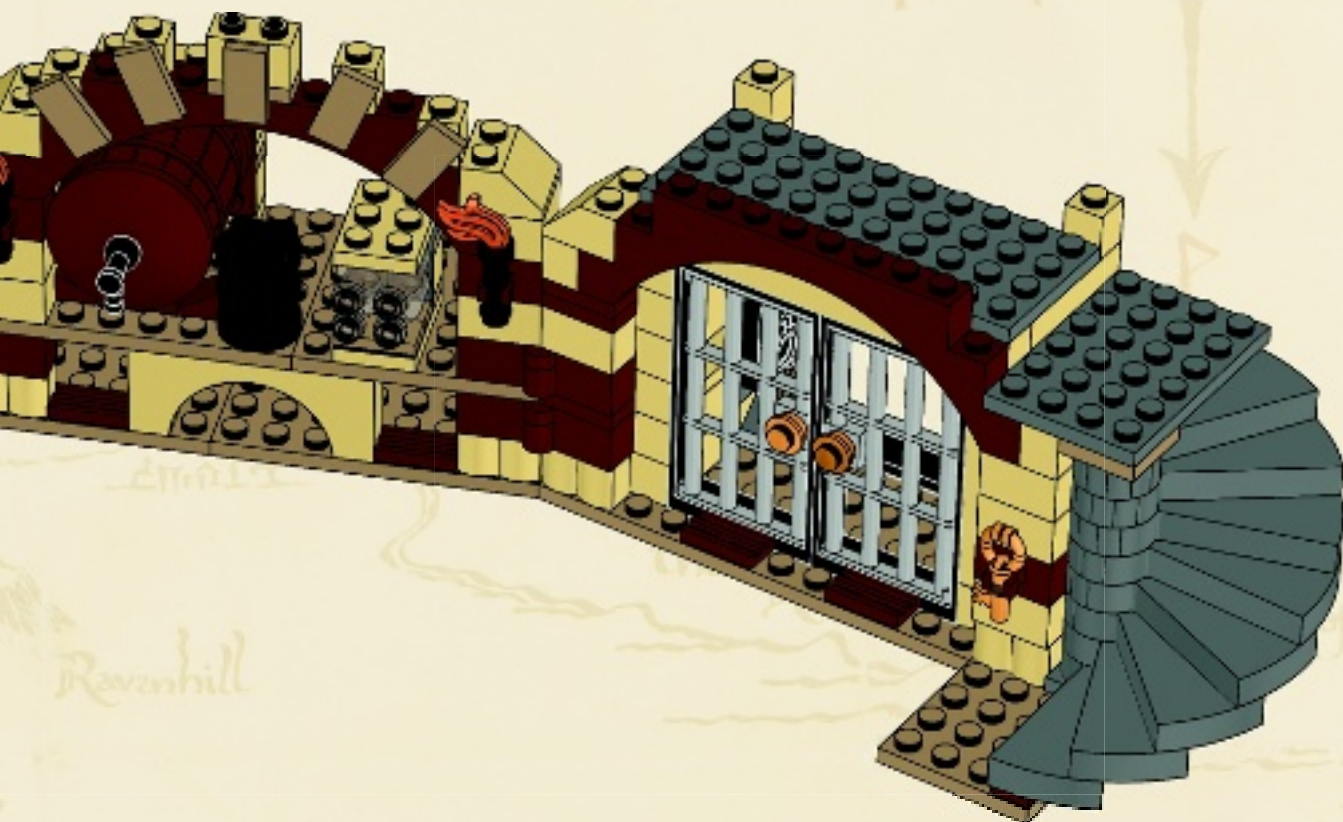

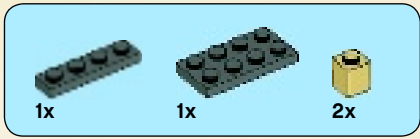

48

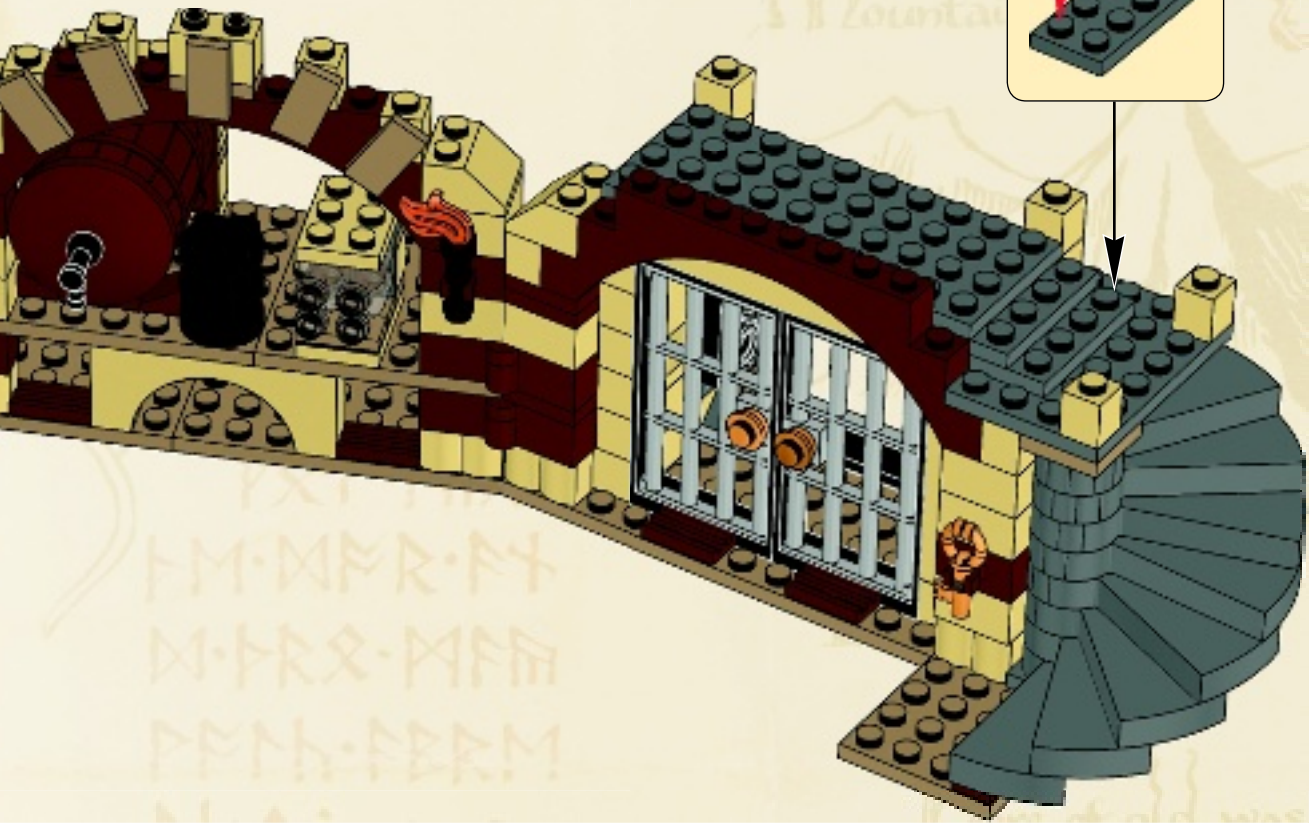
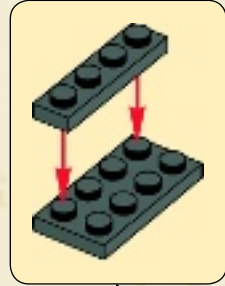



4x



1x

49

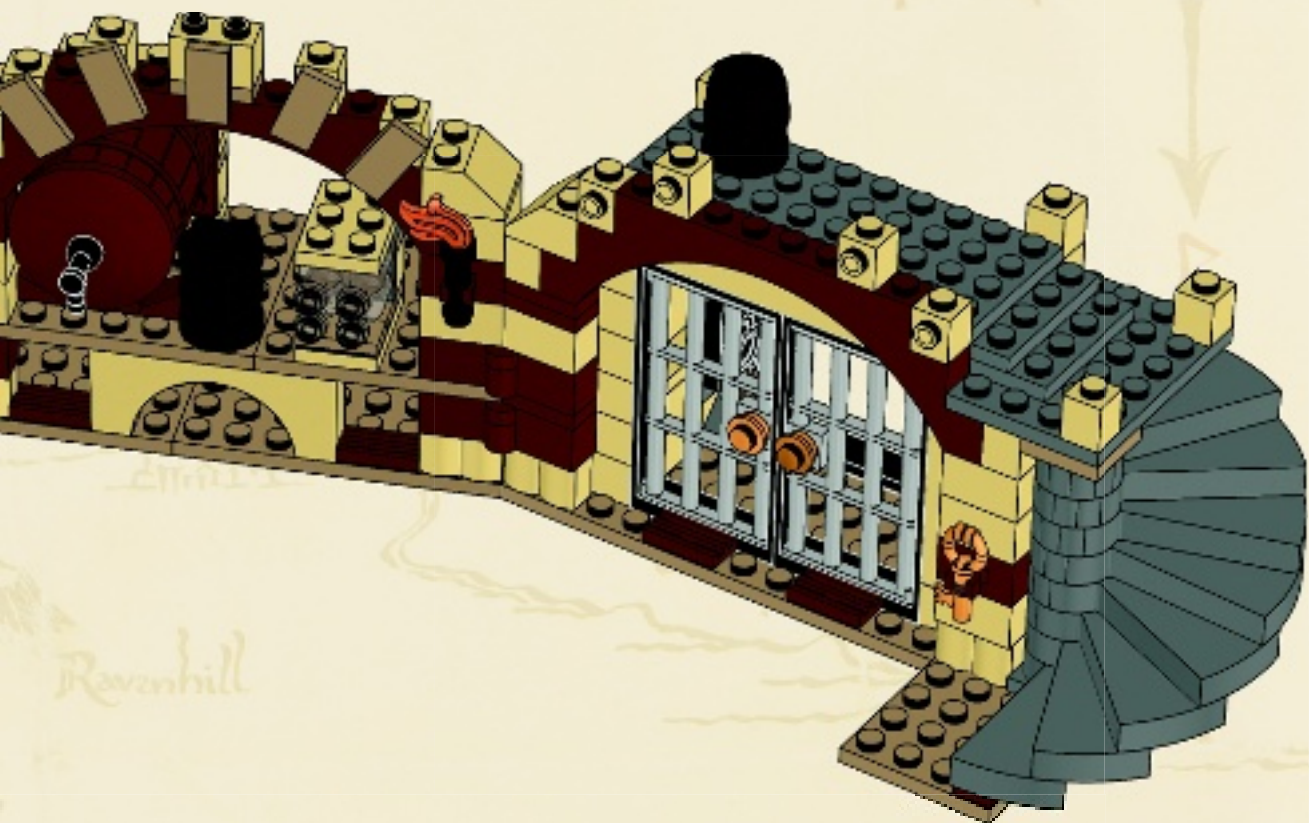

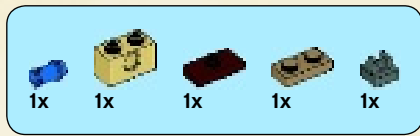

50

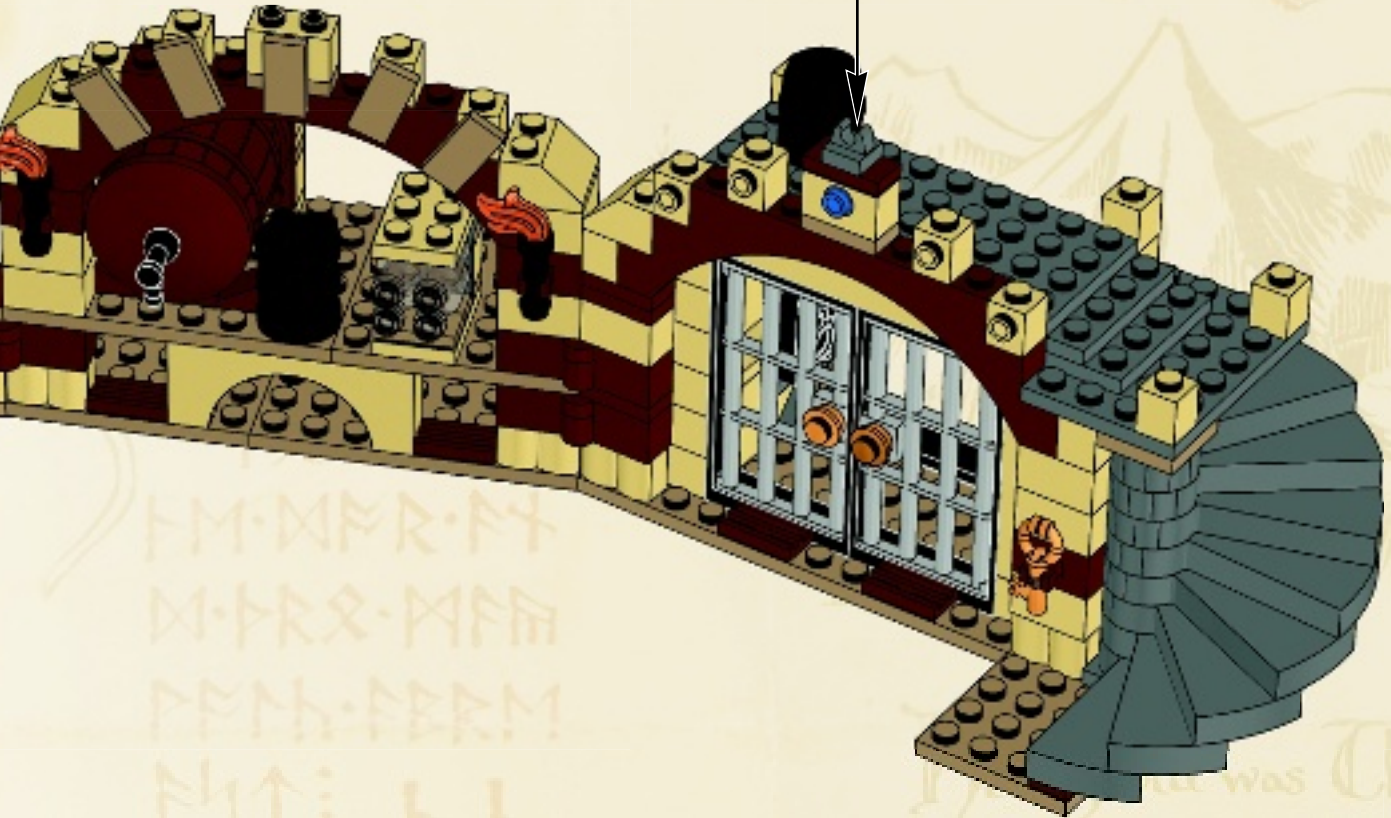
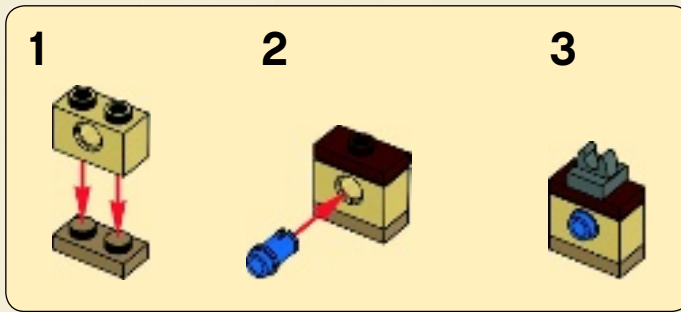



5x

51

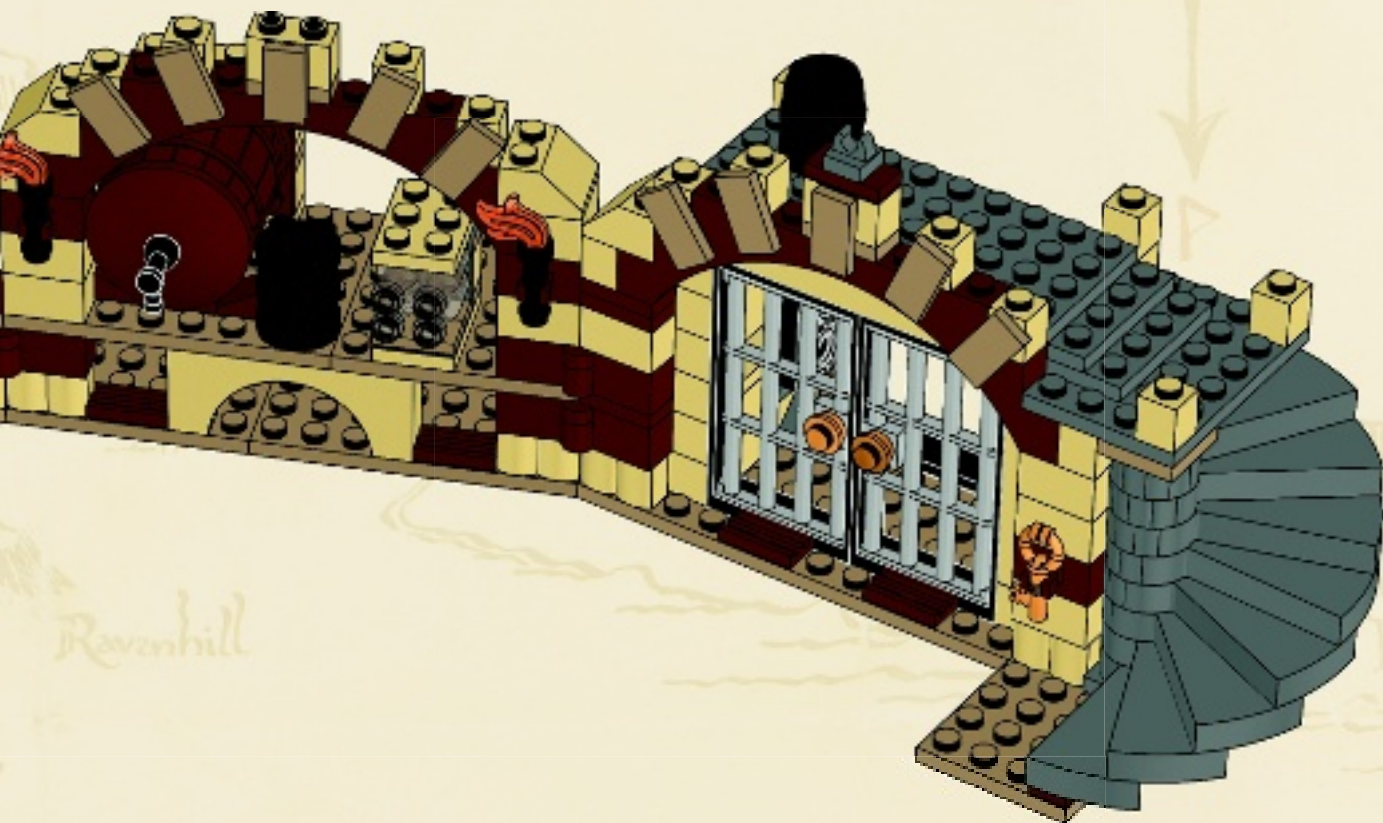



52

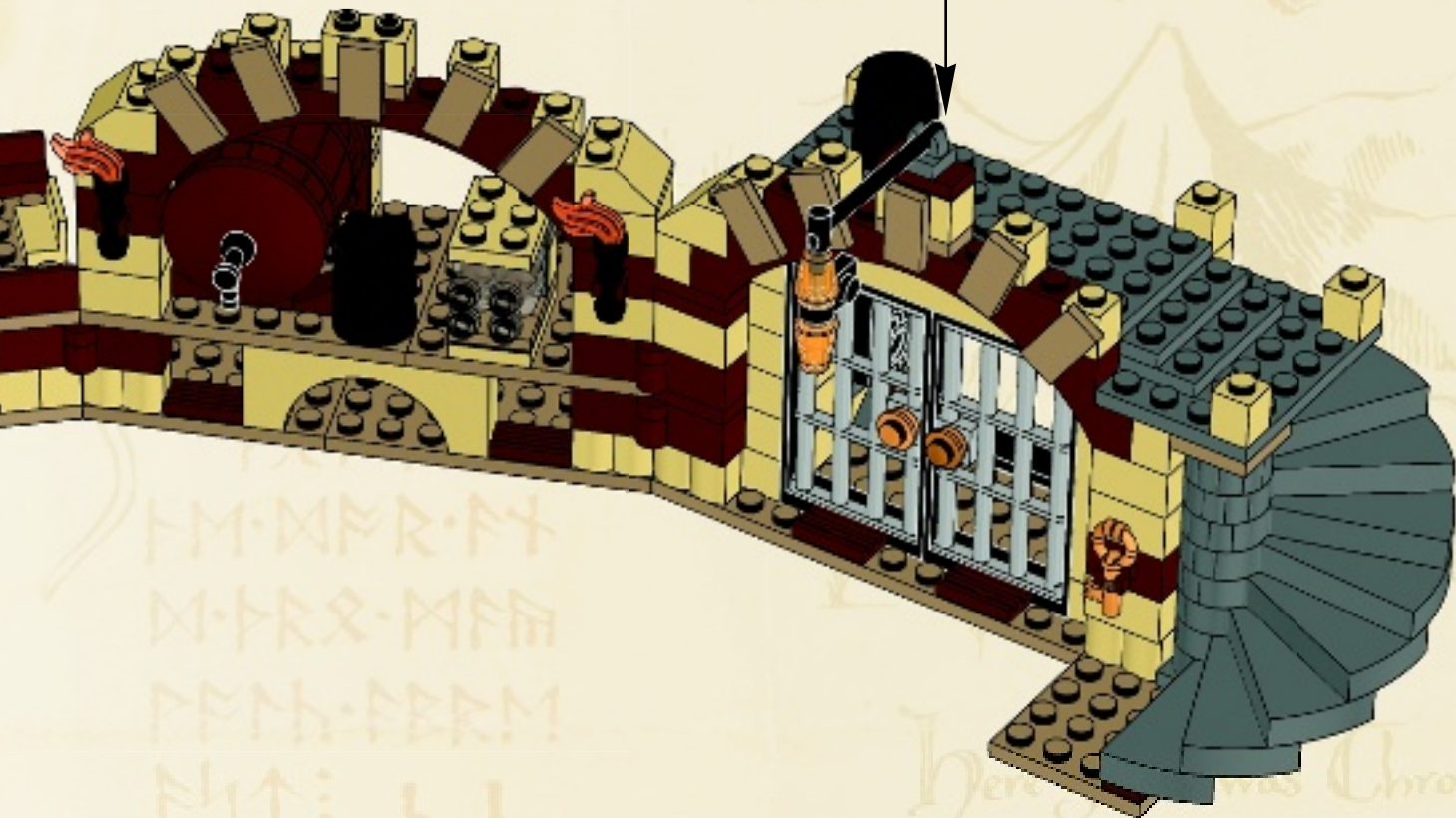
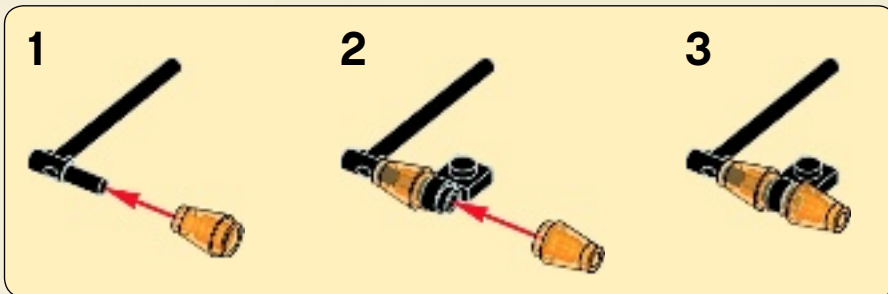

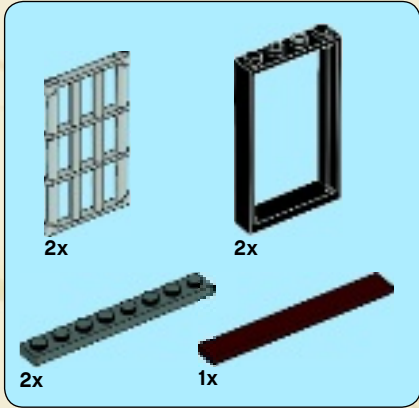
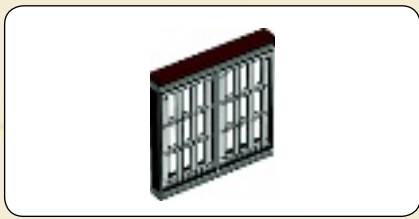

53

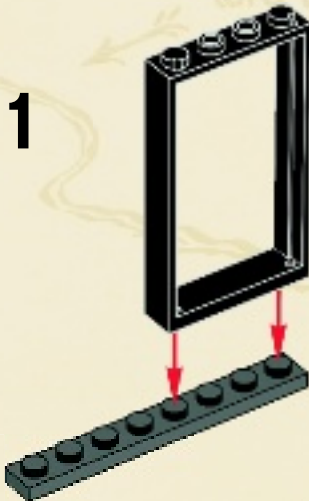

2

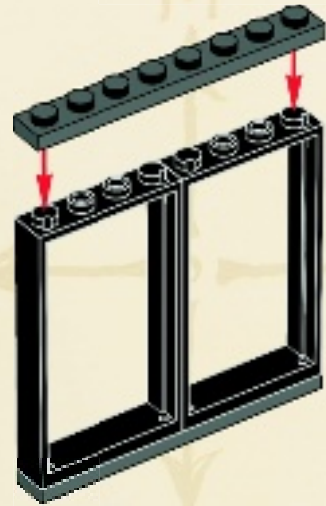

3

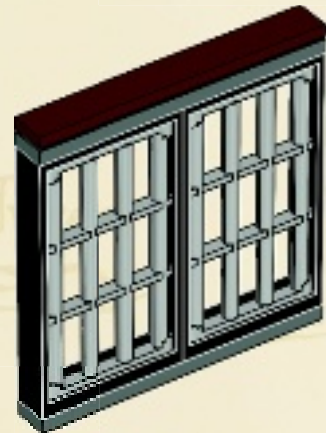

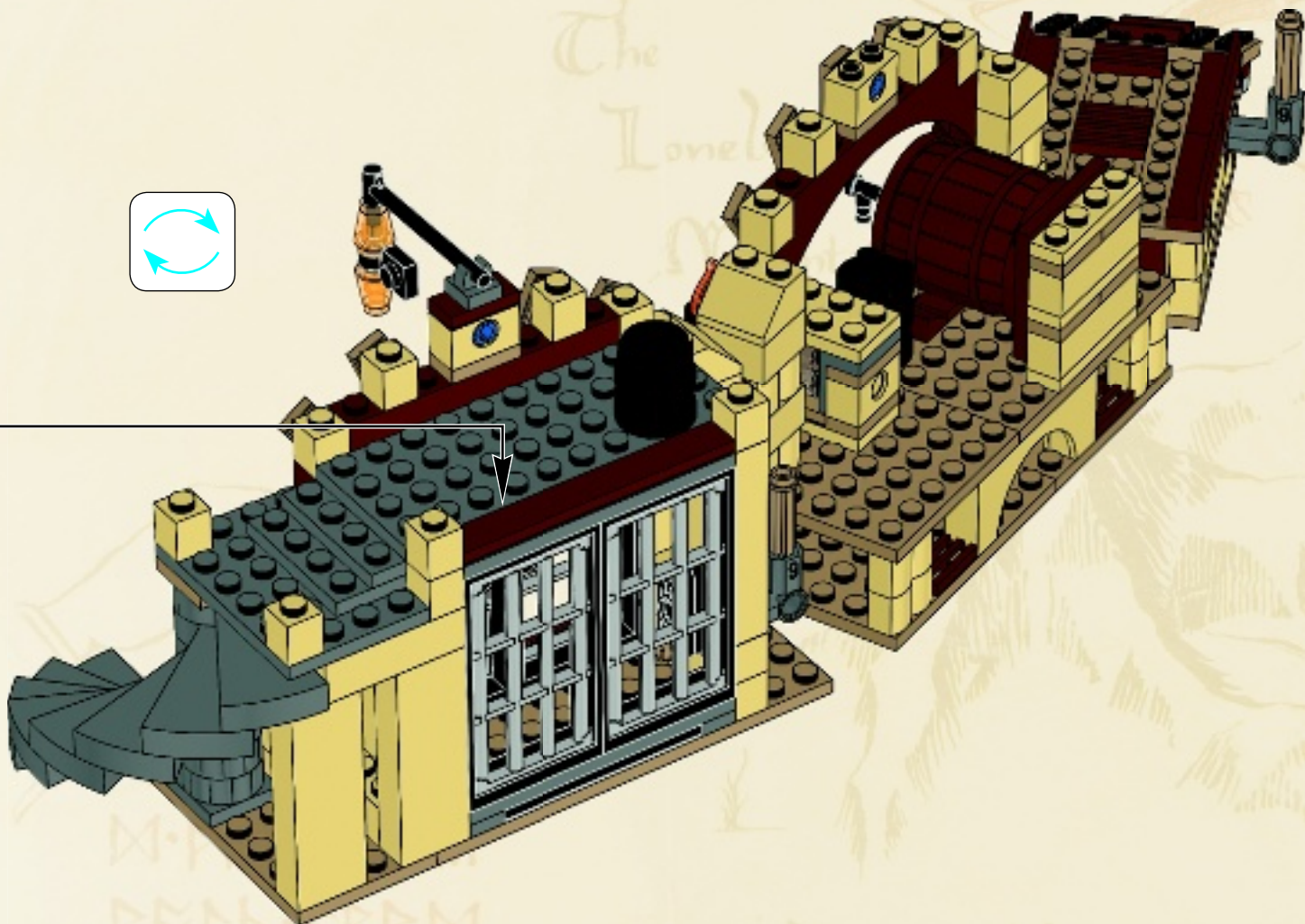
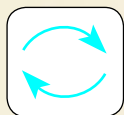

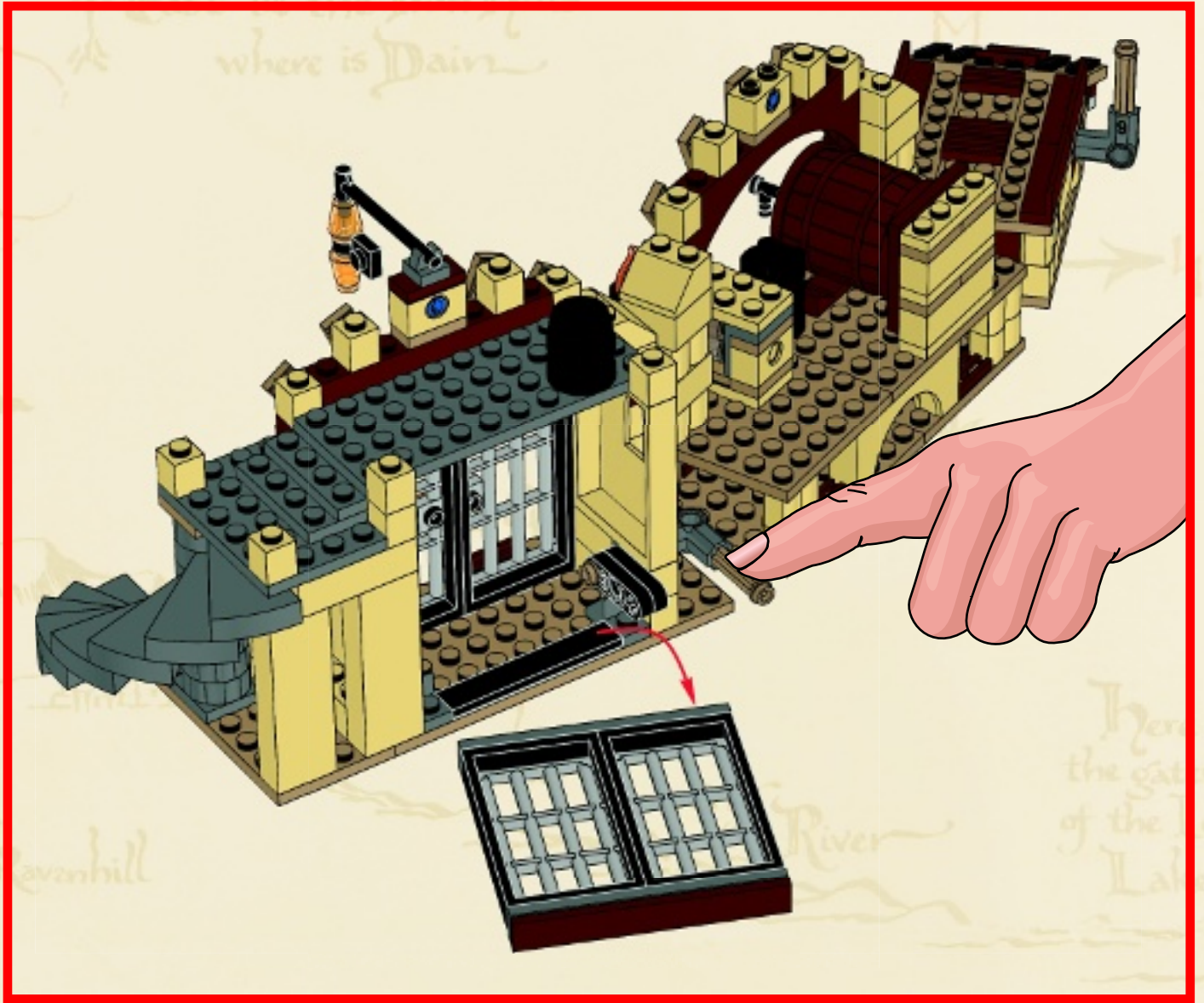

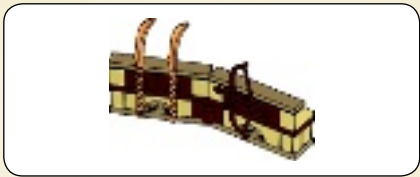

1

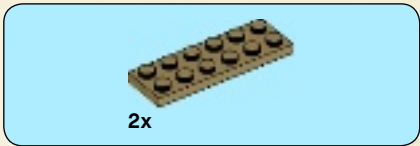
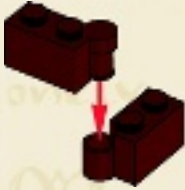

2

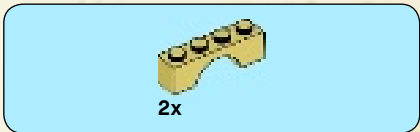
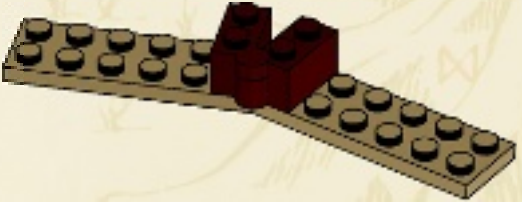

3

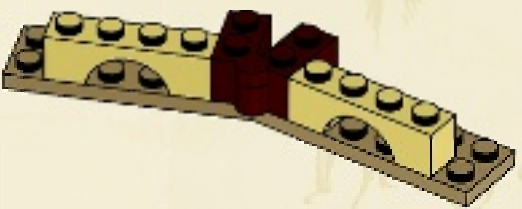



2x

4



4x

5

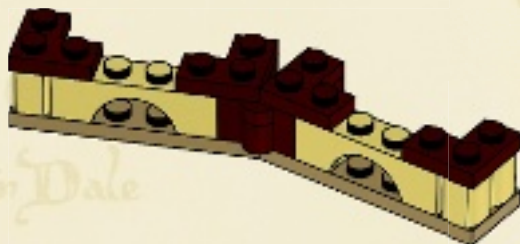

2x

6





4x

7

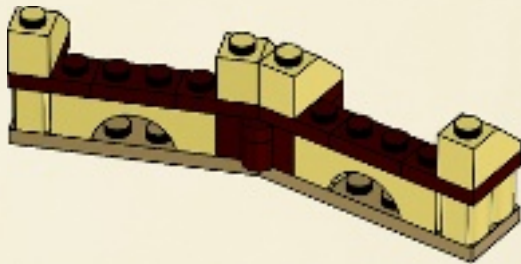

4x

8



2x

9



1x



2x

10

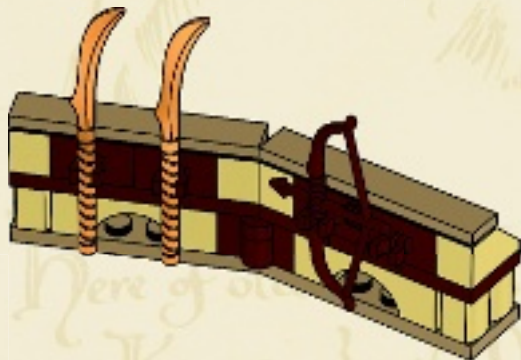

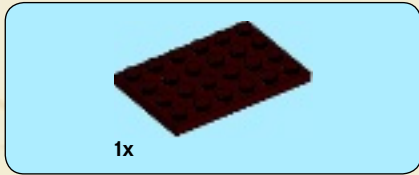

1



2

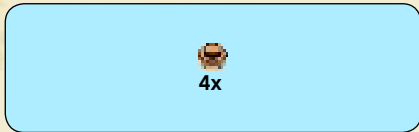
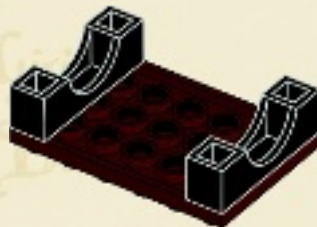

3





2x

4



1x



1x



2x

5

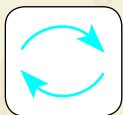

2x



2x



8x

6

1



2



3



2x





1x

1



2x

2



2x



1x



1x

3



1x

4





2x

5



1x



1x



1x

6



1x



1x



1x

7

1



2



↑ East lie the Iron Hills
where is Dain

M



Here is
the gateway
of the Long
Lake

the Running River

Ravenhill



1x
6022273



1x
6021594



1x
6022246



2x
4540865



2x
4567338



1x
4119410



2x
4535738

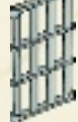

2x
4599496



2x
4610149



1x
6029941



1x
4211570



1x
6006032



1x
6015922



1x
6020525



1x
6020742



1x
6020770



6x
4523159



1x
6009771



2x
6013711



1x
6022033



1x
6002750



1x
6002763



1x
6022271



3x
4273965



2x
4623298



3x
4536677



3x
4538950



1x
6005225



1x
4529672



1x
6023064



1x
6028771



1x
6028771



1x
6030710



2x
4210671



8x
4153418



1x
6002173



1x
6002173



1x
4210639



2x
4210935



2x
4277928



1x
4211129



2x
4210633



2x
4621917



2x
4211094



2x
4211133



1x
4211001



1x
4211065



2x
4210998



1x
4211115



1x
4211122



1x
4211122



2x
6016059



12x
4528604



13x
4496699



1x
4541618



4x
6013821



2x
4507047



2x
4550329



5x
4246957



3x
4530712



2x
4251796



1x
6001001



1x
4266897



Customer Service
Kundenservice
Service Consommateurs
Servicio Al Consumidor

LEGO.com/service or dial



: 00800 5346 5555
 : 1-800-422-5346



□ 79010
Goblin Soldier



□ 79010
Nori the Dwarf

□ 79004
Bilbo Baggins™



□ 79010
Goblin Soldier

□ 79010
Dori the Dwarf



□ 79003
Dwalin the Dwarf

□ 79002
Hunter Orc



□ 79010
The Goblin King



□ 79004
Oin the Dwarf

□ 79004
Mirkwood™ Elf Chief



□ 79003
Balin the Dwarf



□ 79010
Gandalf™ the Grey



□ 79001
Kili the Dwarf



□ 79003
Bilbo Baggins™



□ 79000
Bilbo Baggins™

□ 79000
Gollum™



□ 79003
Bofur the Dwarf



□ 79004
Mirkwood™ Elf Guard

□ 79004
Gloin the Dwarf



□ 79001
Fili the Dwarf



□ 79001
Legolas Greenleaf™



□ 79002
Thorin Oakenshield™



□ 79002
Yazneg™

□ 79002
Warg



□ 79002
Warg



□ 79002
Bifur the Dwarf

□ 79010
Goblin Scribe



□ 79010
Ori the Dwarf



□ 79003
Bombur the Dwarf



□ 79003
Gandalf™ the Grey



□ 79001
Tauriel™



□ 79002
Hunter Orc

79010



79003



79002





THE HOBBIT

AN UNEXPECTED JOURNEY

LEGO.com/thehobbit



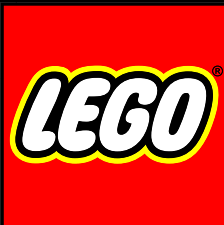

THE LORD OF THE RINGS



The Quest of the Fellowship Continues in 2013

LEGO.com/thelordoftherings

THE HOBBIT™

AN UNEXPECTED JOURNEY

©2012 The LEGO Group.
THE HOBBIT: AN UNEXPECTED JOURNEY.
© NLP™ Middle-earth Ent. Lic. to New Line.
(s12)



3920
The Hobbit: An
Unexpected Journey

7+ 2-4 15-25



GAMES





WIN!

Go to www.LEGOsurvey.com/product
to fill out a survey for a chance
to win a cool LEGO® Product.
No purchase necessary.
Open to all residents where not prohibited.



www.LEGOsurvey.com/product

GEWINNE! WIN!

Nimm an der Umfrage auf
www.LEGOsurvey.com/product
teil und hab die Chance ein cooles
LEGO® Produkt zu gewinnen!

Die Teilnahme am Gewinnspiel führt zu keinerlei
Kaufverpflichtungen. Teilnahme in allen nicht
ausgeschlossenen Ländern möglich.

Ga naar www.LEGOsurvey.com/product,
vul een
enquêteformulier in en maak
kans op een cool LEGO® product.

Geen aankoopverplichting.
Iedereen mag deelnemen, uitgezonderd
ingezetenden van landen waar een
enquêteverbod geldt.

GAGNE! 当てよう!

Visite www.LEGOsurvey.com/product
pour répondre à un
questionnaire et avoir une chance de
gagner un produit LEGO® très cool!

Aucune obligation d'achat.
Ouvert à tous les résidents des pays
autorisés.

www.LEGOsurvey.com/product にアクセスして、
アンケートにご記入ください。当選者にはレゴ
製品を差し上げます。

お買い上げの必要はありません

禁止されていない限り、すべての皆様にご利用いただけます。