

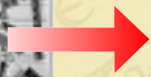

# THE LORD OF THE RINGS

79007

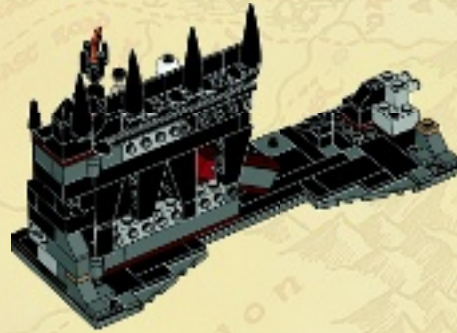



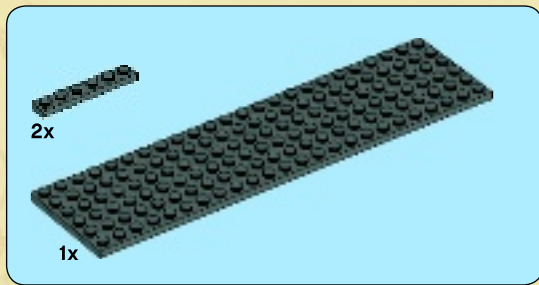

1

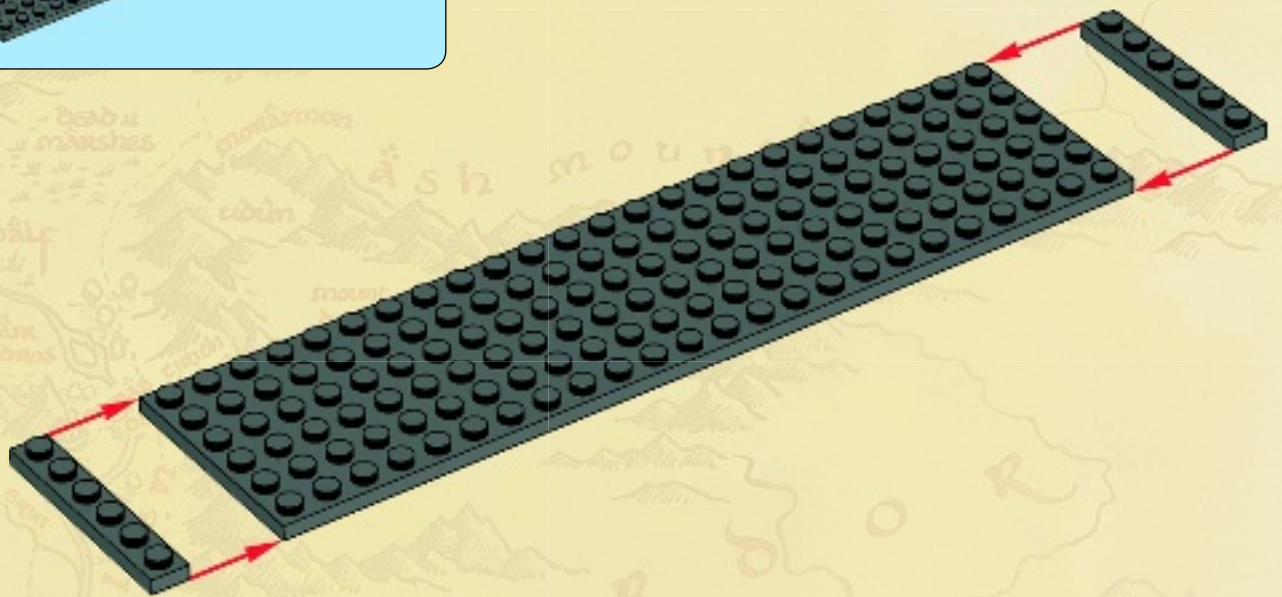

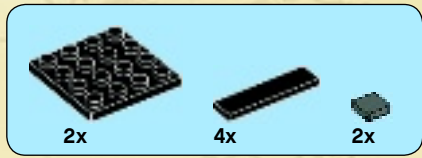

2

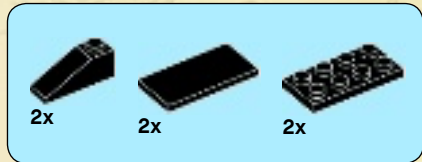
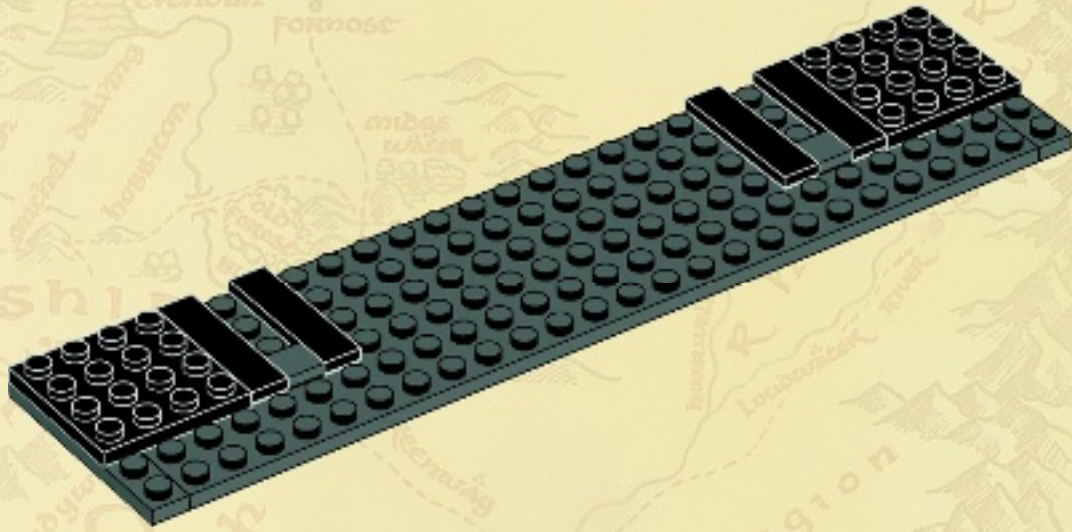

3

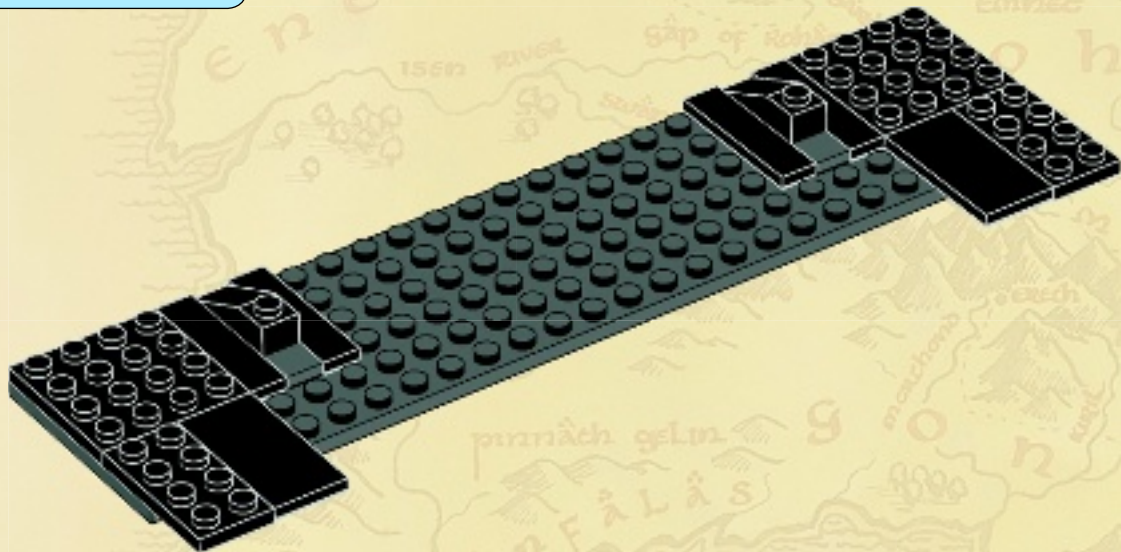

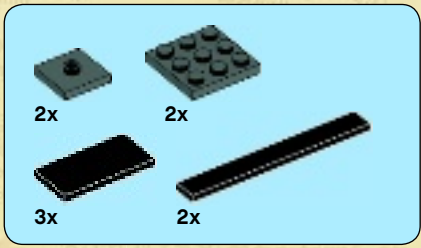

4

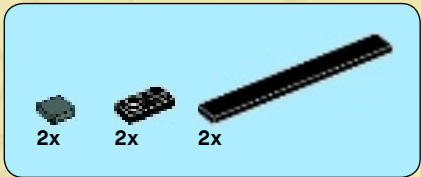
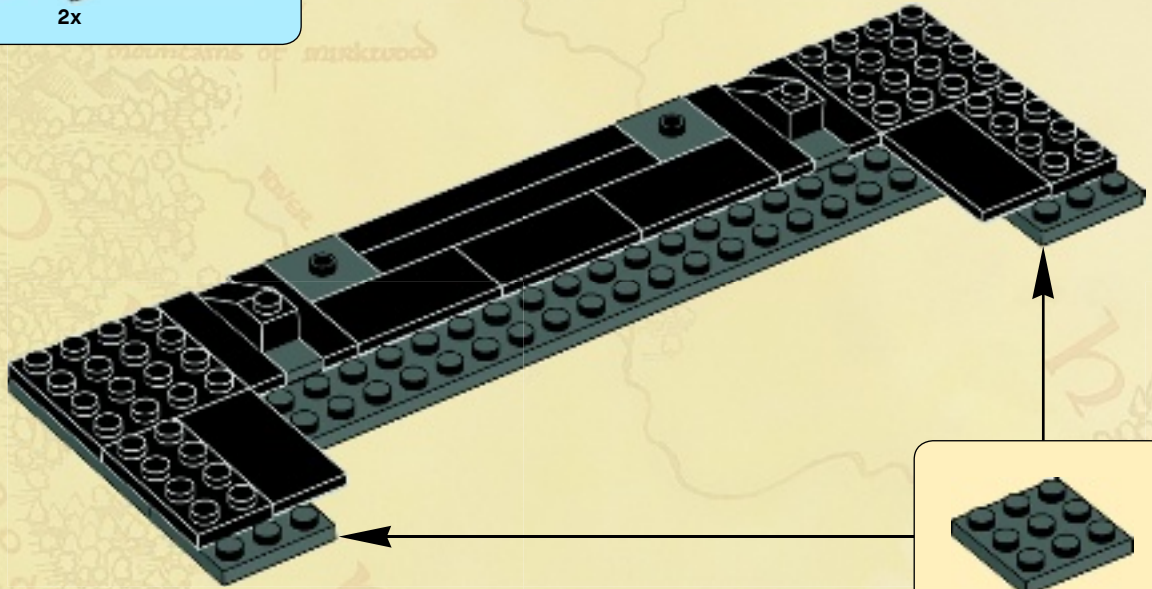

5

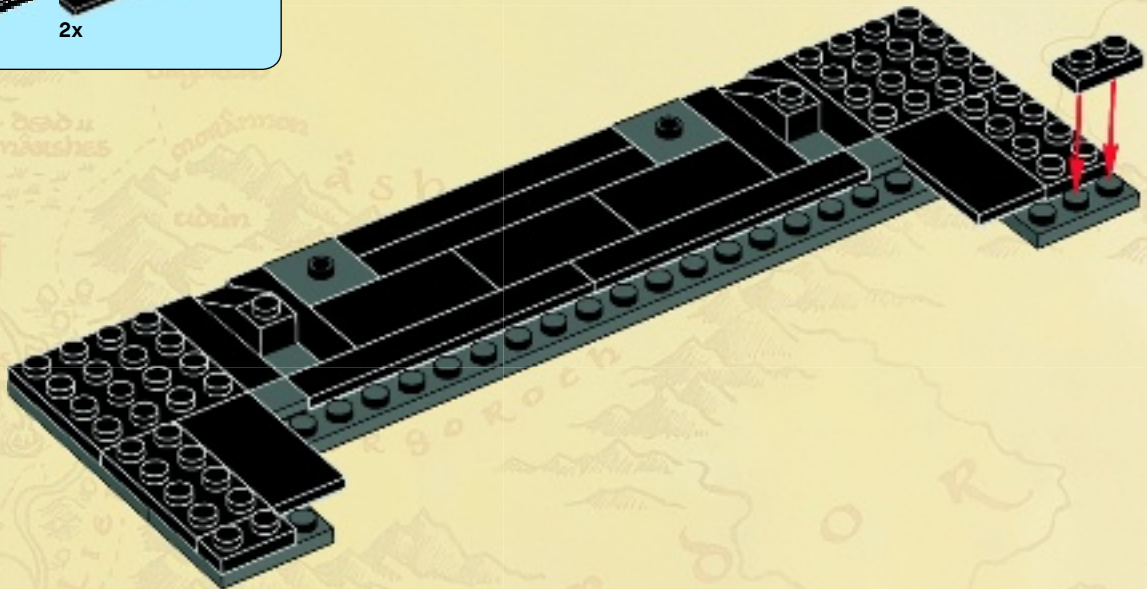

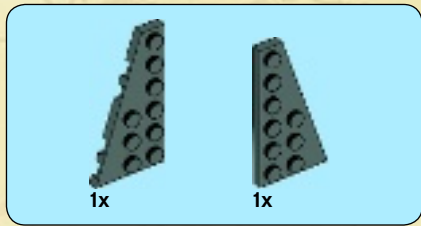

6

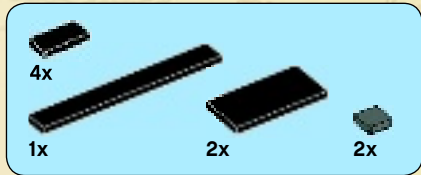
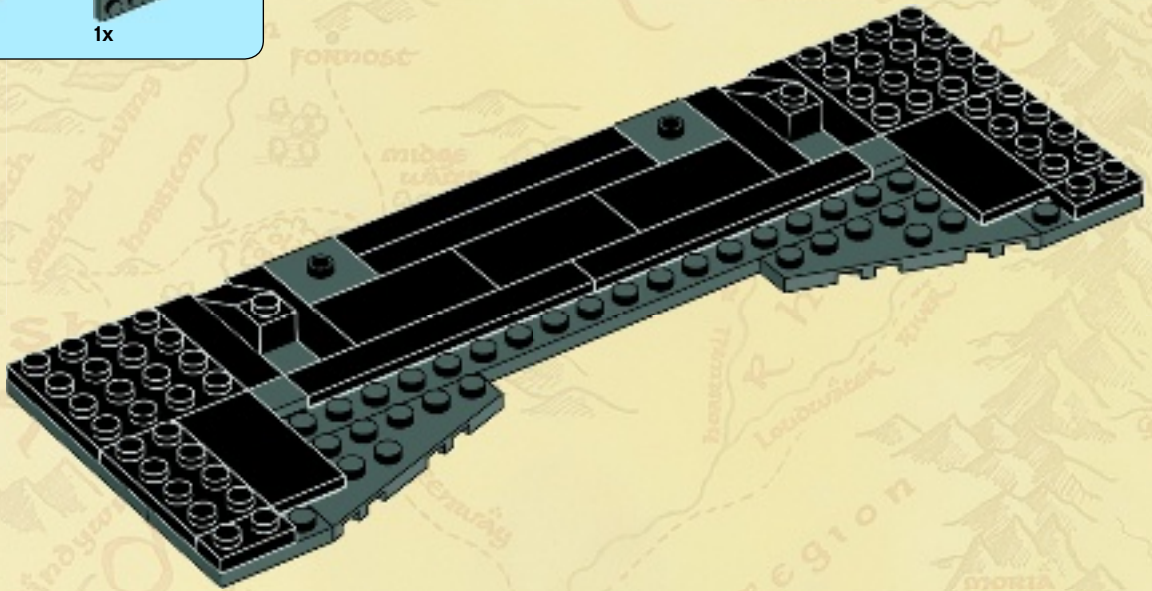

7

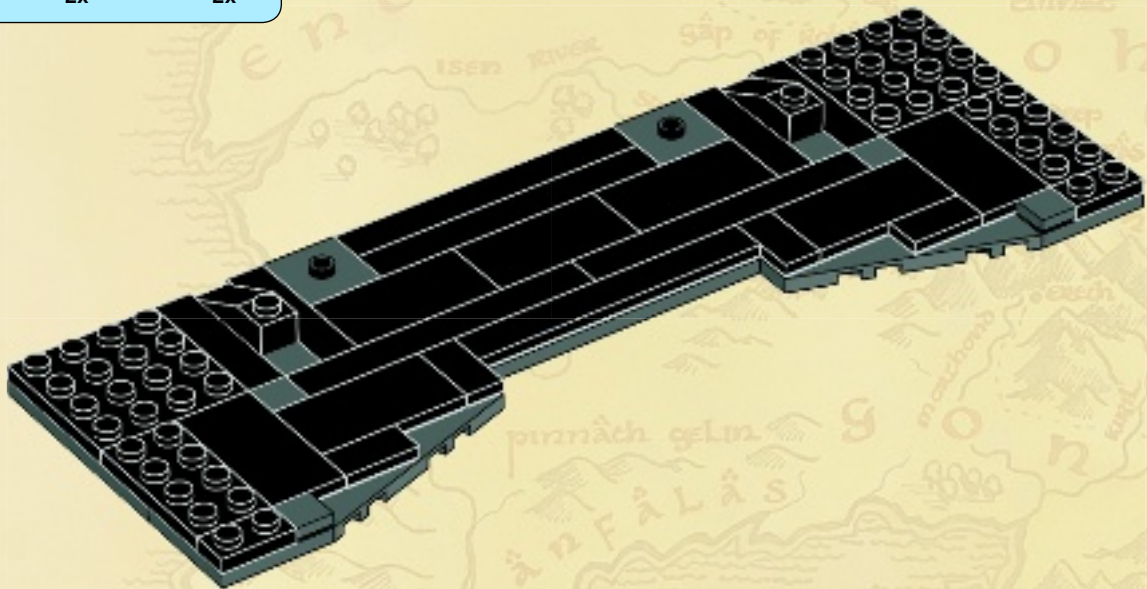



8

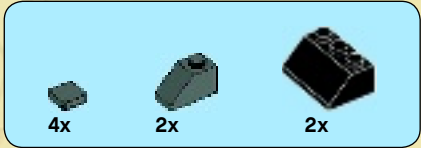
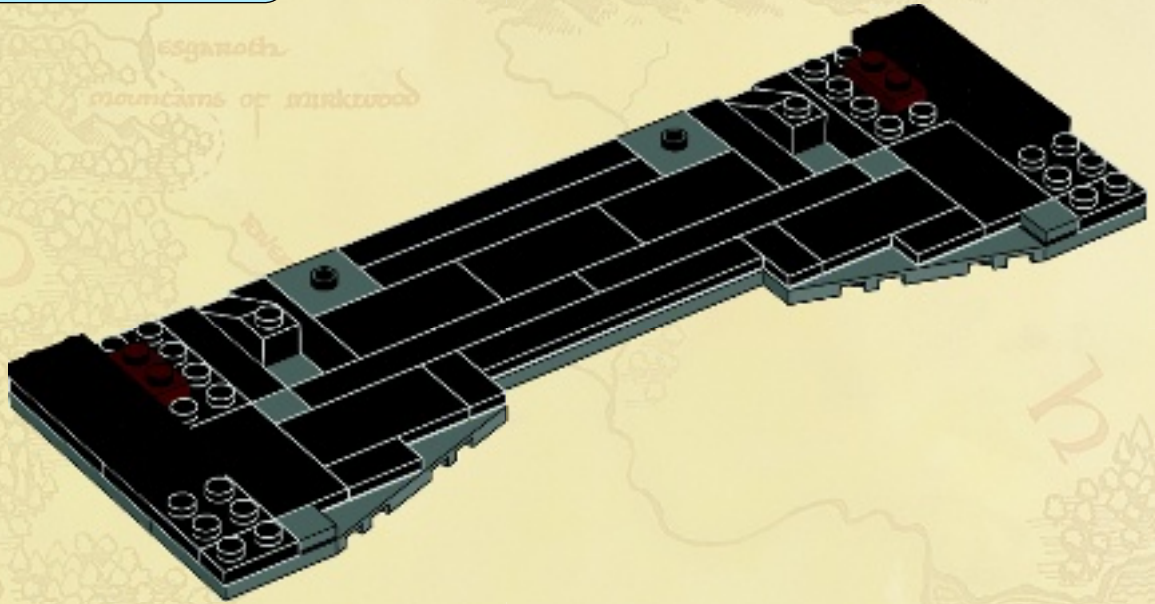

9

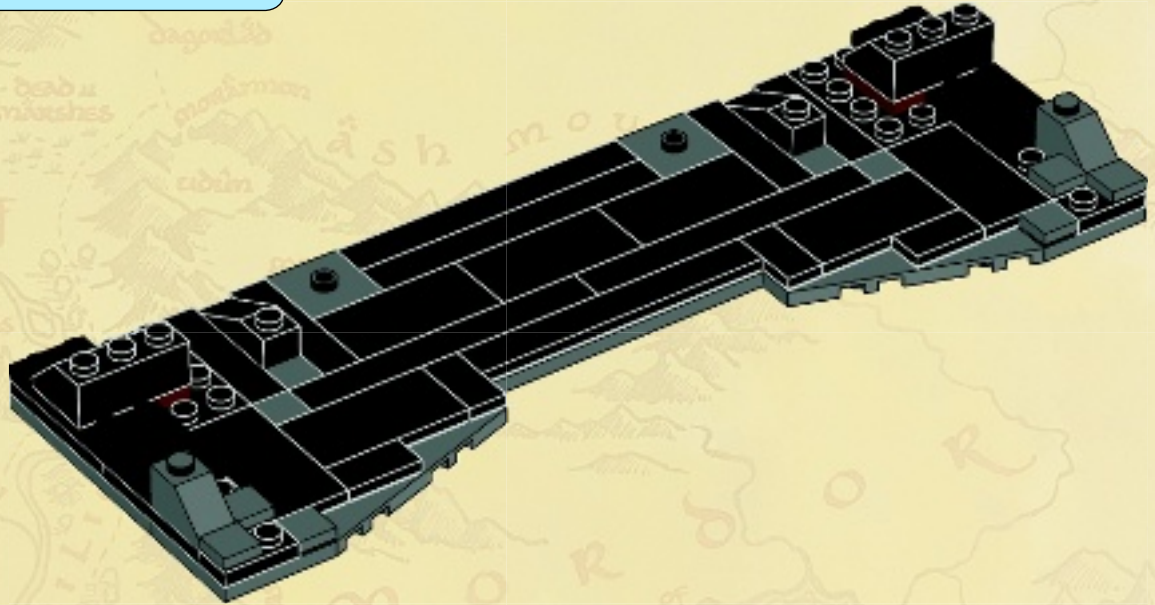

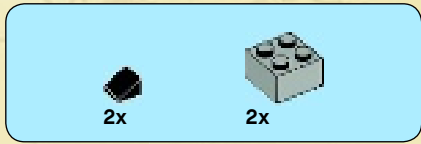

10

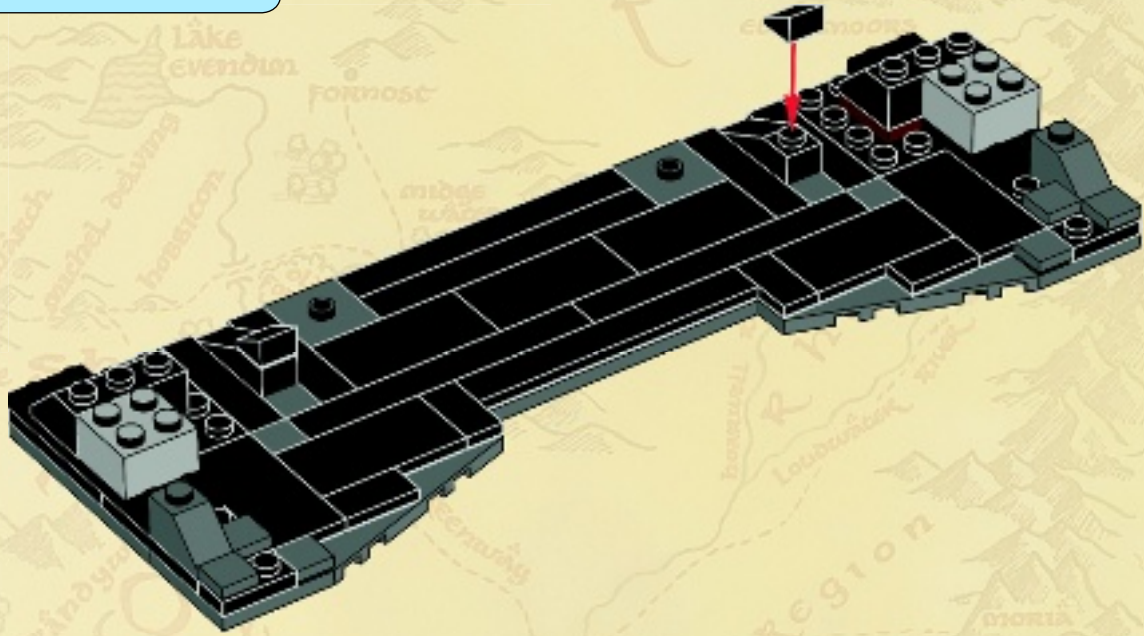

11

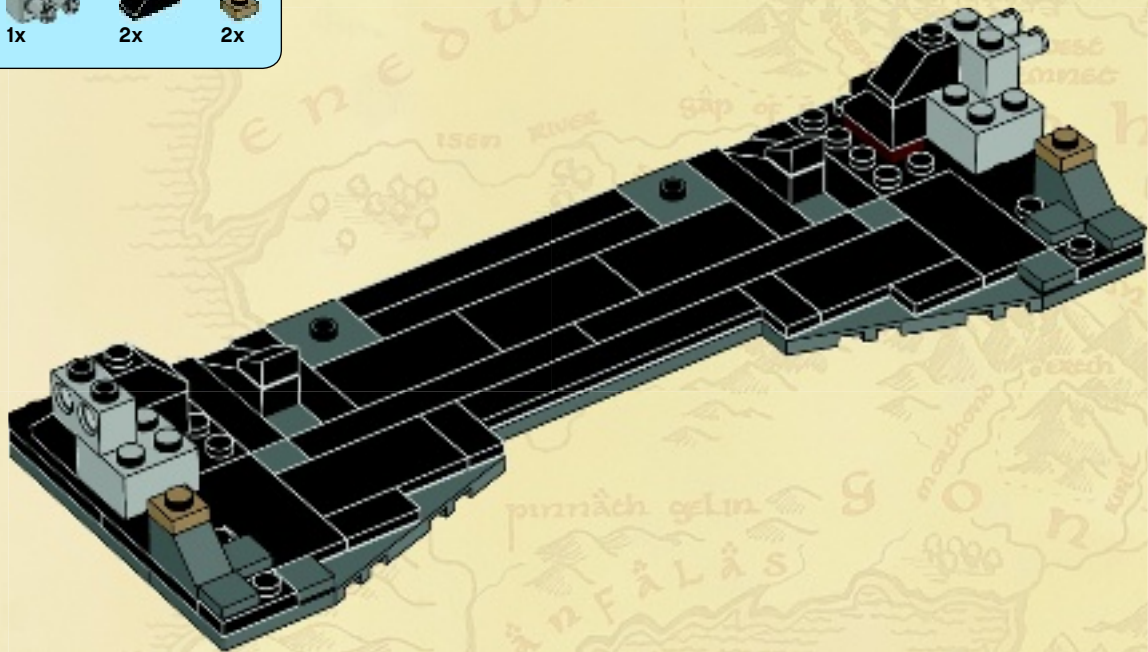



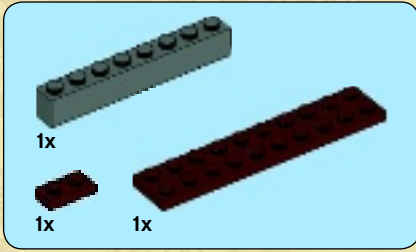

1

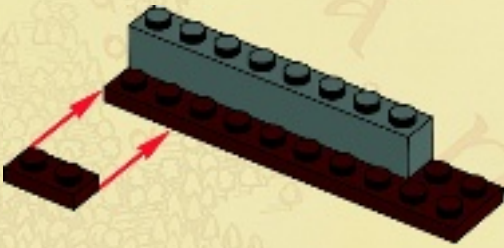

2

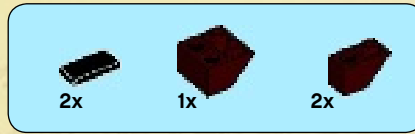
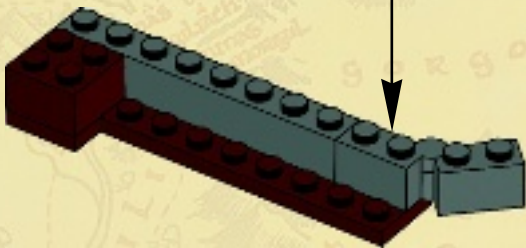
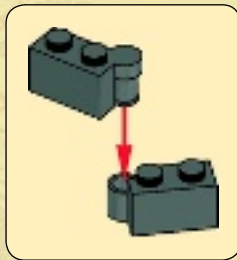

3

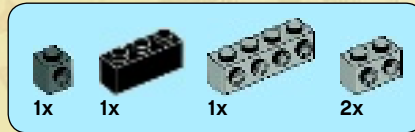
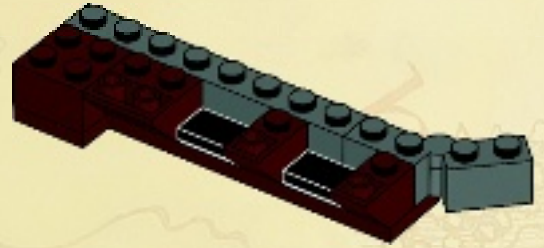

4

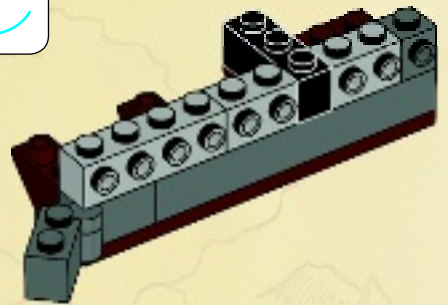
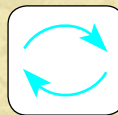

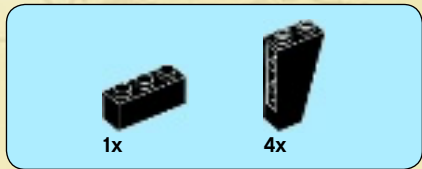

5

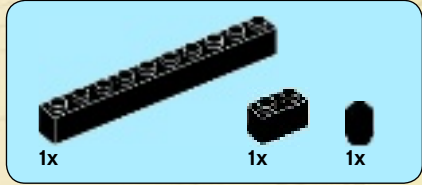
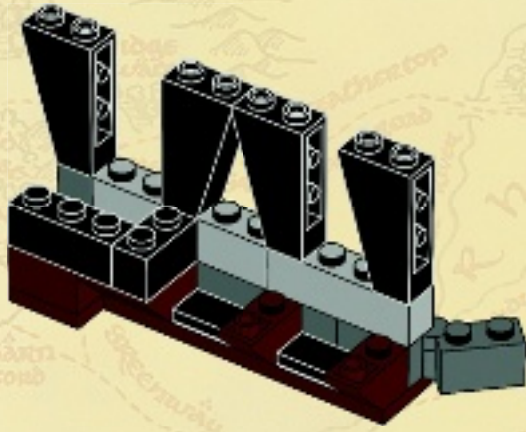

6

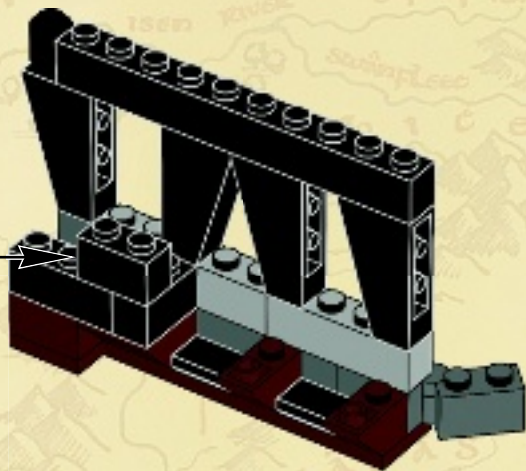
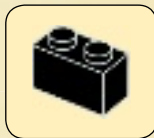

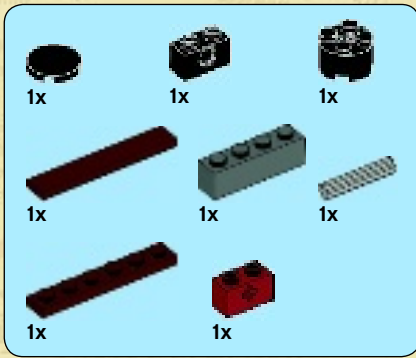

# 7

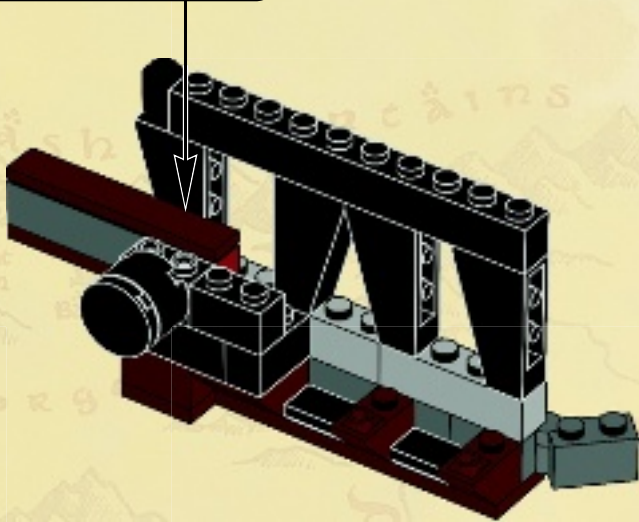
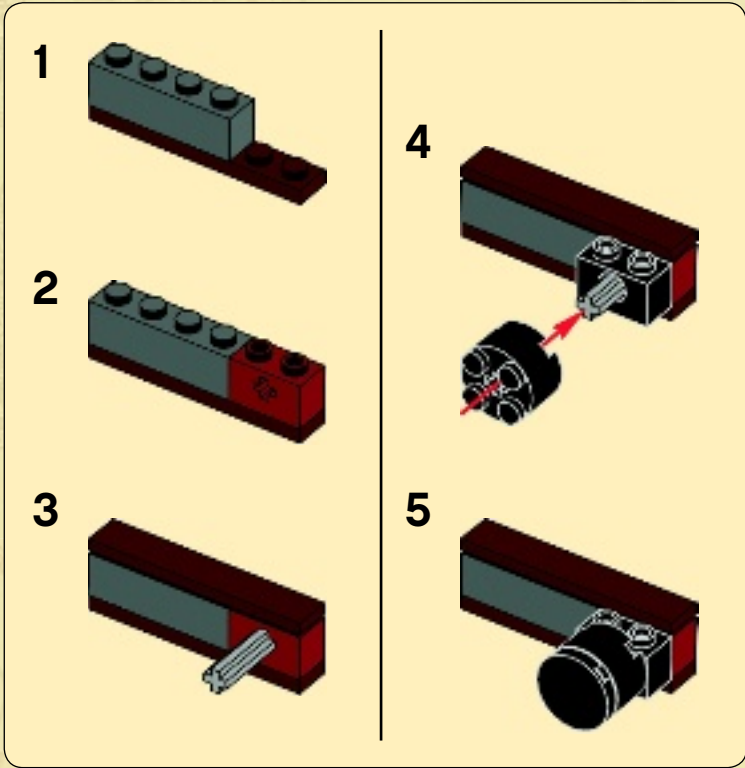

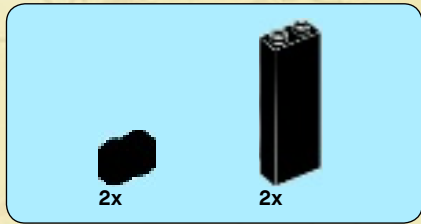

8

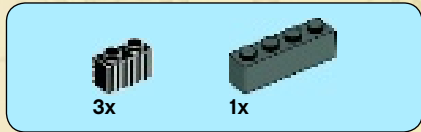
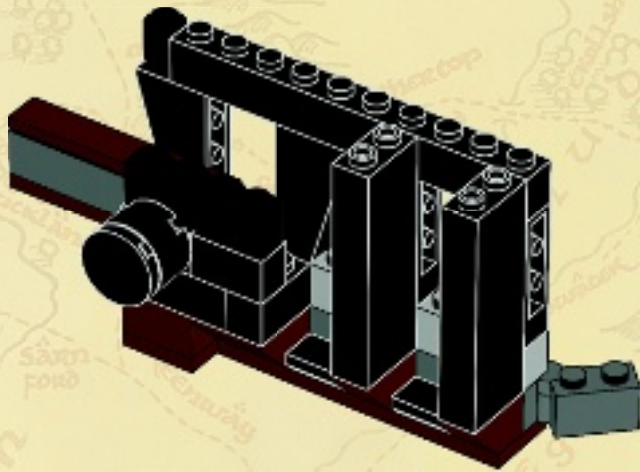

9

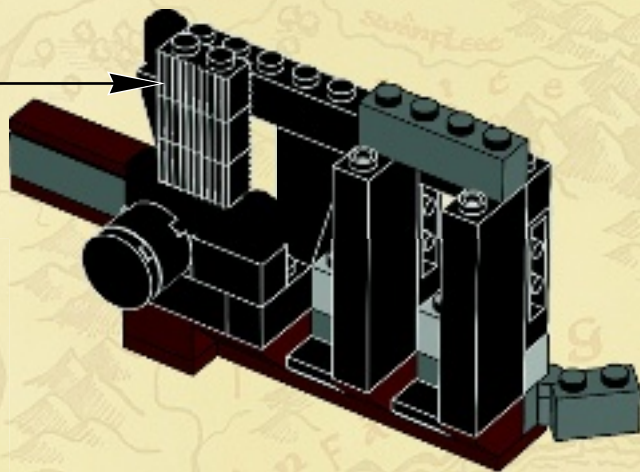
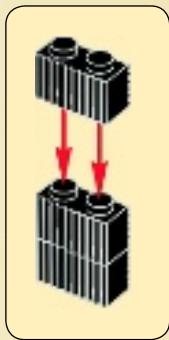

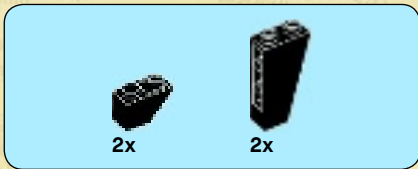

10

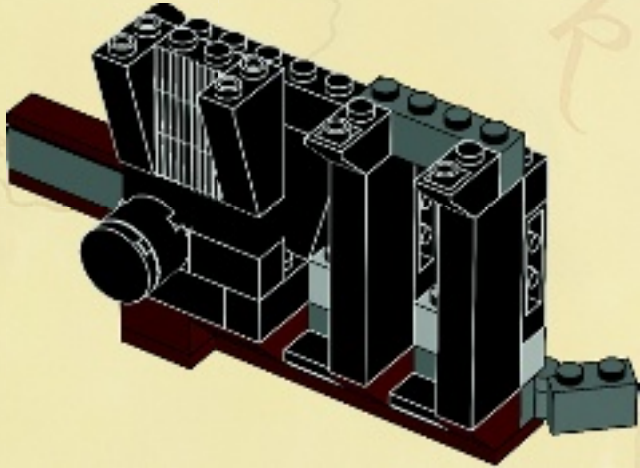

11

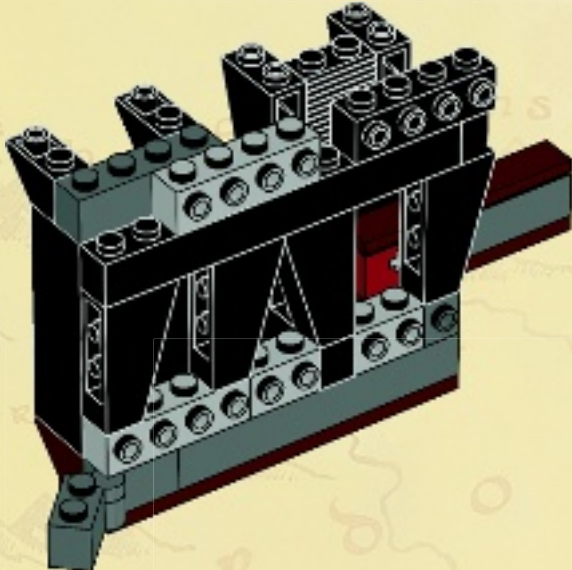

12

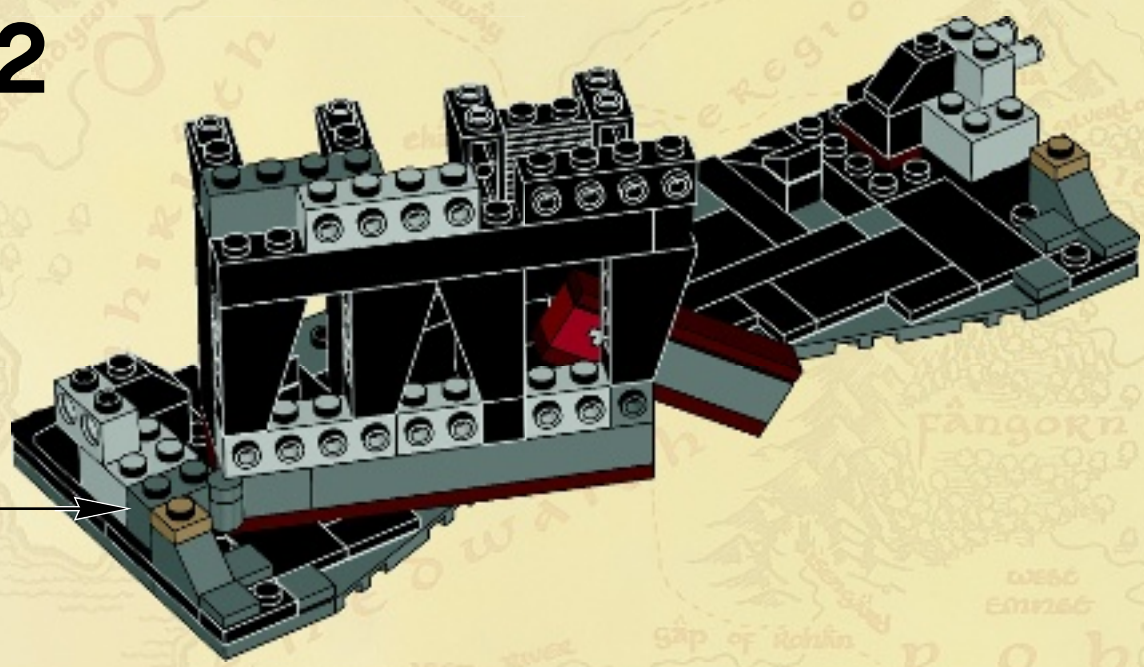



# 13

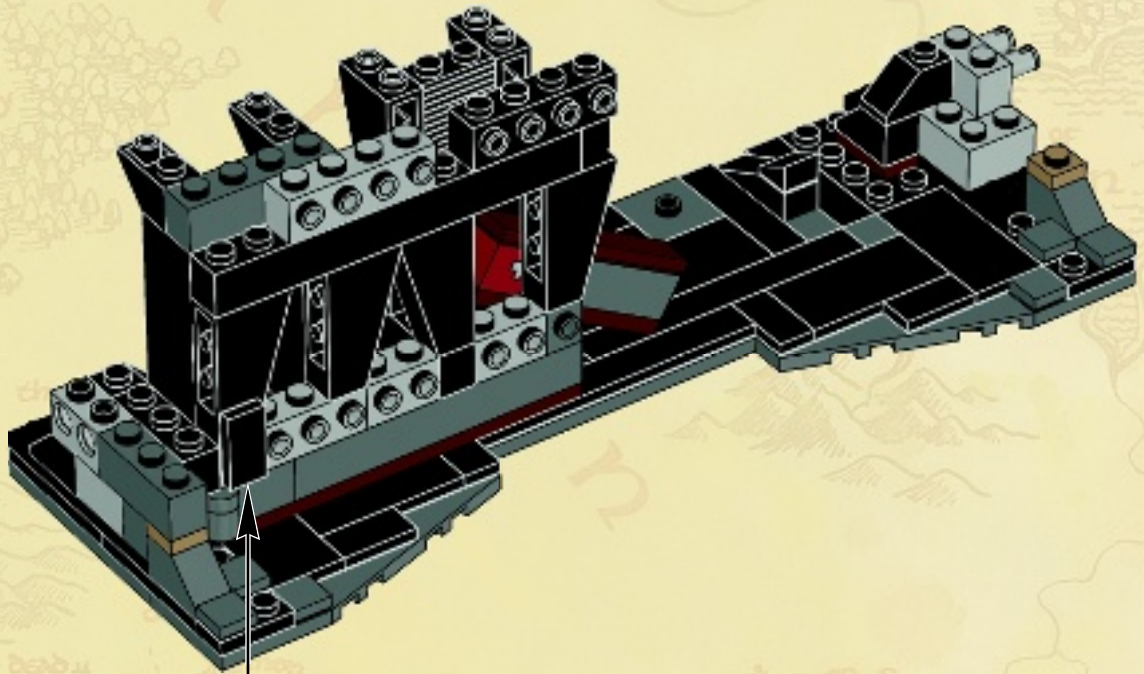



14

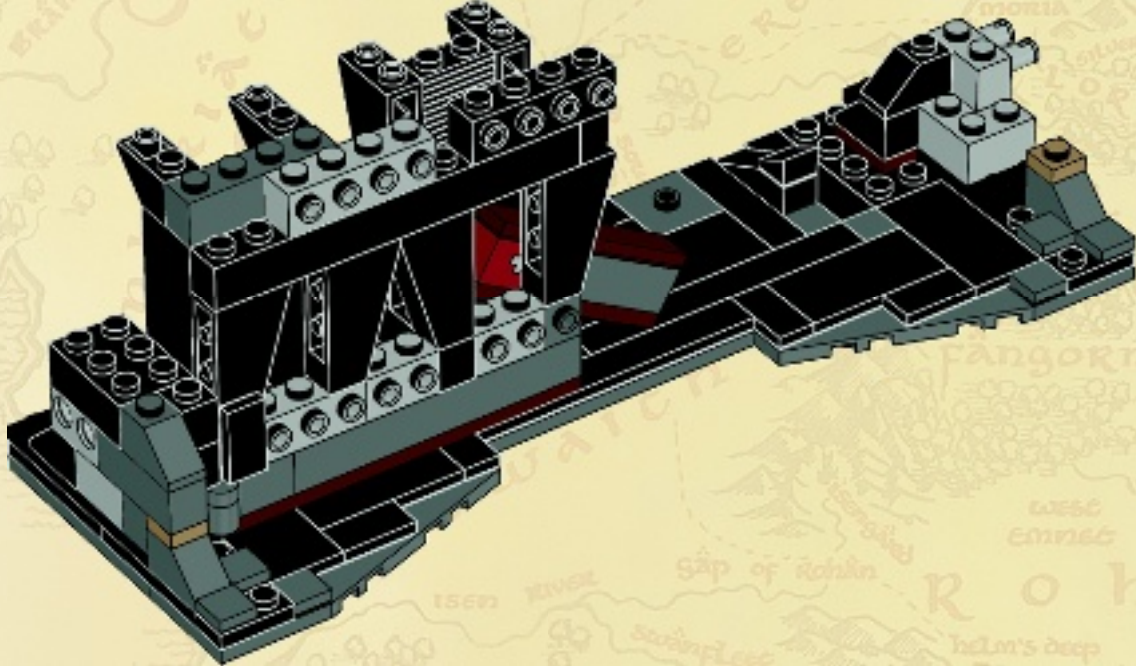





1x



1x

# 15

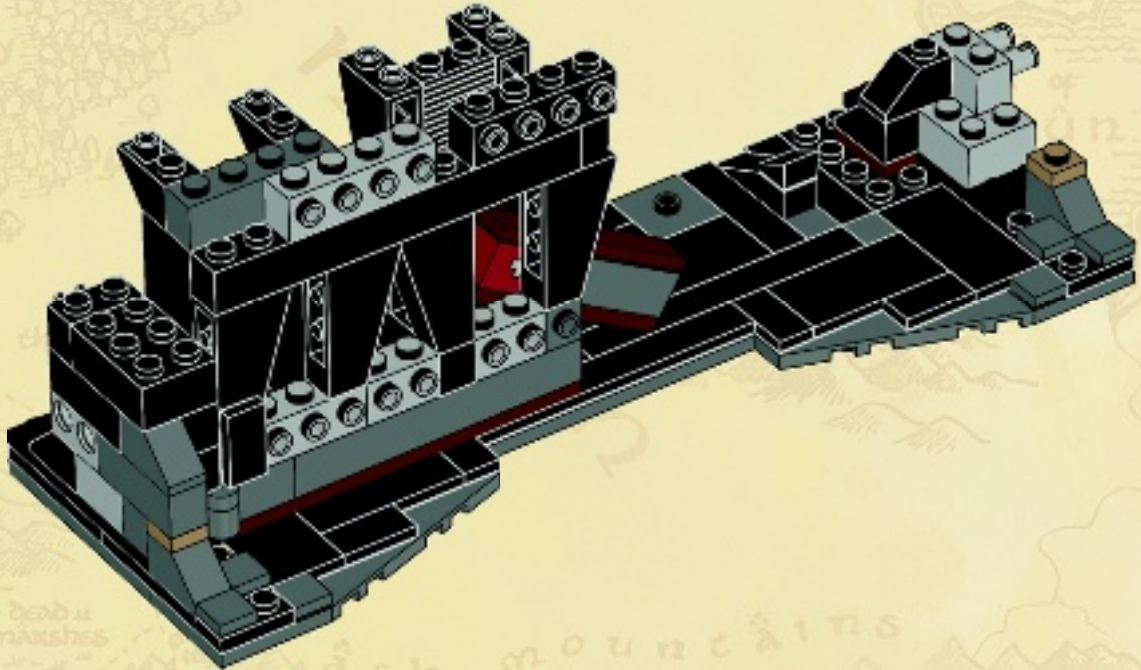



# 16

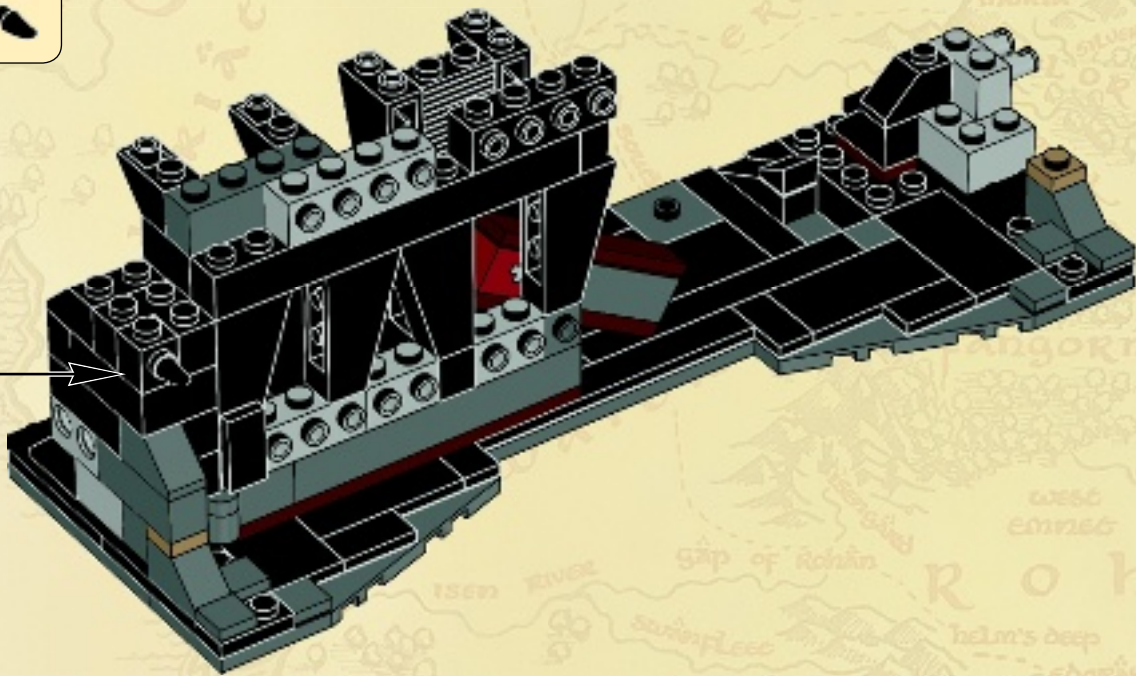

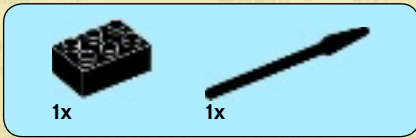

17

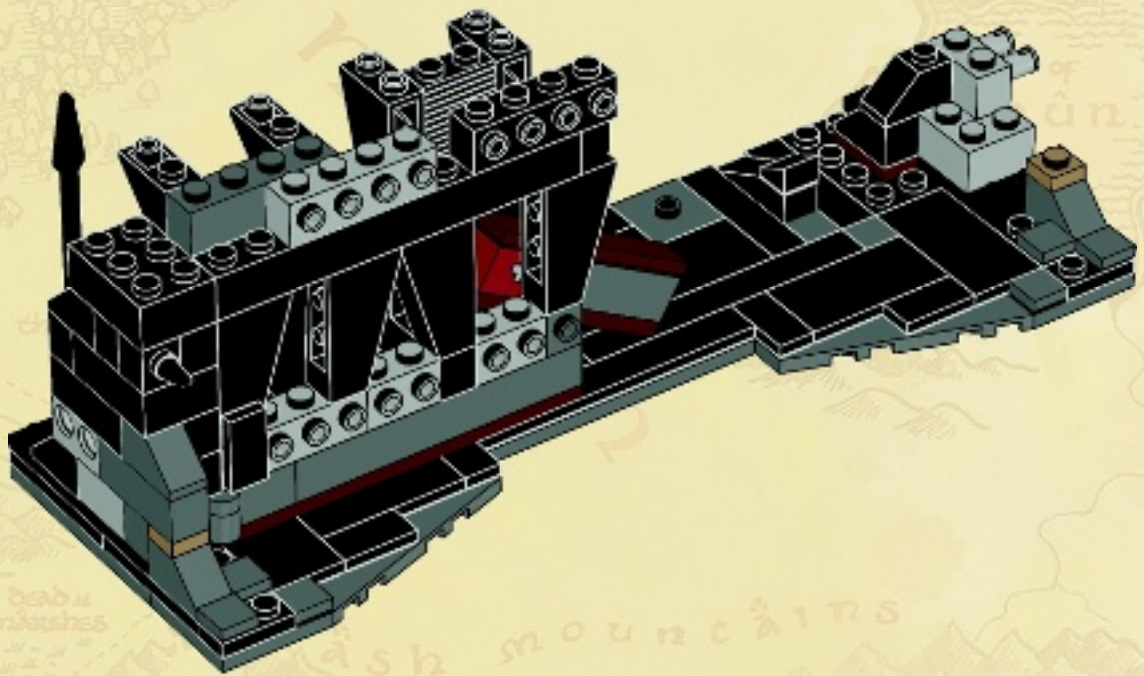



# 18

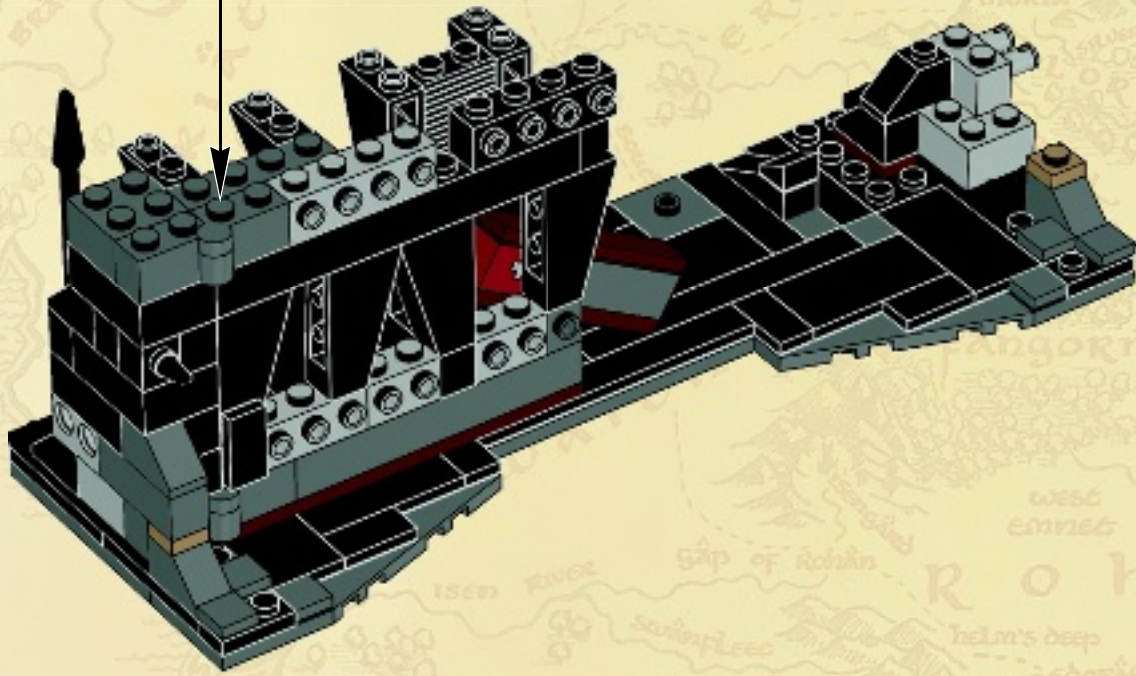
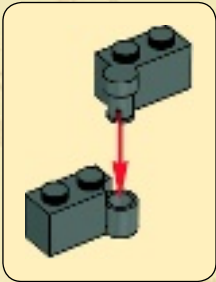

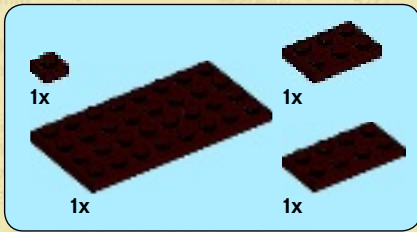

19

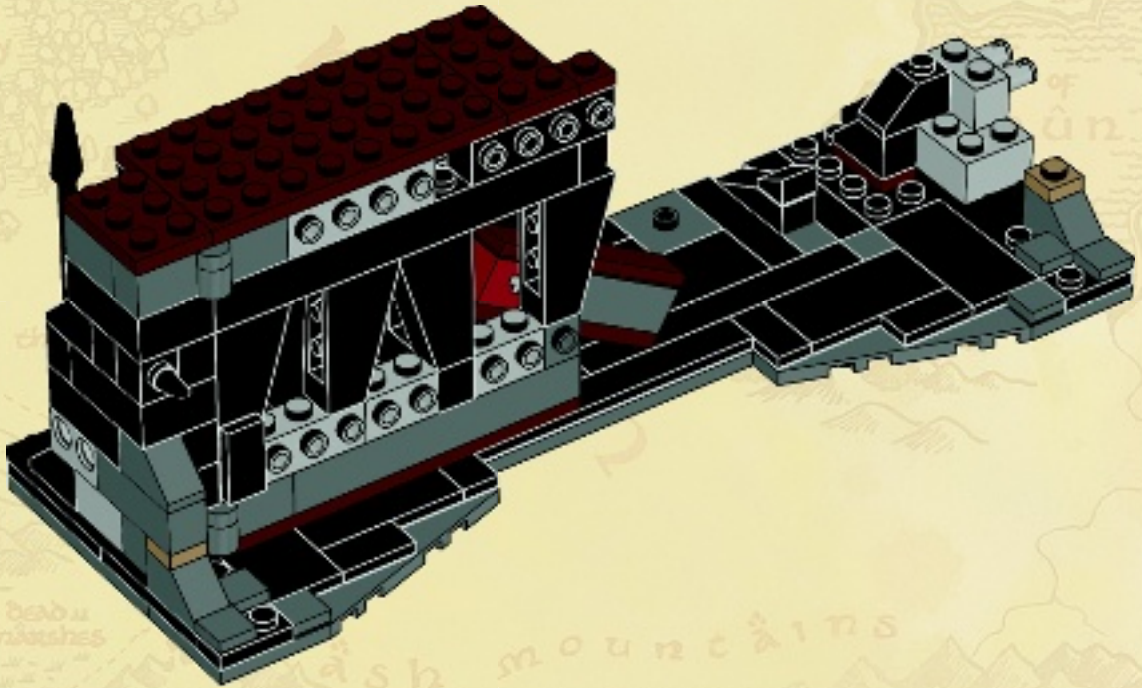



# 20

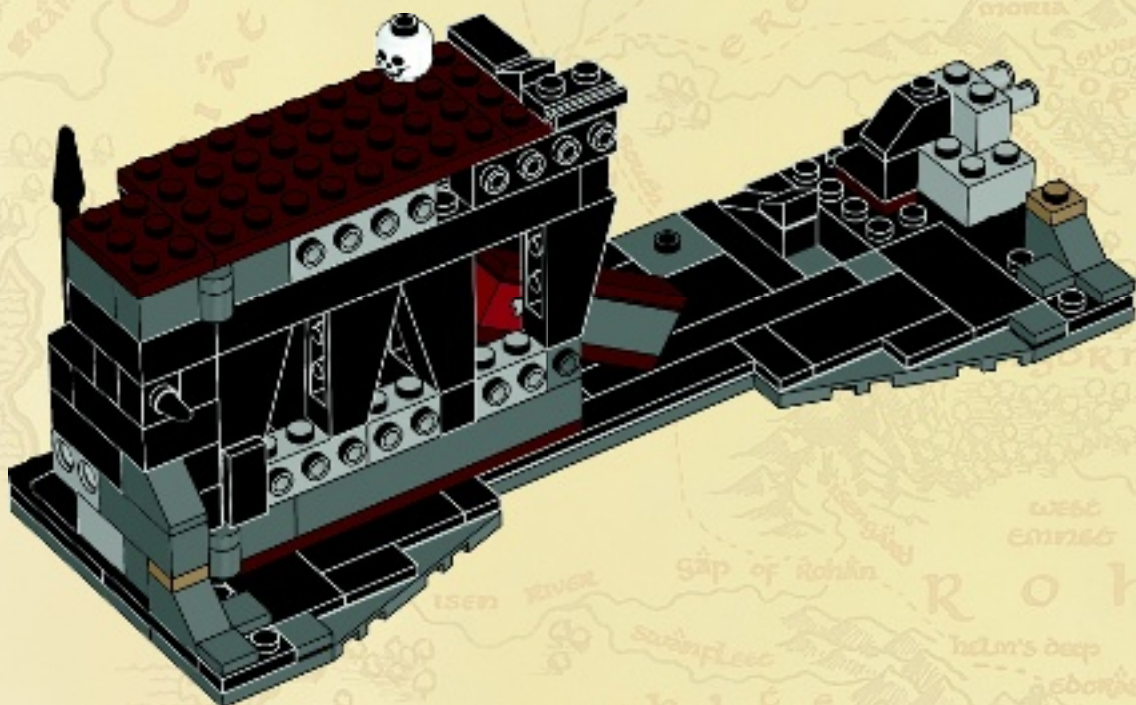

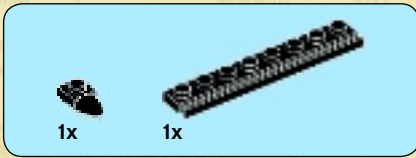

21

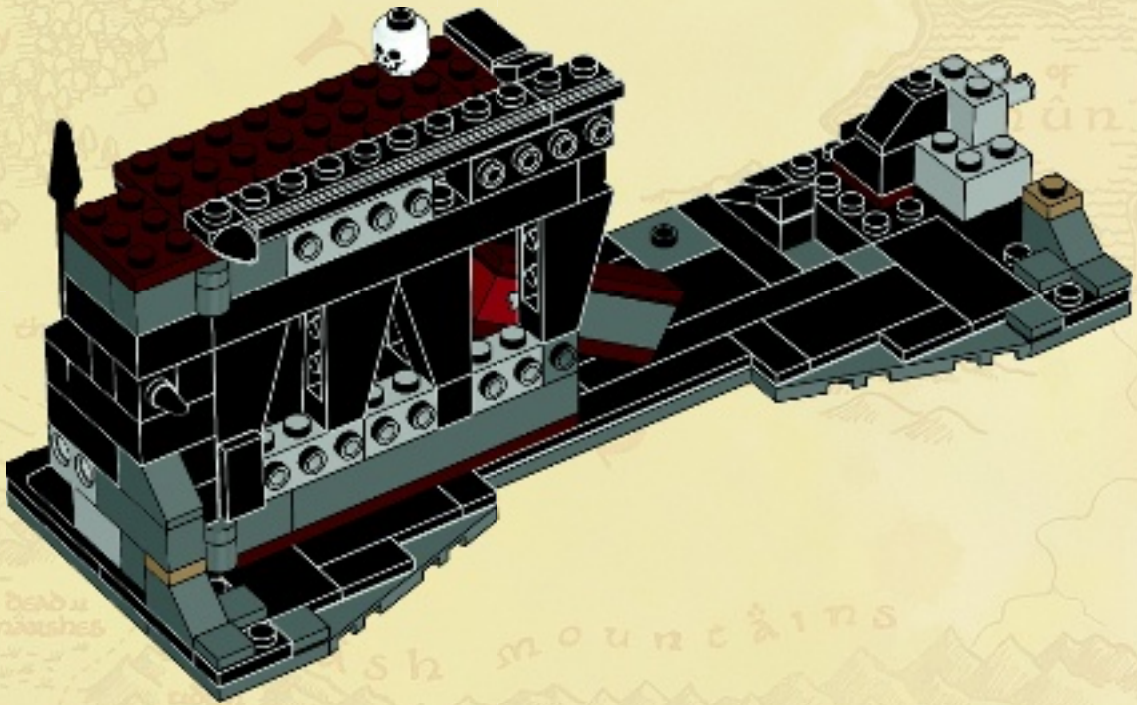



# 22

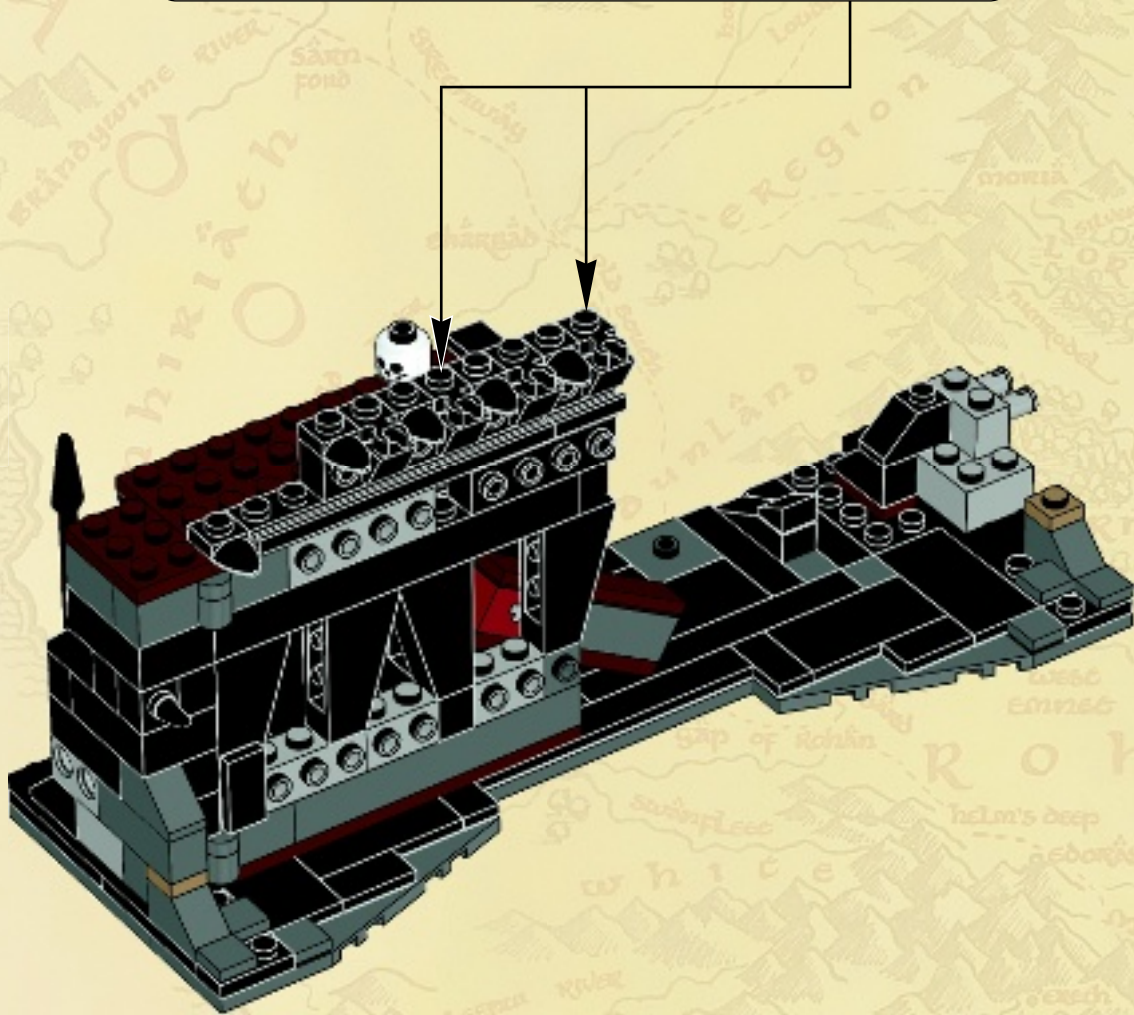
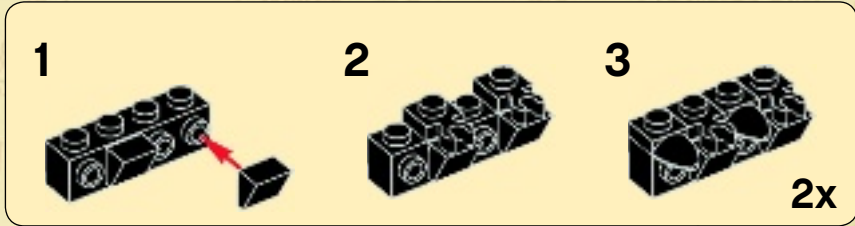



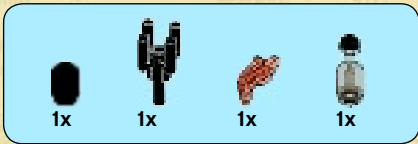

# 23

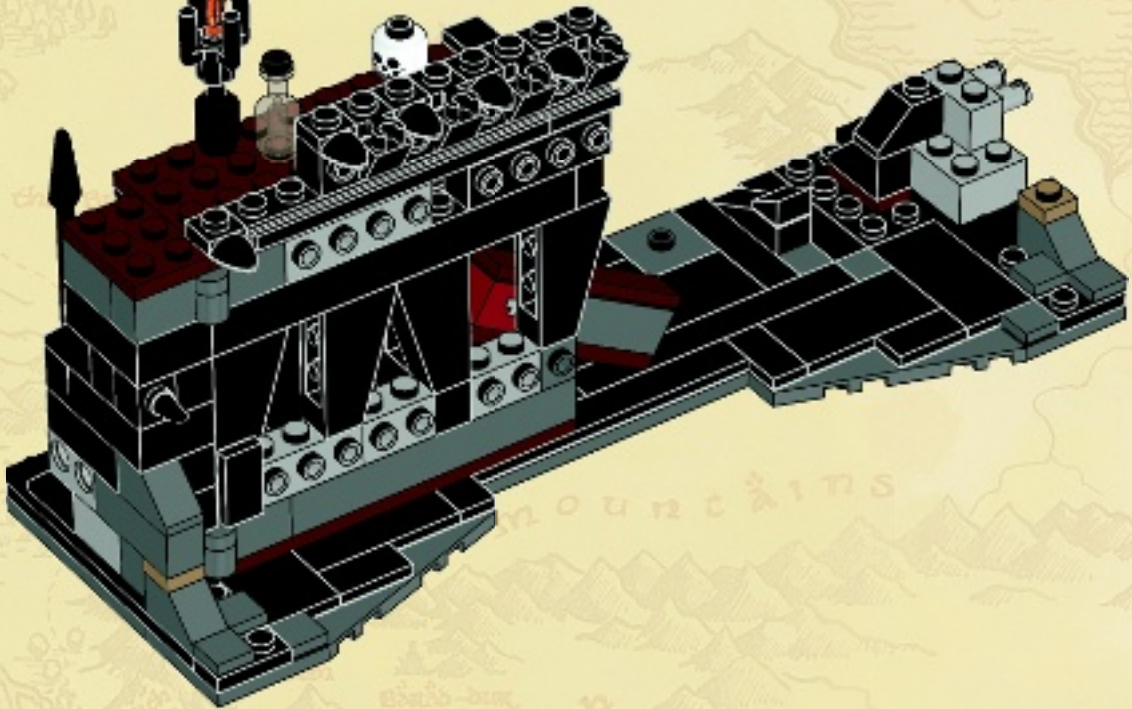
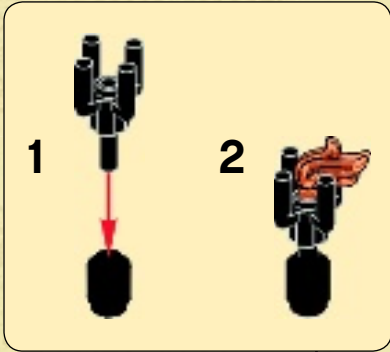

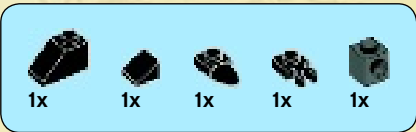

# 24

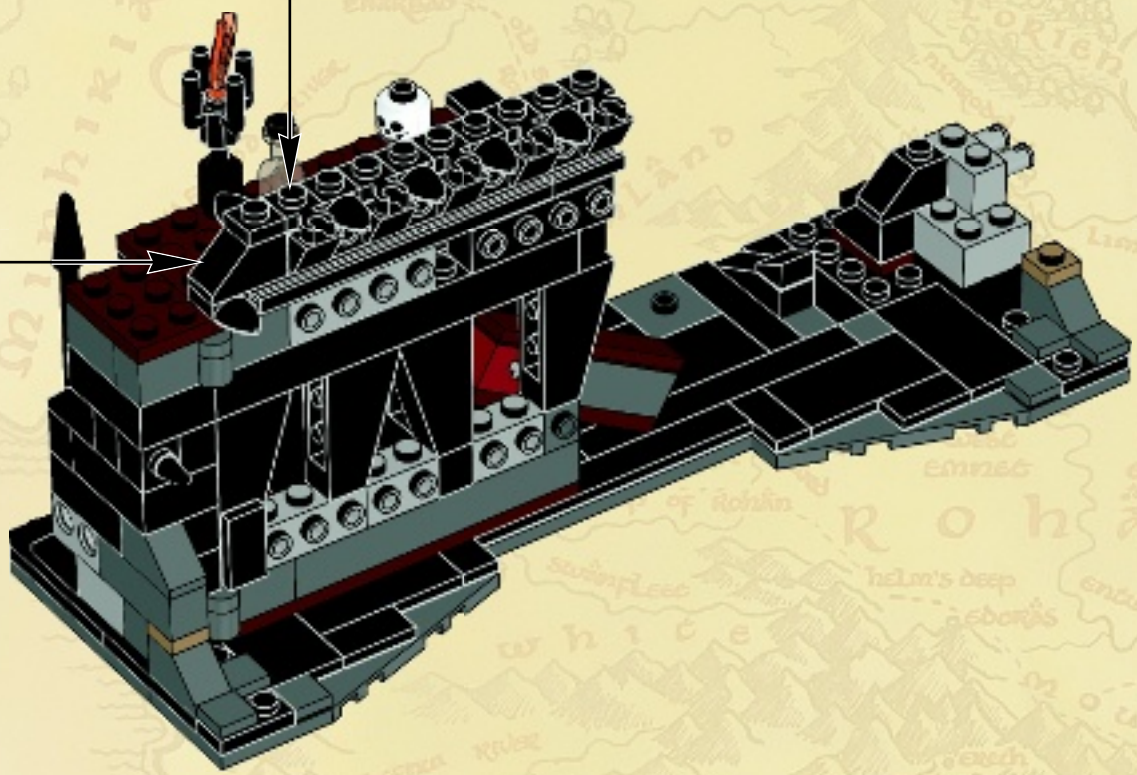
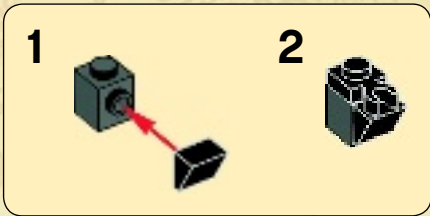



1x



2x

# 25

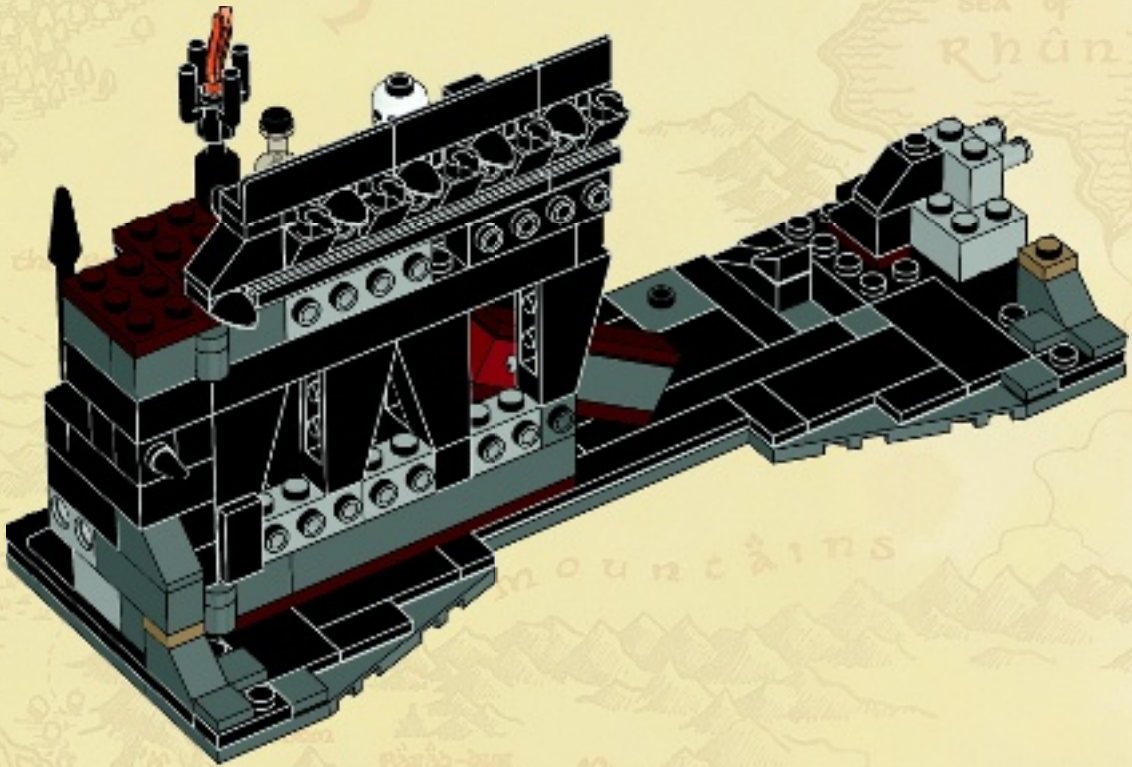



# 26

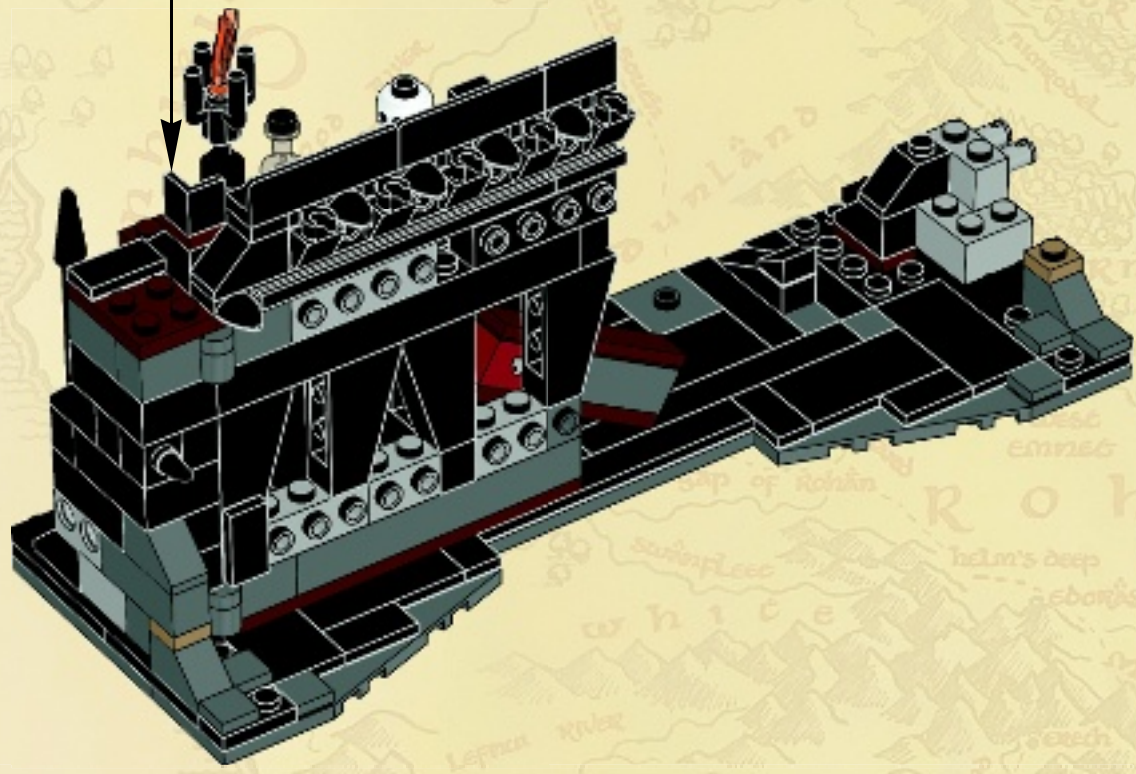
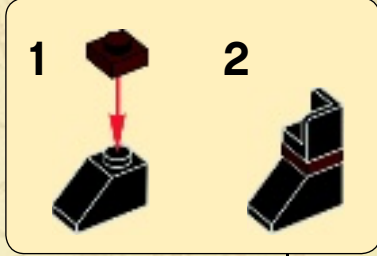



# 27

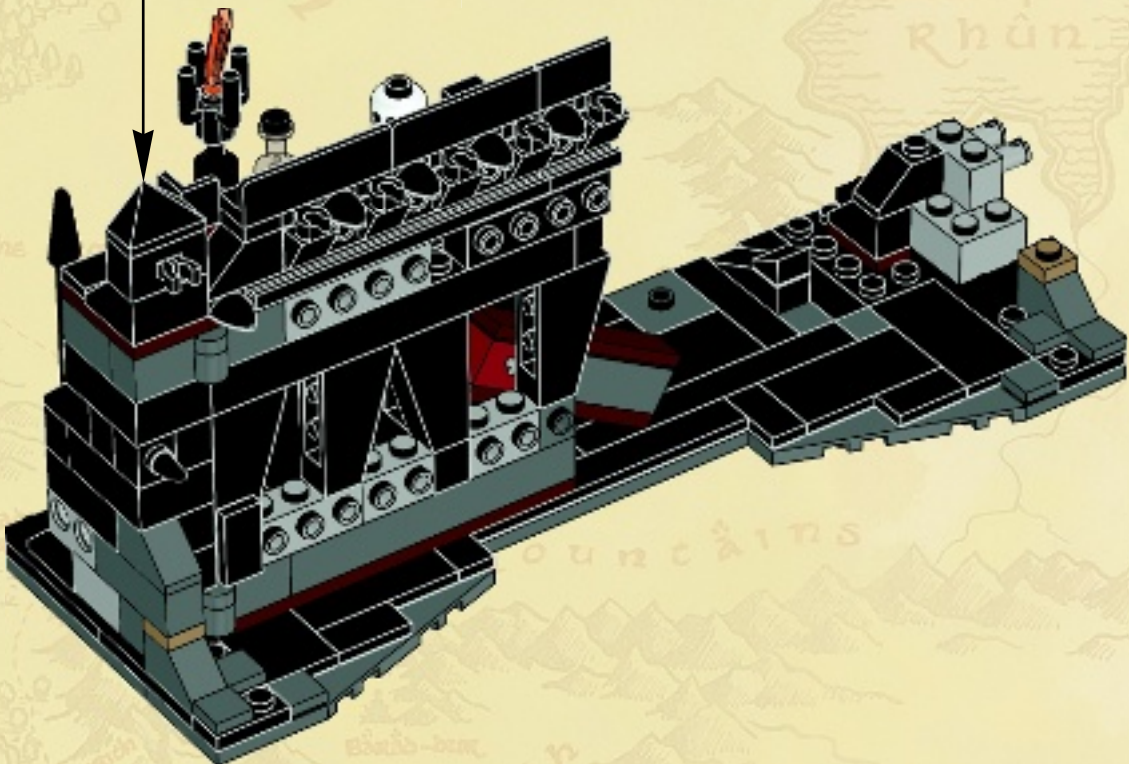
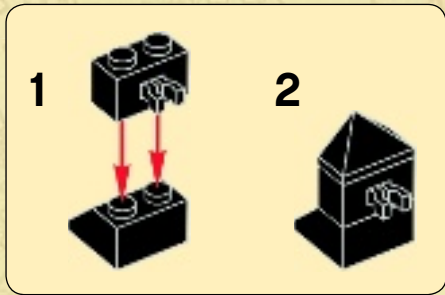



28

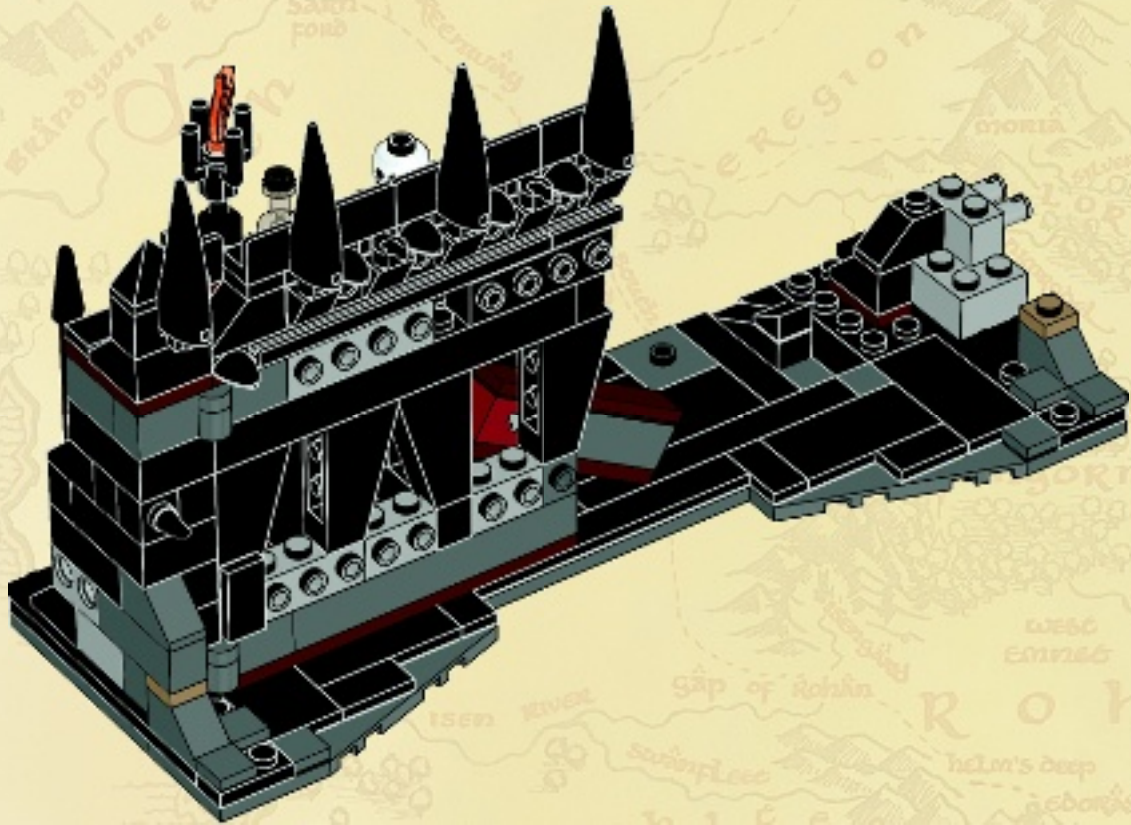

4

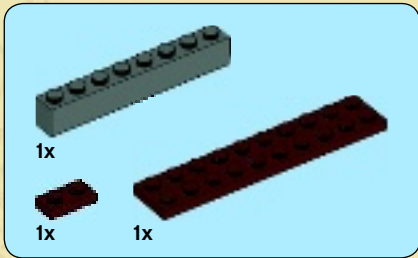
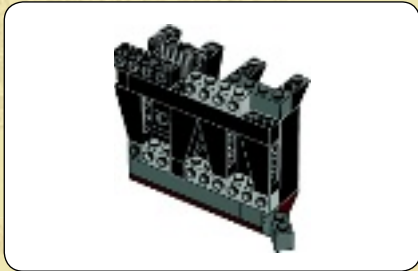

1

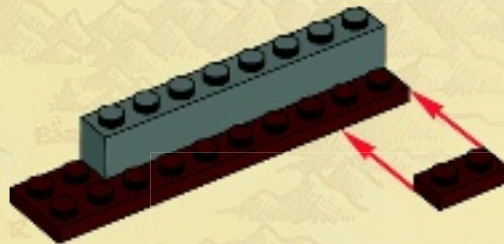



2

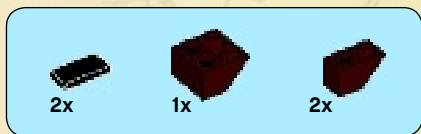
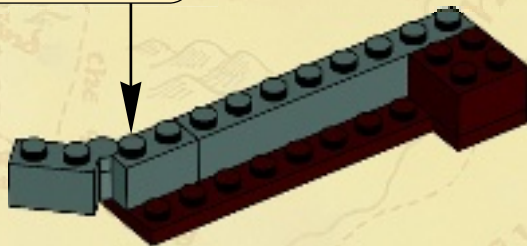
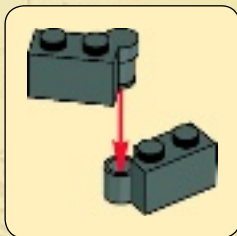

3

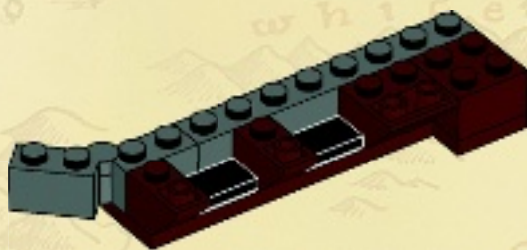



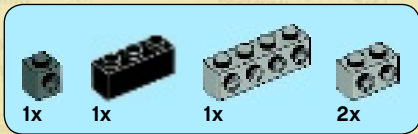

4

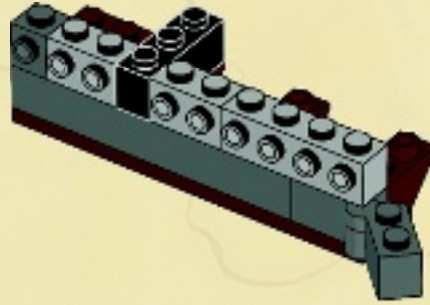
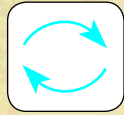

5

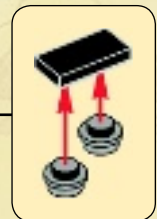
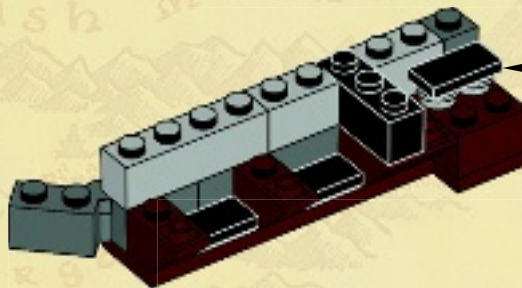
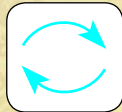



6

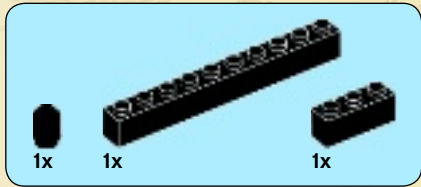
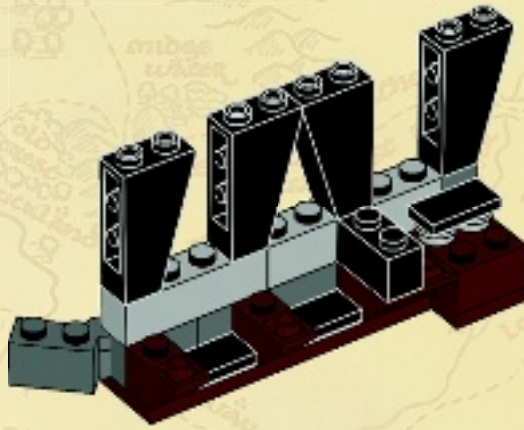

7

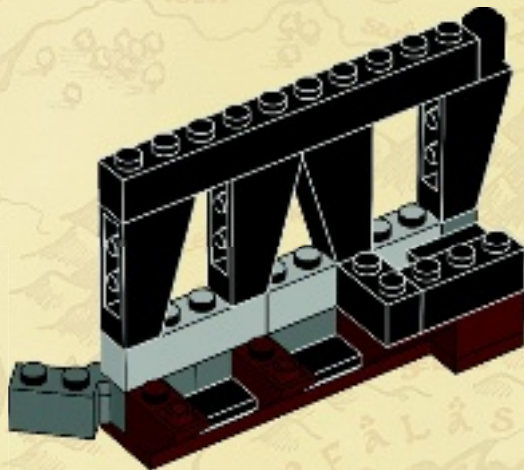

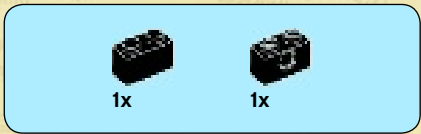

8

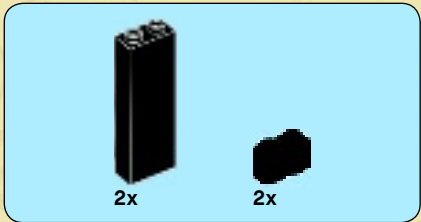
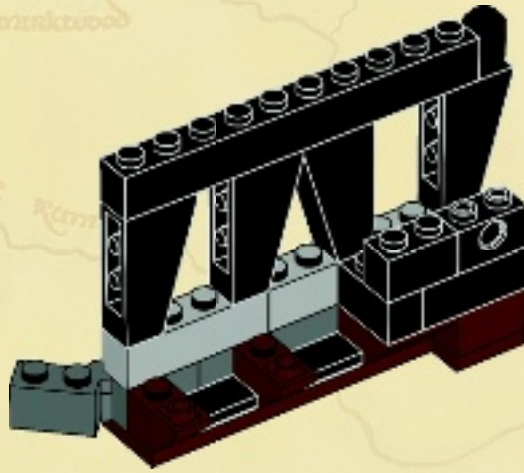

9

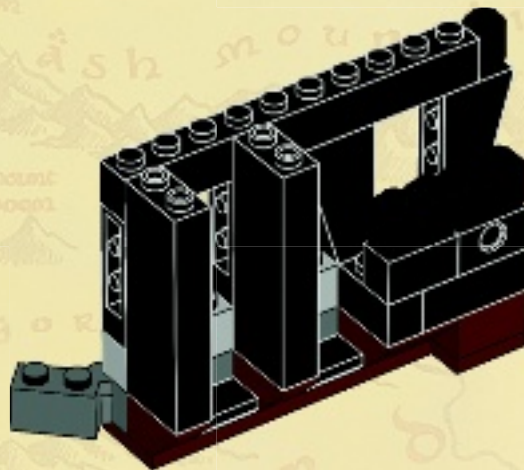

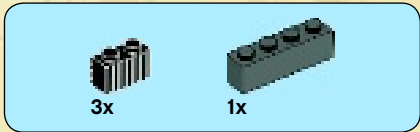

10

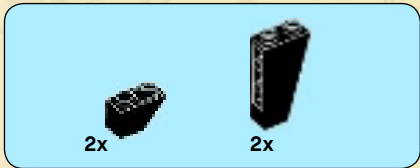
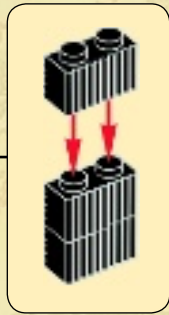
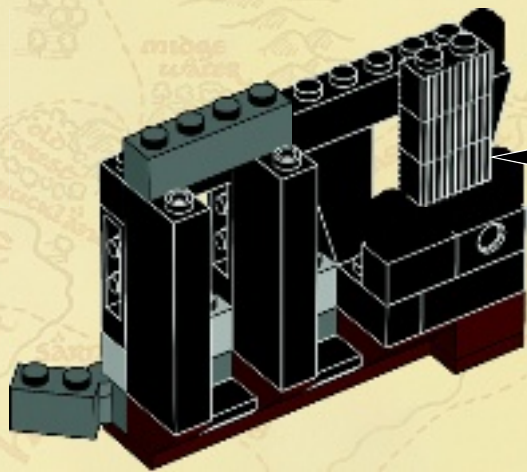

11

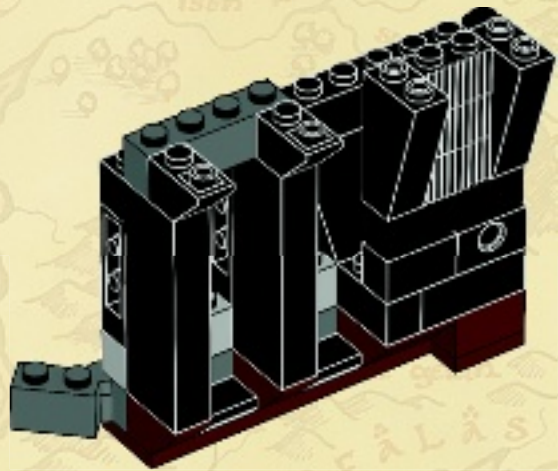



12

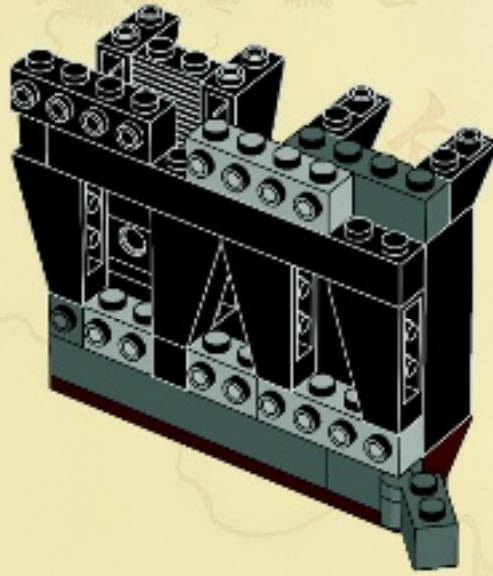
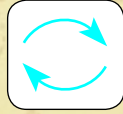

29

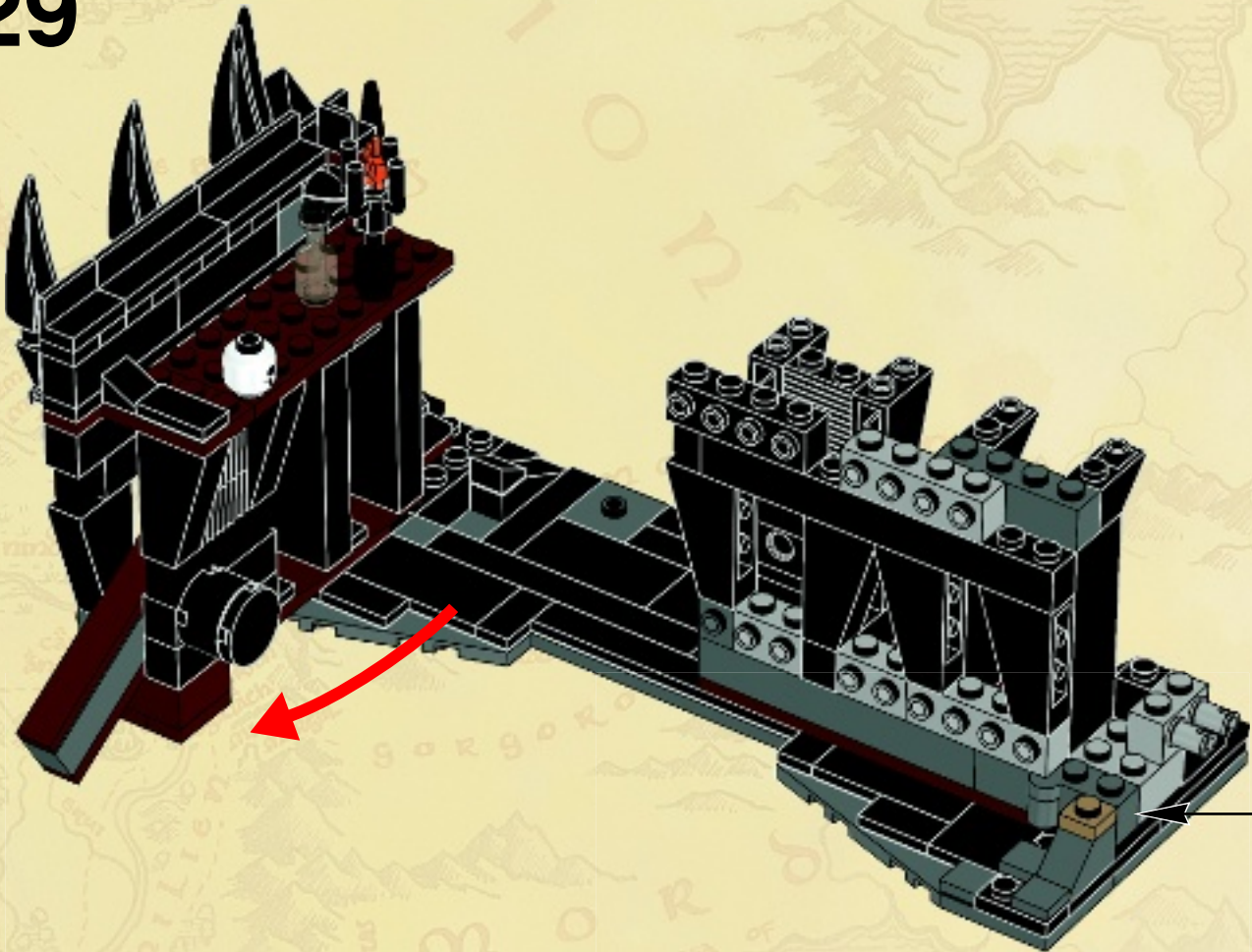



# 30

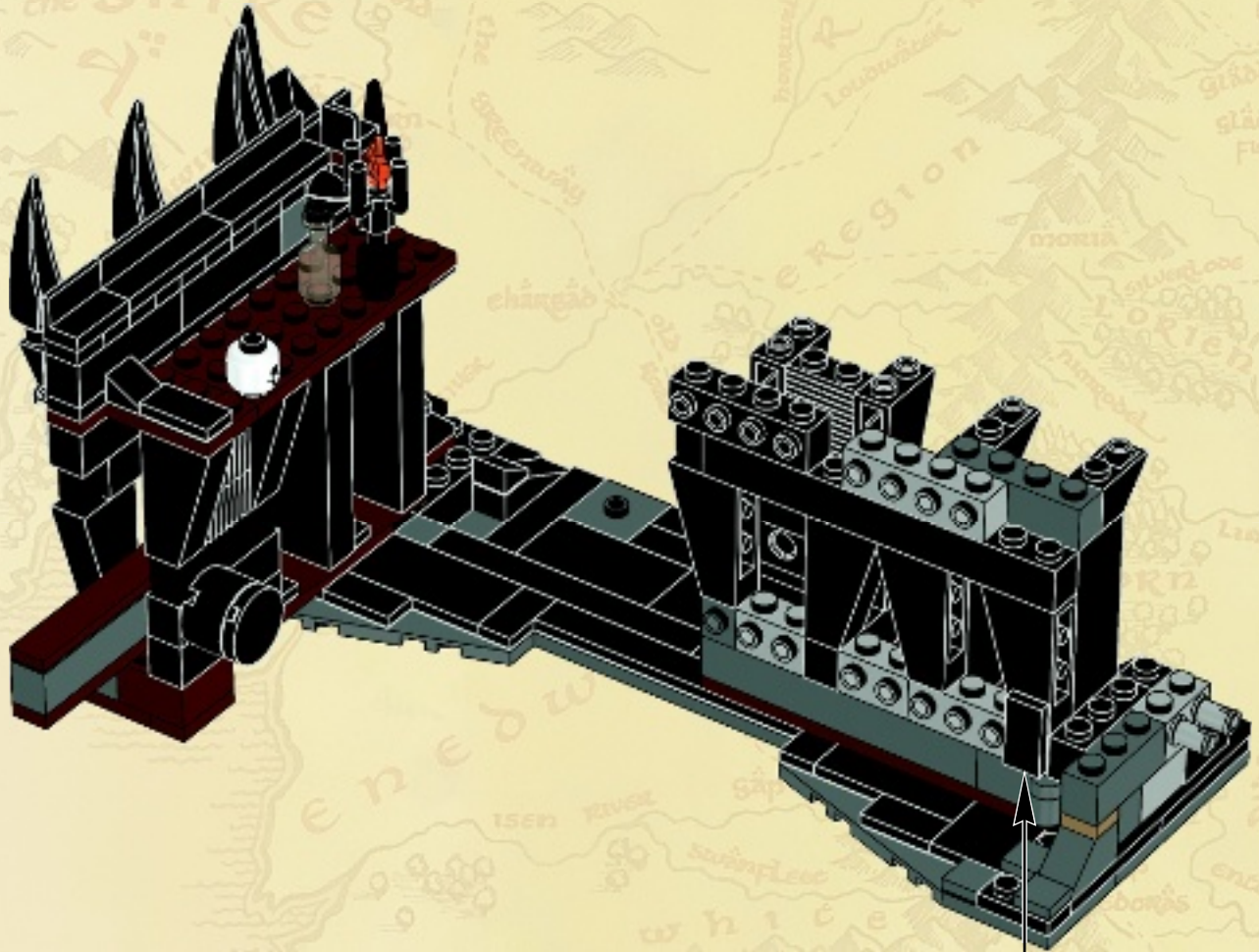



# 31

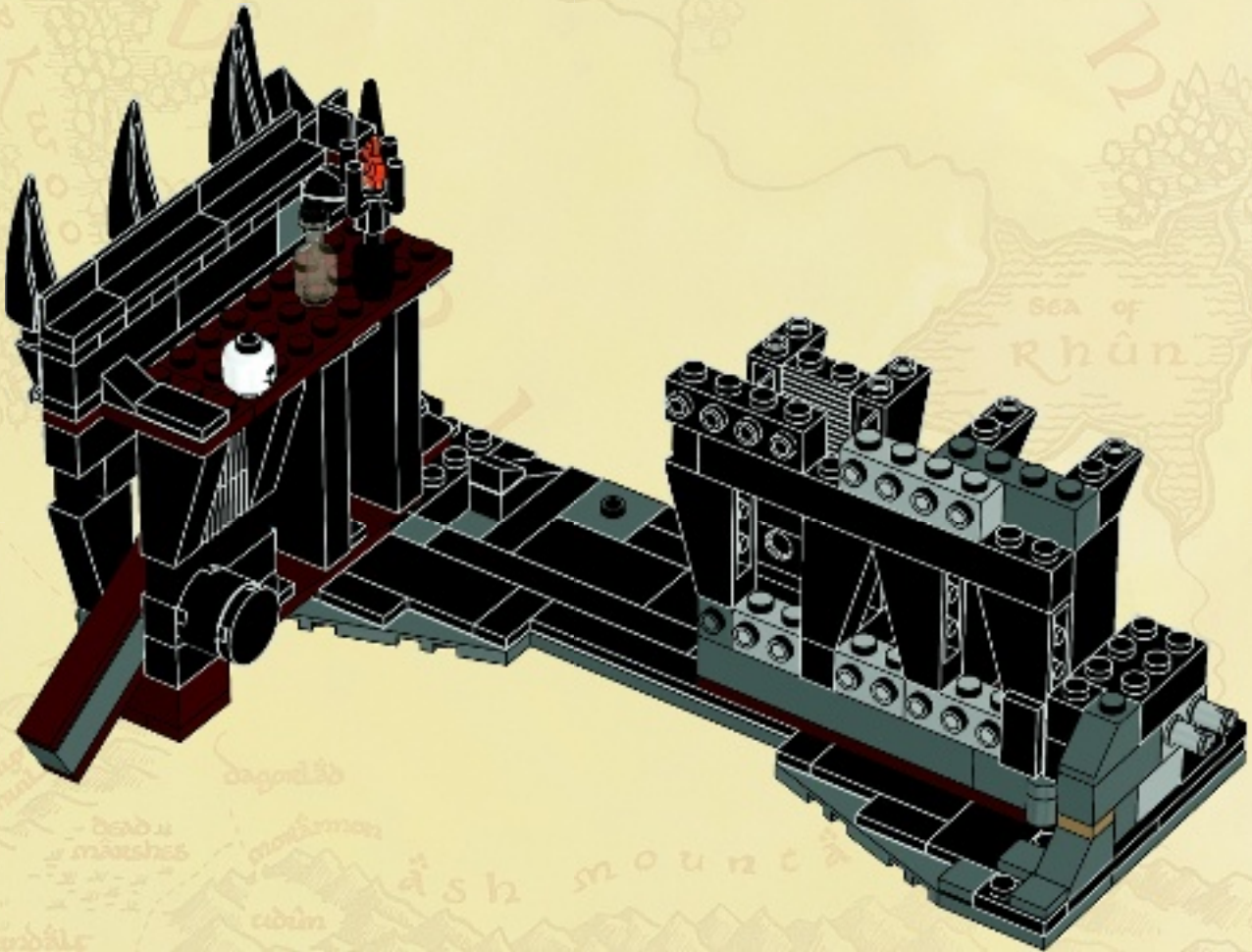



# 32

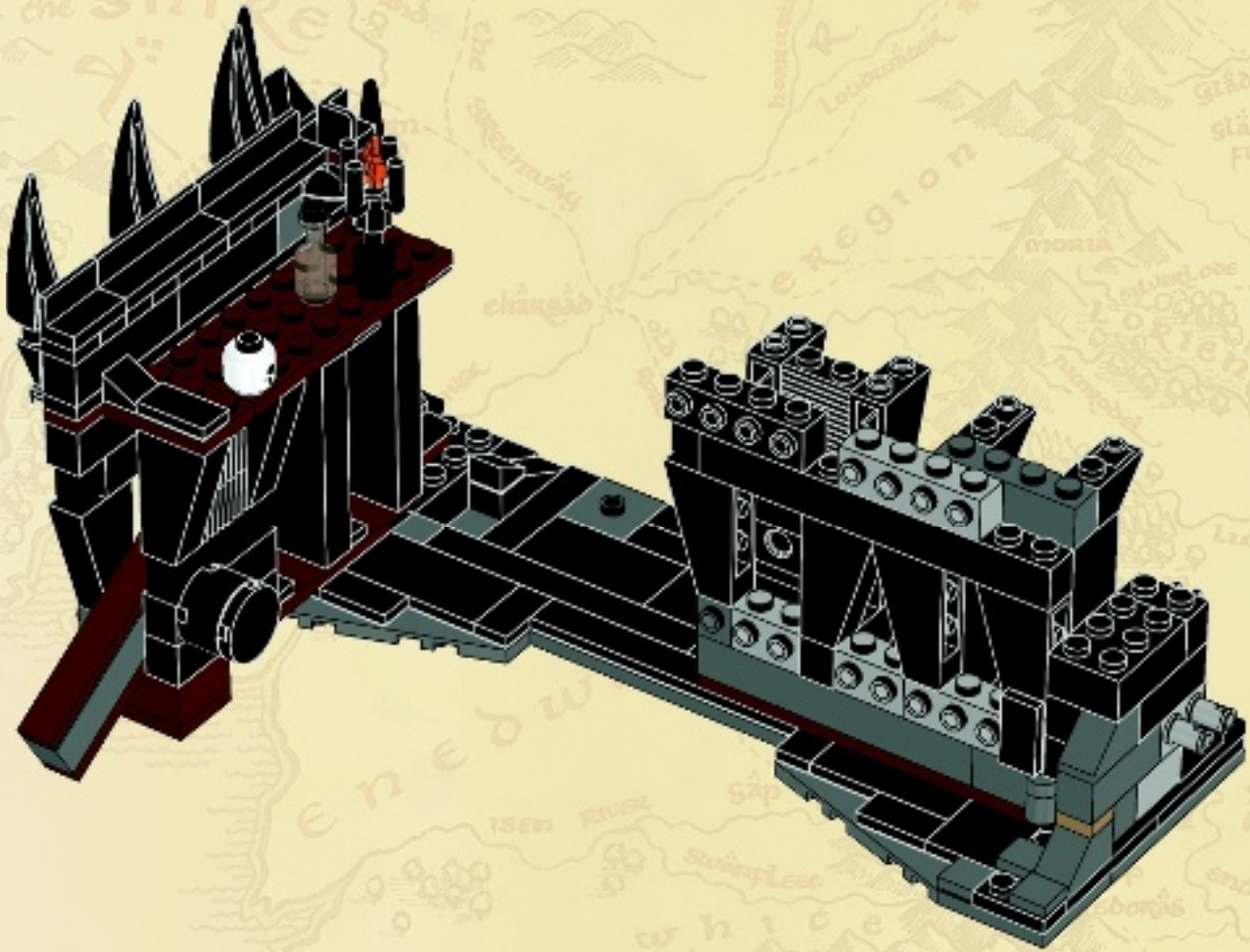





# 33

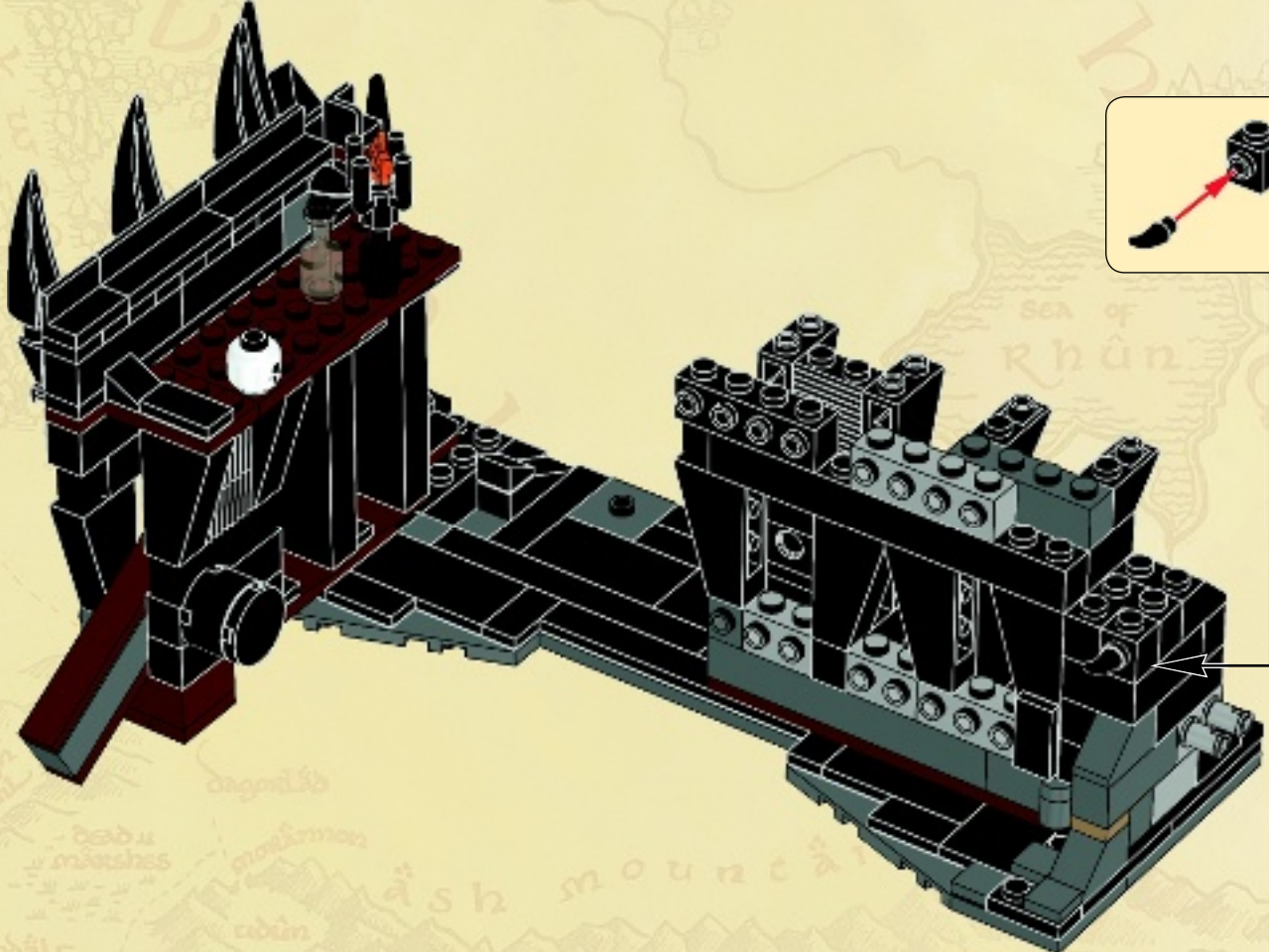

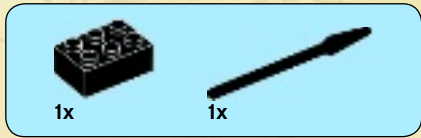

34

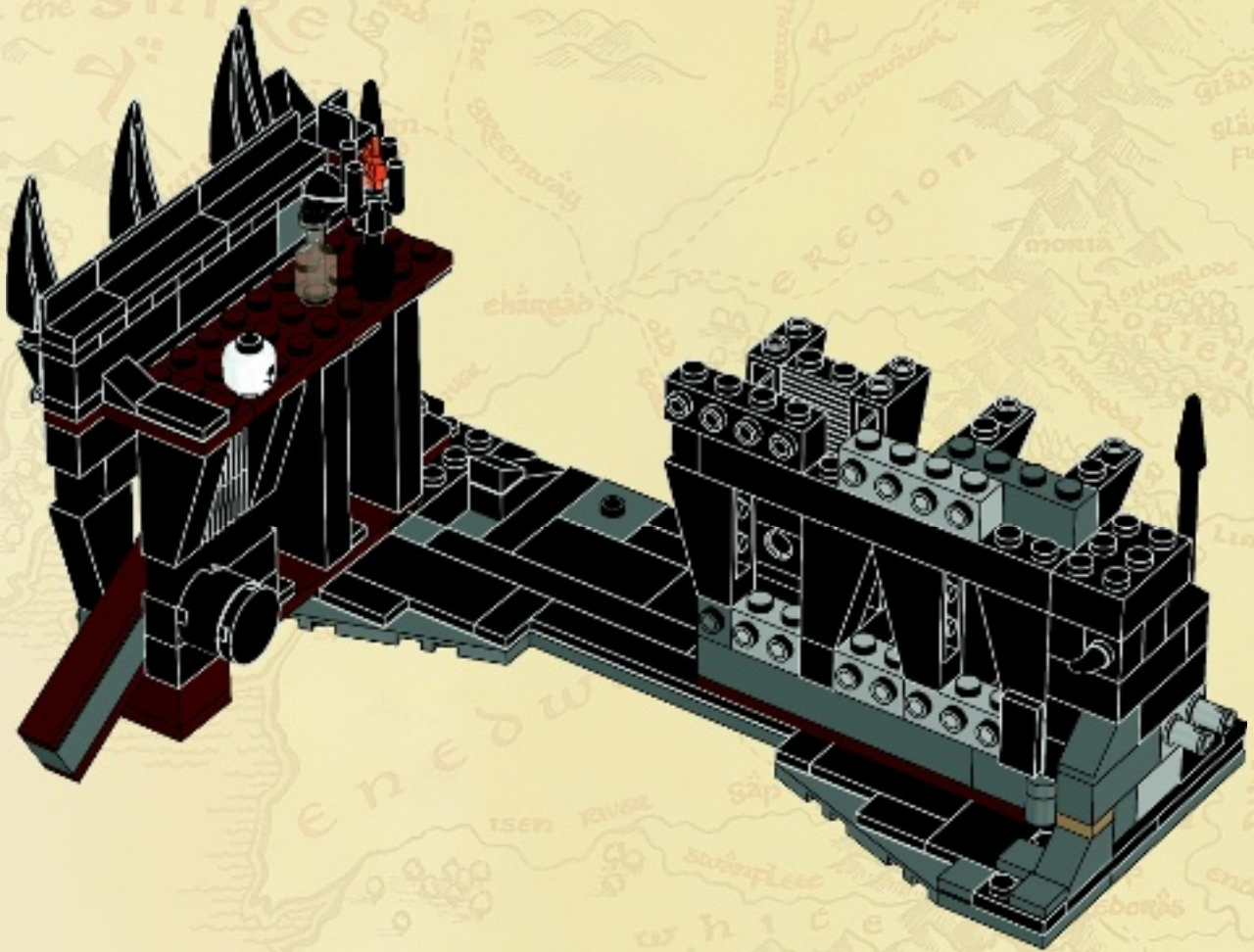



# 35

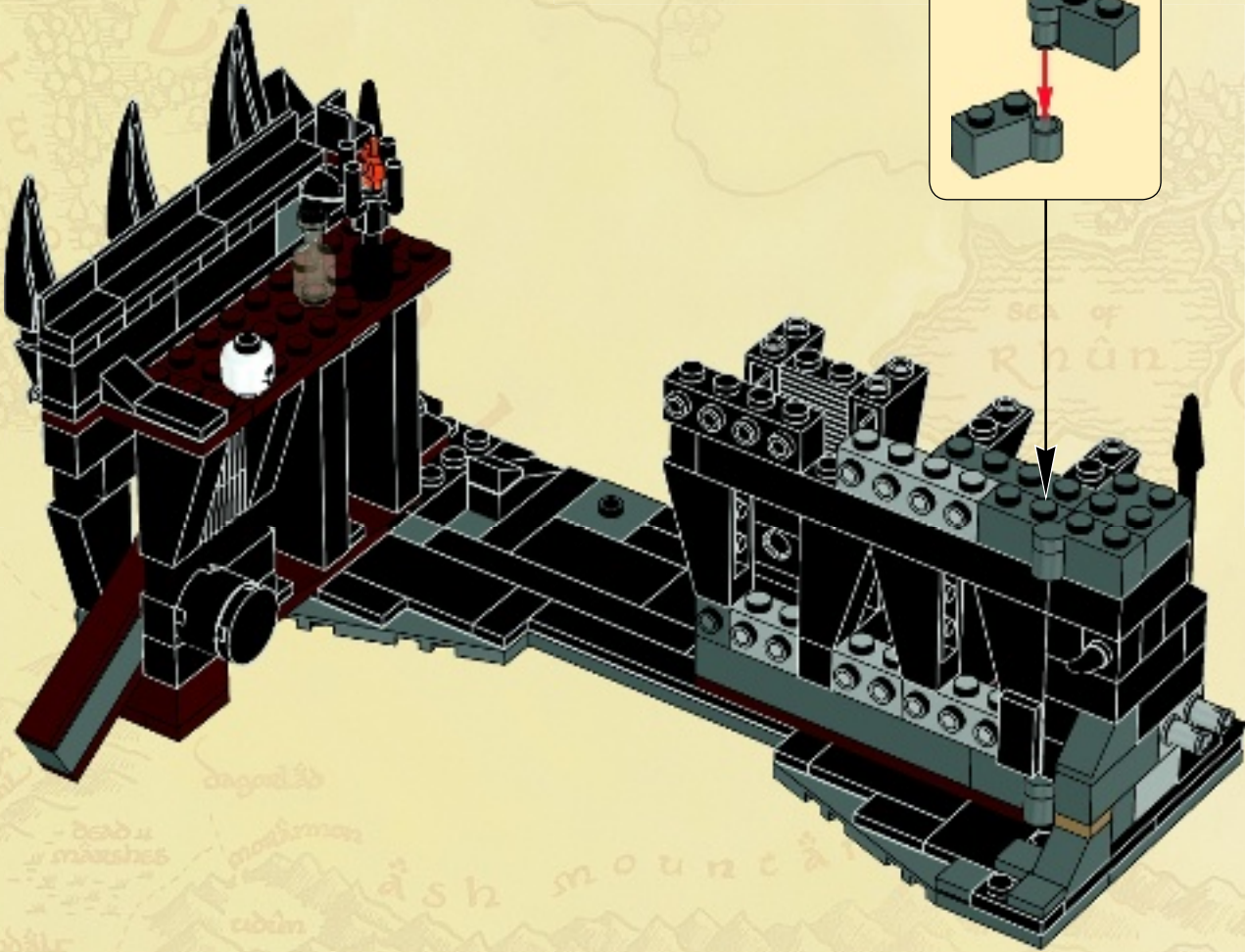

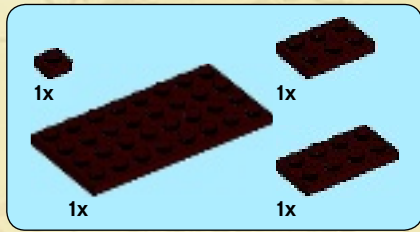

36

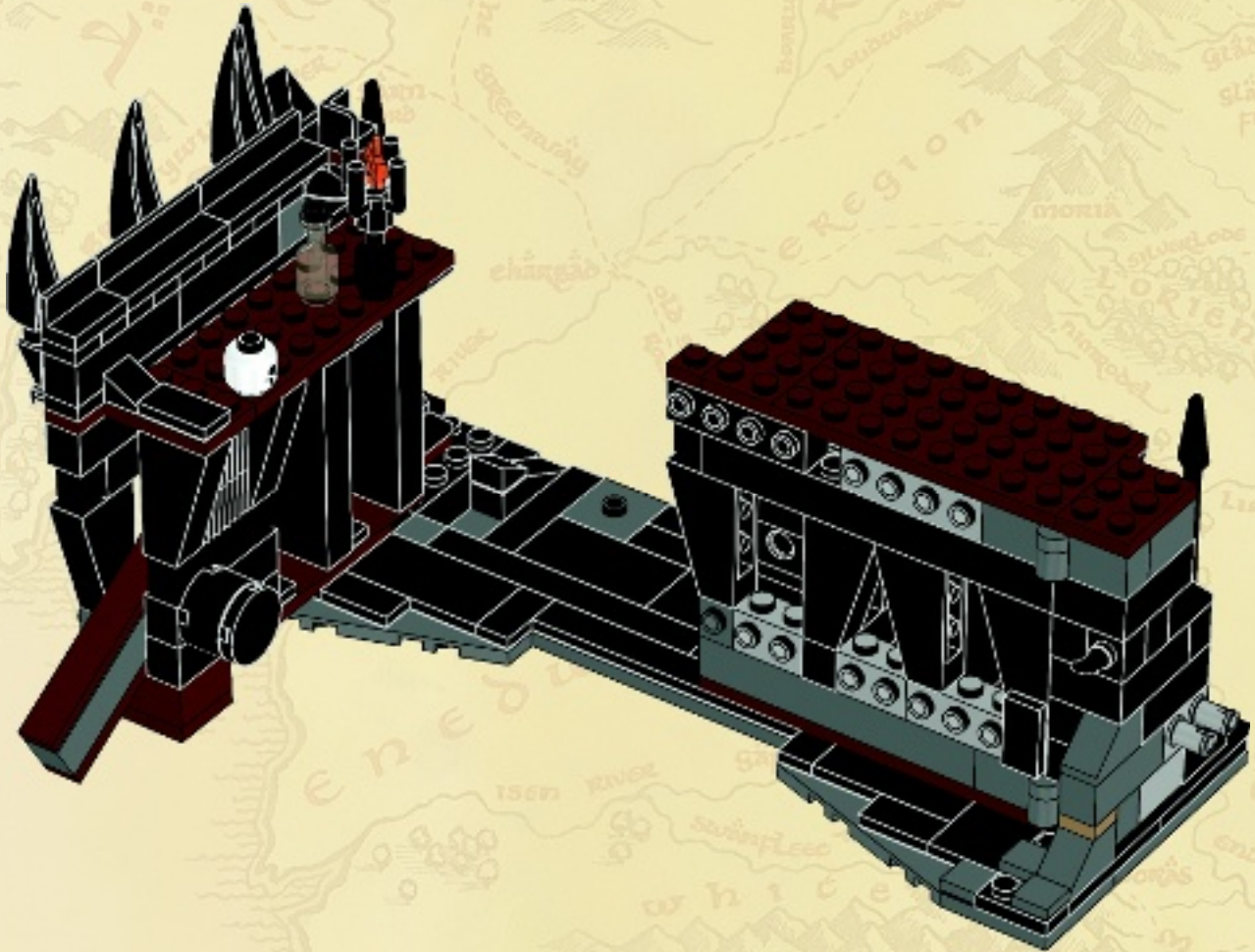



1x



1x



1x

# 37

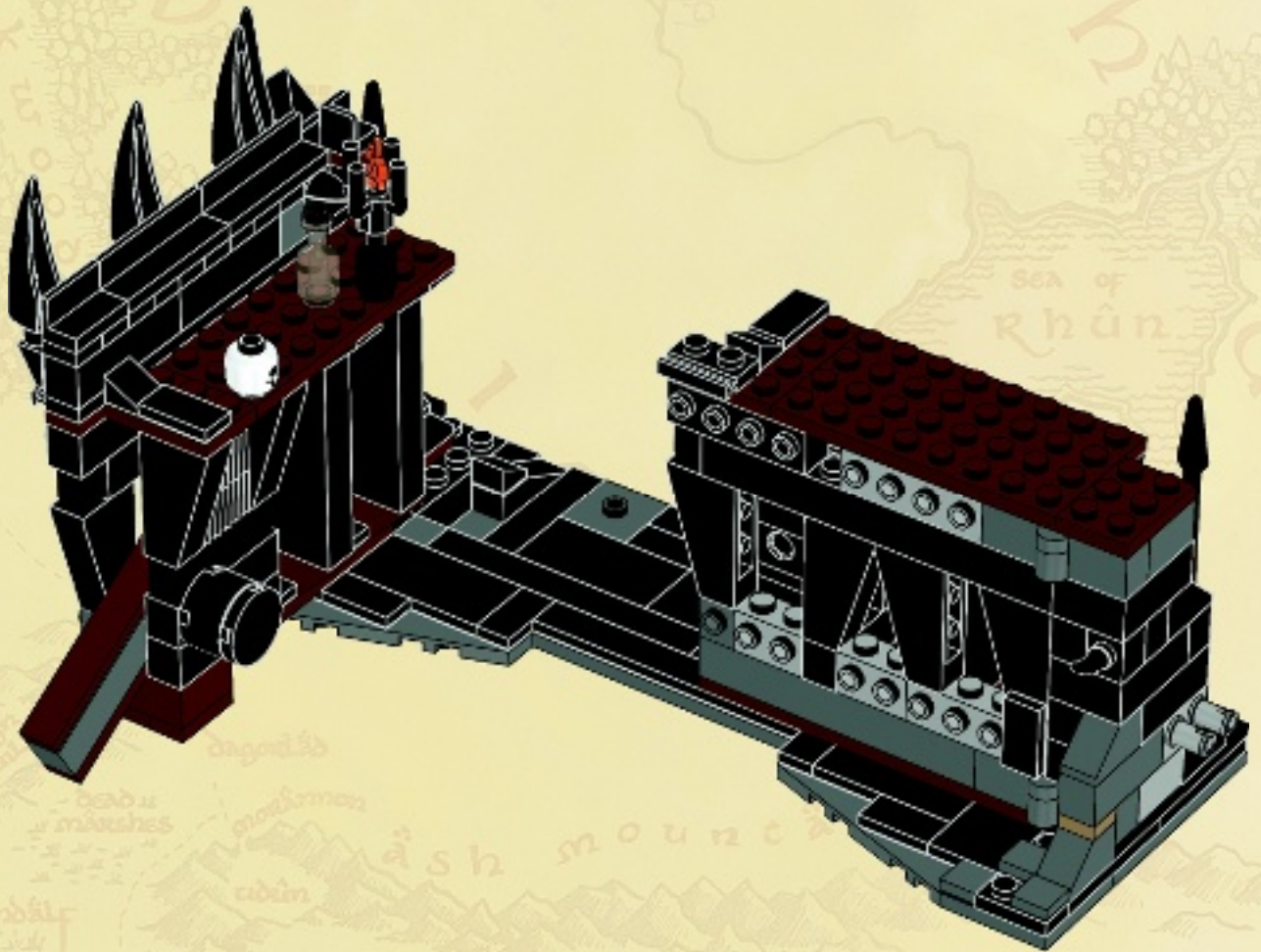

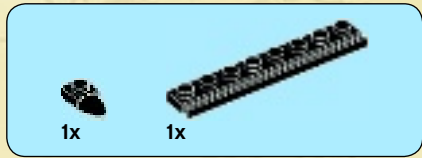

38

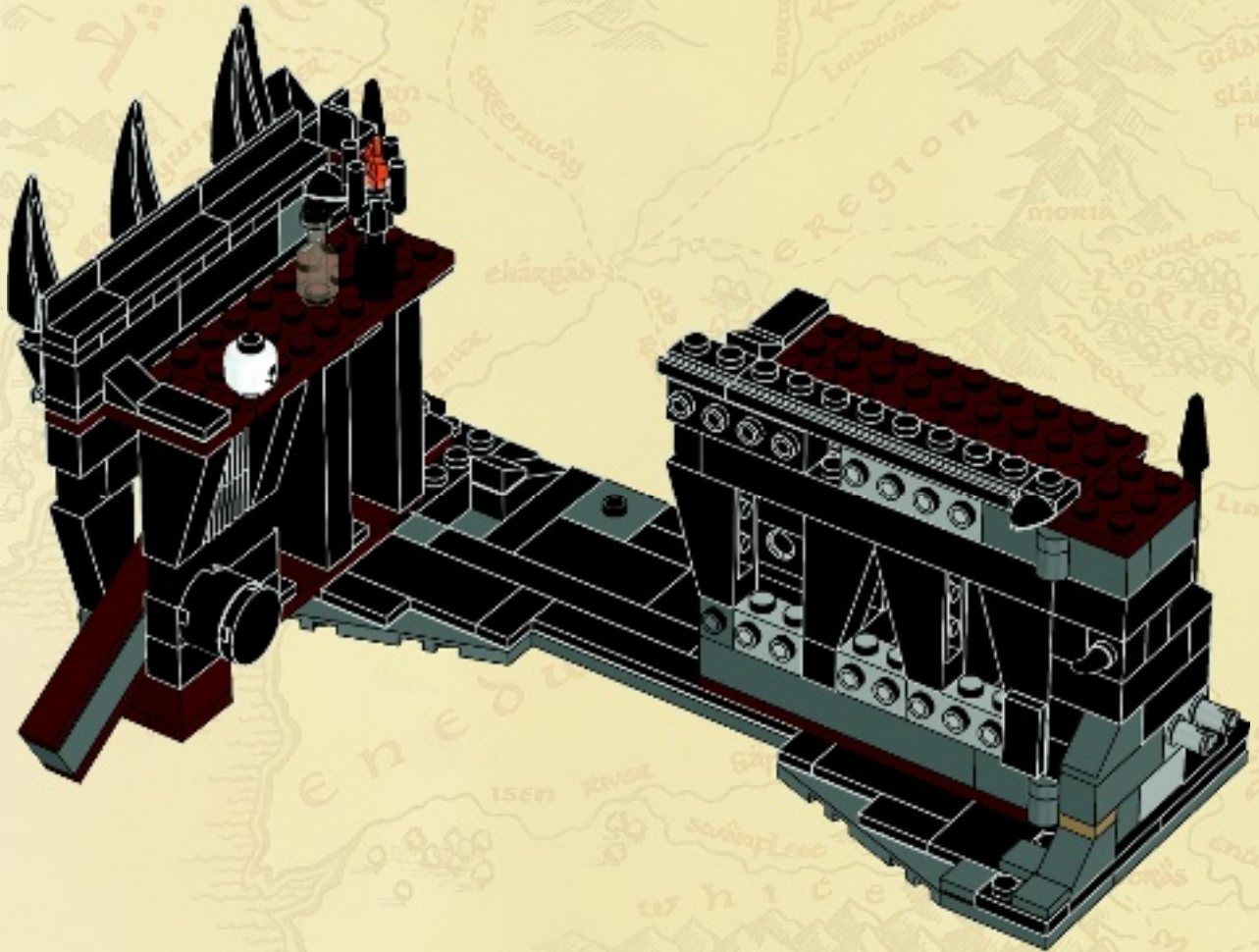

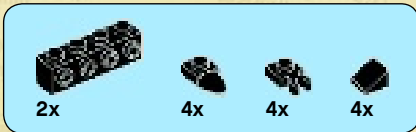

# 39

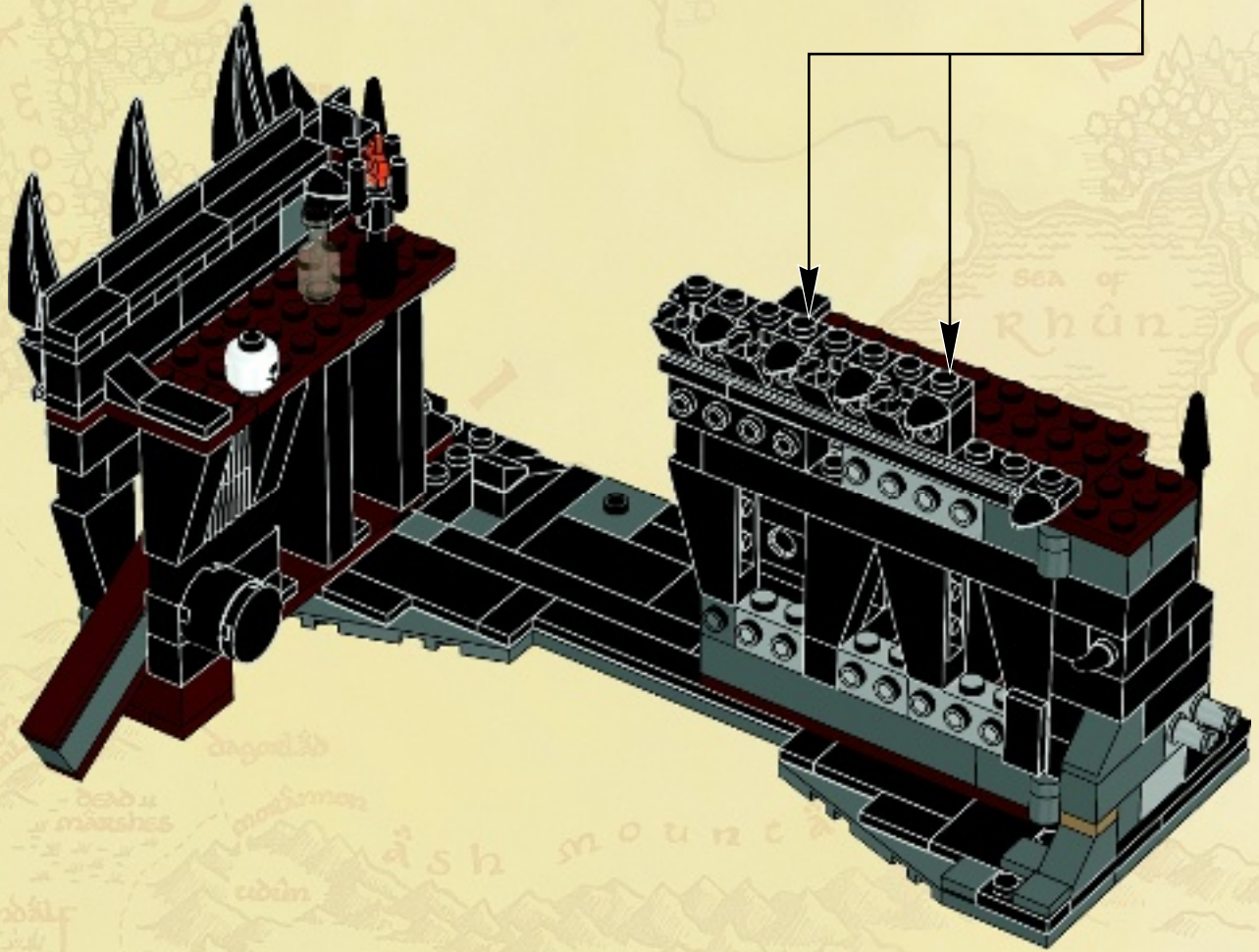
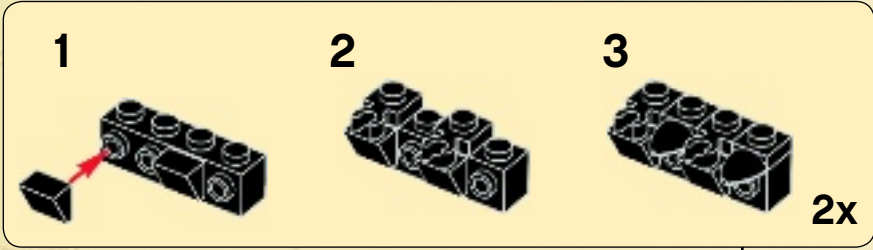

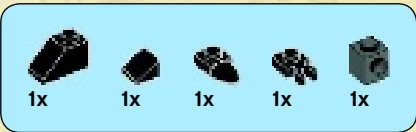

# 40

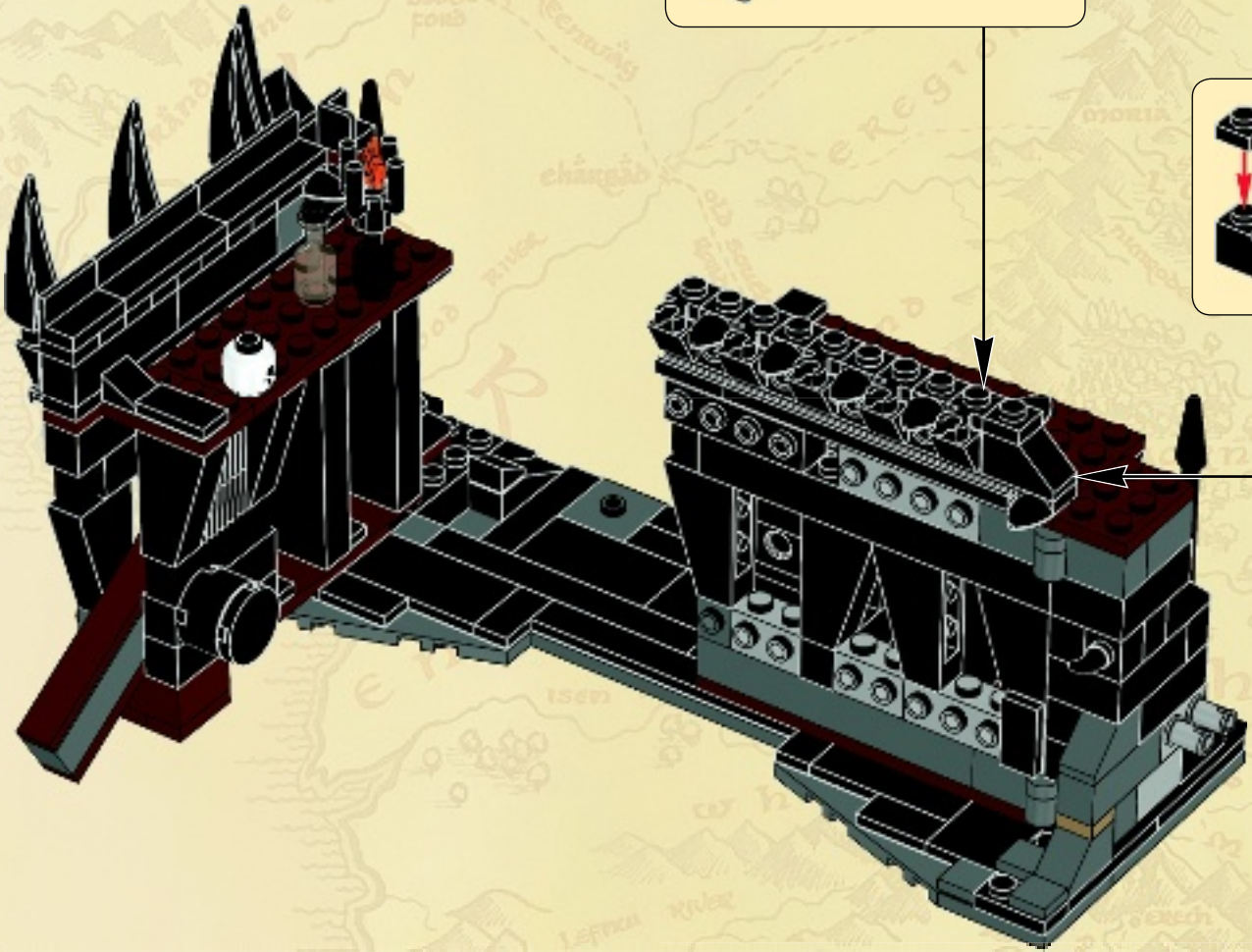
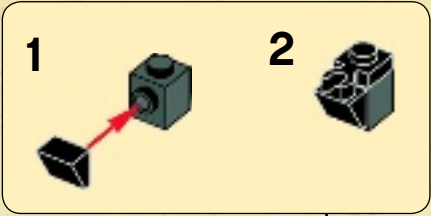



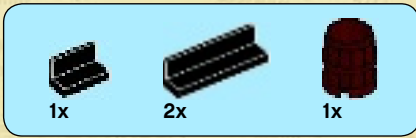

41

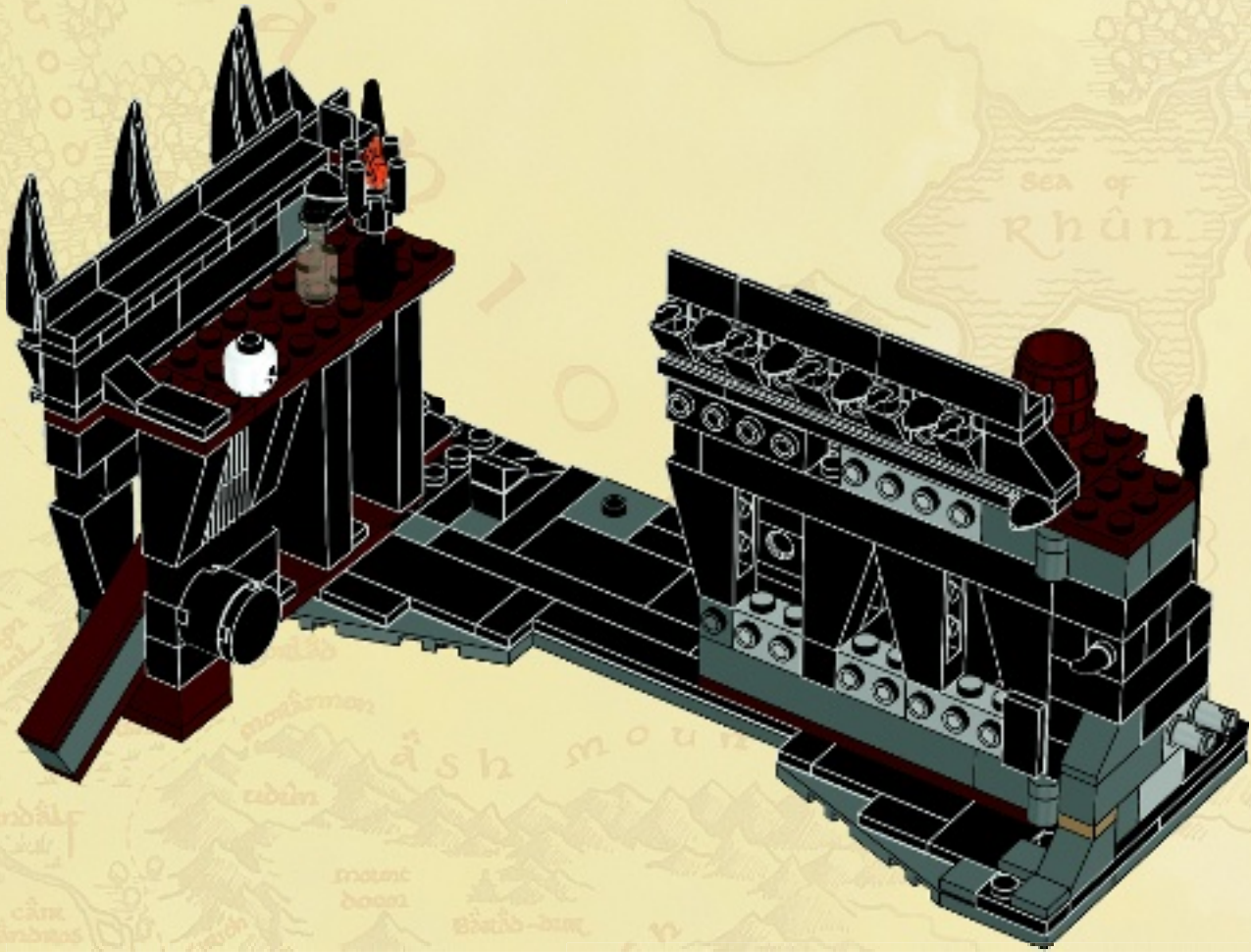



# 42

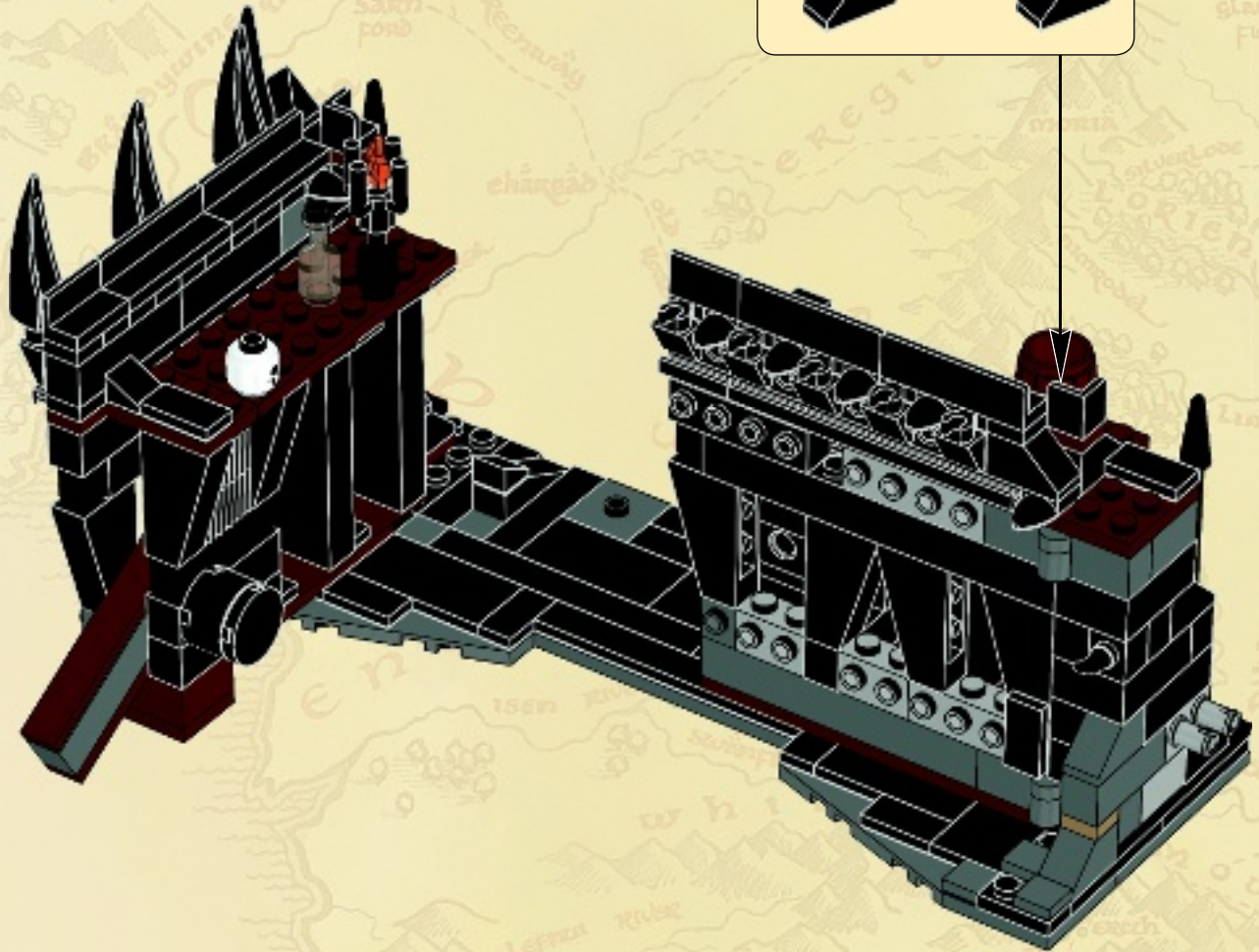
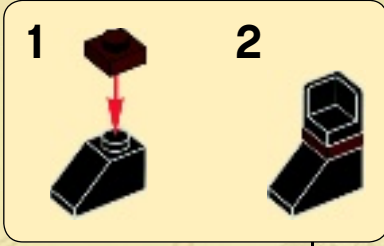



# 43

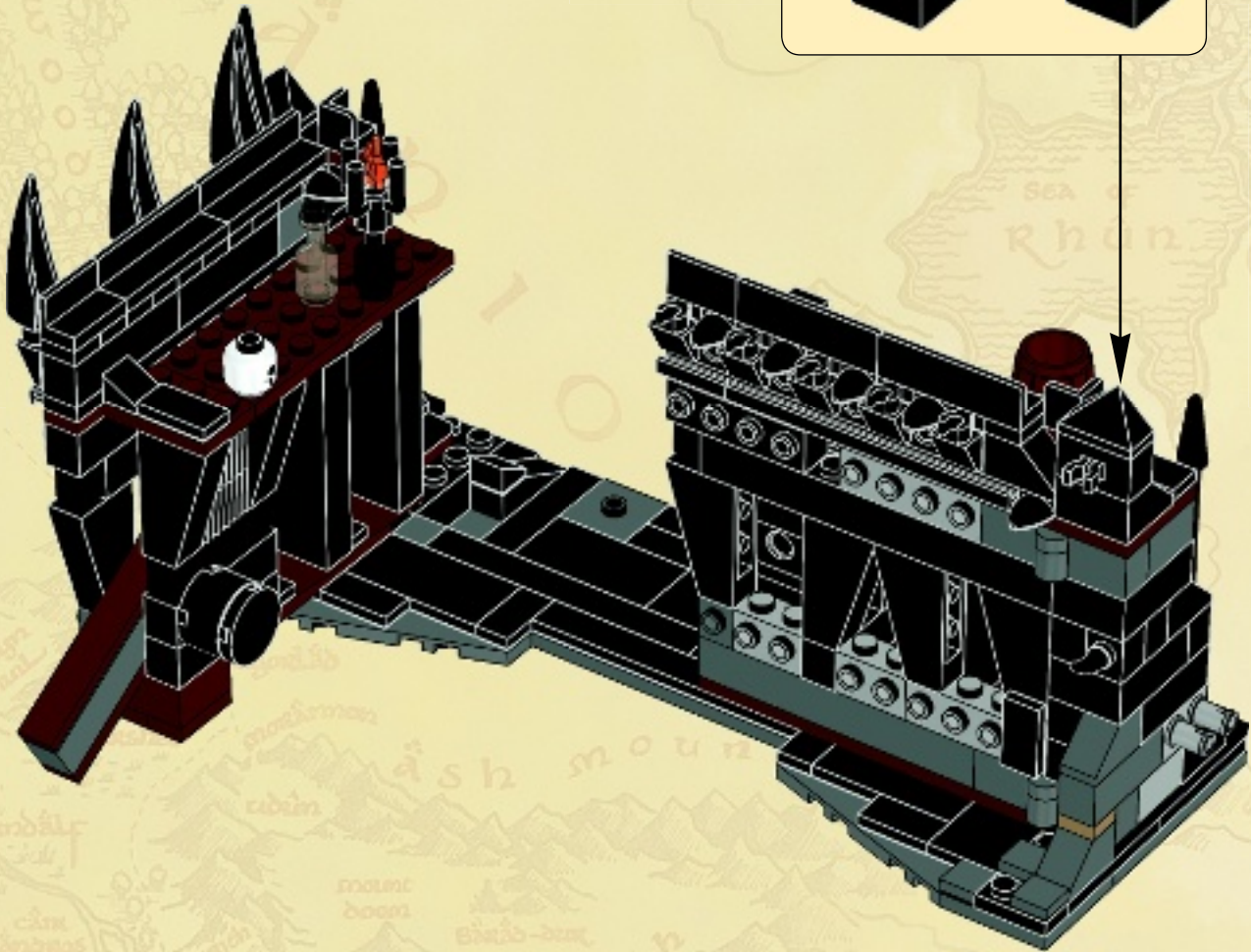
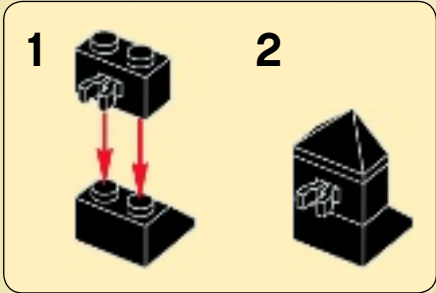



44

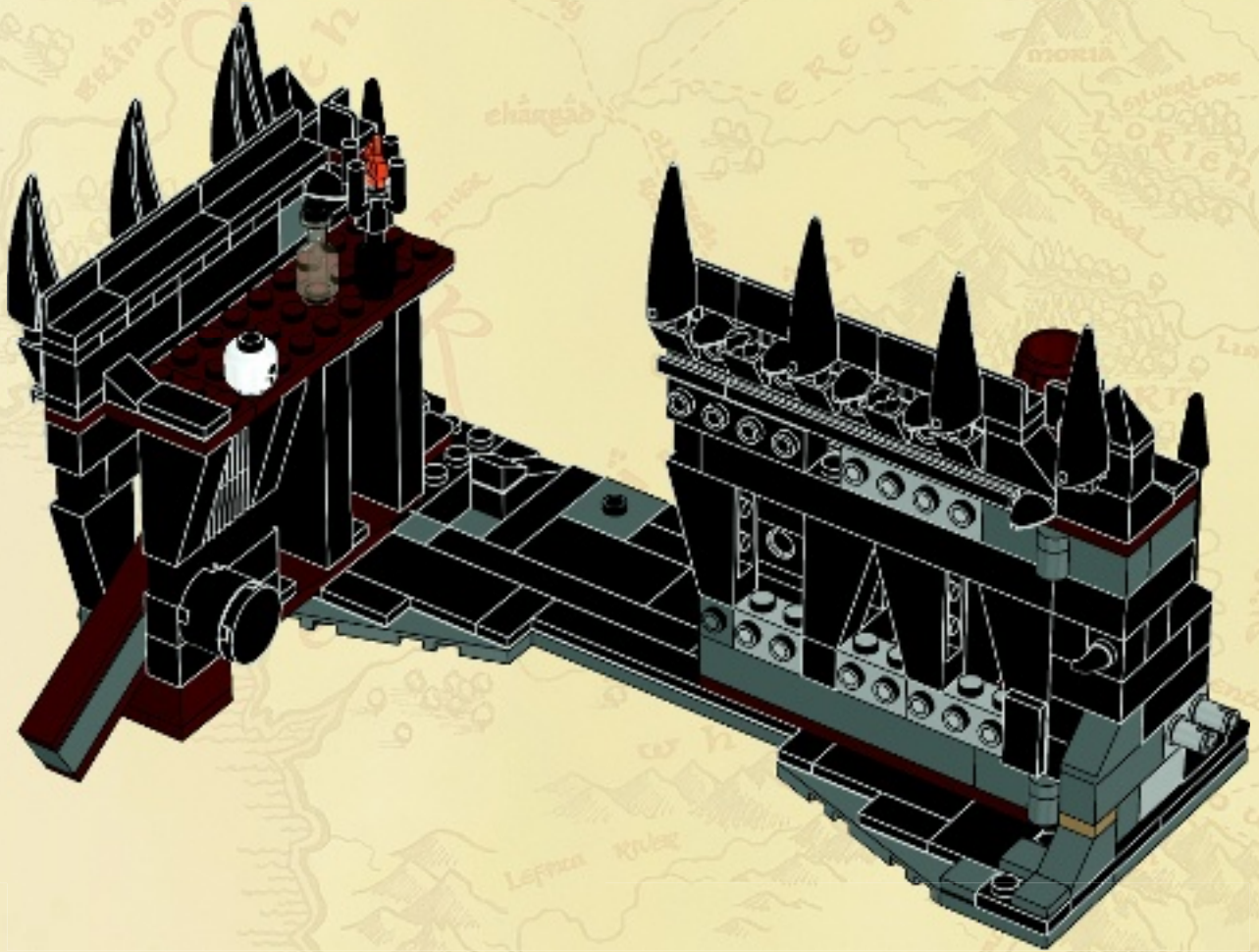

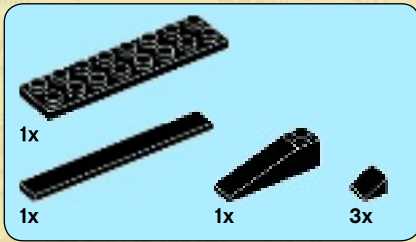

# 45

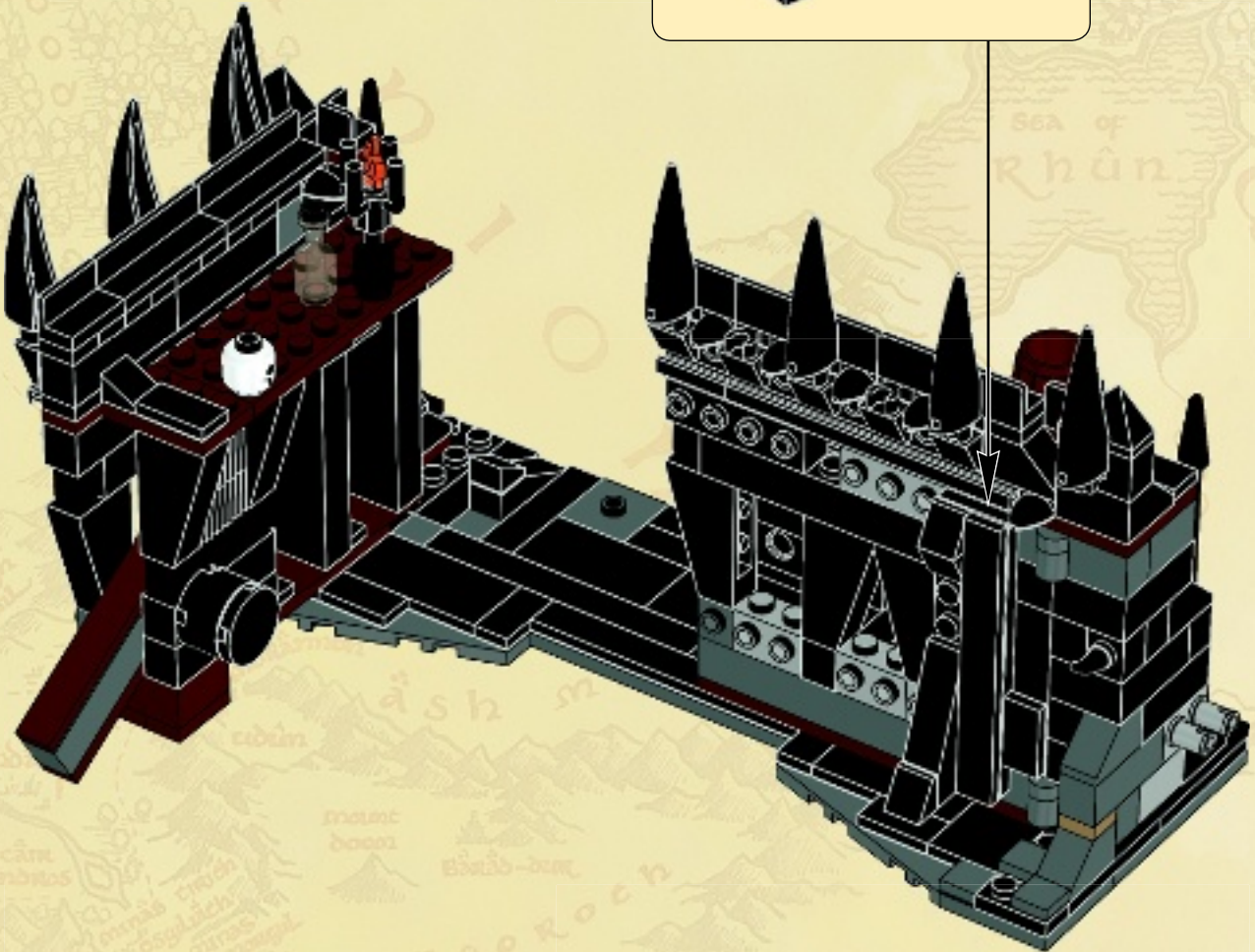
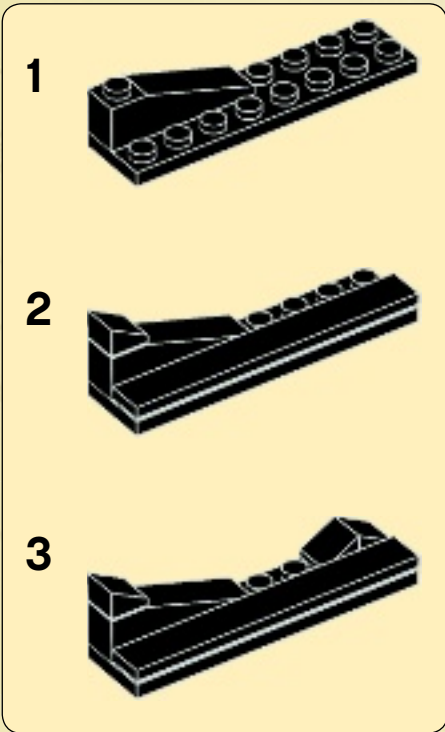

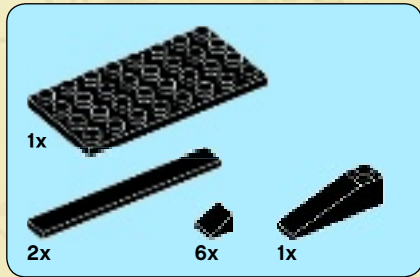

46

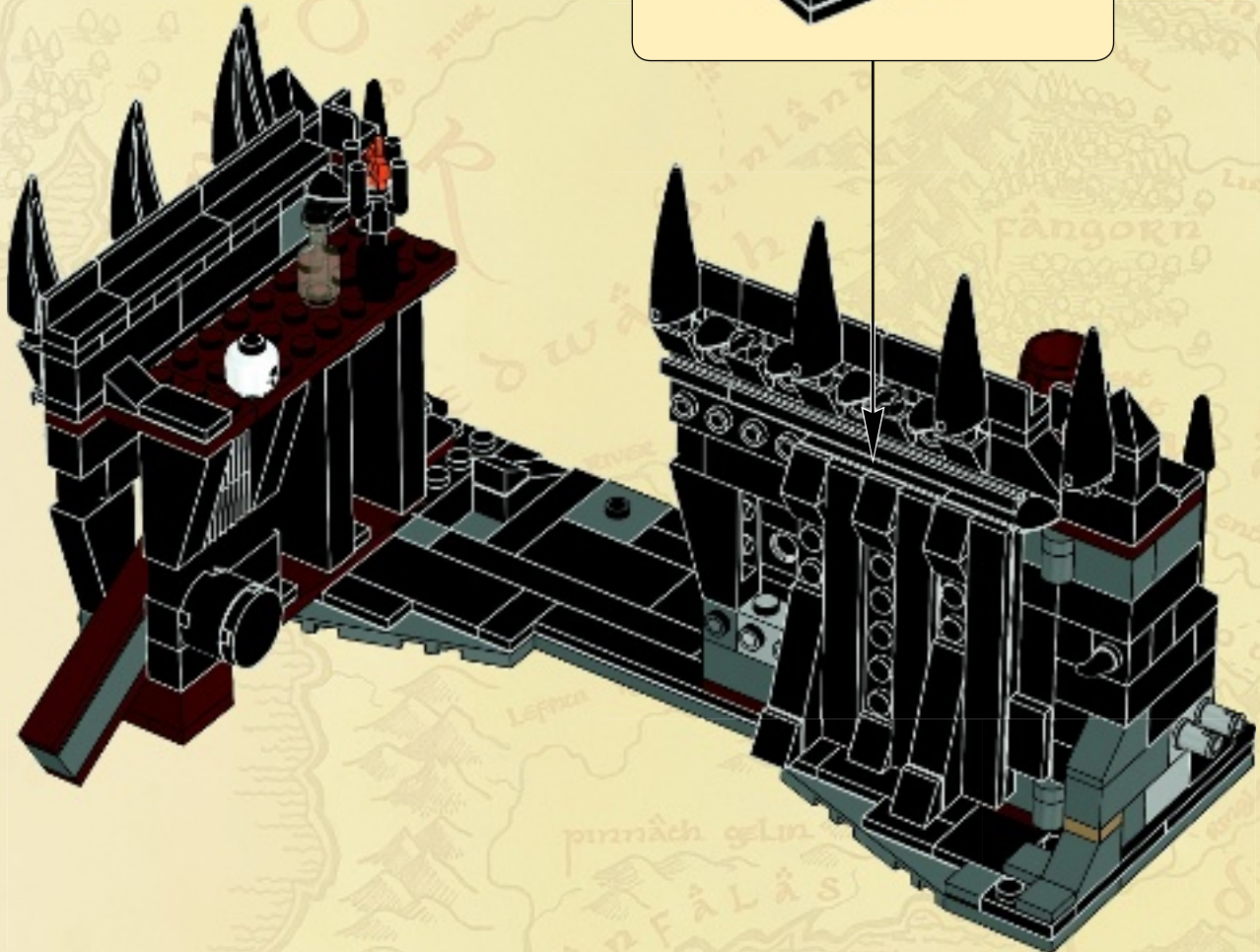
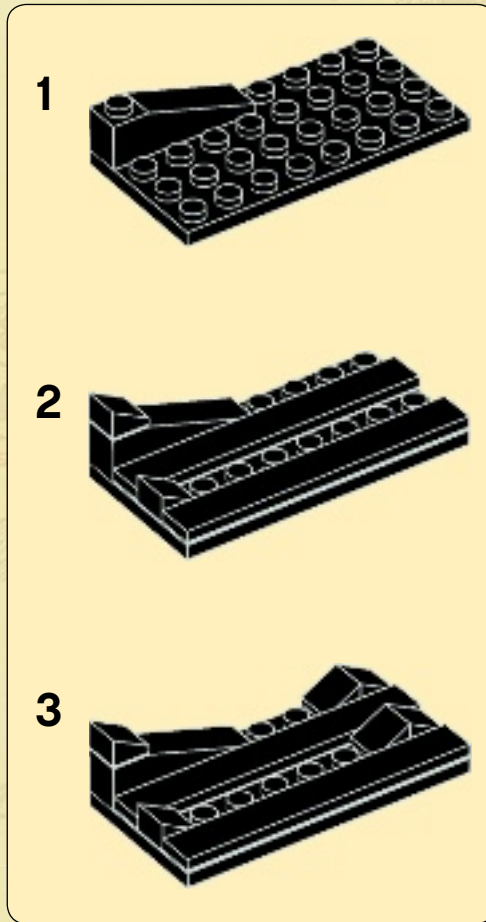

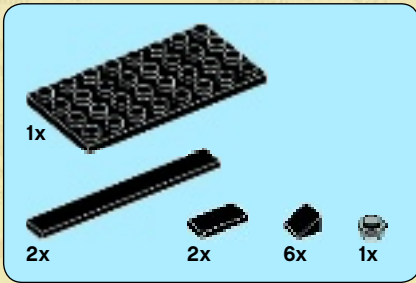

47

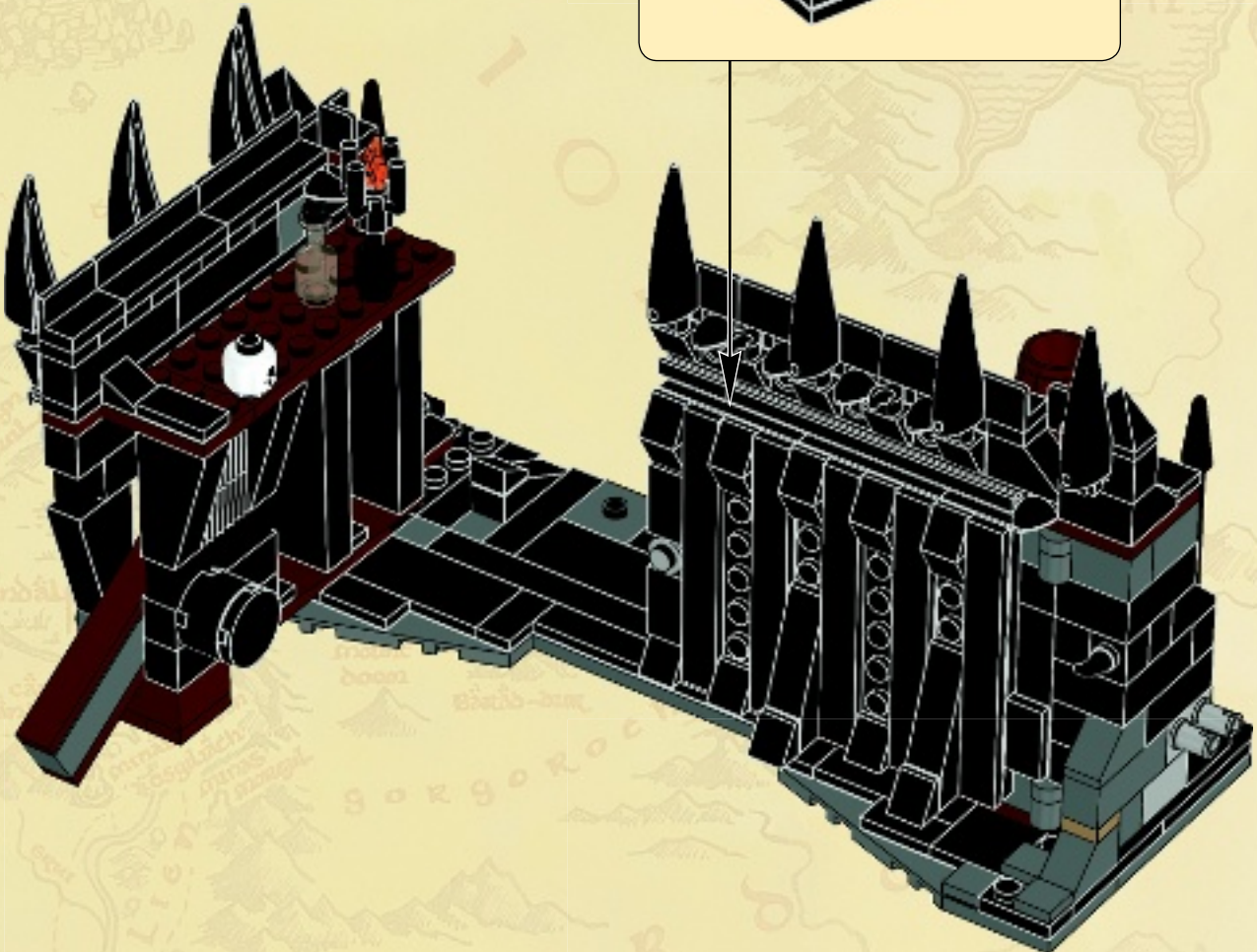
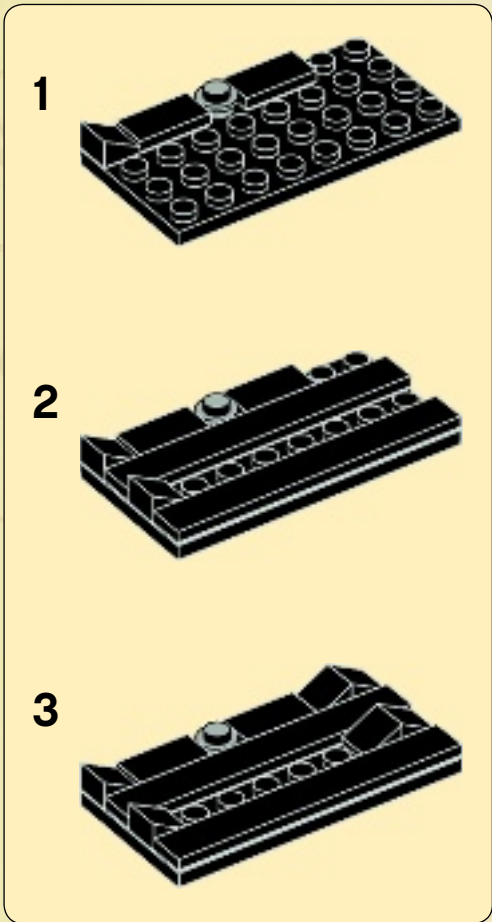

1

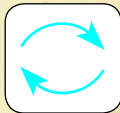
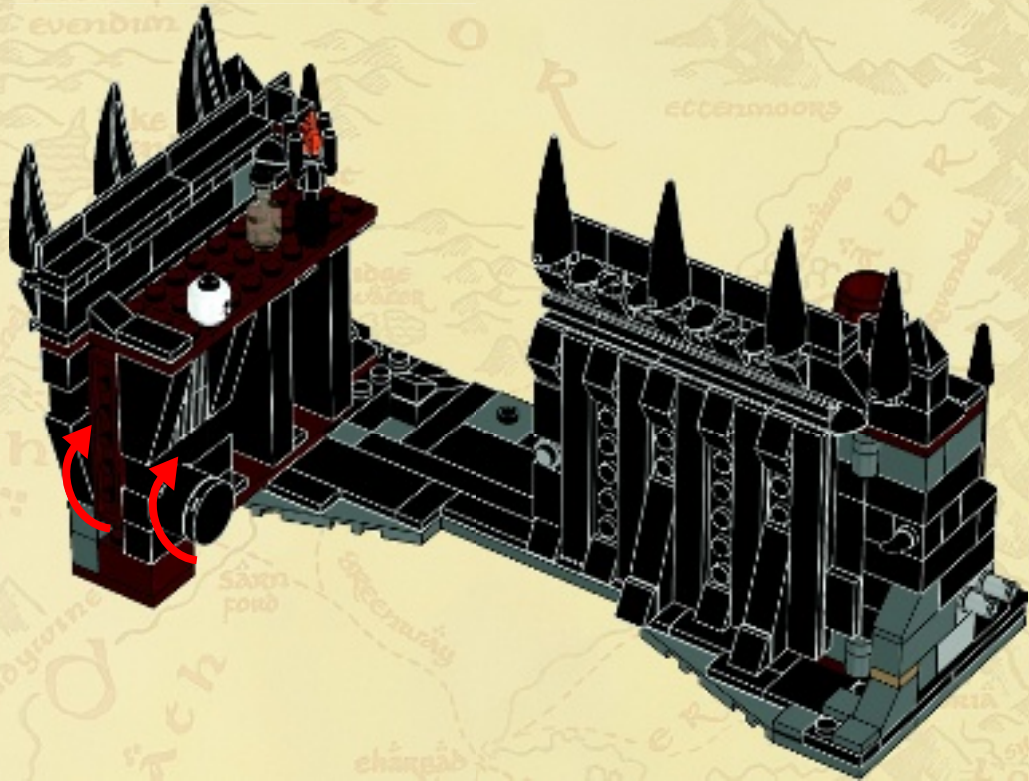

2

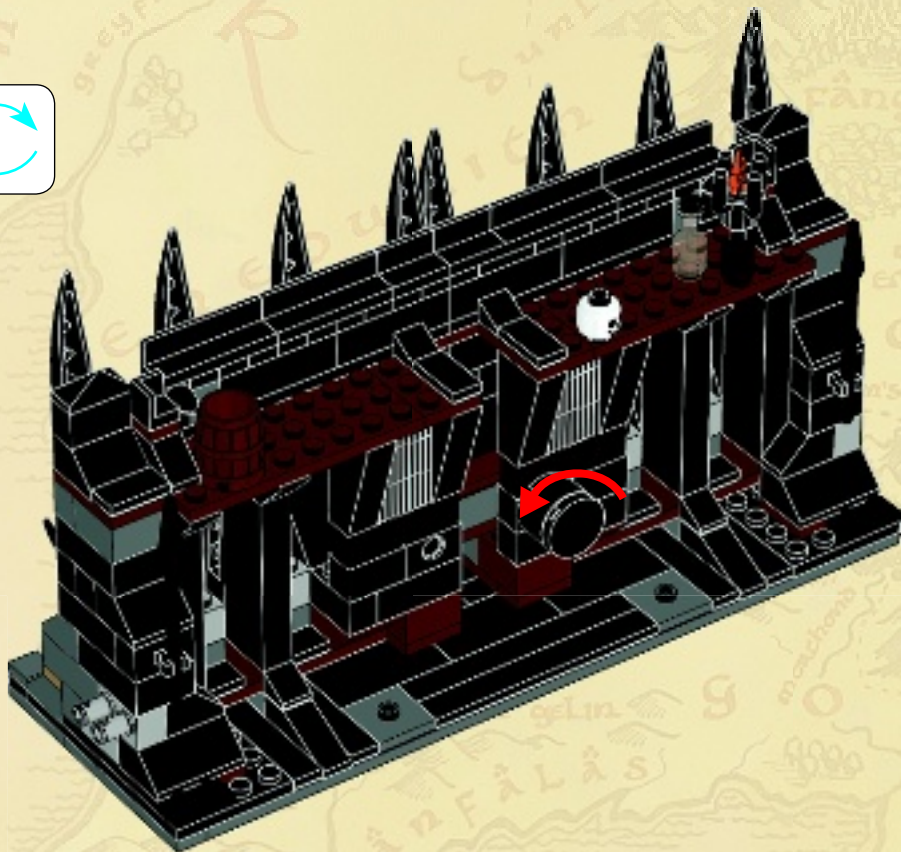



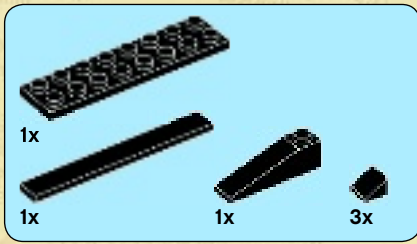

48

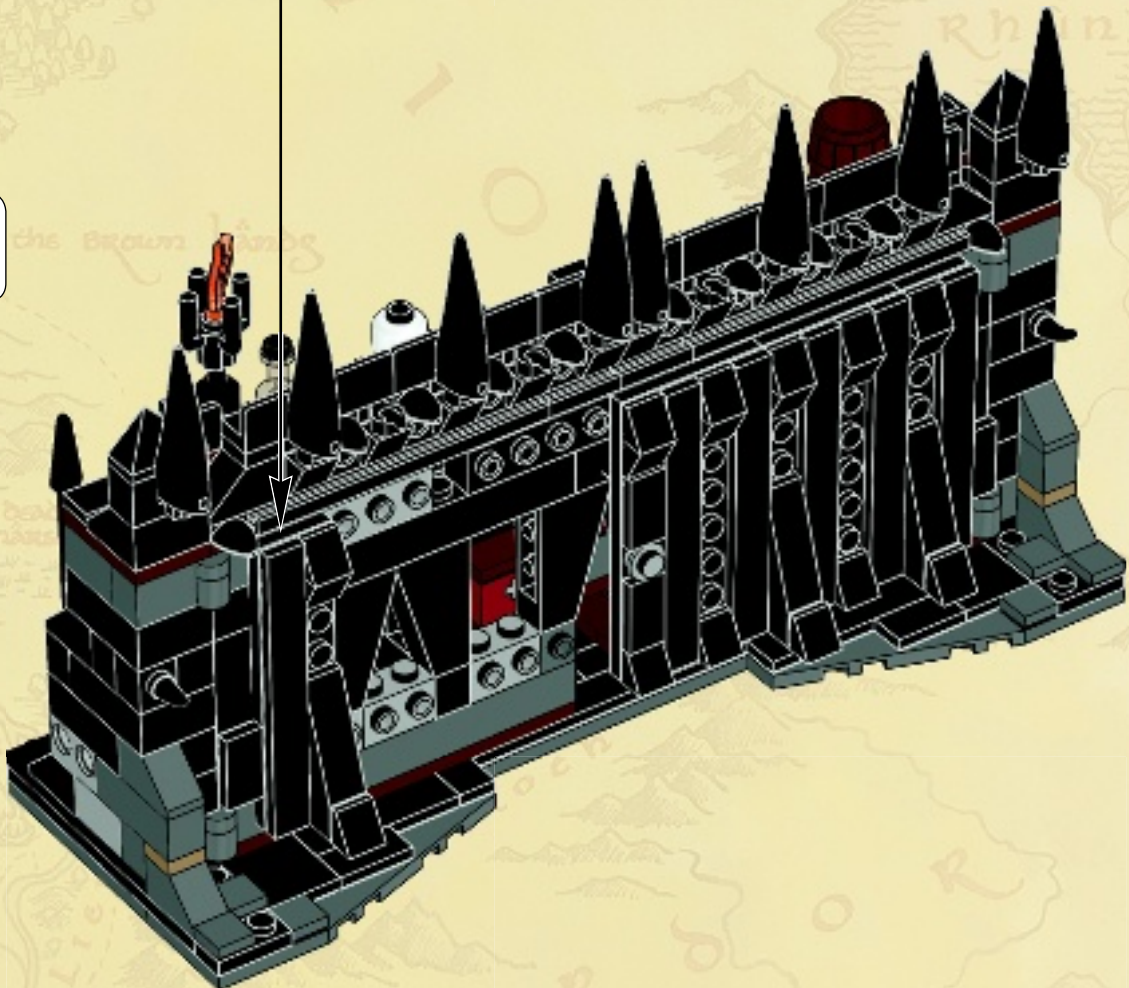
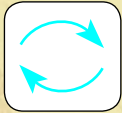
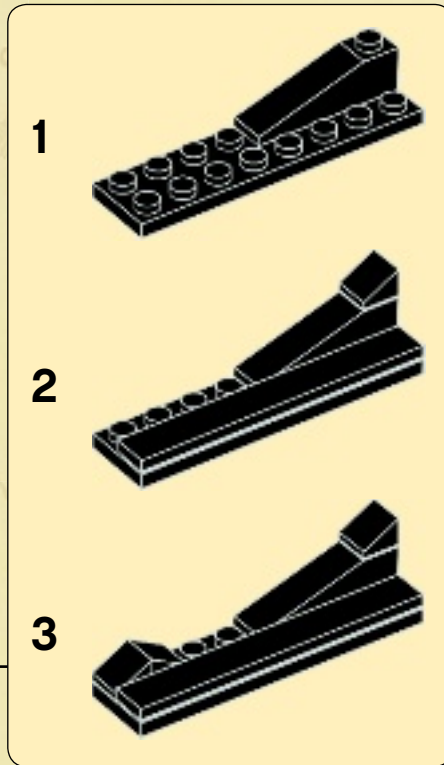

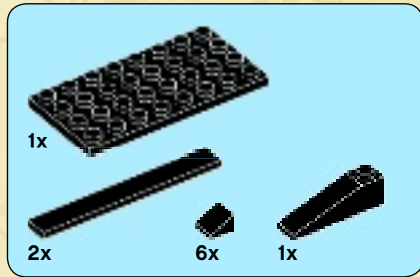

49

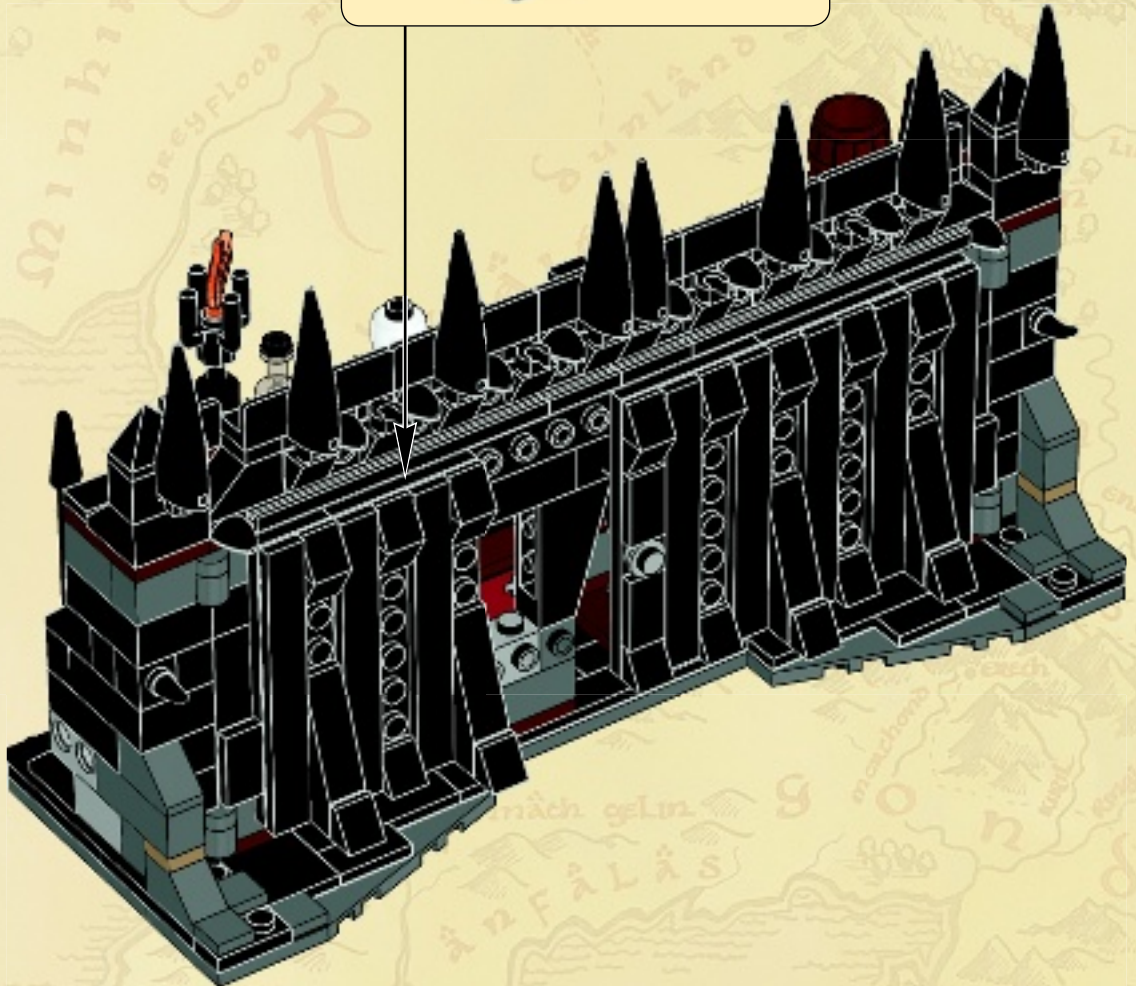
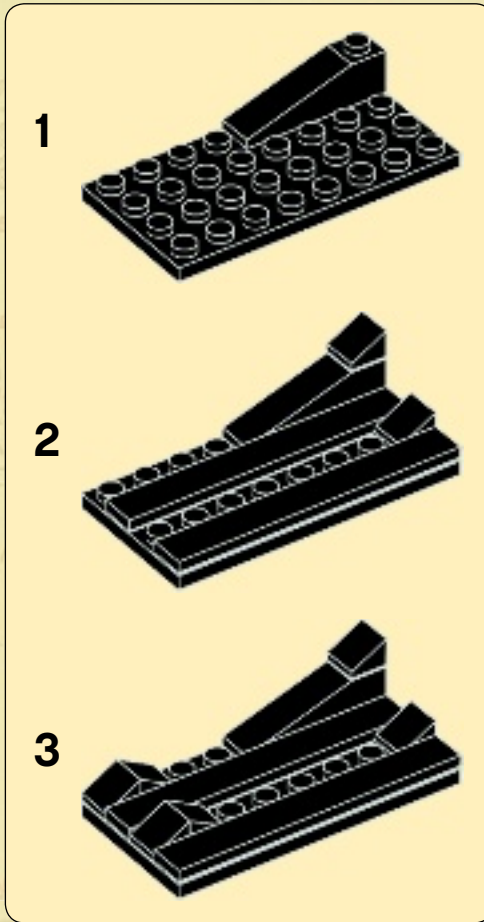

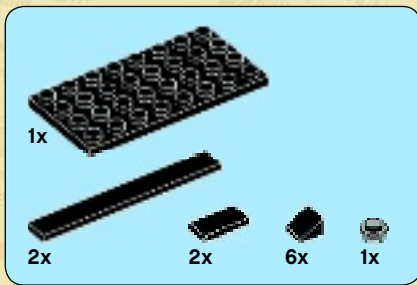

50

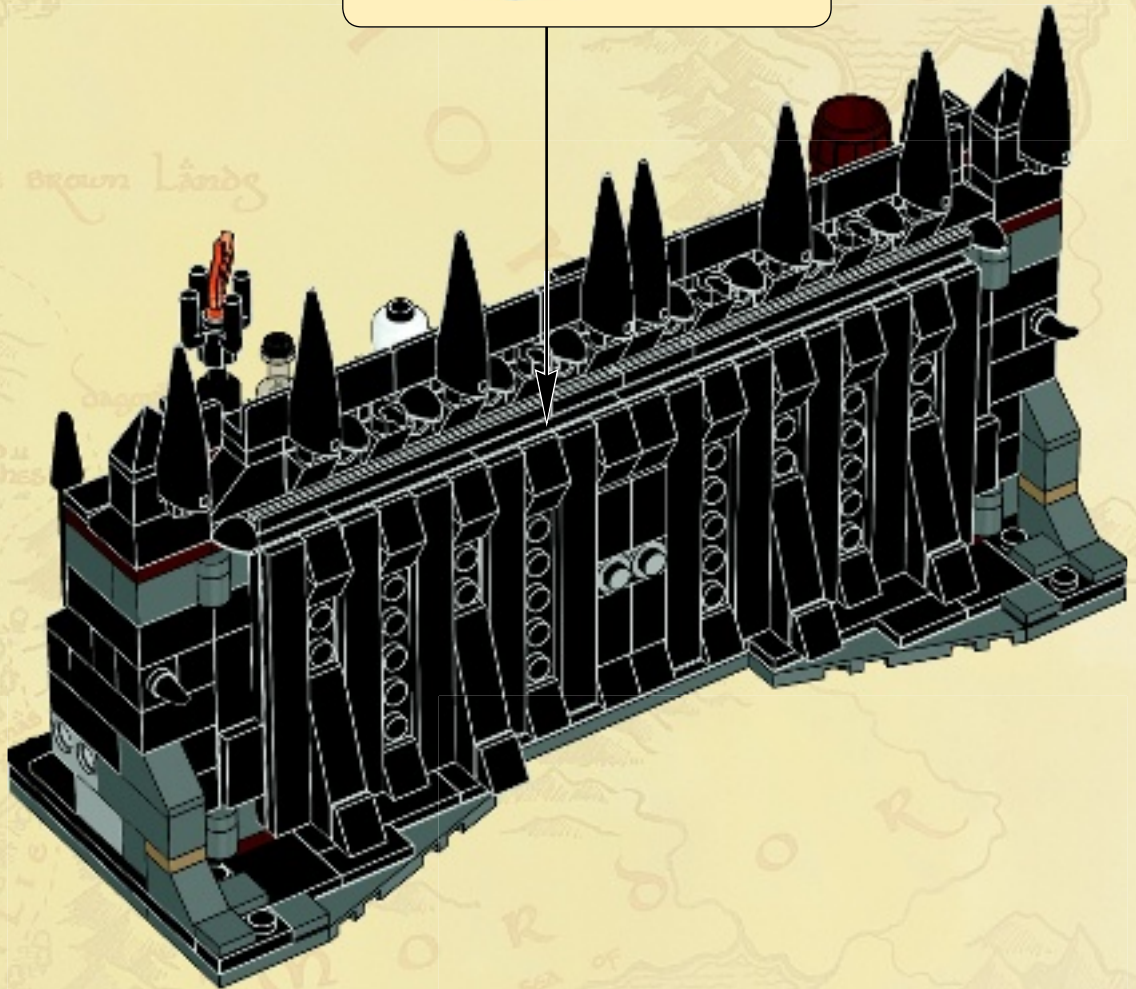
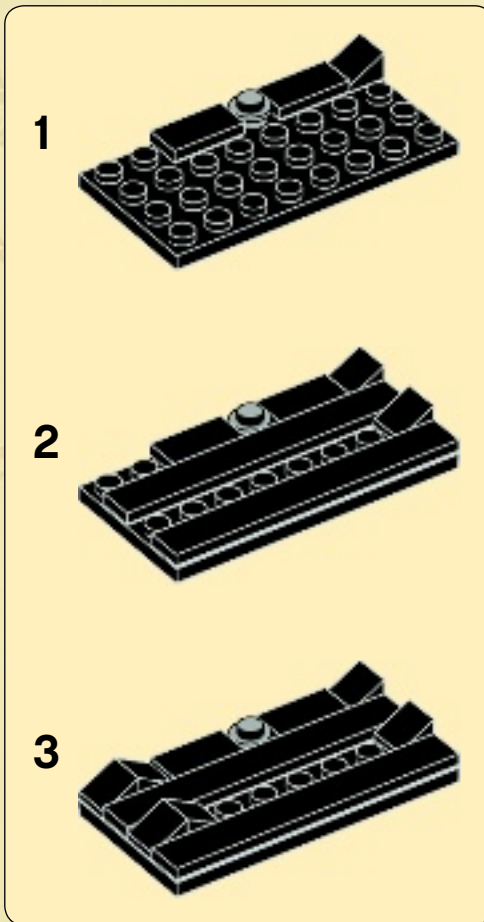

1

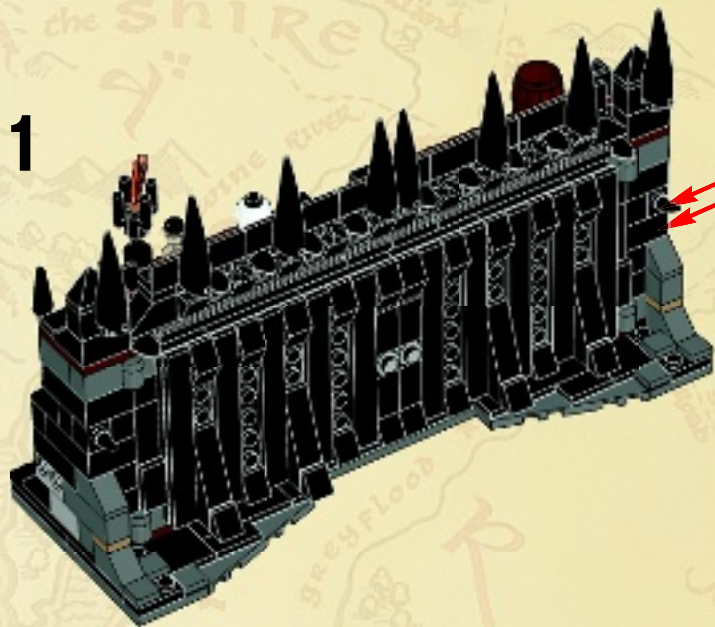

2





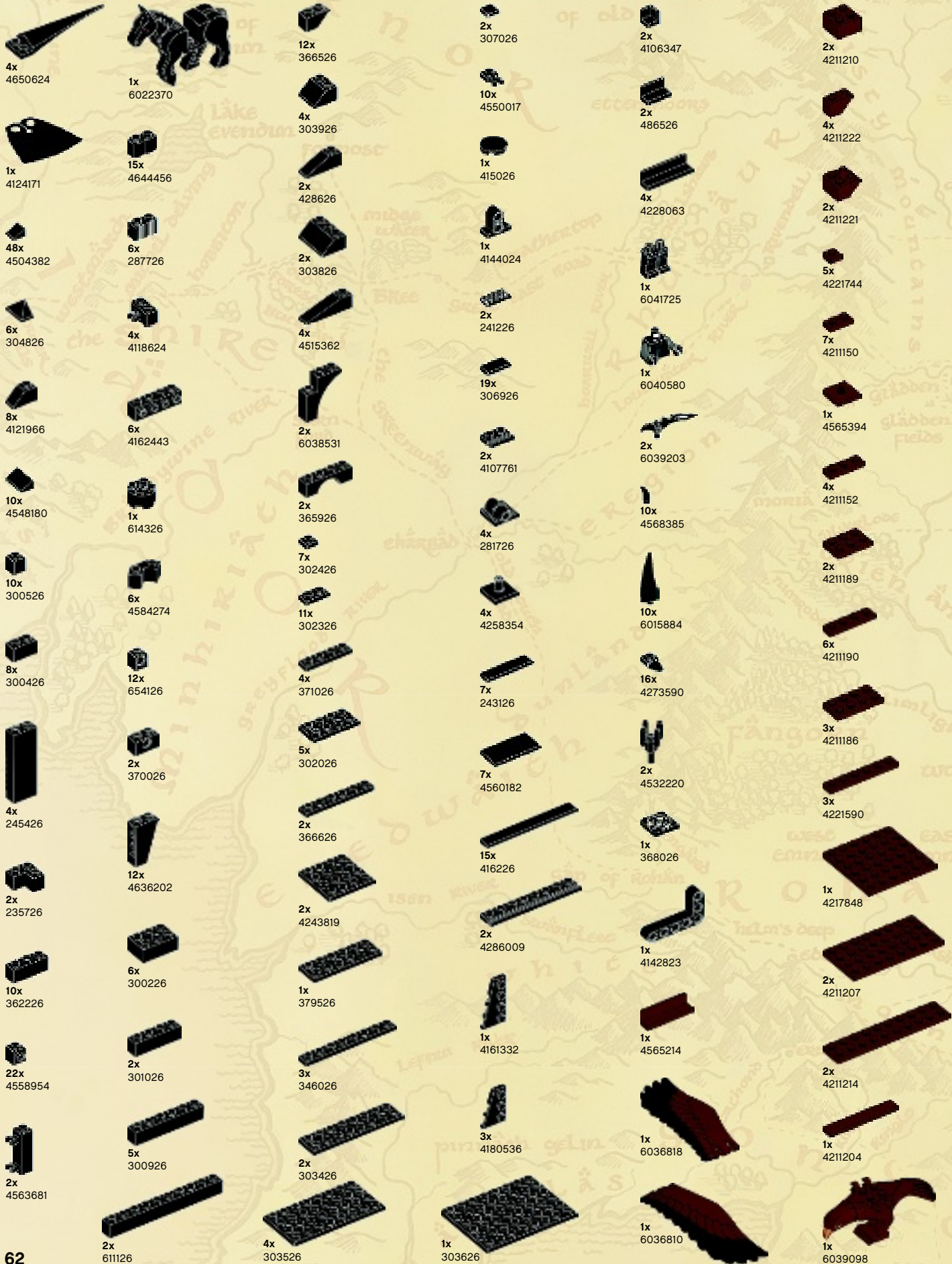

- 4x 4650624
- 1x 6022370
- 12x 366526
- 4x 307026
- 2x 4106347
- 2x 4211210
- 1x 4124171
- 15x 4644456
- 4x 303926
- 10x 4550017
- 2x 486526
- 4x 4211222
- 48x 4504382
- 6x 287726
- 2x 428626
- 1x 415026
- 4x 4228063
- 2x 4211221
- 6x 304826
- 4x 4118624
- 2x 428626
- 1x 4144024
- 1x 6041725
- 5x 4221744
- 8x 4121966
- 6x 4162443
- 2x 303826
- 1x 4144024
- 1x 6040580
- 7x 4211150
- 10x 4548180
- 1x 614326
- 2x 6038531
- 2x 4107761
- 1x 4565394
- 10x 300526
- 6x 4584274
- 2x 365926
- 4x 4107761
- 4x 281726
- 2x 302426
- 10x 4211189
- 8x 300426
- 12x 654126
- 7x 302426
- 4x 4258354
- 6x 4211190
- 4x 300426
- 12x 654126
- 11x 302326
- 4x 4258354
- 3x 4211186
- 4x 245426
- 2x 370026
- 4x 371026
- 5x 302026
- 7x 4258354
- 3x 4221590
- 2x 235726
- 12x 4636202
- 2x 366626
- 7x 4560182
- 2x 4532220
- 10x 362226
- 6x 300226
- 2x 416226
- 1x 368026
- 22x 4558954
- 2x 301026
- 2x 4243819
- 15x 416226
- 1x 4142823
- 2x 4563681
- 2x 301026
- 1x 379526
- 2x 4286009
- 1x 4142823
- 5x 300926
- 3x 346026
- 1x 4180536
- 1x 4142823
- 2x 611126
- 5x 303426
- 1x 4161332
- 1x 4142823
- 4x 303526
- 2x 303426
- 3x 4180536
- 1x 4142823
- 1x 303626
- 2x 303426
- 1x 4180536
- 1x 4142823
- 1x 6036818
- 1x 6036810
- 1x 6039098

1x  
4211147

1x  
4211389

2x  
4211387

9x  
6015344

3x  
4211660

4x  
4211636

3x  
4211541

4x  
4211525

1x  
4540203

4x  
4211483

4x  
4211807

1x  
4211815

3x  
4211088

3x  
4211060

2x  
4211104

3x  
4211103

2x  
4211052

4x  
4211090

6x  
4504378

15x  
4211135

3x  
4221745

1x  
4210646

1x  
6000853

2x  
4211043

3x  
6039176

2x  
4211056

2x  
4211099

1x  
4210794

14x  
4210848

4x  
4587212

4x  
4558955

1x  
4211045

3x  
4648256

2x  
4565322

2x  
4290149

2x  
4290150

1x  
6041727

4x  
6011461

4x  
4210795

1x  
6039174

1x  
4267282

1x  
6038374

1x  
4538720

1x  
9327

1x  
6040581

2x  
4651445

1x  
6038519

1x  
4600294

1x  
4549636

1x  
4620380

7x  
4549436

2x  
6004384

1x  
4611880

1x  
4611882

1x  
4653172

1x  
6038650

1x  
6002759

1x  
6000177

1x  
4159279

2x  
4113916

1x  
6042874

2x  
4540865

1x  
4654448

8x  
4519970

3x  
6022105

2x  
4518687

2x  
4529672

2x  
6010063

1x  
4568934

2x  
4549898

1x  
4568951

1x  
6005104

1x  
6042872

1x  
6040582

1x  
4539059

Customer Service  
Kundenservice  
Service Consommateurs  
Servicio Al Consumidor

LEGO.com/service or dial

🇧🇪 🇩🇪 🇫🇷 🇮🇹 🇯🇵 🇰🇷 🇸🇪 🇸🇯 🇹🇼 🇺🇰 🇺🇸 🇻🇪  
: 00800 5346 5555  
: 1-800-422-5346

79005





79006



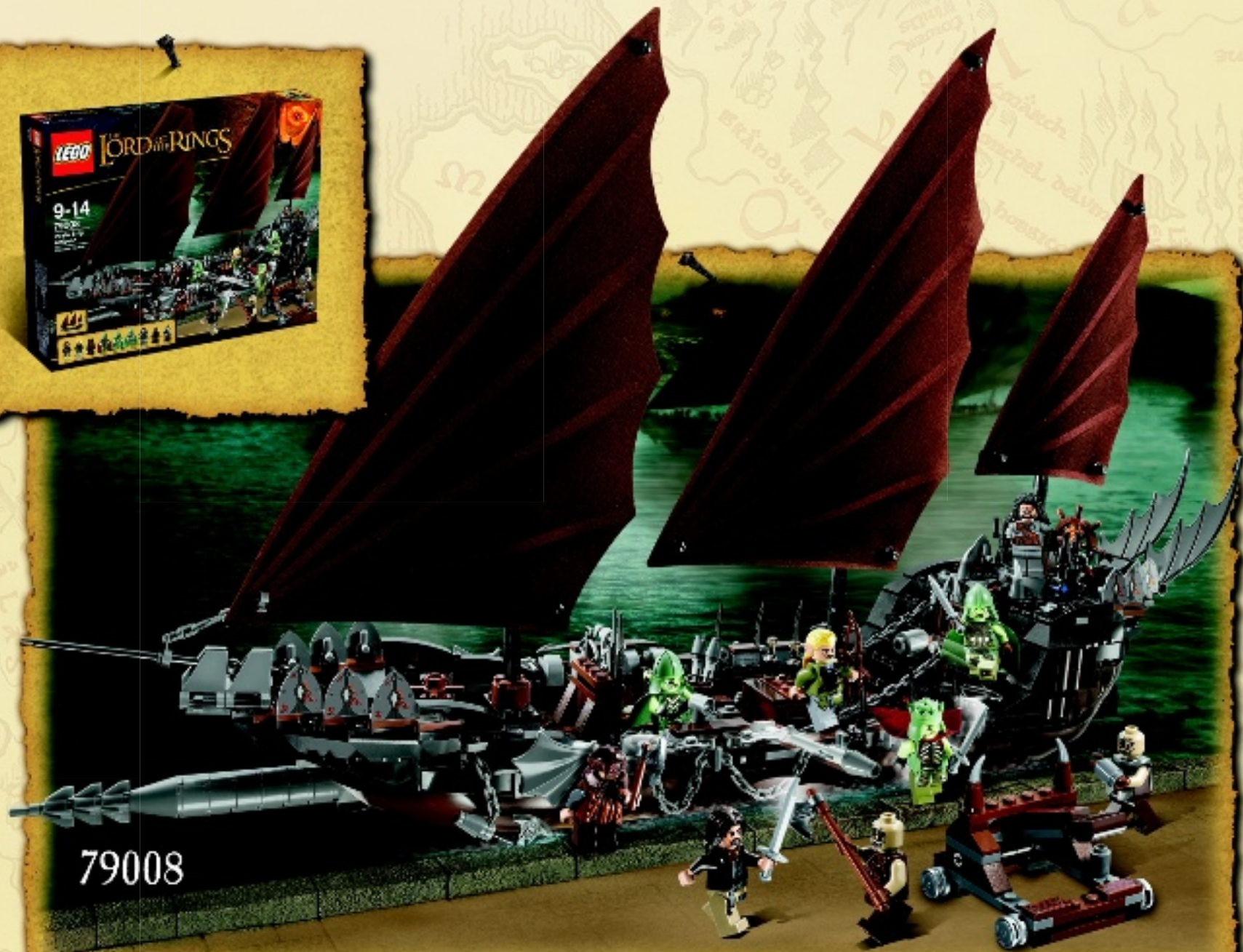

79008

# LEGO.com/theLordoftherings

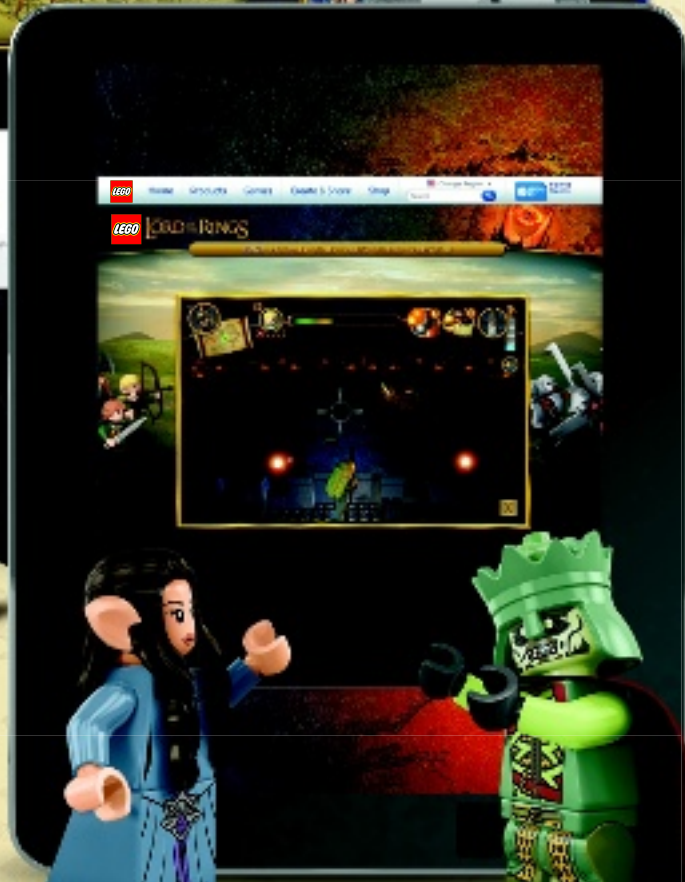
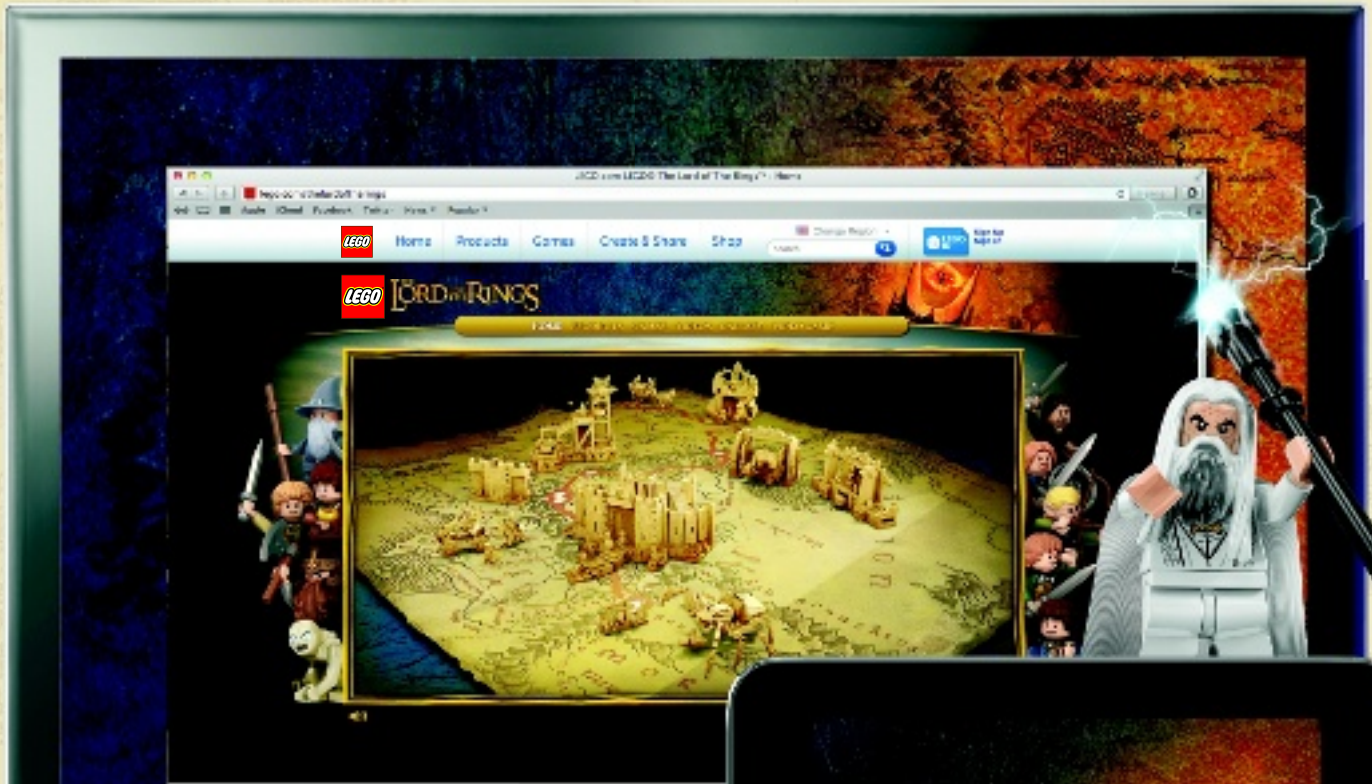

The LEGO logo is displayed in its characteristic white, rounded font with a thick black outline and a yellow drop shadow, set against a solid red square background.

# THE HOBBIT™

THE DESOLATION OF SMAUG



CONTINUE THE ADVENTURE  
DECEMBER 2013

[LEGO.com/thehobbit](http://LEGO.com/thehobbit)

THE HOBBIT: THE DESOLATION OF SMAUG:  
©WBEI™ Middle-earth Ent. Lic. to New Line.  
(s13)



LEGO, the LEGO logo and the Minifigure are  
trademarks of the LEGO Group.  
©2013 the LEGO Group.

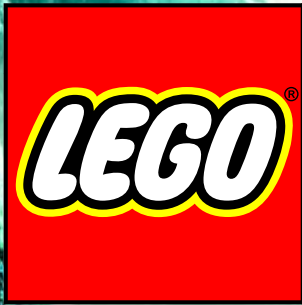

# THE LORD OF THE RINGS



8+



2/4



15-35



GAMES



LEGO and the LEGO logo are trademarks of the LEGO Group. © 2013 The LEGO Group. THE LORD OF THE RINGS. © NLP™ Middle-earth Ent. Lic. to New Line. (S13)



# THE LORD OF THE RINGS



[LEGO.com/thelordoftherings](http://LEGO.com/thelordoftherings)

PlayStation



XBOX 360

XBOX LIVE

Wii

NINTENDO 3DS

NINTENDO DS

PC DVD

LEGO THE LORD OF THE RINGS software © 2012 TT Games Publishing Ltd. Produced by TT Games under license from the LEGO Group. LEGO, the LEGO logo, the Brick and the Knob configurations and the Minifigure are trademarks of the LEGO Group. © 2012 The LEGO Group. © 2012 New Line Productions, Inc. All The Lord of the Rings content other than content from the New Line films © 2012 The Saul Zaentz Company d/b/a Middle-earth Enterprises ("SZE"). Mithril, Morgul, The Lord of the Rings and the names of the characters, items, events and places therein are trademarks of SZE under license to Warner Bros. Interactive Entertainment. Nintendo trademarks and copyrights are properties of Nintendo. "PlayStation" and the "PS" Family logo are registered trademarks and the PlayStation Network logo is a trademark of Sony Computer Entertainment Inc. KINECT, Xbox, Xbox 360, Xbox LIVE, and the Xbox logos are trademarks of the Microsoft group of companies and are used under license from Microsoft. All other trademarks and copyrights are the property of their respective owners. All rights reserved.

WB GAMES LOGO, WB SHIELD: TM & © Warner Bros. Entertainment Inc. (s12)





# club™

## Free\*! Gratuit!

\* Paid subscription in Australia and New Zealand.  
Abonnement payant en Australie et Nouvelle-Zélande



© 2013 The LEGO Group.

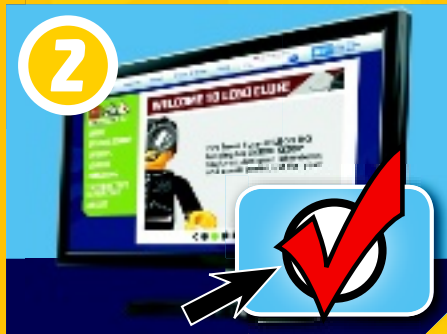

[LEGO.com/club](http://LEGO.com/club)



# WIN!

Go to [www.LEGOsurvey.com/product](http://www.LEGOsurvey.com/product) to fill out a survey for a chance to win a cool LEGO® Product.

No purchase necessary.

Open to all residents where not prohibited.



## [www.LEGOsurvey.com/product](http://www.LEGOsurvey.com/product)

### GEWINNE!

Nimm an der Umfrage auf [www.LEGOsurvey.com/product](http://www.LEGOsurvey.com/product) teil und hab die Chance ein cooles LEGO® Produkt zu gewinnen!

Die Teilnahme am Gewinnspiel führt zu keinerlei Kaufverpflichtungen. Teilnahme in allen nicht ausgeschlossenen Ländern möglich.

### WIN!

Ga naar [www.LEGOsurvey.com/product](http://www.LEGOsurvey.com/product), vul een enquêteformulier in en maak kans op een cool LEGO® product.

Geen aankoopverplichting. Iedereen mag deelnemen, uitgezonderd ingezetenden van landen waar een enquêteverbod geldt.

### GAGNE!

Visite [www.LEGOsurvey.com/product](http://www.LEGOsurvey.com/product) pour répondre à un questionnaire et avoir une chance de gagner un produit LEGO® très cool!

Aucune obligation d'achat. Ouvert à tous les résidents des pays autorisés.

### 当てよう!

[www.LEGOsurvey.com/product](http://www.LEGOsurvey.com/product) にアクセスして、アンケートにご記入ください。当選者にはレゴ製品を差し上げます。

お買い上げの必要はありません。禁止されていない限り、すべての皆様にご利用いただけます。