



# THE LORD OF THE RINGS

79008





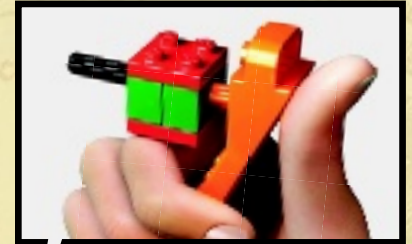

[LEGO.com/brickseparator](https://LEGO.com/brickseparator)



1

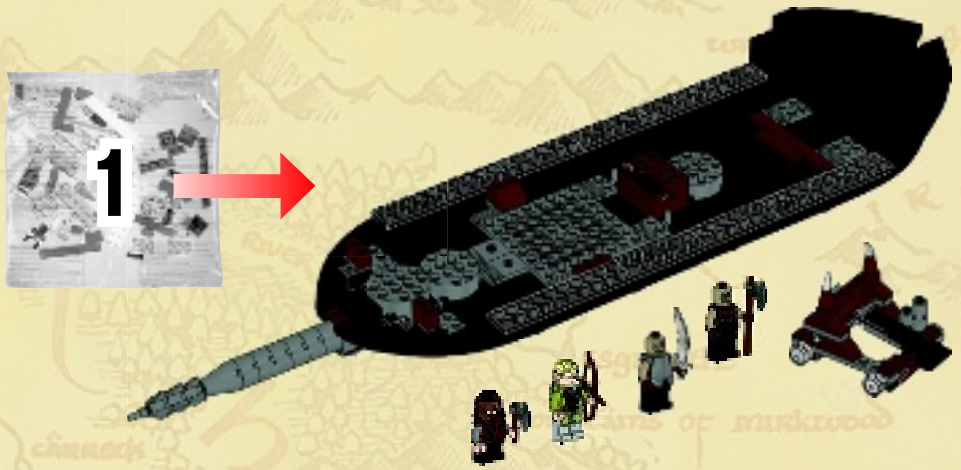
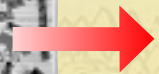

2

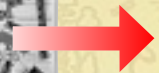

3

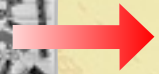

4



5



6

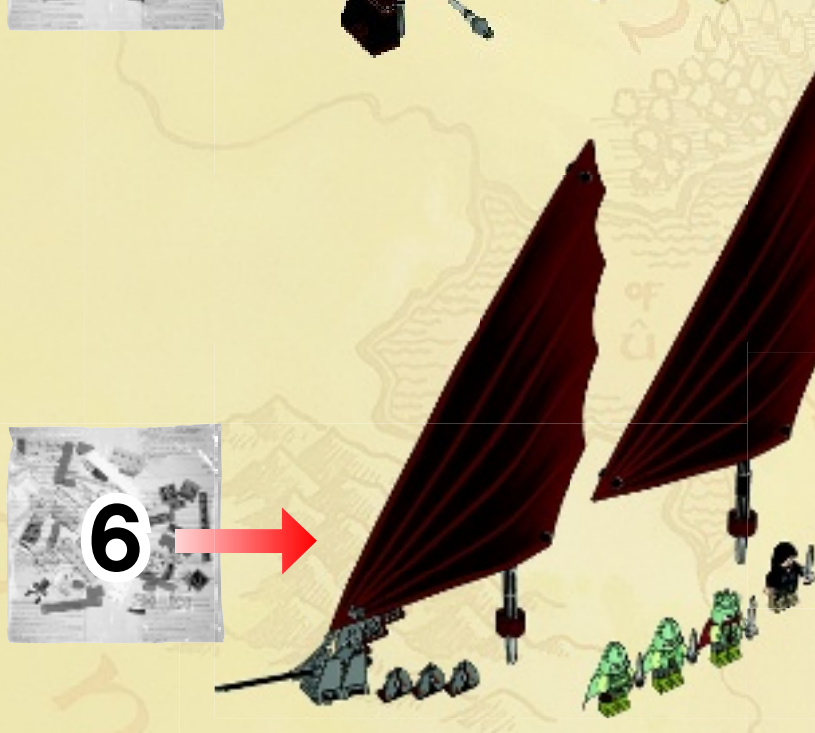



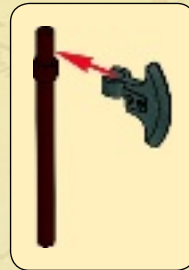
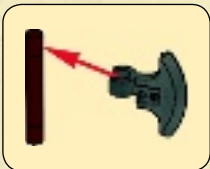
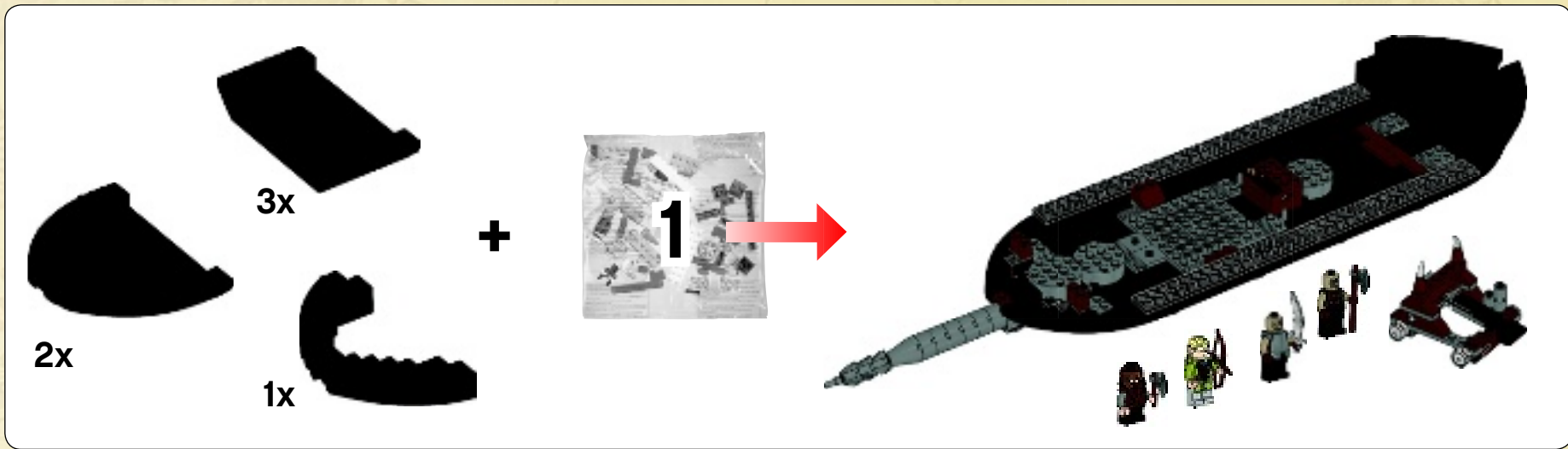



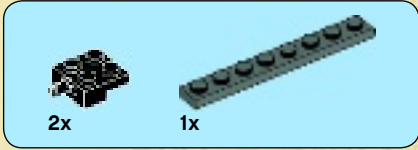

1

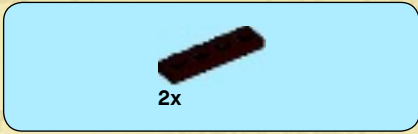
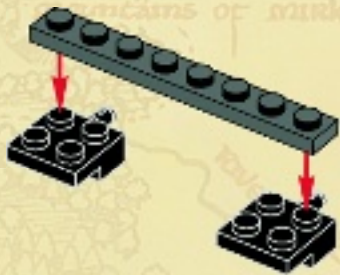

2

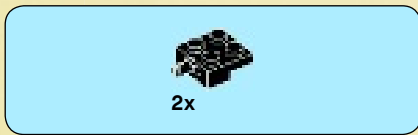
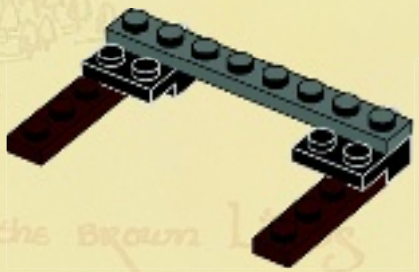

3

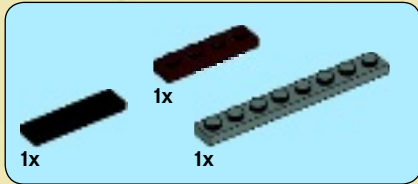
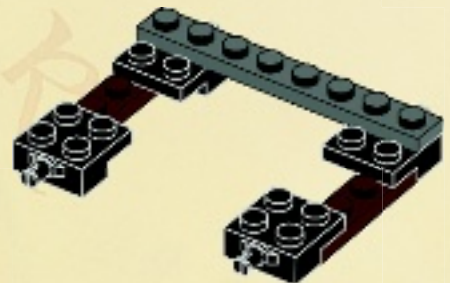

4

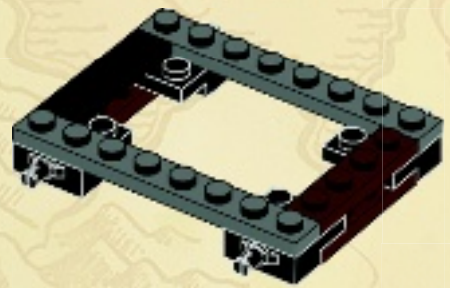



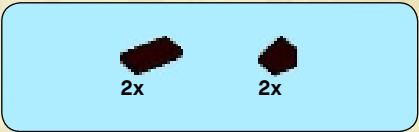

5

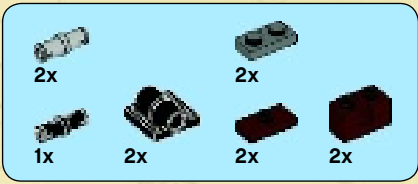
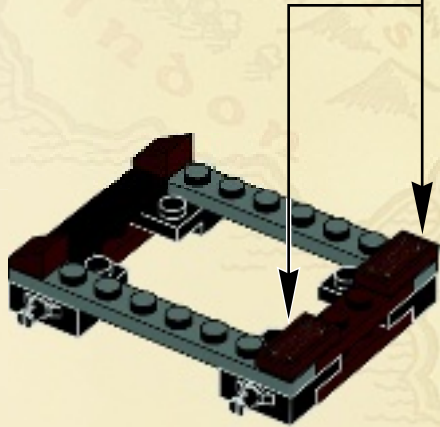
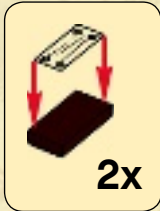

6

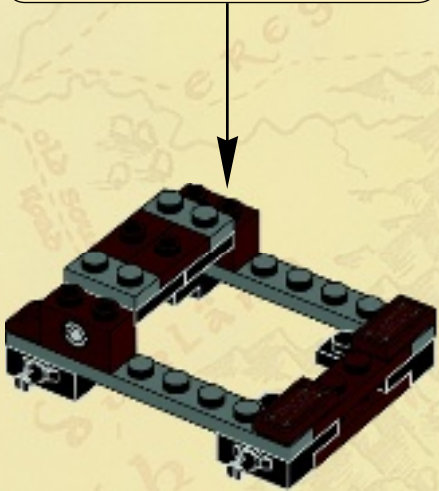
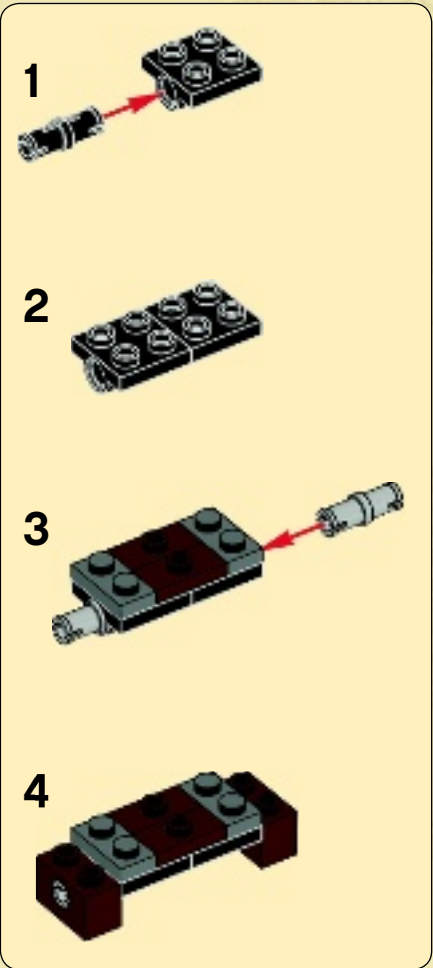



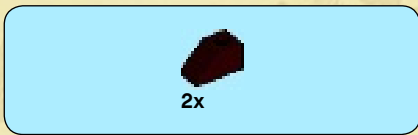

7

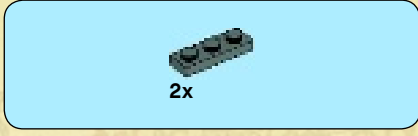
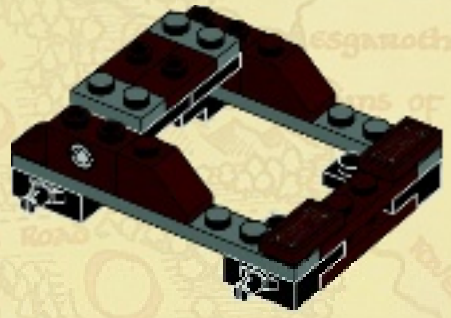

8

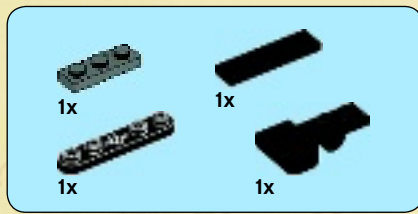
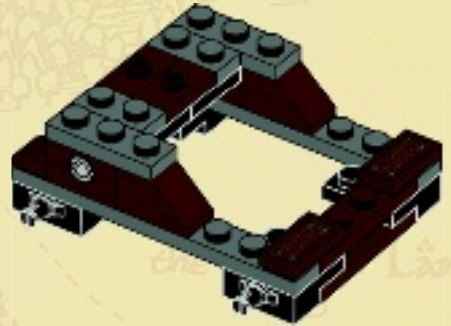

9

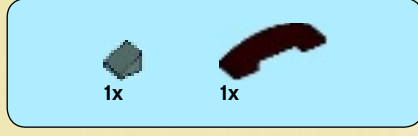
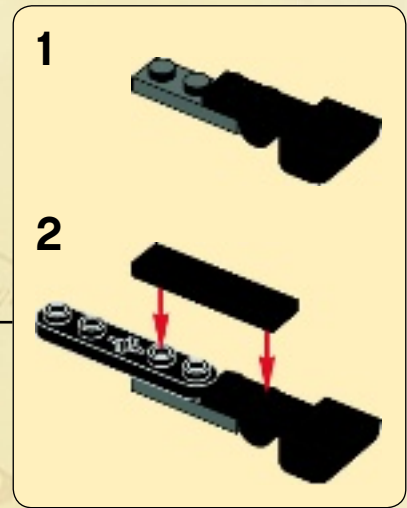
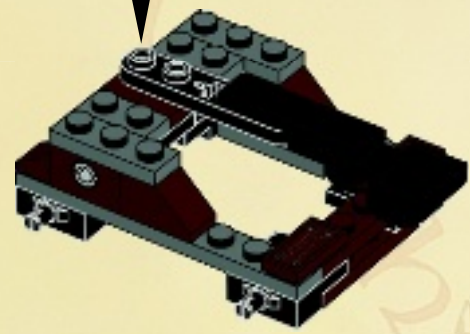

10

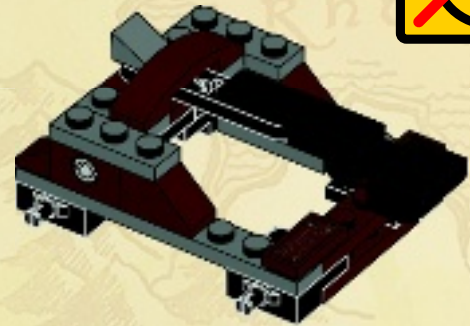





11

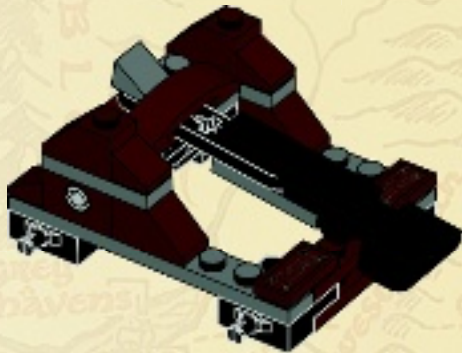

12

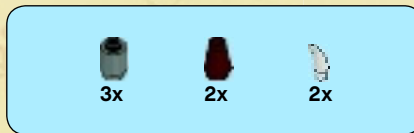
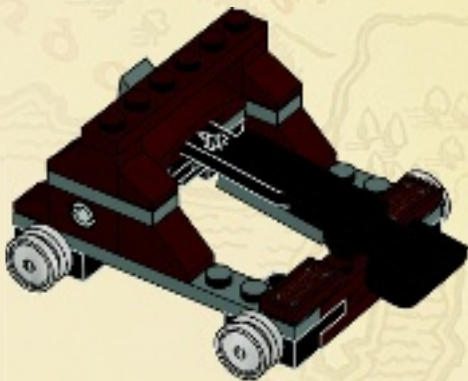

13

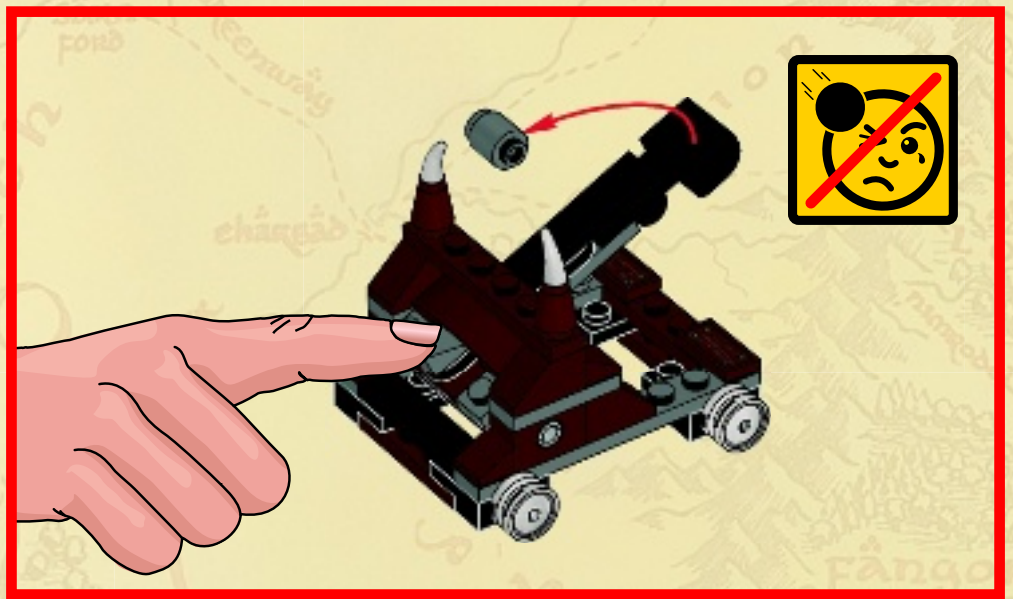
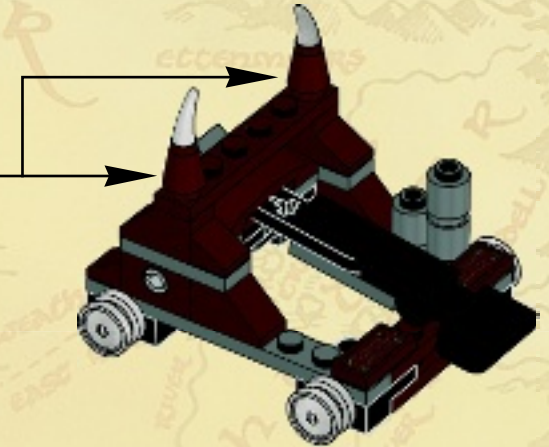
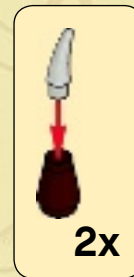





1

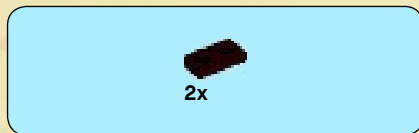
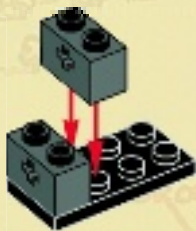

2

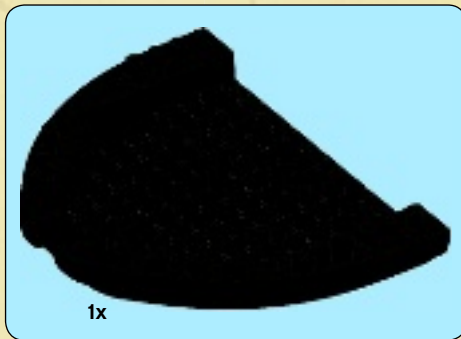

3



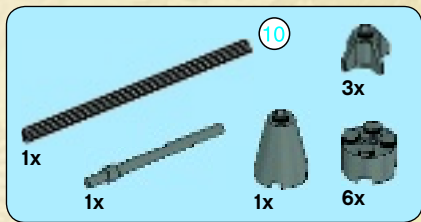

4

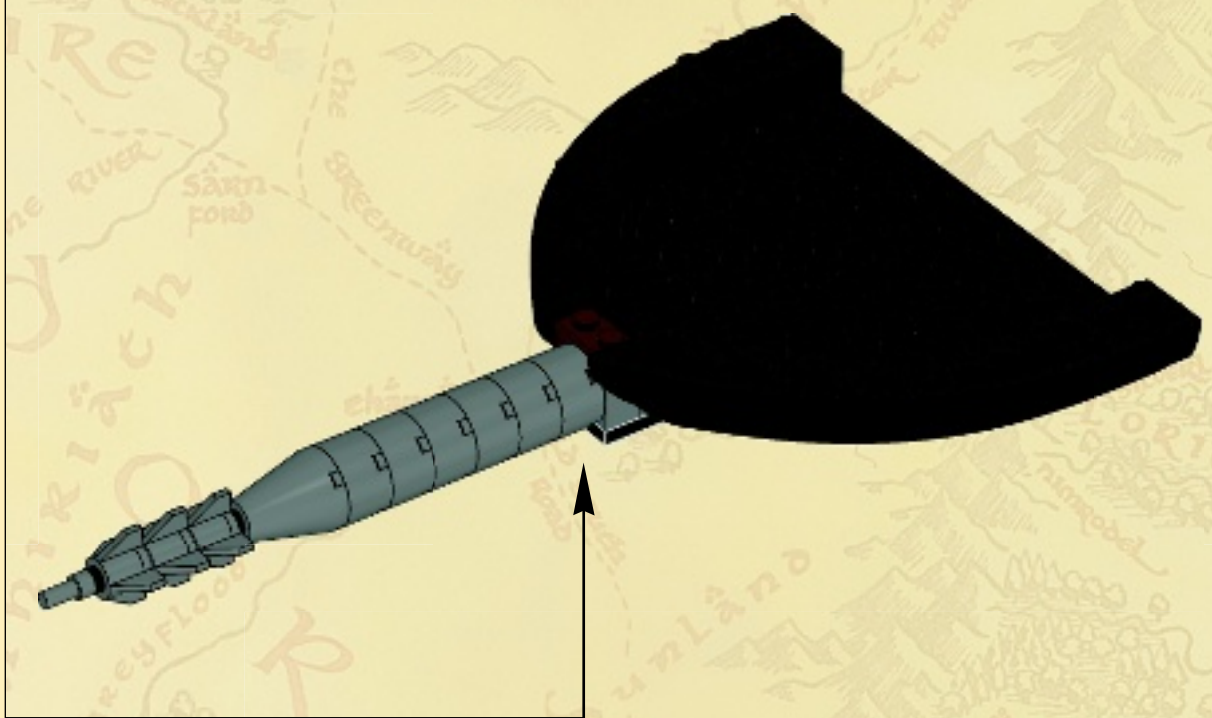
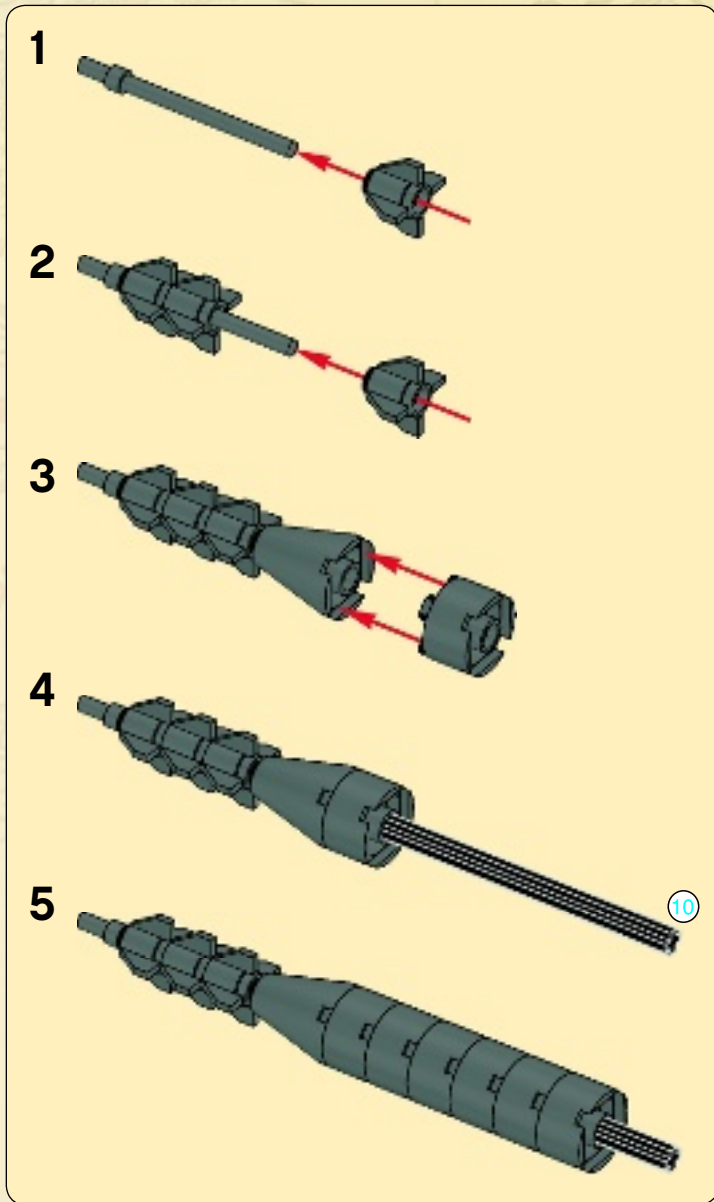



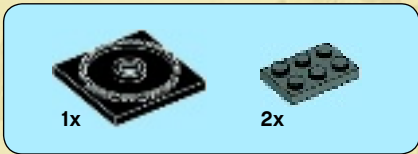

5

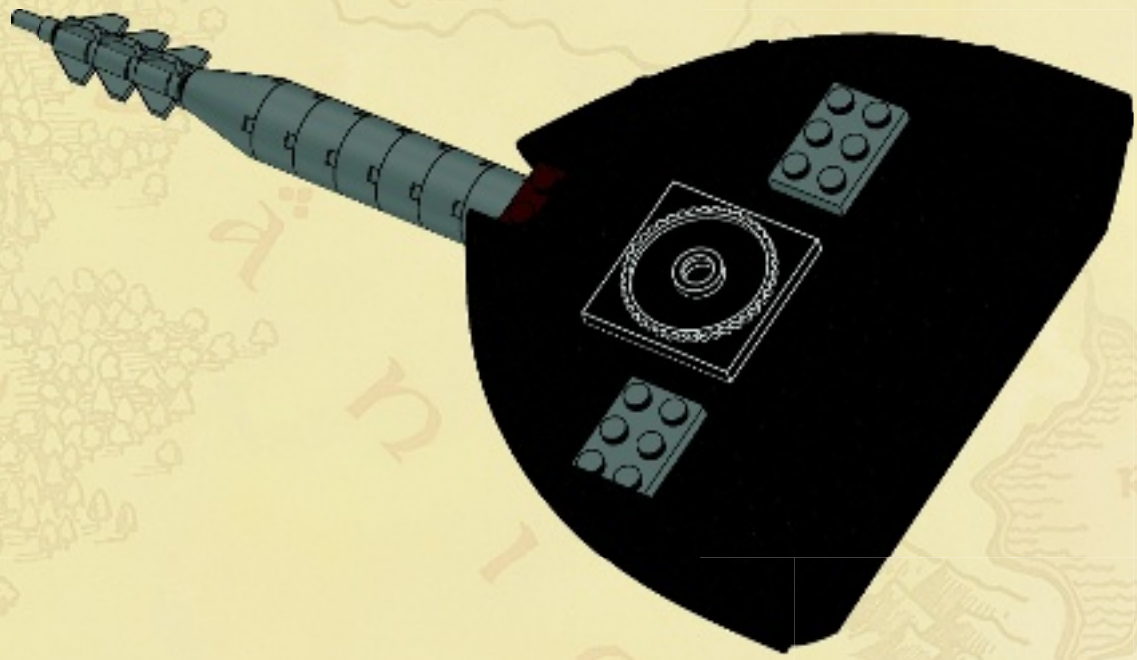

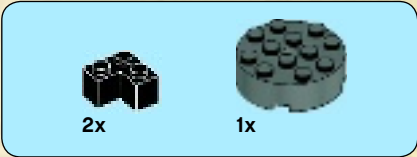

6

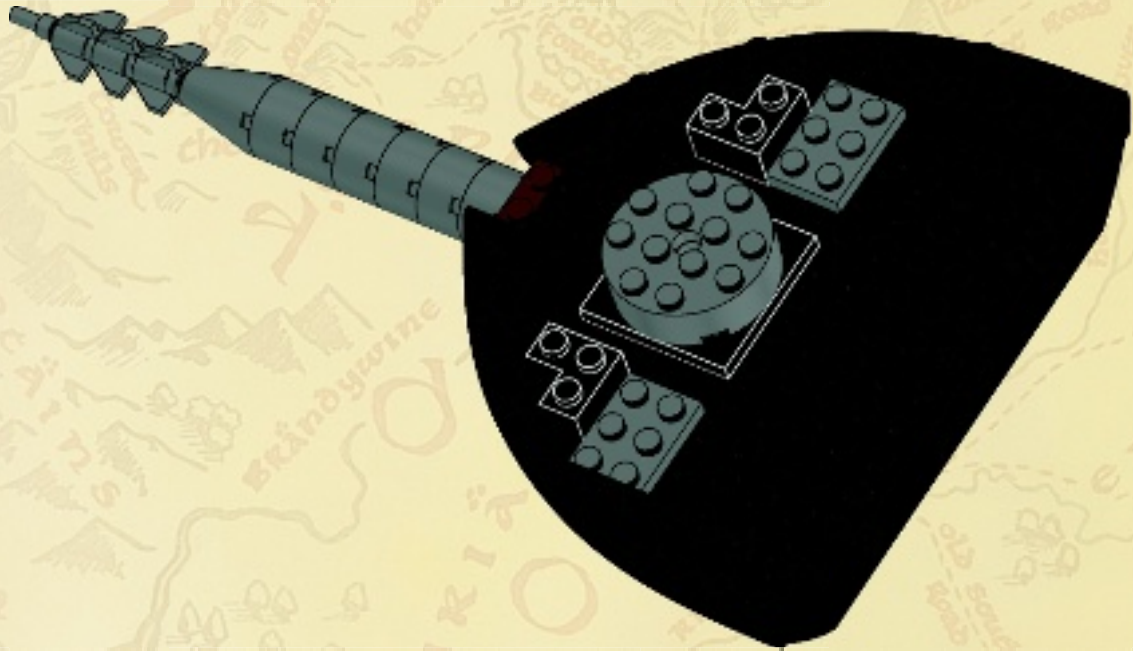



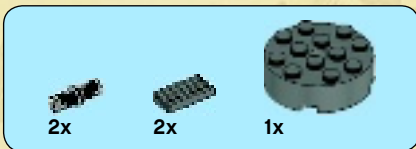

7

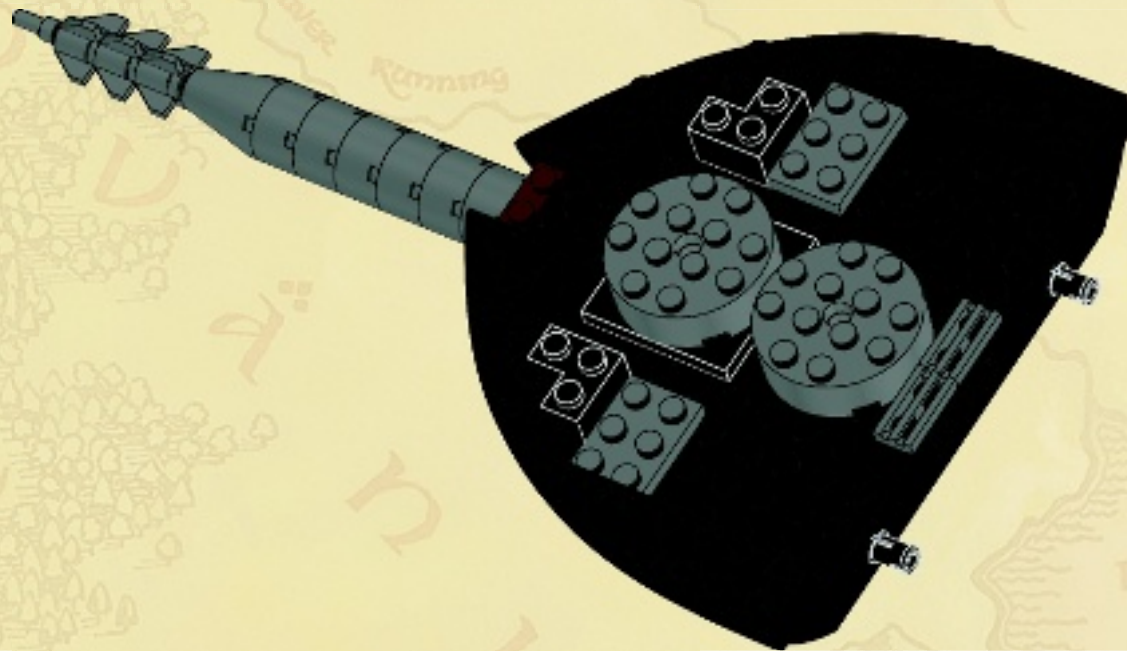

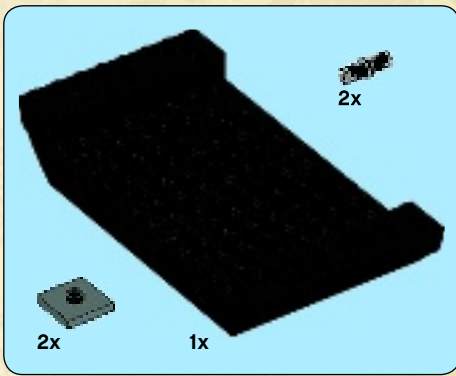

8

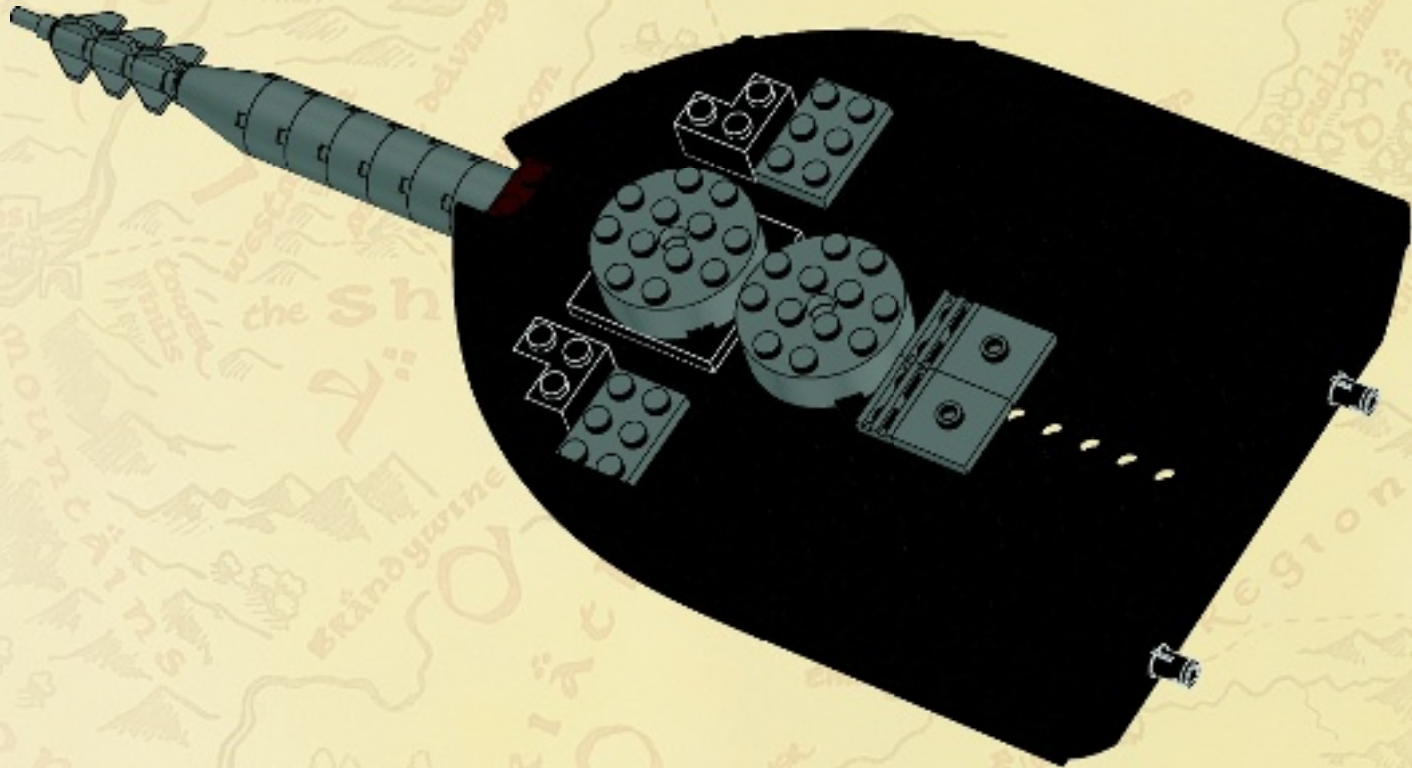



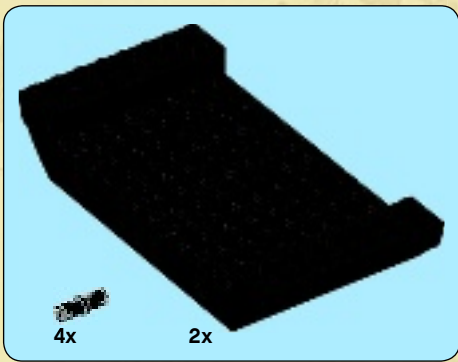

9

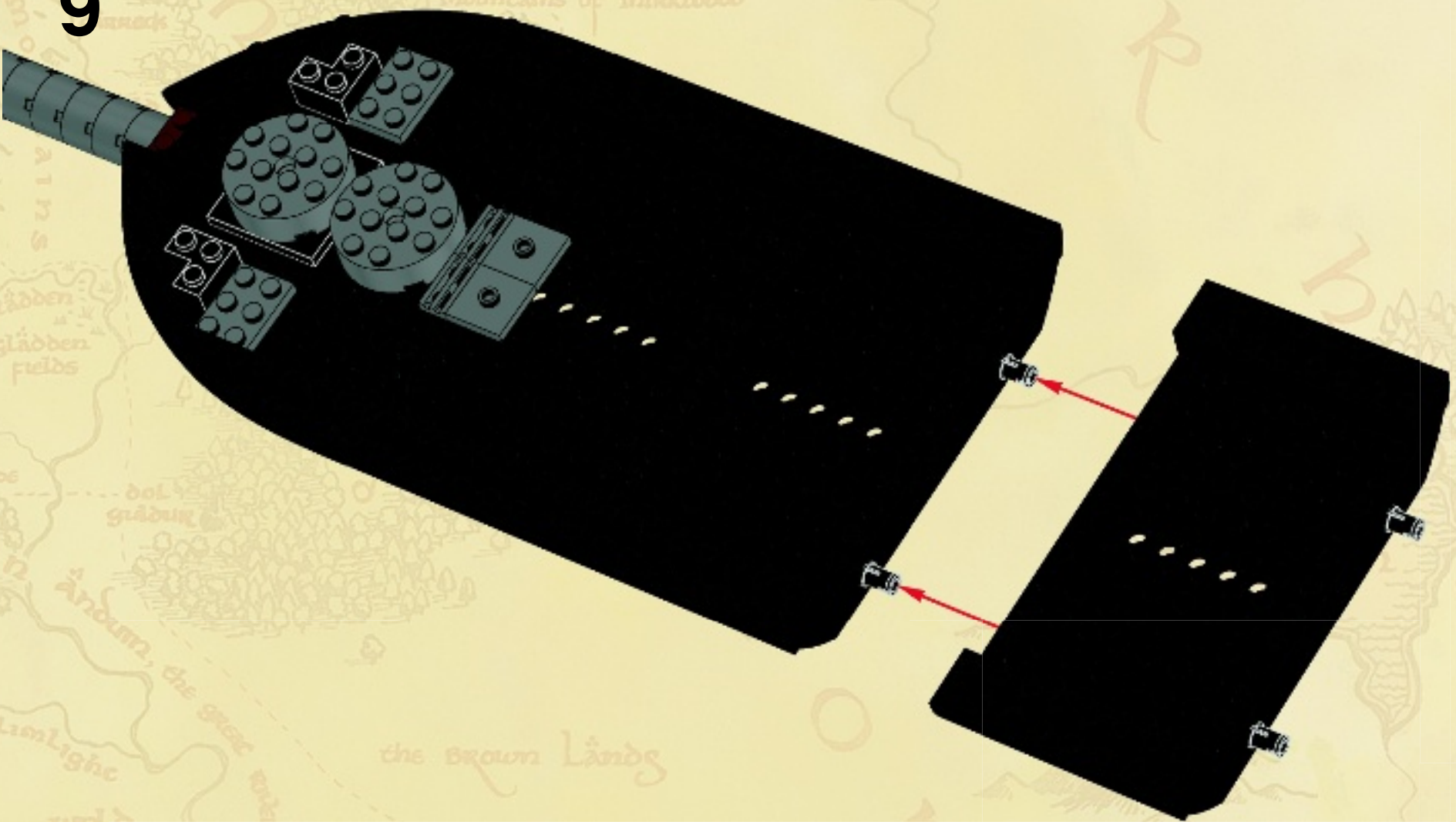

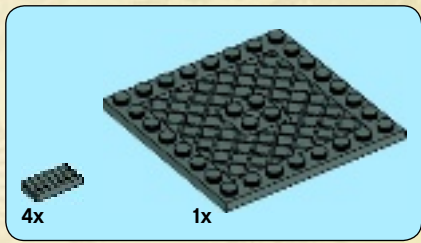

10

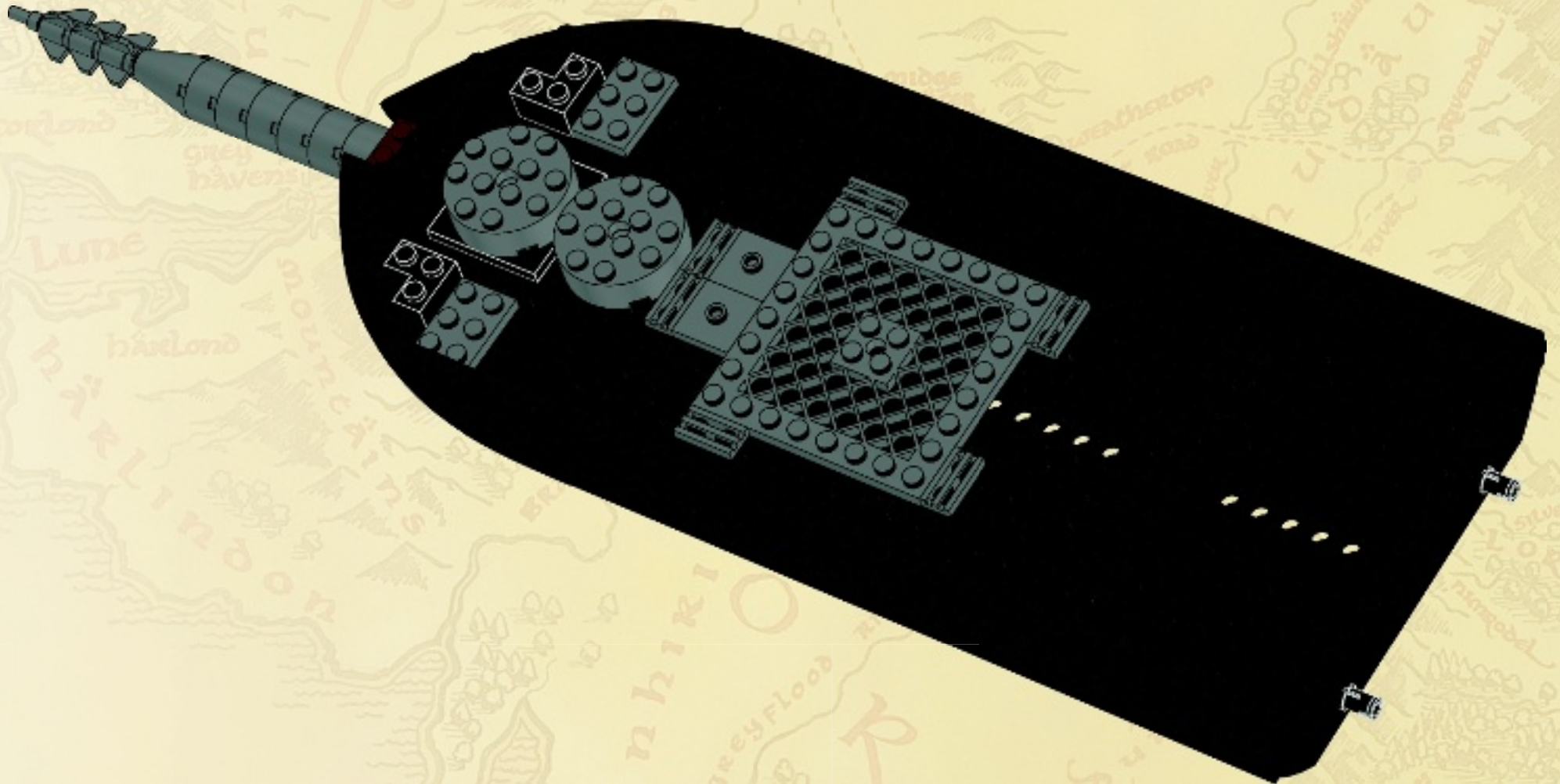





11

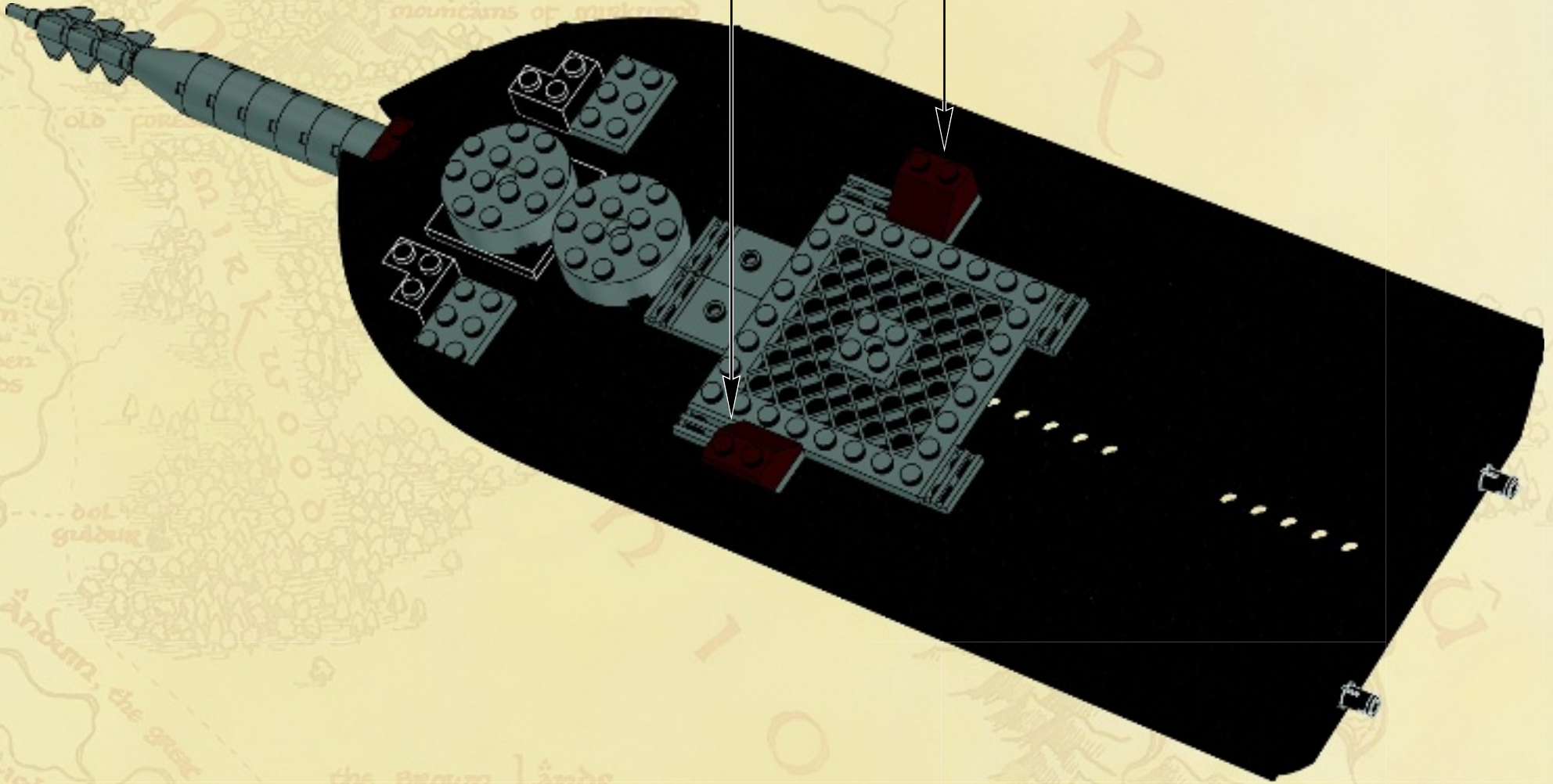

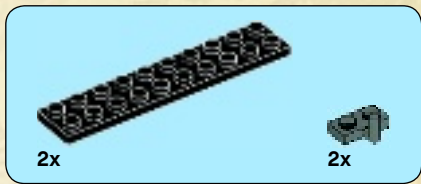

12

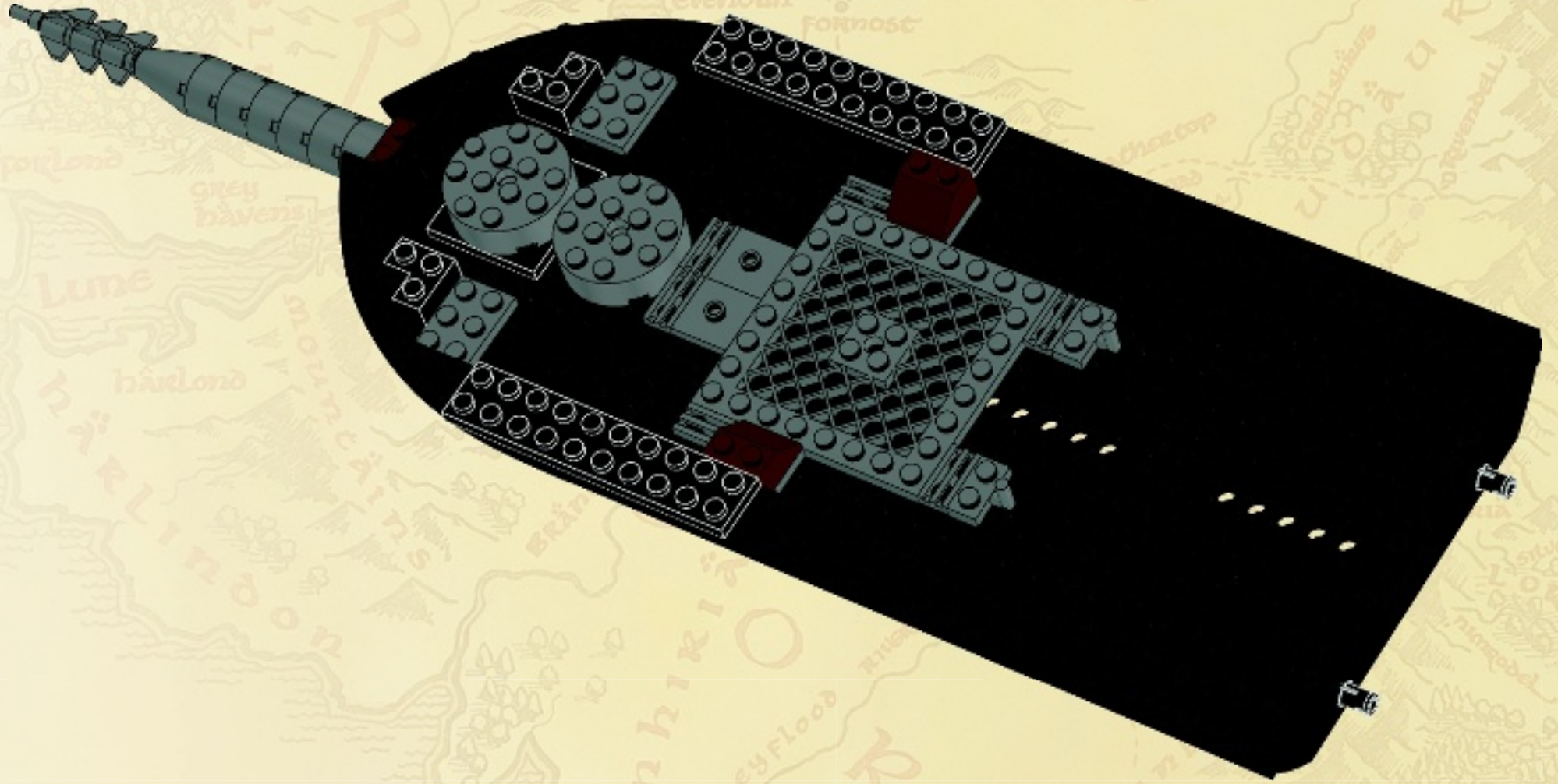



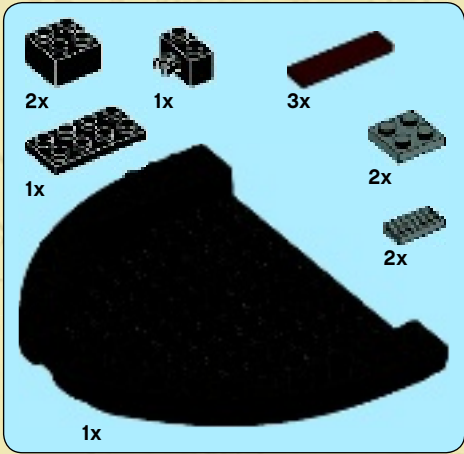

13



4



5

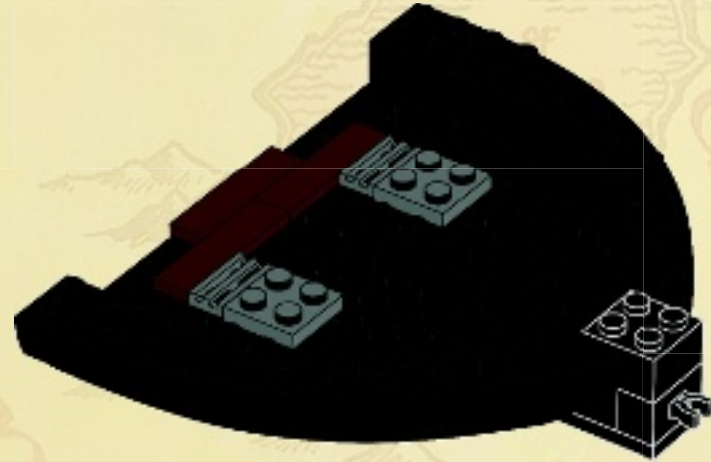

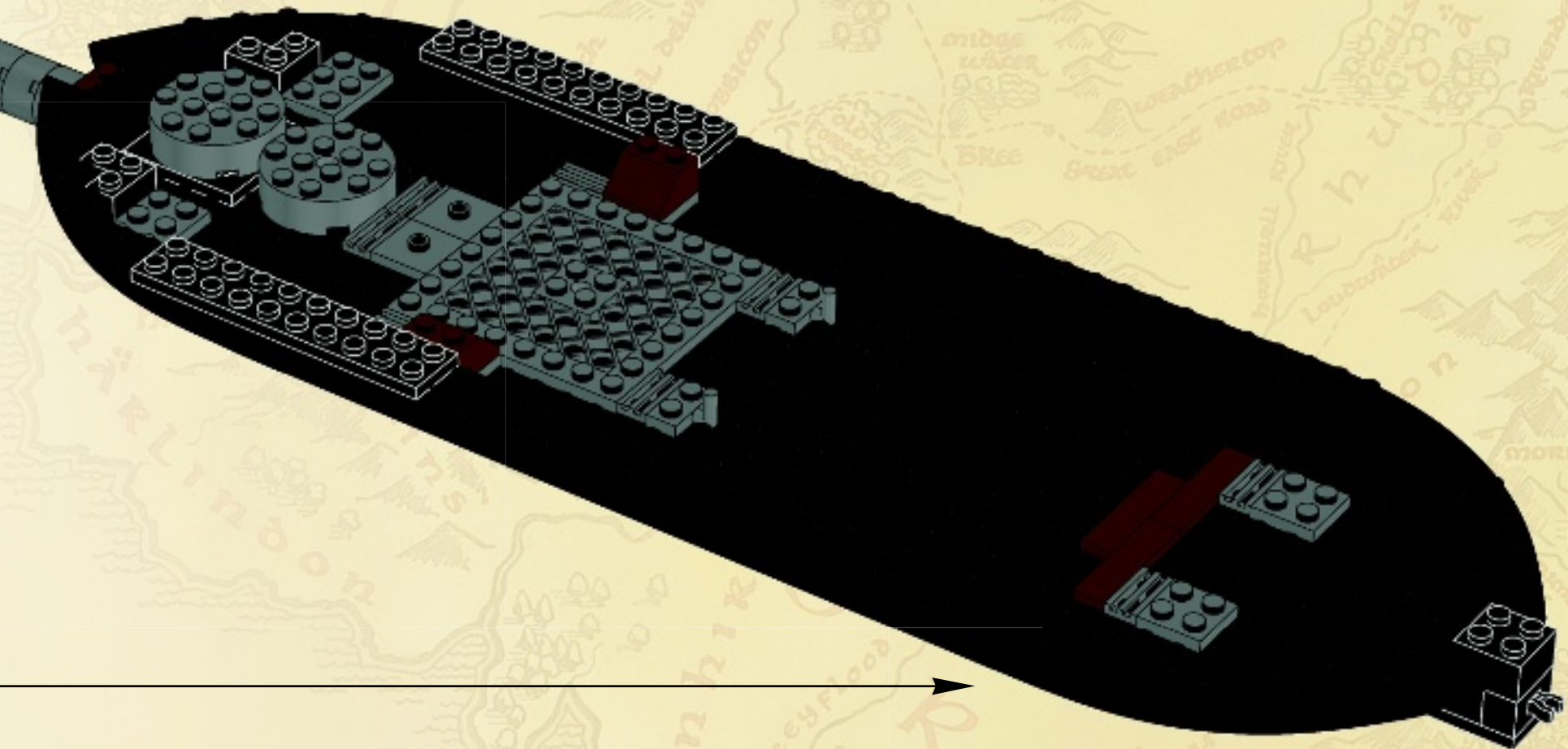
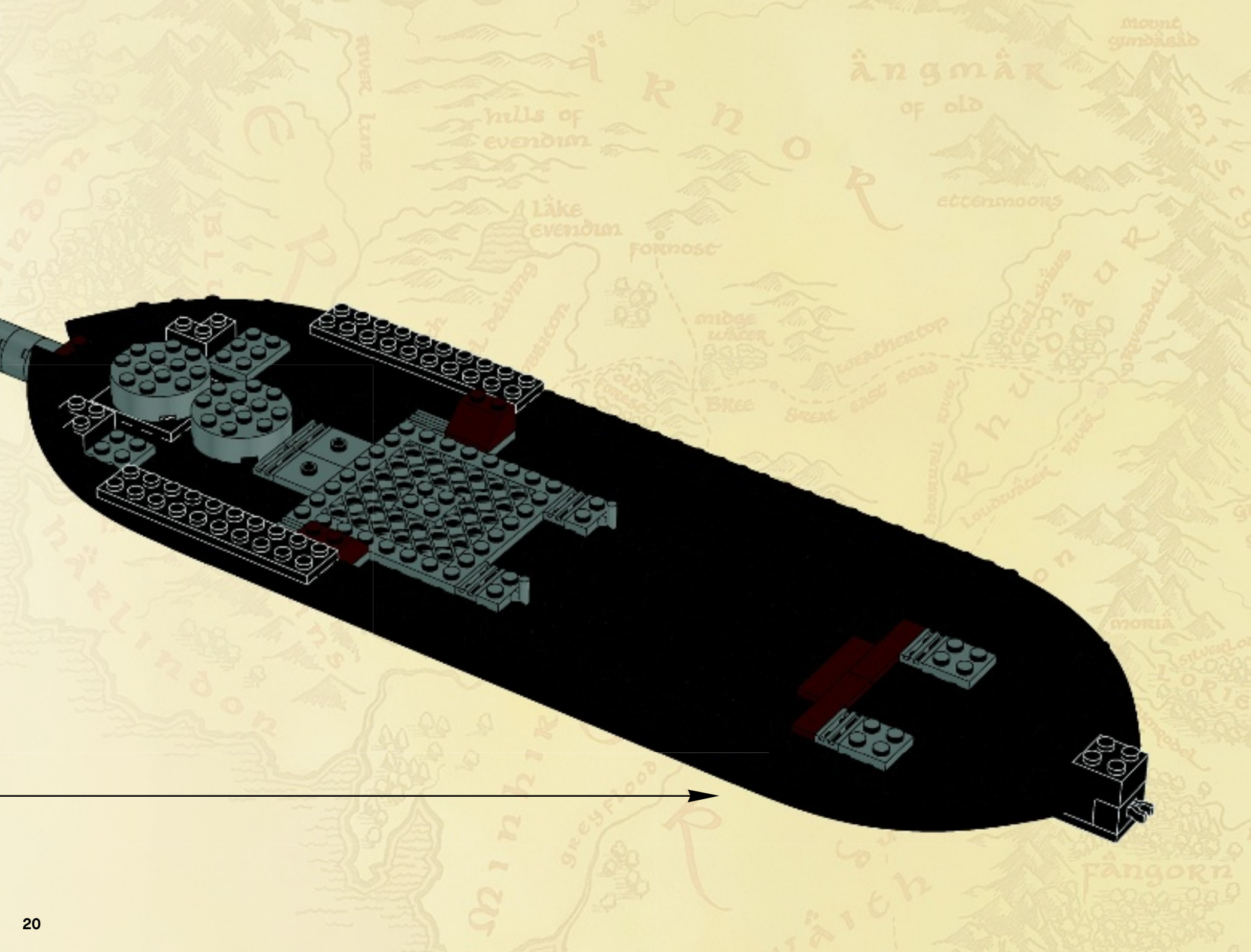



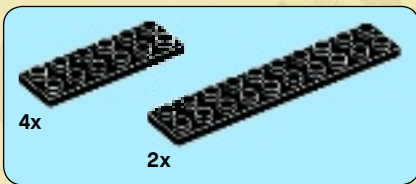

14

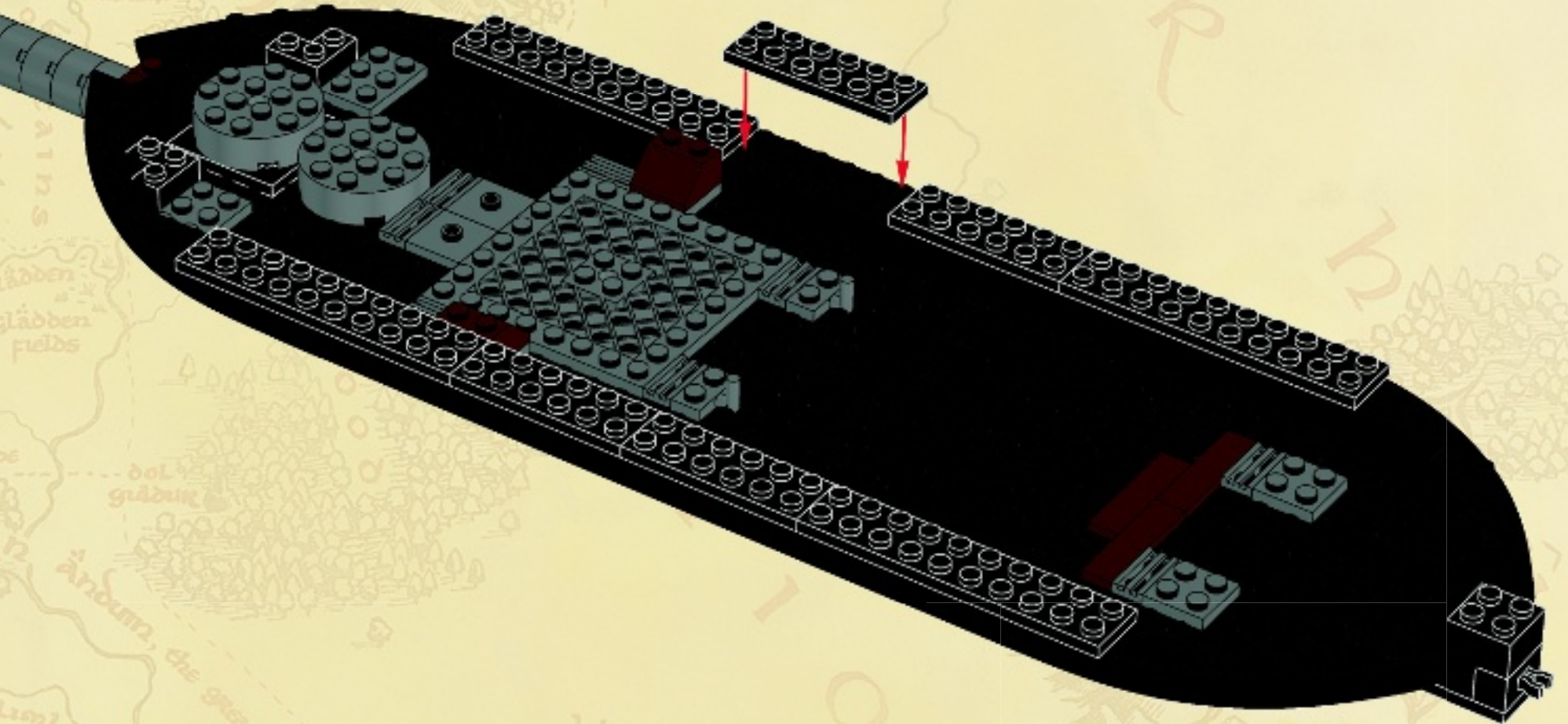



10x

15

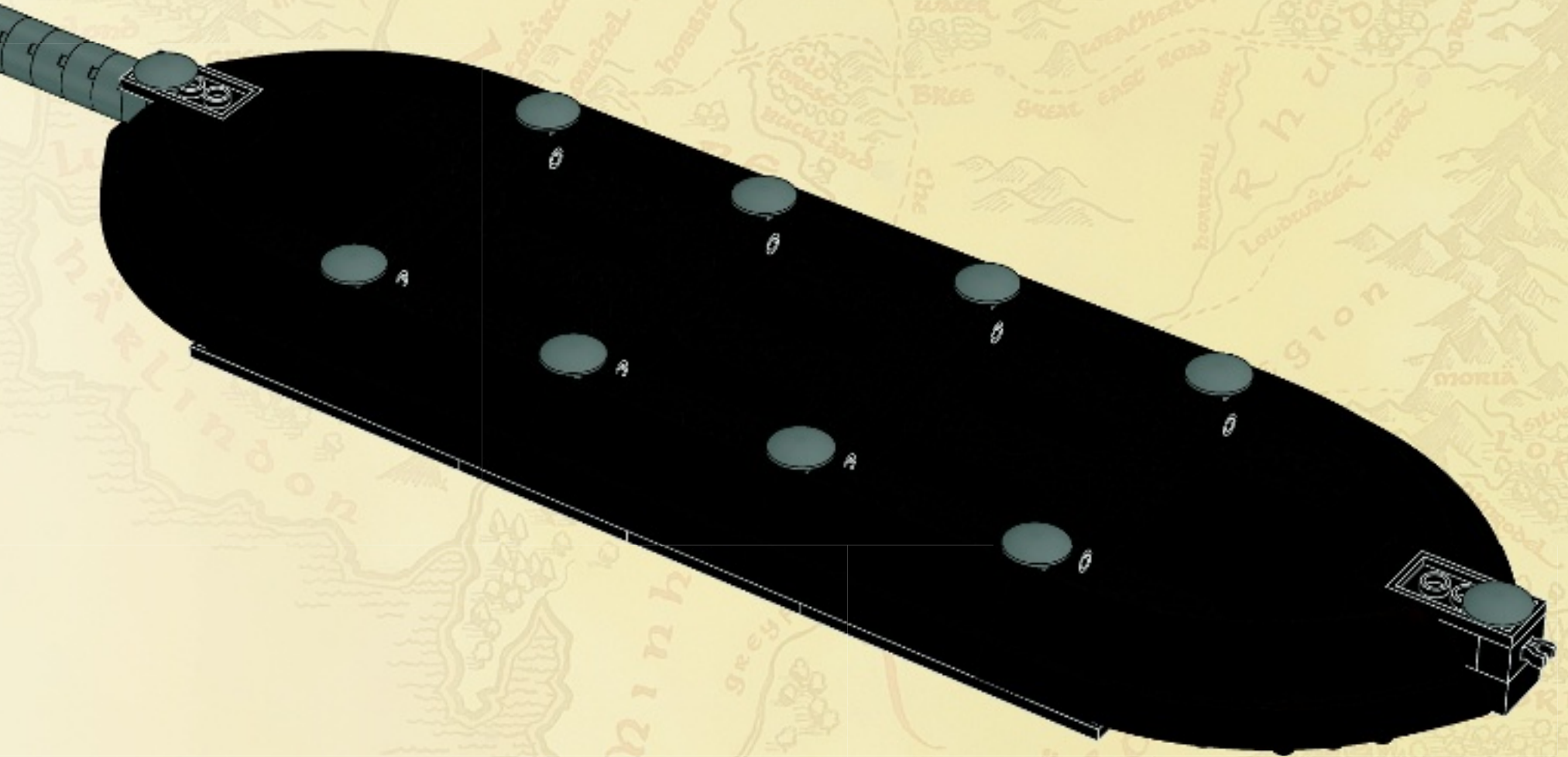



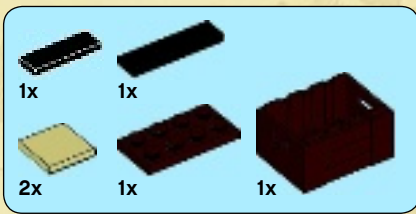

16

1

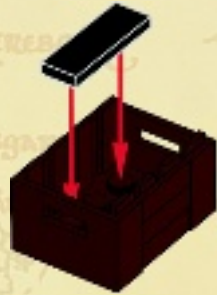

2



3

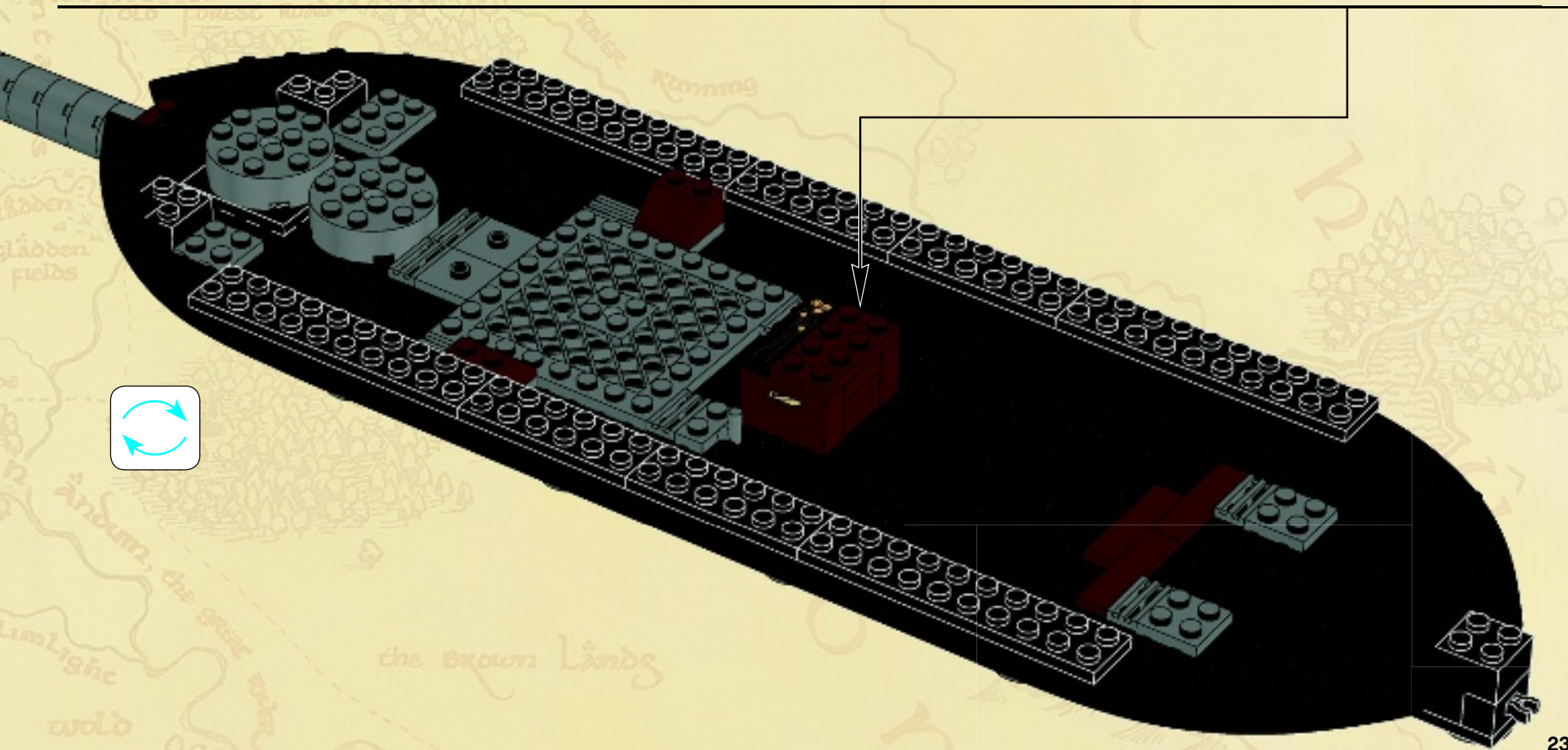

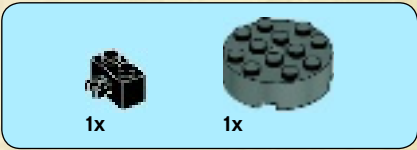

17

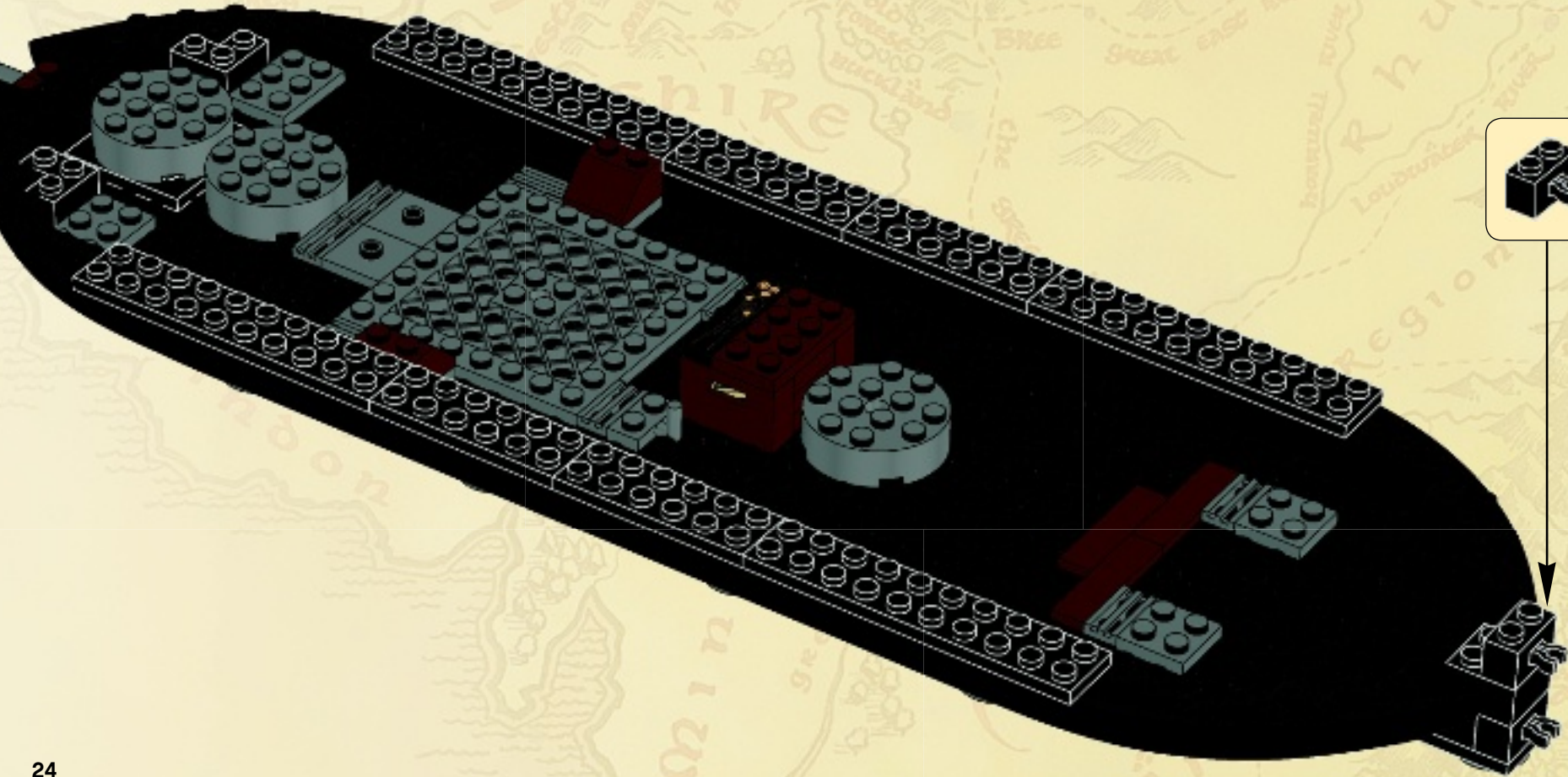



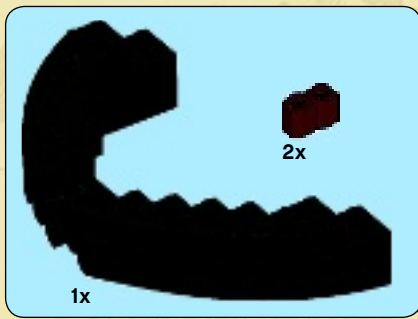

18

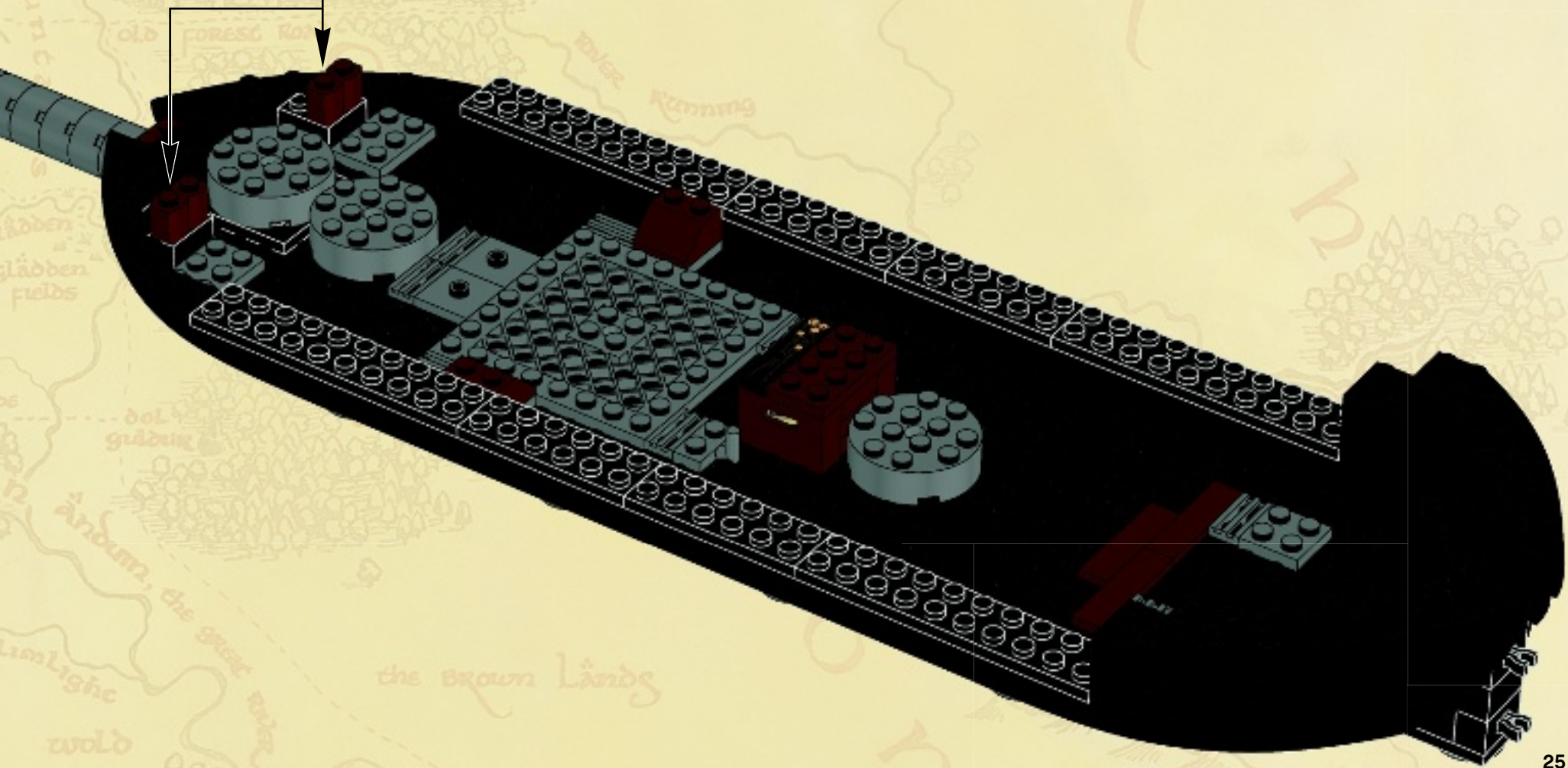

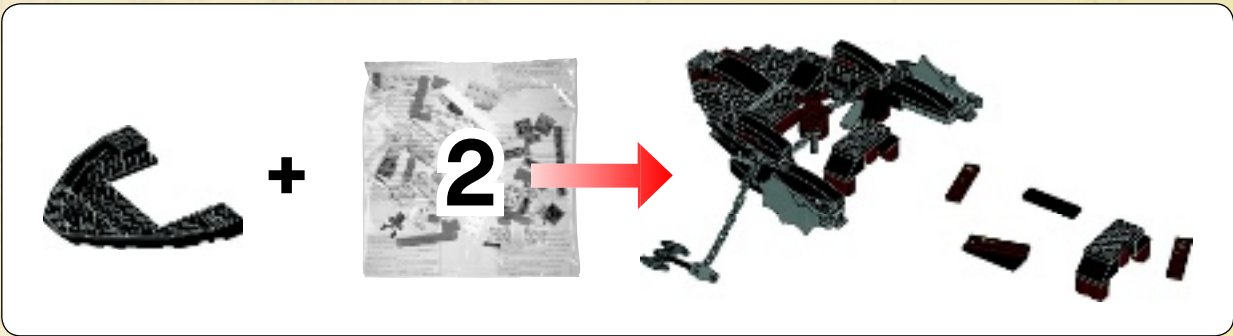

19

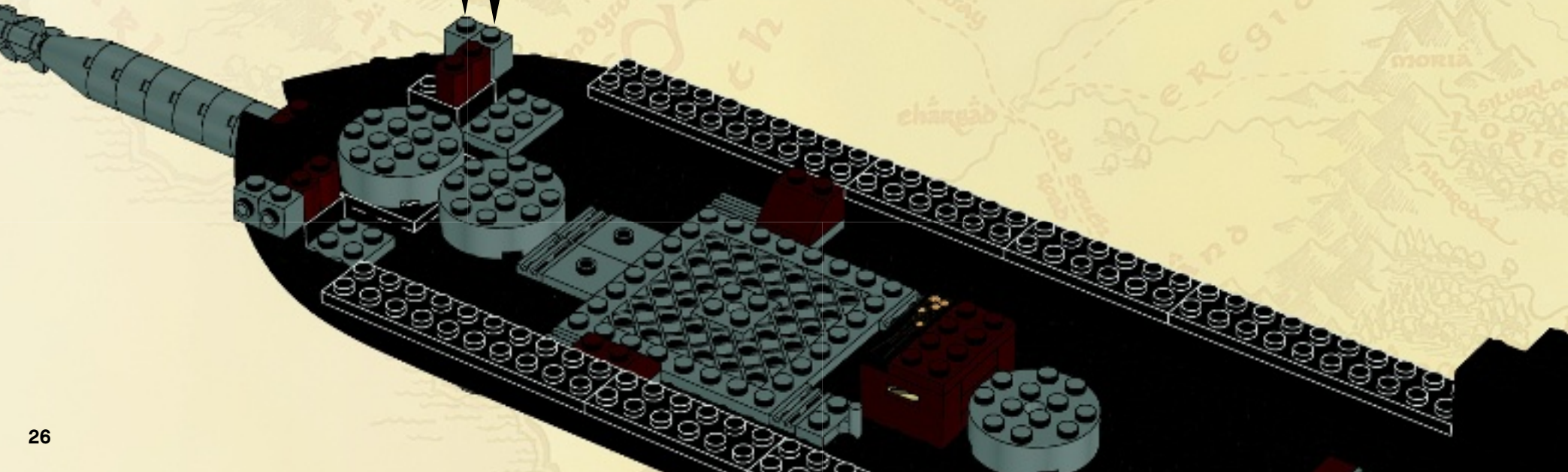
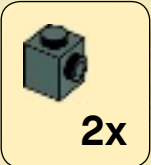





20

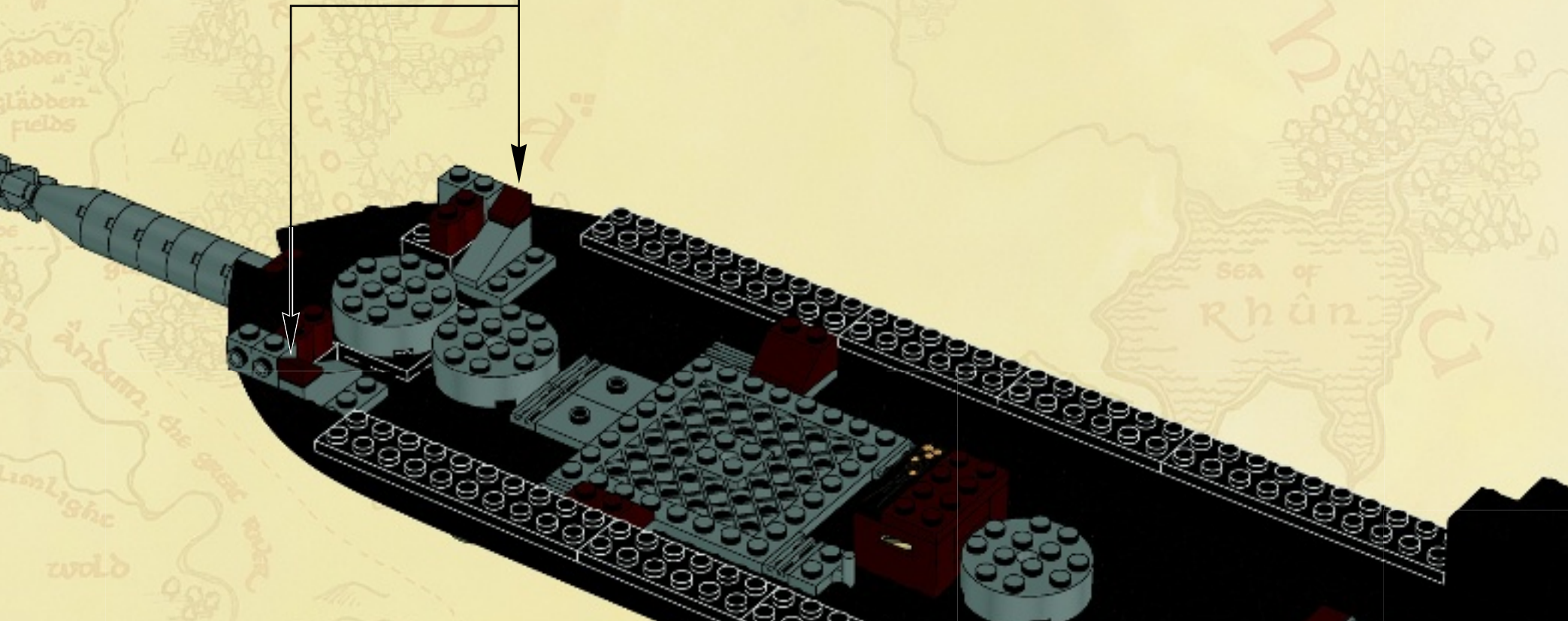
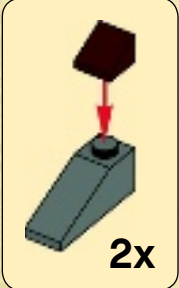



# 21

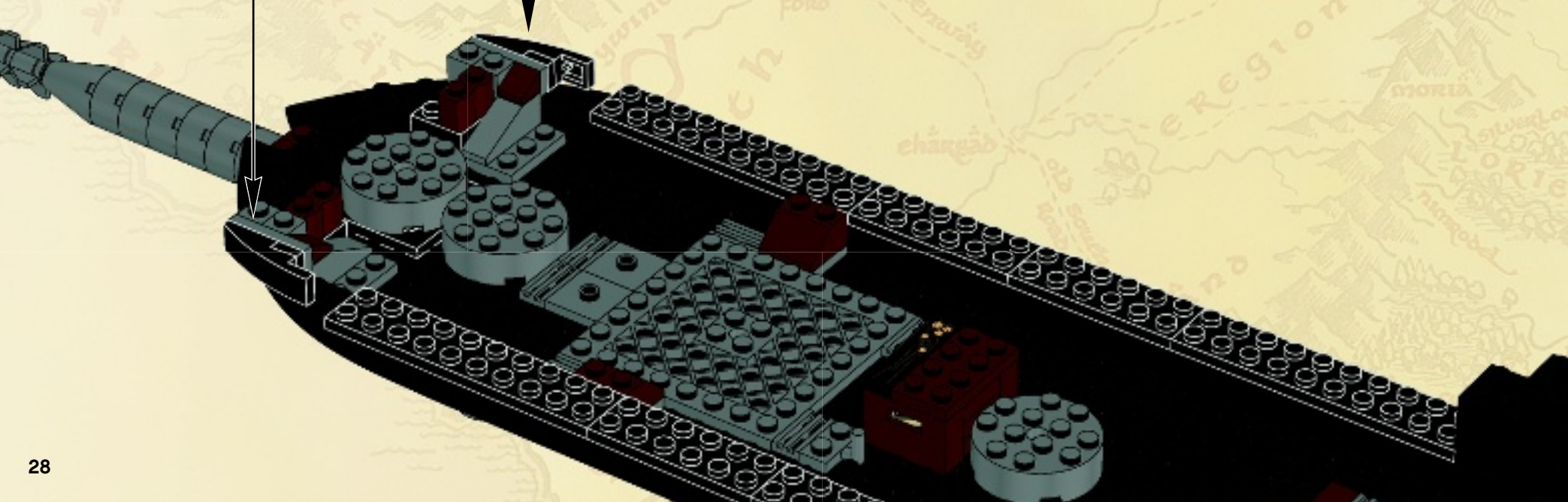
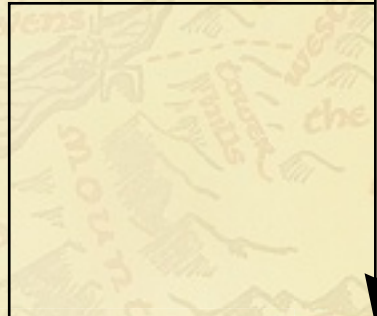
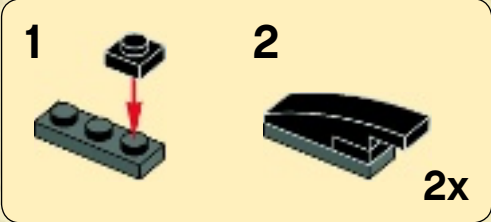





2x

22



2x

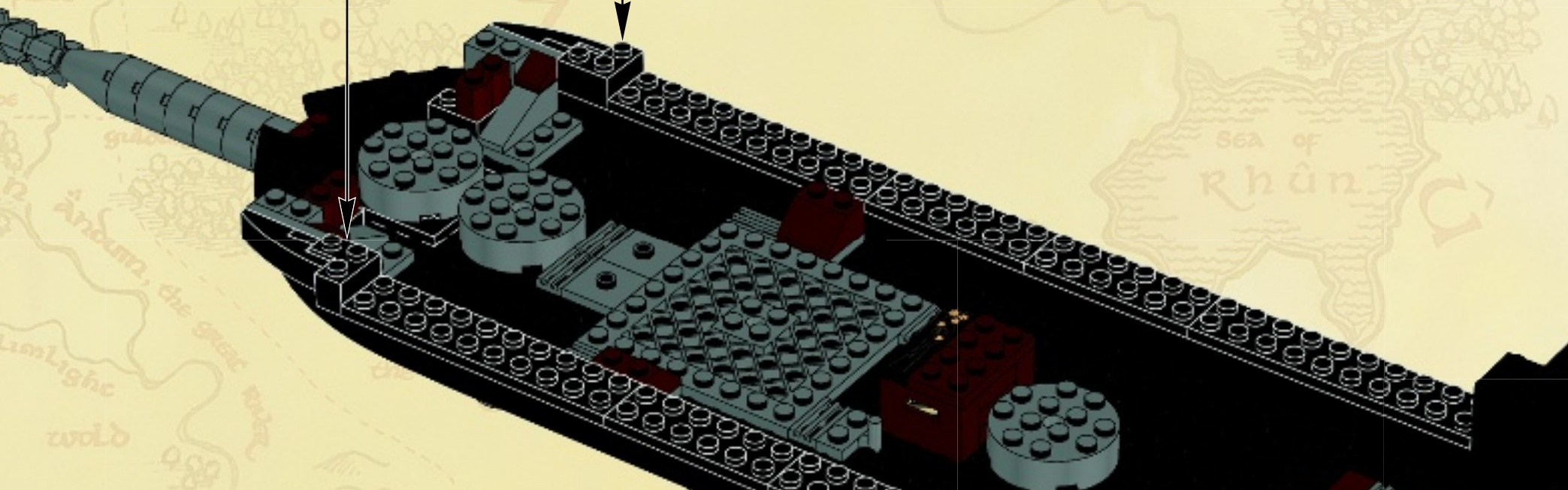



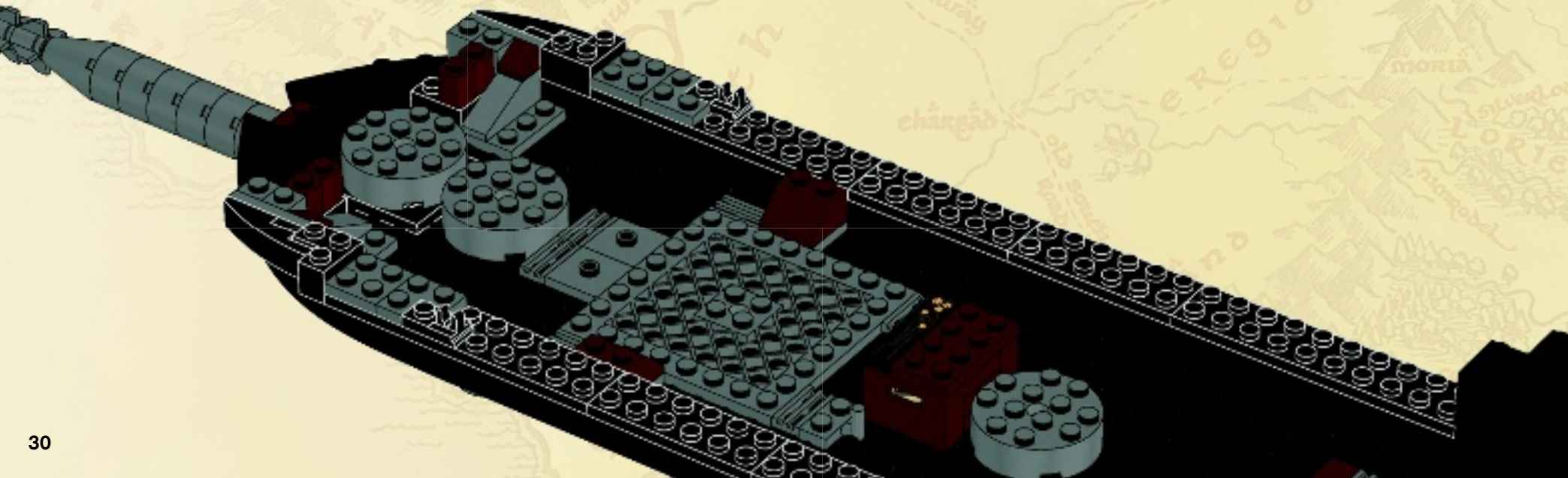

# 23





2x  2x 

24

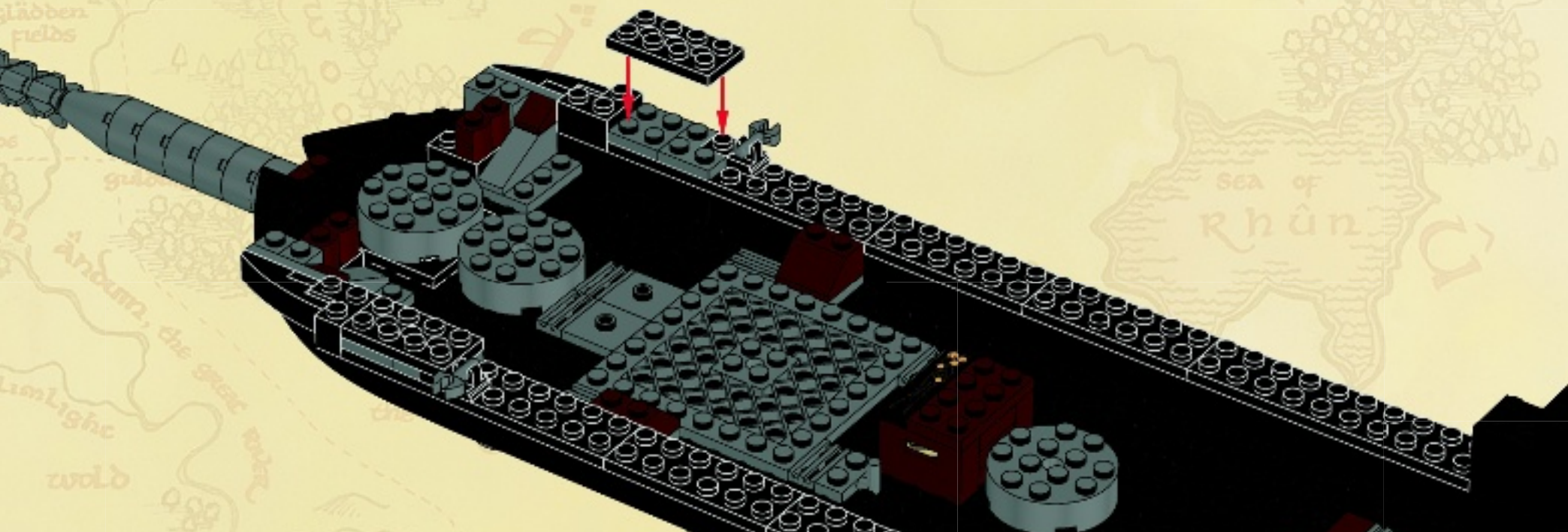

2x  1x 

25

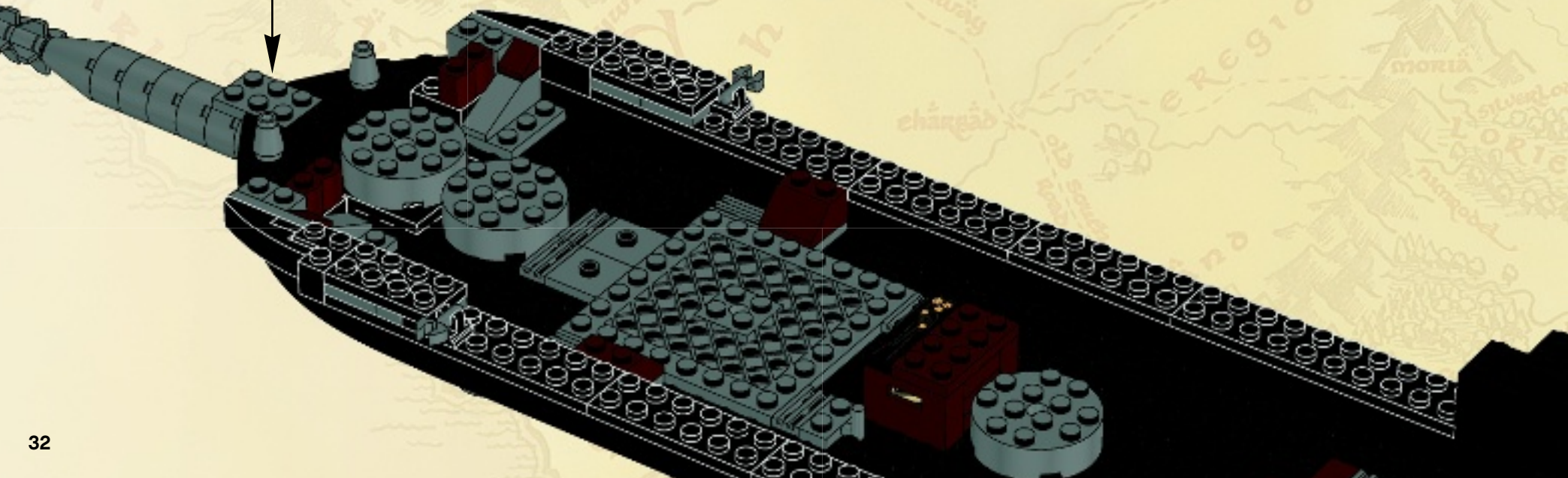



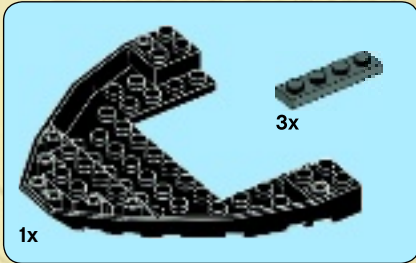

1

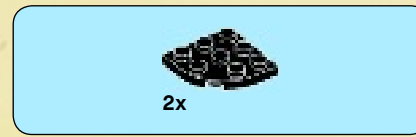
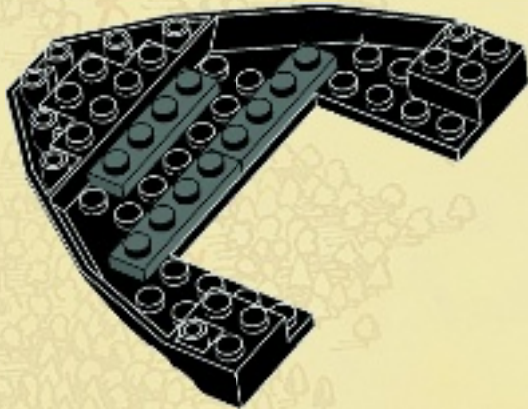

2

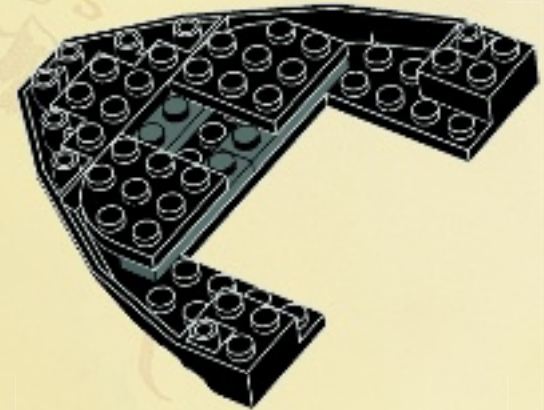

3

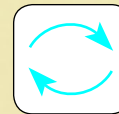

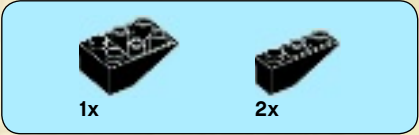

4

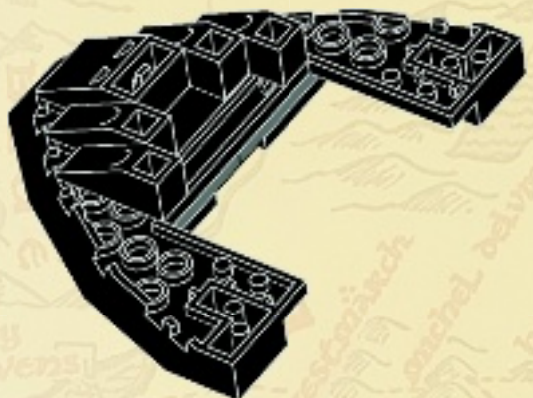

5

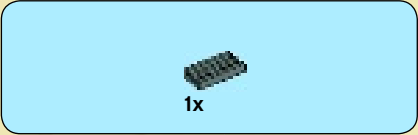
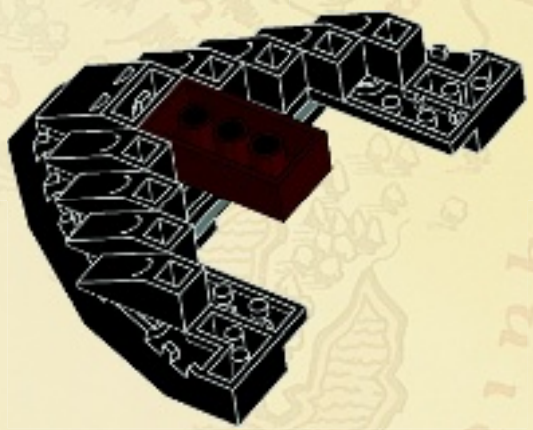

6

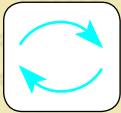

7

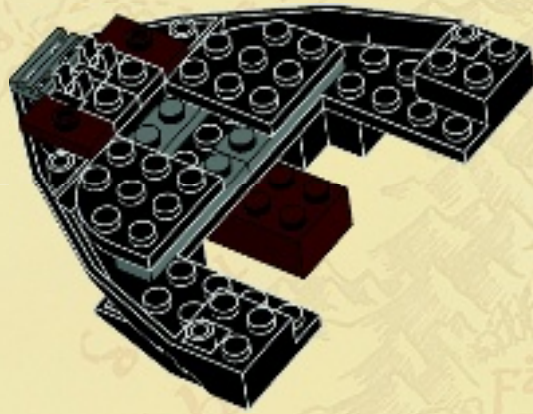





8

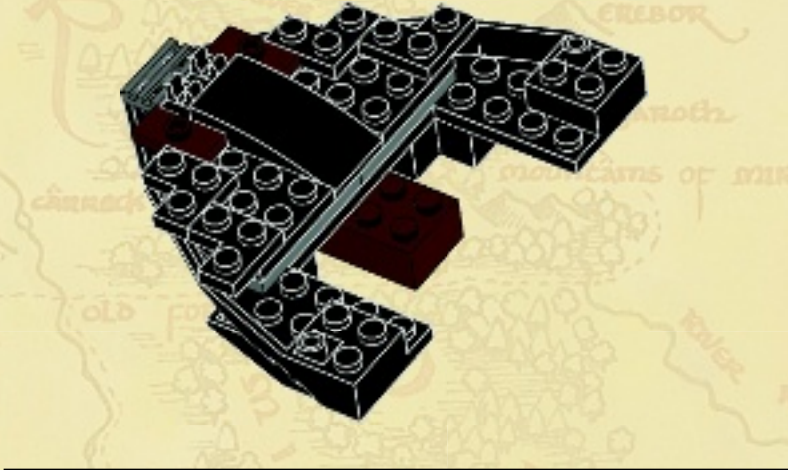

26

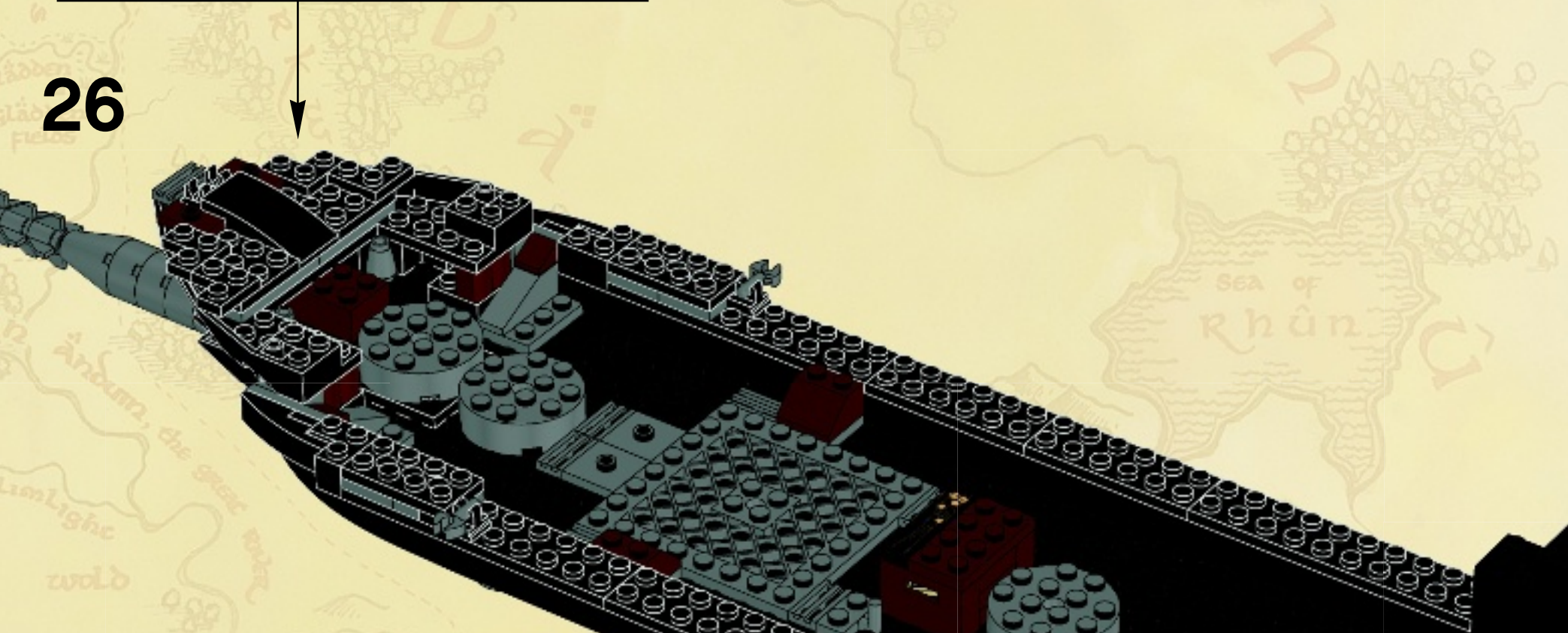



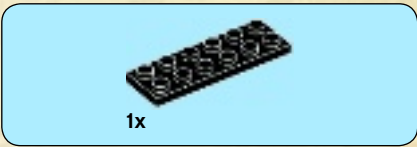

27

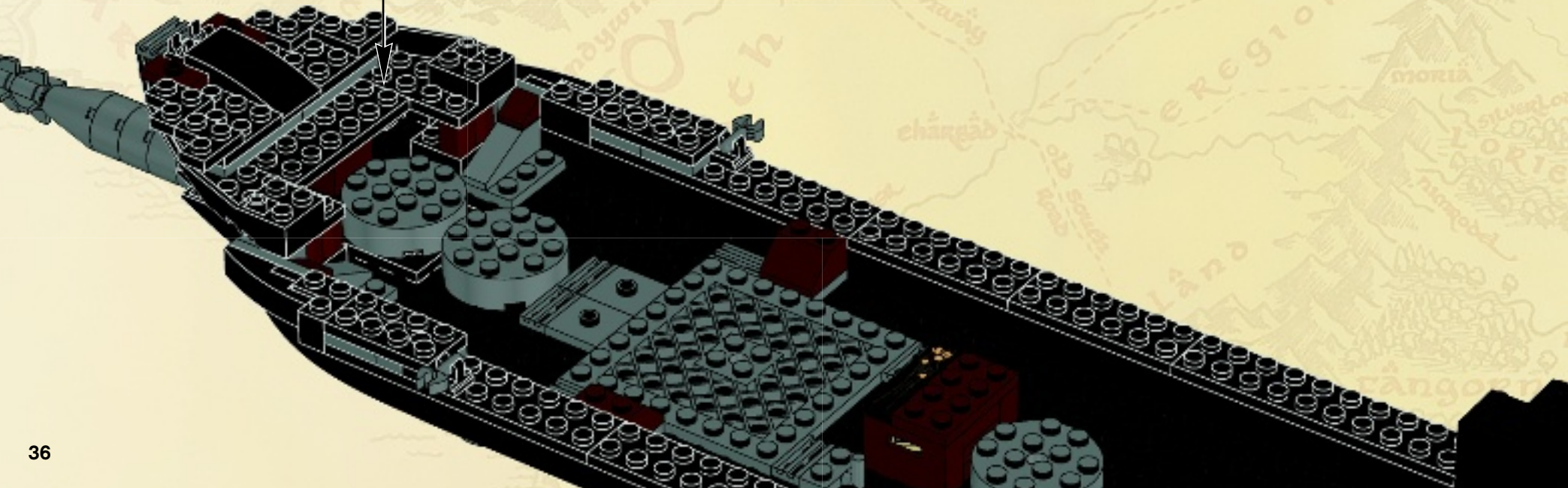





28

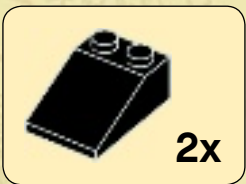

withered heath

IRON HILLS

EREBOR

esganoth

mountains of mirkwood

cinnaith

old forest road

river running

SEA OF RHUN

Anduin, the great river

Limlight

wold

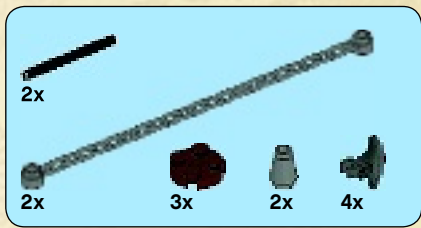

29

1



2

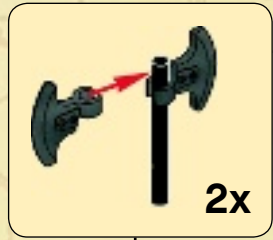

3

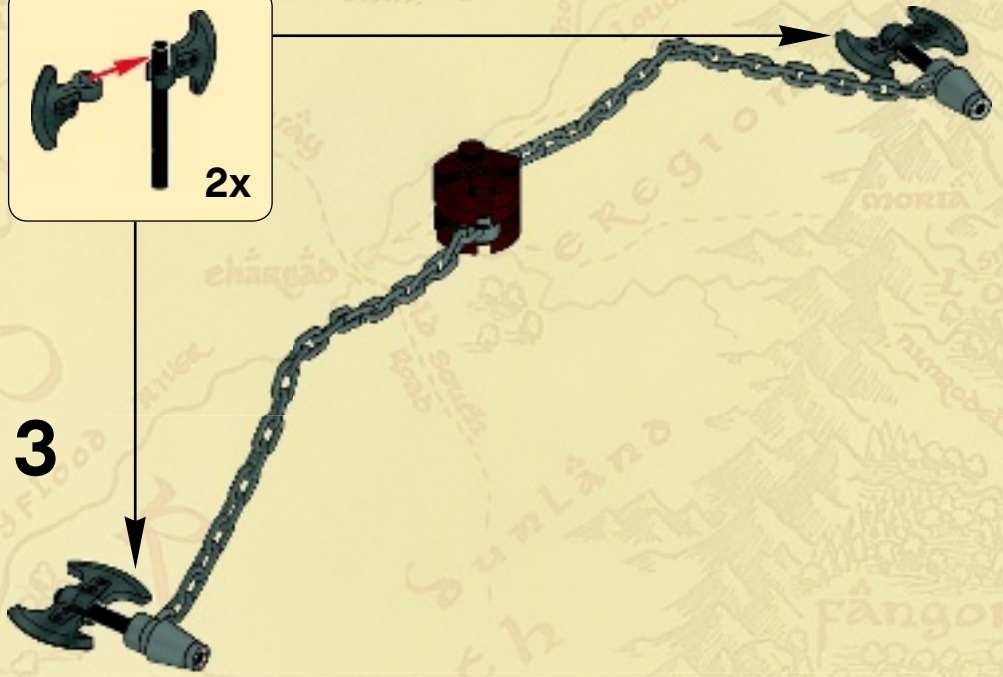



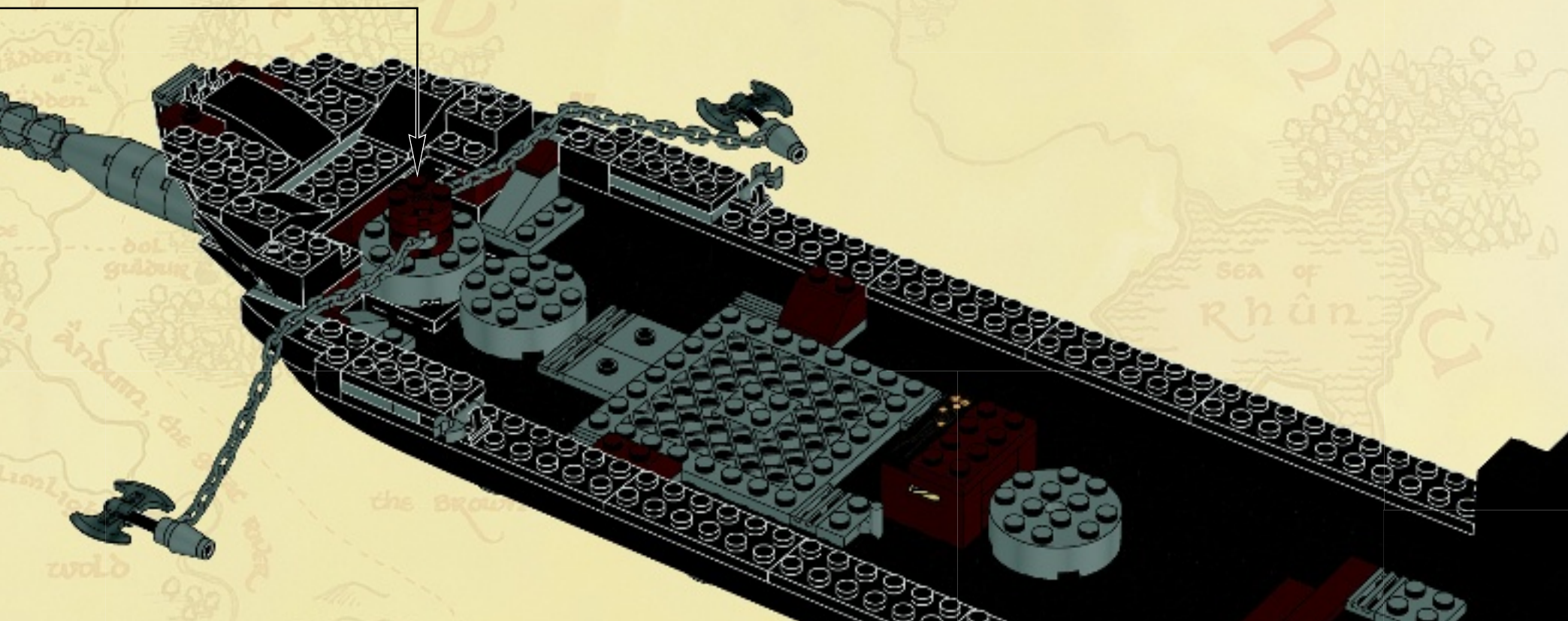
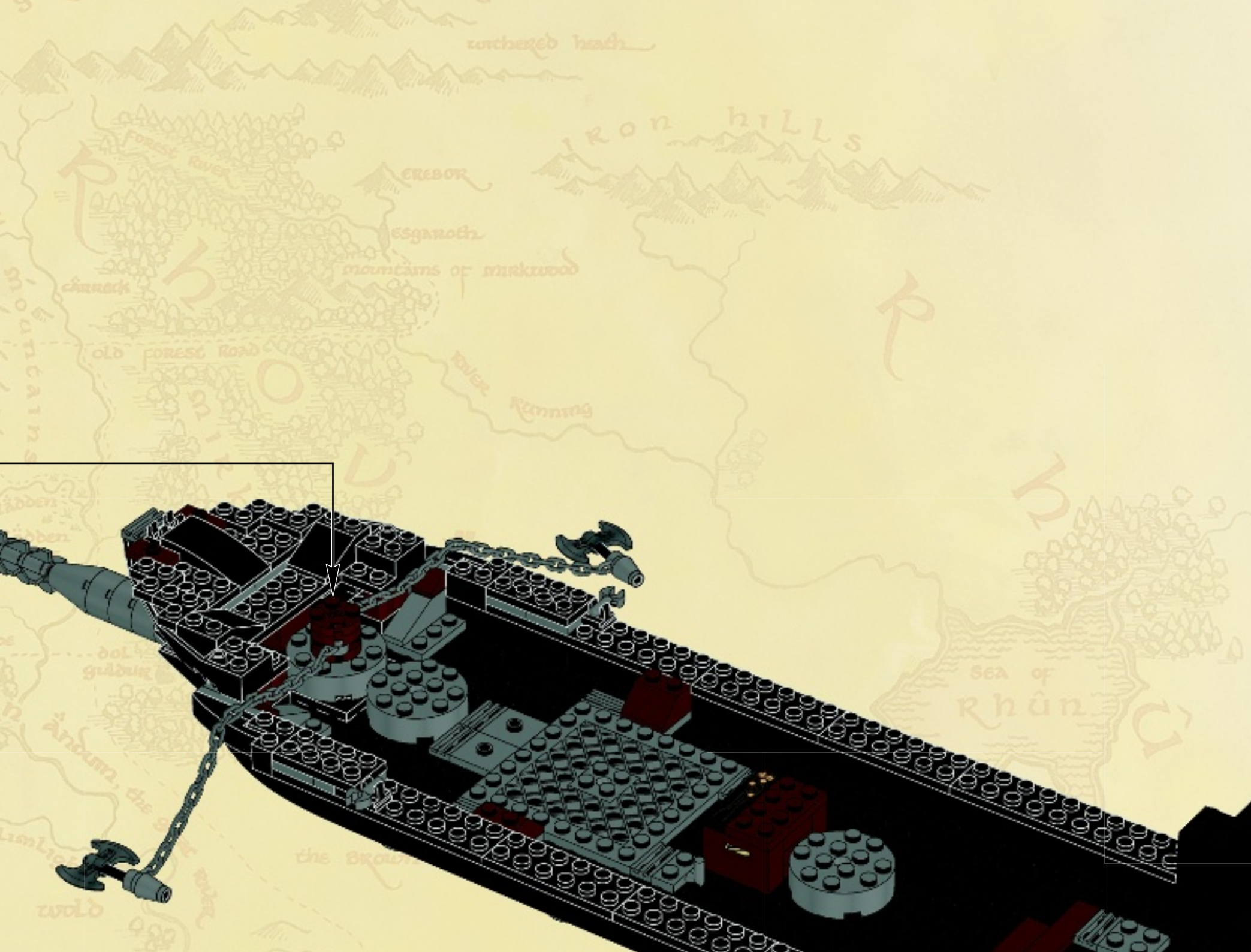



1x  4  1x

 4 **1:1**

30

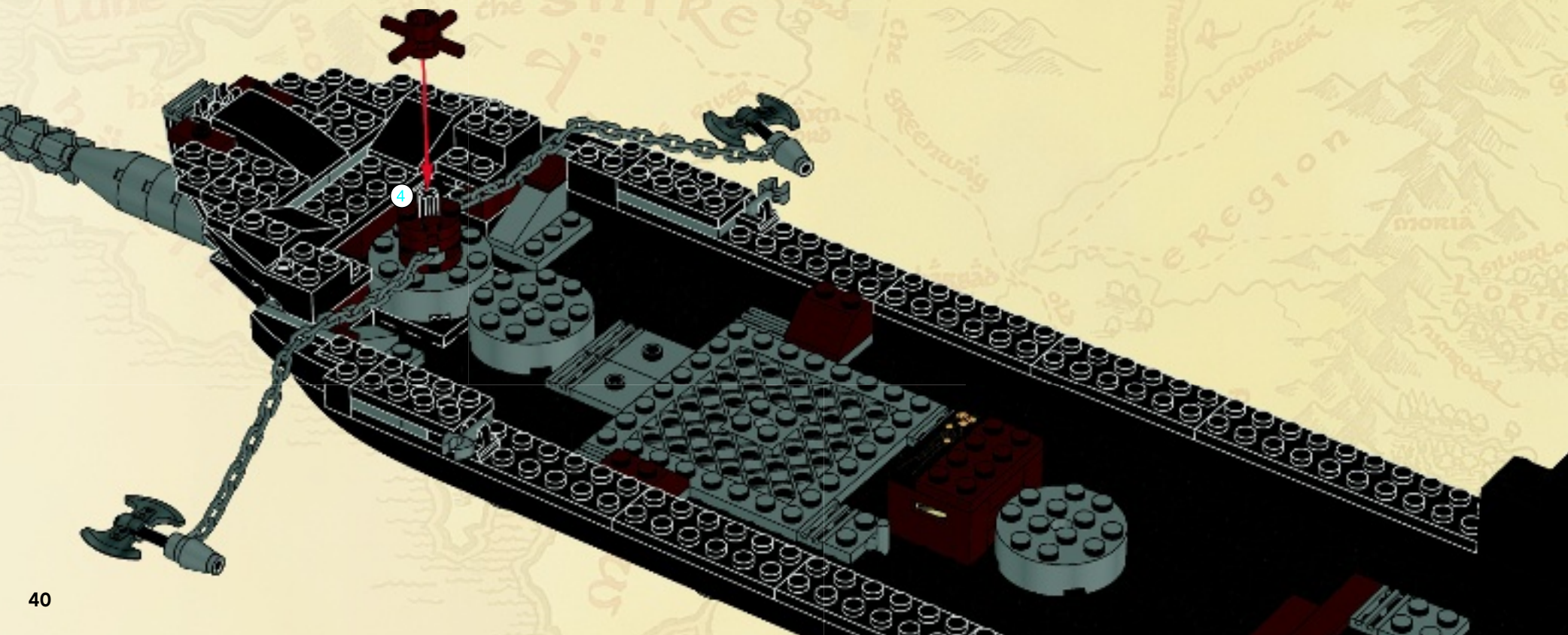





31

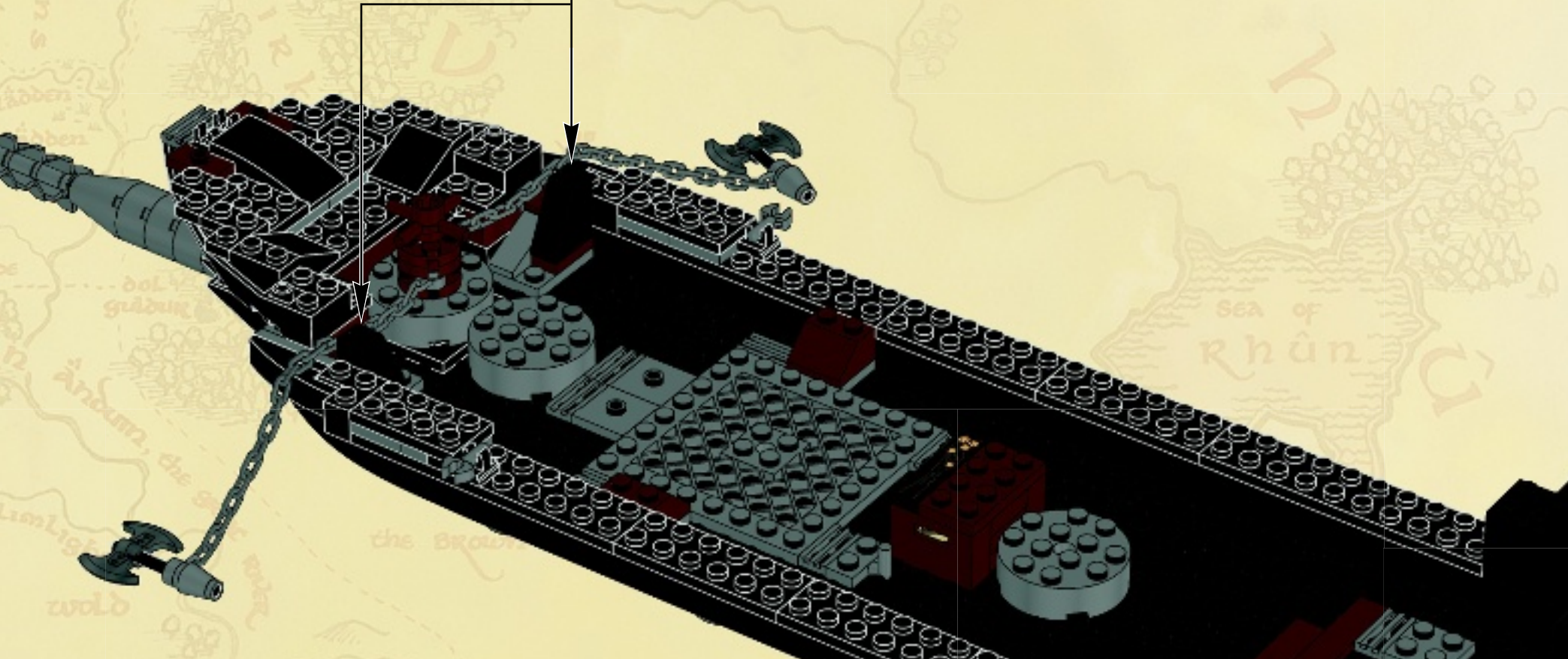



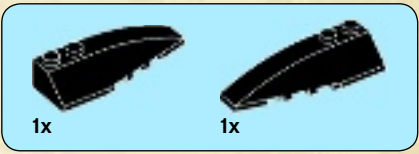

32

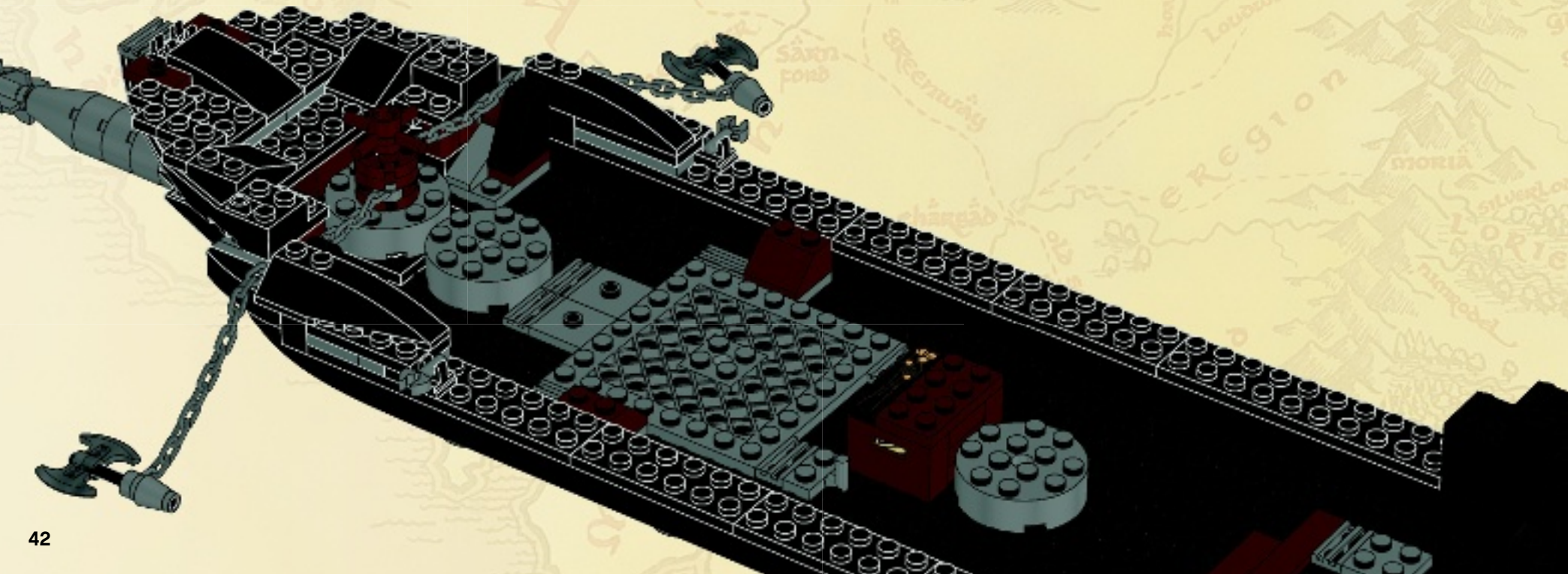





2x

33



2x

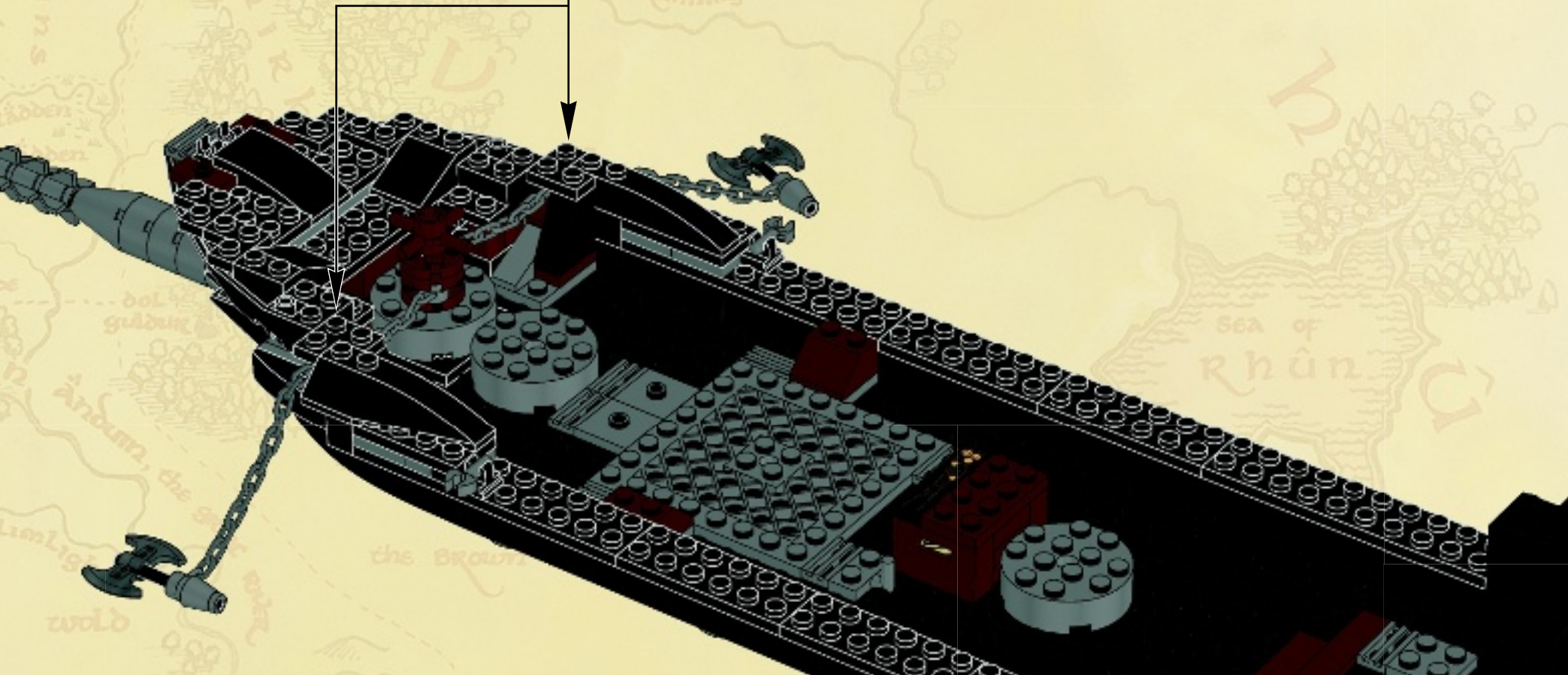





34

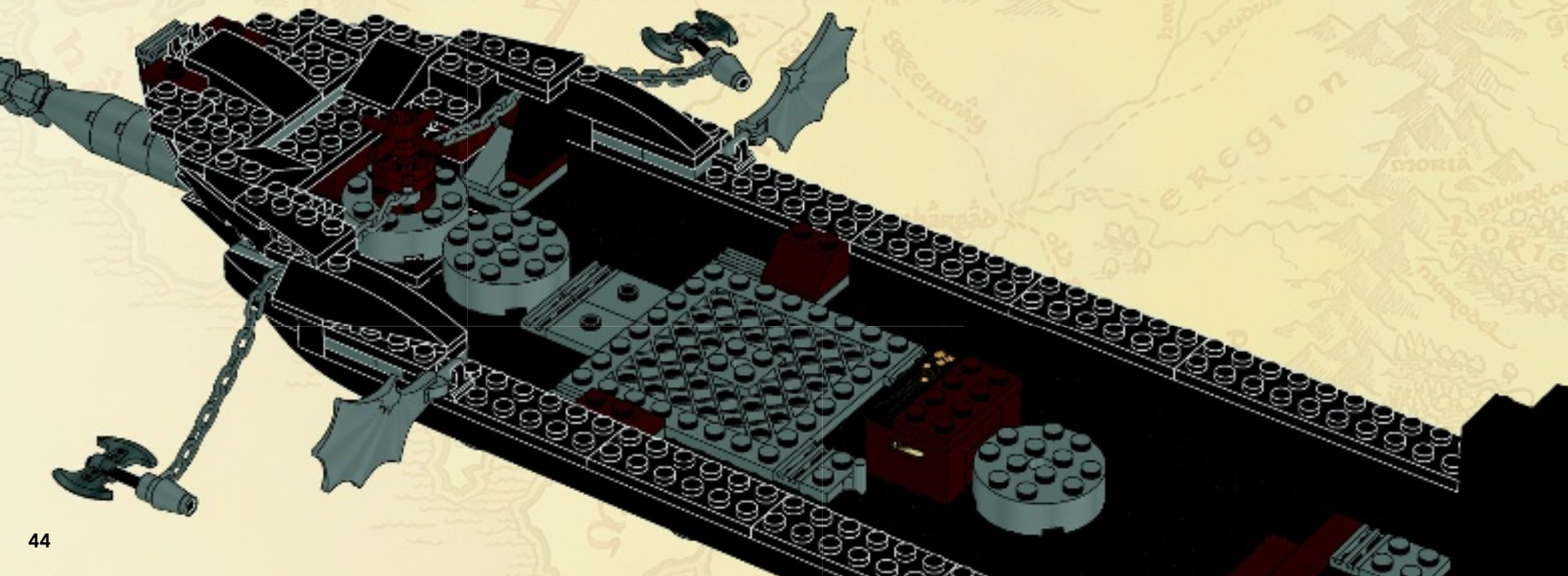



35

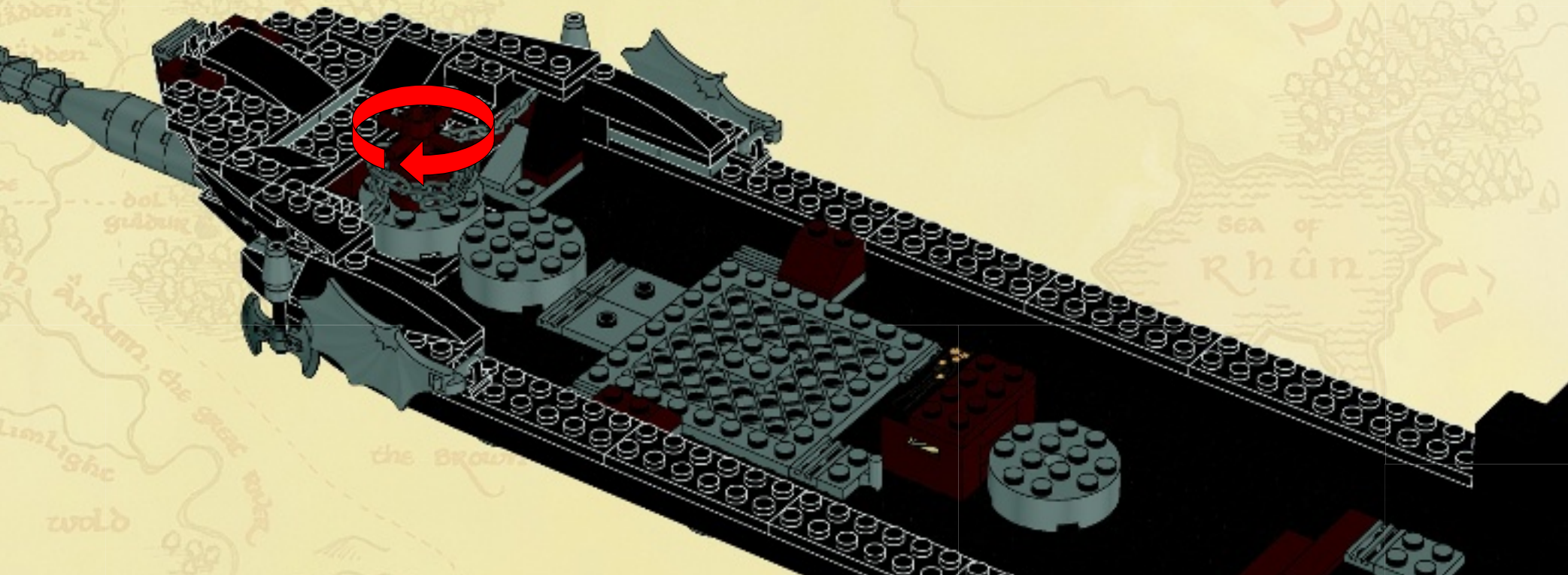

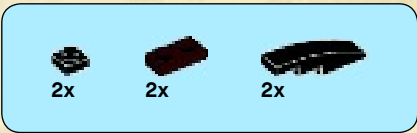

# 36

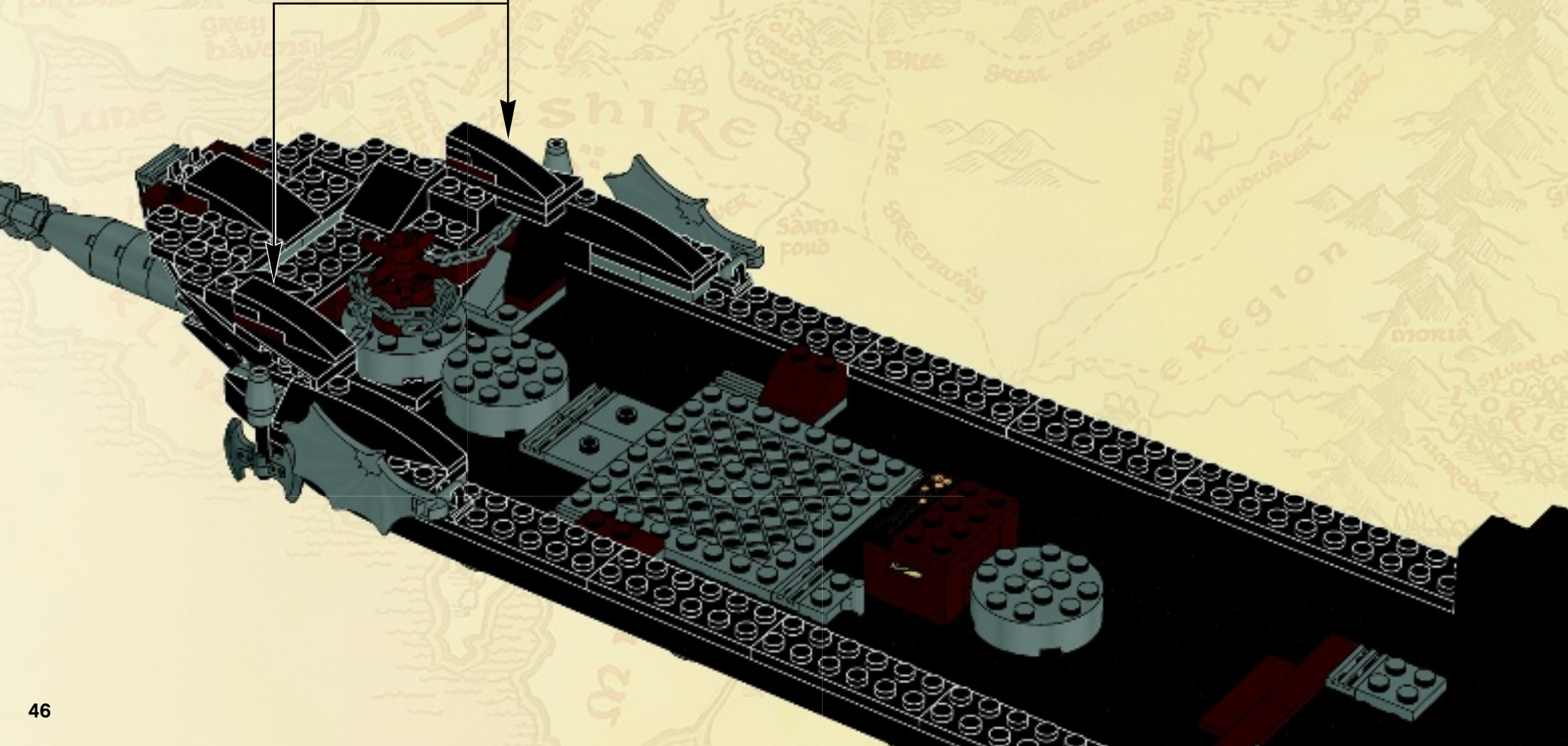
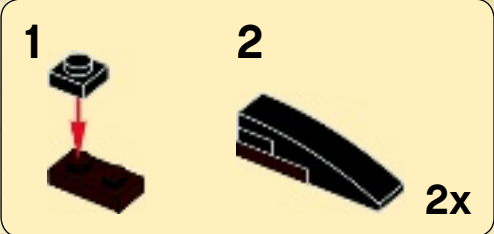



2x 4x

37

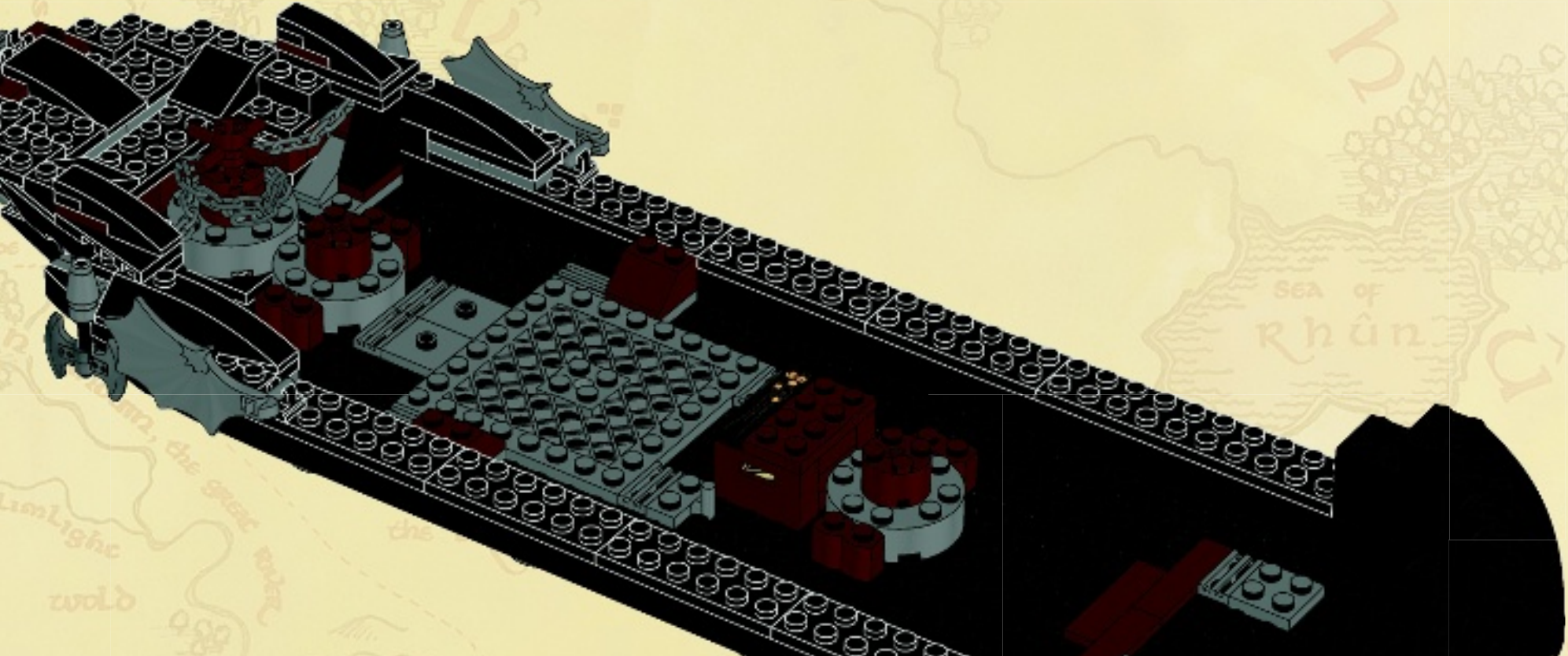







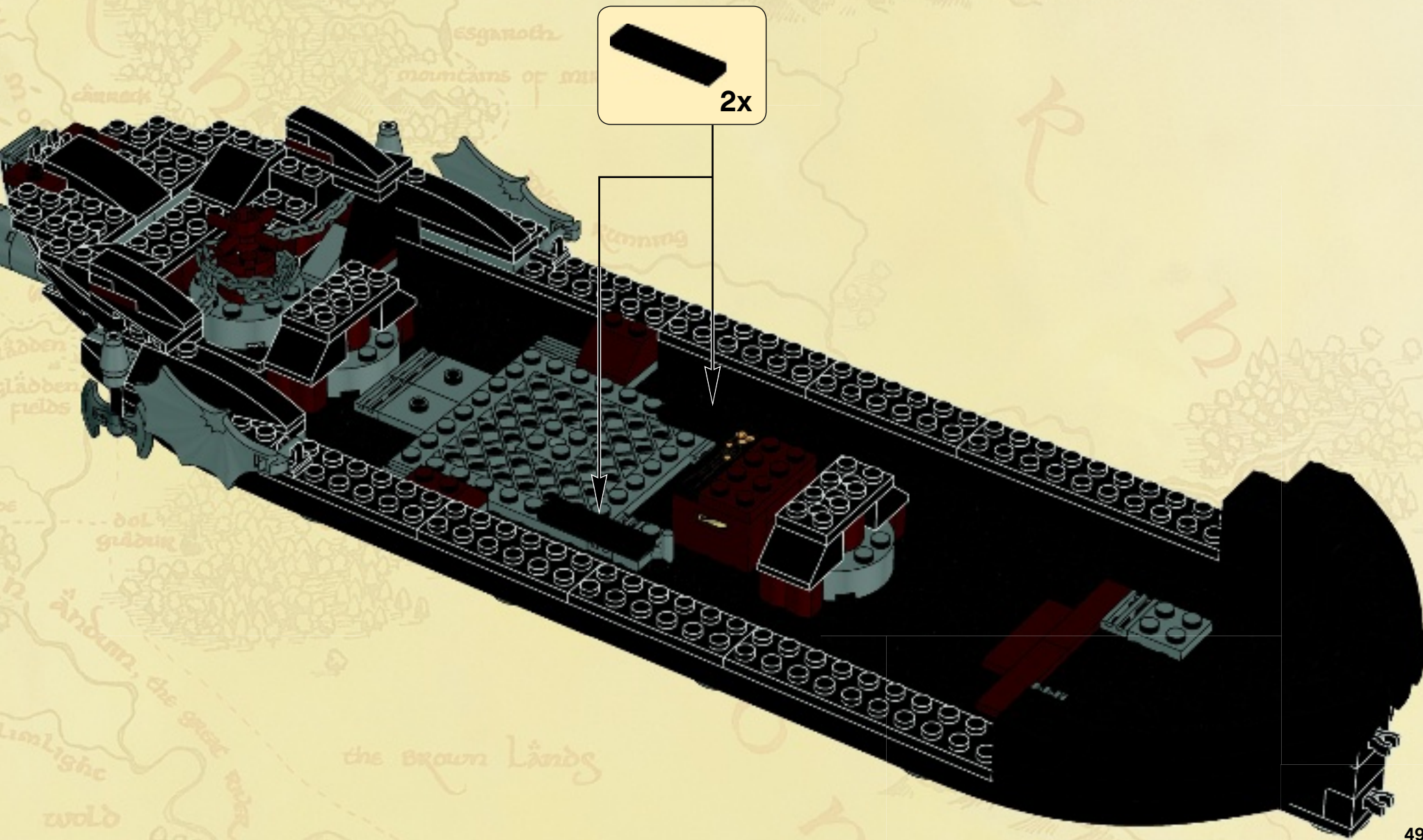

39







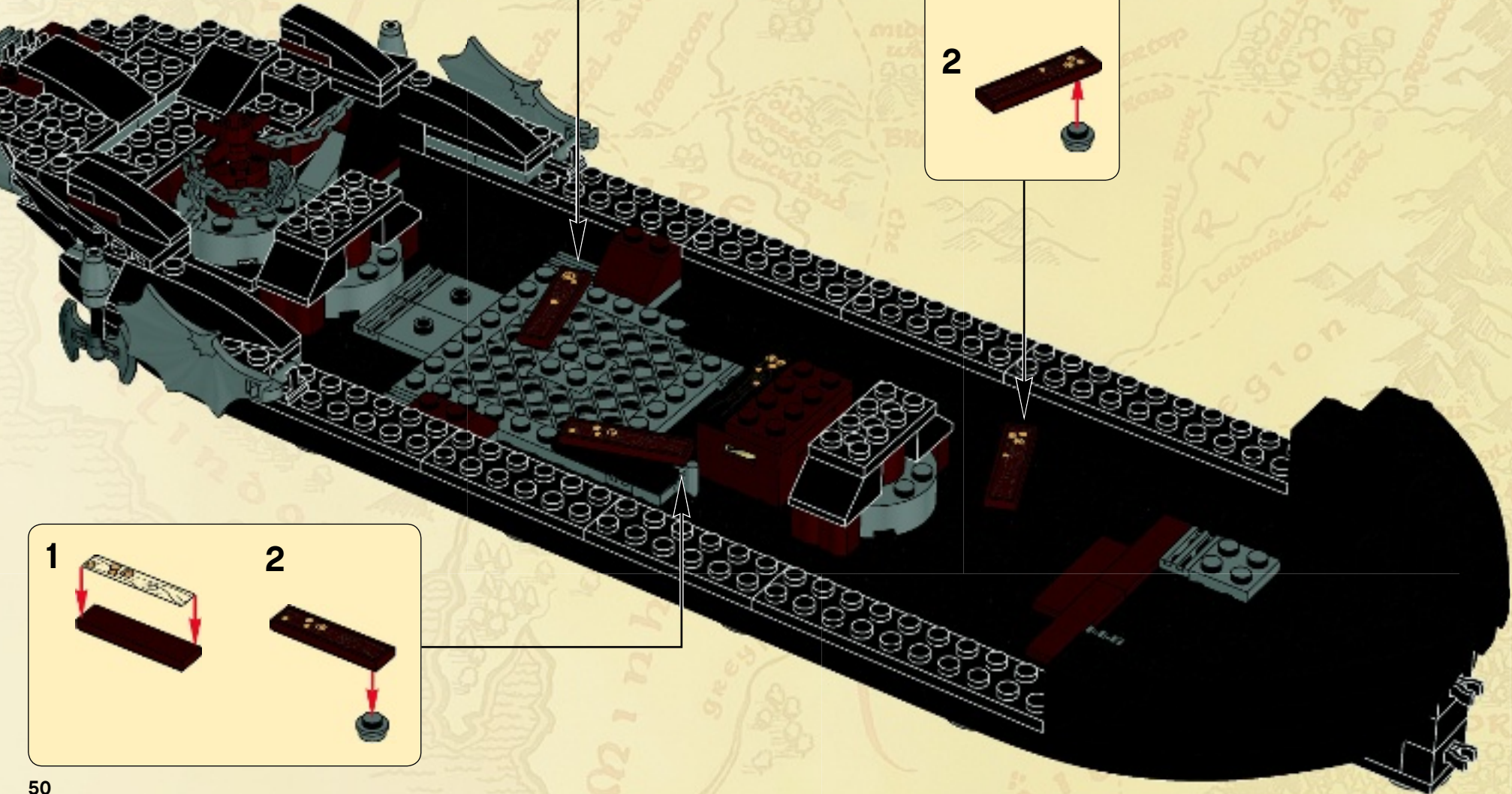

2x  3x 

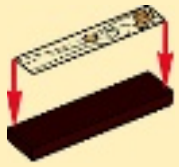
# 40

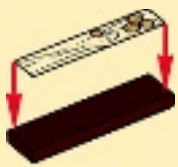

1 

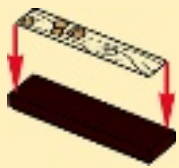
1   
 2 

1   
 2 



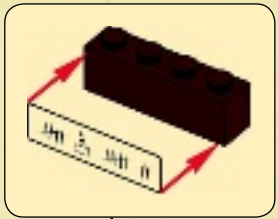
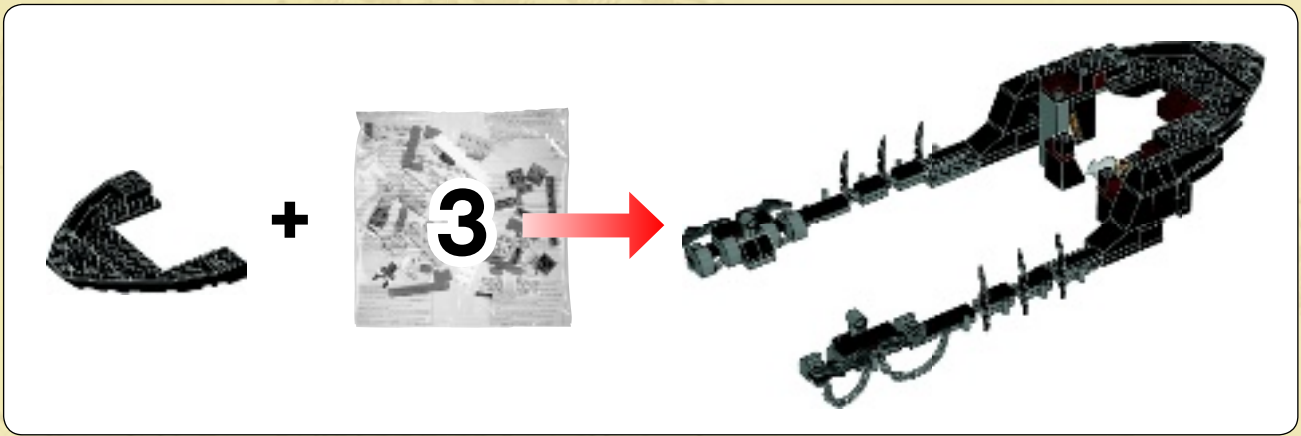

41

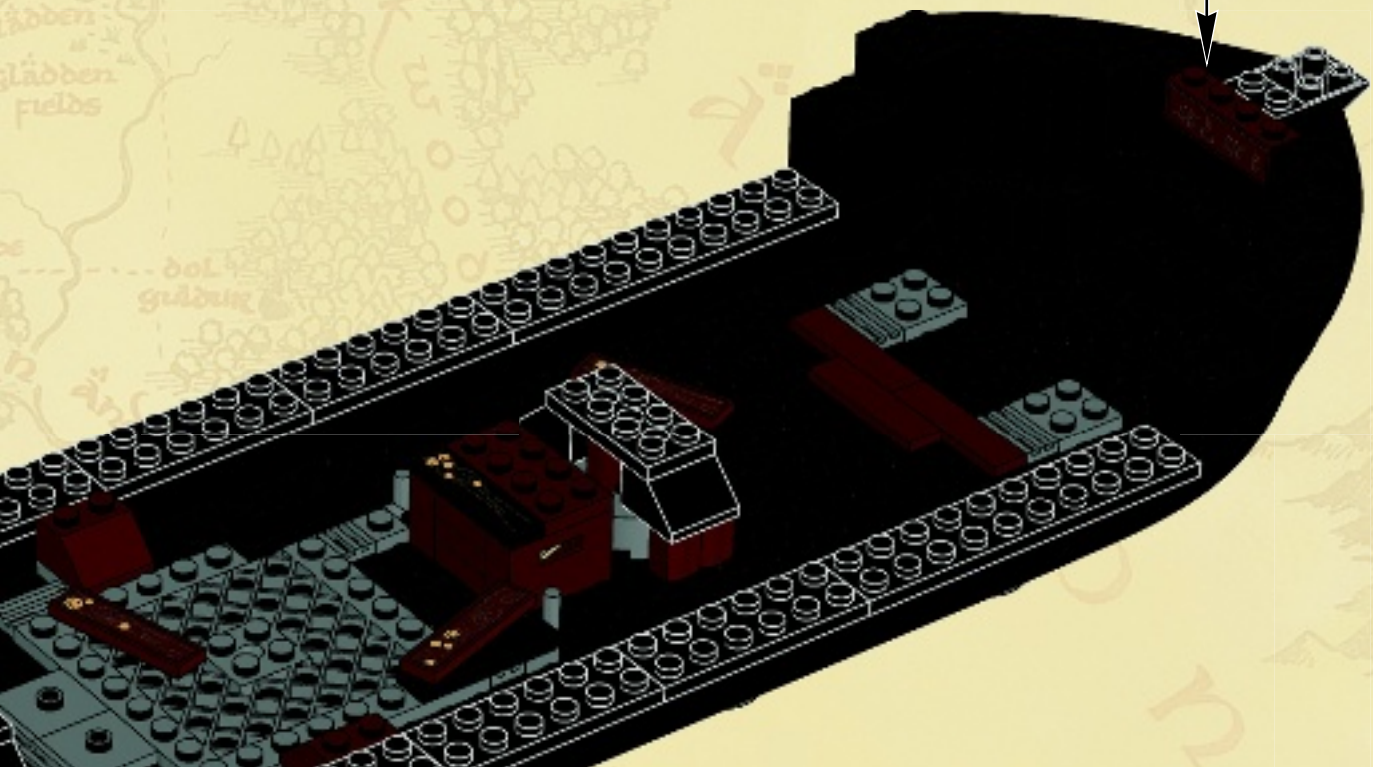



# 42

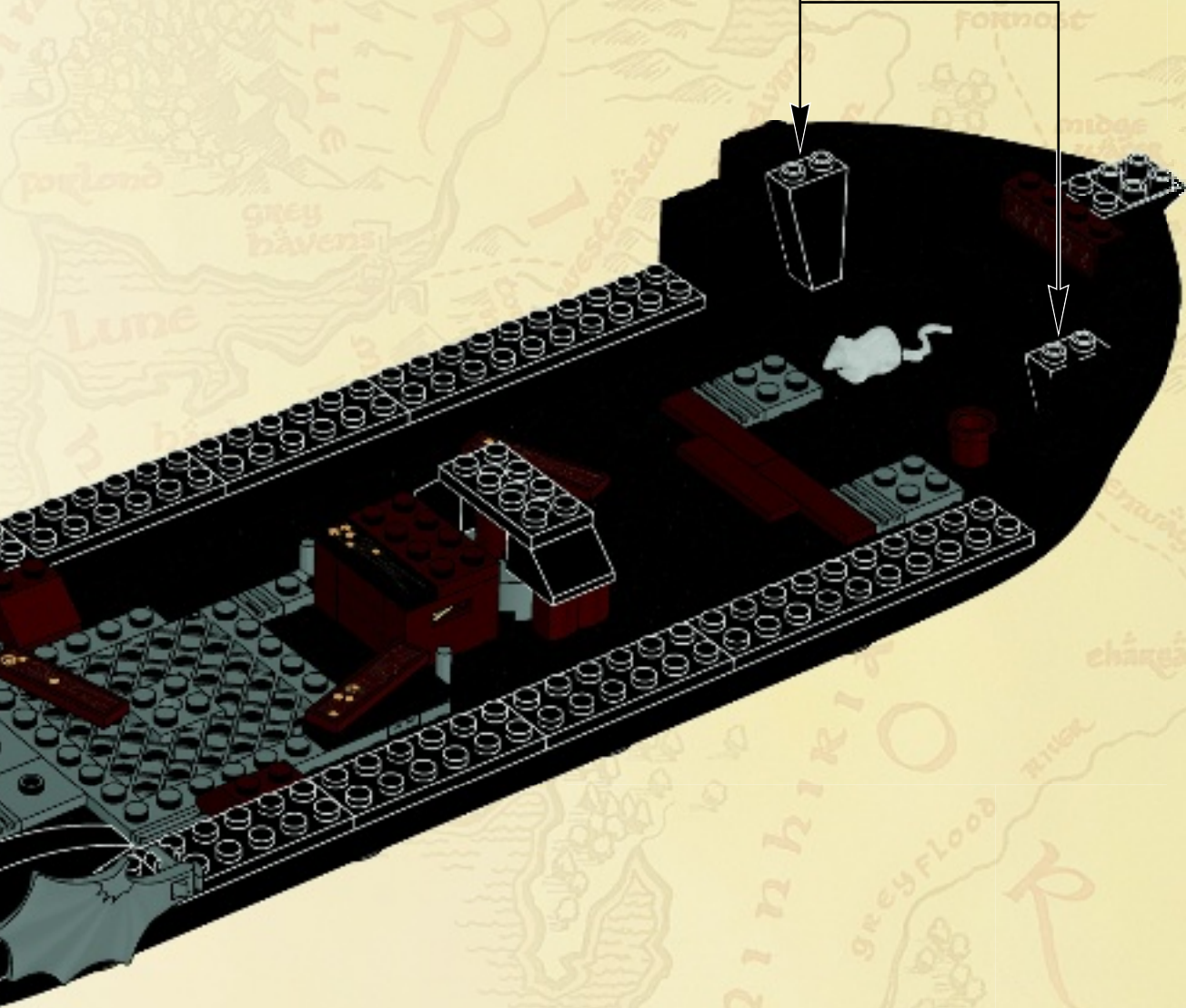



4x 4x

# 43

2x

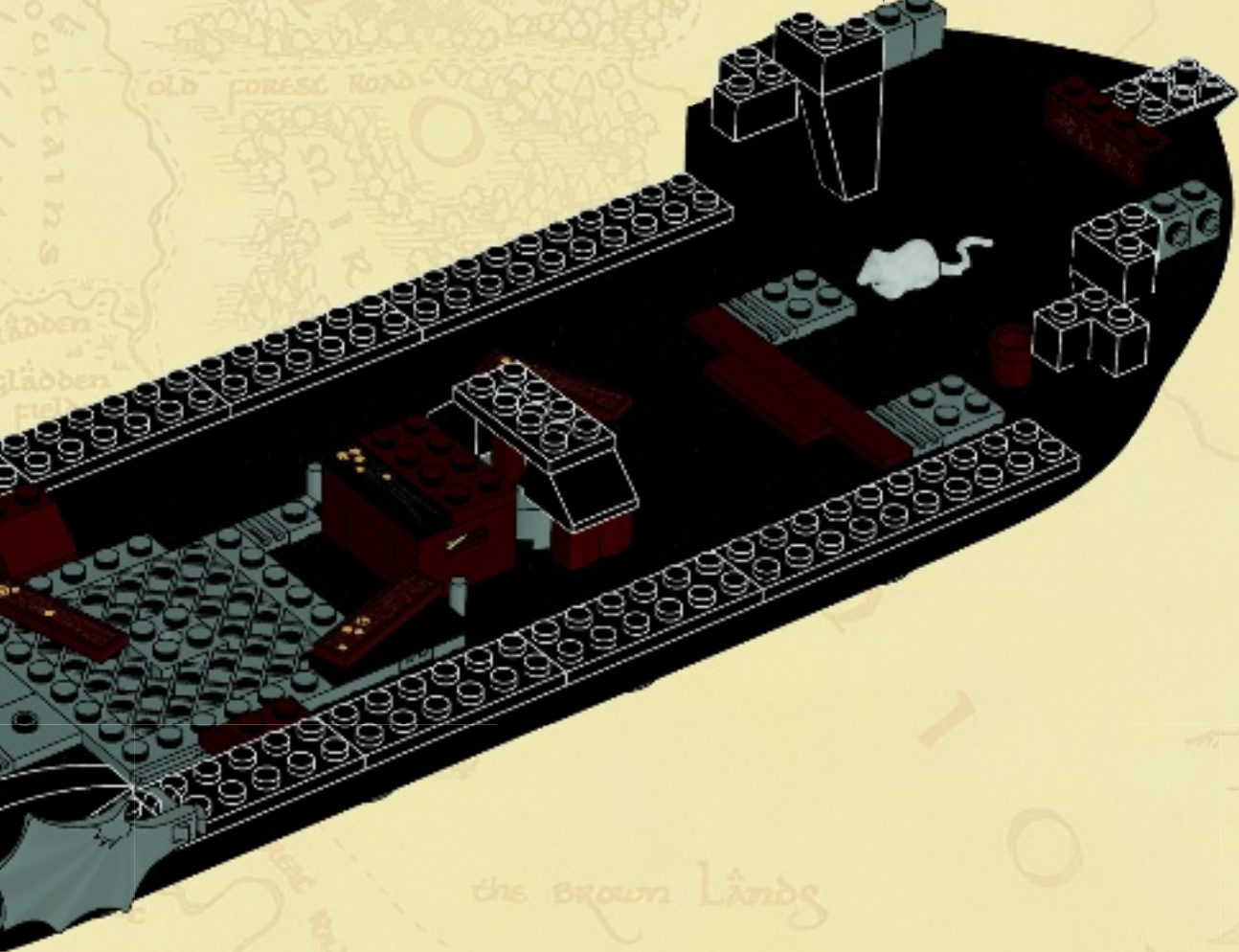

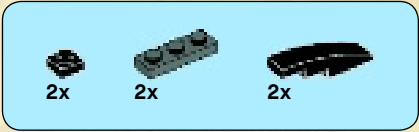

44

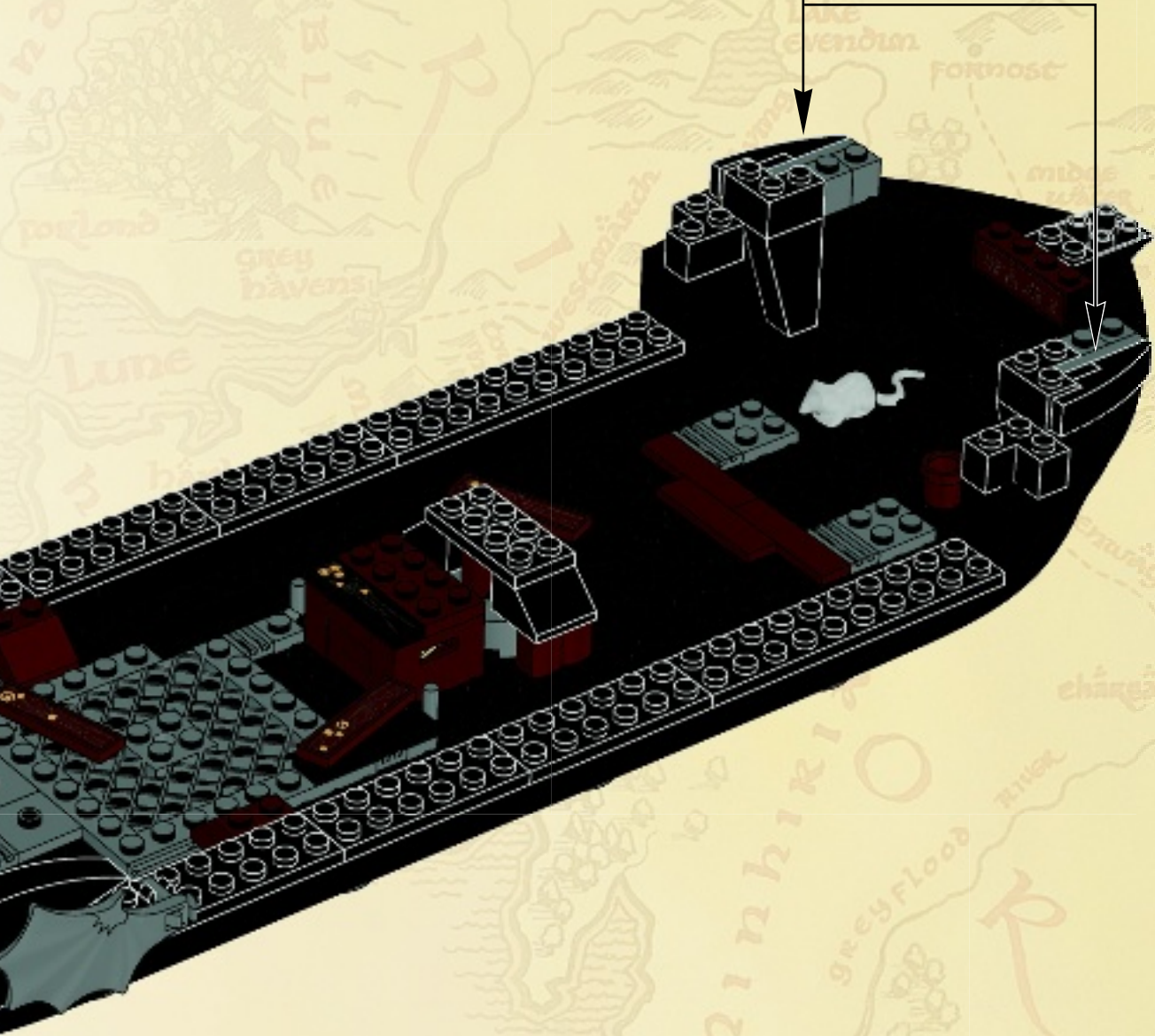
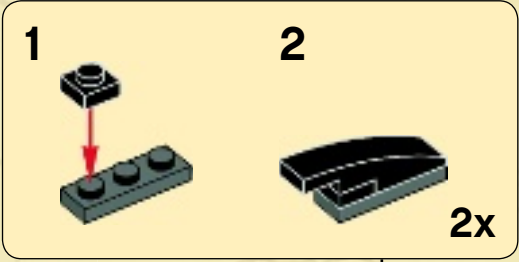





45

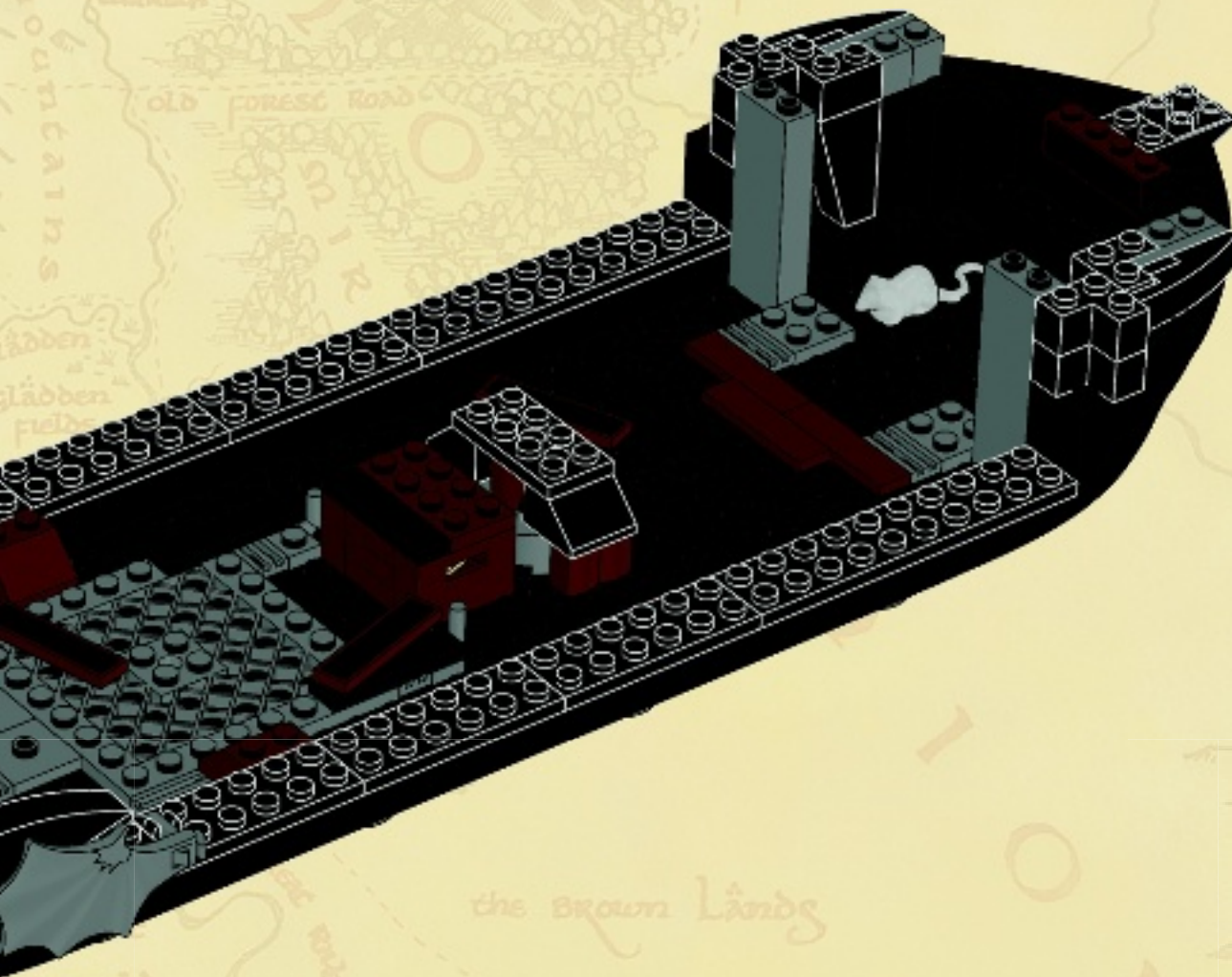

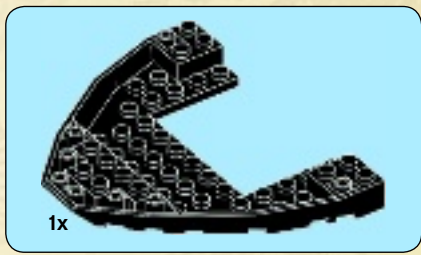

1

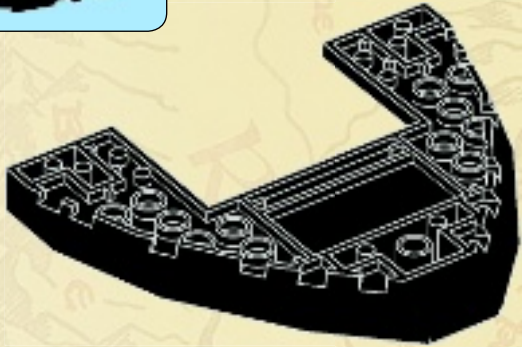

3

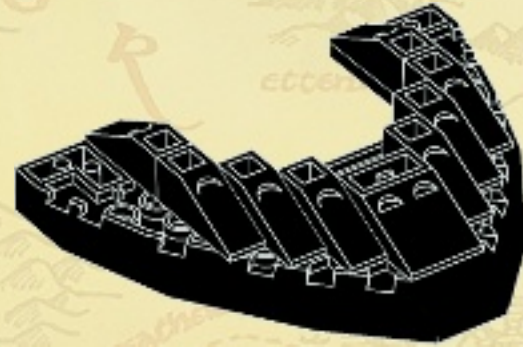

2



4





5

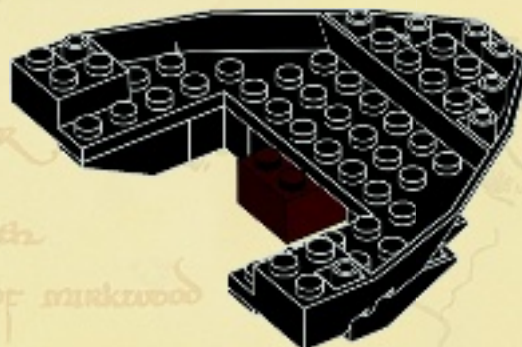
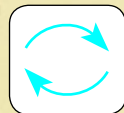

46

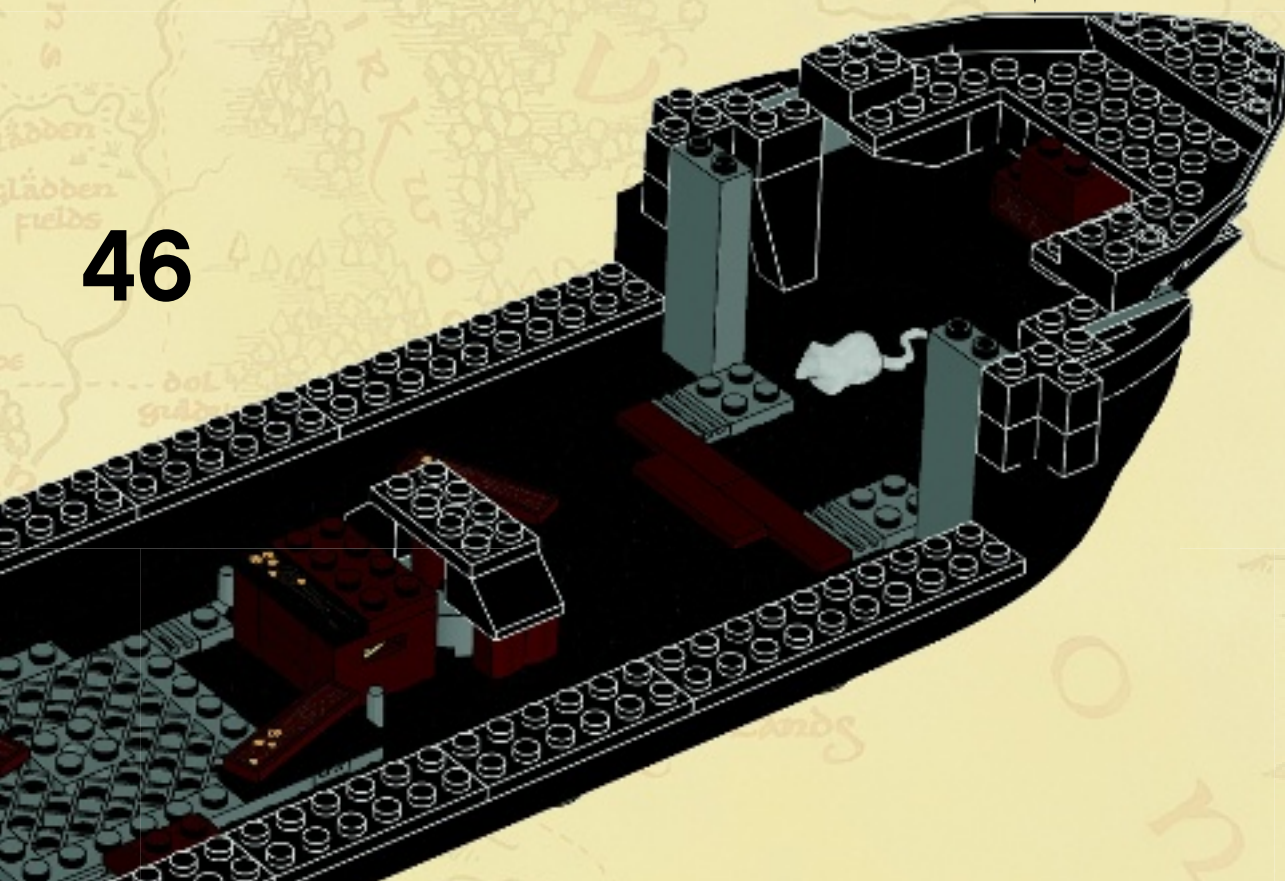

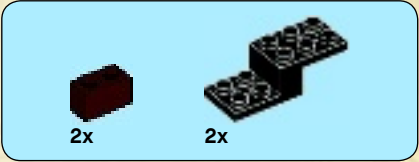

47

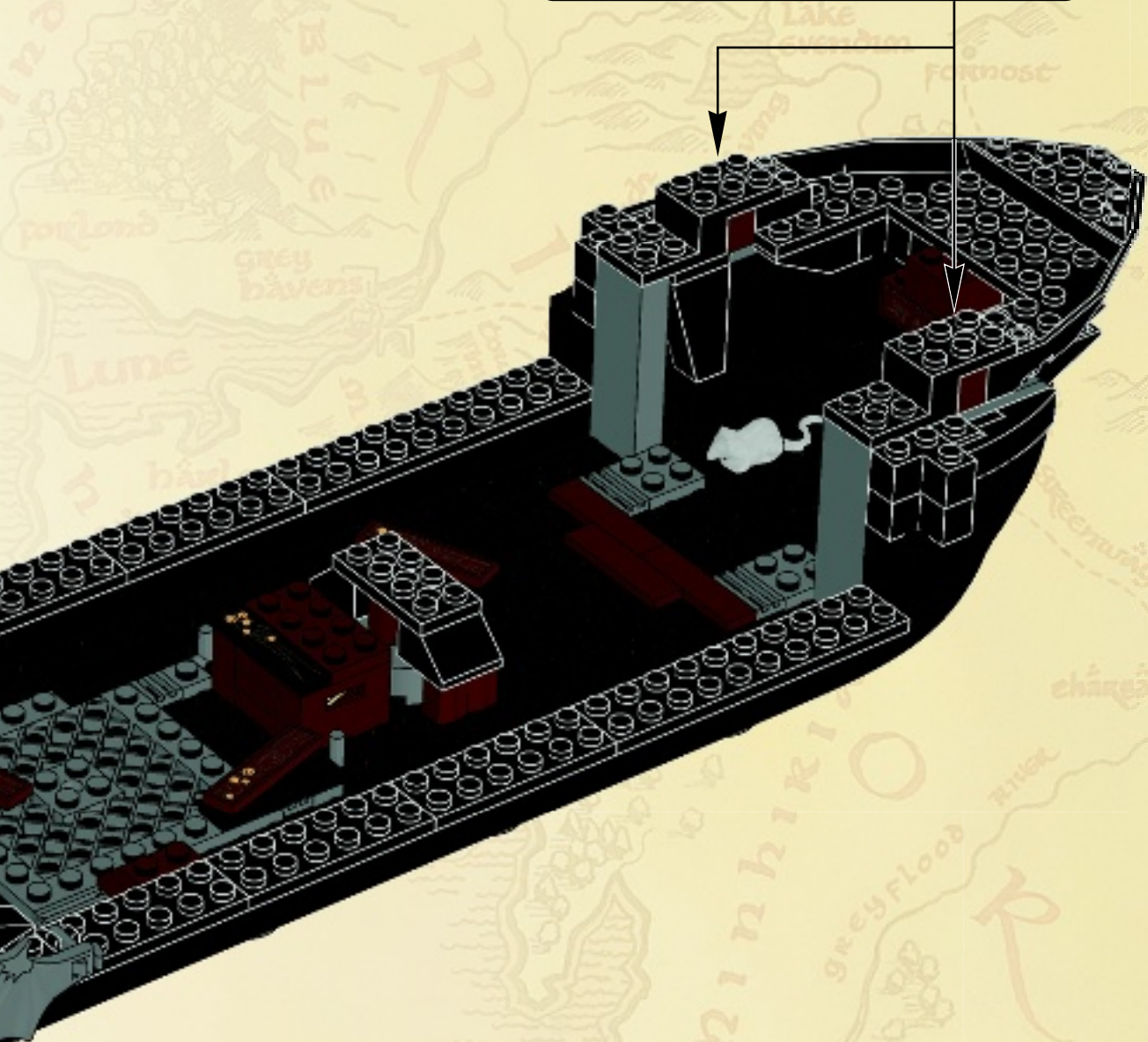
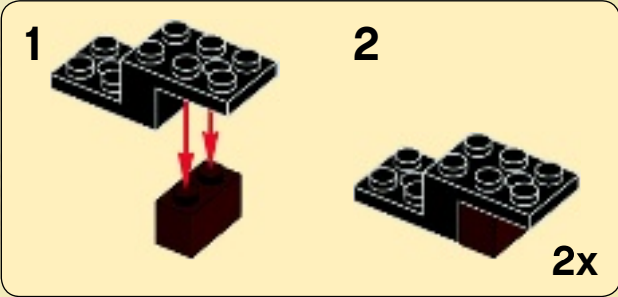





48

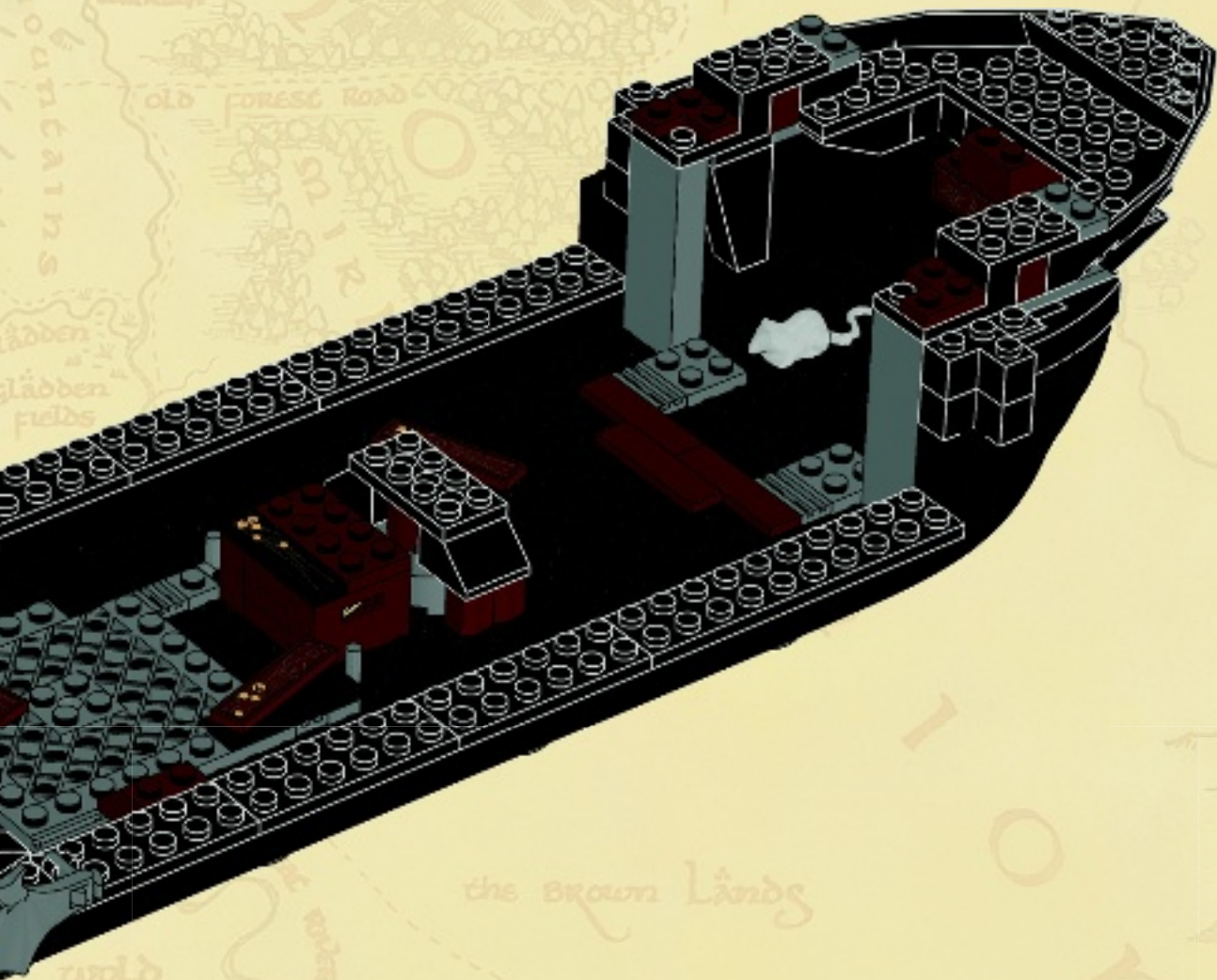



# 49

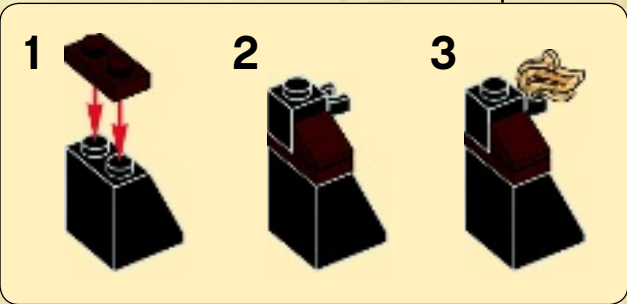
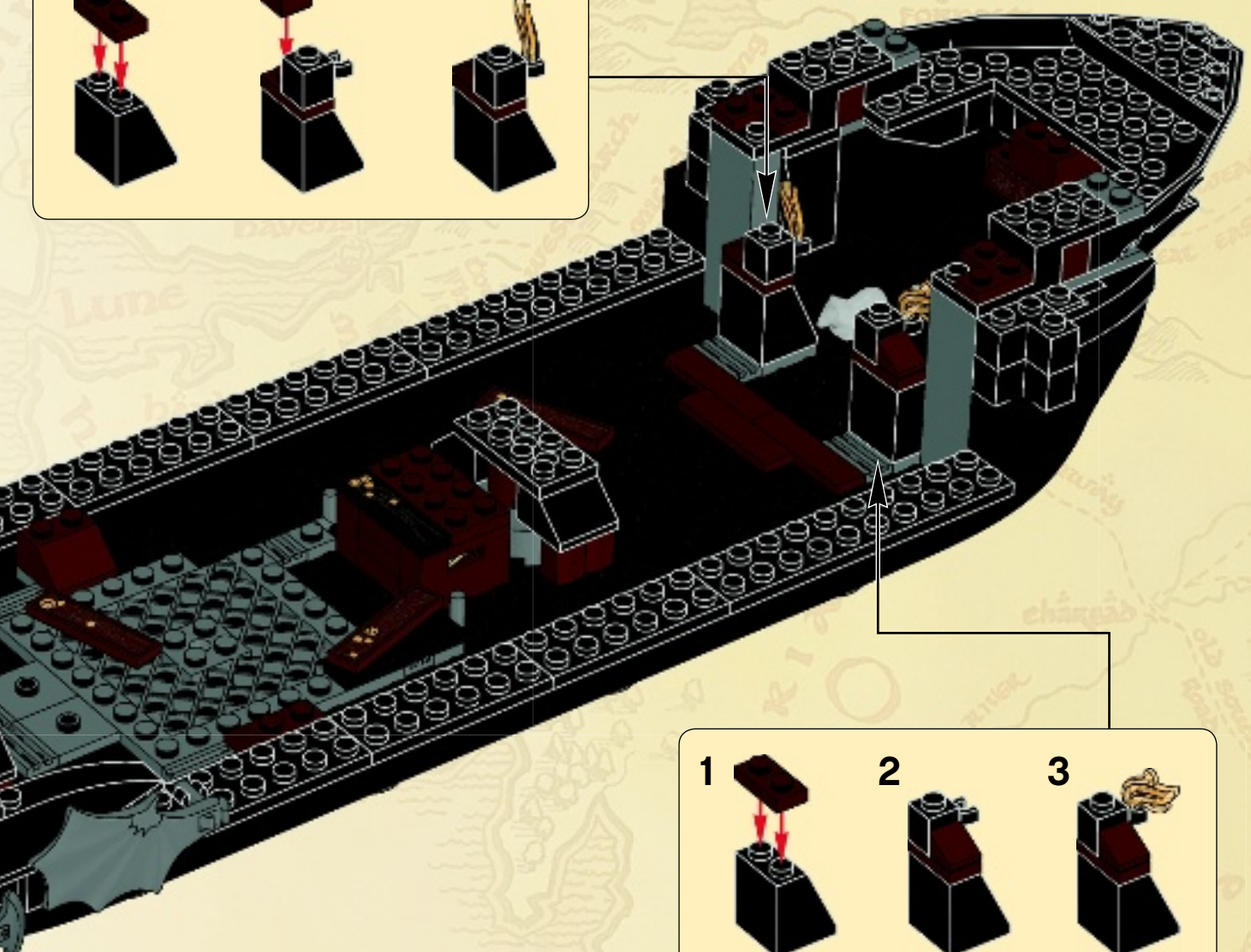
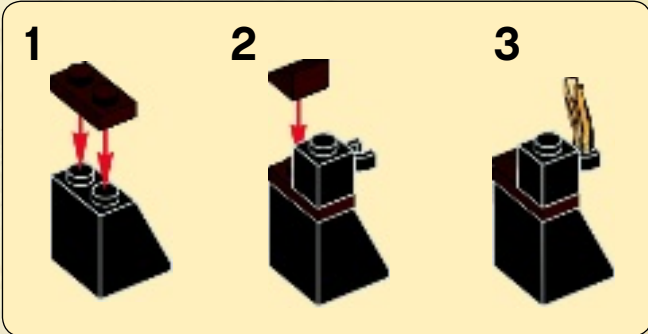





# 50

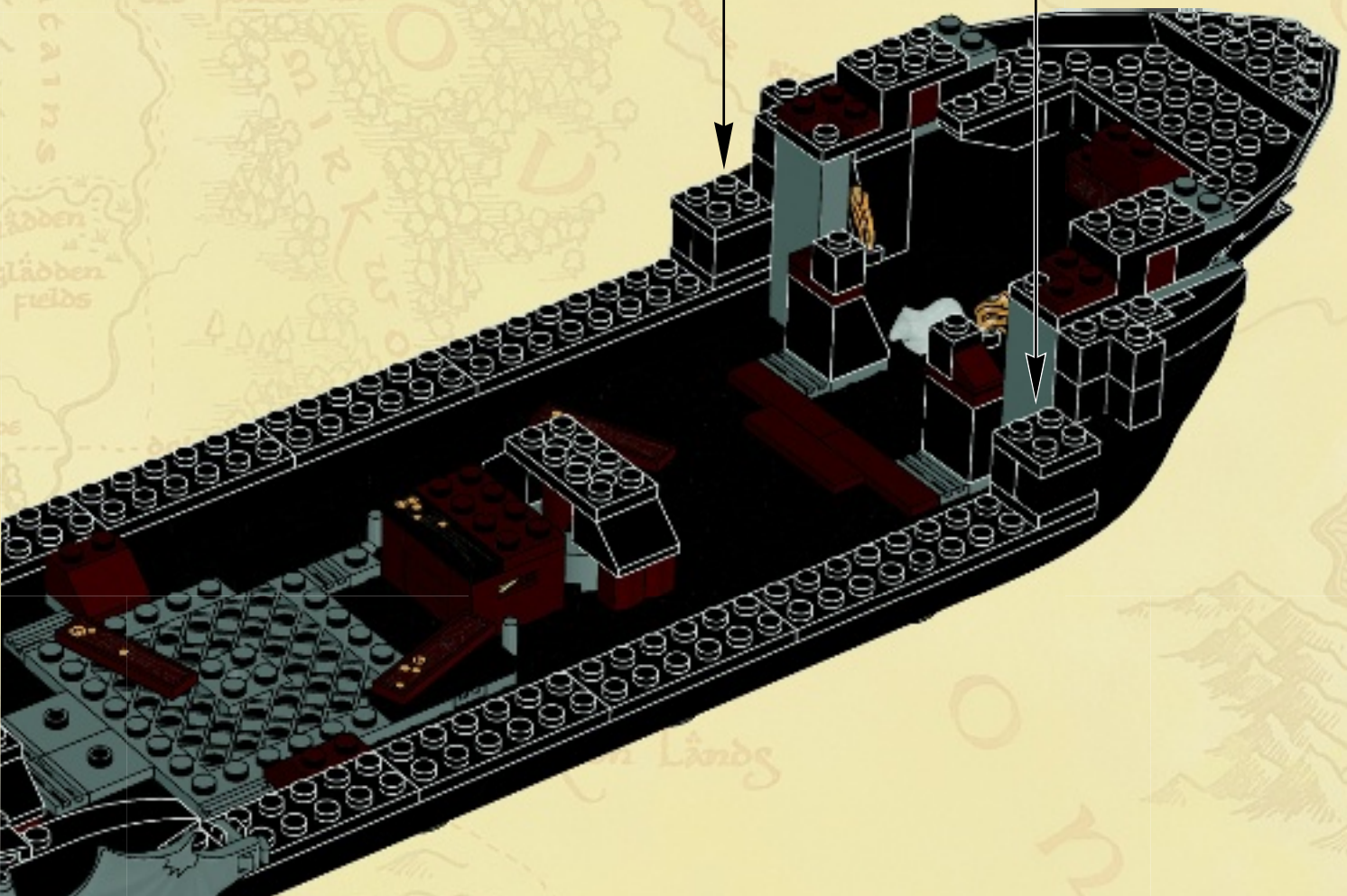
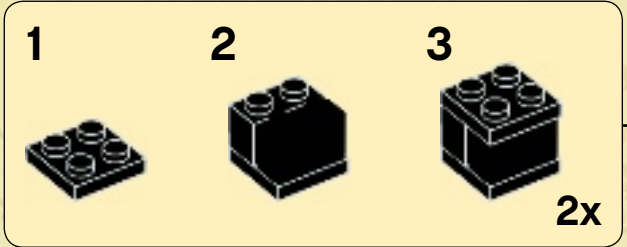

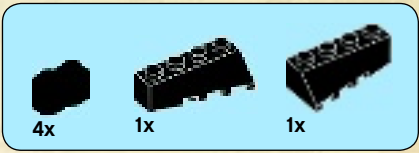

51

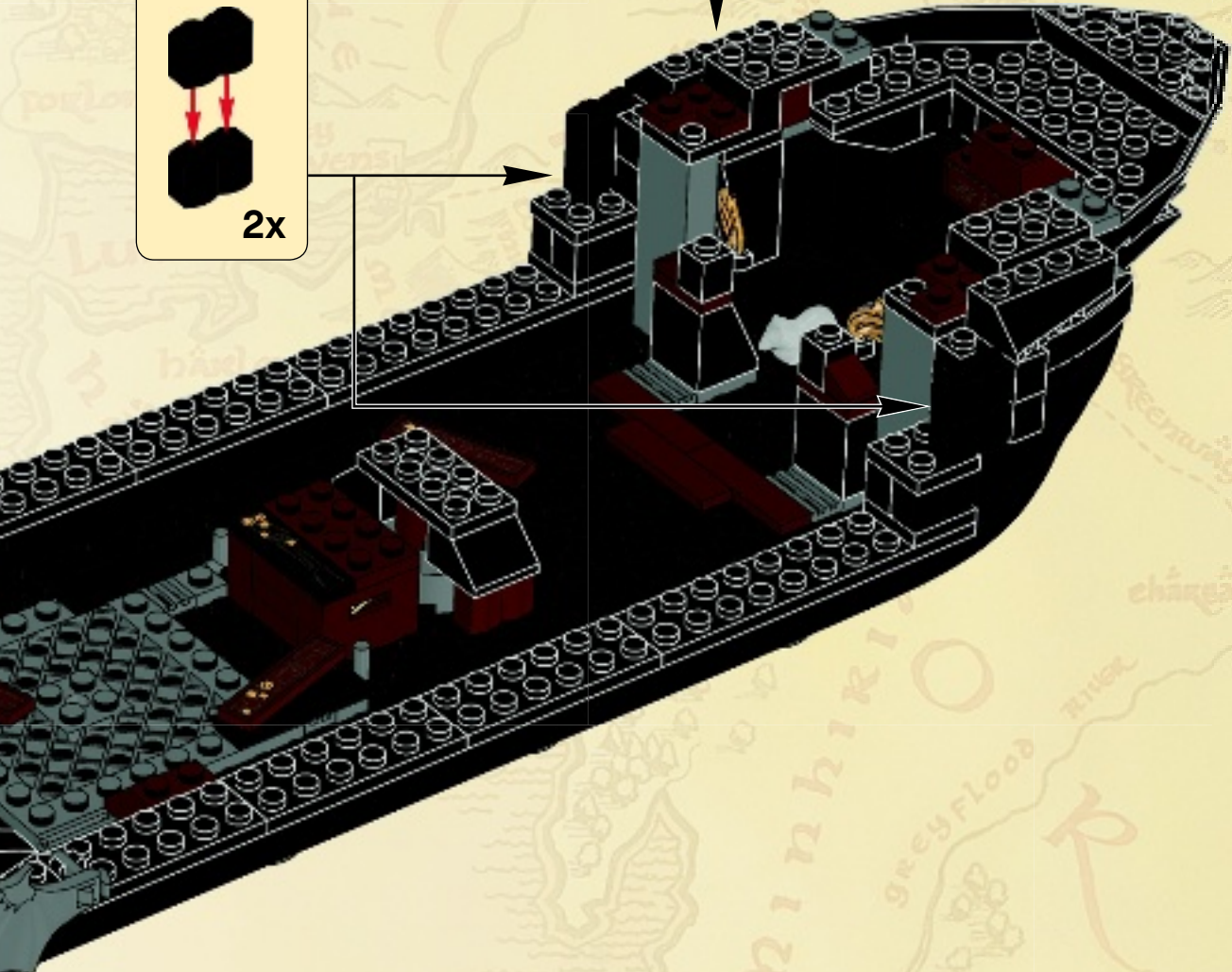
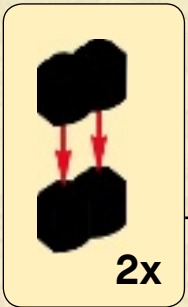





# 52

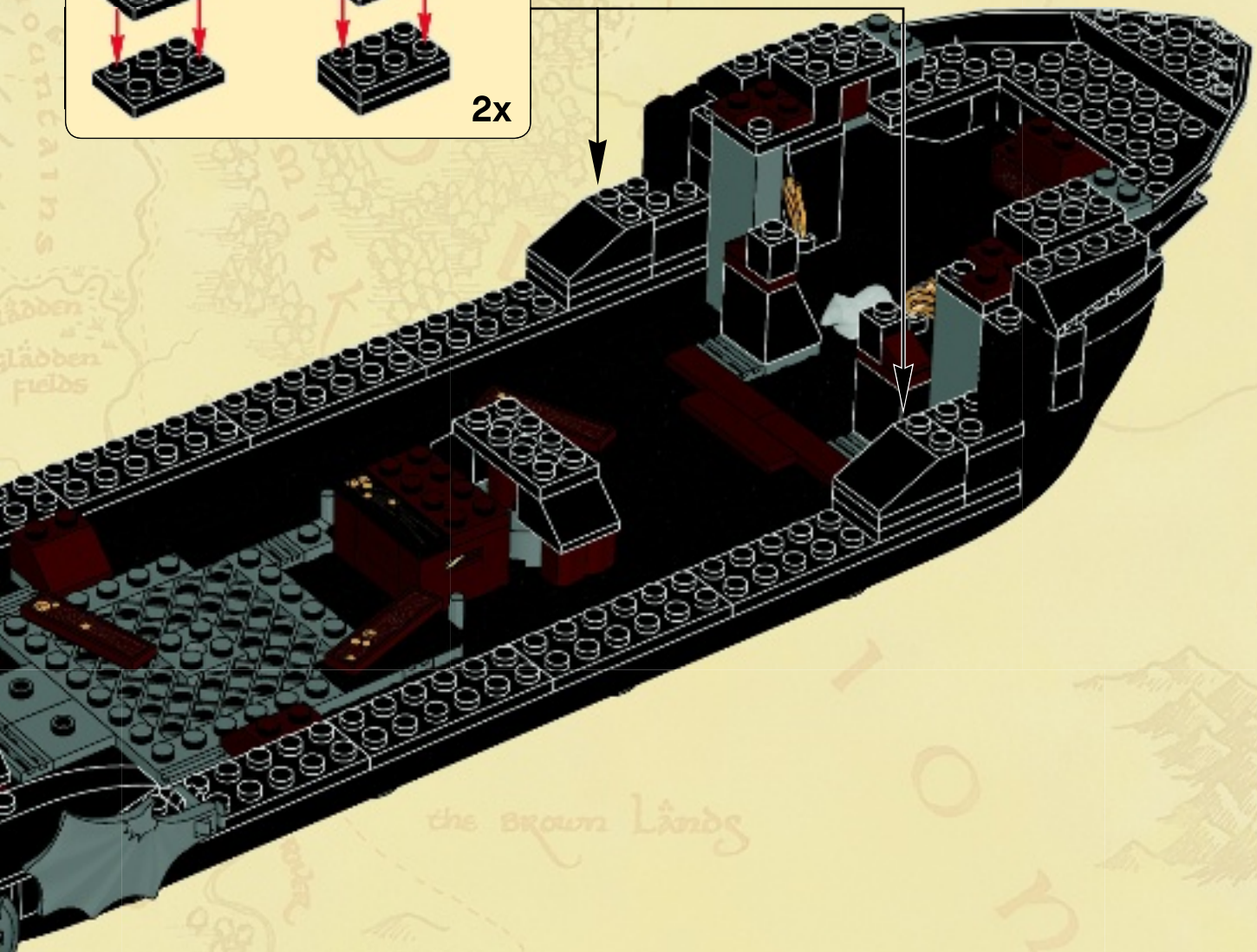
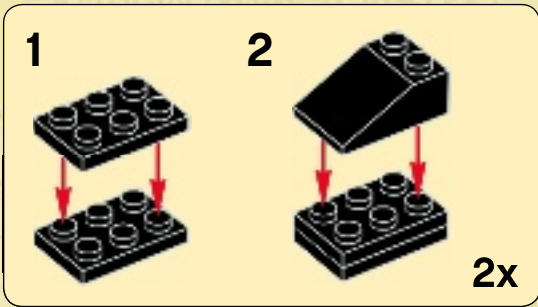

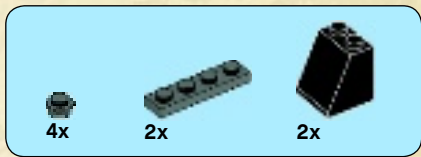

53

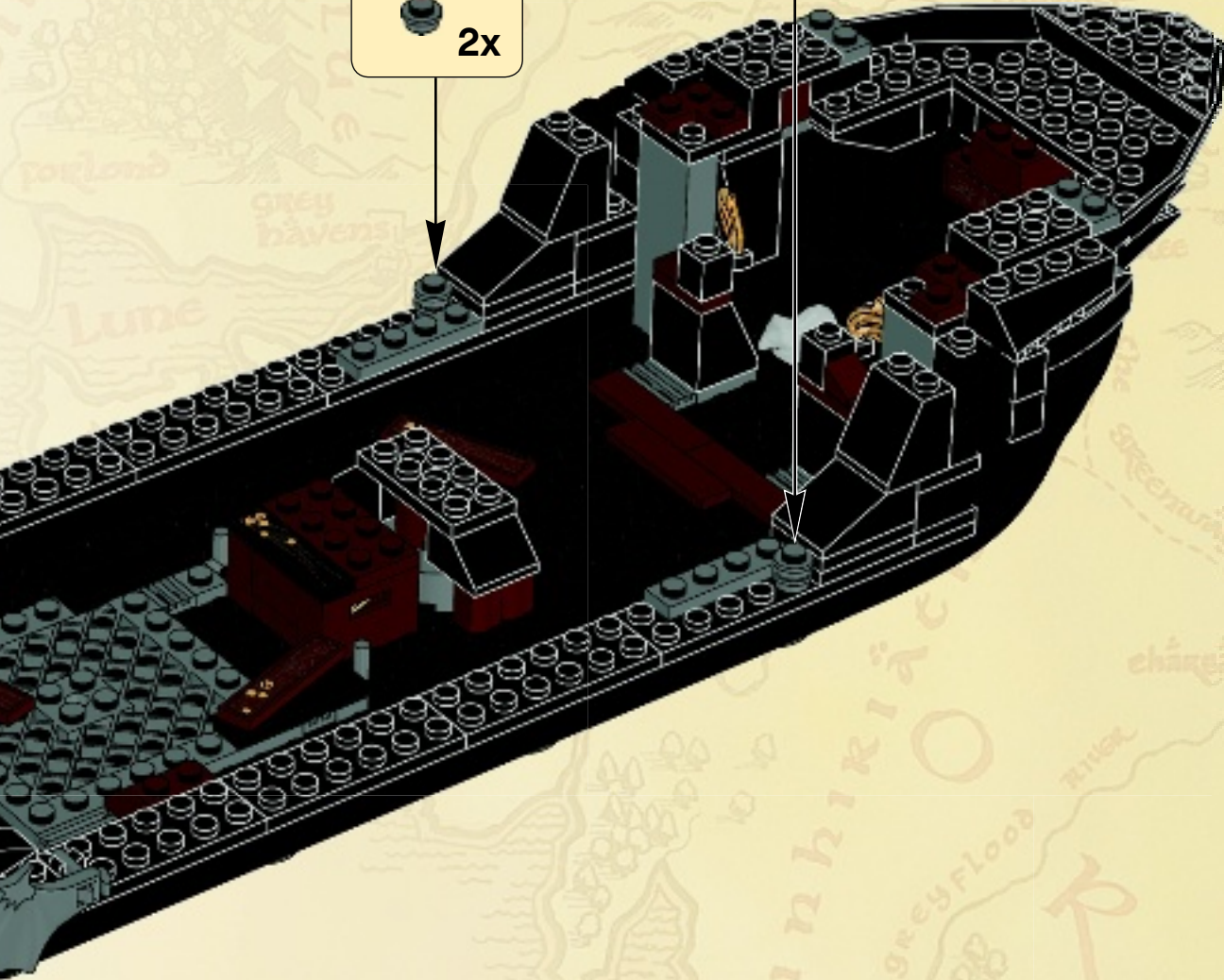
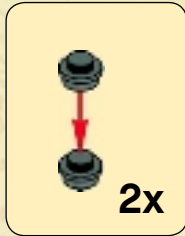



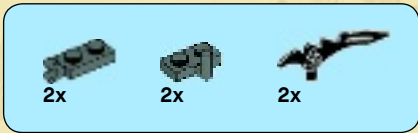

# 54

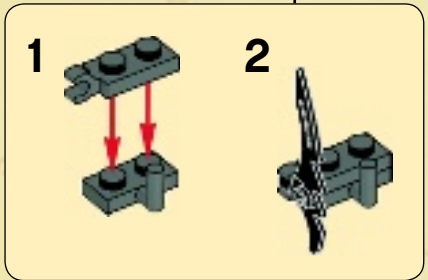
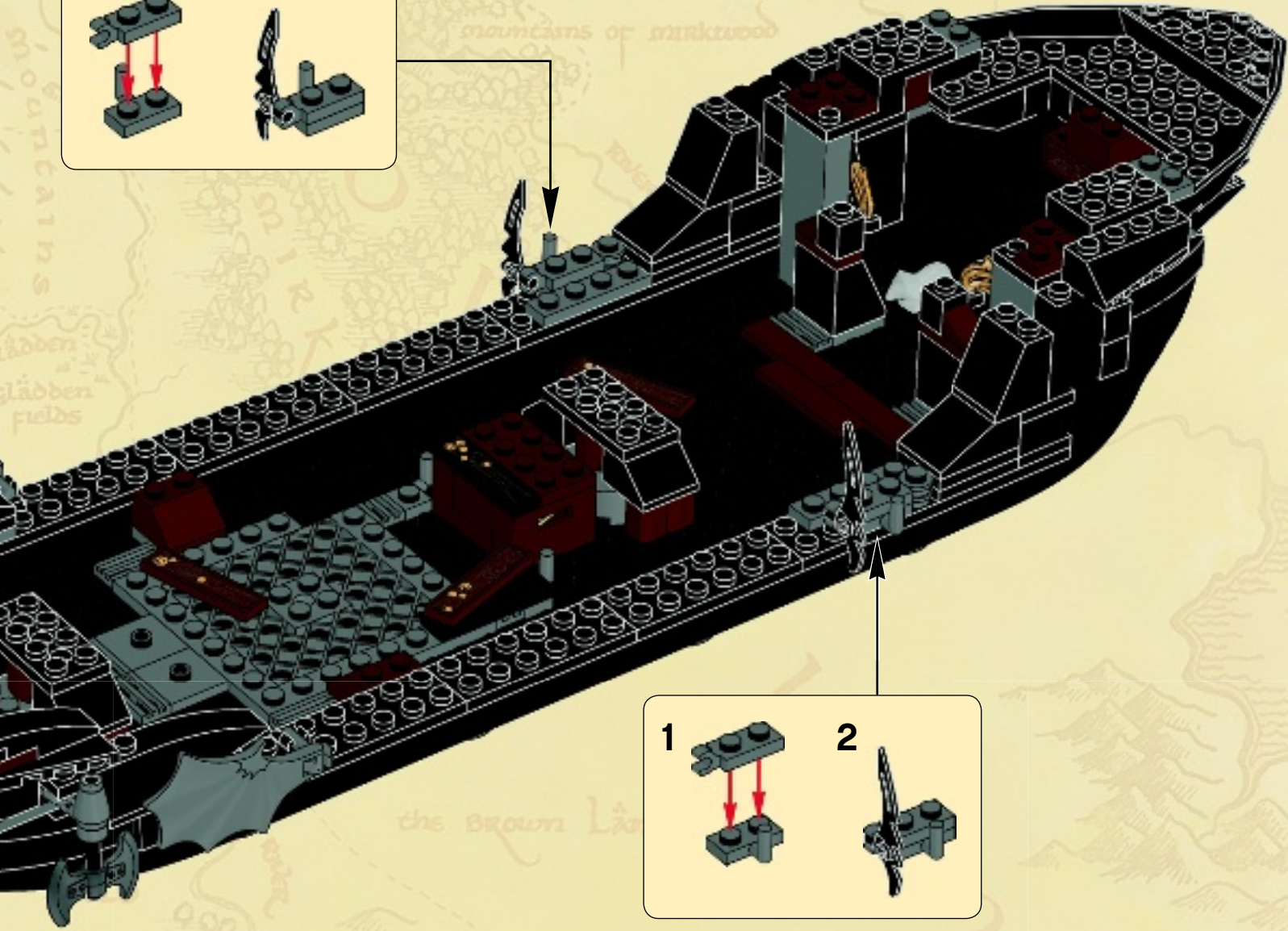
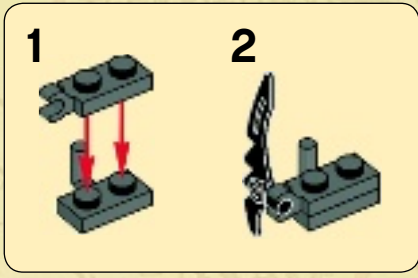



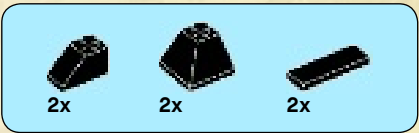

55

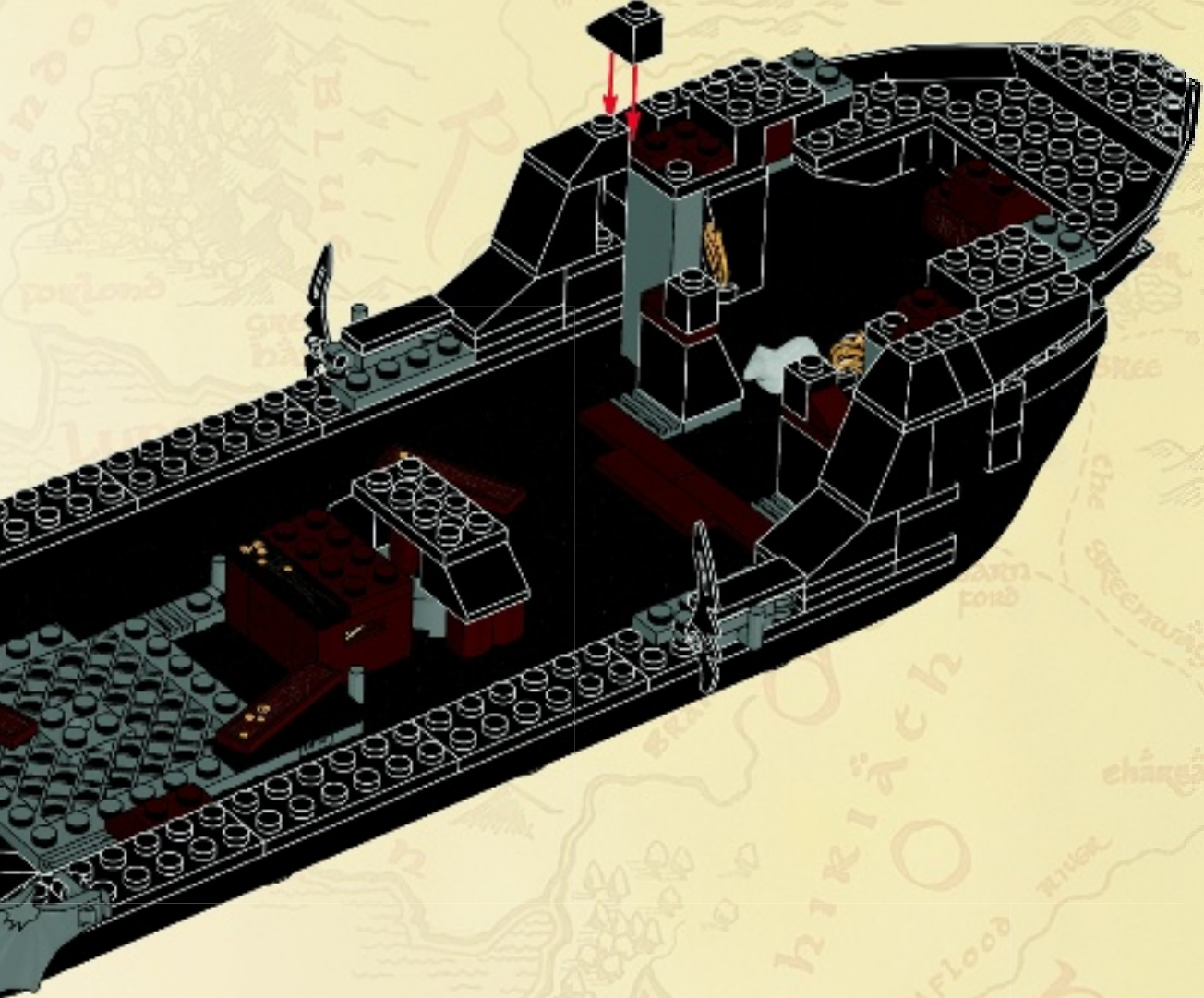



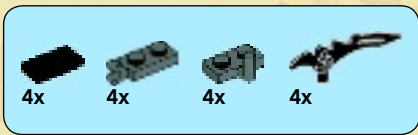

# 56

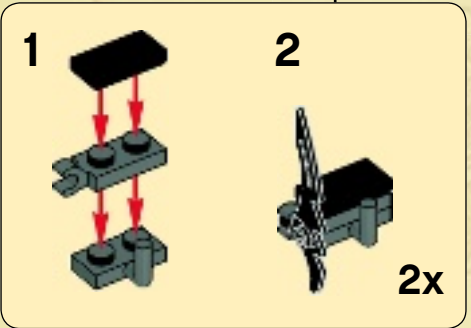
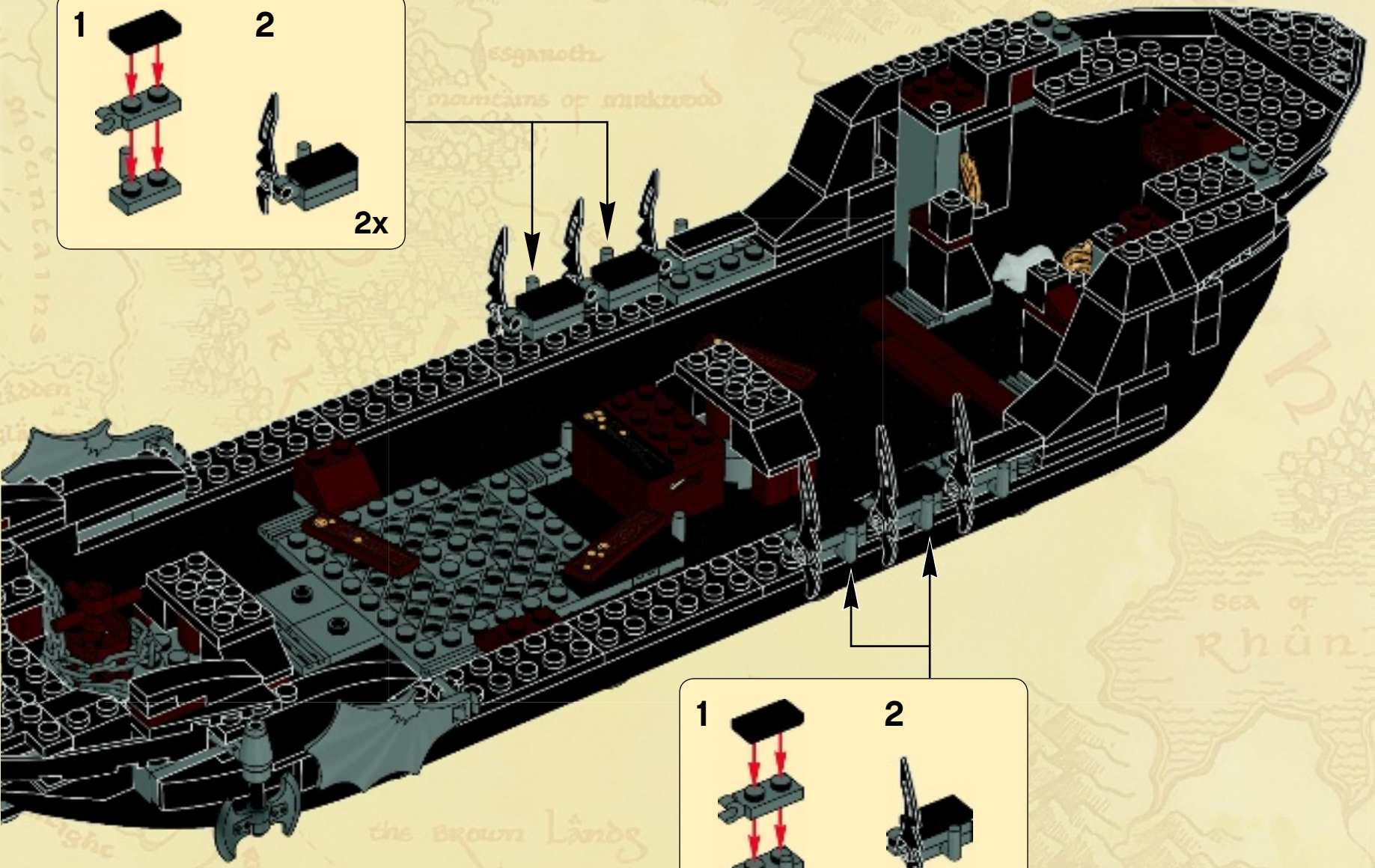
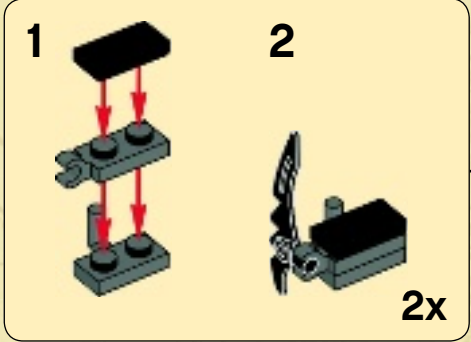



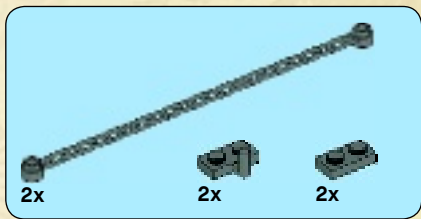

57

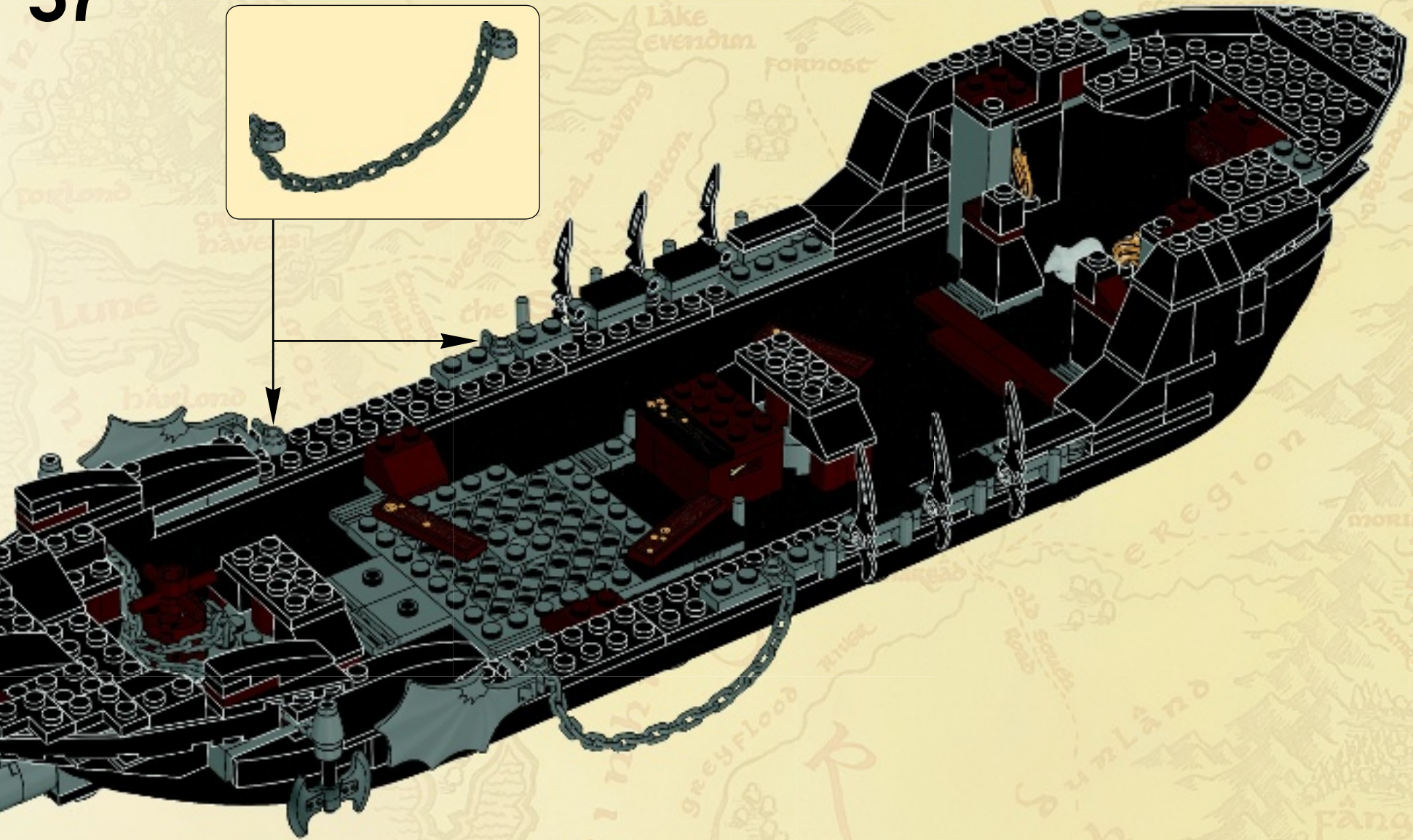
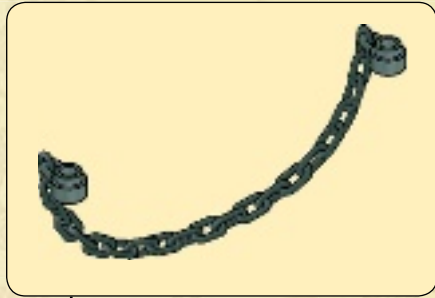



2x  2x 

# 58

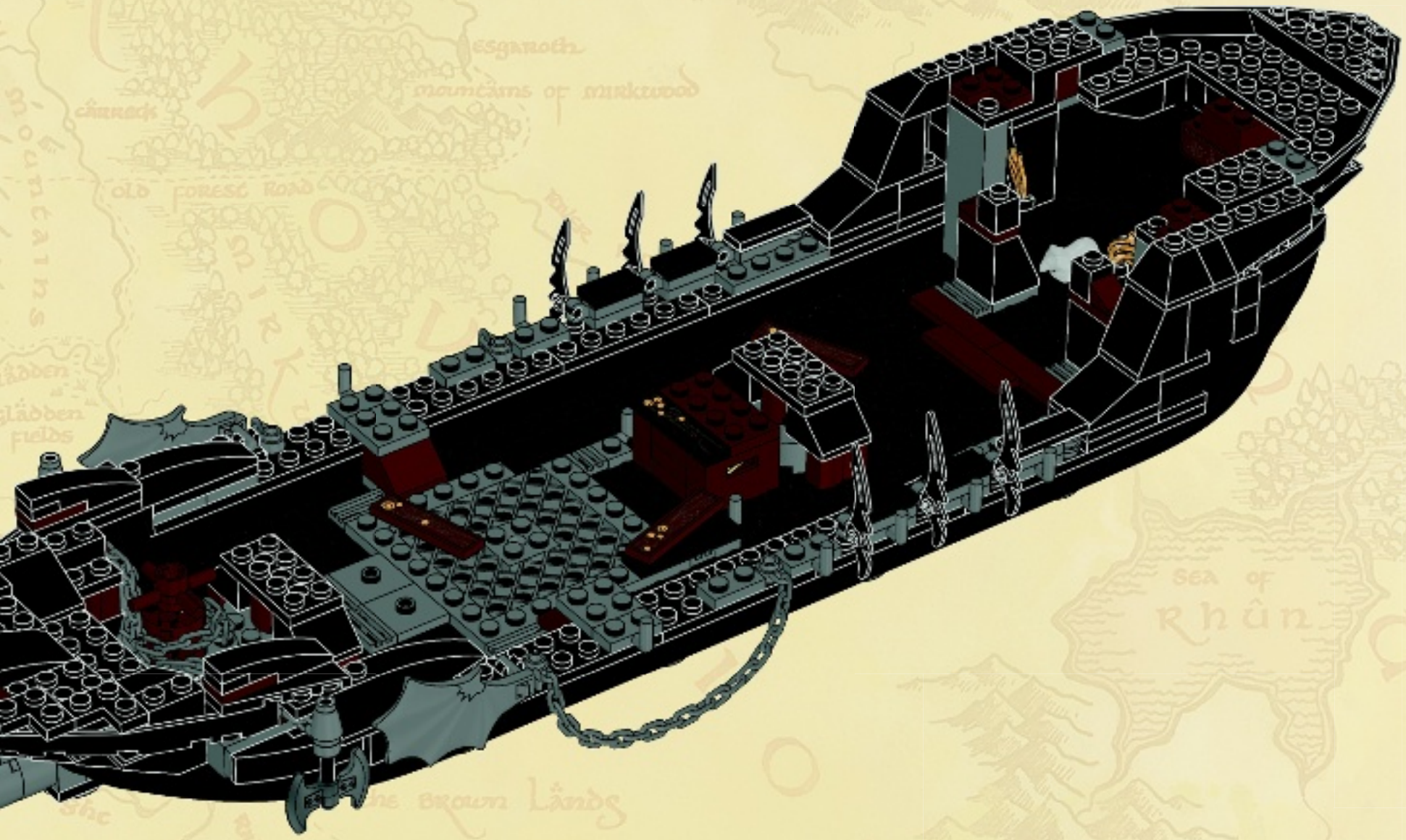



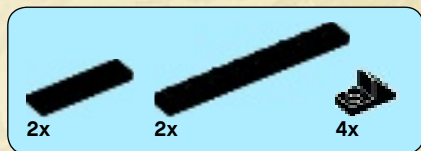

59

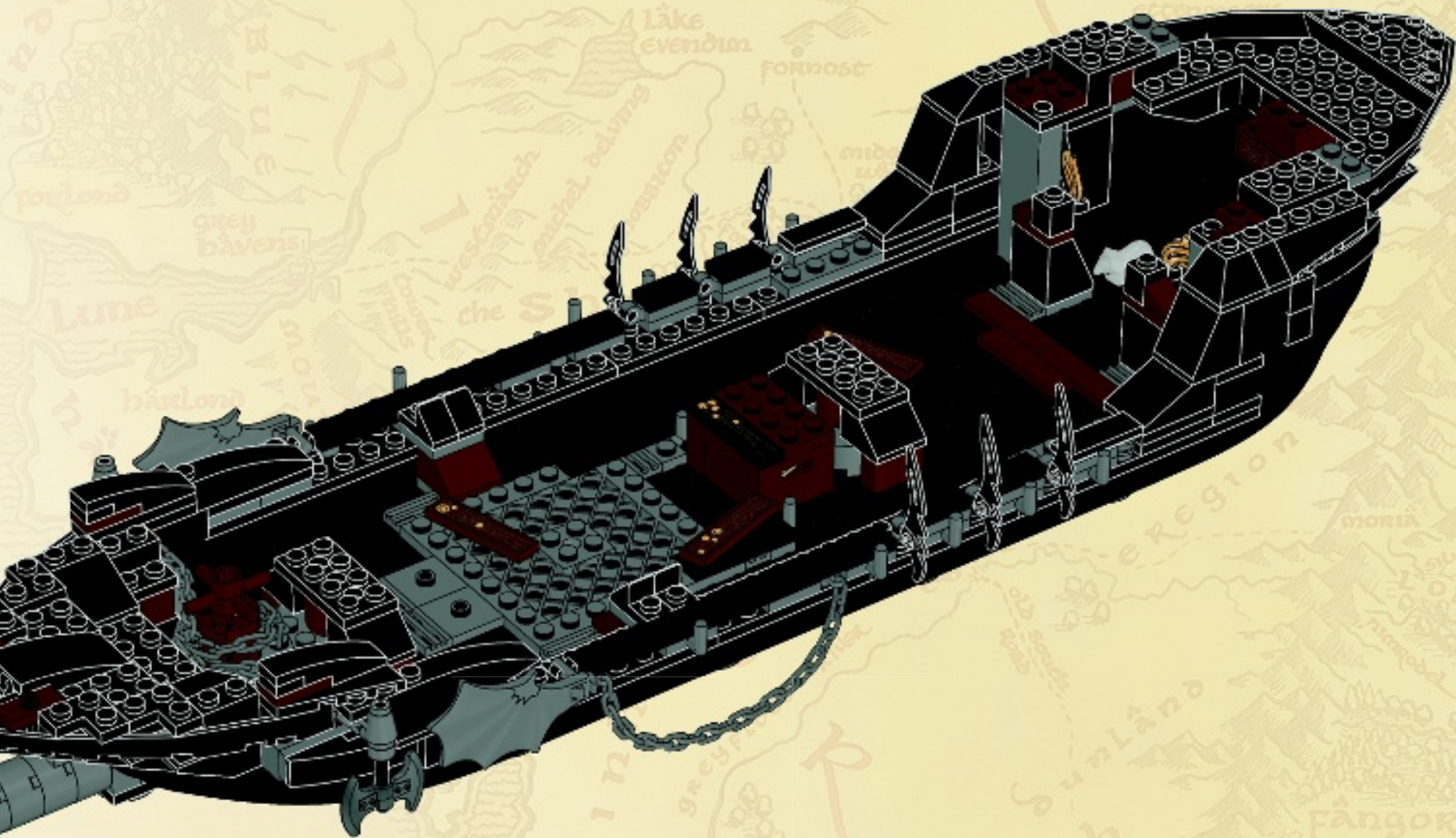





8x



2x

60

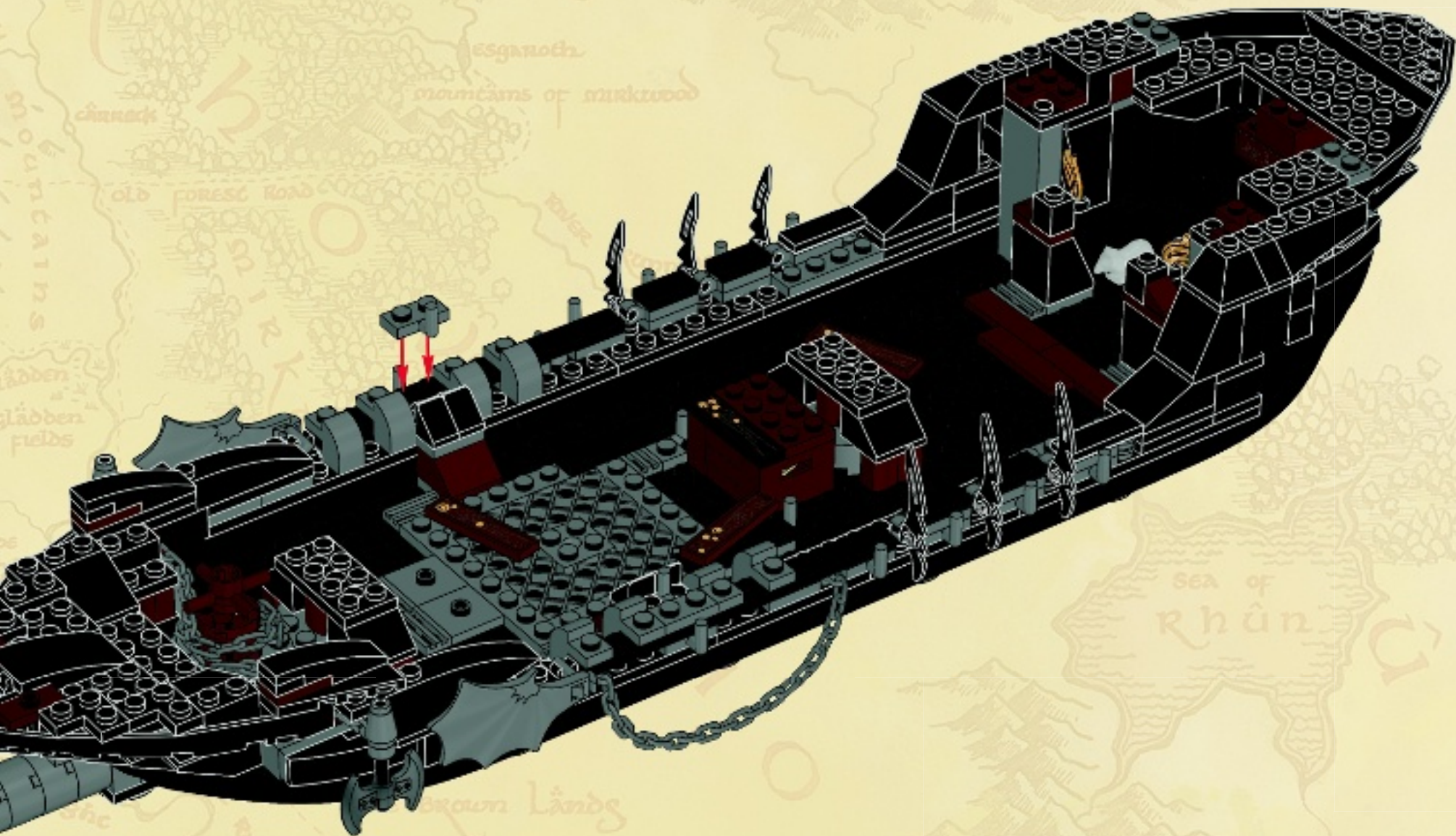



61

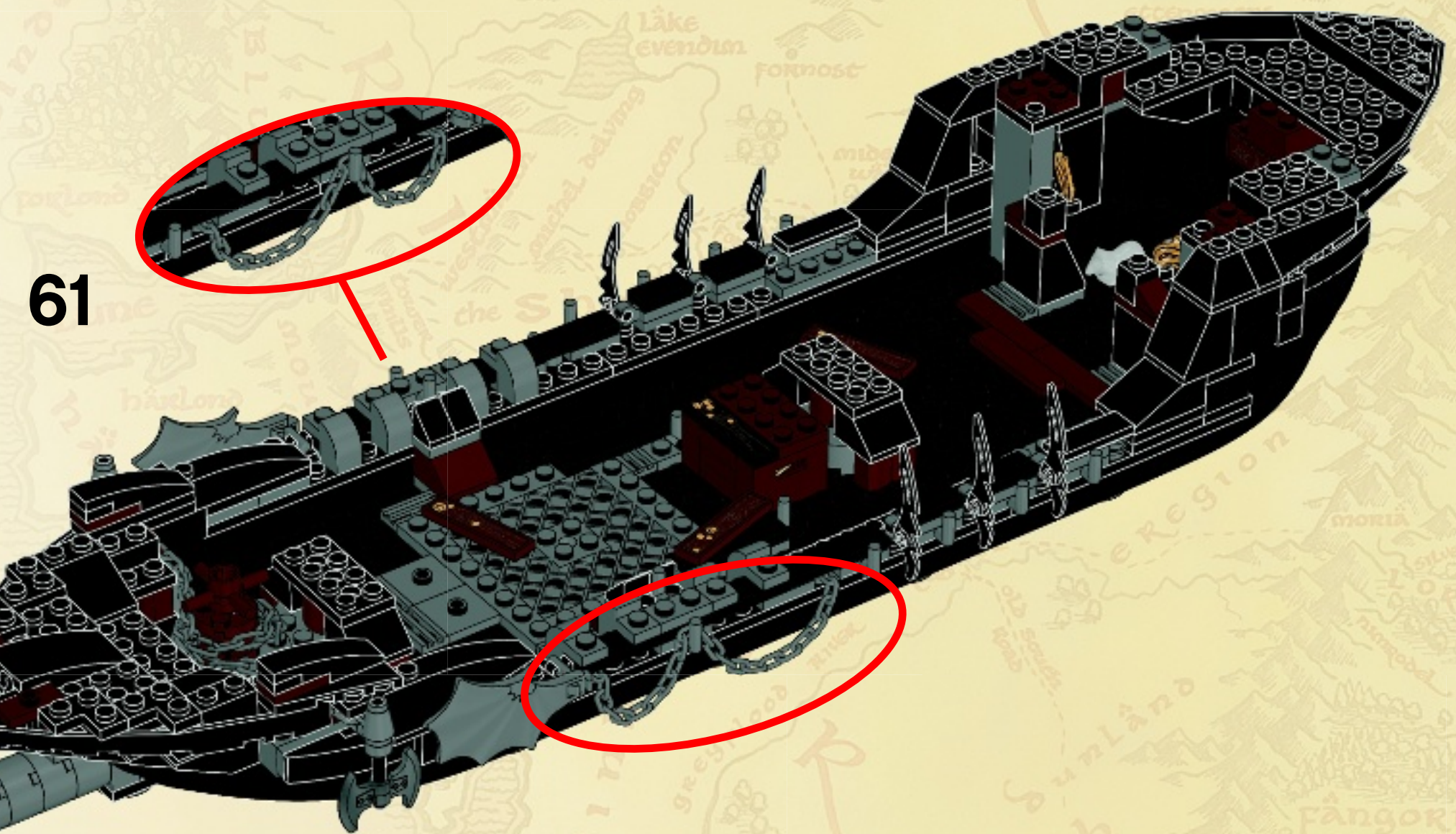



2x  4x 

62

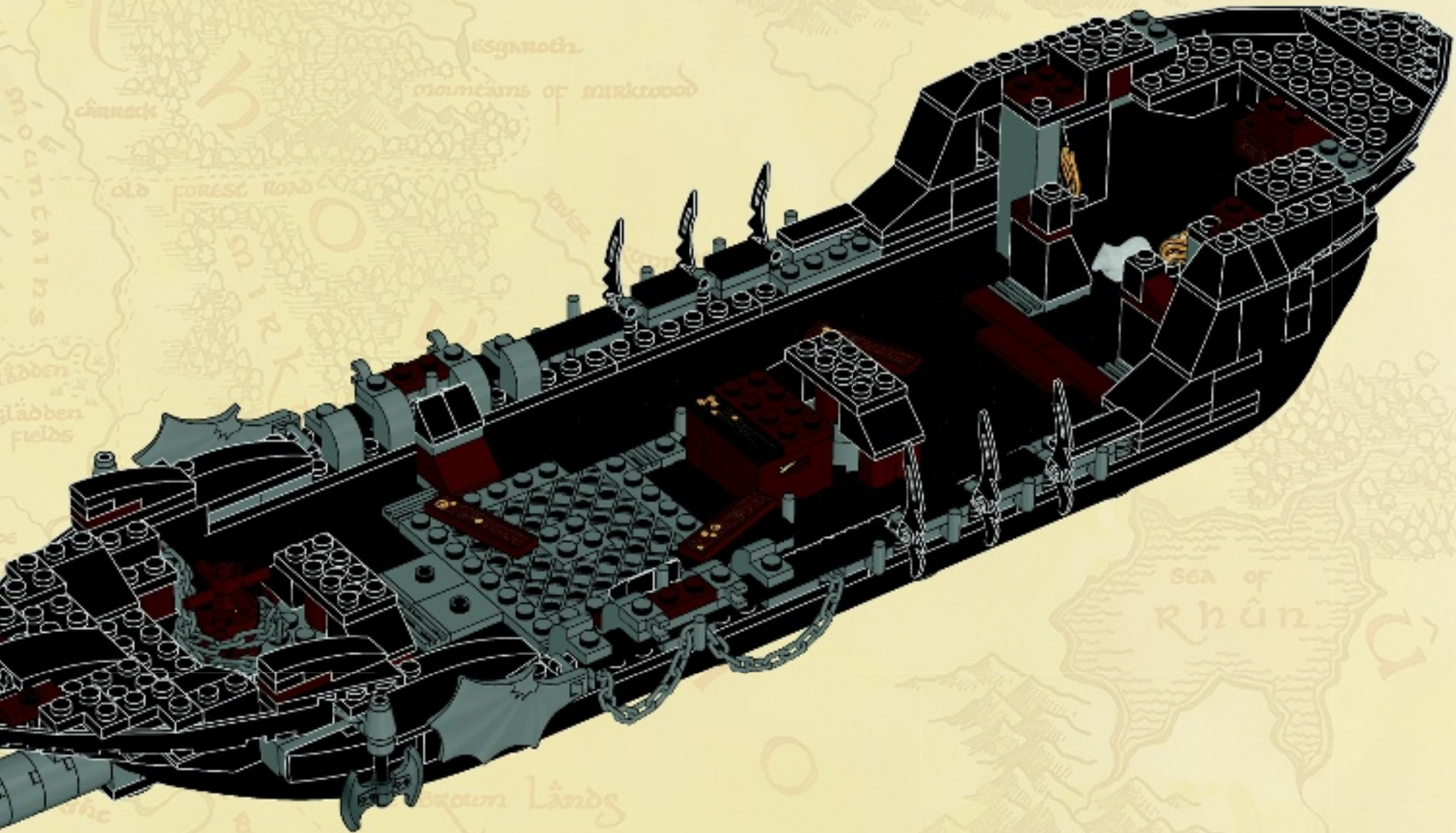



2x  2x  4x 

# 63

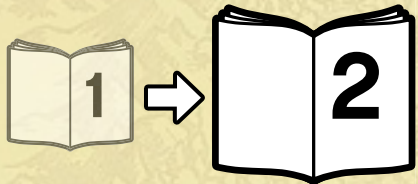
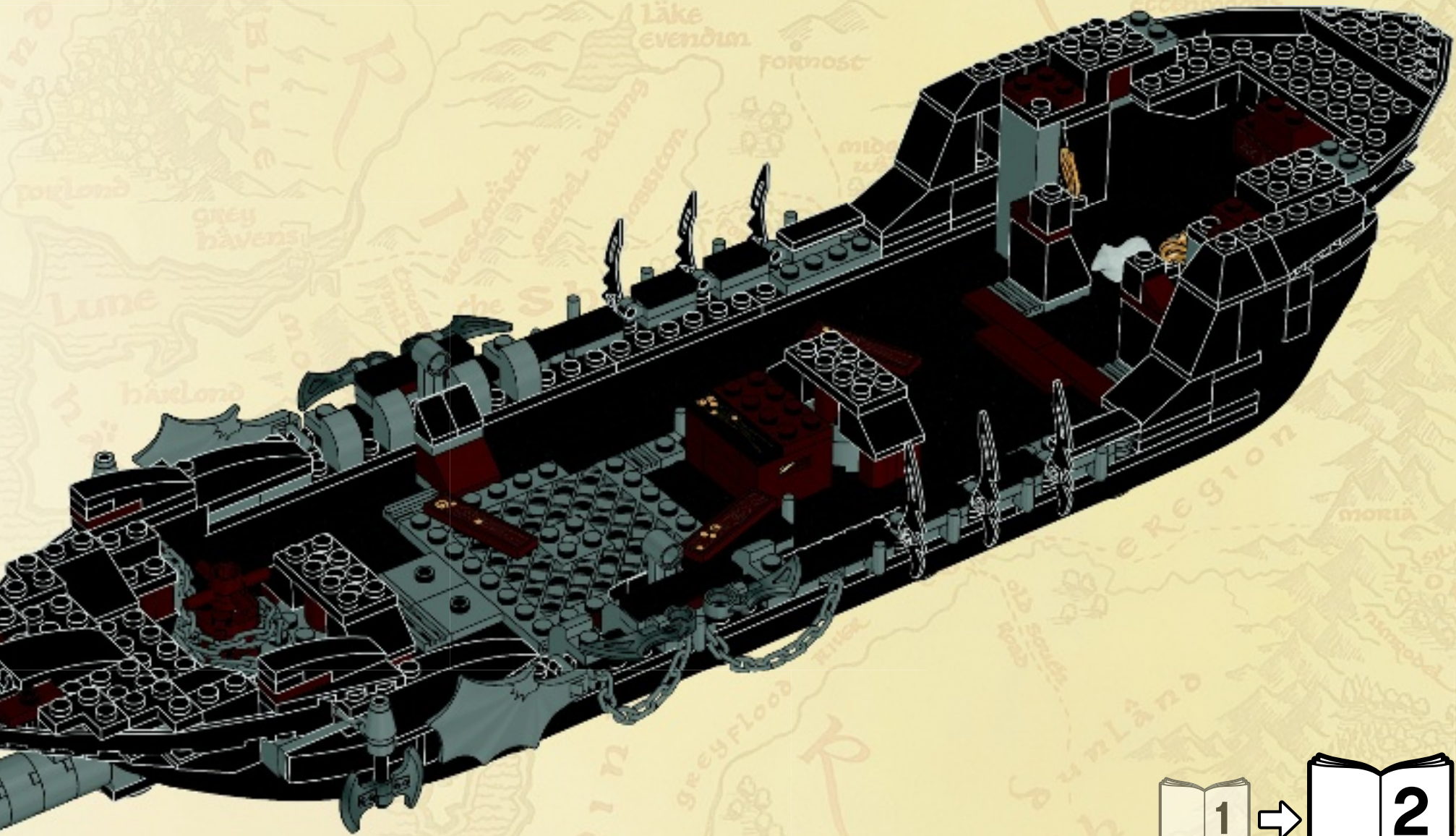





# club™

## Free\*! Gratuit!

\* Paid subscription in Australia and New Zealand.  
Abonnement payant en Australie et Nouvelle-Zélande



© 2013 The LEGO Group.

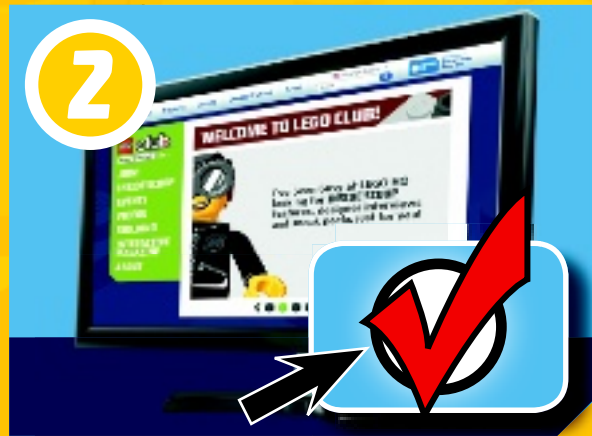

# LEGO.com/club



# WIN!

Go to [www.LEGOsurvey.com/product](http://www.LEGOsurvey.com/product) to fill out a survey for a chance to win a cool LEGO® Product. No purchase necessary. Open to all residents where not prohibited.



LEGO.com



## [www.LEGOsurvey.com/product](http://www.LEGOsurvey.com/product)

### GEWINNE!

Nimm an der Umfrage auf [www.LEGOsurvey.com/product](http://www.LEGOsurvey.com/product) teil und hab die Chance ein cooles LEGO® Produkt zu gewinnen! Die Teilnahme am Gewinnspiel führt zu keinerlei Kaufverpflichtungen. Teilnahme in allen nicht ausgeschlossenen Ländern möglich.

### WIN!

Ga naar [www.LEGOsurvey.com/product](http://www.LEGOsurvey.com/product), vul een enquêteformulier in en maak kans op een cool LEGO® product. Geen aankoopverplichting. Iedereen mag deelnemen, uitgezonderd ingezetenden van landen waar een enquêteverbod geldt.

### GAGNE!

Visite [www.LEGOsurvey.com/product](http://www.LEGOsurvey.com/product) pour répondre à un questionnaire et avoir une chance de gagner un produit LEGO® très cool! Aucune obligation d'achat. Ouvert à tous les résidents des pays autorisés.

### 当てよう!

[www.LEGOsurvey.com/product](http://www.LEGOsurvey.com/product) にアクセスして、アンケートにご記入ください。当選者にはレゴ製品を差し上げます。お買い上げの必要はありません。禁止されていない限り、すべての皆様にご利用いただけます。