



# THE HOBBIT

THE RESOLUTION OF SMAGG

79014









1



2

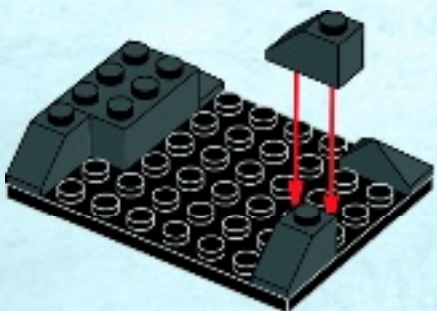

4



3

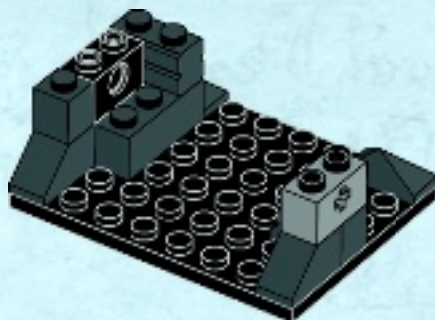



4

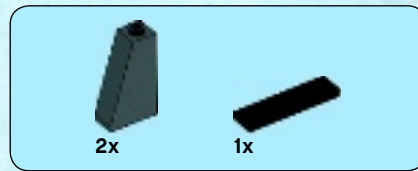
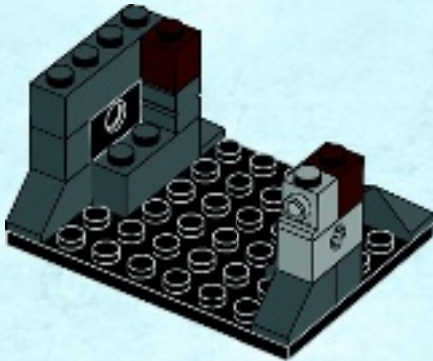

5

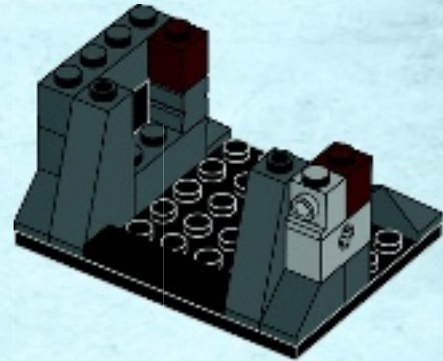

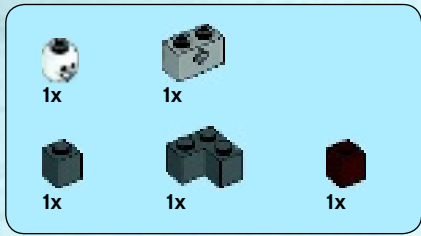

6

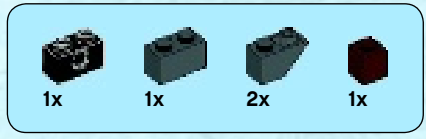
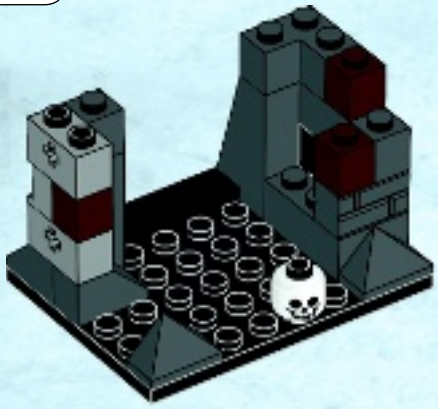
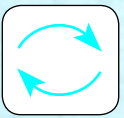

7

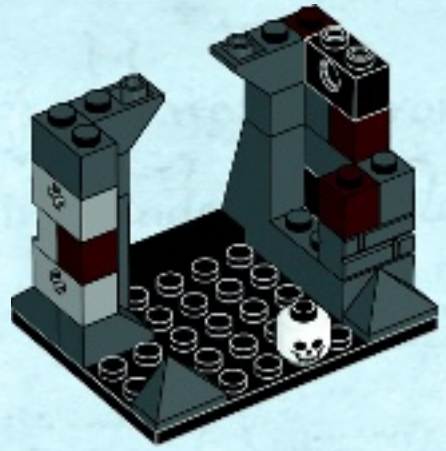

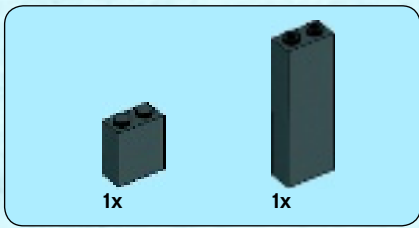

8

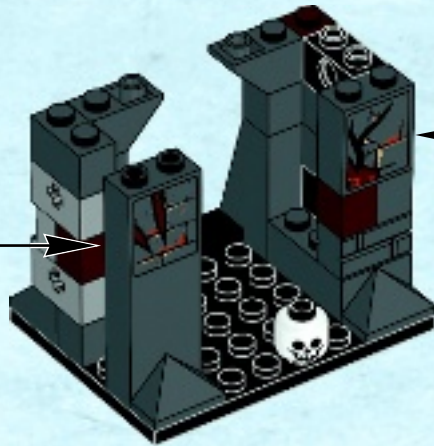
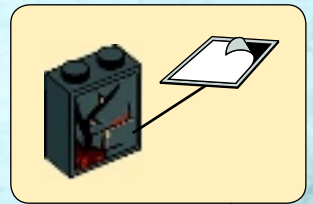
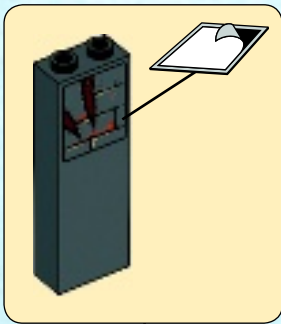



9

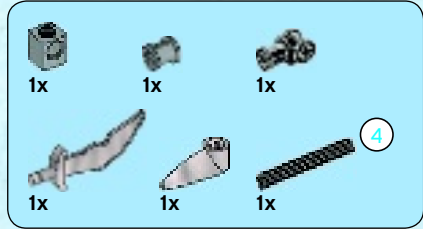
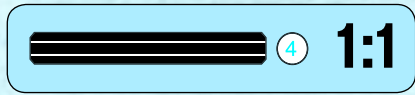
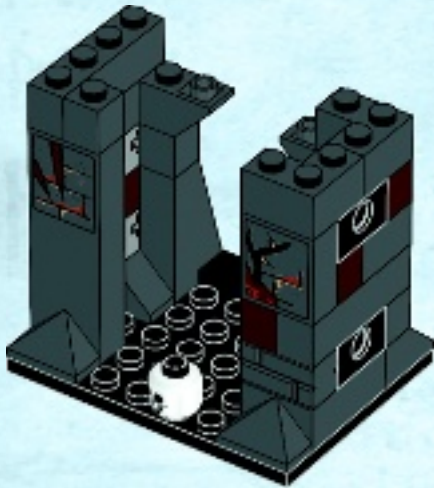

10

1

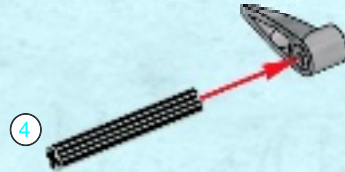

2

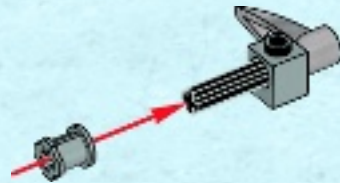



**3**

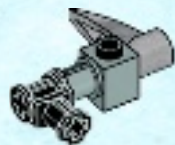

**4**



**5**

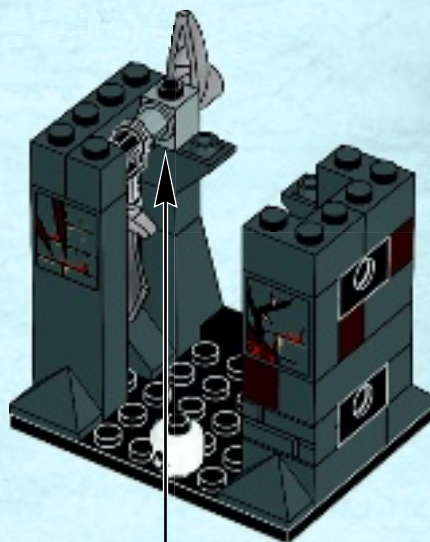
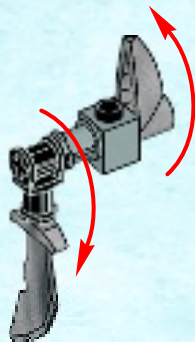



# 11

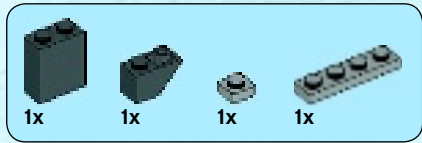
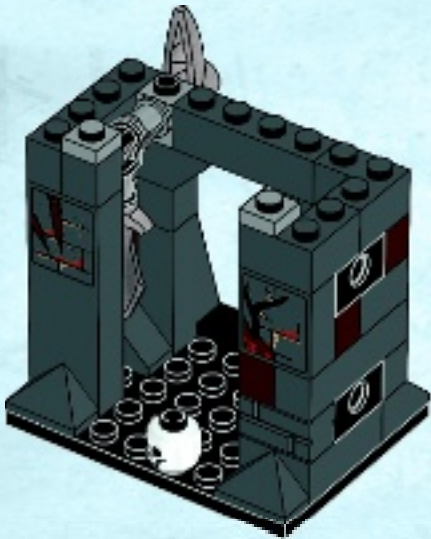

# 12

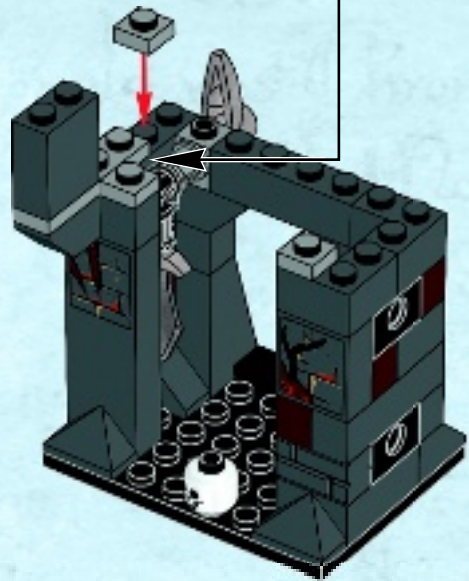
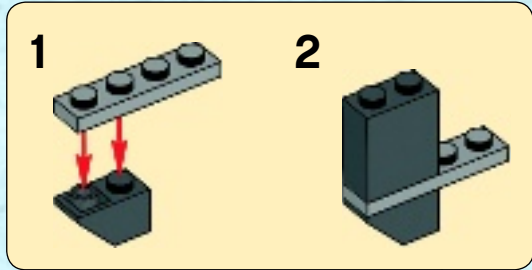

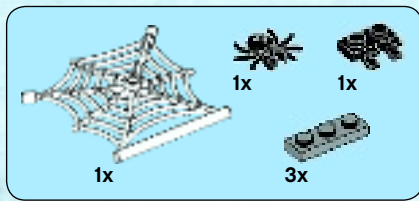

# 13

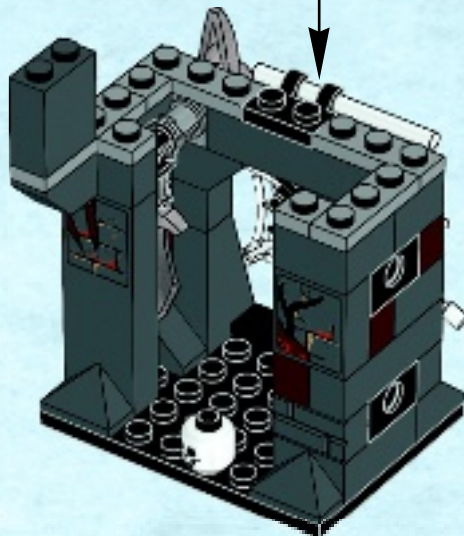
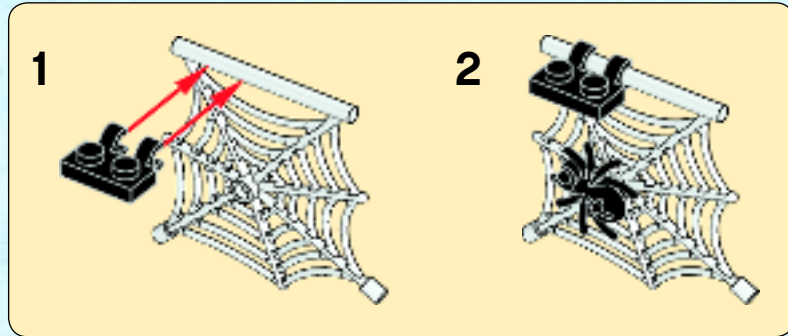



3x



2x



2x

# 14

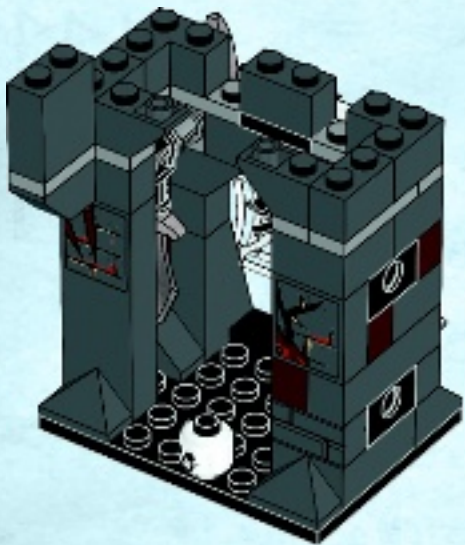

1x



2x

# 15

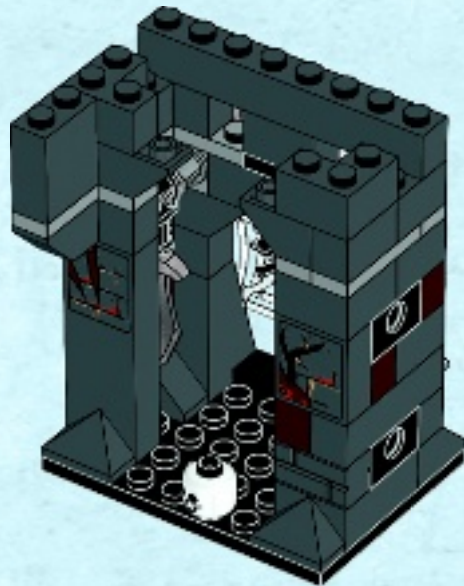



2x

# 16

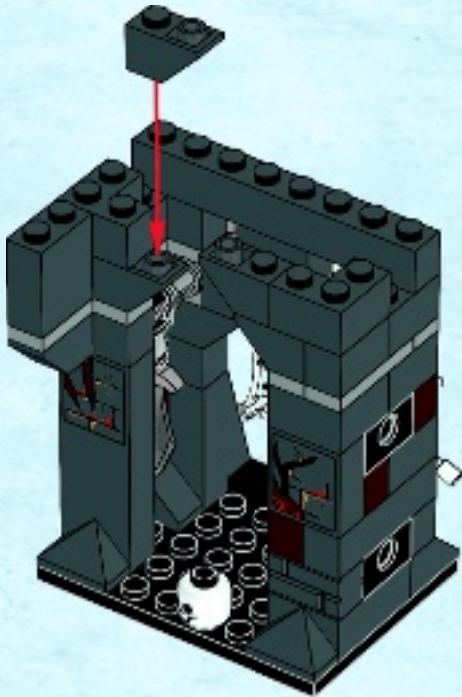

1x



1x



1x

# 17

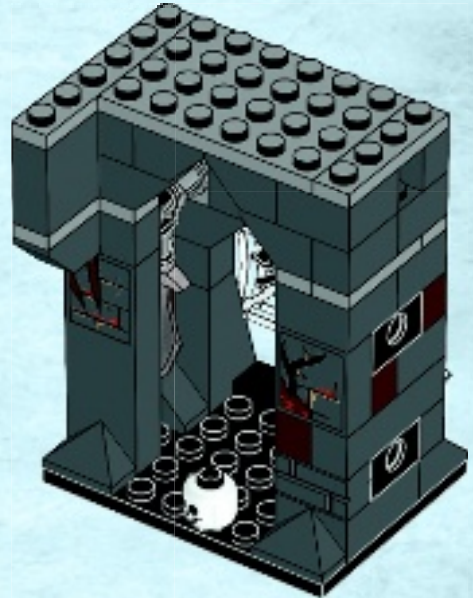



18

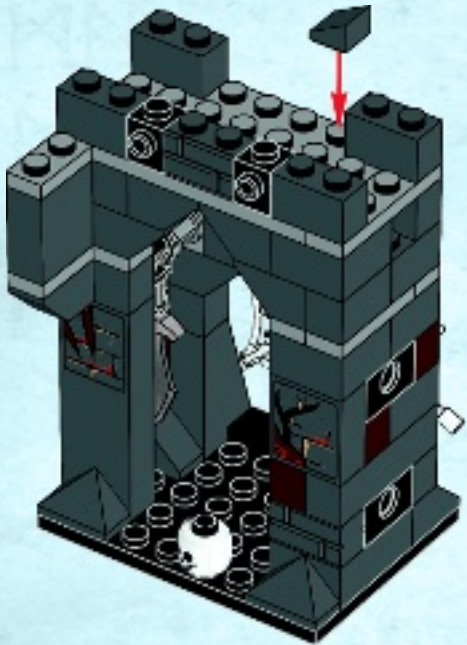

19

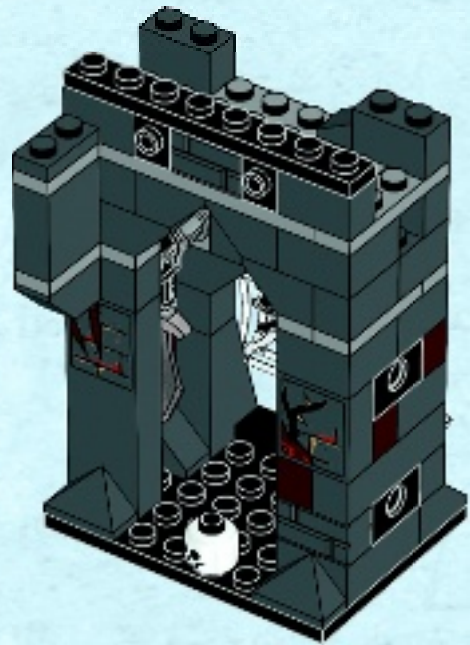

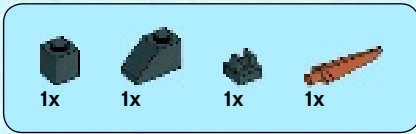

20

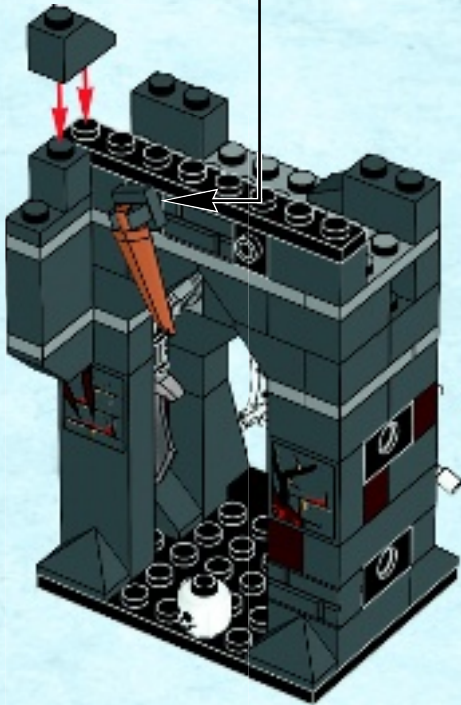
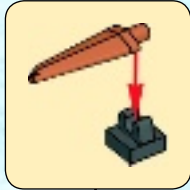

21

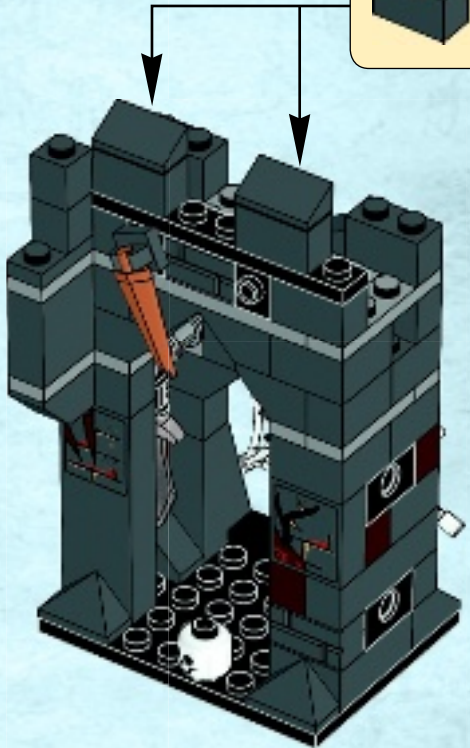
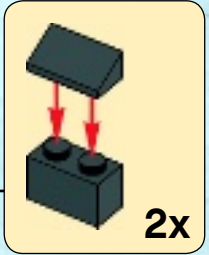

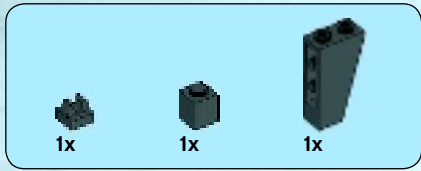

# 22

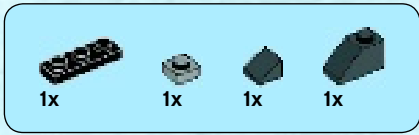
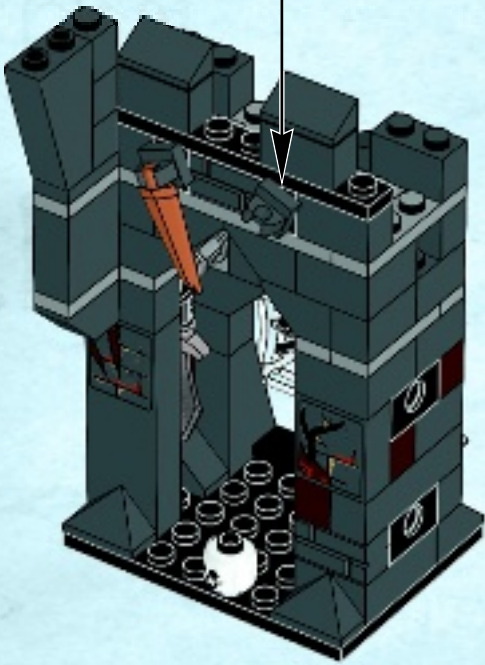

# 23

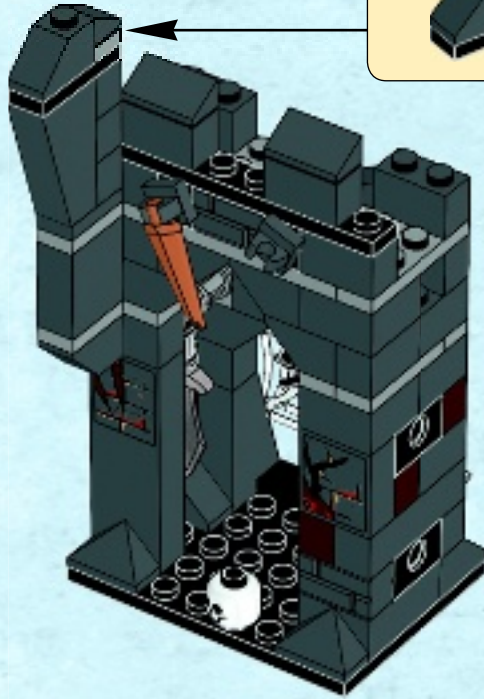
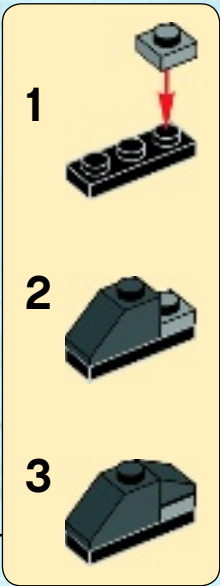



24

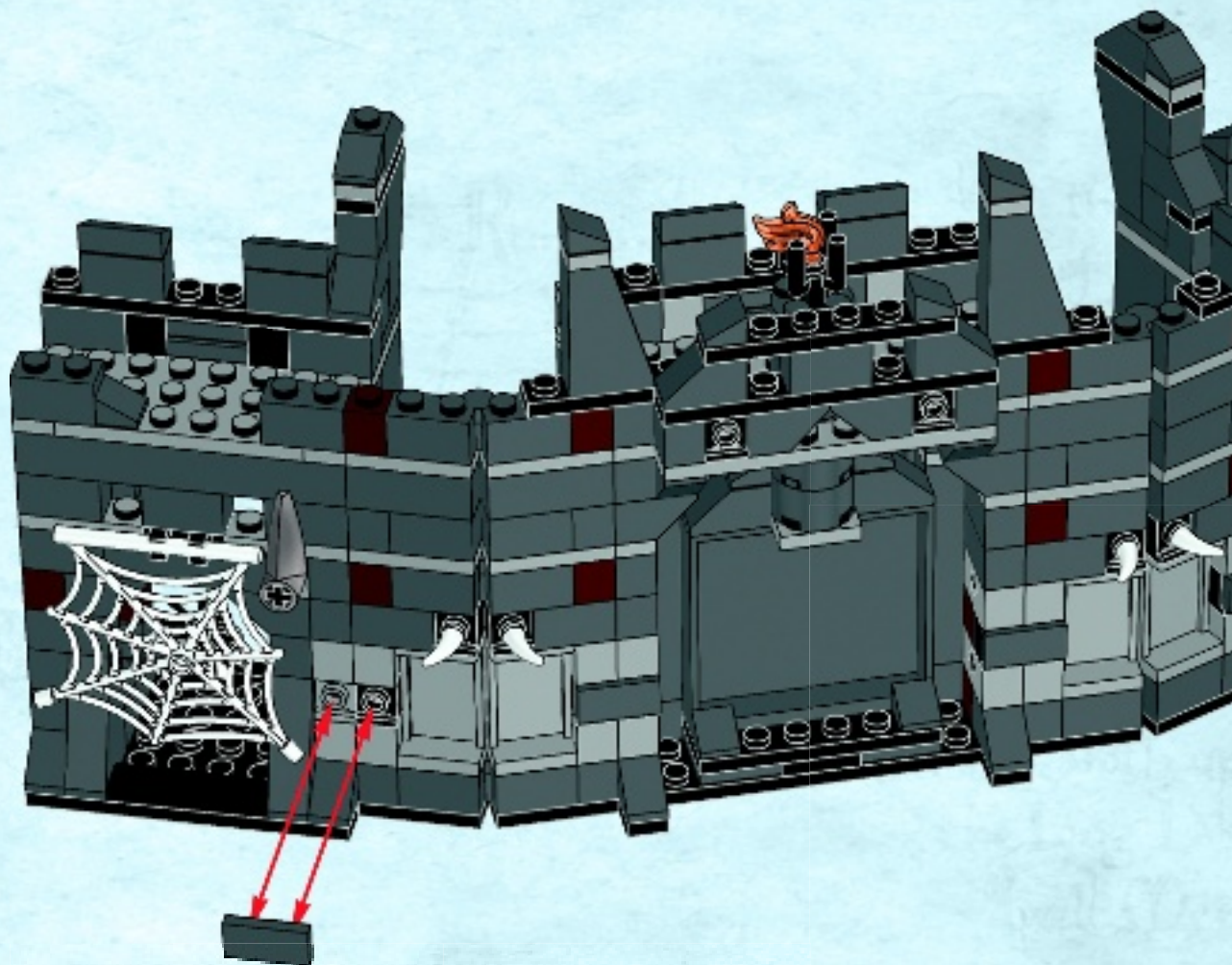
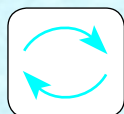



25

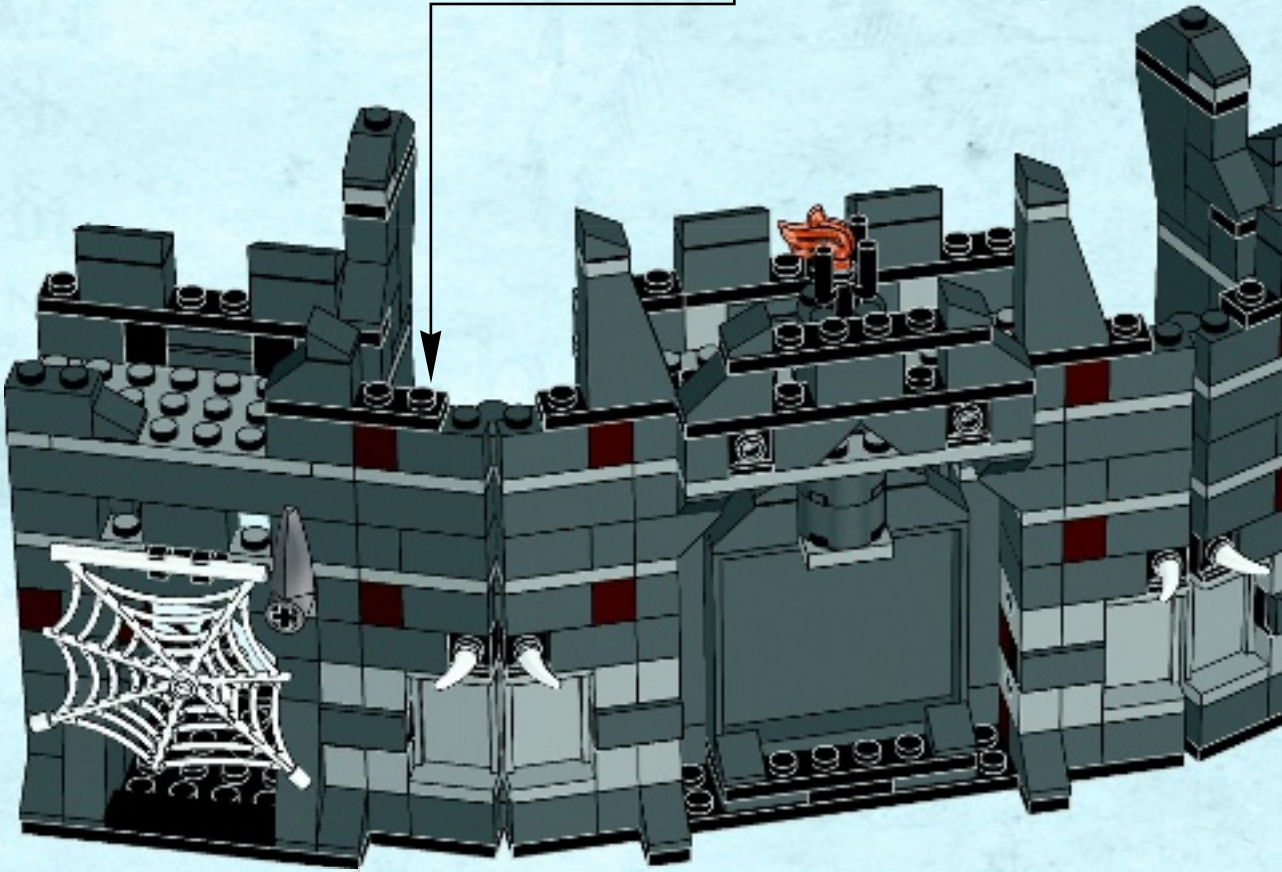
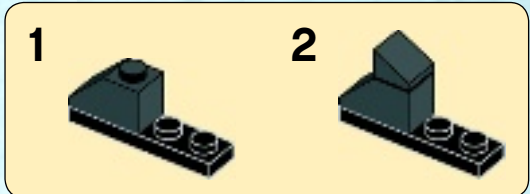

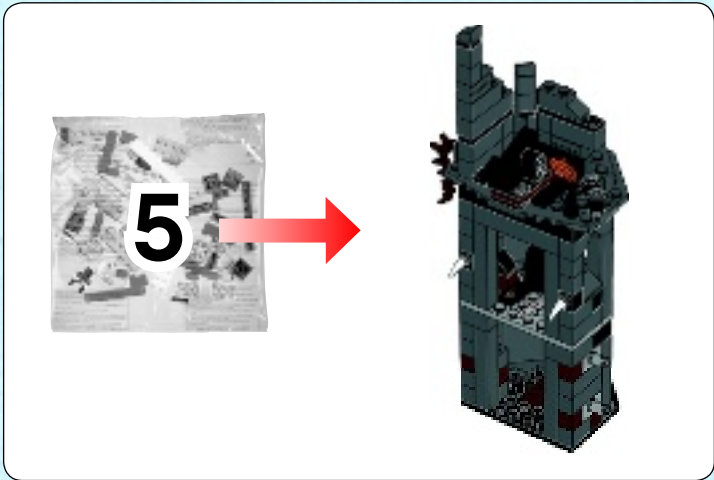

2

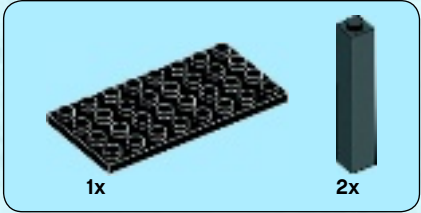

1

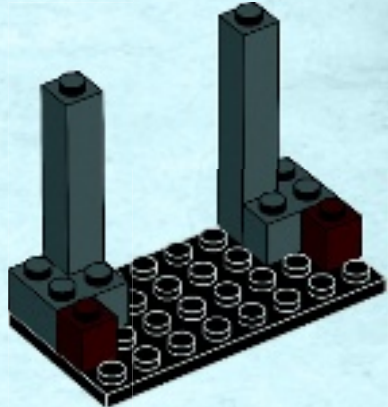
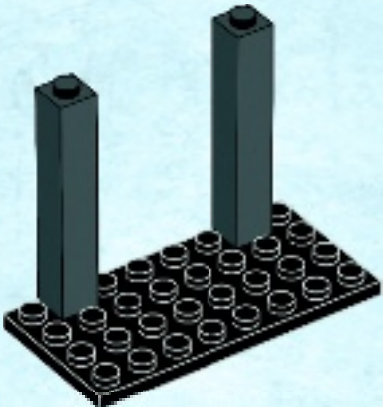

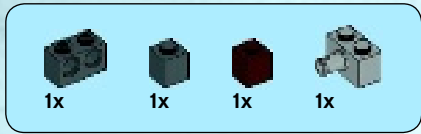

3

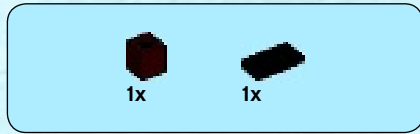
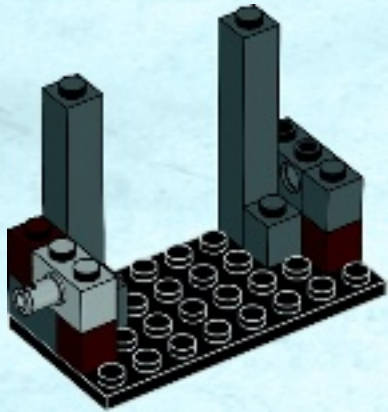

4

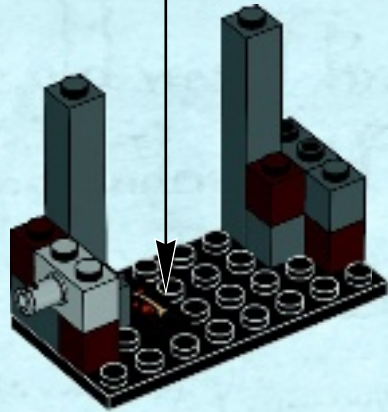
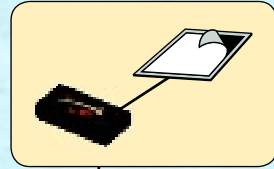



5

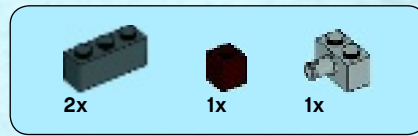
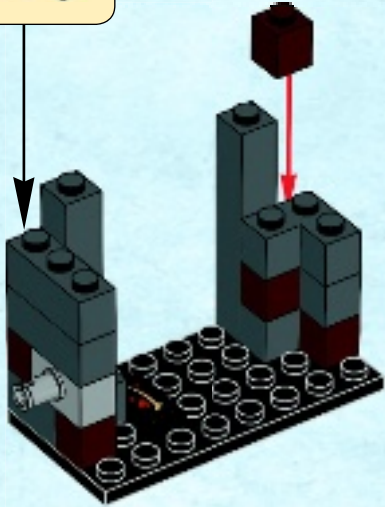
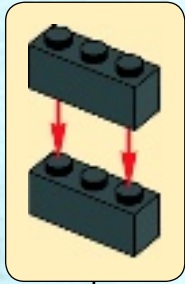

6

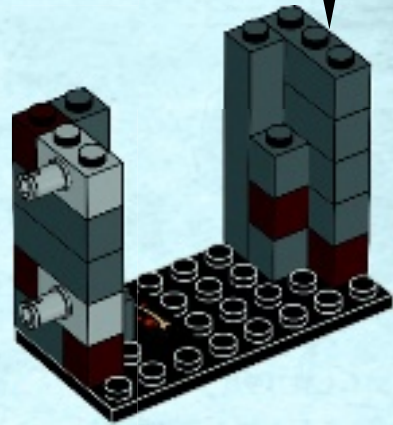
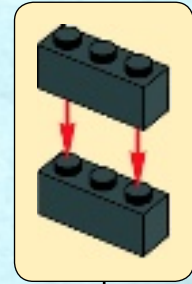



2x

7

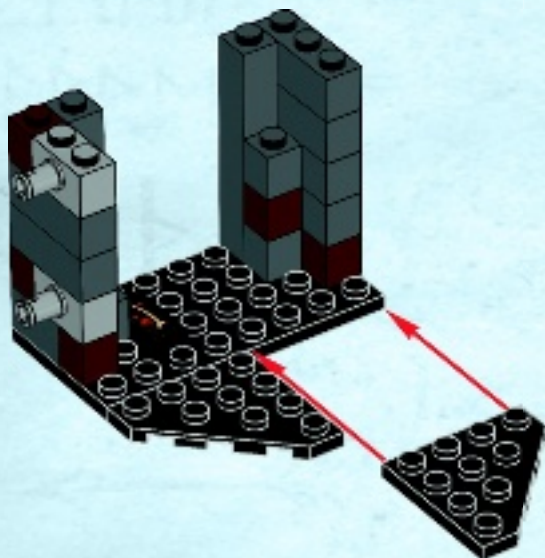

1x



1x

8

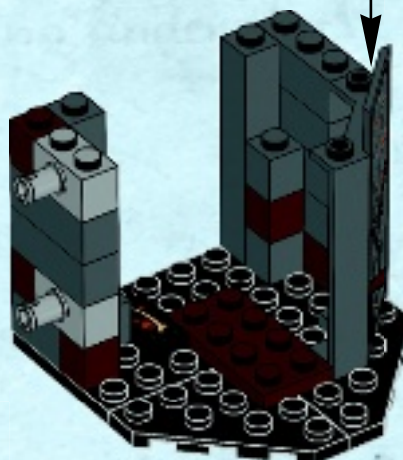
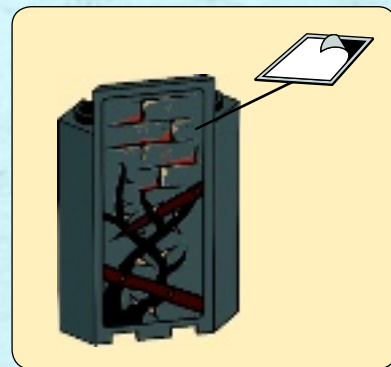

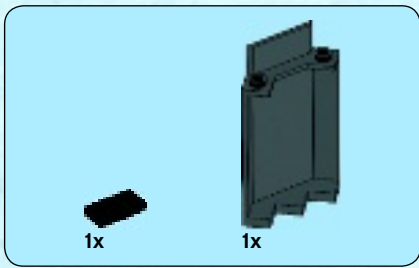

9

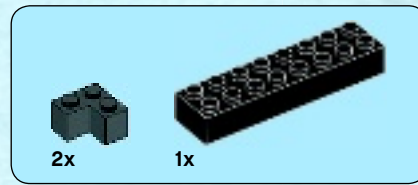
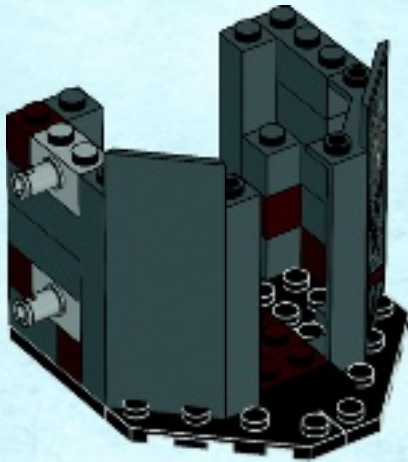

10

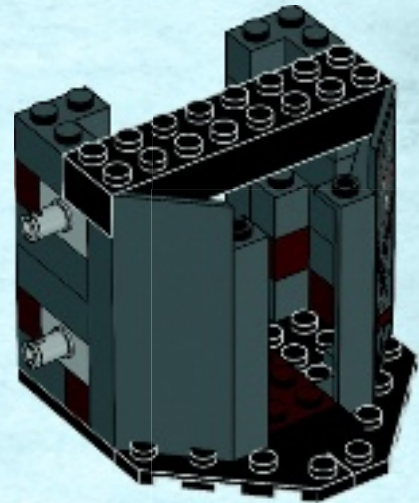

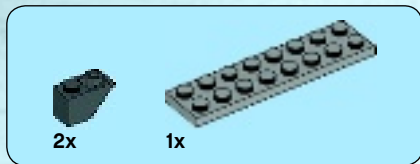

# 11

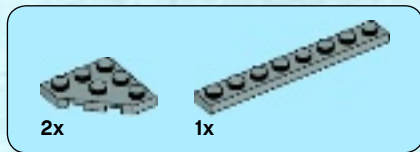
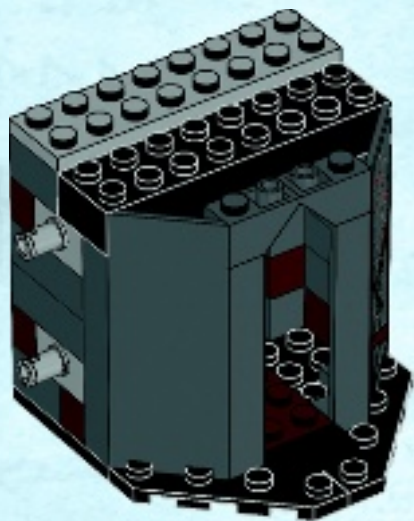

# 12

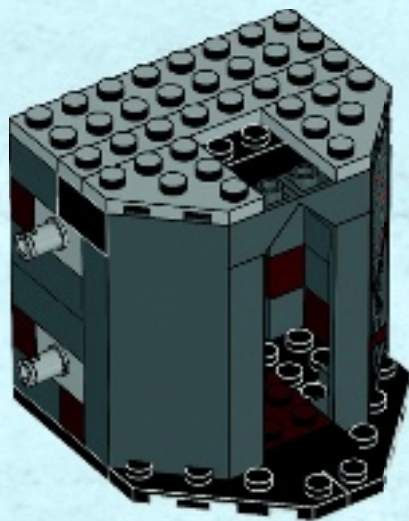





13

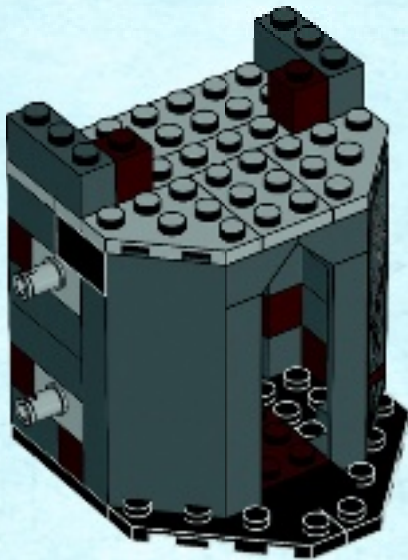

14

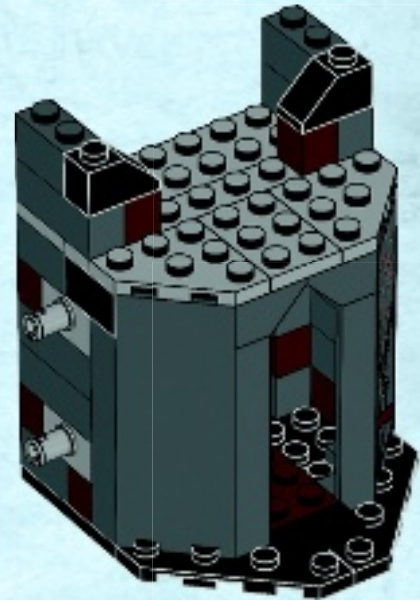



3x



1x

# 15

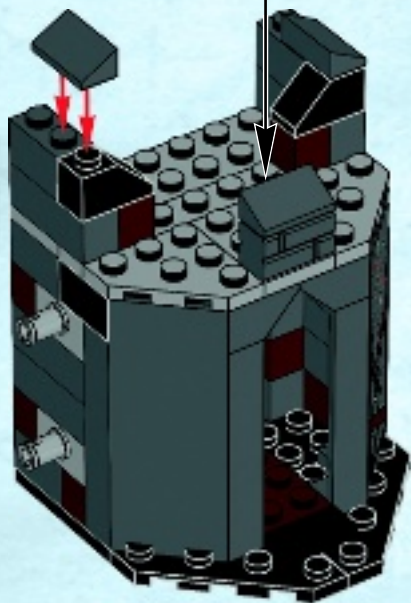
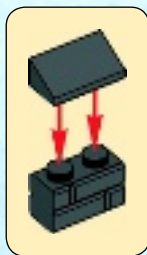

1x

# 16

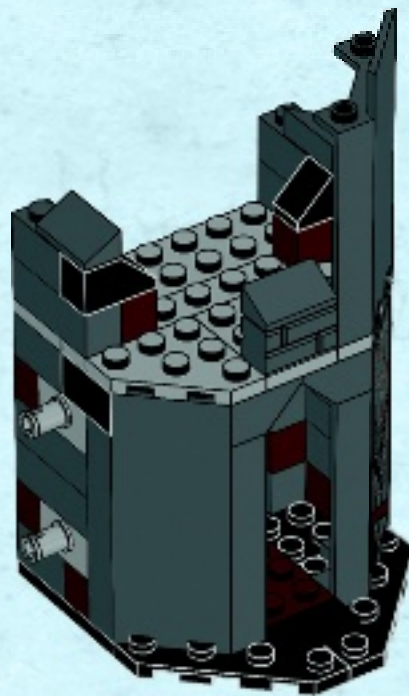

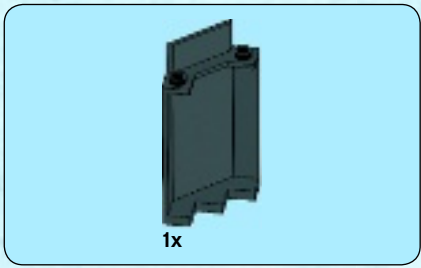

17

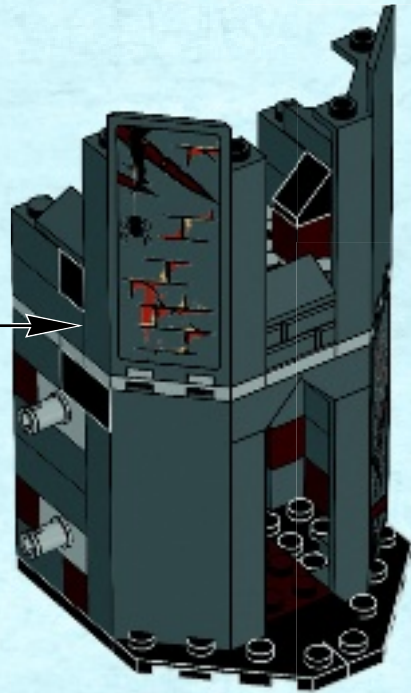
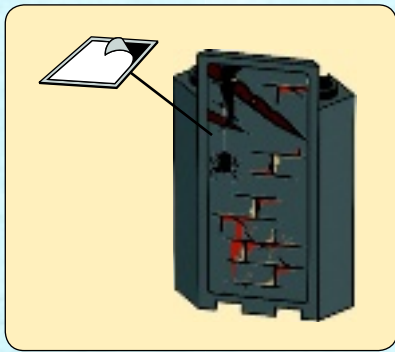

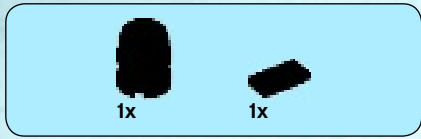

# 18

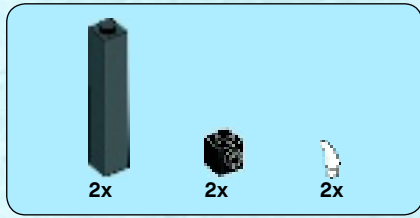
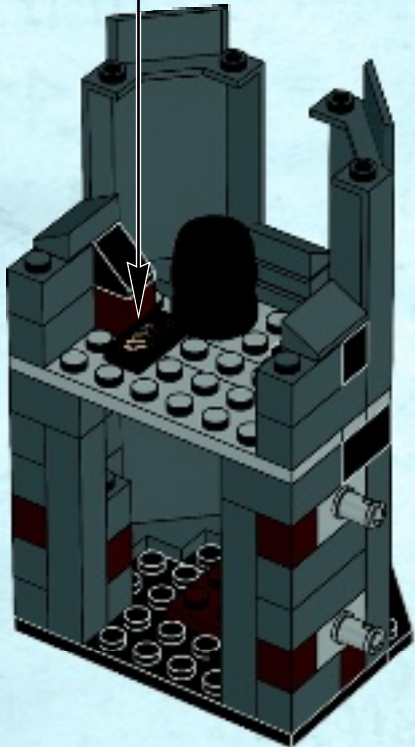
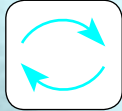
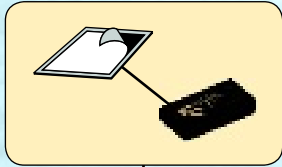

# 19

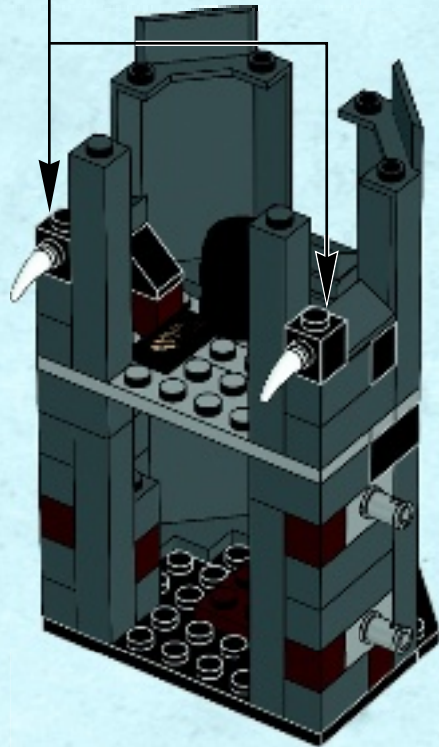
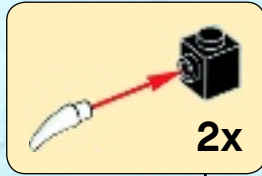

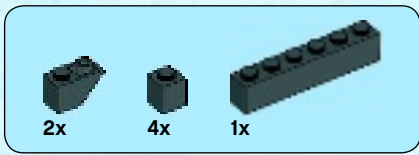

# 20

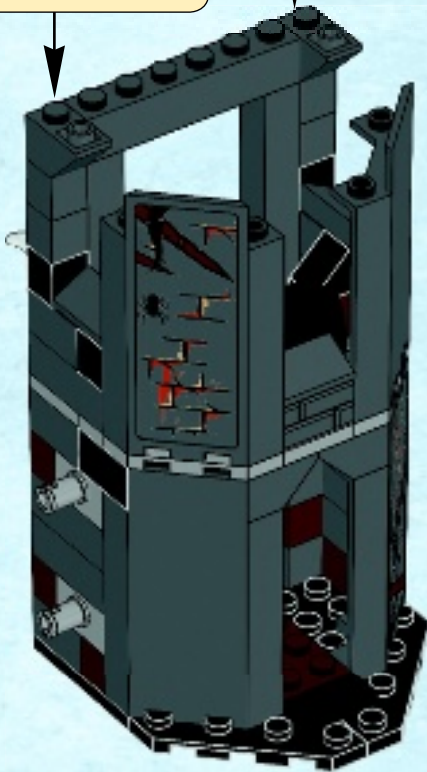
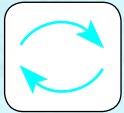
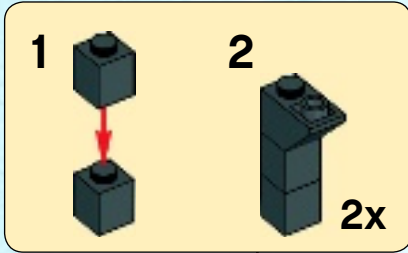

# 21



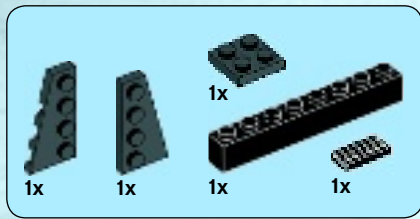

# 22

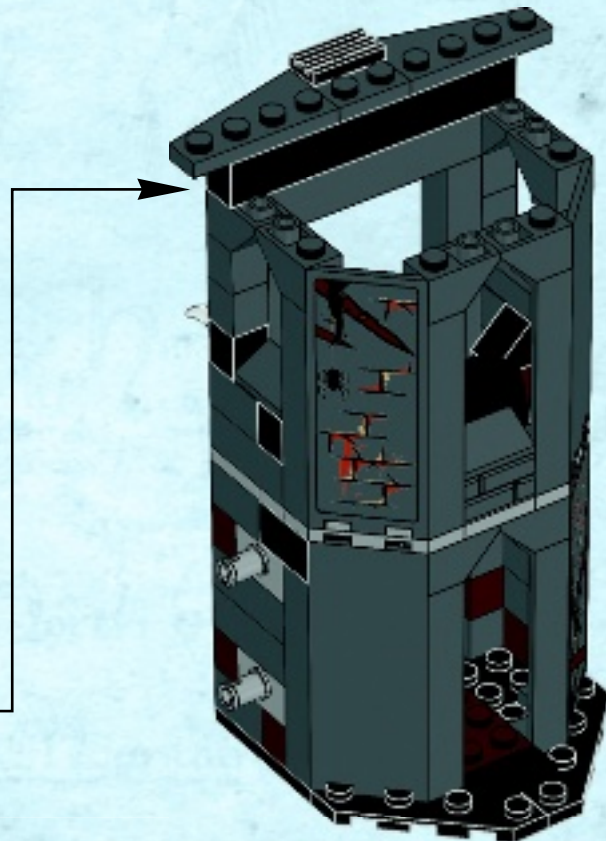
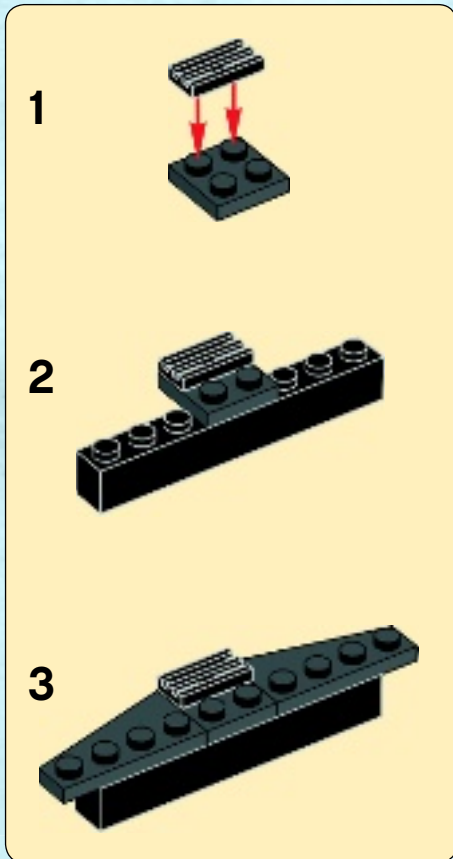



3x

# 23

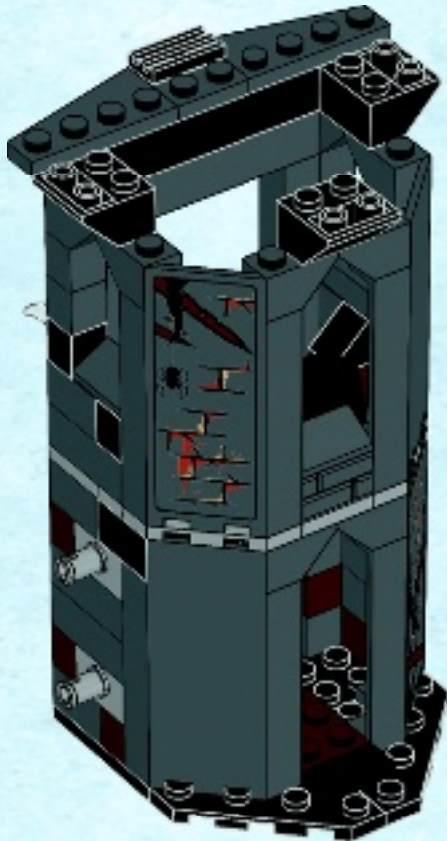

1x

1x

# 24

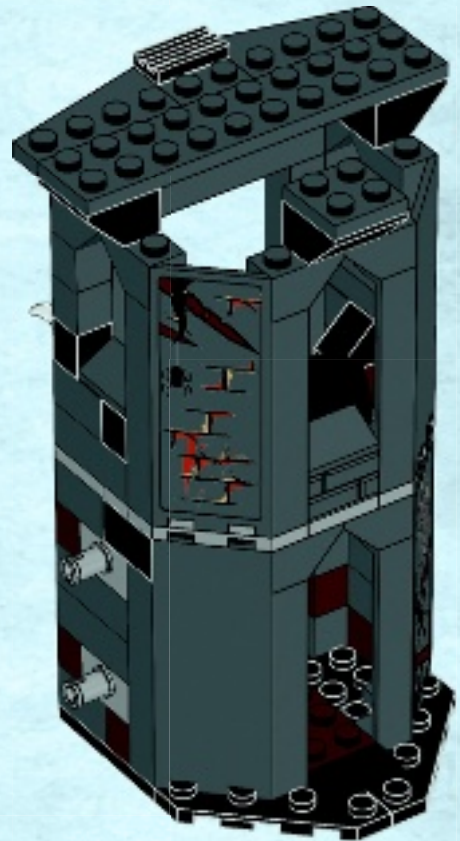



25

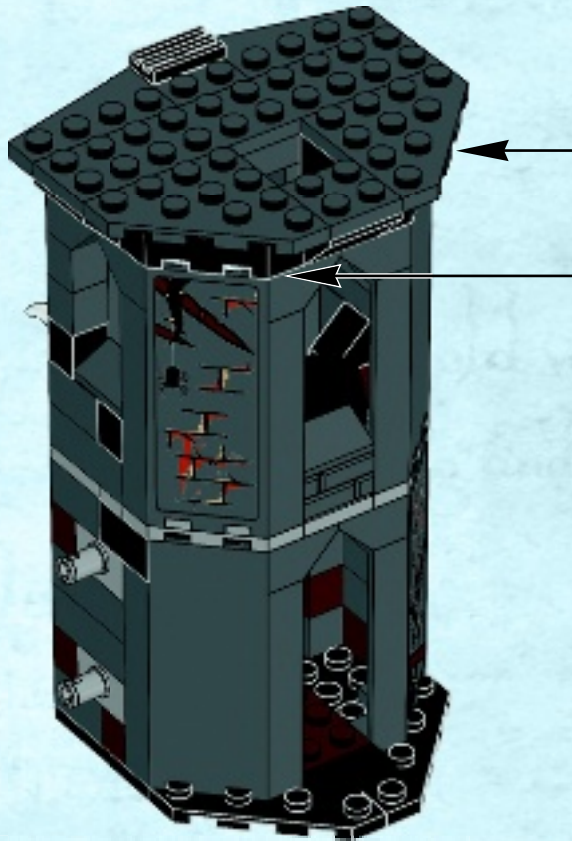
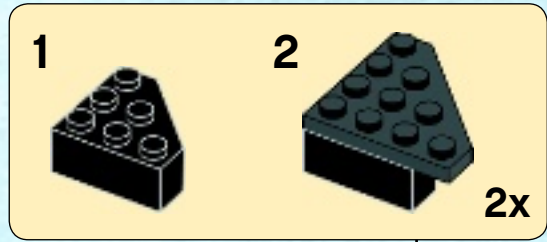





3x



1x

# 26

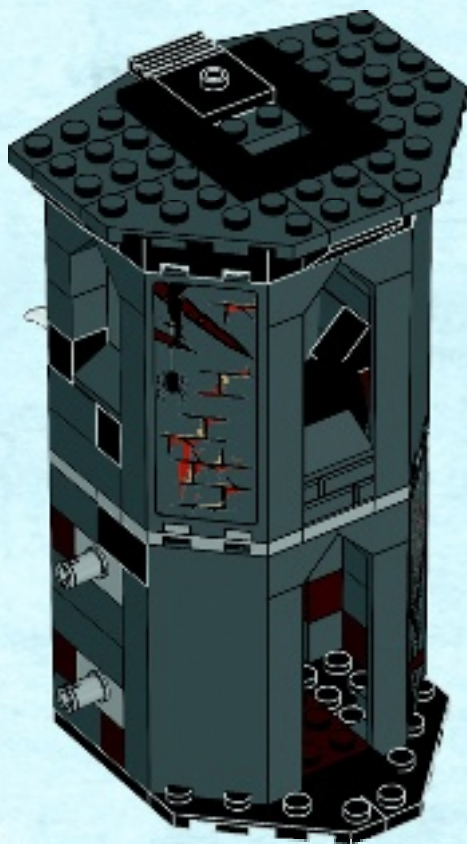



27

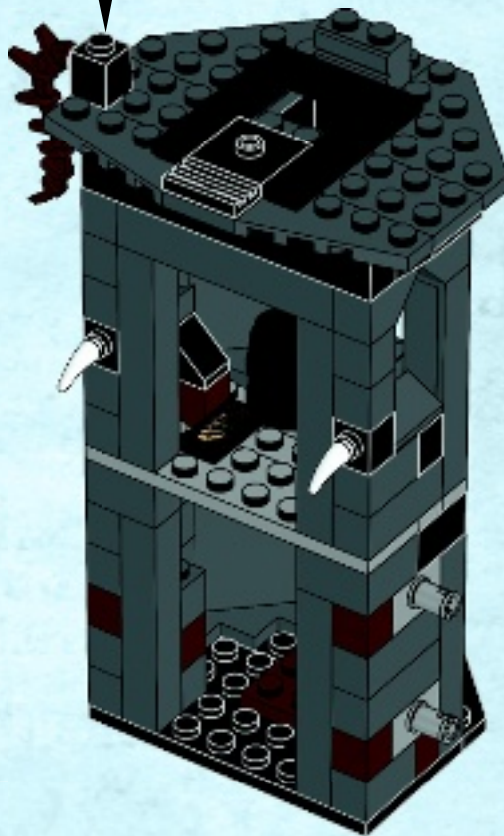
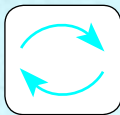
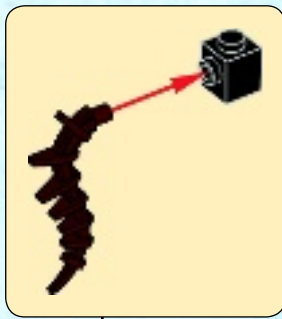

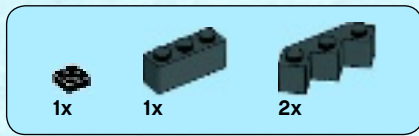

28

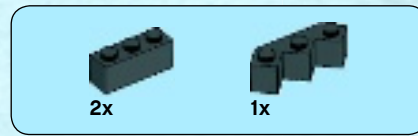
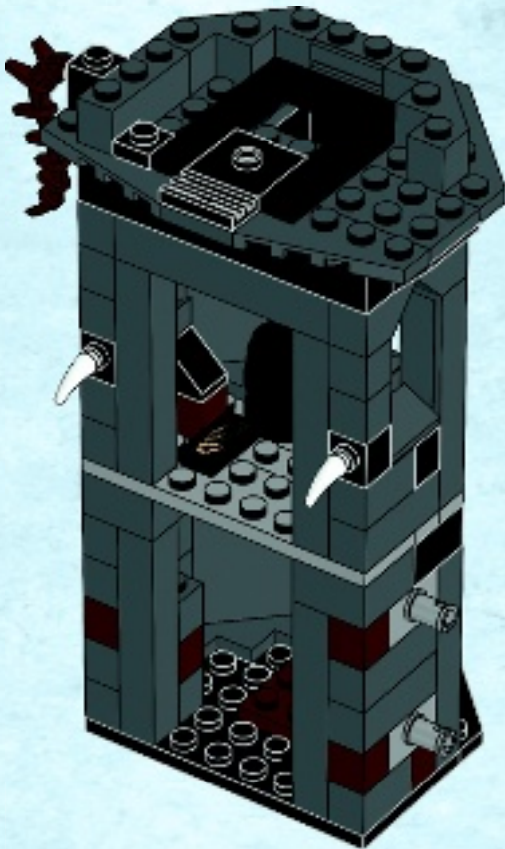

29

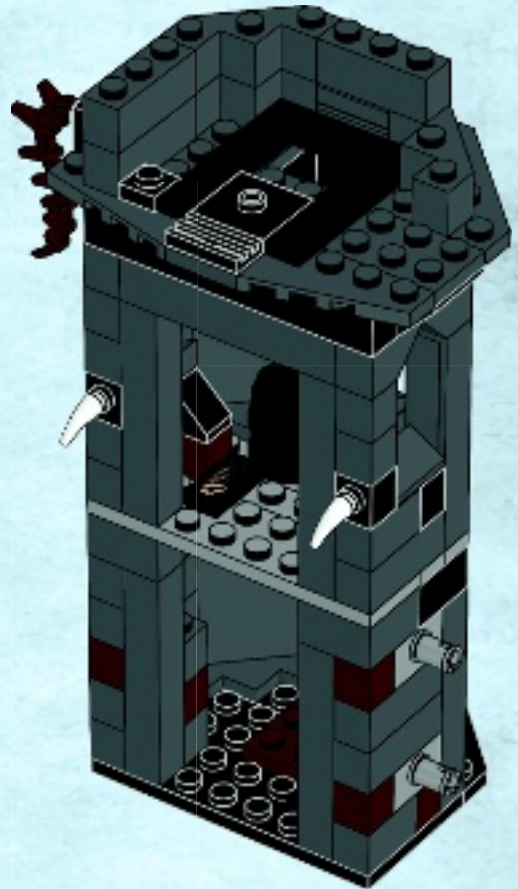

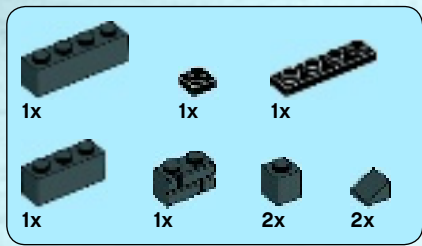

# 30

1

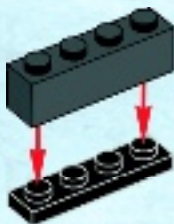

2

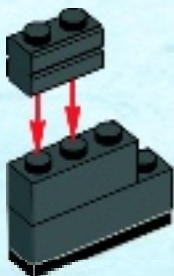

3

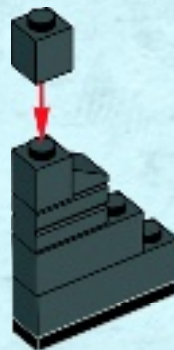

4



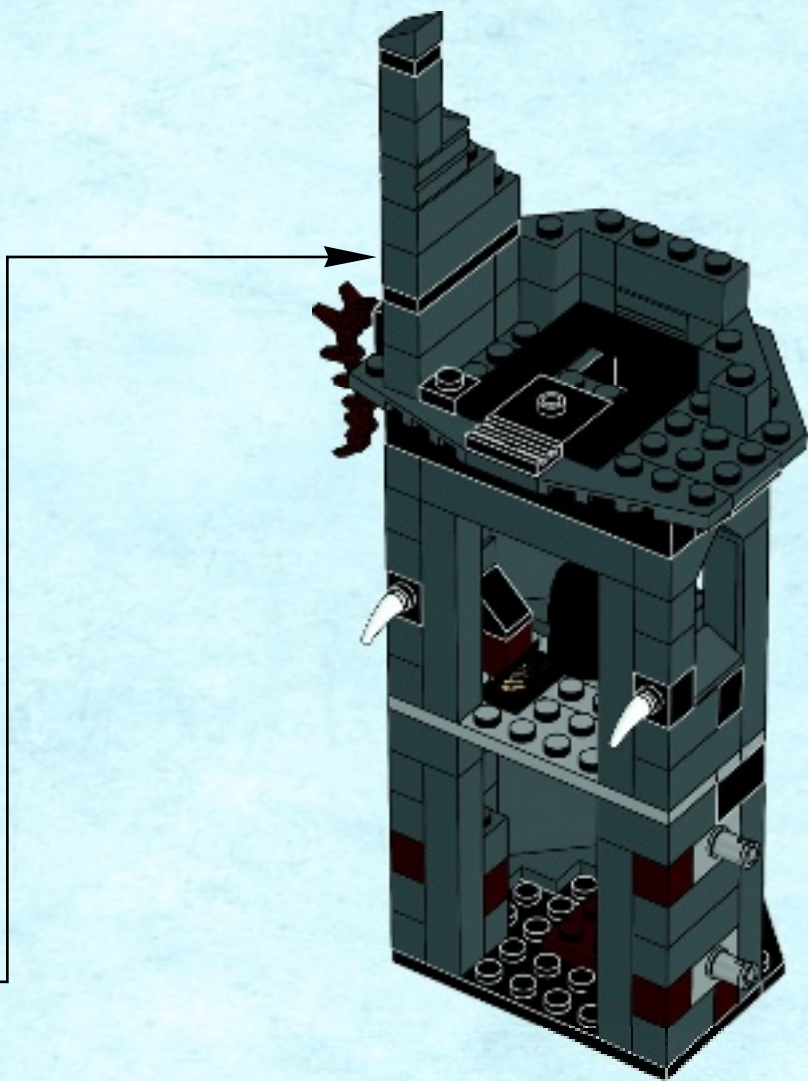

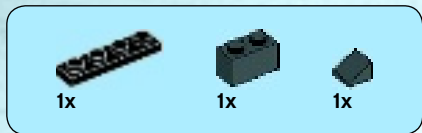

31

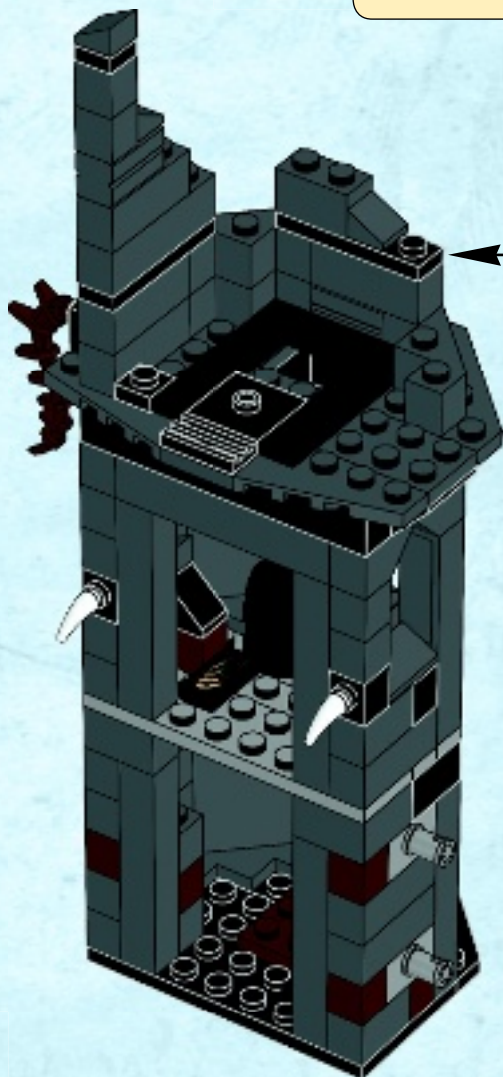
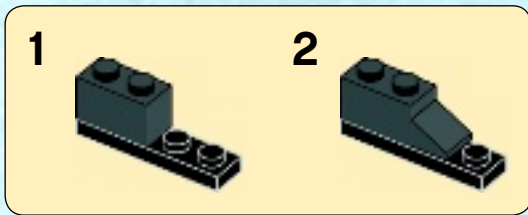

1x 2x 1x

32

1 2 3

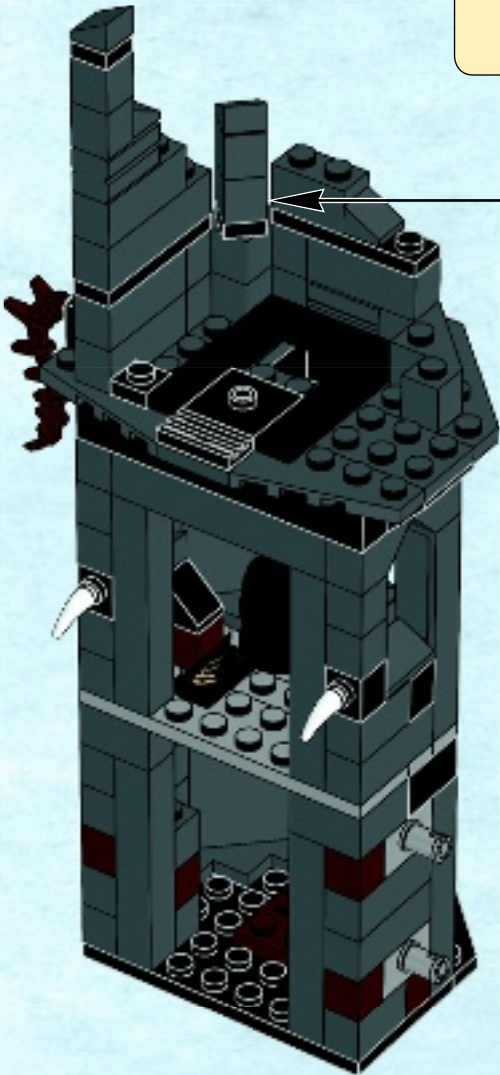

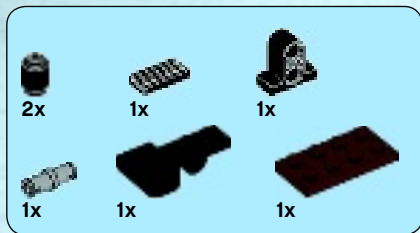

# 33

1



2



3

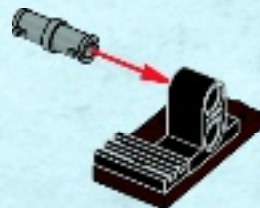

4





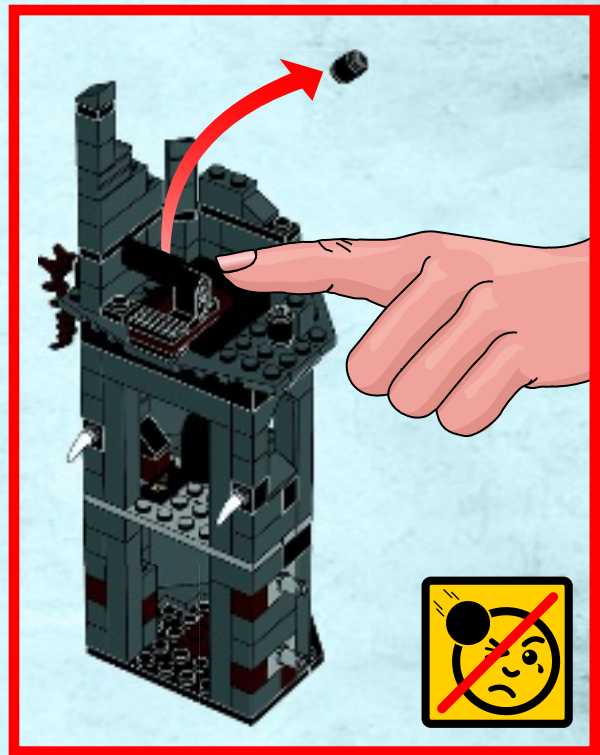
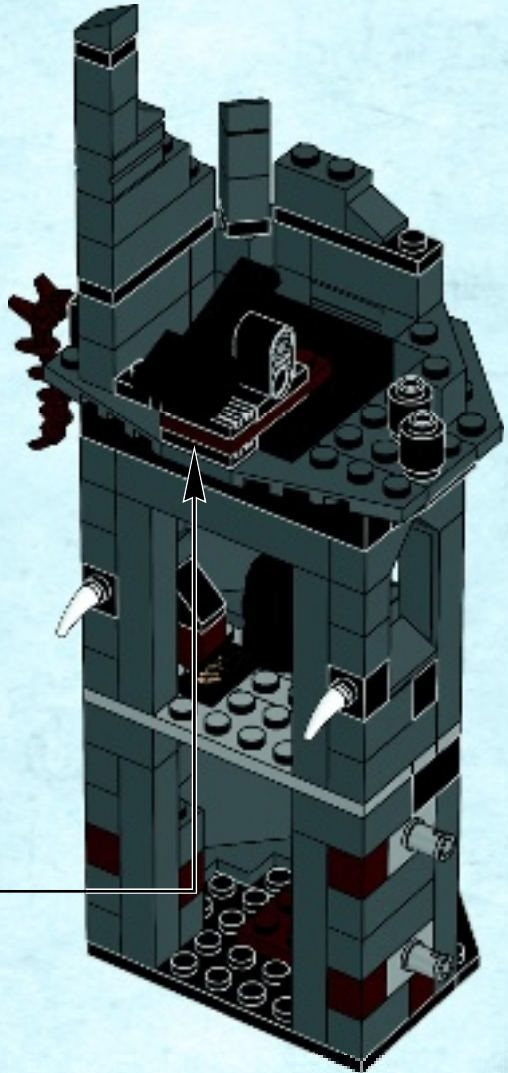

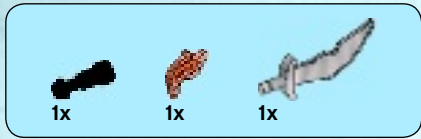

# 34

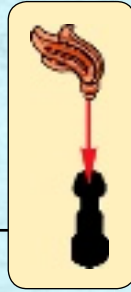
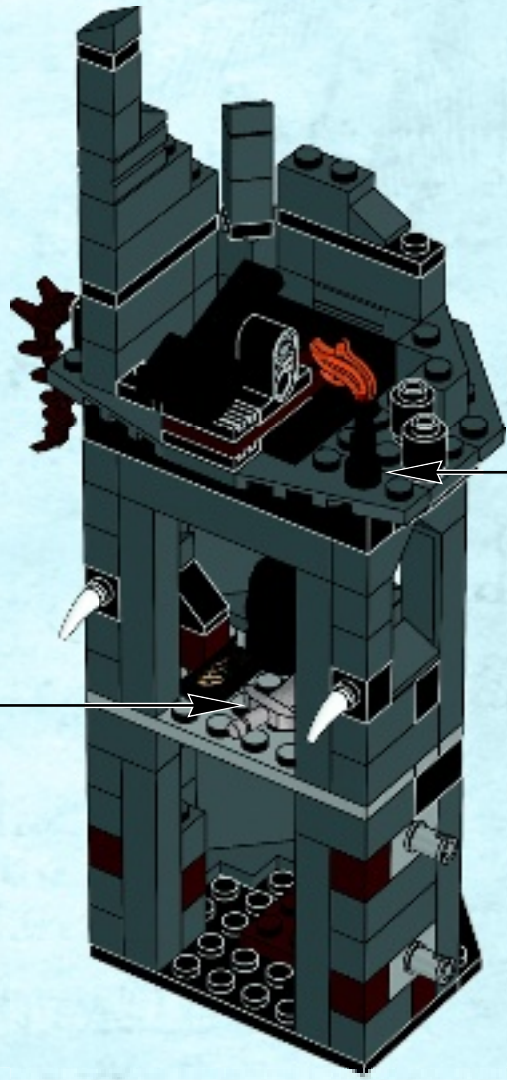

35

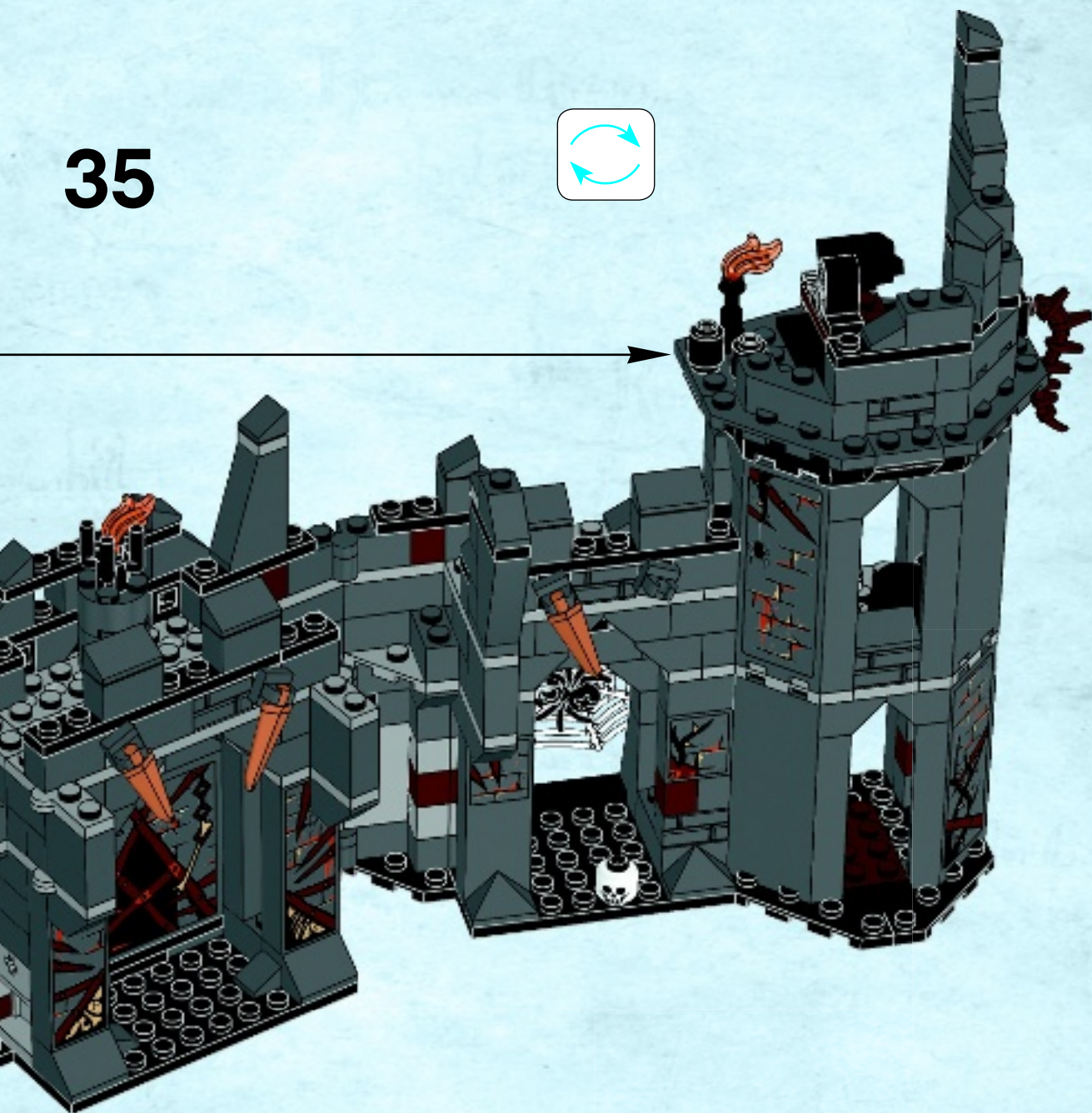
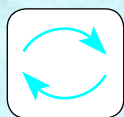



6

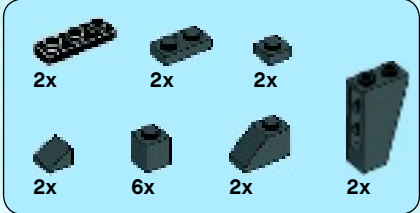
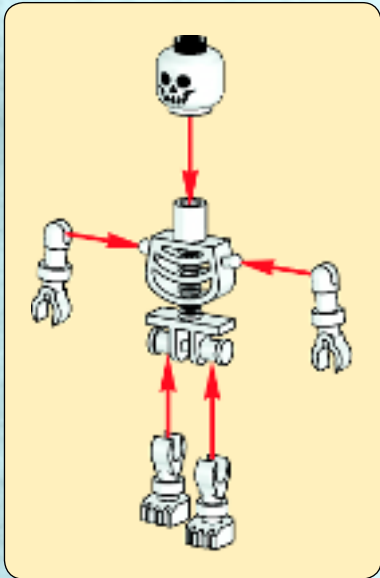

36

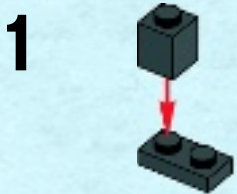

2



3



4



5

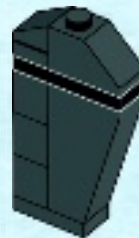

2x

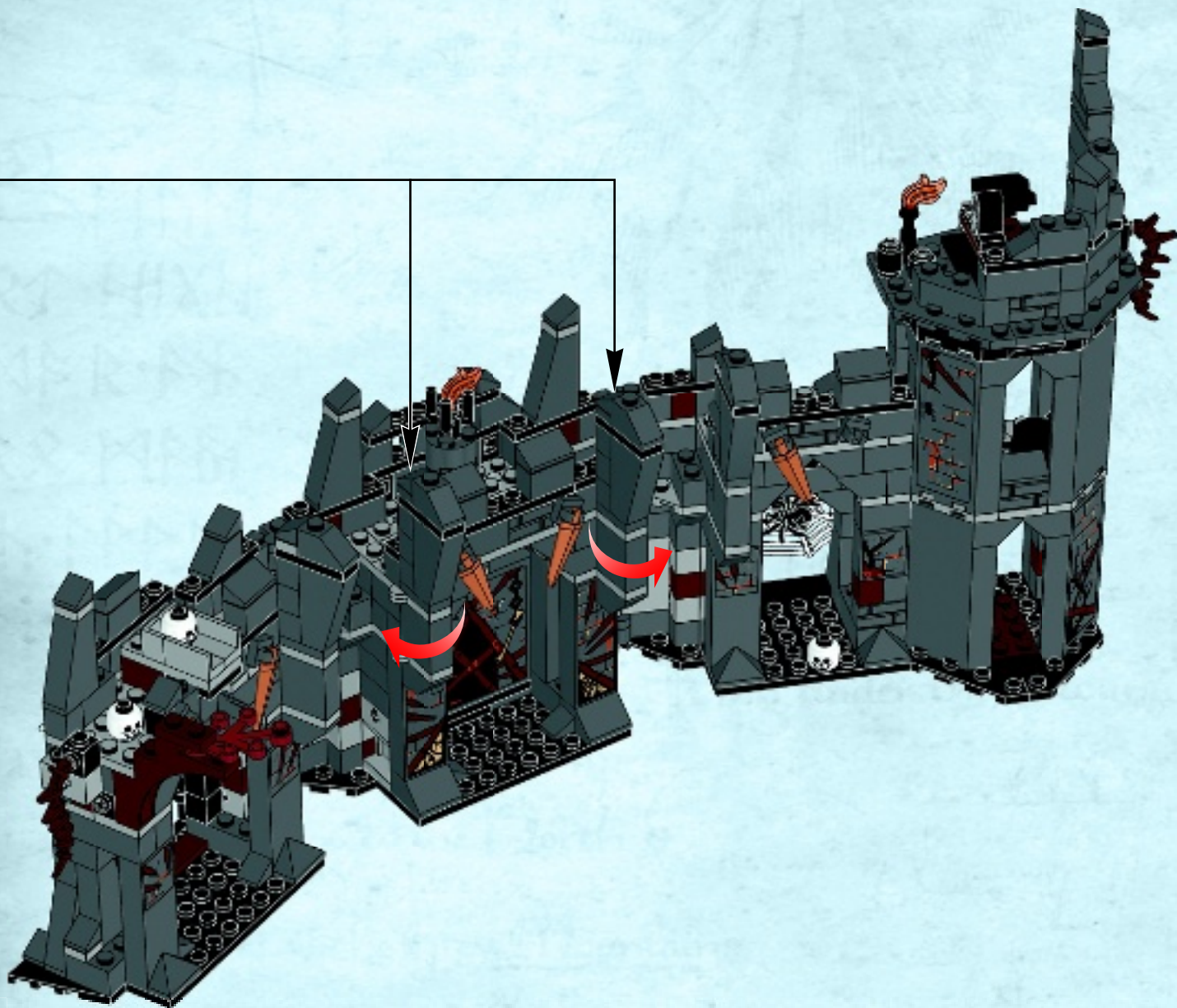



**1**

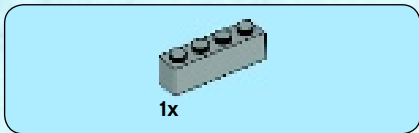

**2**

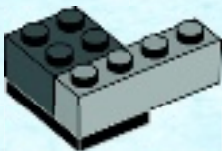

**3**

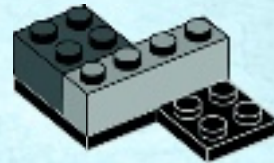

**4**

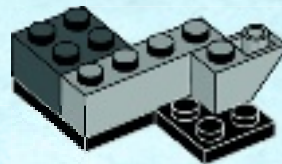



1x

5

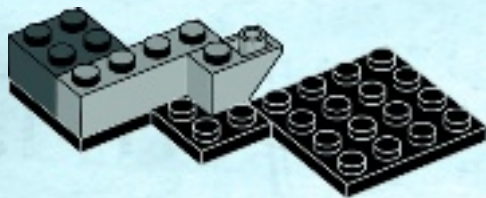

1x



1x

6

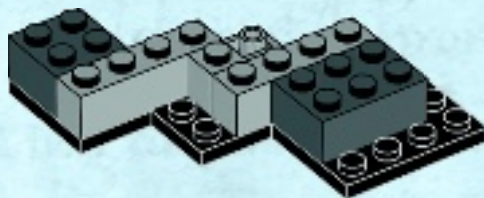





1x



2x

7

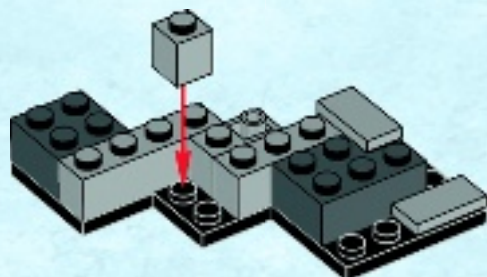

1x



1x

8

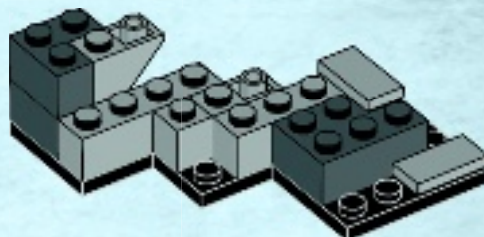



1x



1x

# 9

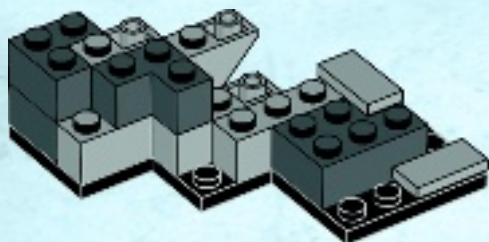

1x



1x

# 10





1x



1x

# 11

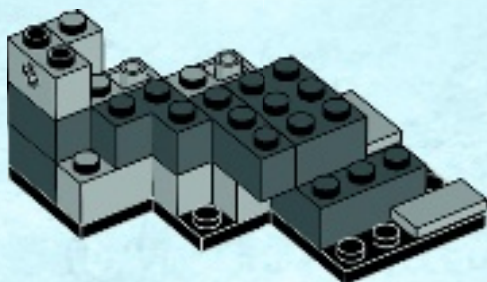

1x



1x



1x

# 12

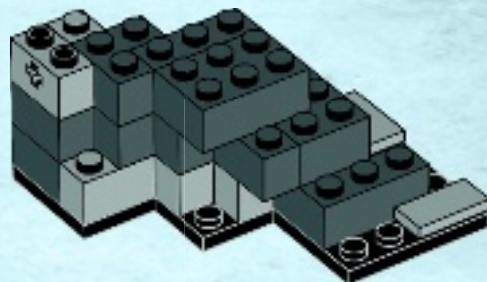



1x



2x

# 13

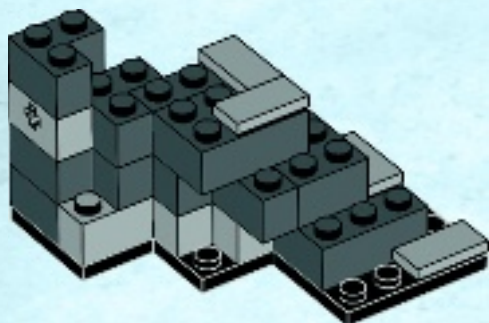

1x



1x

# 14

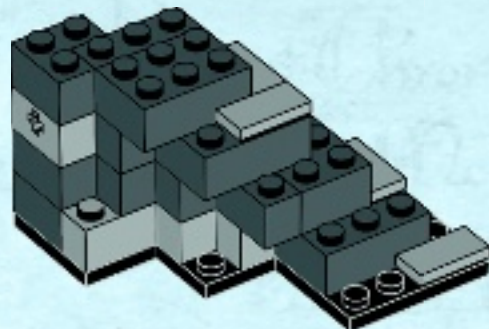

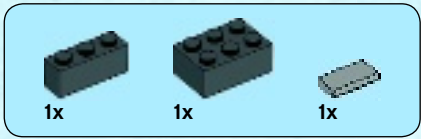

15

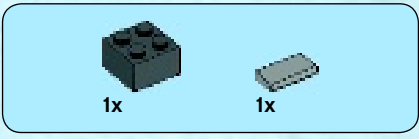
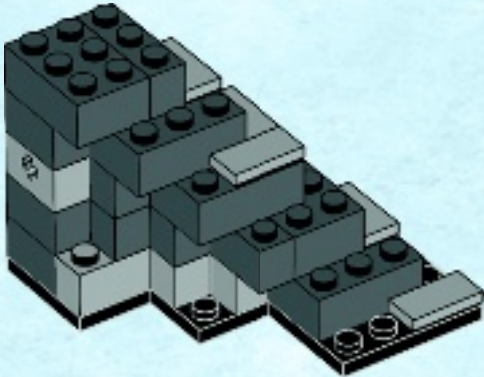

16

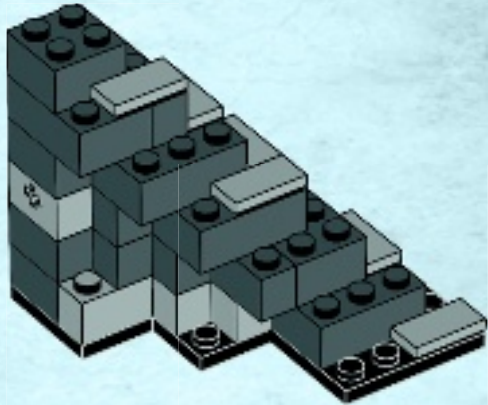



1x



2x



1x

# 17

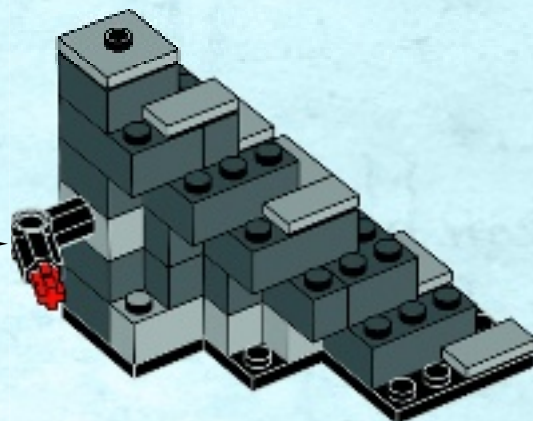
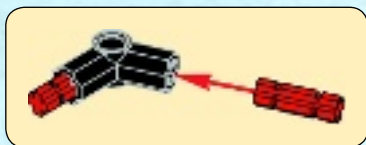

37

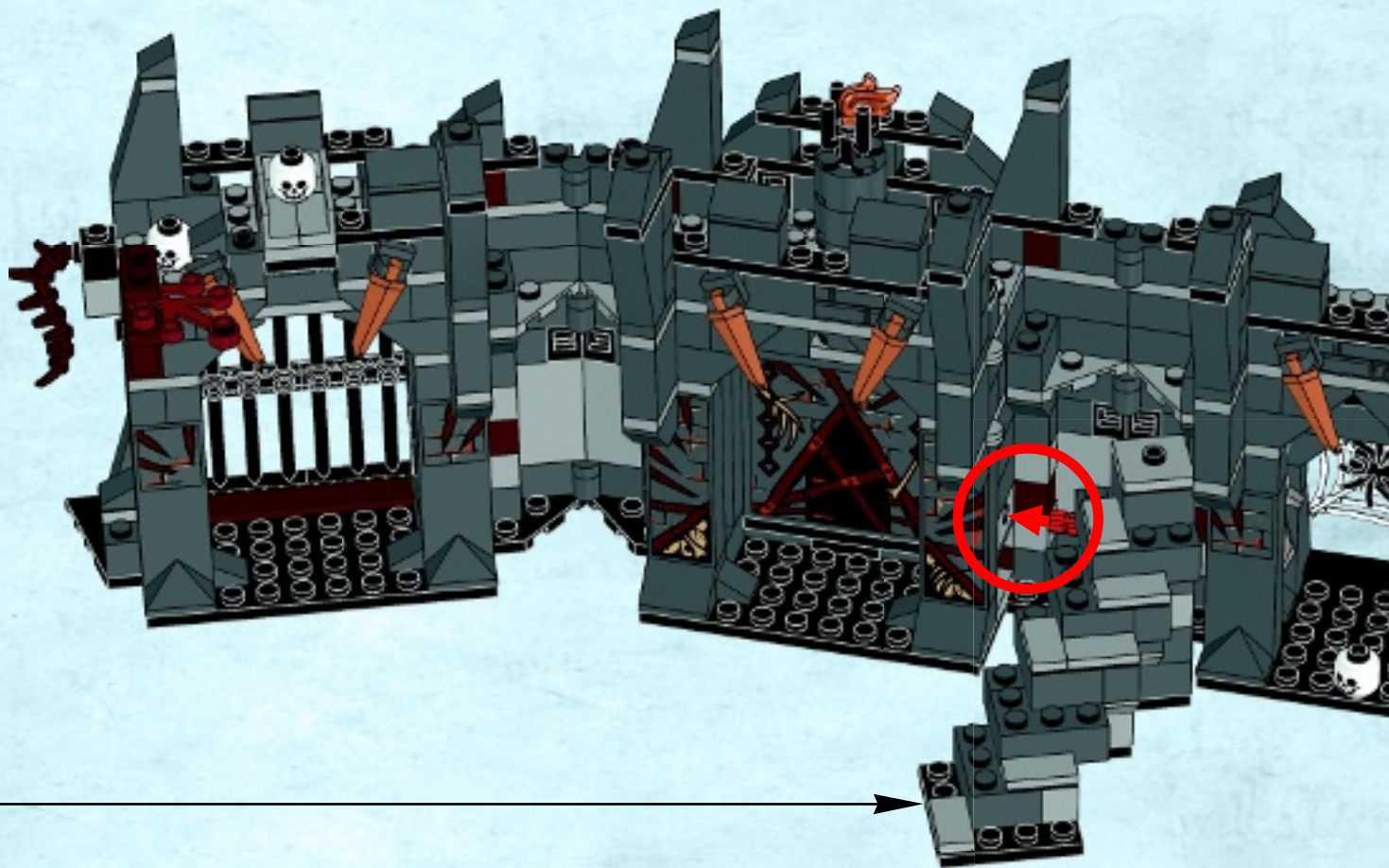



**1**

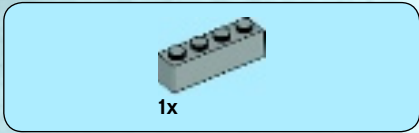

**2**

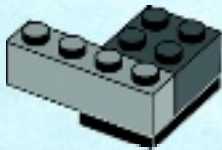

**3**

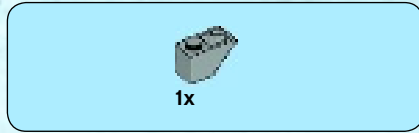

**4**

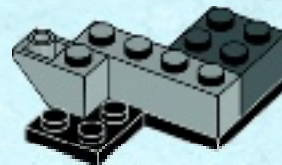





1x

5

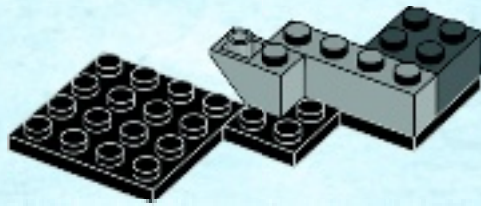

1x



1x

6

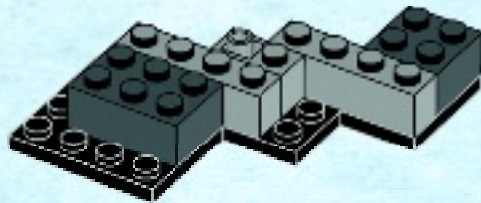

1x



2x

7

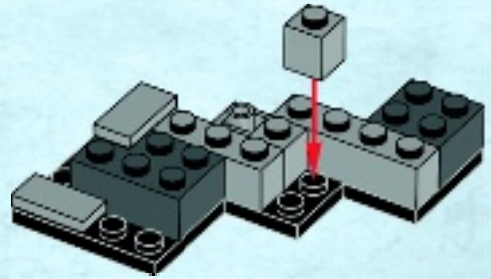

1x



1x

8

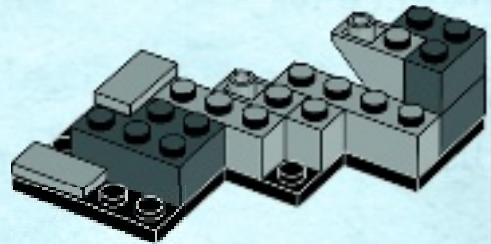



1x



1x

9

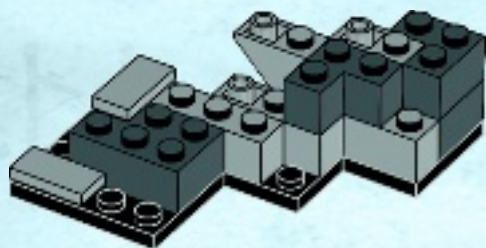

1x



1x

10





1x



1x

# 11

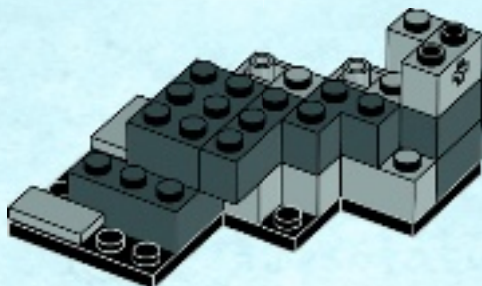

1x



1x



1x

# 12

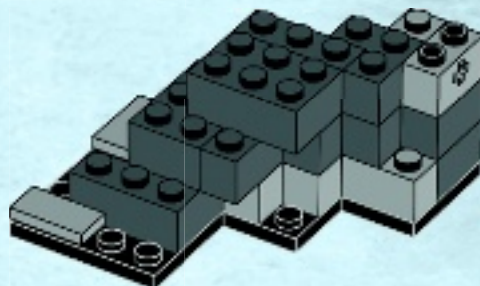



1x



2x

# 13

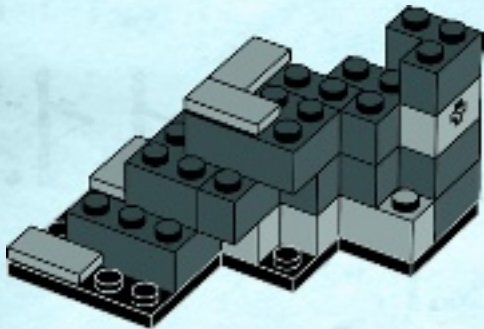

1x



1x

# 14

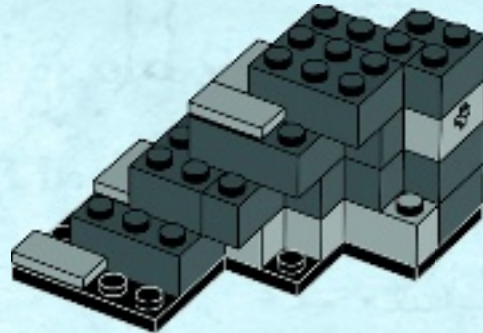

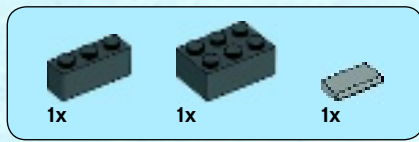

15

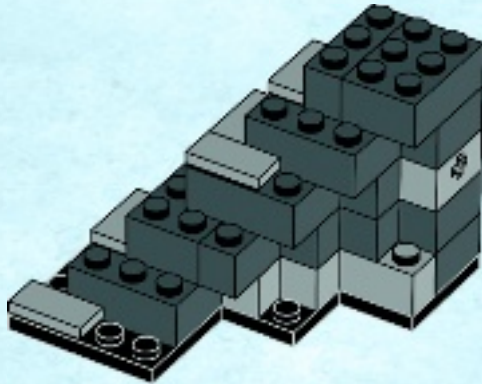

16

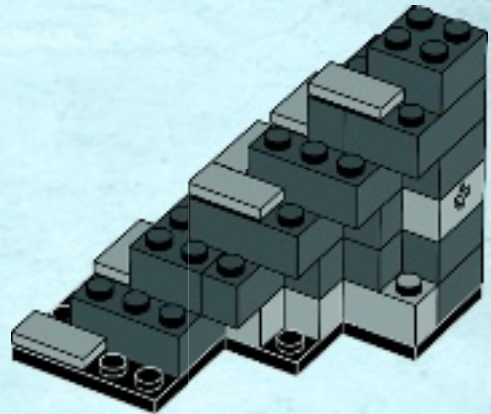



1x



2x



1x

# 17

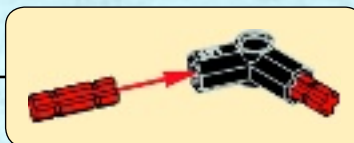
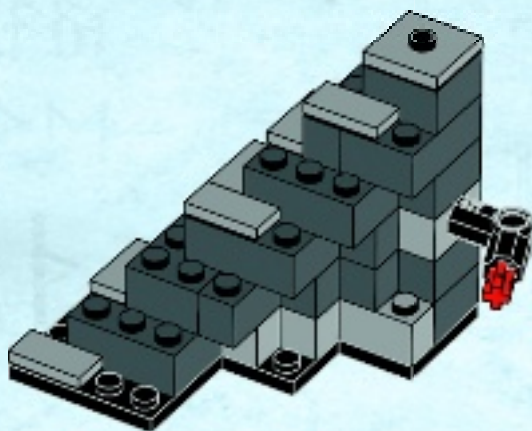

38

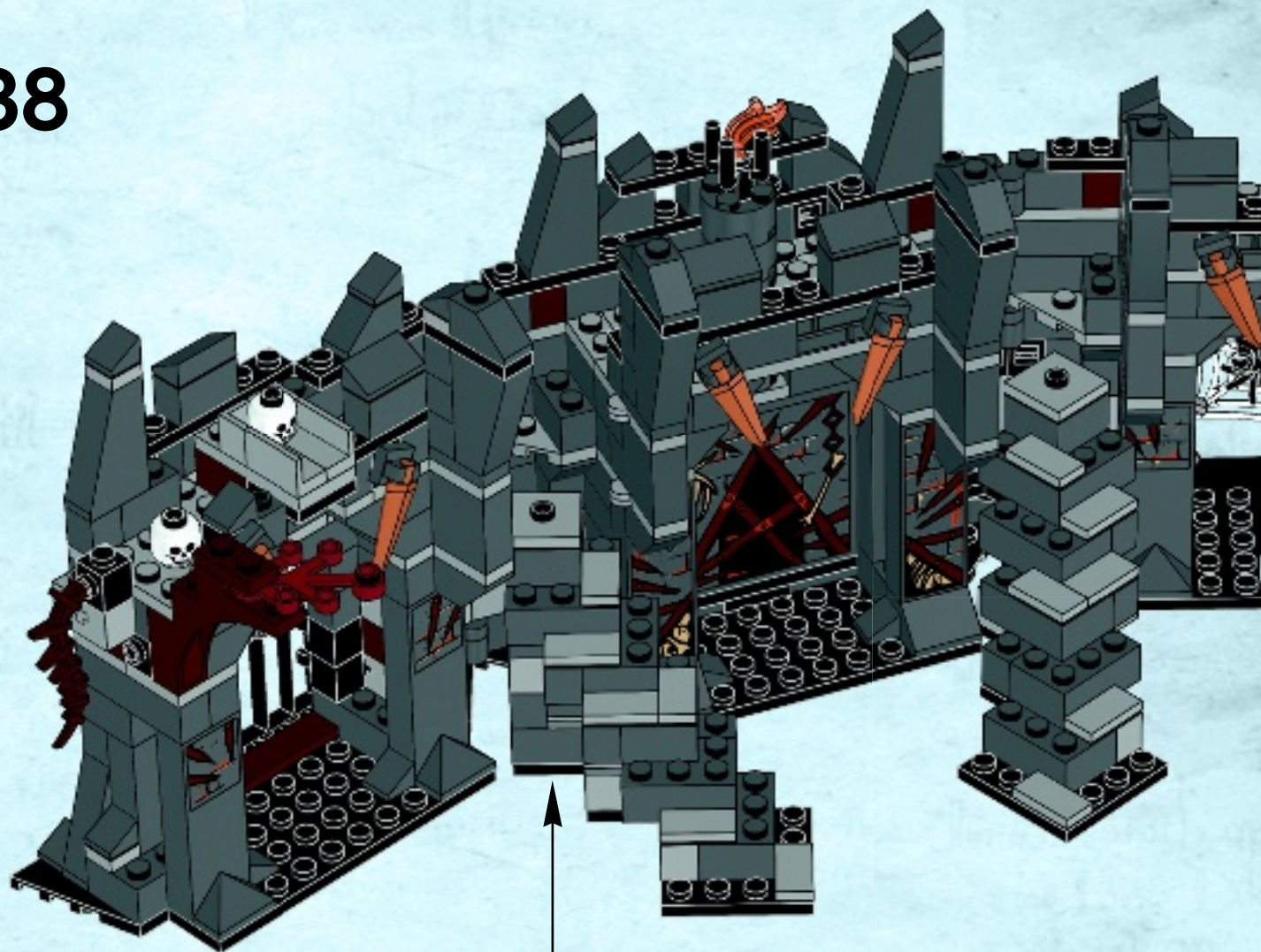



1

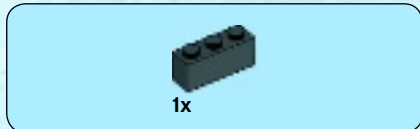
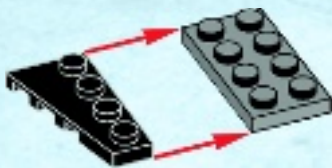

2

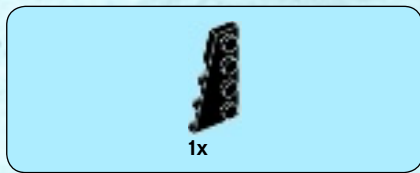

3







1x

4



2x



1x



1x

5

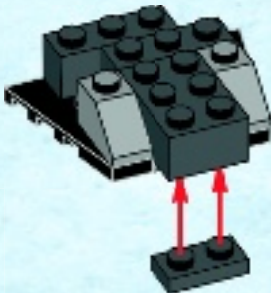

1x



1x



1x

6

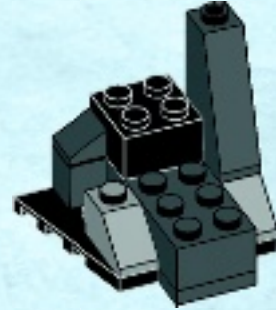

1x



1x

7





8



9

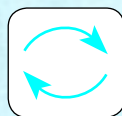



1x



1x

# 10



1x



1x



1x



1x

# 11

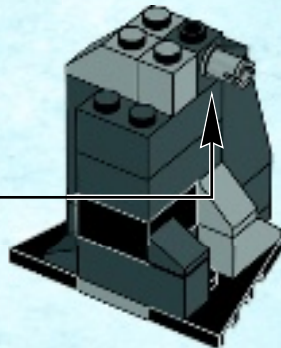
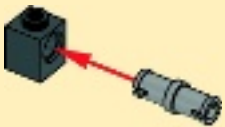

2x

# 12



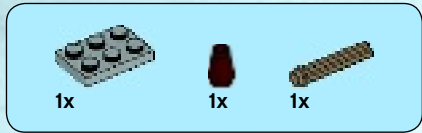

# 13

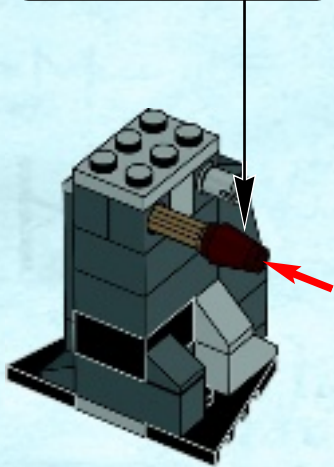
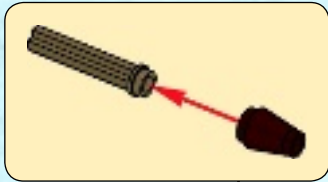

# 14



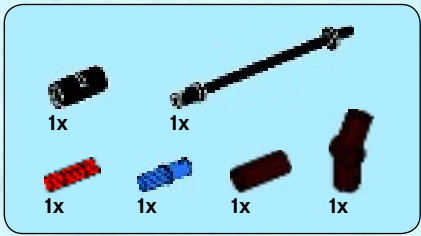

15

1



2



3



4



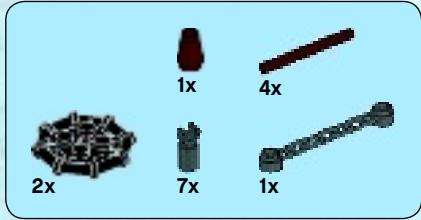

# 16

1



2



3



4

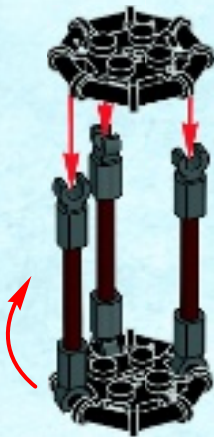

5

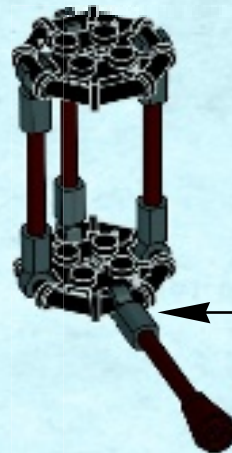

1



2



6

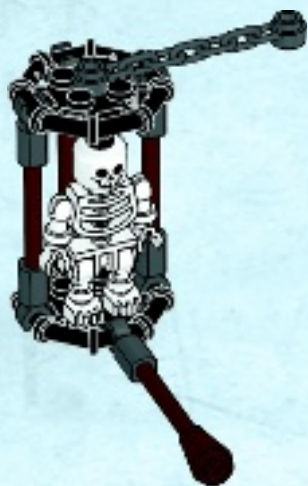

17

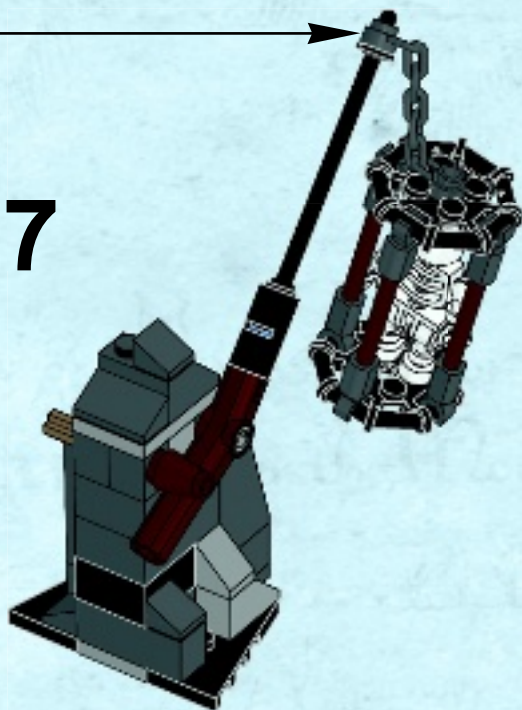



39

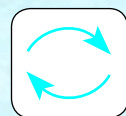
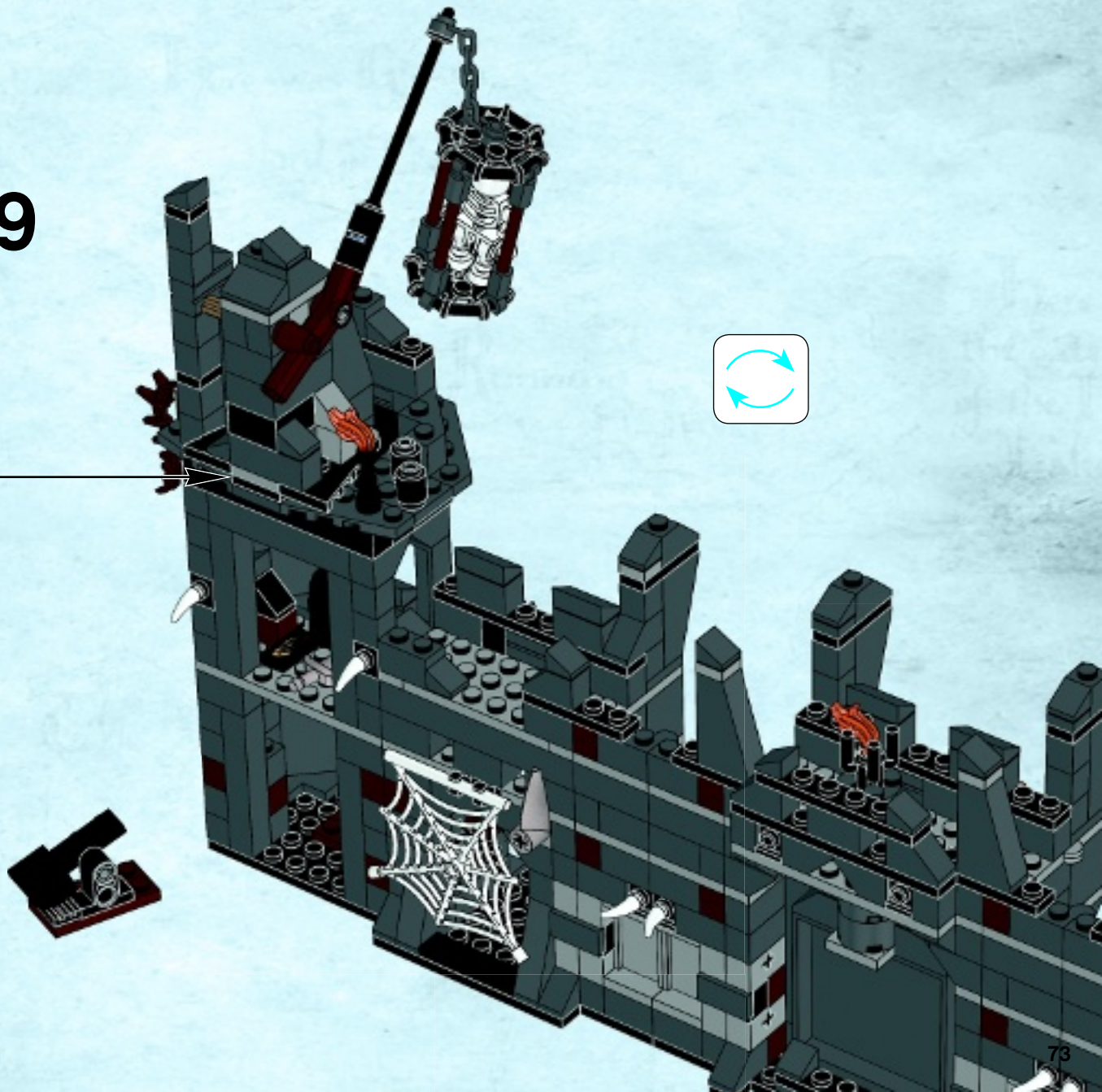

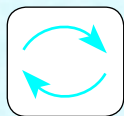

40

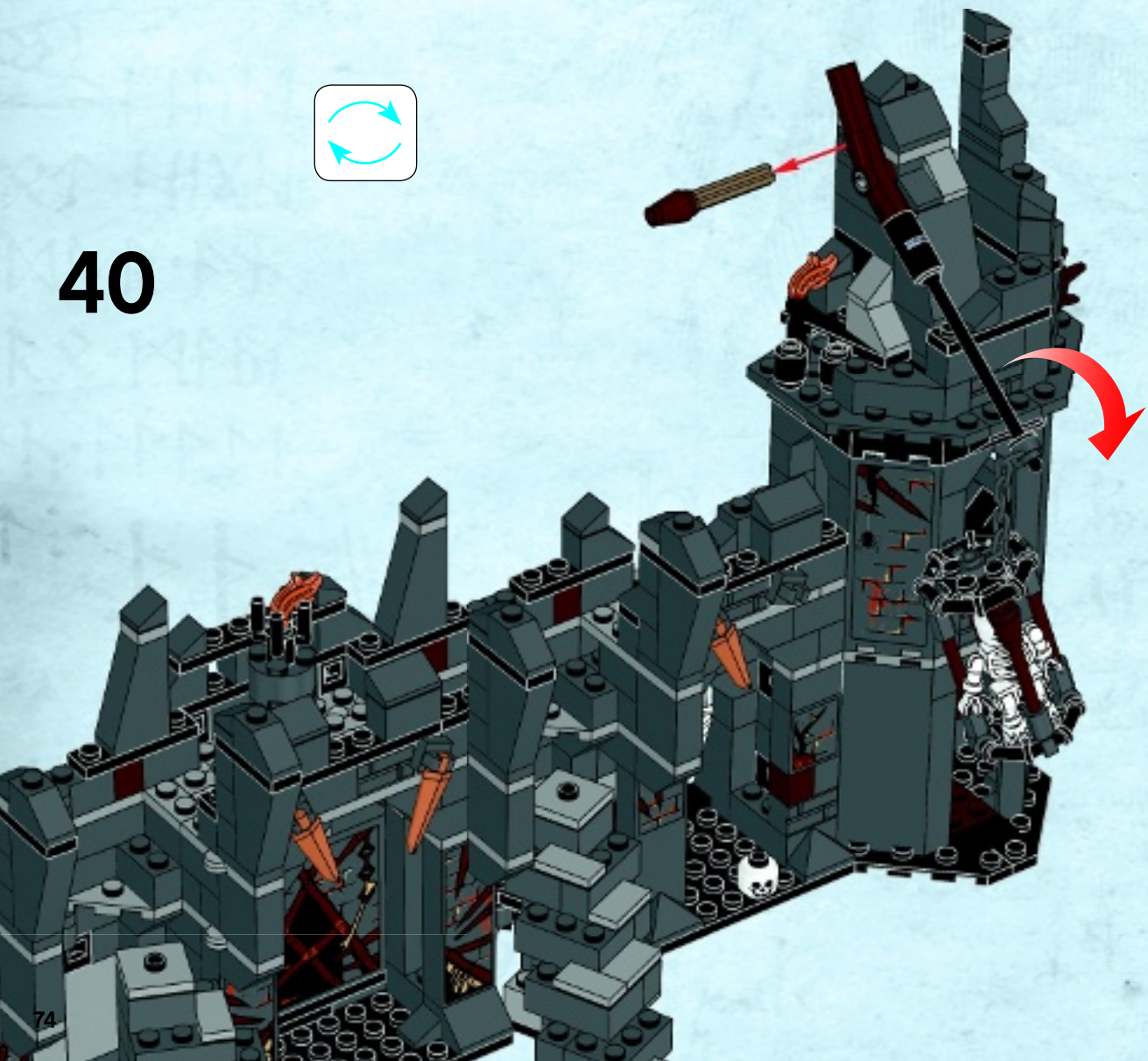





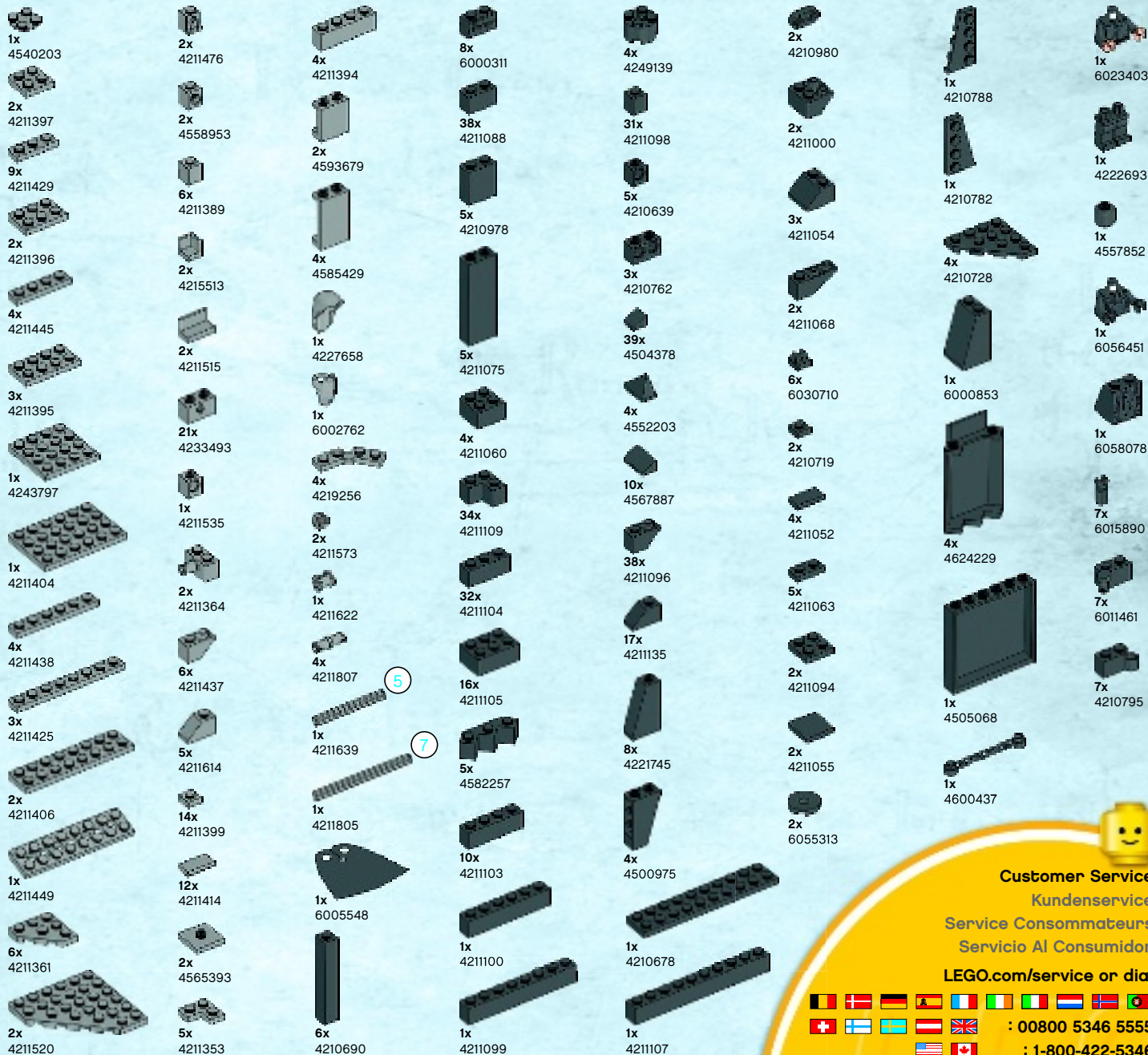

Customer Service

Kundenservice

Service Consommateurs

Servicio Al Consumidor

LEGO.com/service or dial



: 00800 5346 5555

: 1-800-422-5346

79012



79011



79014

79011

+ =

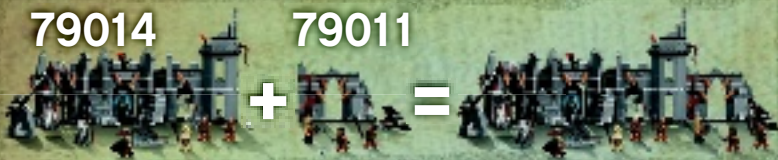

79013





□ 79014  
Azog™



□ 79012  
Gundabad Orc  
Orque de Gundabad  
Orco de Gundabad

□ 79011  
Bcorm™



□ 79011  
Gundabad Orc  
Orque de Gundabad  
Orco de Gundabad



□ 79014  
Gandalf™ the Grey  
Gandalf™ le Gris  
Gandalf™ el Gris



□ 79014  
Gundabad Orc  
Orque de Gundabad  
Orco de Gundabad

□ 79012  
Thranduil



□ 79013  
Bard the Bowman™

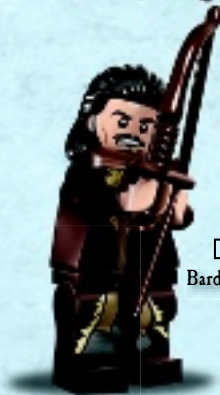

□ 79012  
Gundabad Orc  
Orque de Gundabad  
Orco de Gundabad

□ 79013  
Bilbo Baggins™



□ 79012  
Mirkwood™ Elf Archer  
Elfe archer de Mirkwood™  
Elfo Arquero de Mirkwood™



□ 79013  
Master of Lake-town  
Maître de Lacville  
Maestro de Ciudad del Lago



□ 79011  
Gundabad Orc  
Orque de Gundabad  
Orco de Gundabad



□ 79014  
Radagast™



□ 79014  
Necromancer of  
Dol Guldur  
Nécromancien de  
Dol Guldur  
Nigromante de Dol  
Guldur

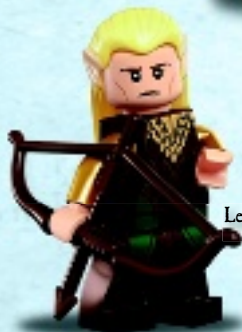

□ 30215  
Legolas Greenleaf™



□ 79014  
Gundabad Orc  
Orque de Gundabad  
Orco de Gundabad



□ 79013  
Thorin Oakenshield™



□ 79013  
Lake-town Guard  
Garde de Lacville  
Guarda de Ciudad del Lago

□ 30216  
Lake-town Guard  
Garde de Lacville  
Guarda de Ciudad del Lago



□ 79012  
Mirkwood™ Elf Archer  
Elfe archer de Mirkwood™  
Elfo Arquero de Mirkwood™



□ 79012  
Mirkwood™ Elf  
Elfe de Mirkwood™  
Elfo de Mirkwood™



□ 79012  
Warg



# THE HOBBIT™



# LE HOBBIT™



COMING  
SORTIE PRÉVUE EN  
2014

[LEGO.com/Thehobbit](http://LEGO.com/Thehobbit)

XBOX  
LIVE

XBOX 360

NINTENDO 3DS



PlayStation



PC DVD

Wii U™



RATING PENDING  
RP  
CONTENT RATED BY  
ESRB

Visit [www.esrb.org](http://www.esrb.org)  
for rating information

LEGO THE HOBBIT software © 2013 TT Games. © 2013 The LEGO Group. © New Line.™ & © SZC lic. to WBIE. (s13). "Wii U", "3DS",™ & © 2013 Nintendo. "PlayStation" and the "PS" Family logo are registered trademarks and the PlayStation Network logo is a trademark of Sony Computer Entertainment Inc. KINECT, Xbox, Xbox 360, Xbox LIVE & Xbox logos,™ Microsoft. All rights reserved.

WB GAMES LOGO, WB SHIELD:  
TM & © Warner Bros. Entertainment Inc.  
(s13)

THE HOBBIT: AN UNEXPECTED JOURNEY, THE HOBBIT: THERE AND BACK AGAIN: ©WBIE™ Middle-earth Ent. Lic. to New Line. (s13)

LE HOBBIT : UN VOYAGE INATTENDU, LE HOBBIT : HISTOIRE D'UN ALLER ET RETOUR : © WBIE™ Middle-earth Ent. Lic. à New Line. (s13)

EL HOBBIT: UN VIAJE INESPERADO, EL HOBBIT: HISTORIA DE UNA IDA Y UNA VUELTA: © WBIE™ Middle-earth Ent.; uso autorizado a New Line. (s13)

**LEGO** THE HOBBIT™  
THE JOURNEY BEGINS

The journey concludes in 2014!

**LEGO** THE HOBBIT™  
THE JOURNEY BEGINS

Le voyage se termine en 2014!

**LEGO** THE HOBBIT™  
THE JOURNEY BEGINS

¡El viaje llega a su fin en 2014!



THE HOBBIT: THERE AND BACK AGAIN:  
© WBEI™ Middle-earth Ent. Lic. to New Line.  
(s13)  
LE HOBBIT: HISTOIRE D'UN ALLER ET RETOUR:  
© WBEI™ Middle-earth Ent. Lic. à New Line.  
(s13)  
EL HOBBIT: HISTORIA DE UNA IDA Y UNA VUELTA:  
© WBEI™ Middle-earth Ent.; uso autorizado a New Line.  
(s13)

[LEGO.com/thehobbit](http://LEGO.com/thehobbit)

LEGO, the LEGO logo and the Minifigure are  
trademarks of the/son des marques de commerce  
de/son marcas registradas de LEGO Group.  
©2013 The LEGO Group.



# WIN!

Go to [LEGO.com/productfeedback](http://LEGO.com/productfeedback) to fill out a survey for a chance to win a cool LEGO® Product. No purchase necessary. Open to all residents where not prohibited.



## LEGO.com/productfeedback

### GEWINNE! WIN!

Nimm an der Umfrage auf [LEGO.com/productfeedback](http://LEGO.com/productfeedback) teil und hab die Chance ein cooles LEGO® Produkt zu gewinnen!

Die Teilnahme am Gewinnspiel führt zu keinerlei Kaufverpflichtungen. Teilnahme in allen nicht ausgeschlossenen Ländern möglich.

Ga naar [LEGO.com/productfeedback](http://LEGO.com/productfeedback), vul een enquêteformulier in en maak kans op een cool LEGO® product.

Geen aankoopverplichting. Ledereen mag deelnemen, uitgezonderd ingezetenden van landen waar een enquêteverbod geldt.

### GAGNE! 当てよう!

Visite [LEGO.com/productfeedback](http://LEGO.com/productfeedback) pour répondre à un questionnaire et avoir une chance de gagner un produit LEGO® très cool!

Aucune obligation d'achat. Ouvert à tous les résidents des pays autorisés.

[LEGO.com/productfeedback](http://LEGO.com/productfeedback) にアクセスして、アンケートにご記入ください。当選者にはレゴ® 製品を差し上げます。

お買い上げの必要はありません

禁止されていない限り、すべての皆様にご利用いただけます。

LEGO, the LEGO logo and the Minifigure are trademarks of the/son des marques de commerce de/son marcas registradas de LEGO Group.

©2013 The LEGO Group.

THE HOBBIT: THE DESOLATION OF SMAUG: © WBEI™ Middle-earth Ent. Lic. to New Line.

LE HOBBIT: LA DESOLATION DE SMAUG: © WBEI™ Middle-earth Ent. Lic. à New Line.

EL HOBBIT: LA DESOLACION DE SMAUG: © WBEI™ Middle-earth Ent.; uso autorizado a New Line.

(s13)

 [LEGO.com](http://LEGO.com)

6073570