



# THE LONE RANGER



79109



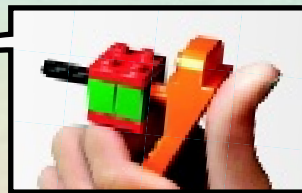
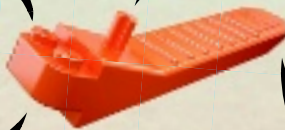



1x

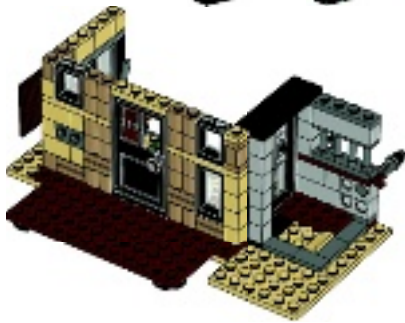

1



2

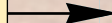
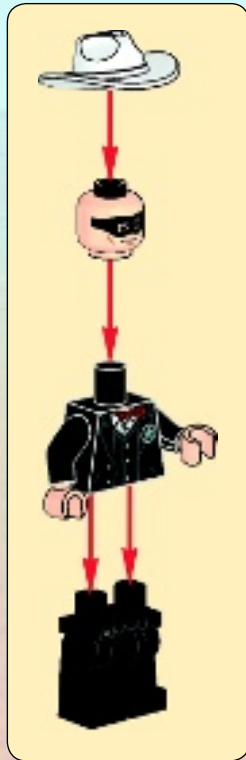



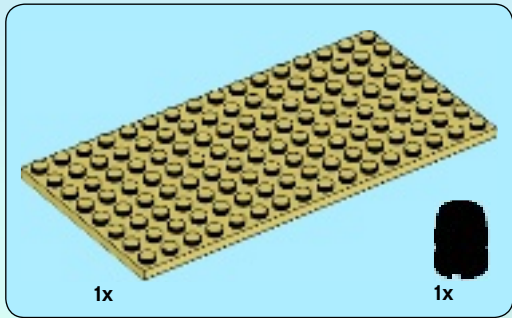
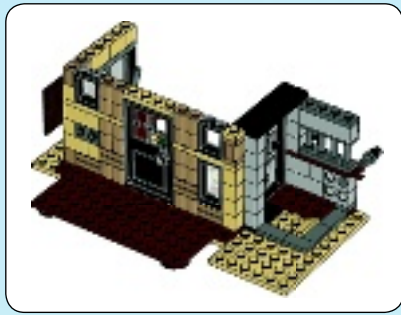

1x

1x

1

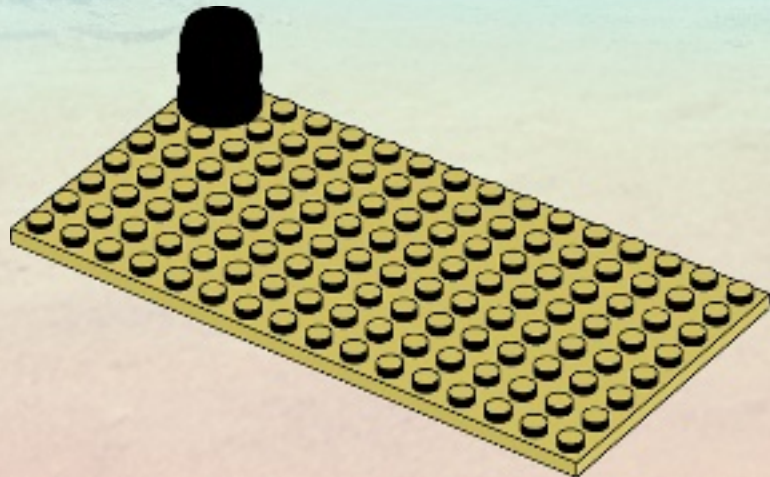

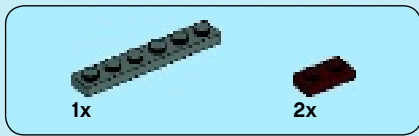

2

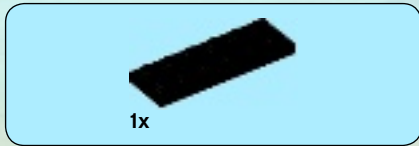

3

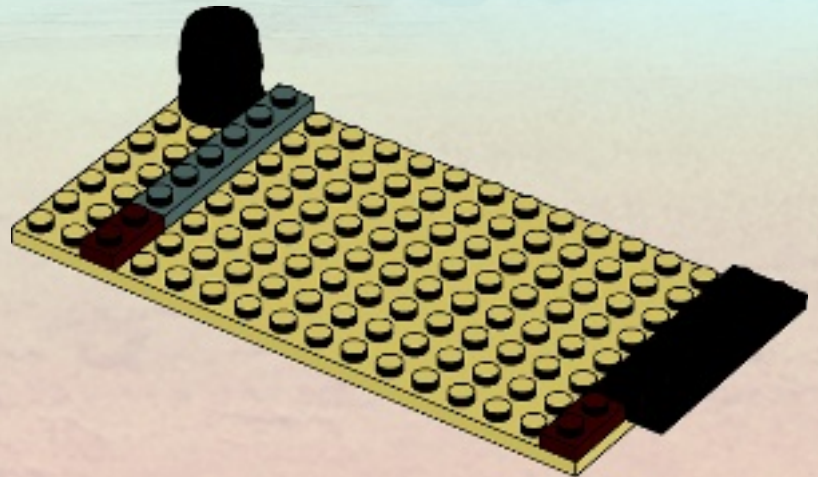

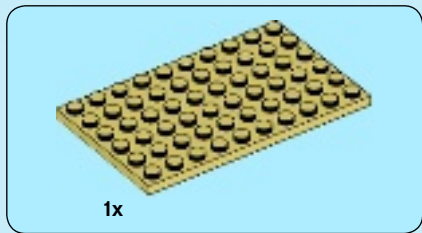

4

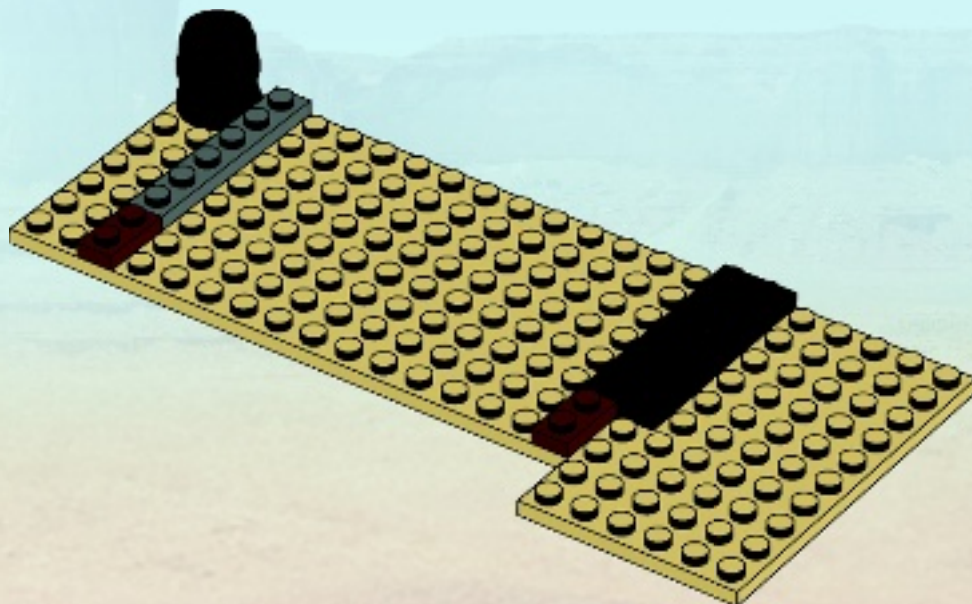

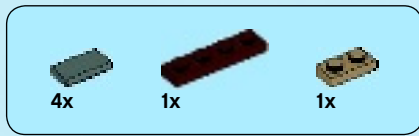

5

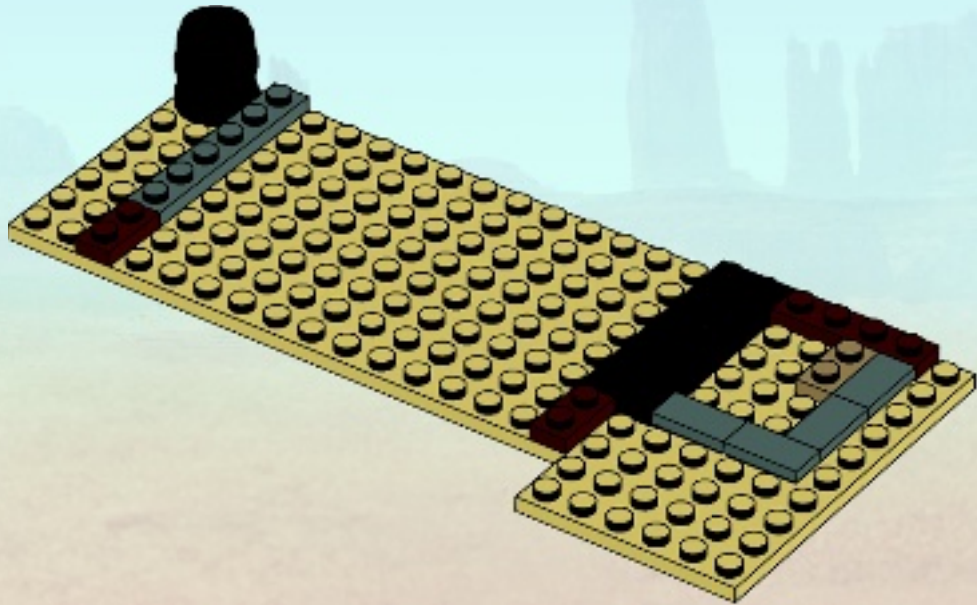

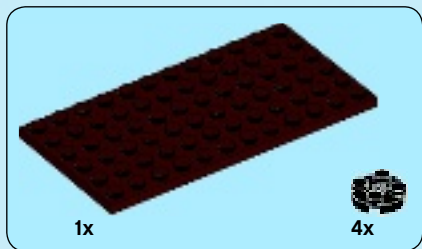

6

1



2

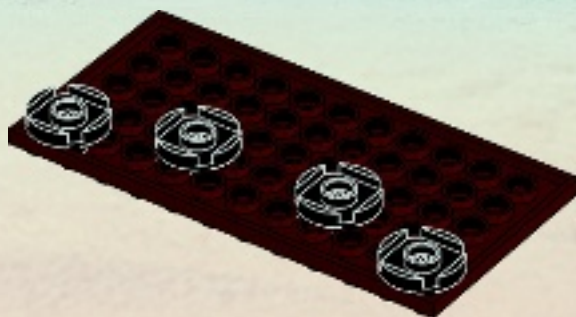



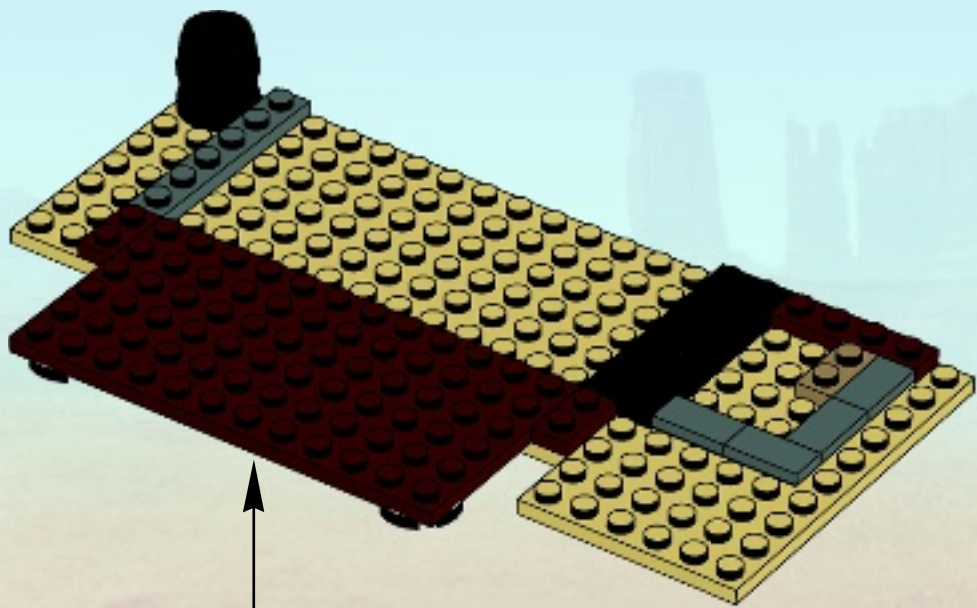

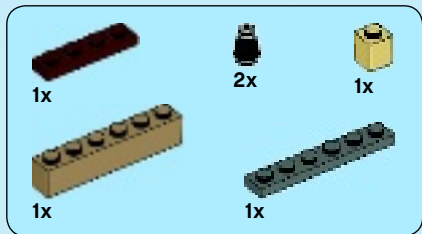

7

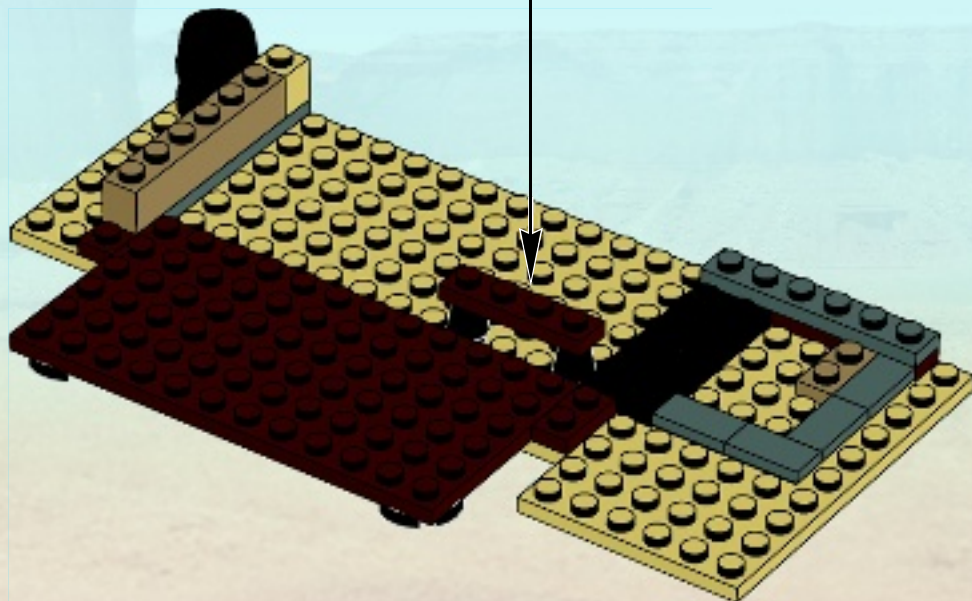

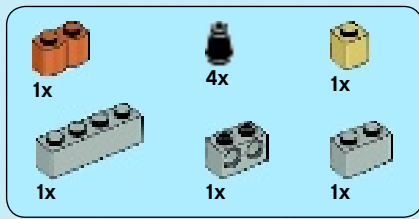

8

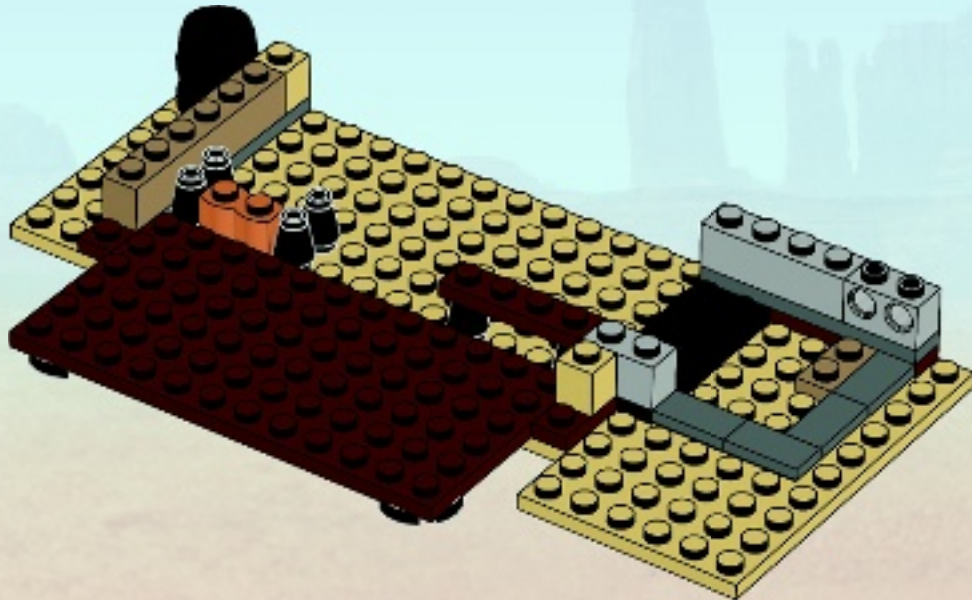

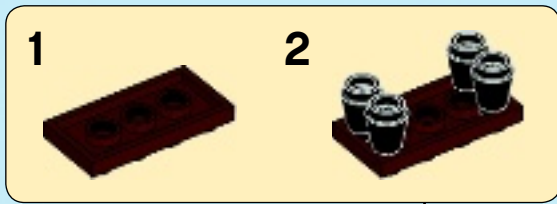
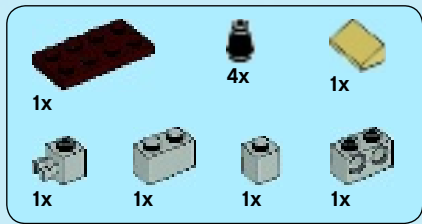

9

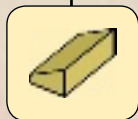
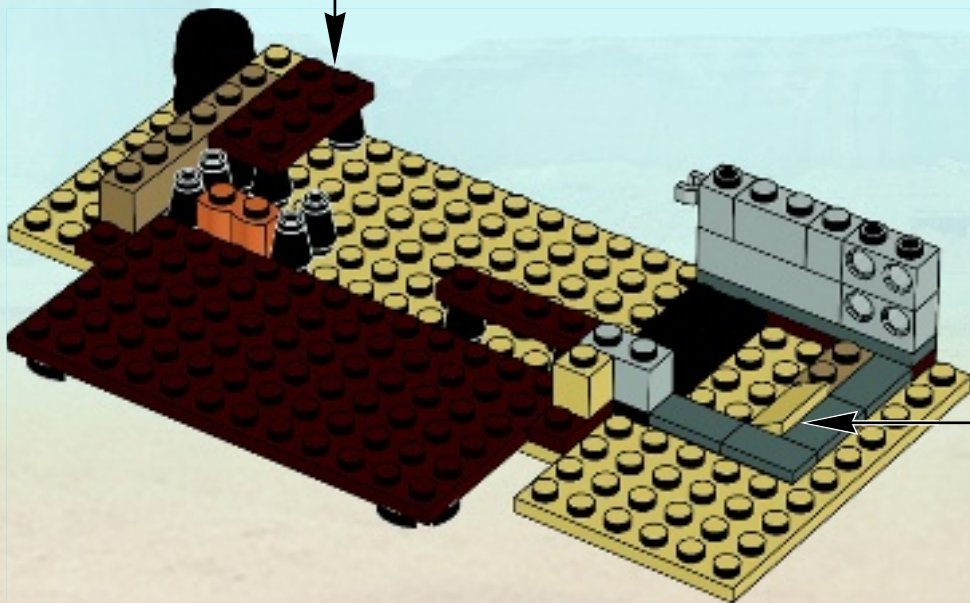



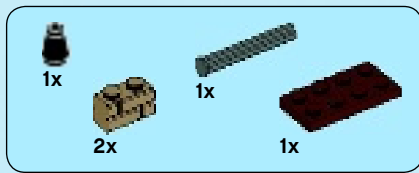

10

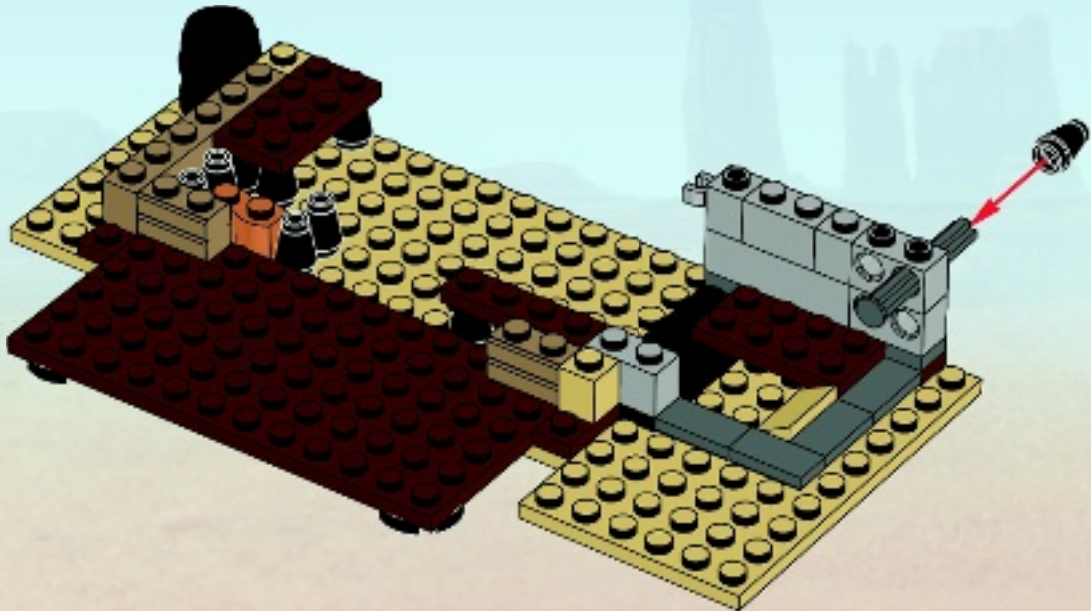

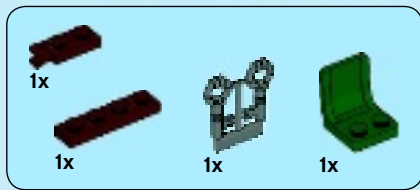

11

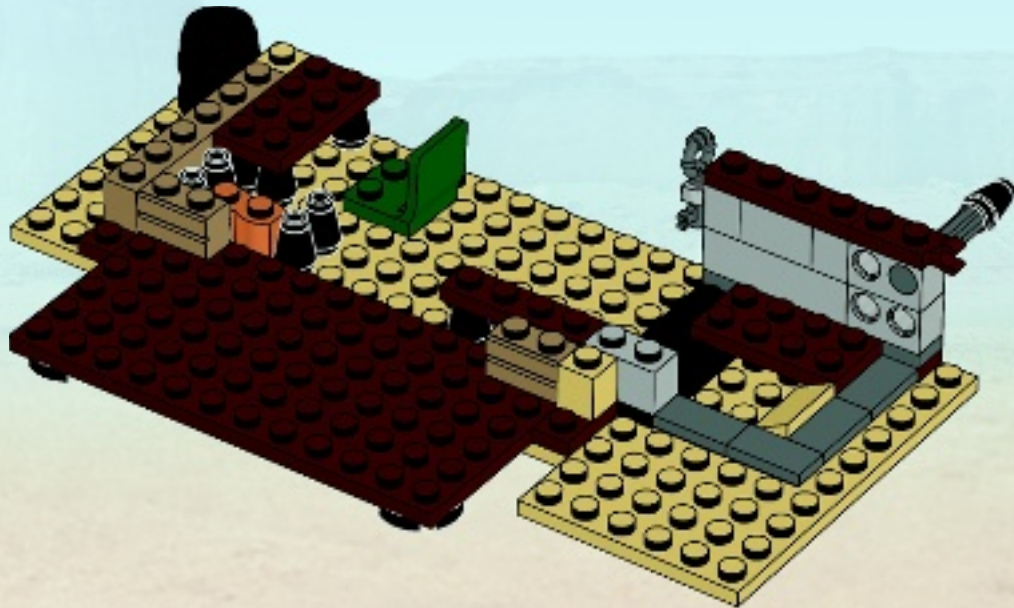

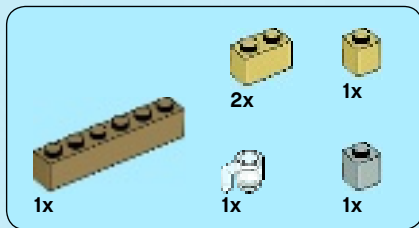

# 12

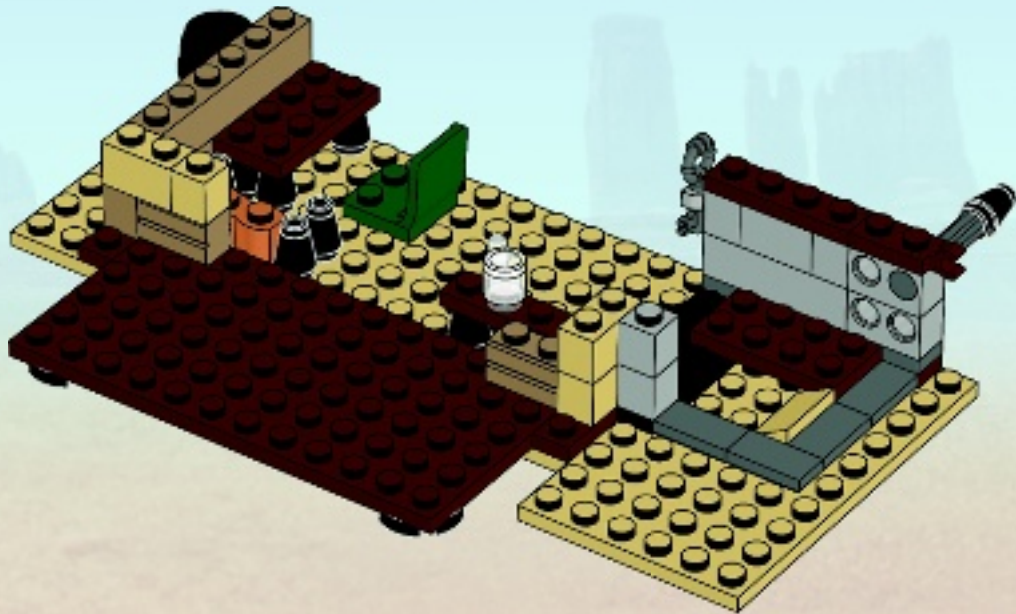



2x



3x



2x

# 13

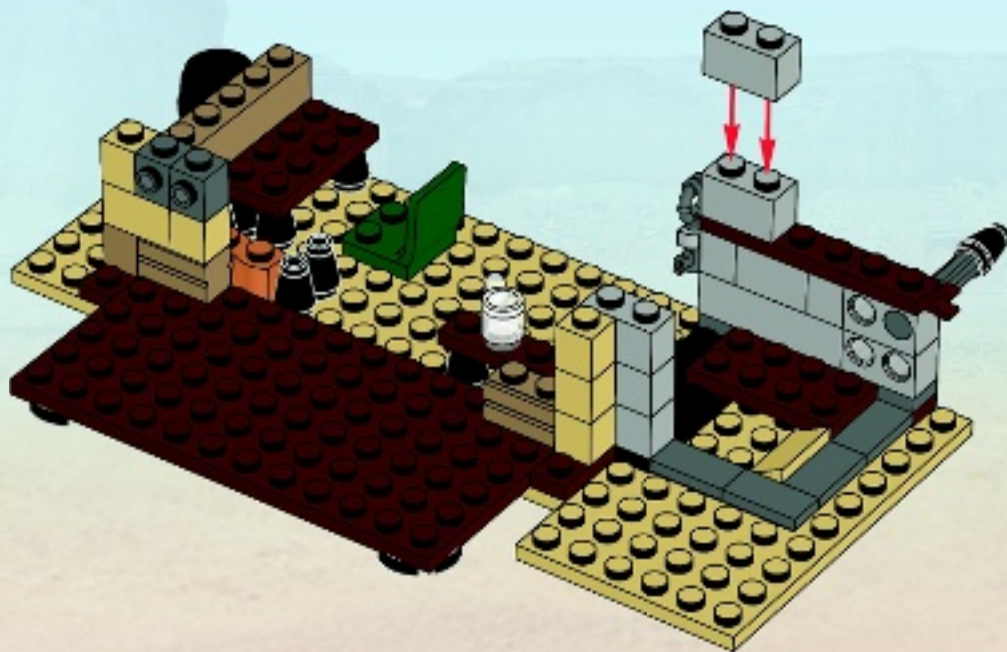





14





15

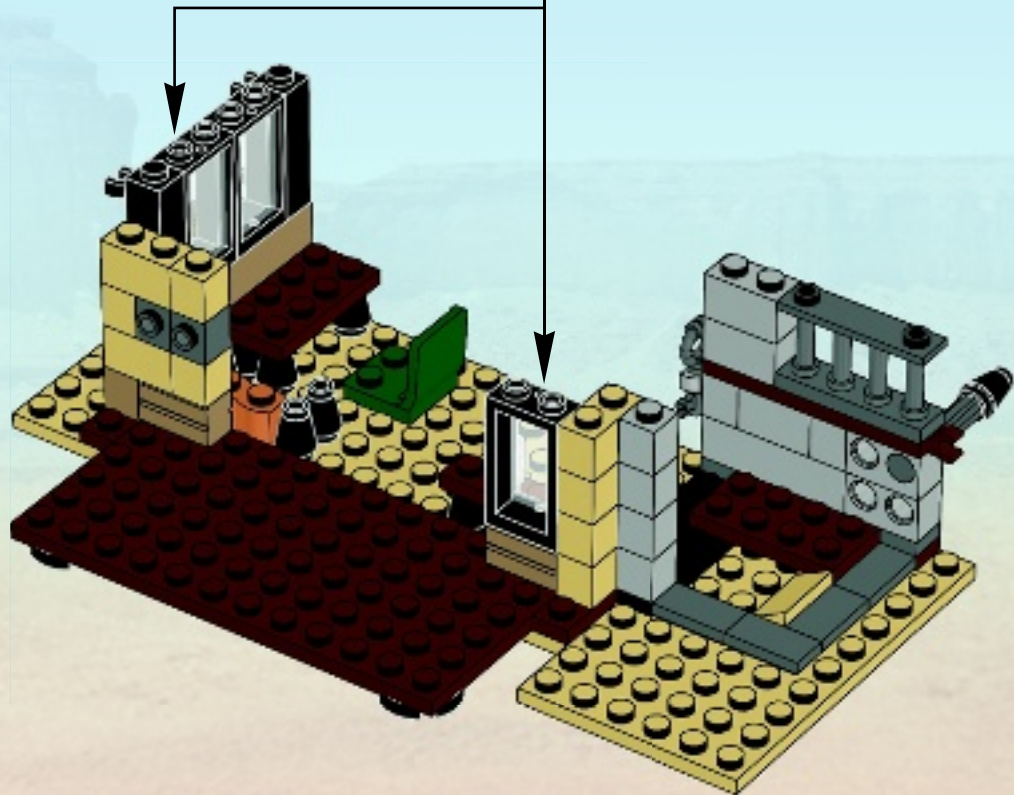
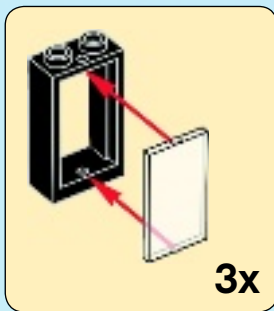

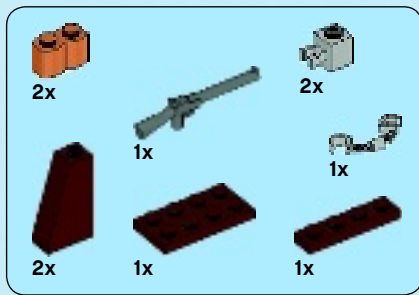

# 16

## 1



## 2

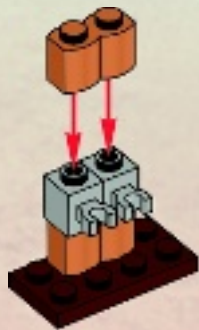

## 3

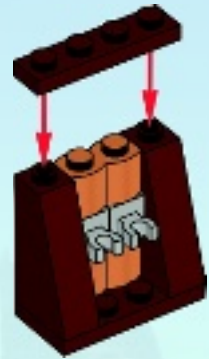

## 4









6x



2x

# 17

1

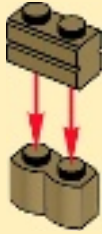

2

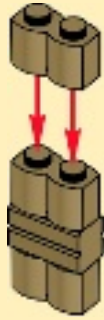

2x

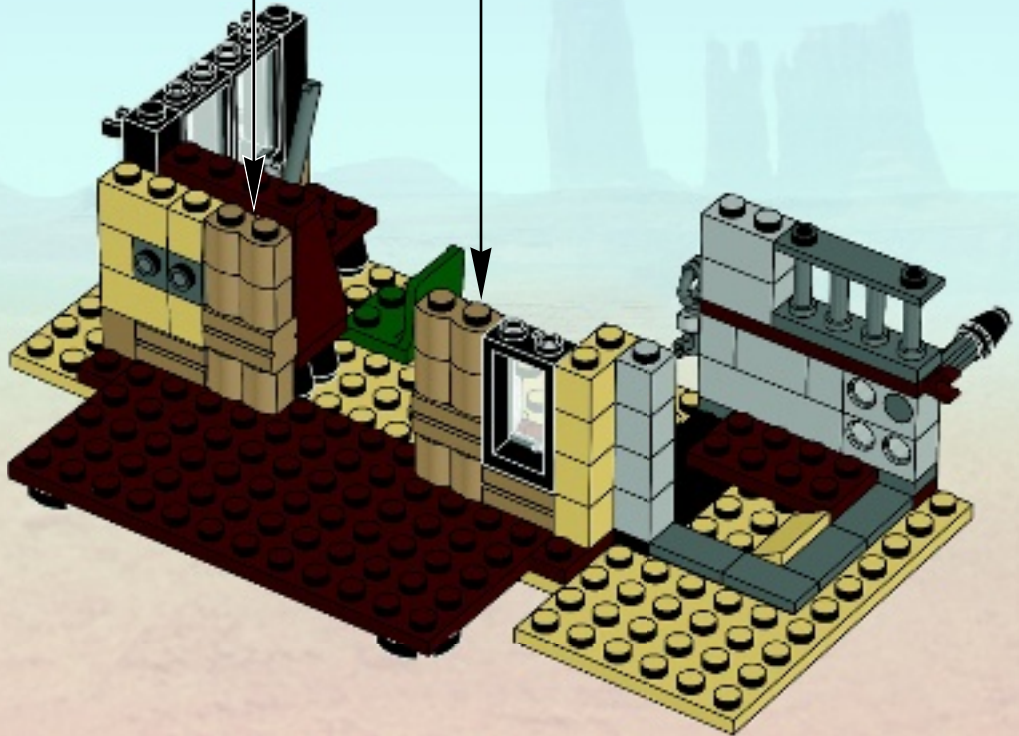

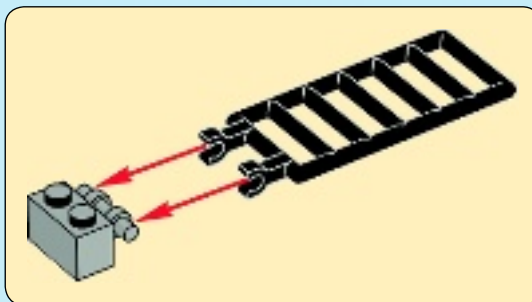
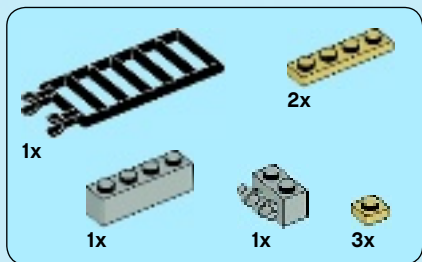

# 18

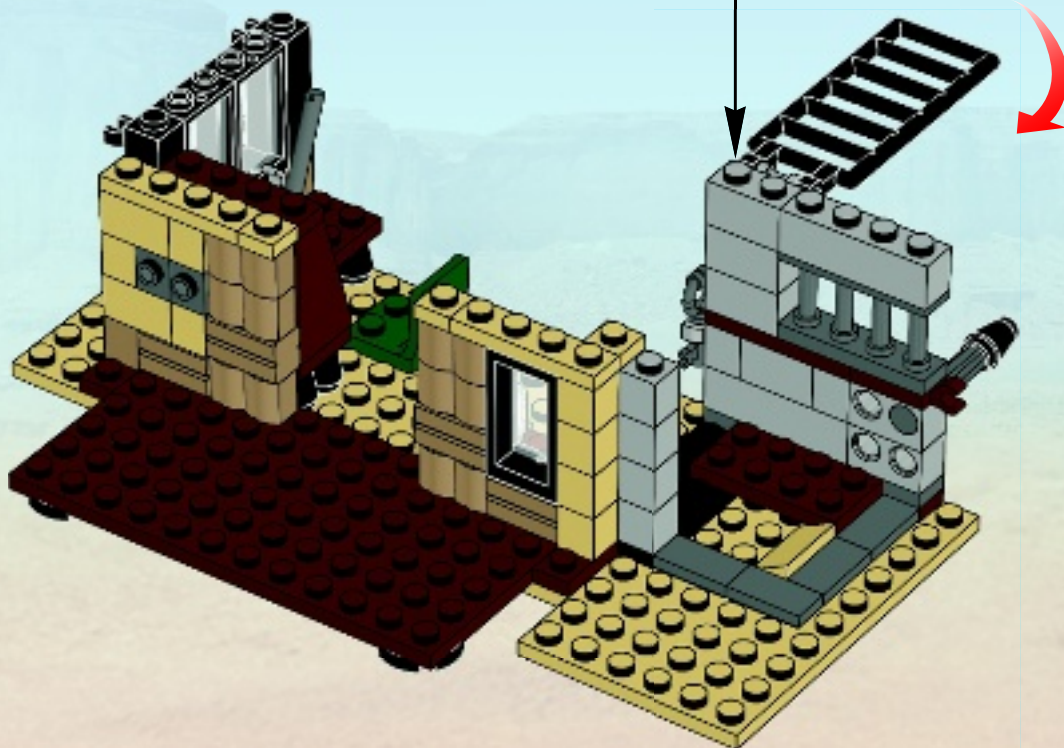



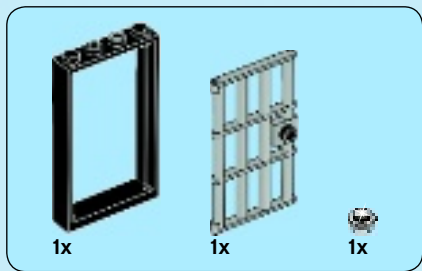

20

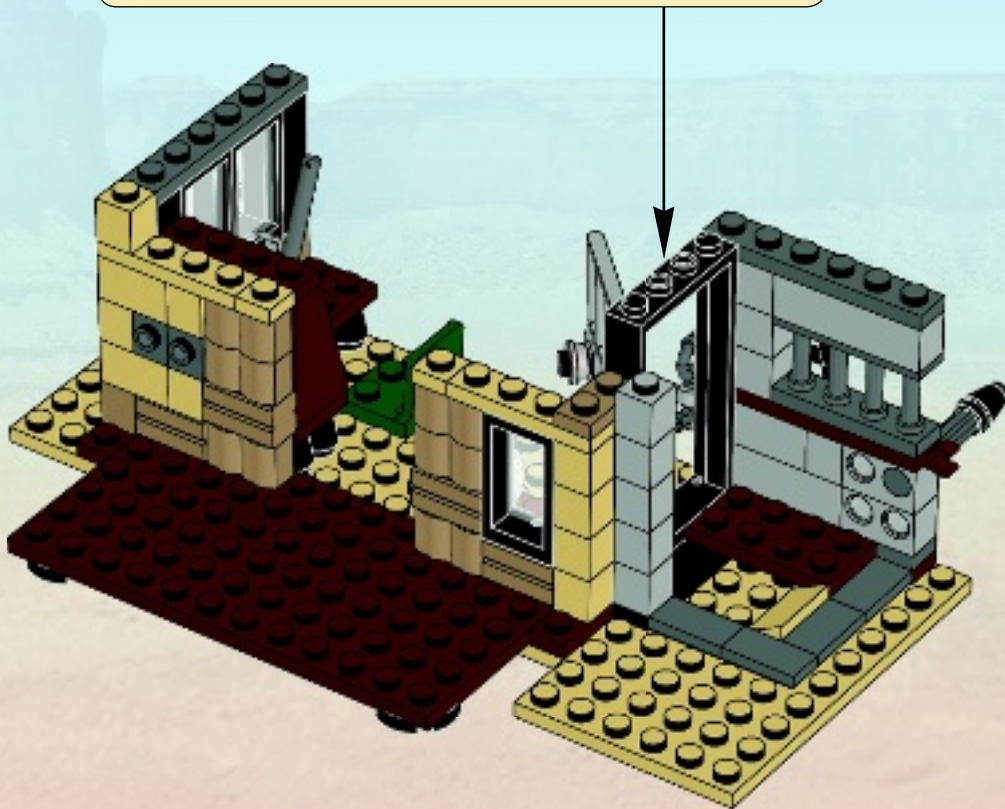
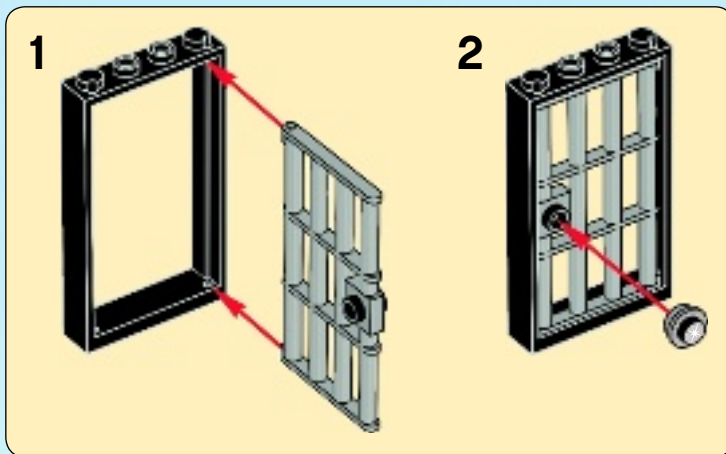





2x



1x



4x

# 21

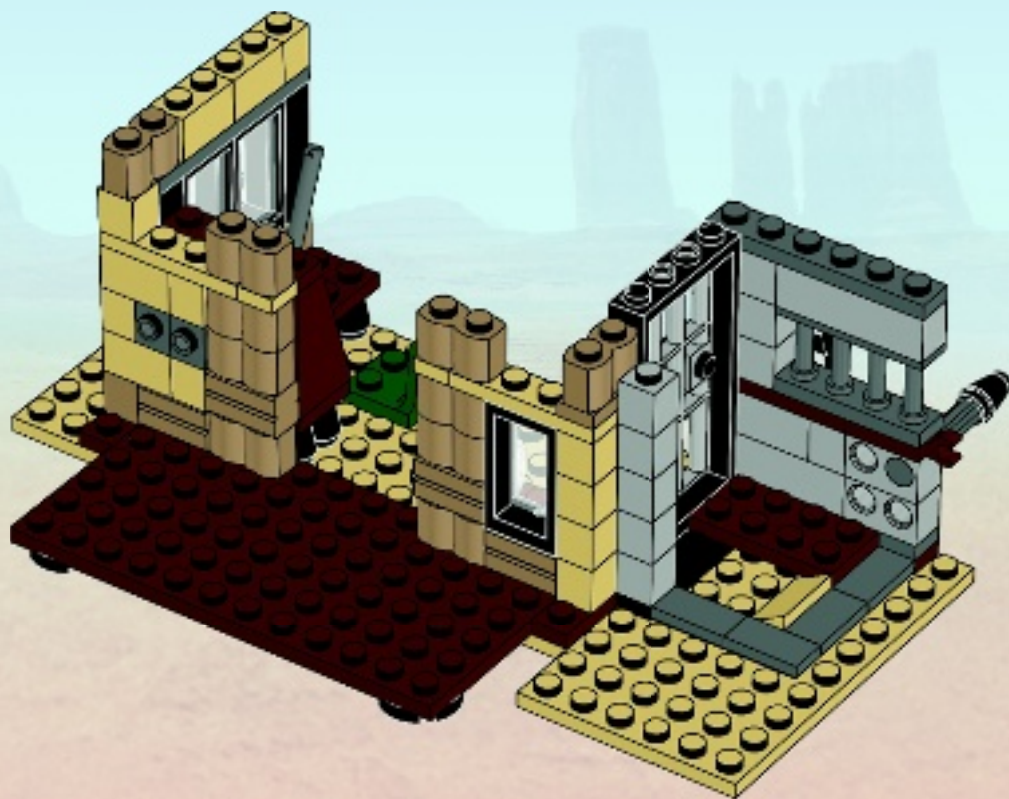

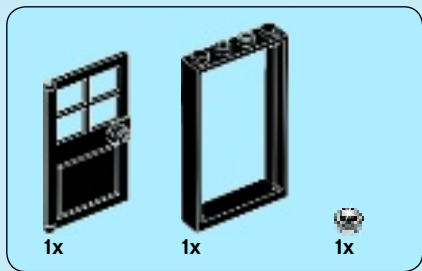

22

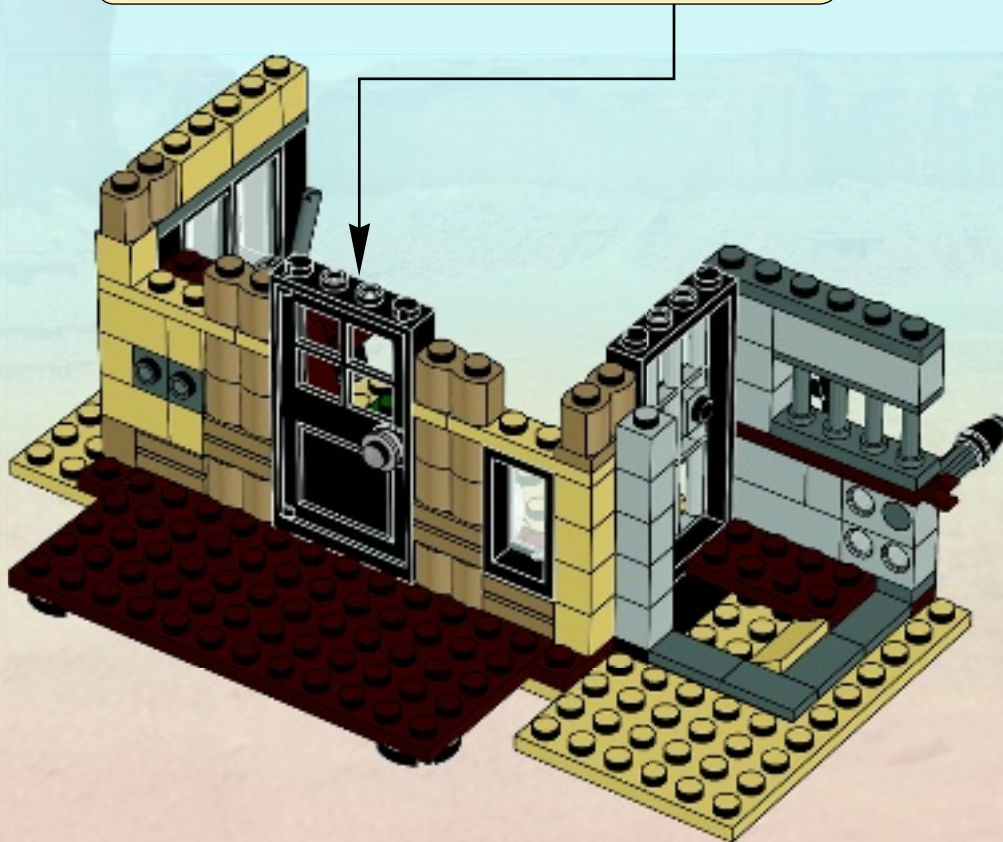
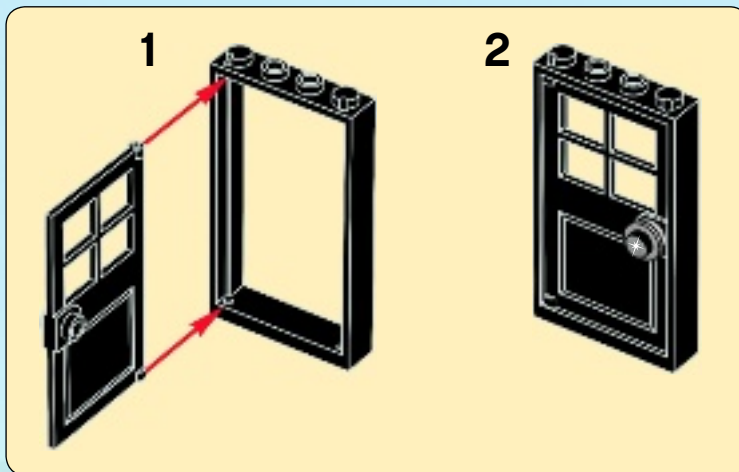

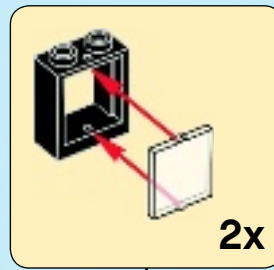
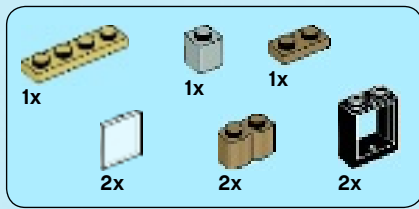

23

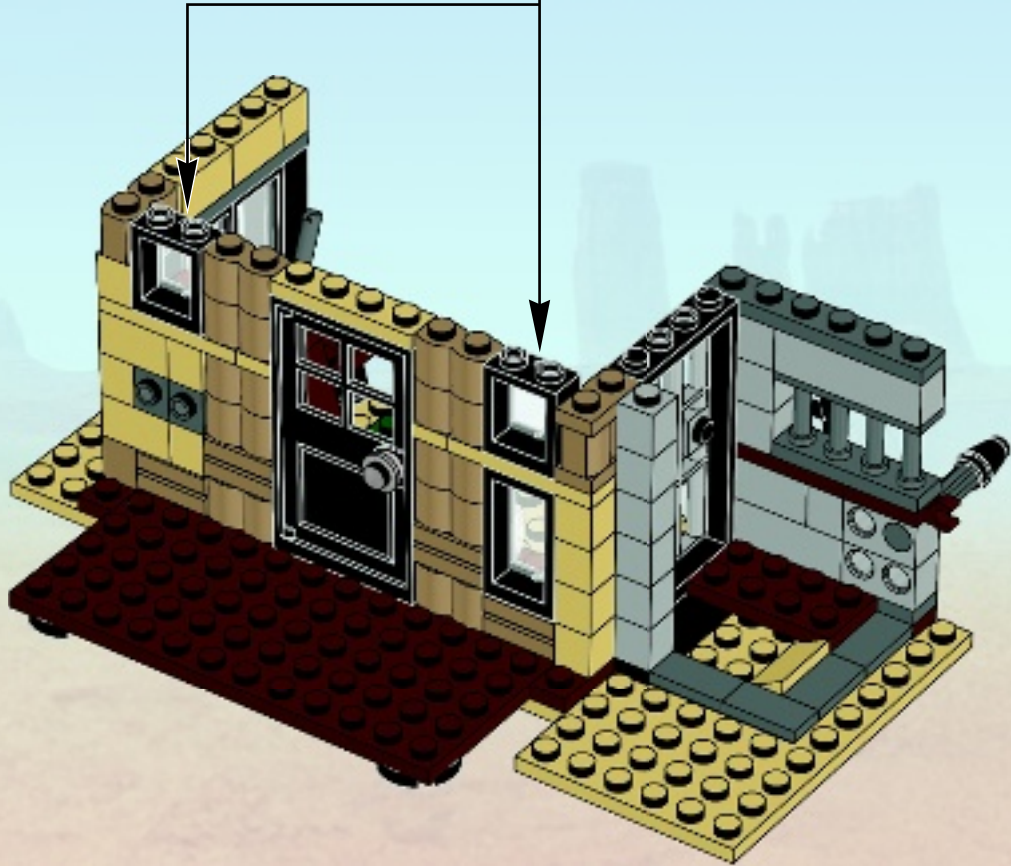



1x



1x

# 24

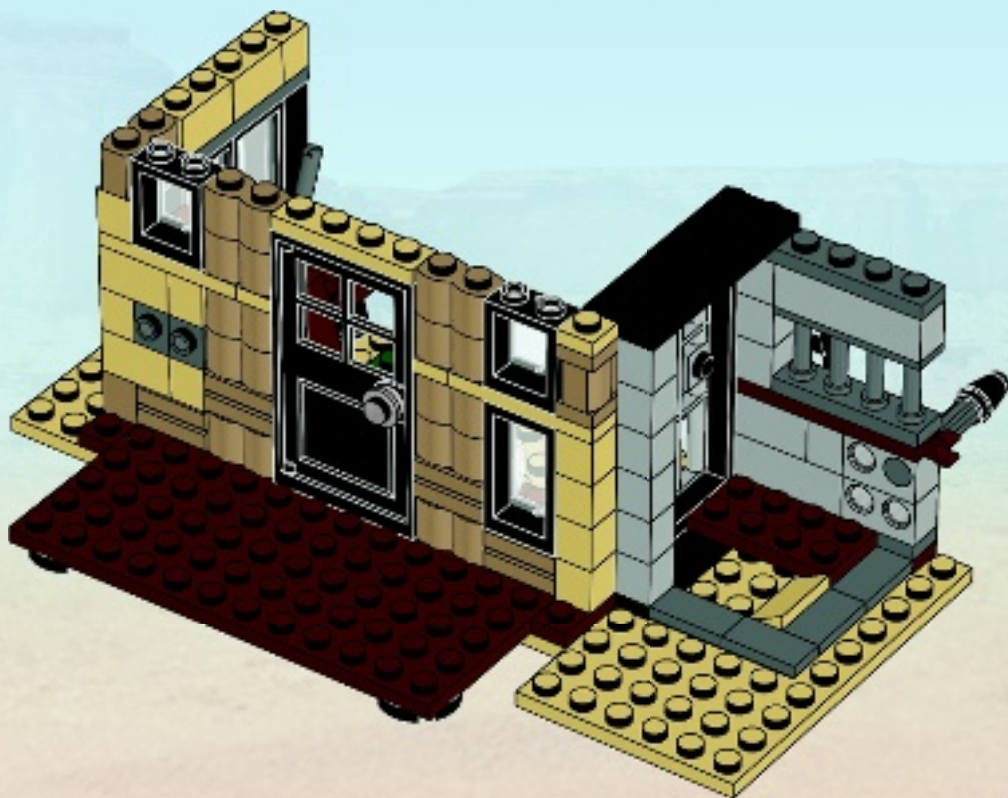



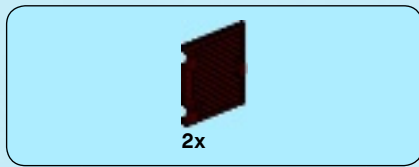

25

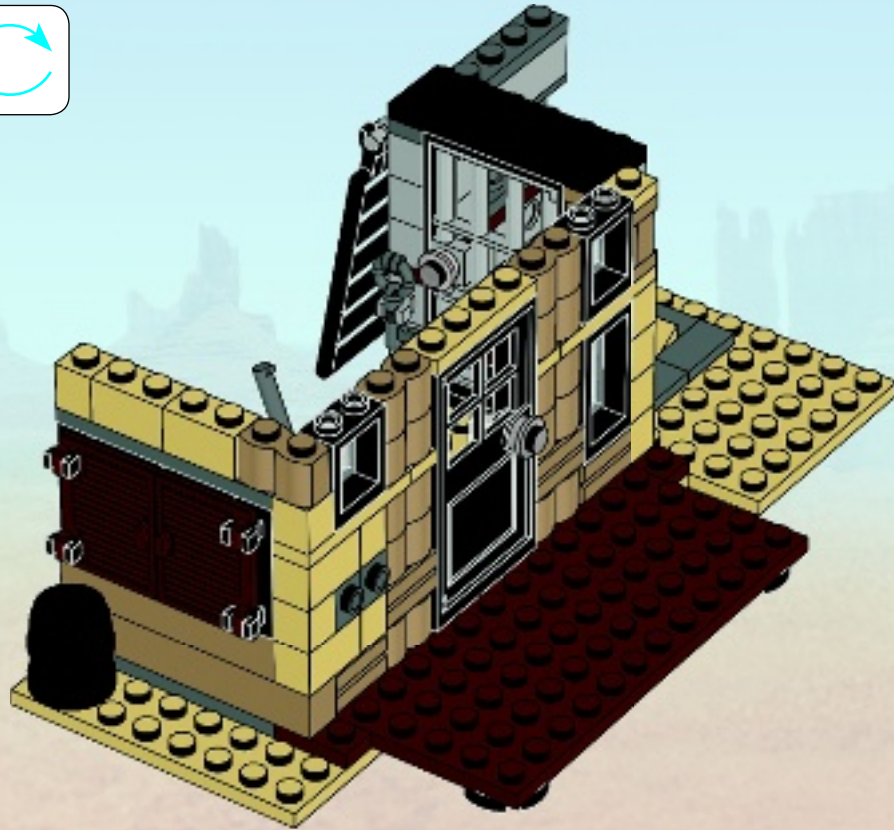
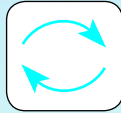

2





26

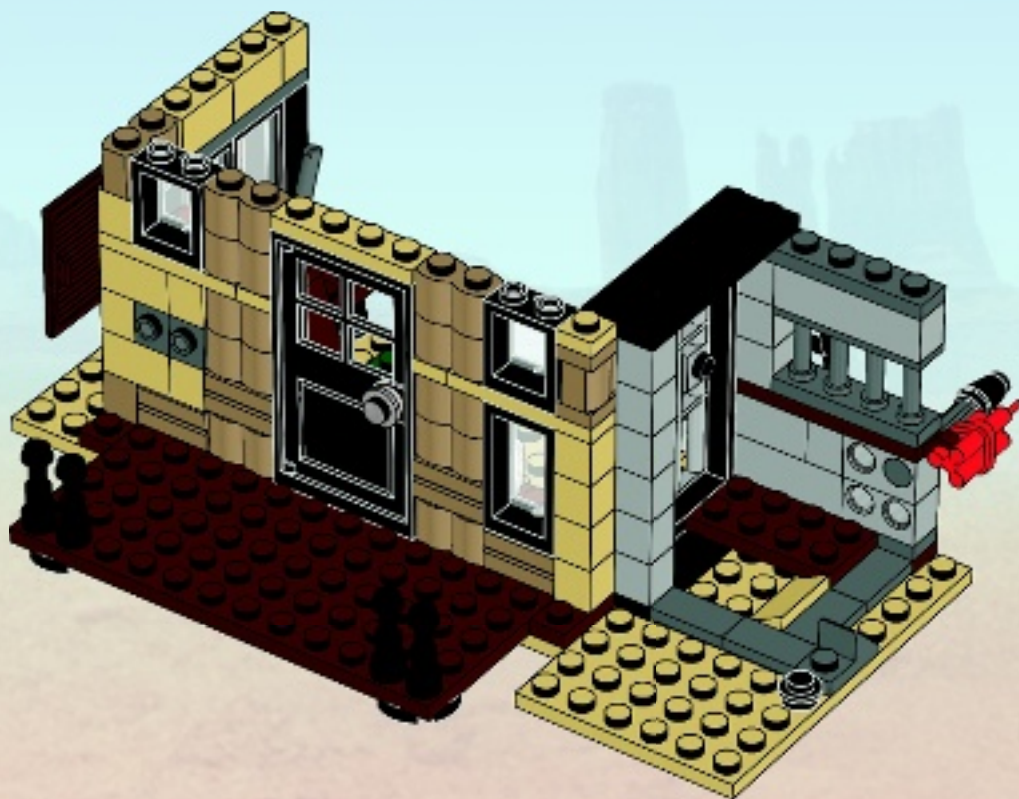
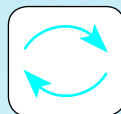

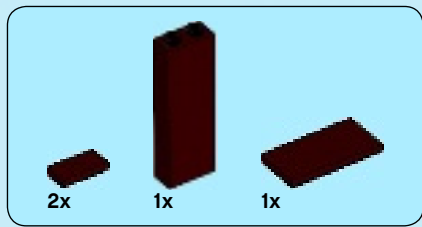

# 27

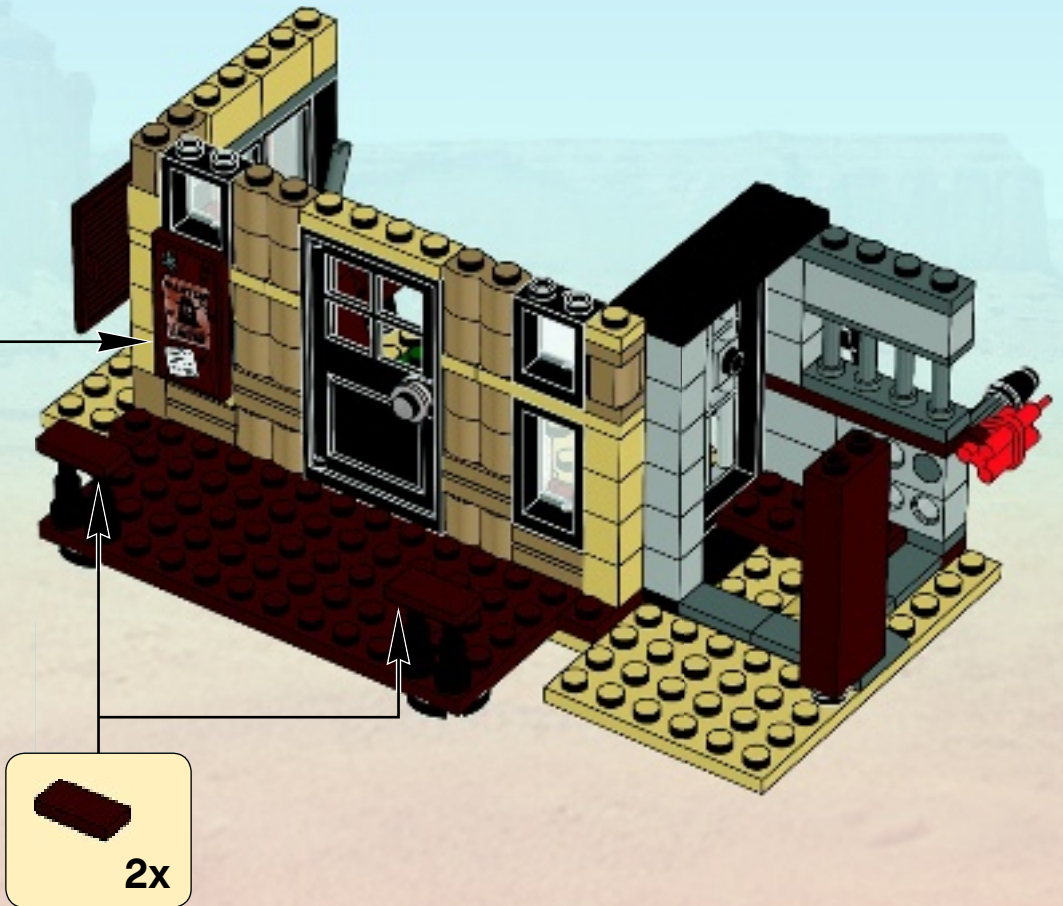
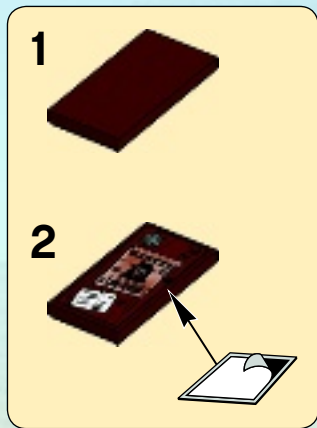



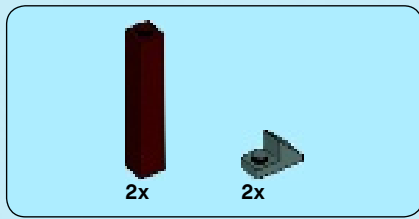

28

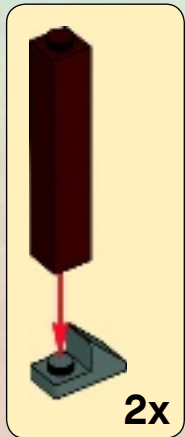
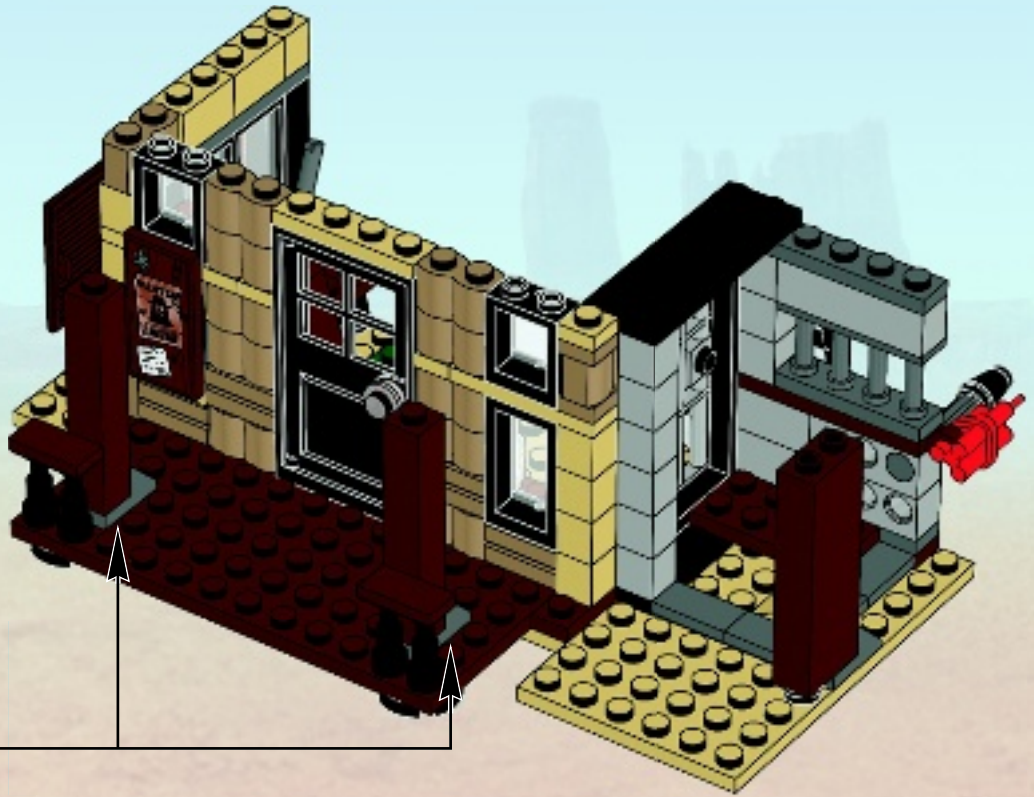



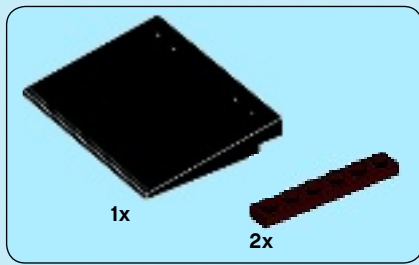

30

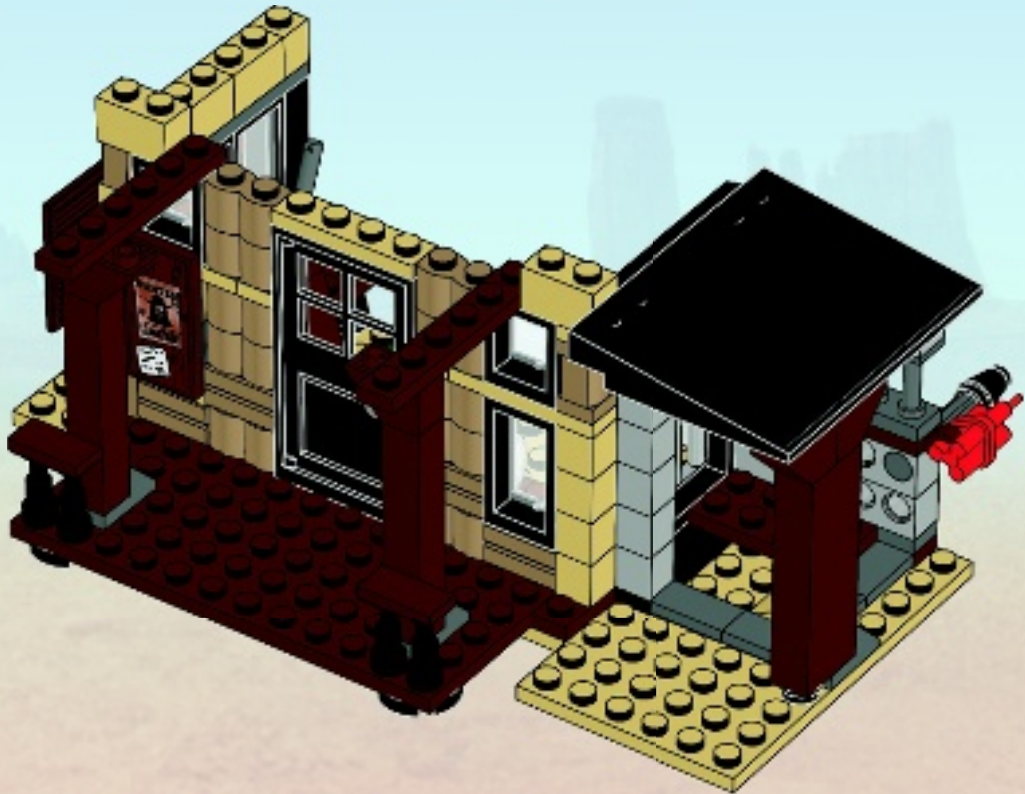



# 31

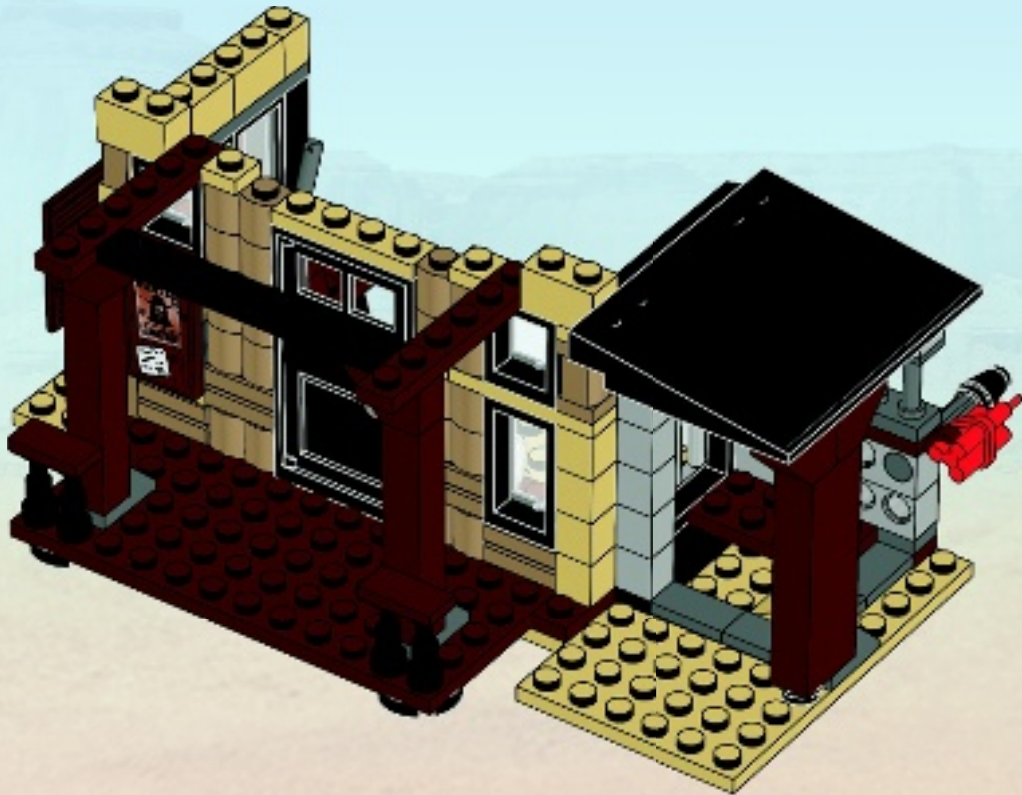



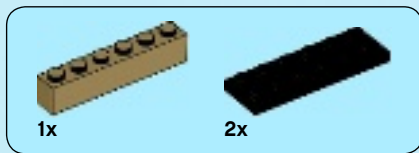

# 32

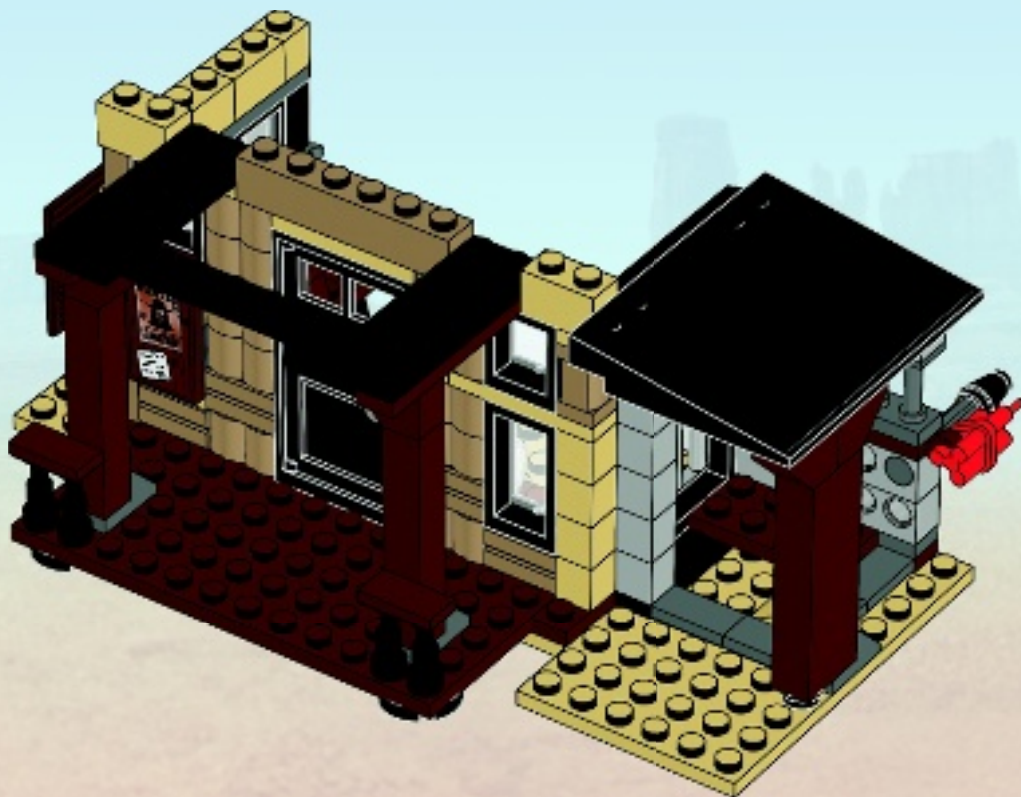



2x



4x

# 33

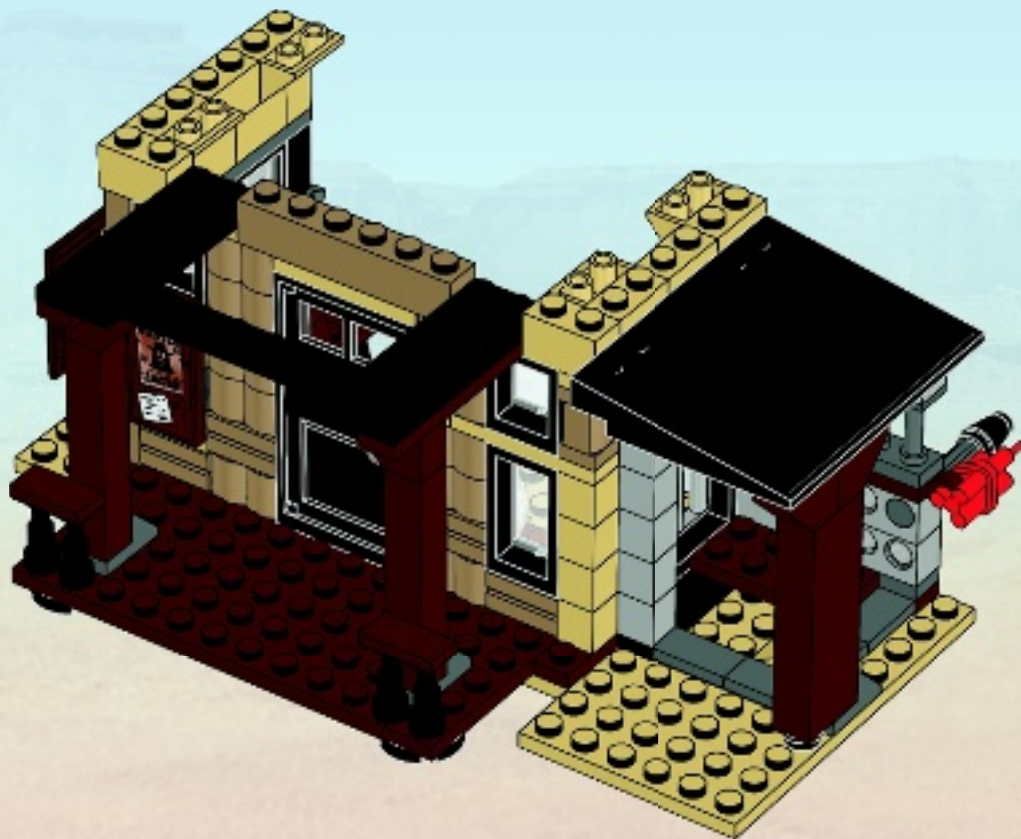

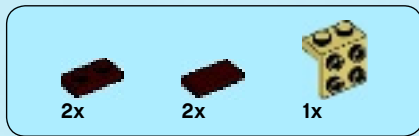

34

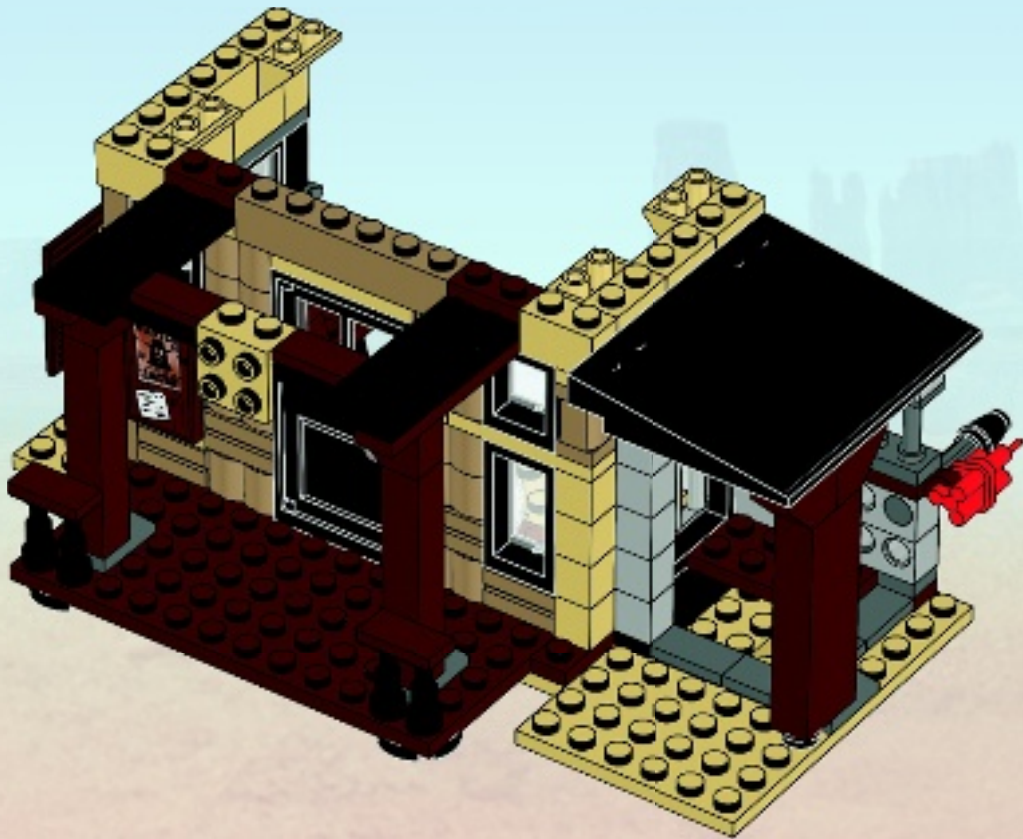

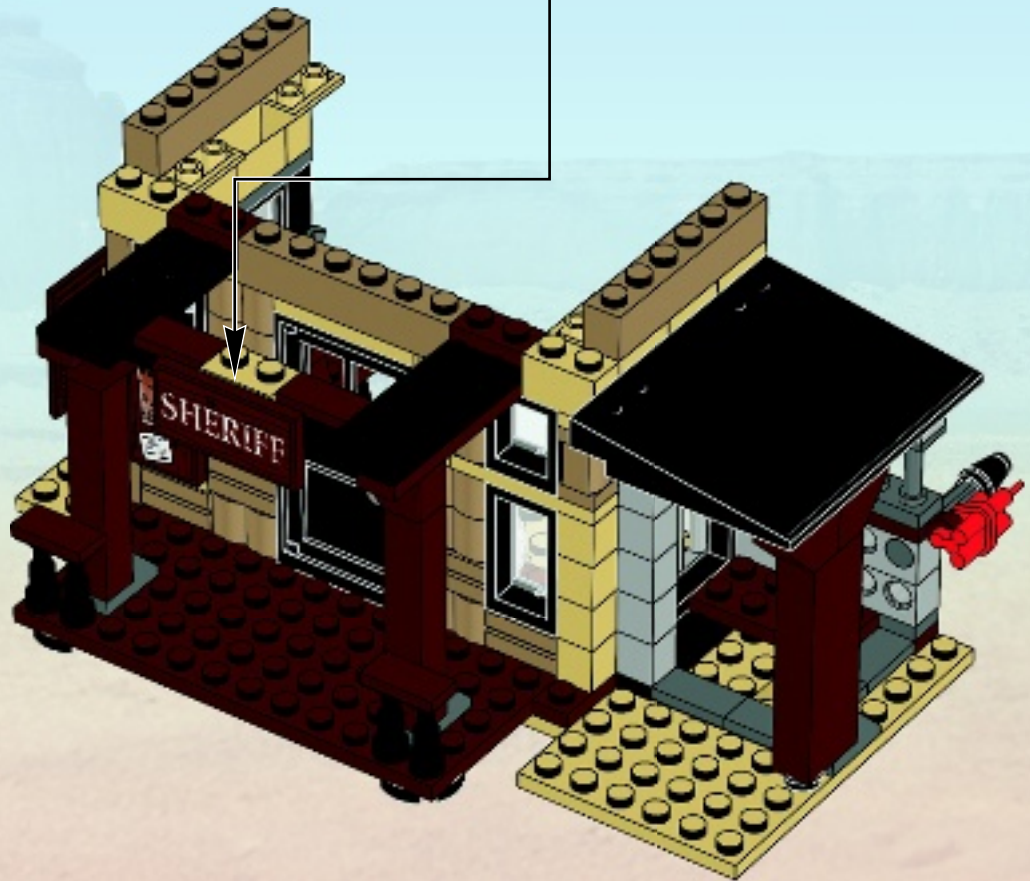
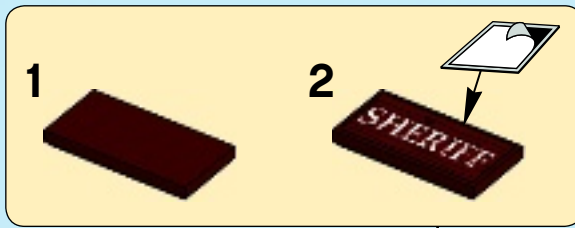
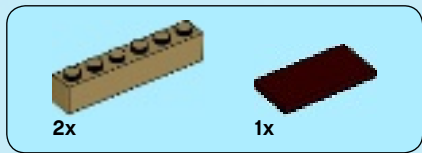

35



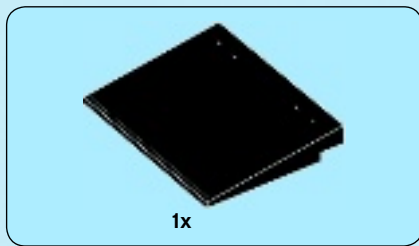

36

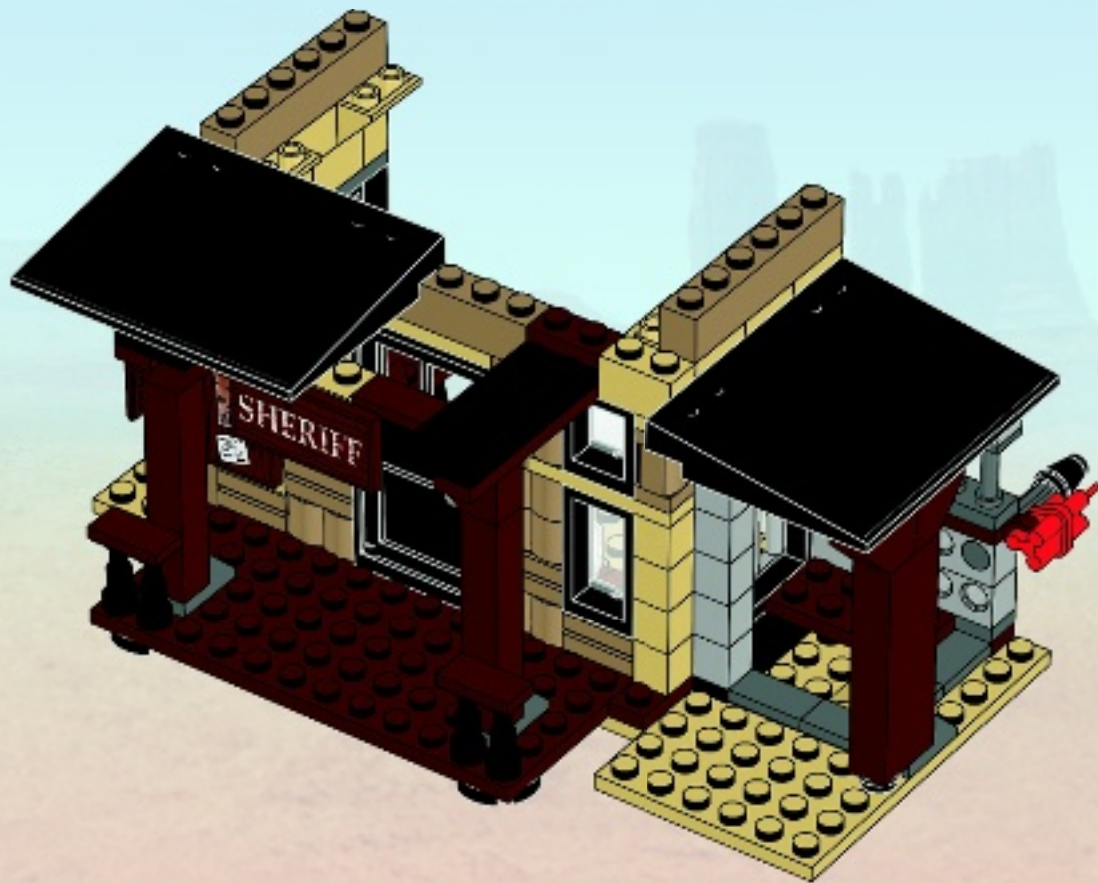

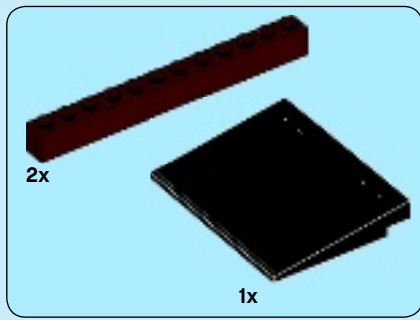

37

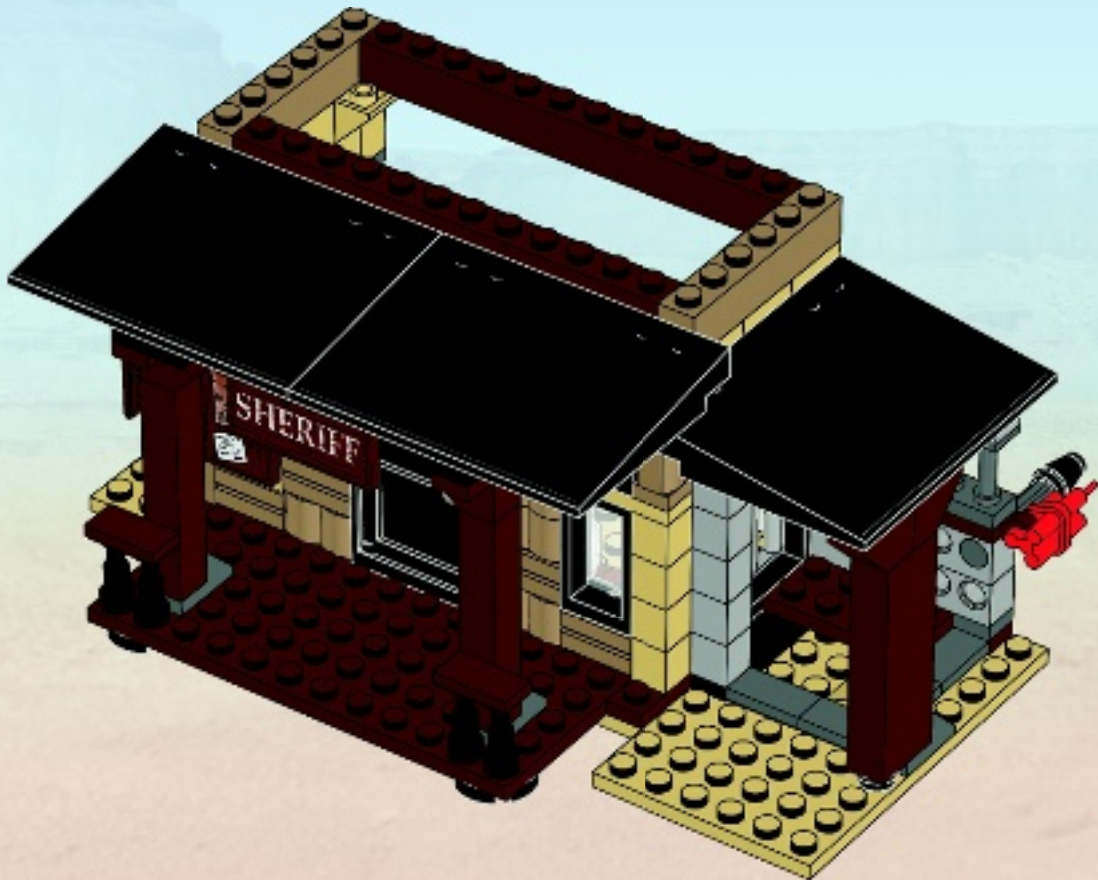

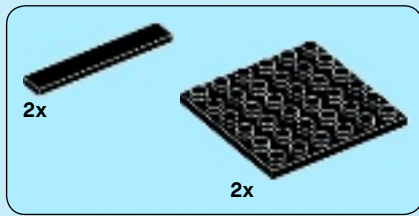

# 38

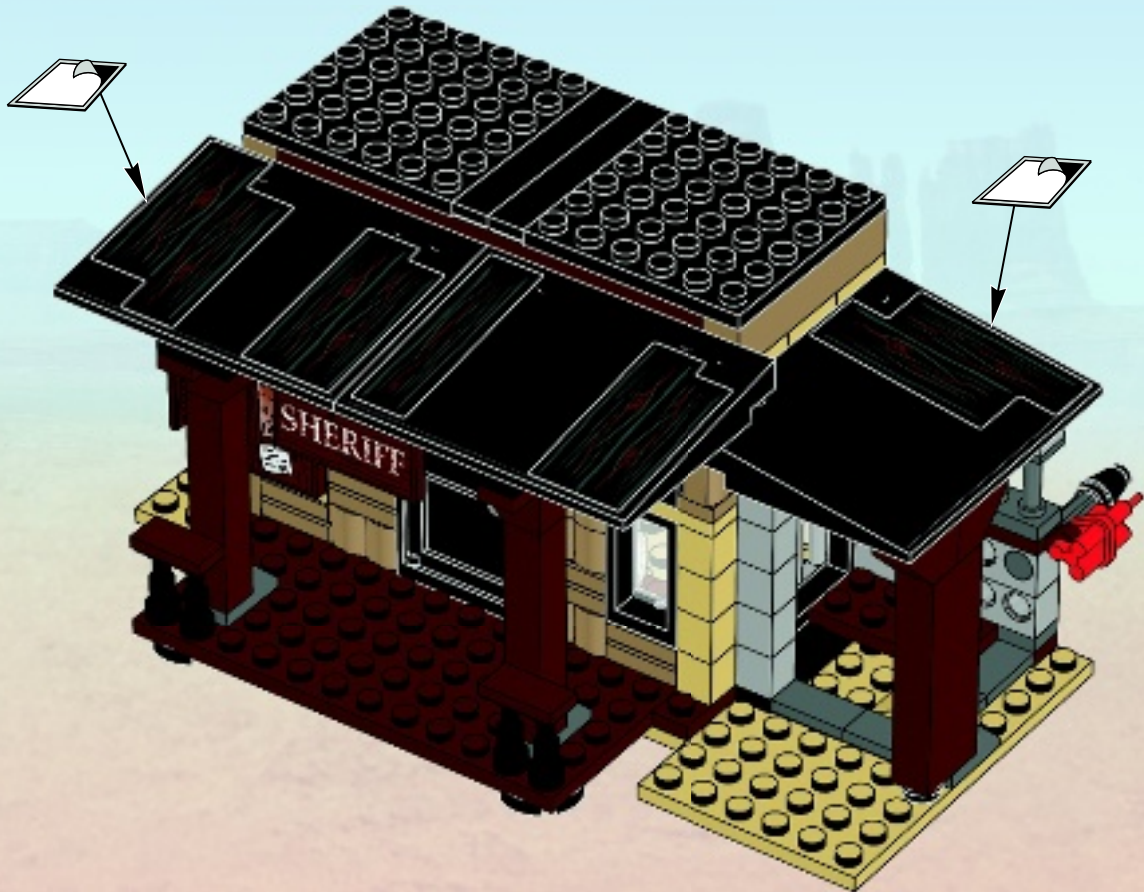

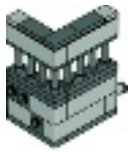

1x



1x

1

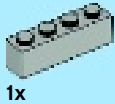
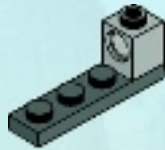

1x

2

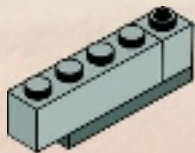

1x

3

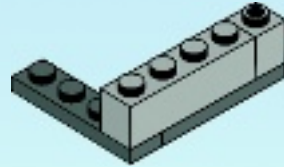

1x



1x



1x

4

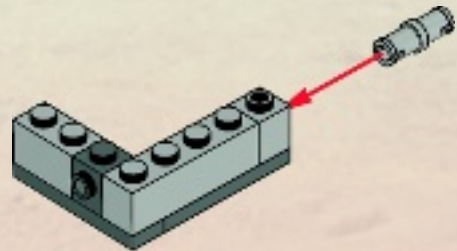



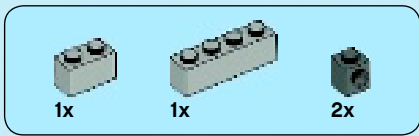

5

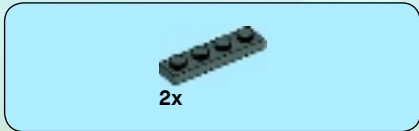
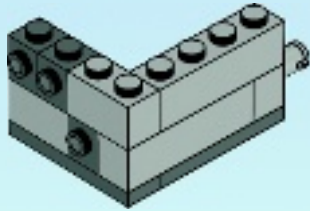

6

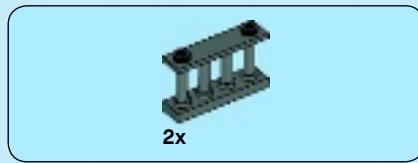
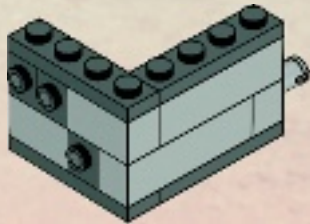

7

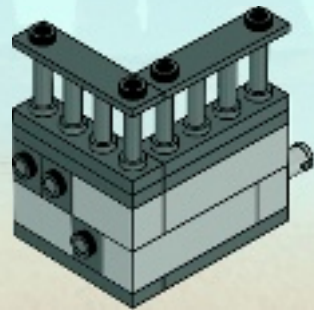



2x

8

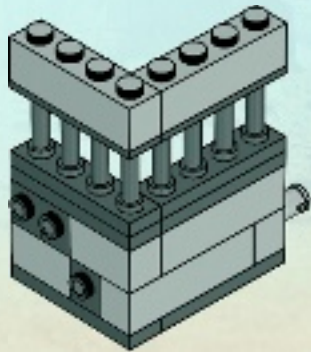

3x



2x

9

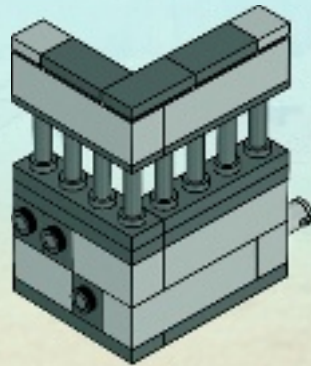

39

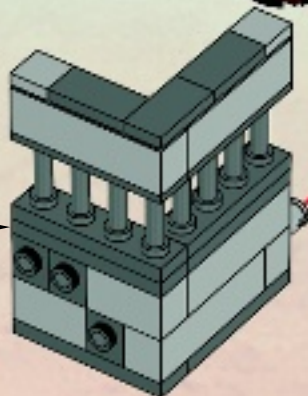
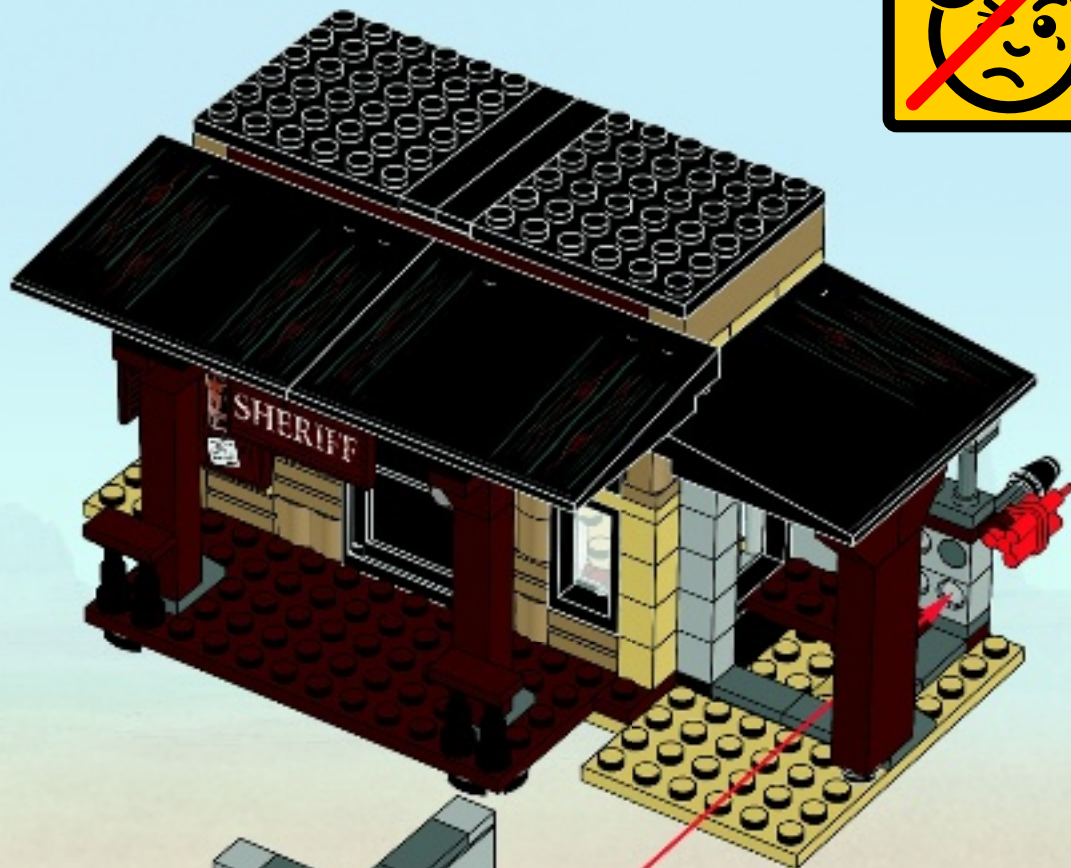



2x

40

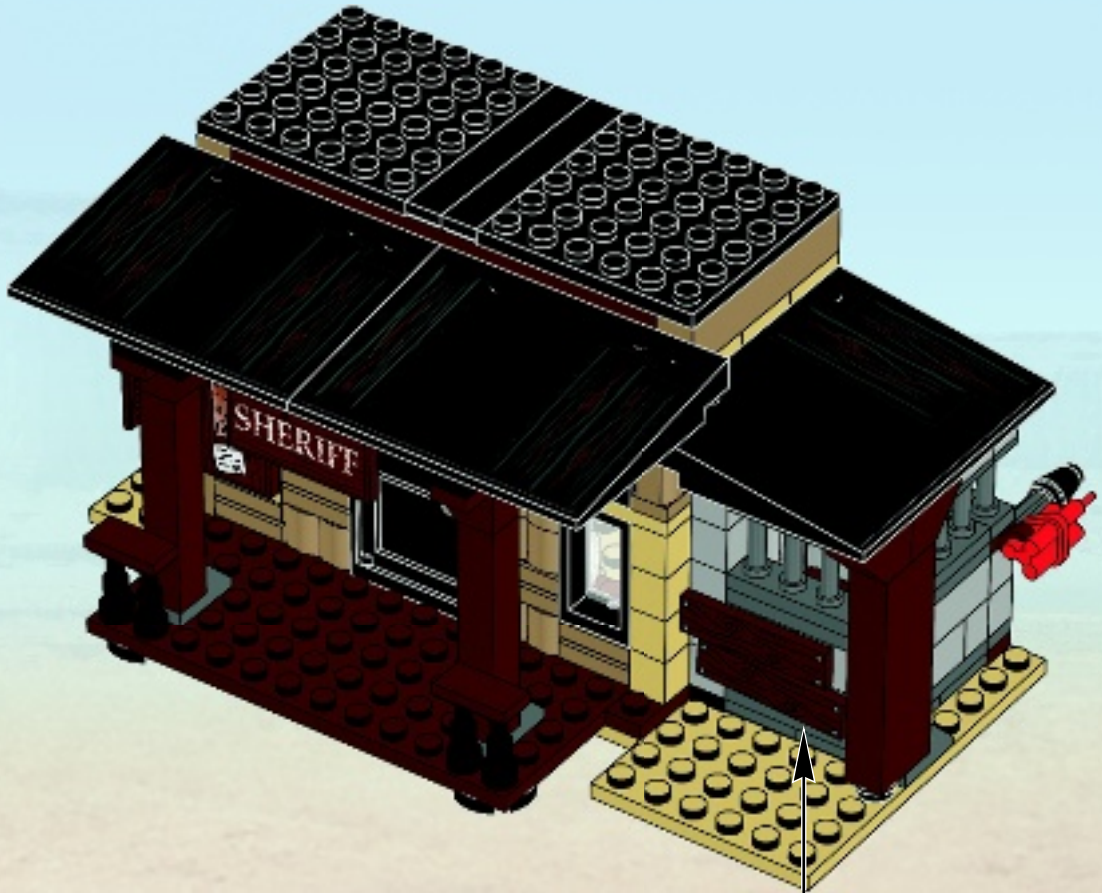

2x





2x

# 41

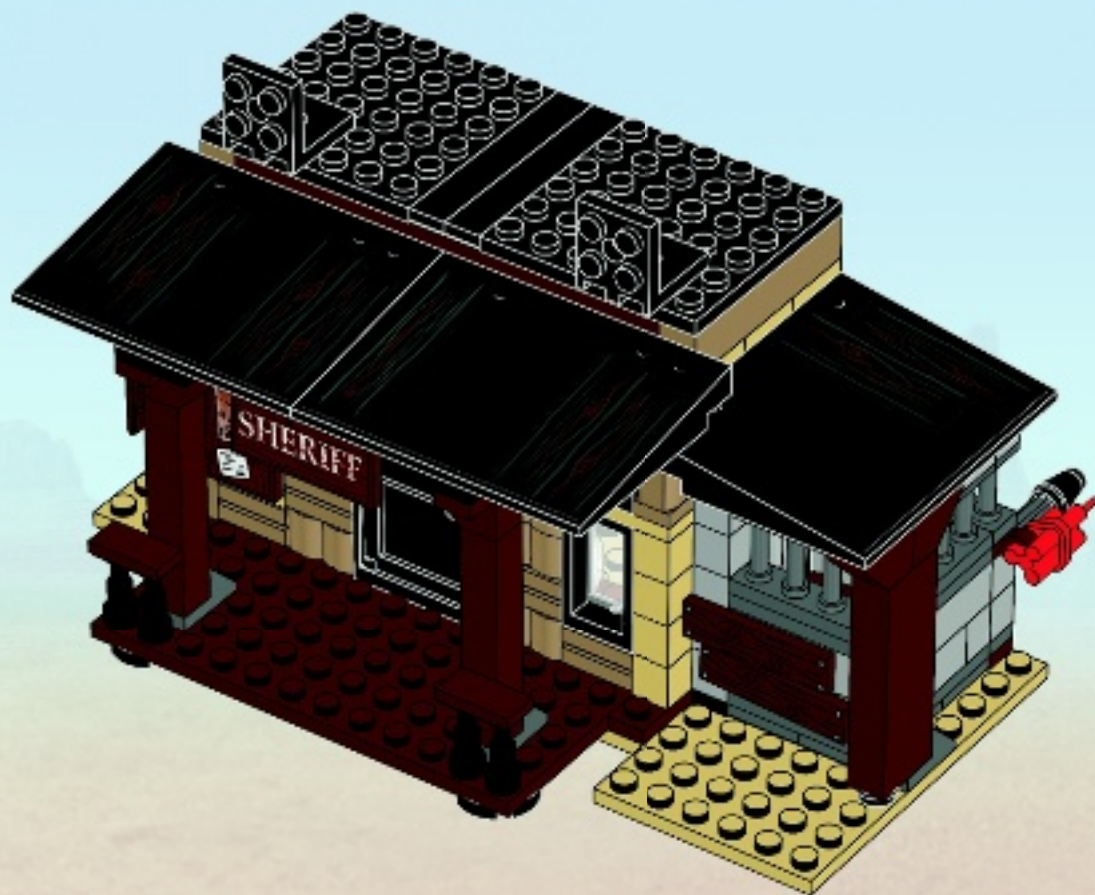

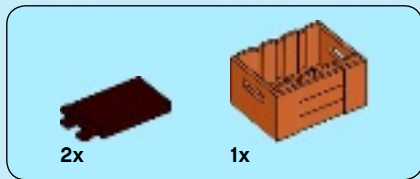

42

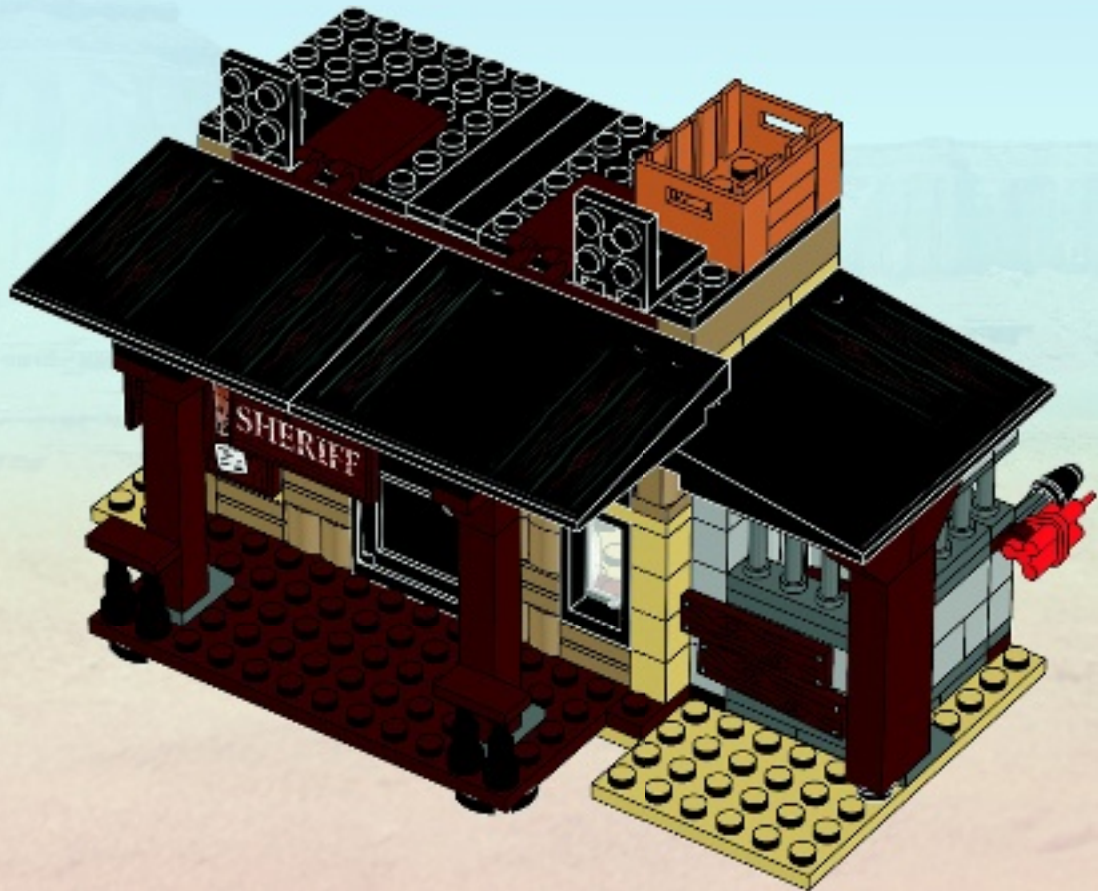

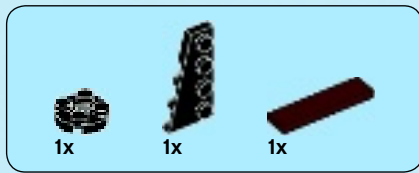

43

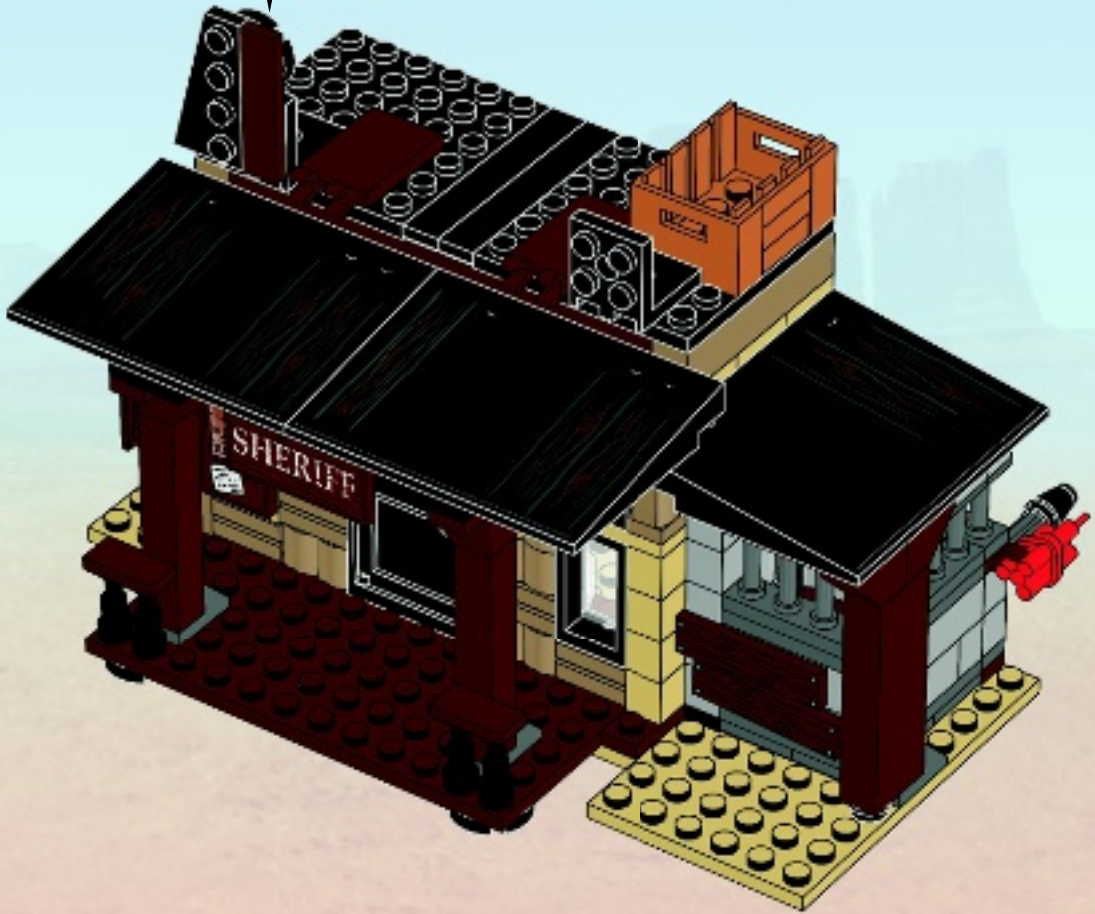





44

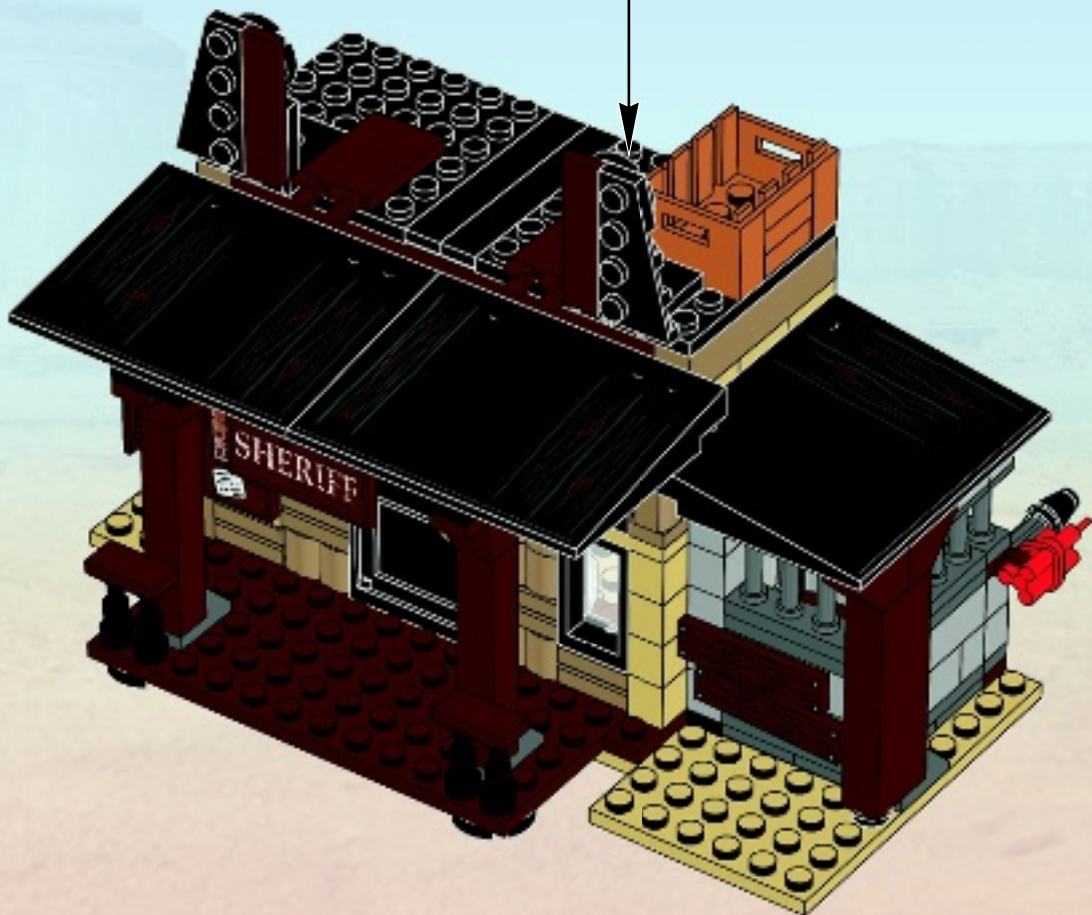





1

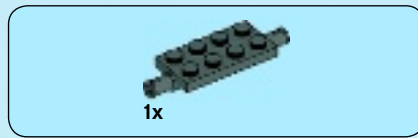
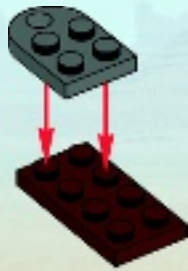

2

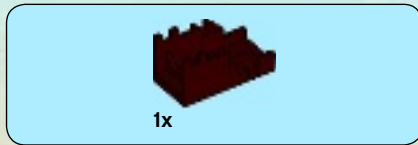

3

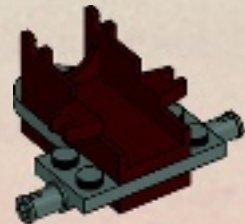



4



5



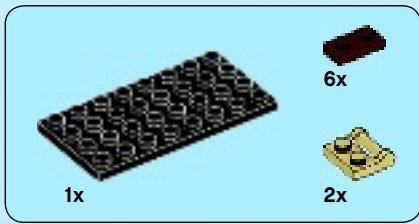

6

1



2

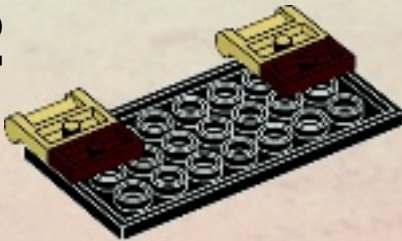

3

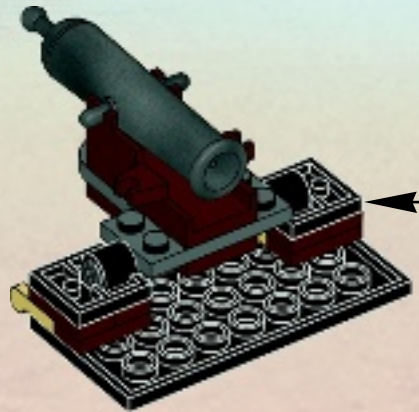
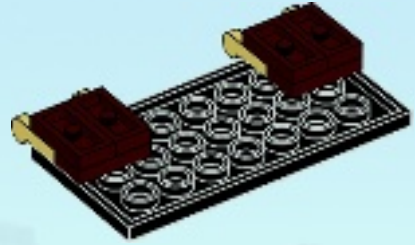

45

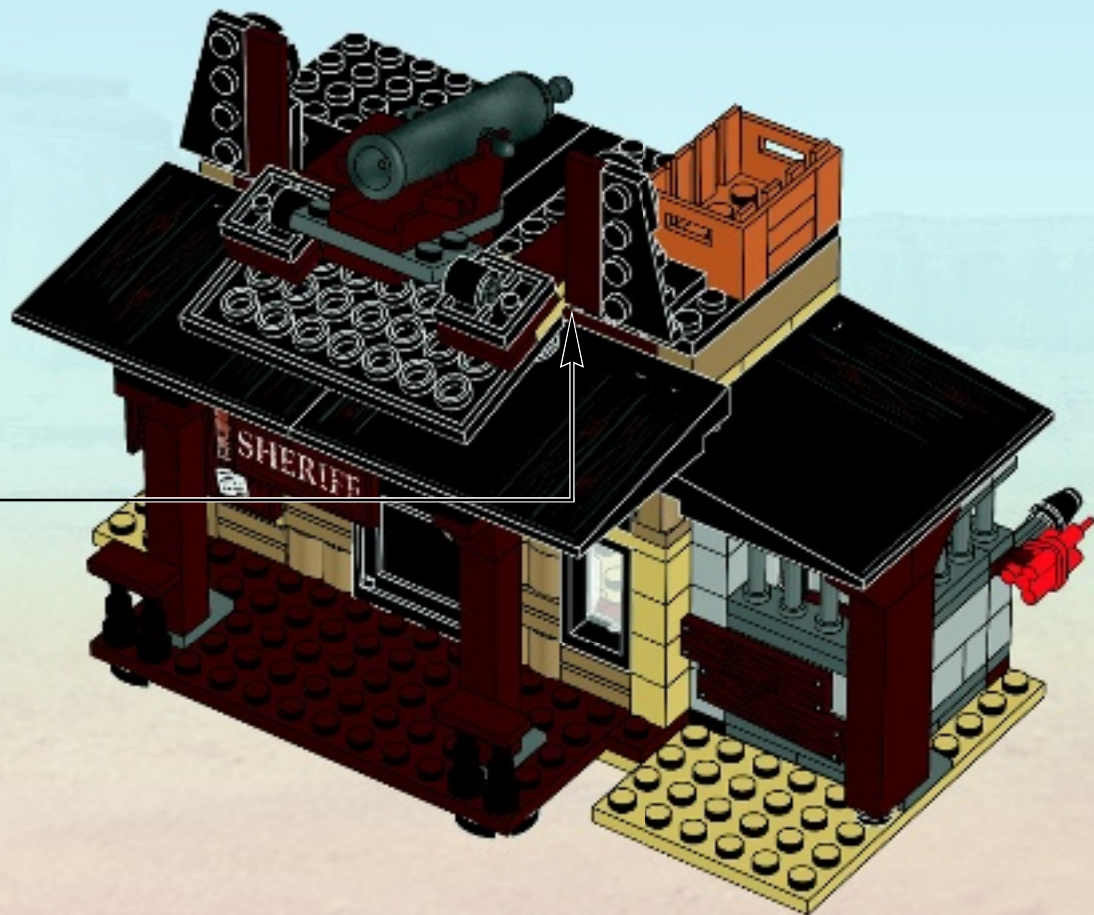



2x

3x

# 46



3x



2x

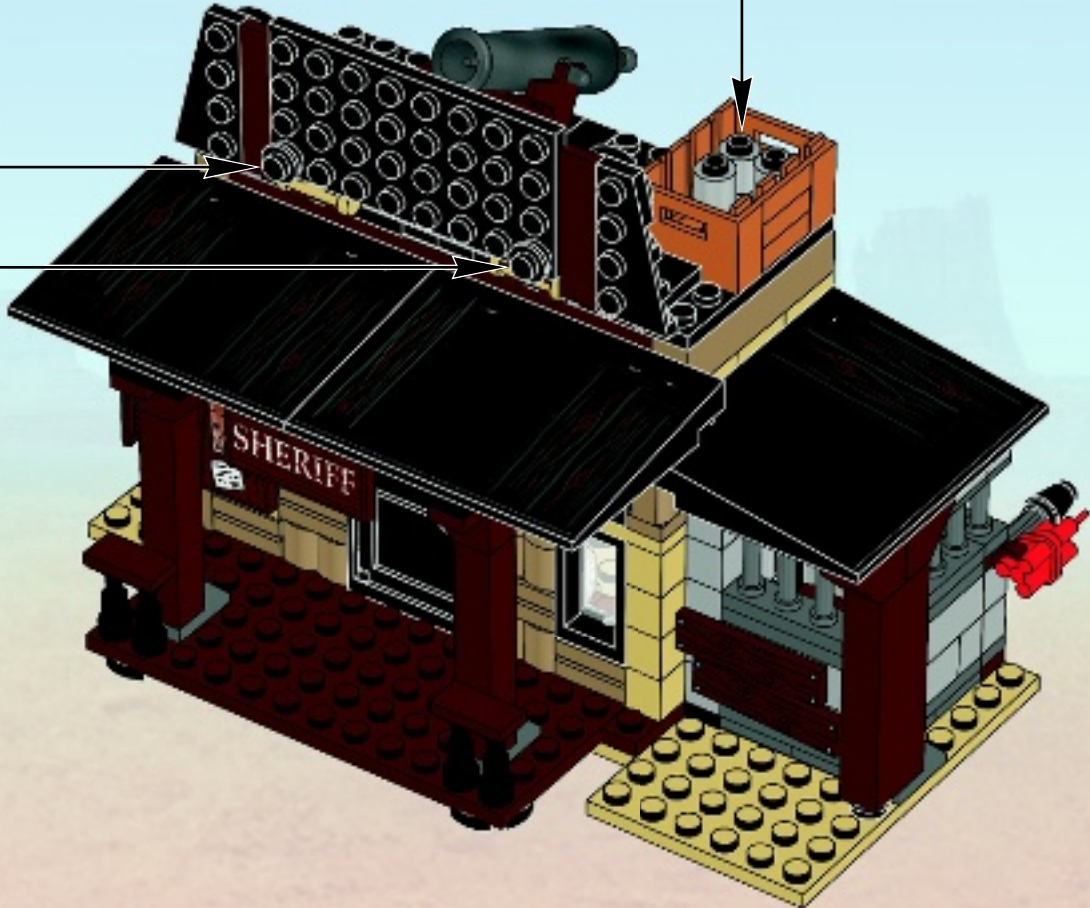

47

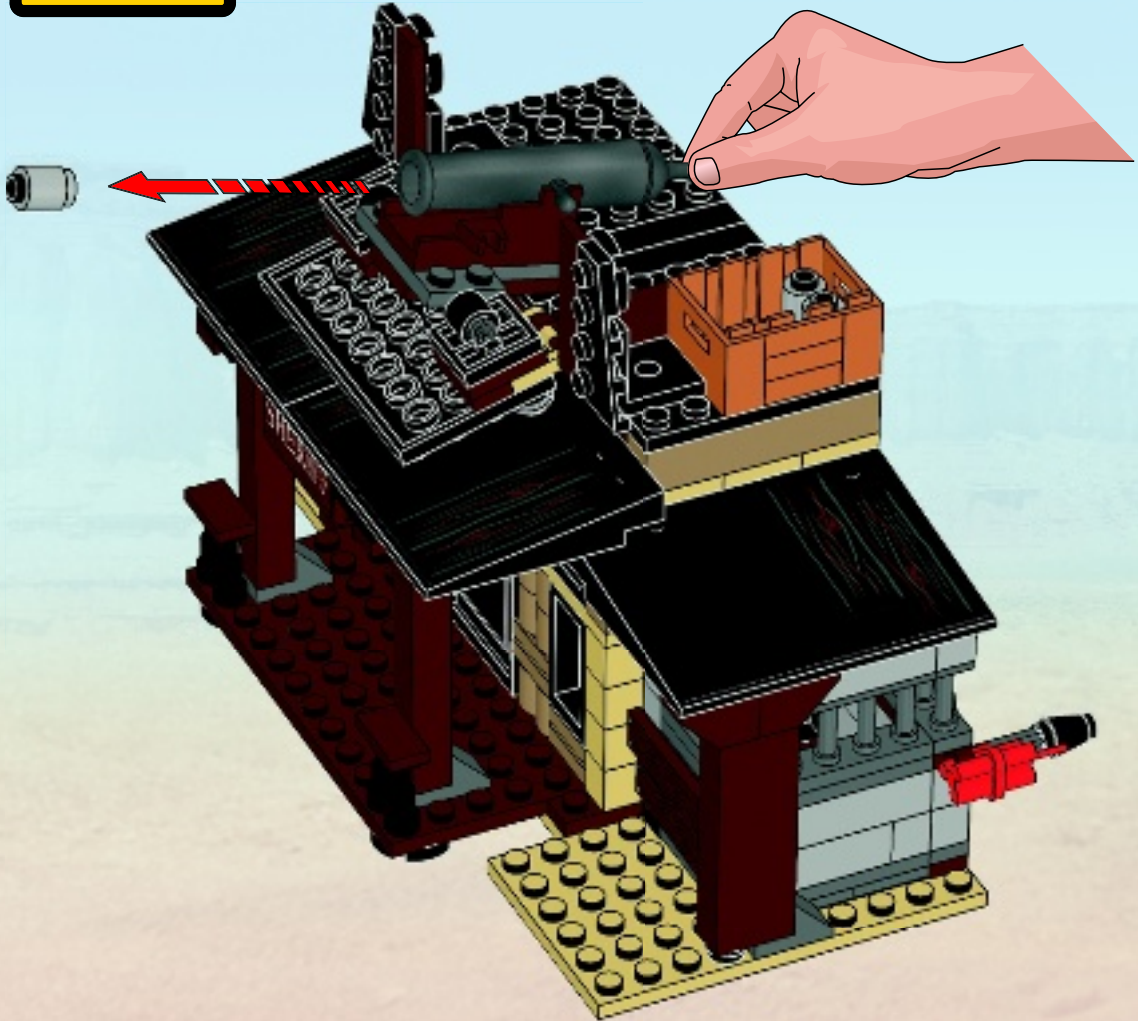

48

