



# THE LONE RANGER



79110



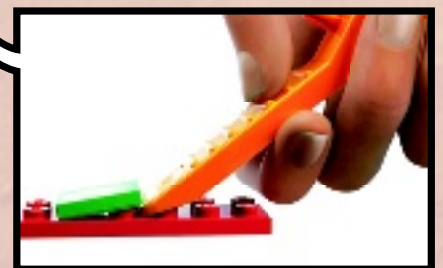
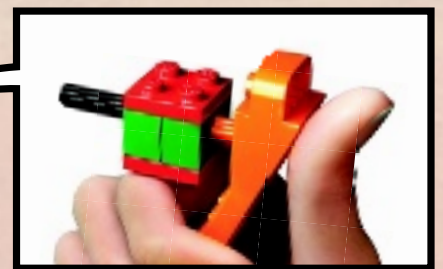



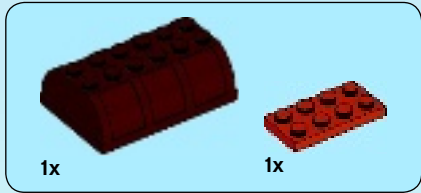

1



2

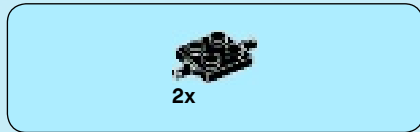

3

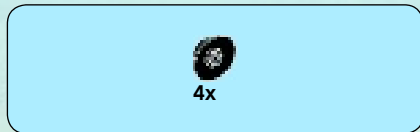

4

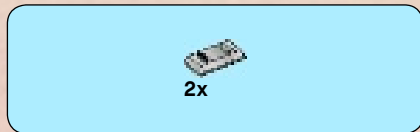

5

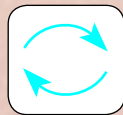

2x

2x



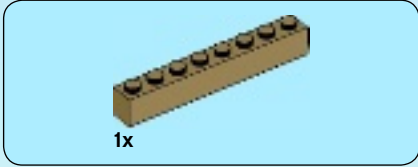
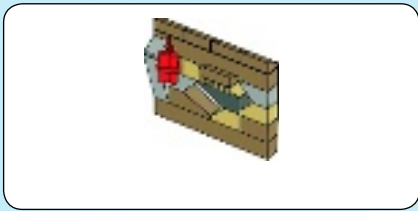

1



2

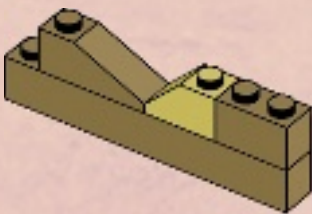

3

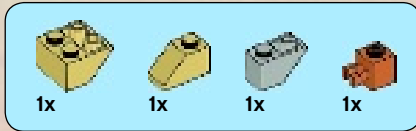
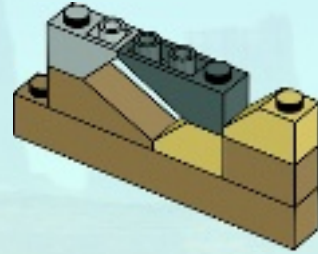

4

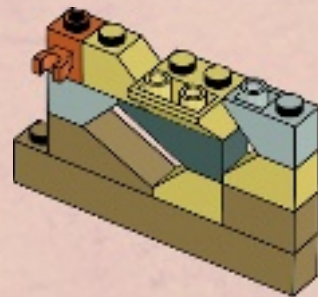

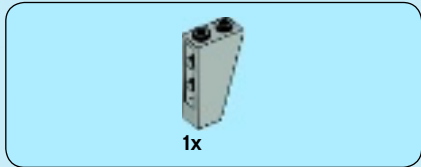

5

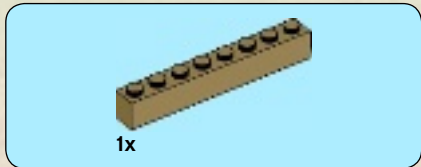
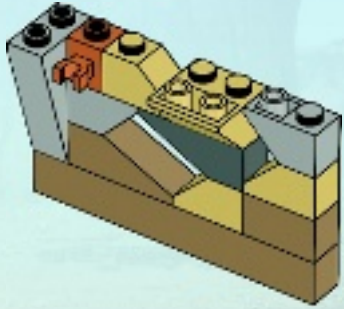

6

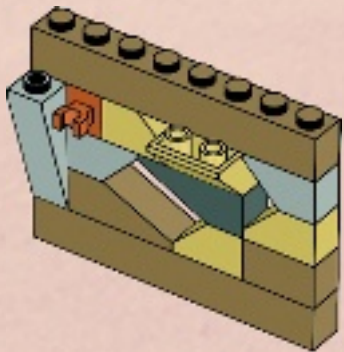

7

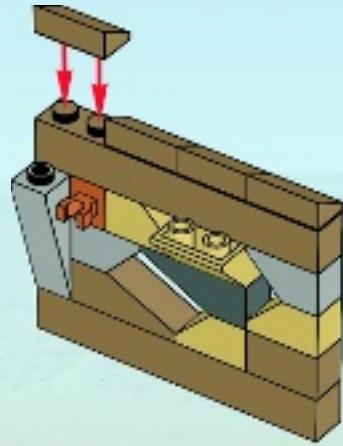

8

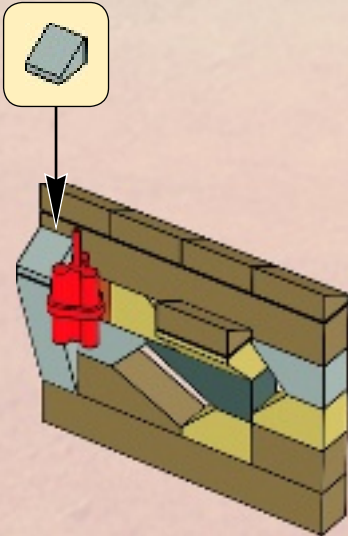

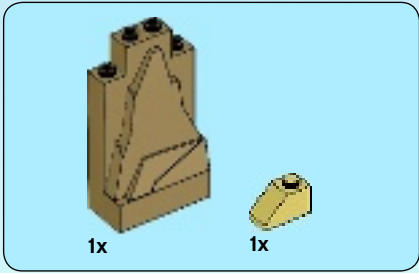
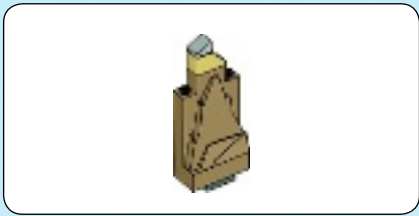

**1**

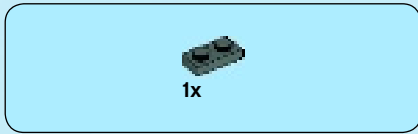

**2**



**3**

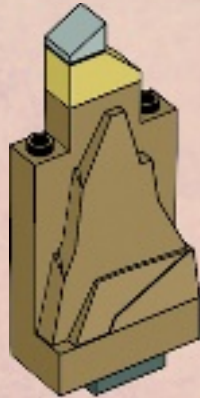

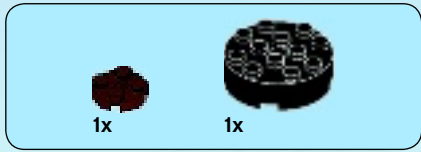

1

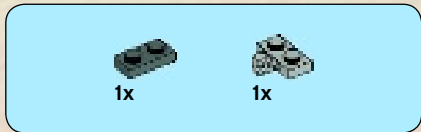

2

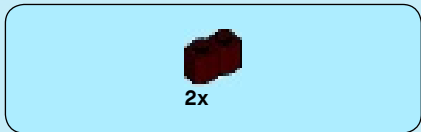

3

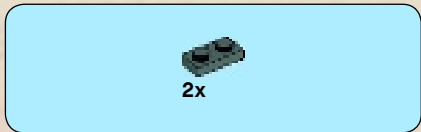

4







1x



1x

# 5



2x

# 6



1x

# 7



1x

# 8

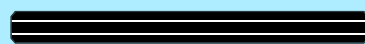
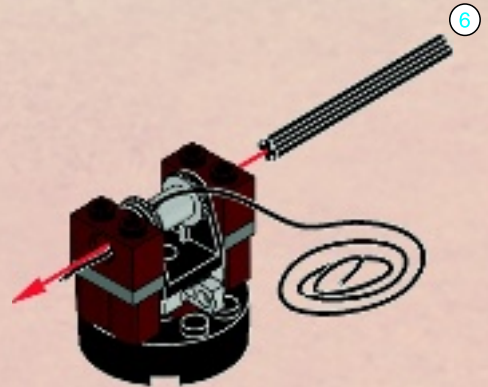

6

# 1:1



2x

# 9



2x

# 10

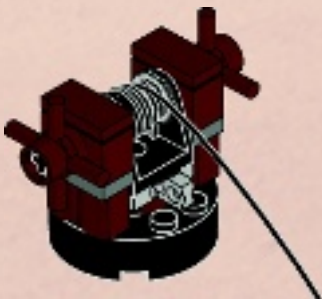

1x

8



2x

# 11

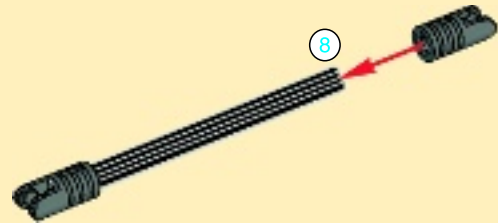
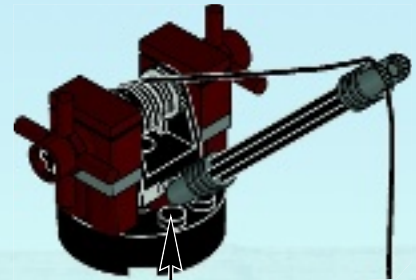

8

1:1



1x

# 12





13

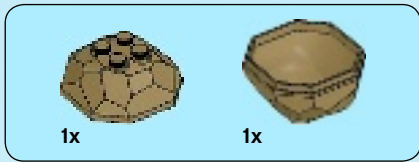
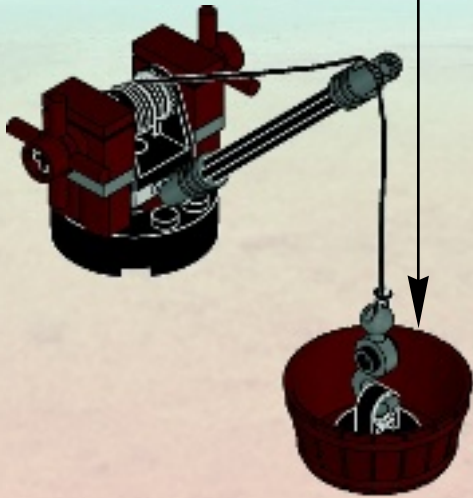

1

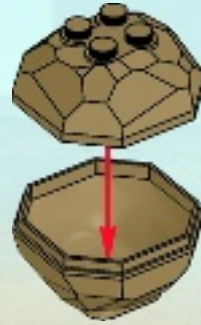

2



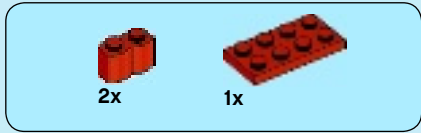

1

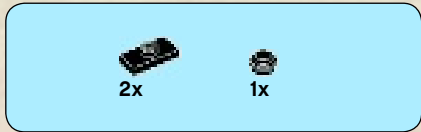
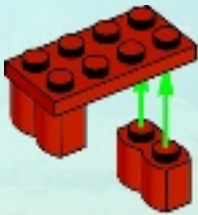

2

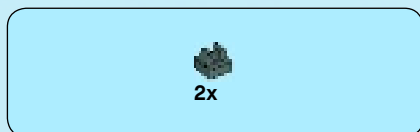

3

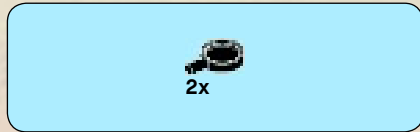
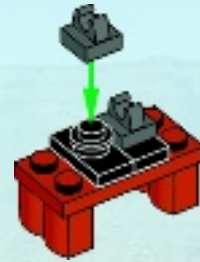

4

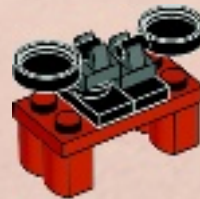

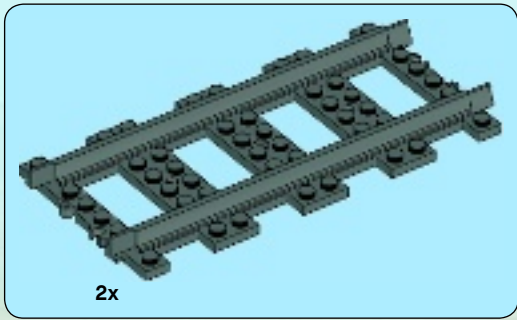
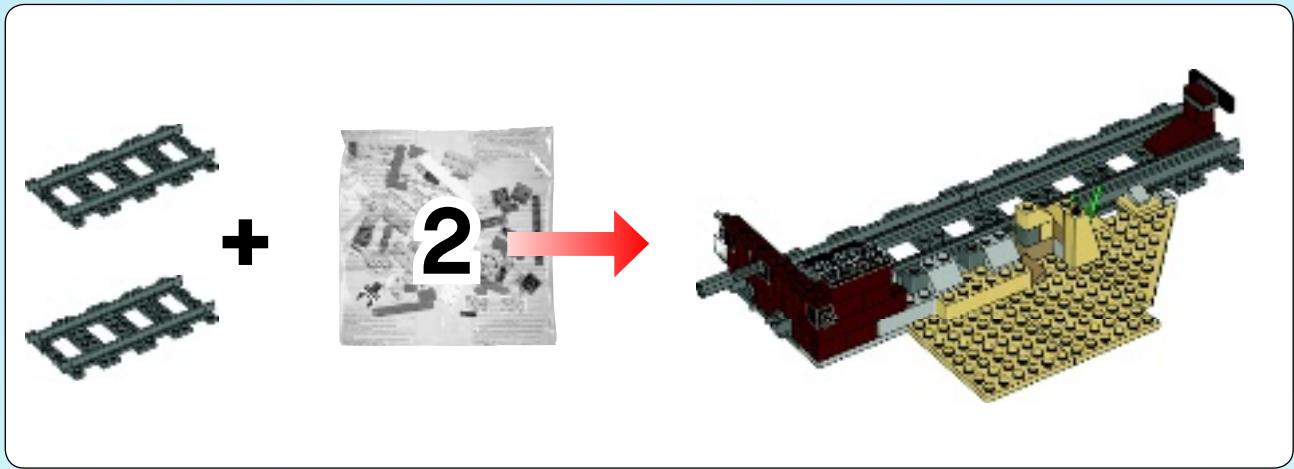

1

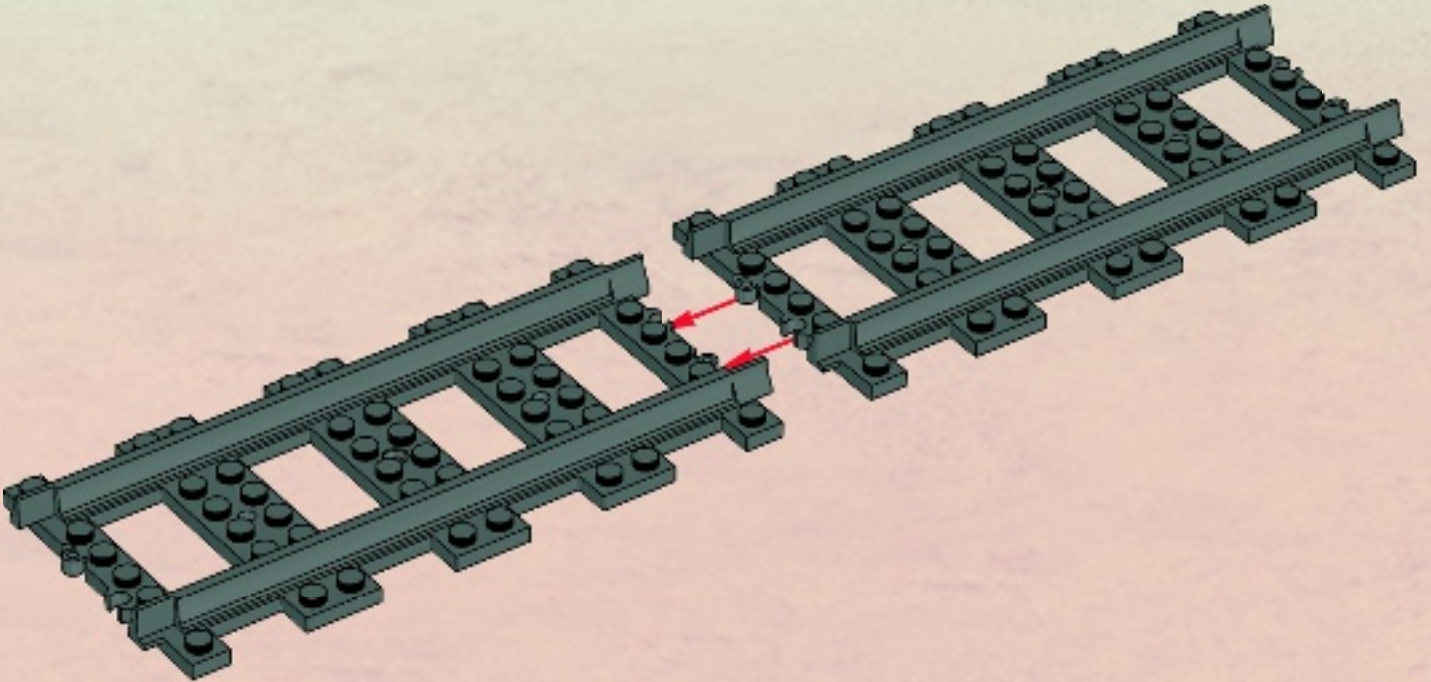

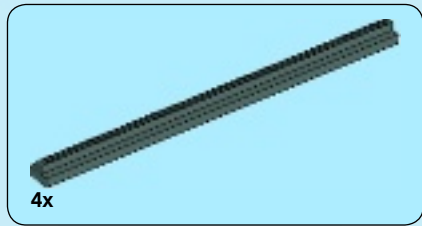

2

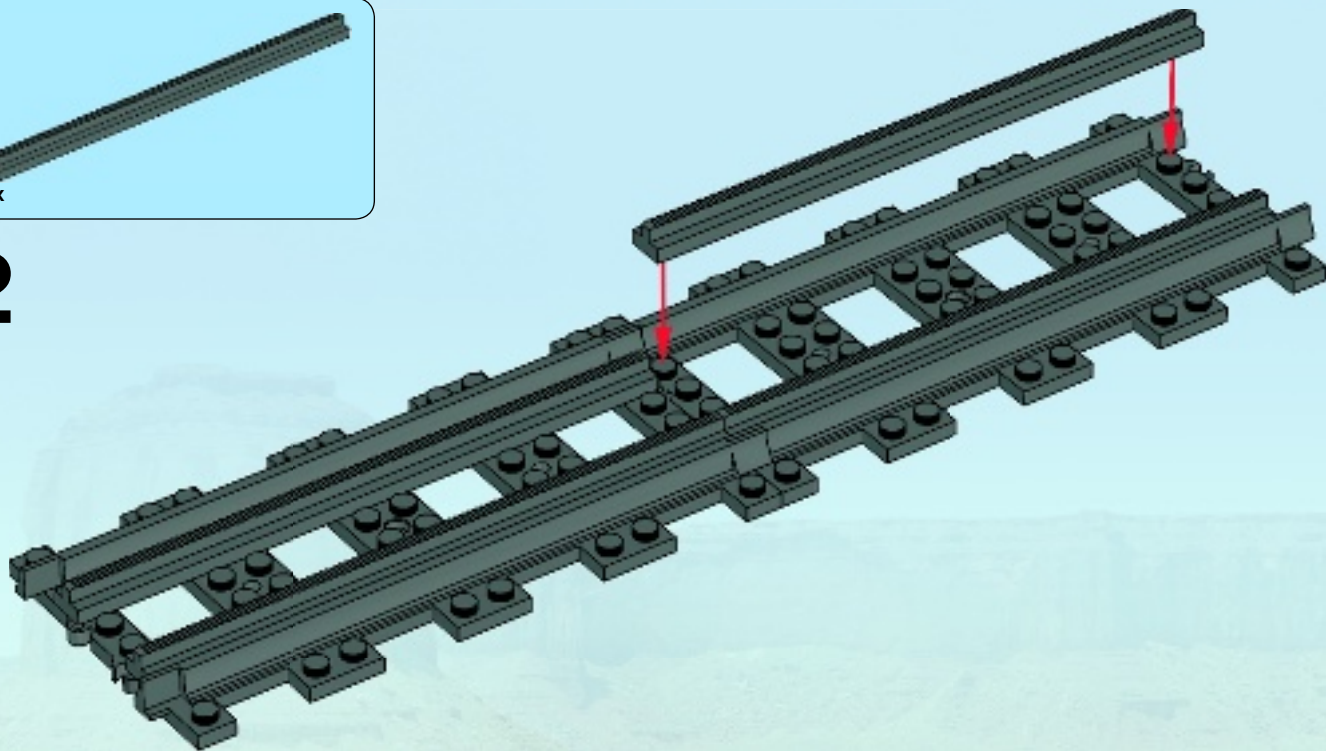

3

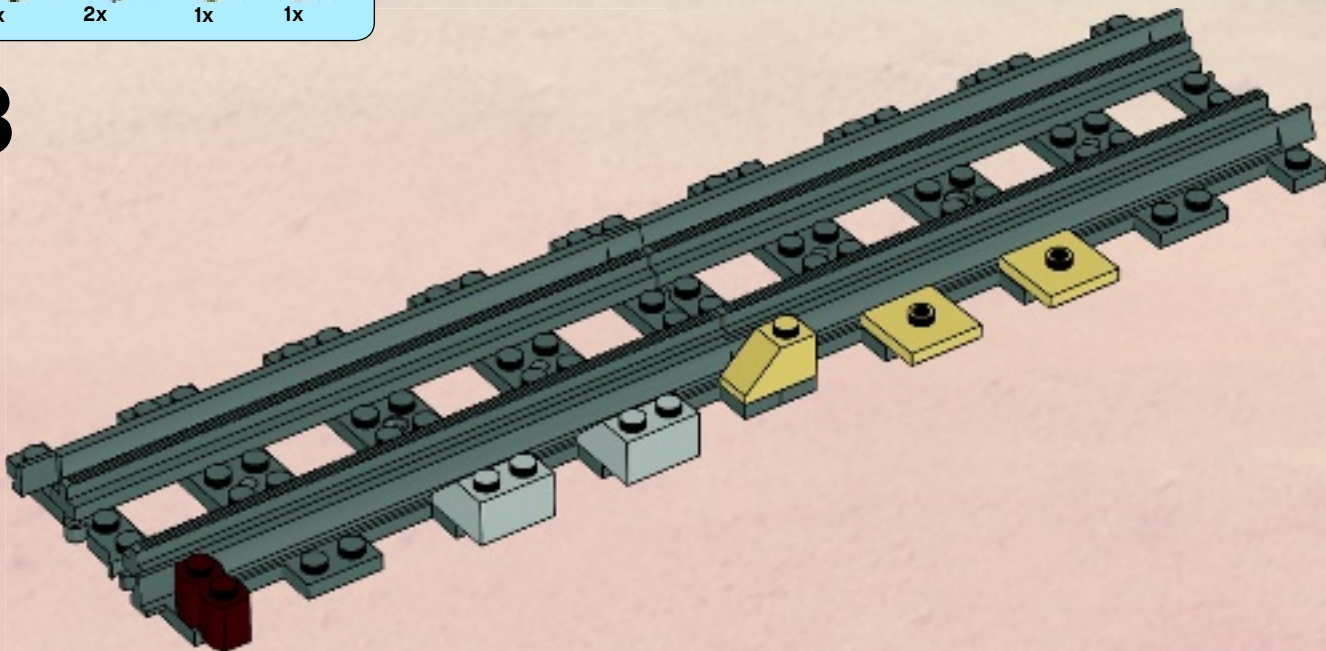

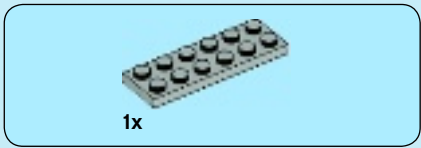

4

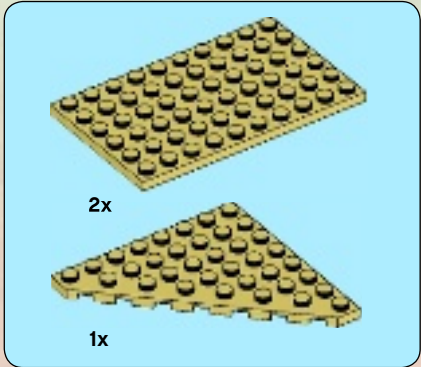

5

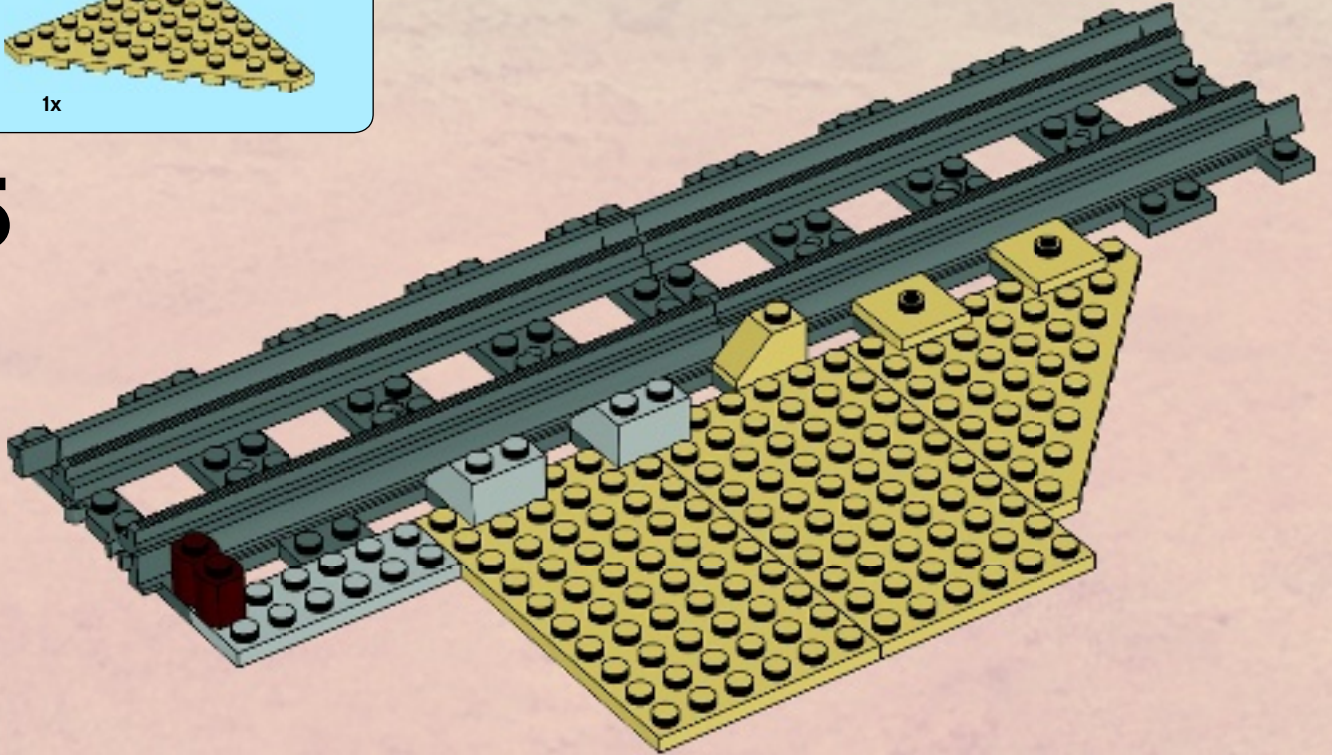

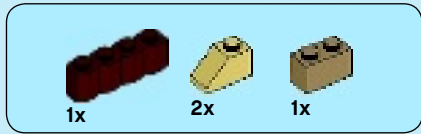

6

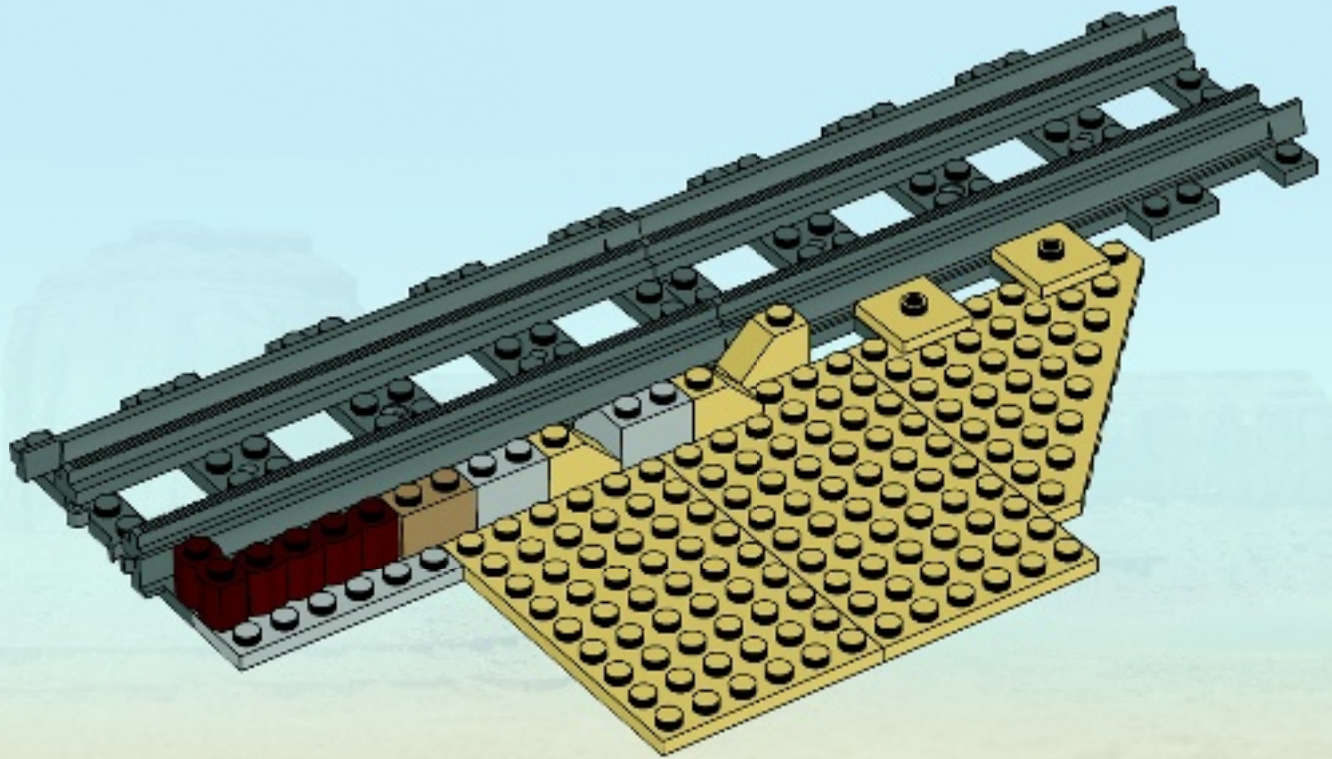

7

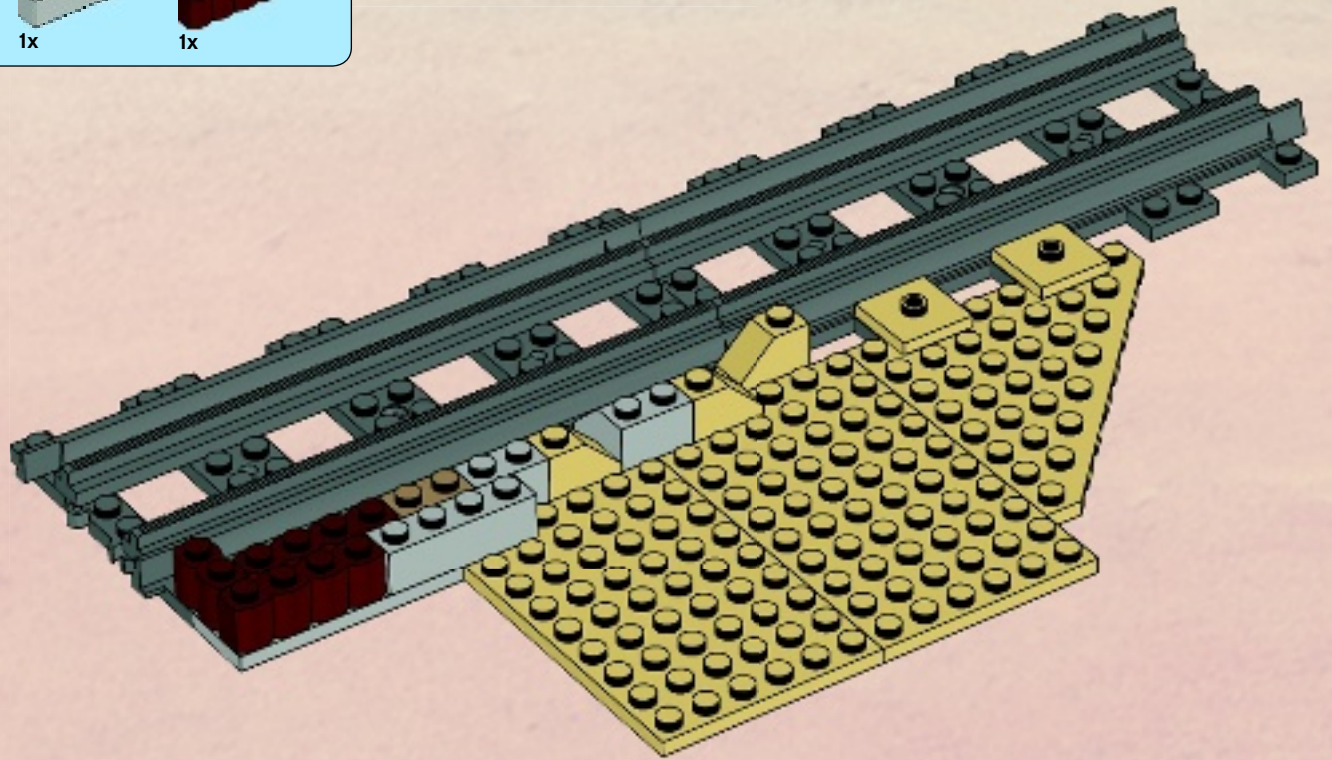



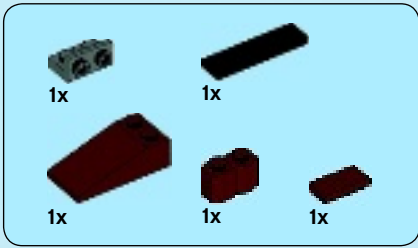

8

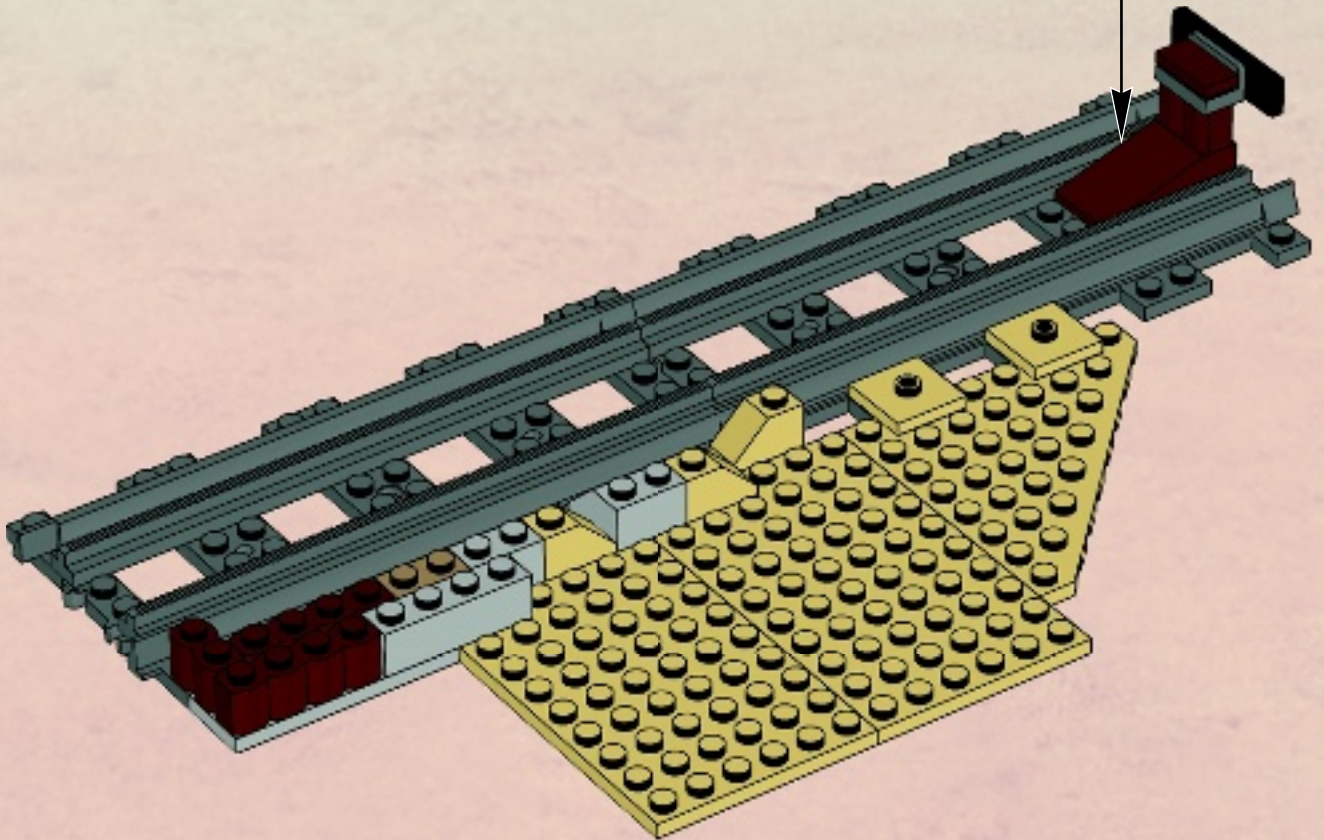
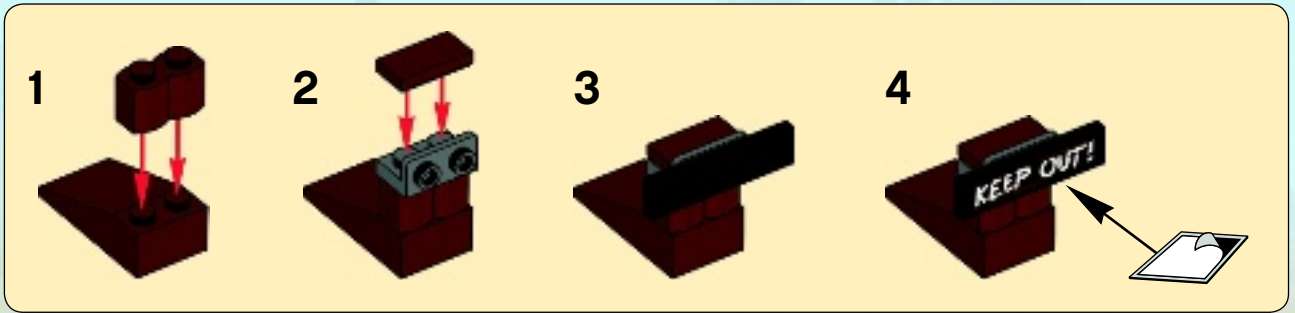

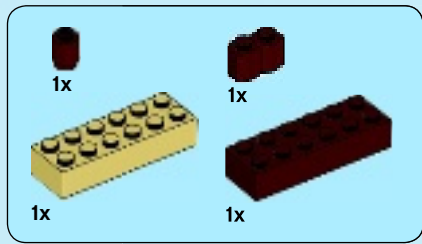

9

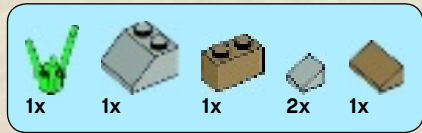
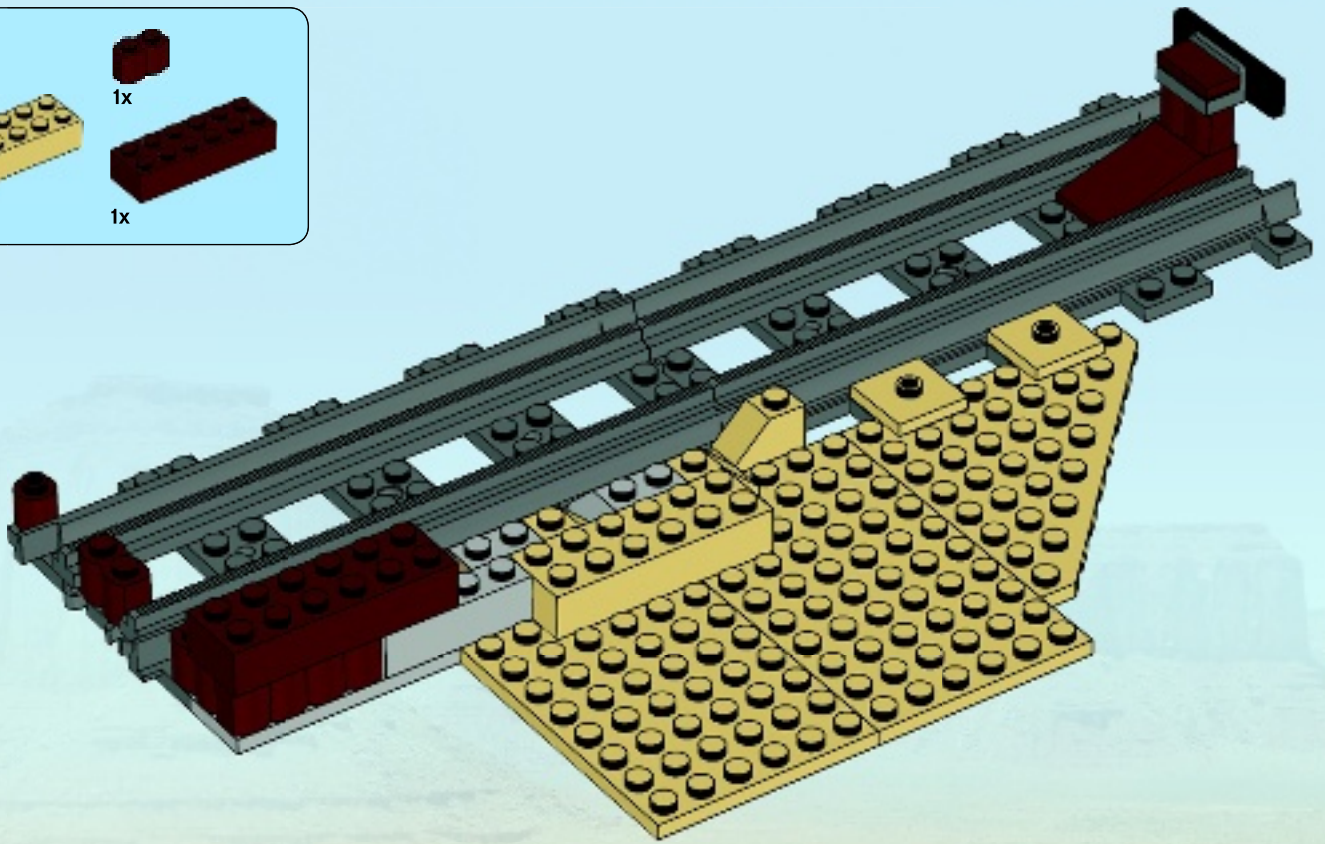

10

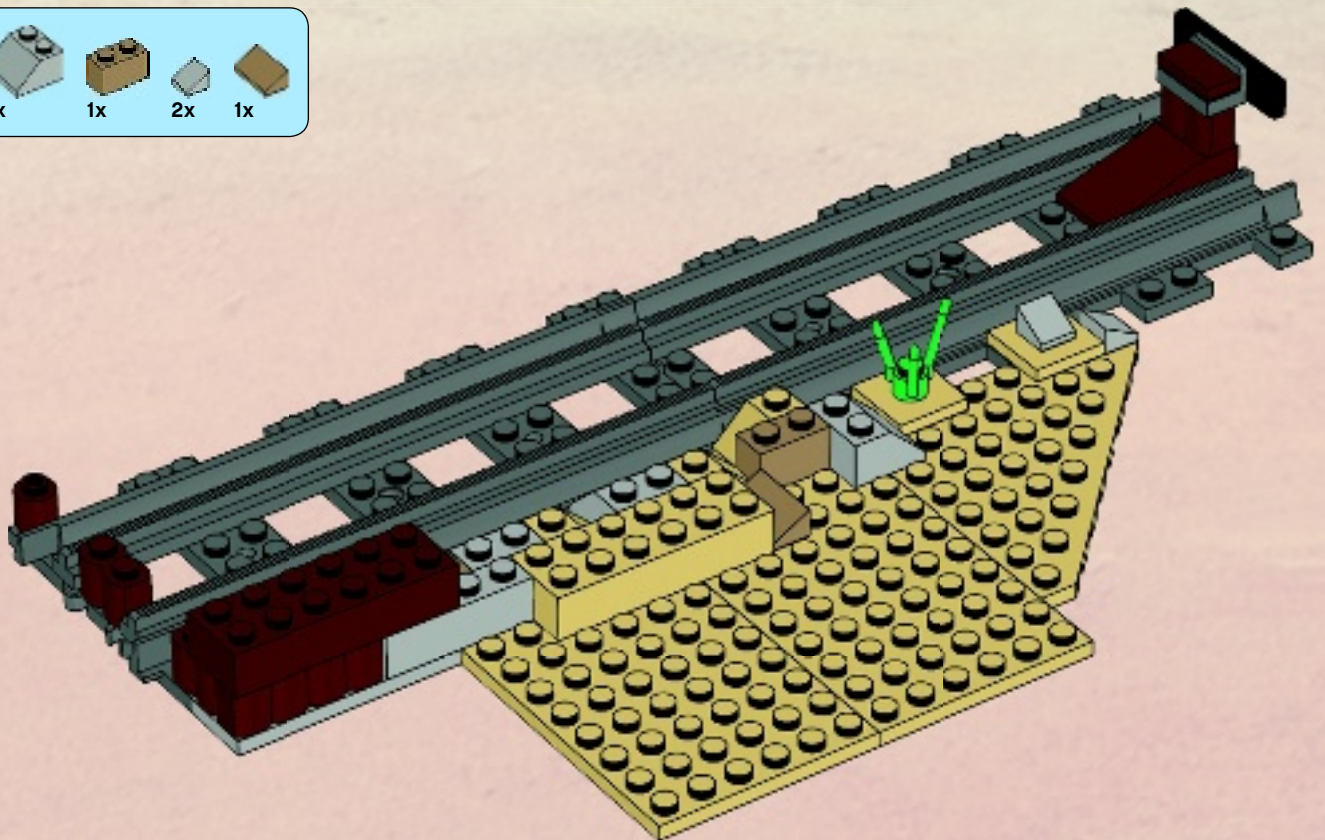

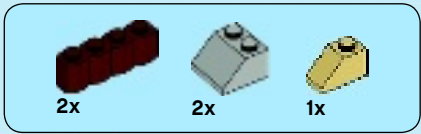

# 11

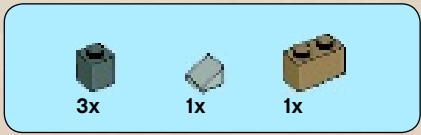
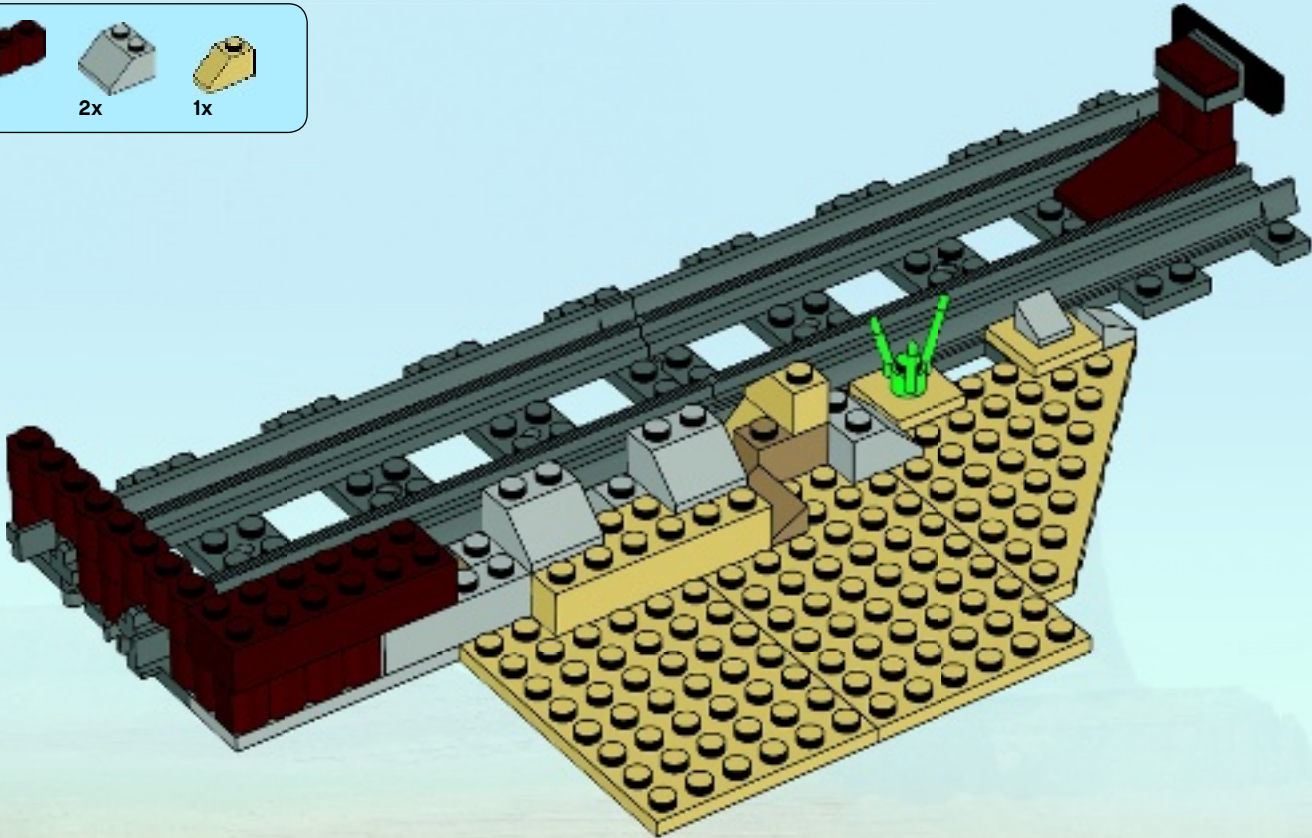

# 12

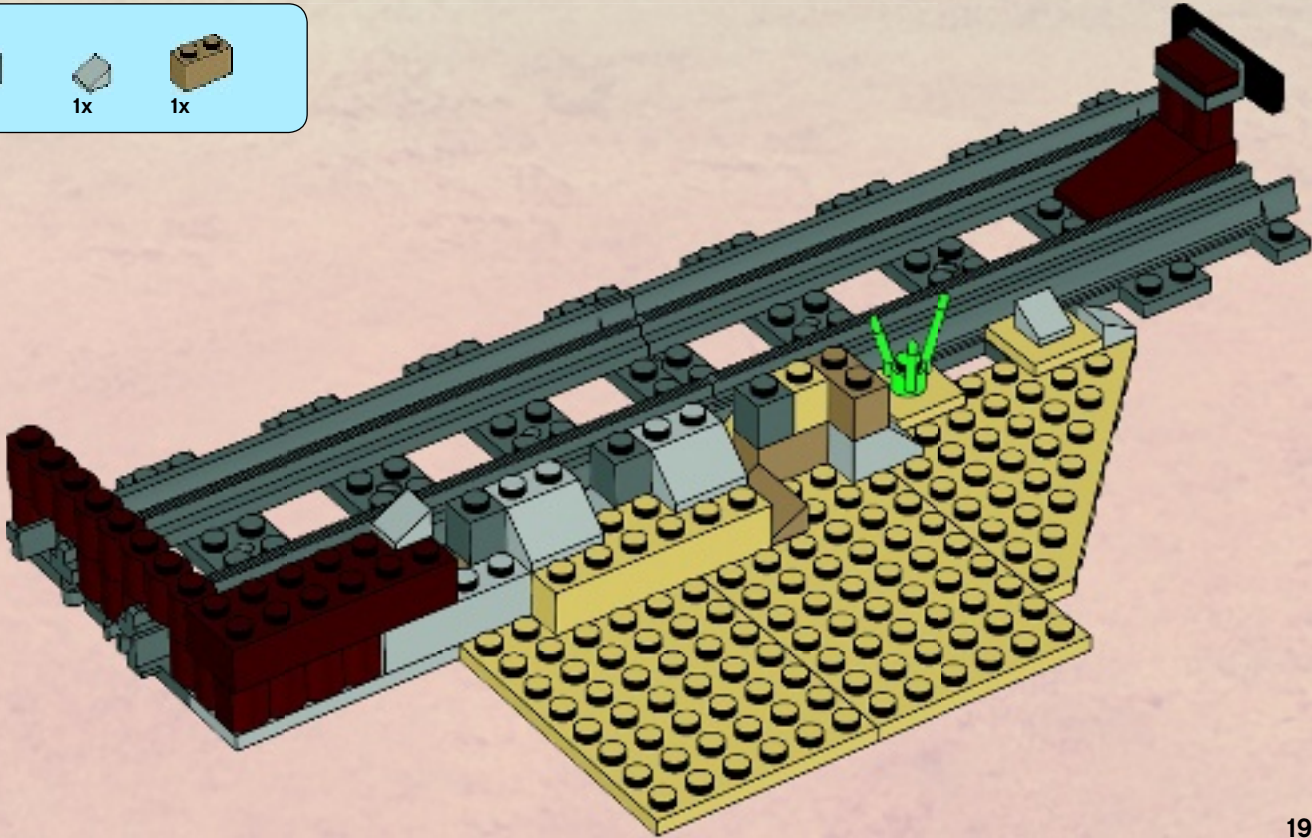

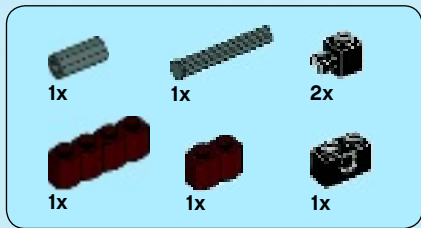

# 13

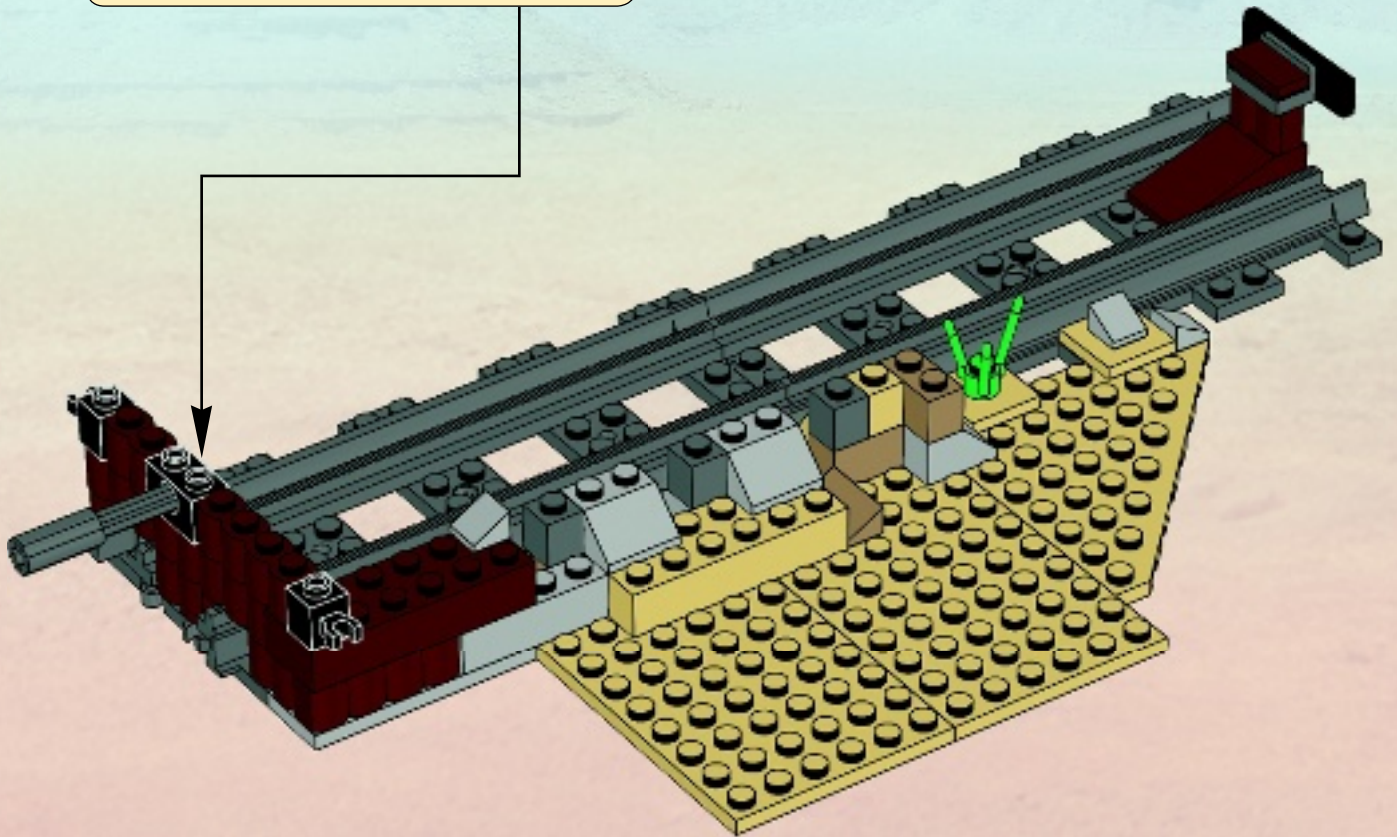
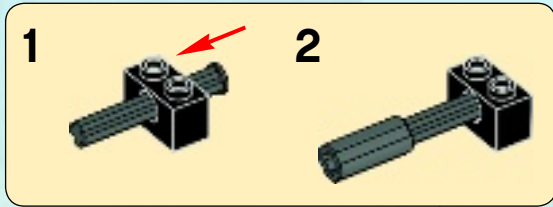



14

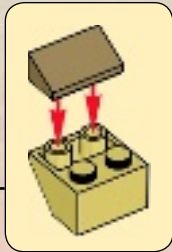
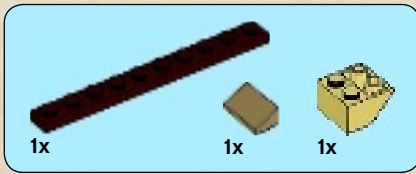
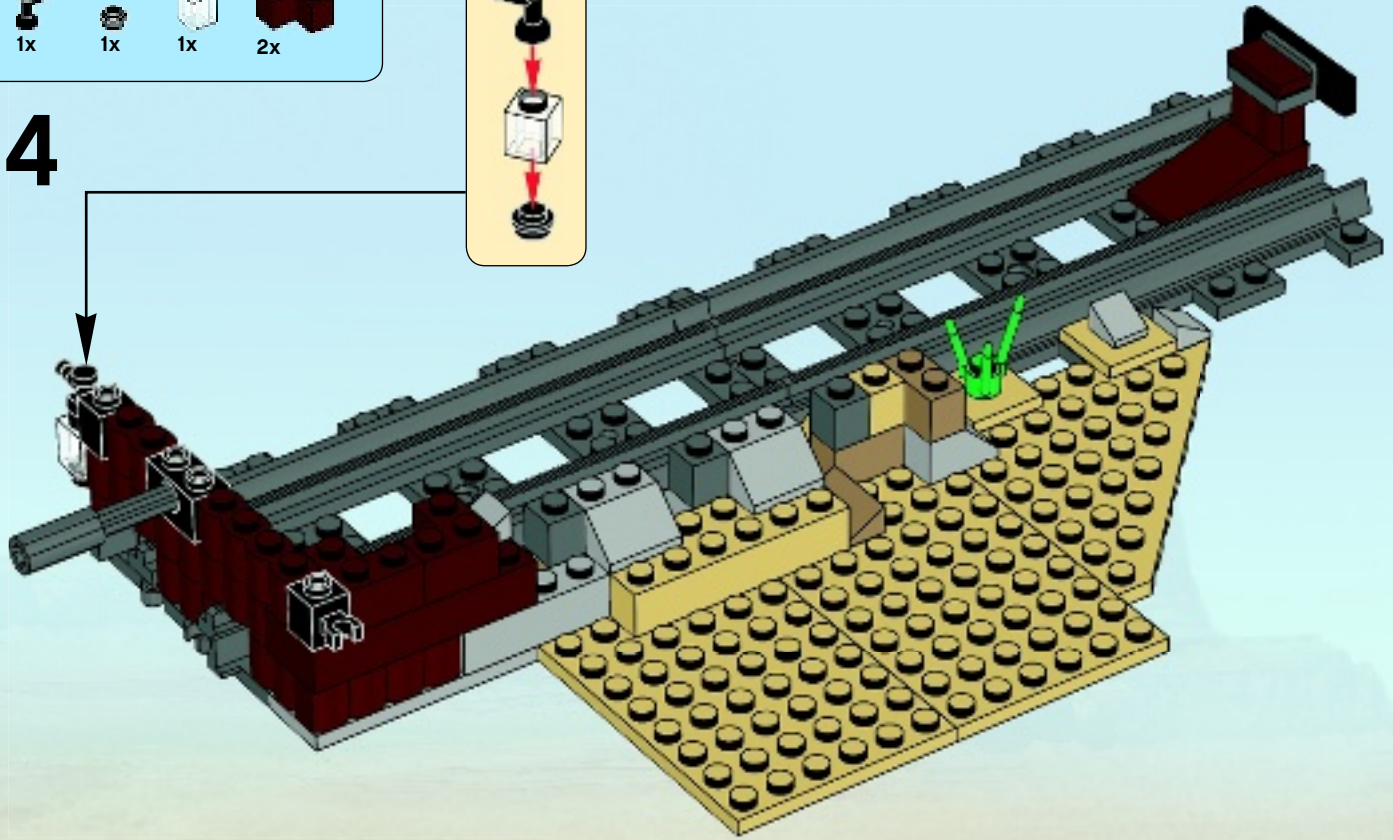

15

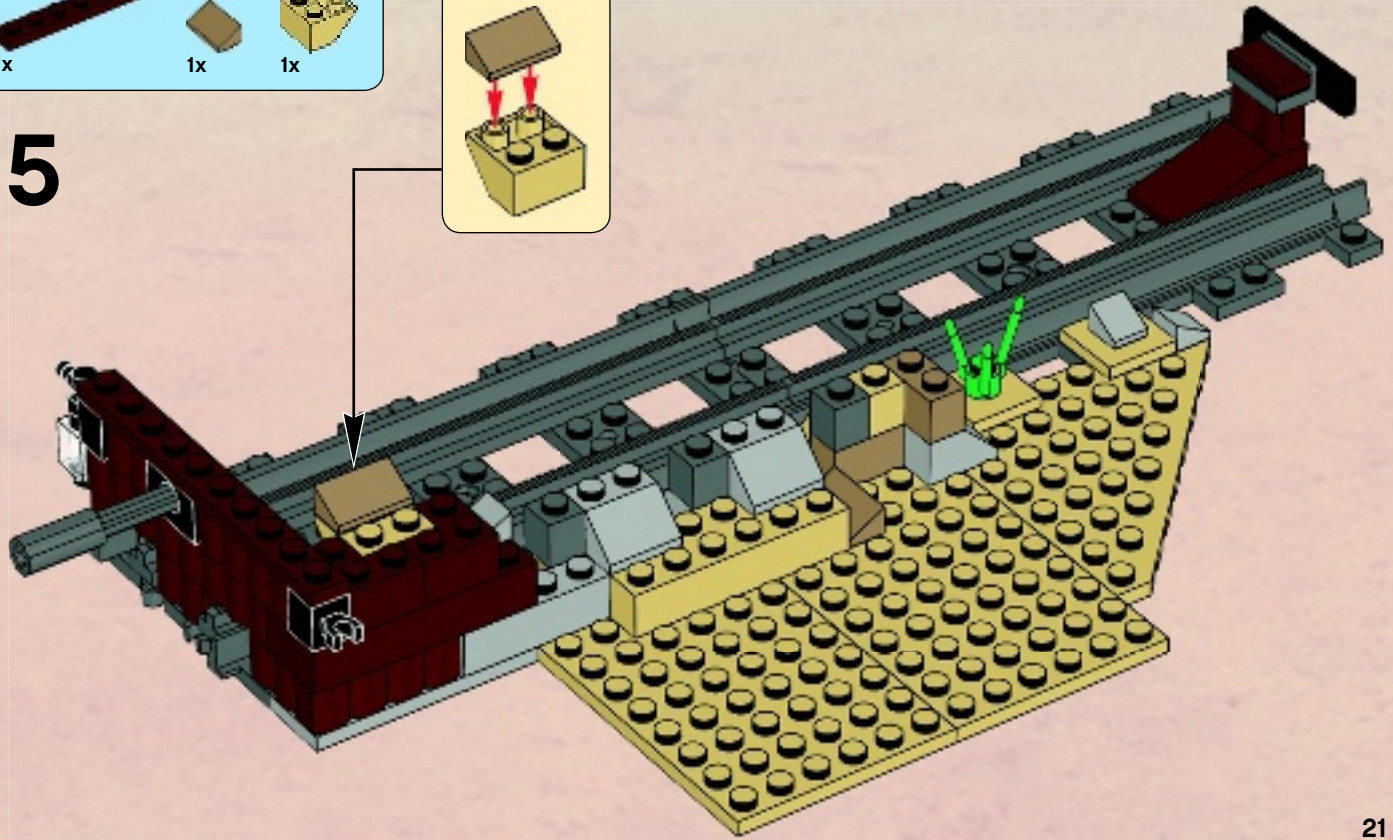

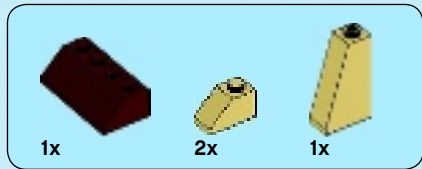

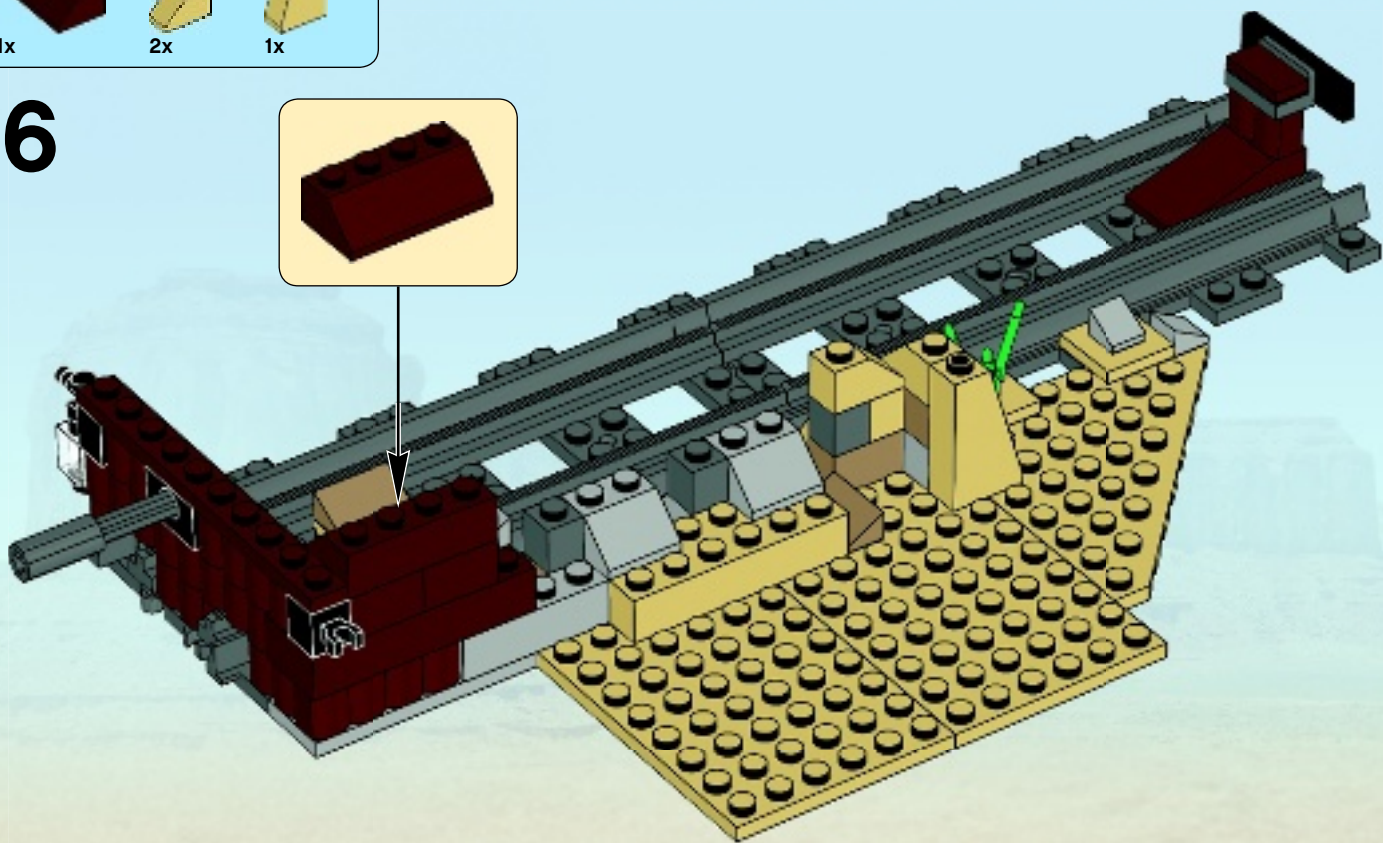
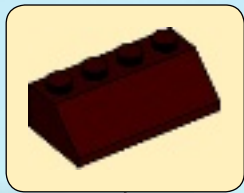

16

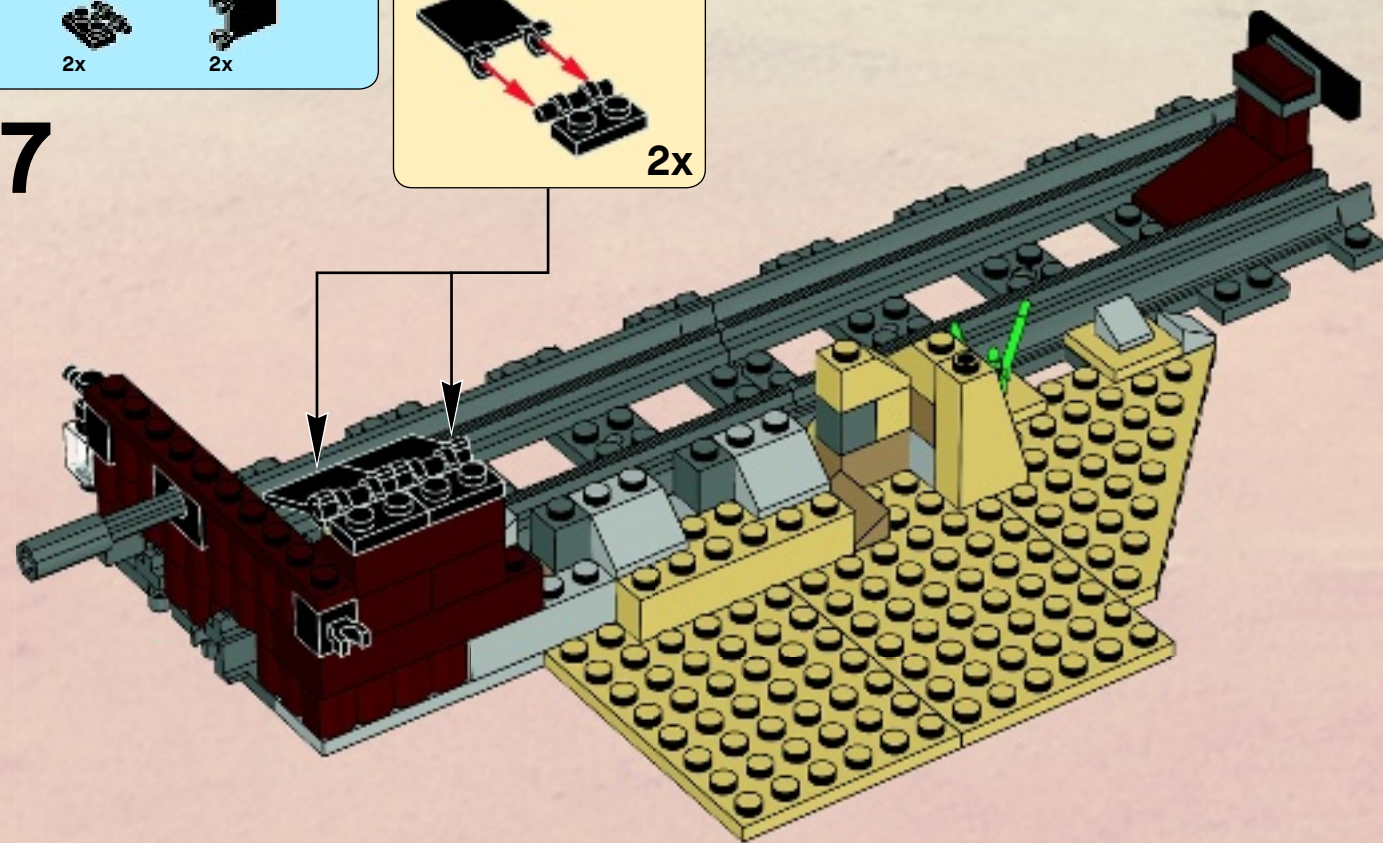
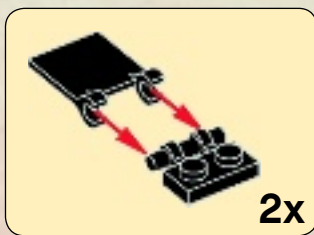

17



2x  2x 

# 18

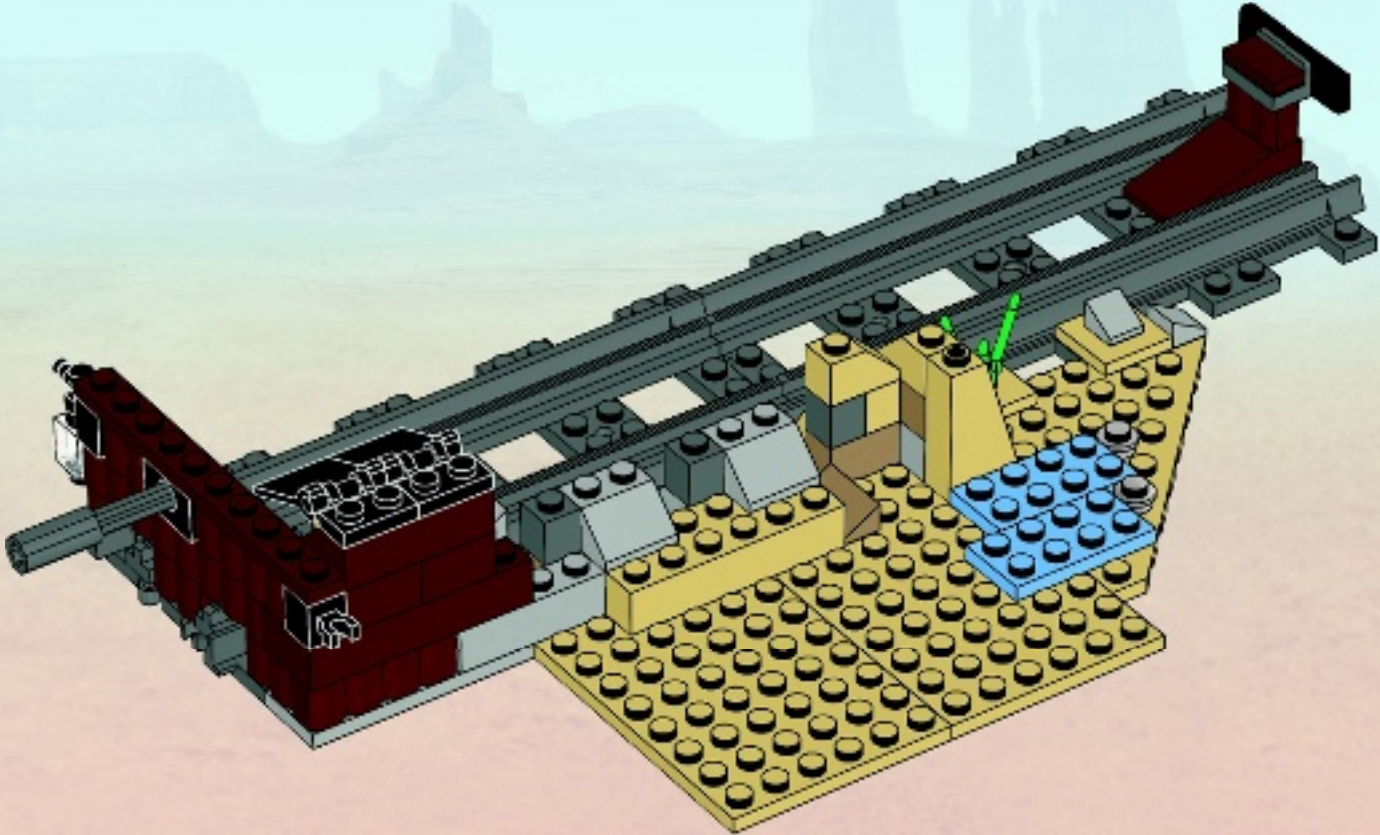



2x



1x

# 19

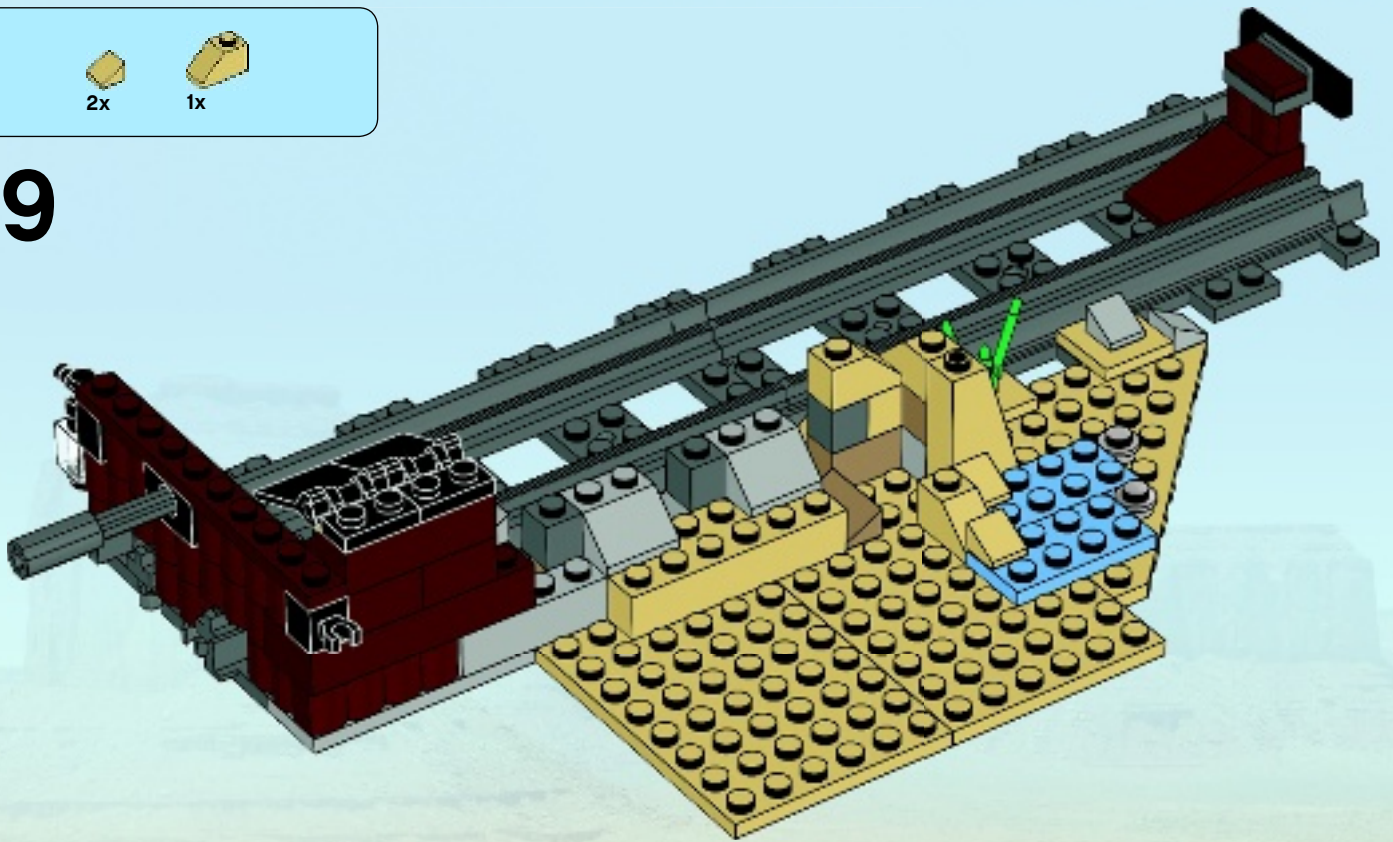

4x



1x



1x

# 20

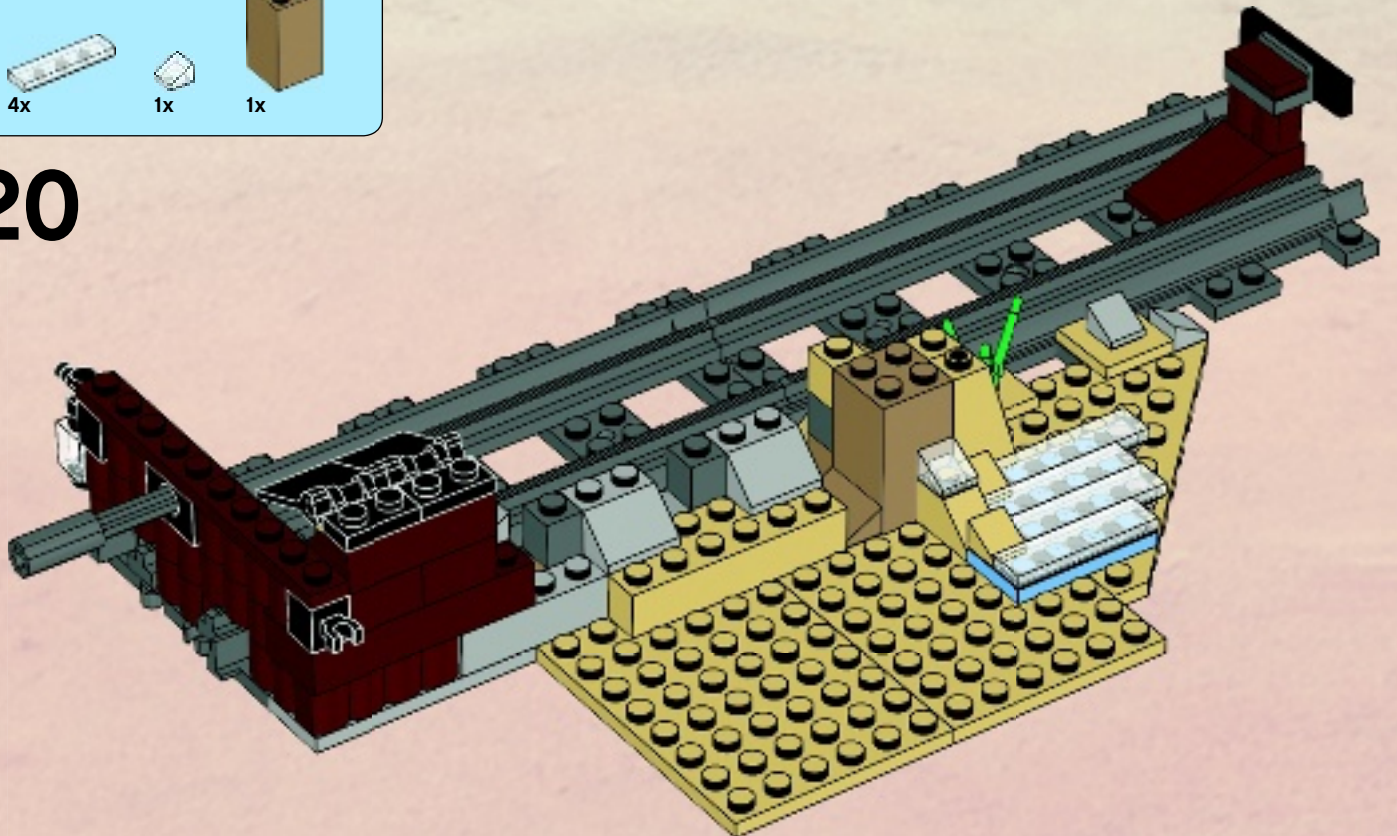



4x      2x      1x

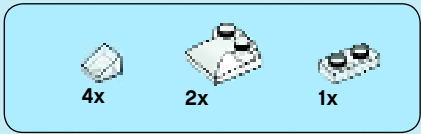

# 21

1      2      3      4

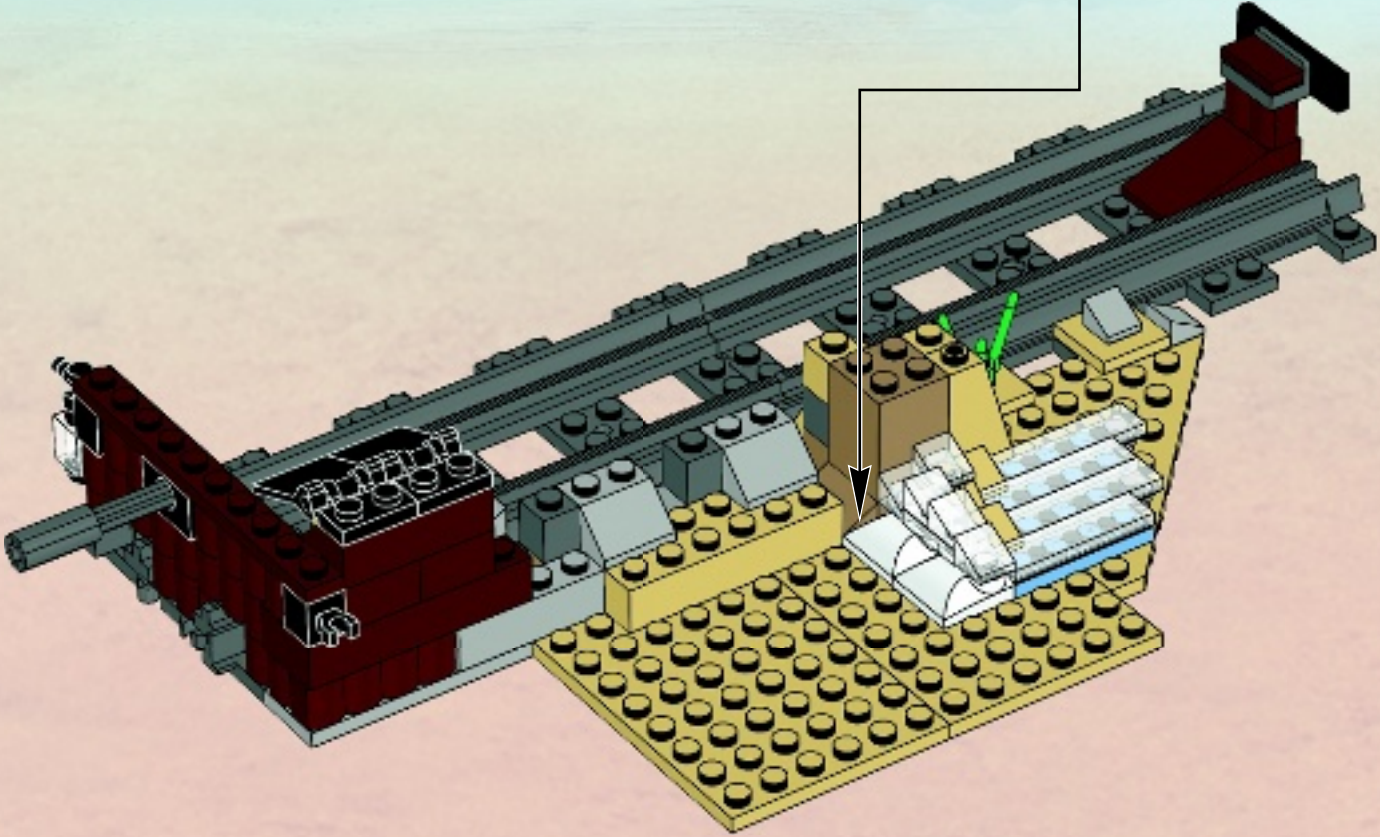
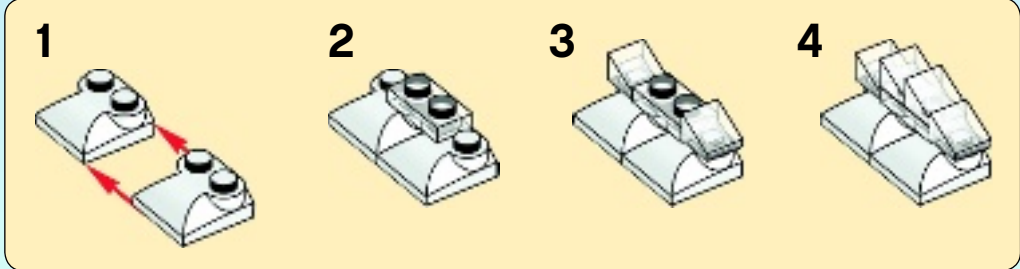



3x



2x



3x

# 22

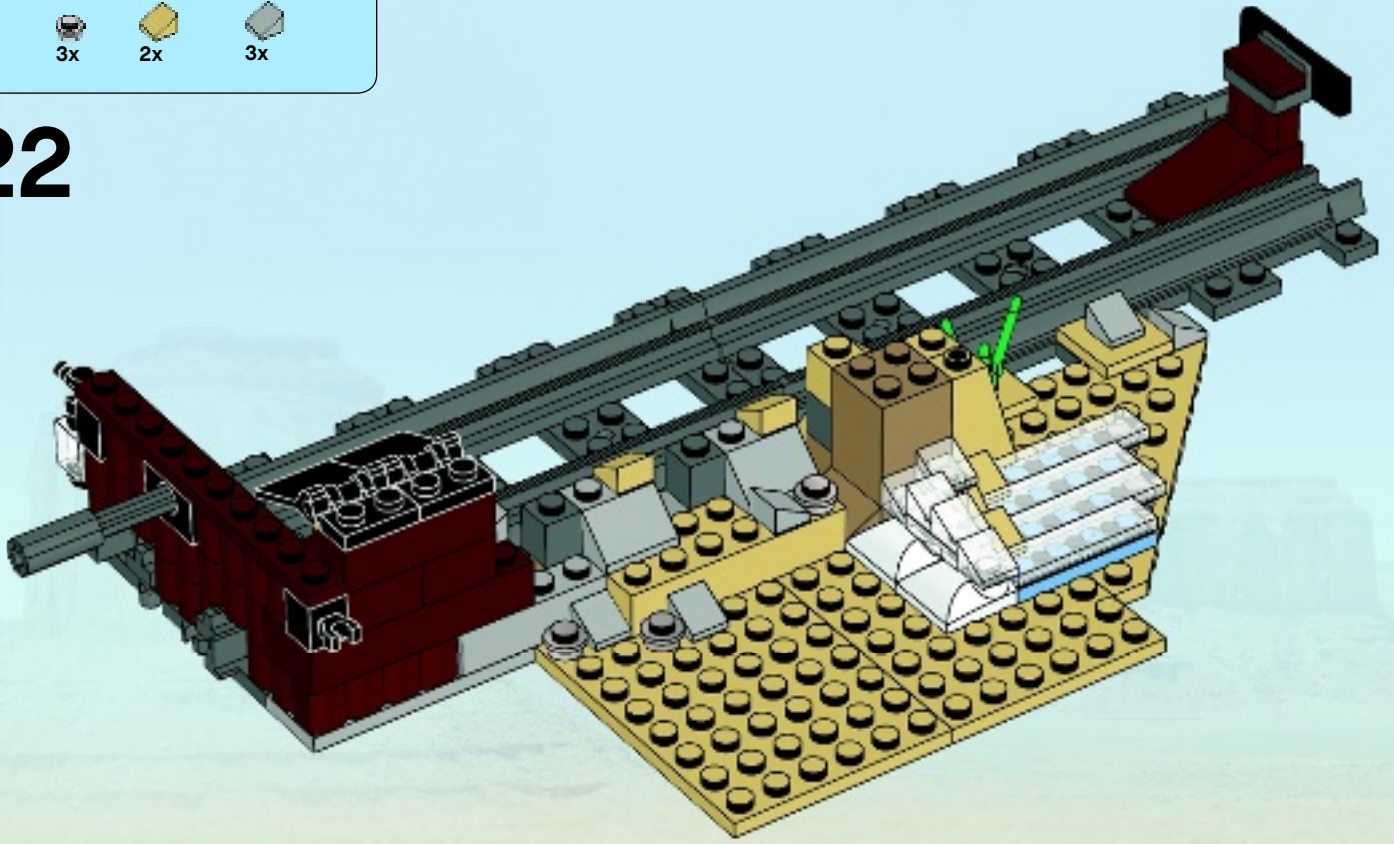

1x



1x



1x

# 23

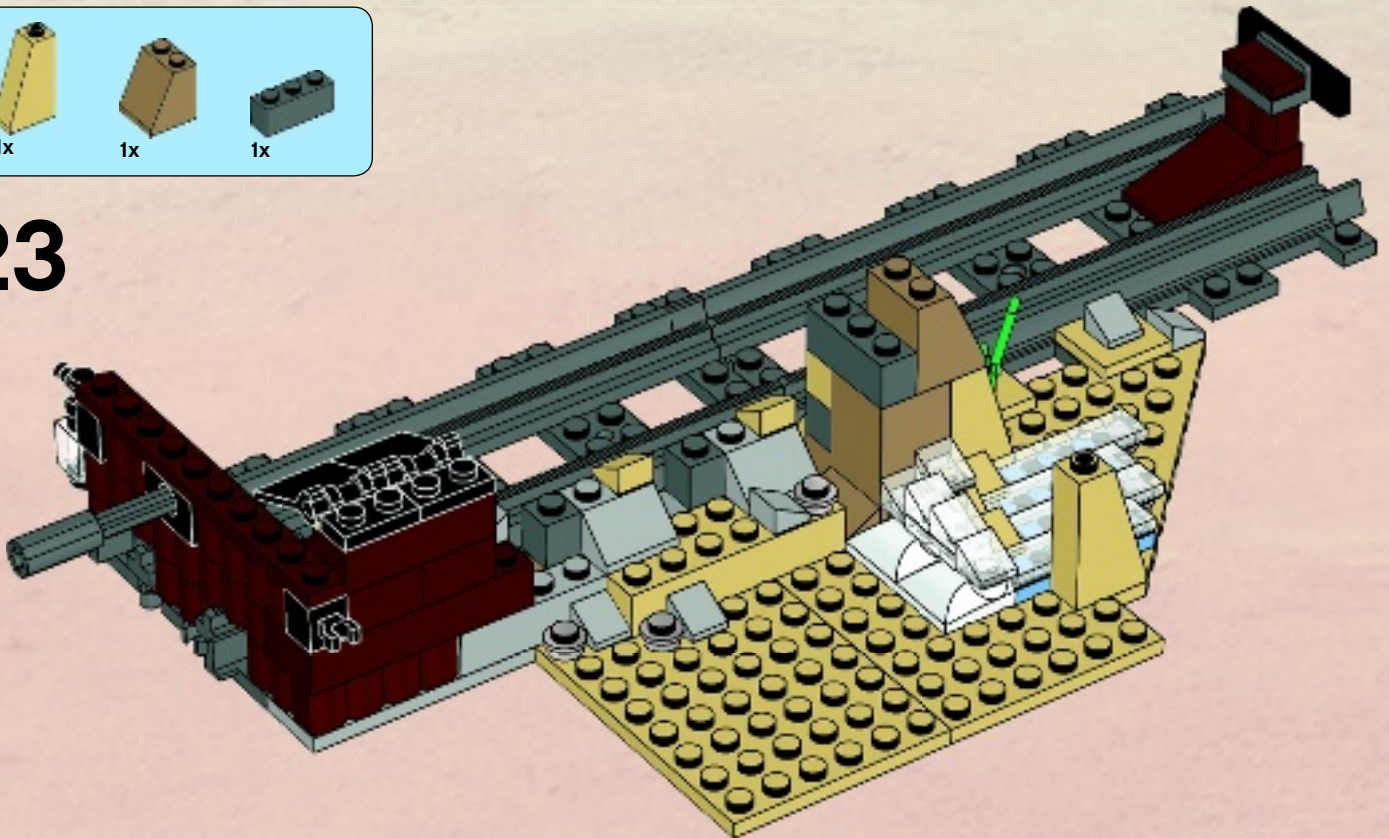

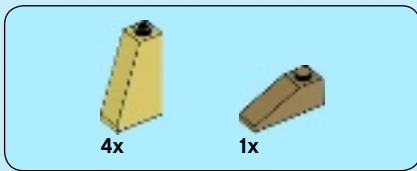

24

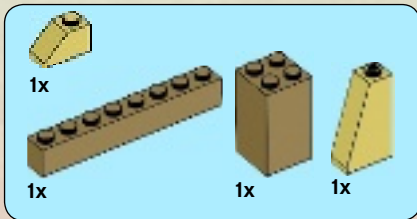
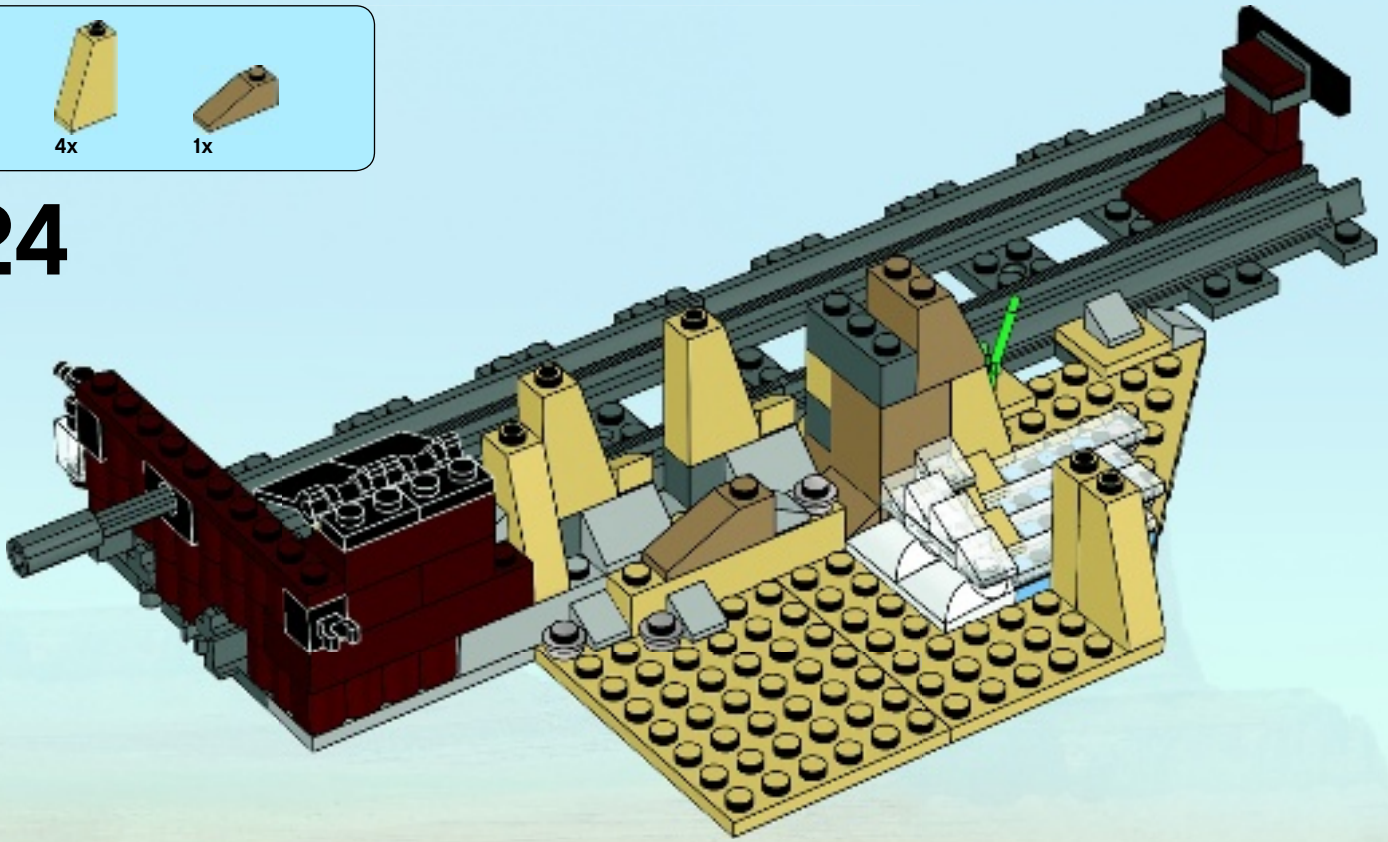

25

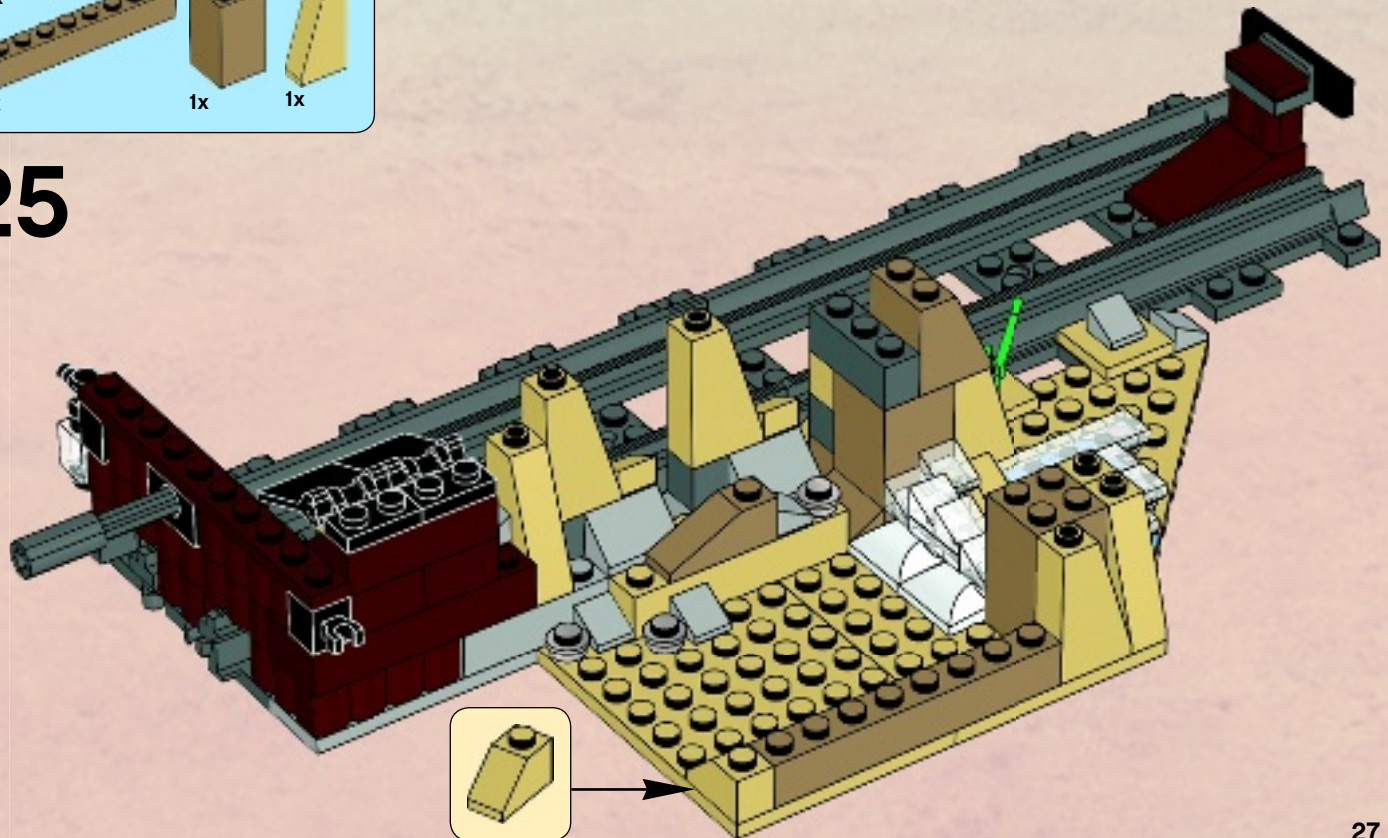

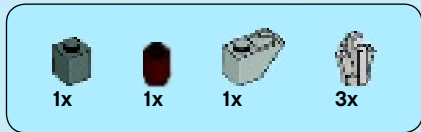

26

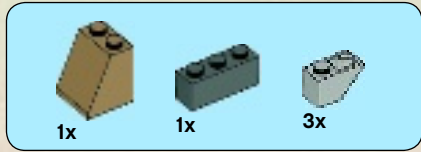
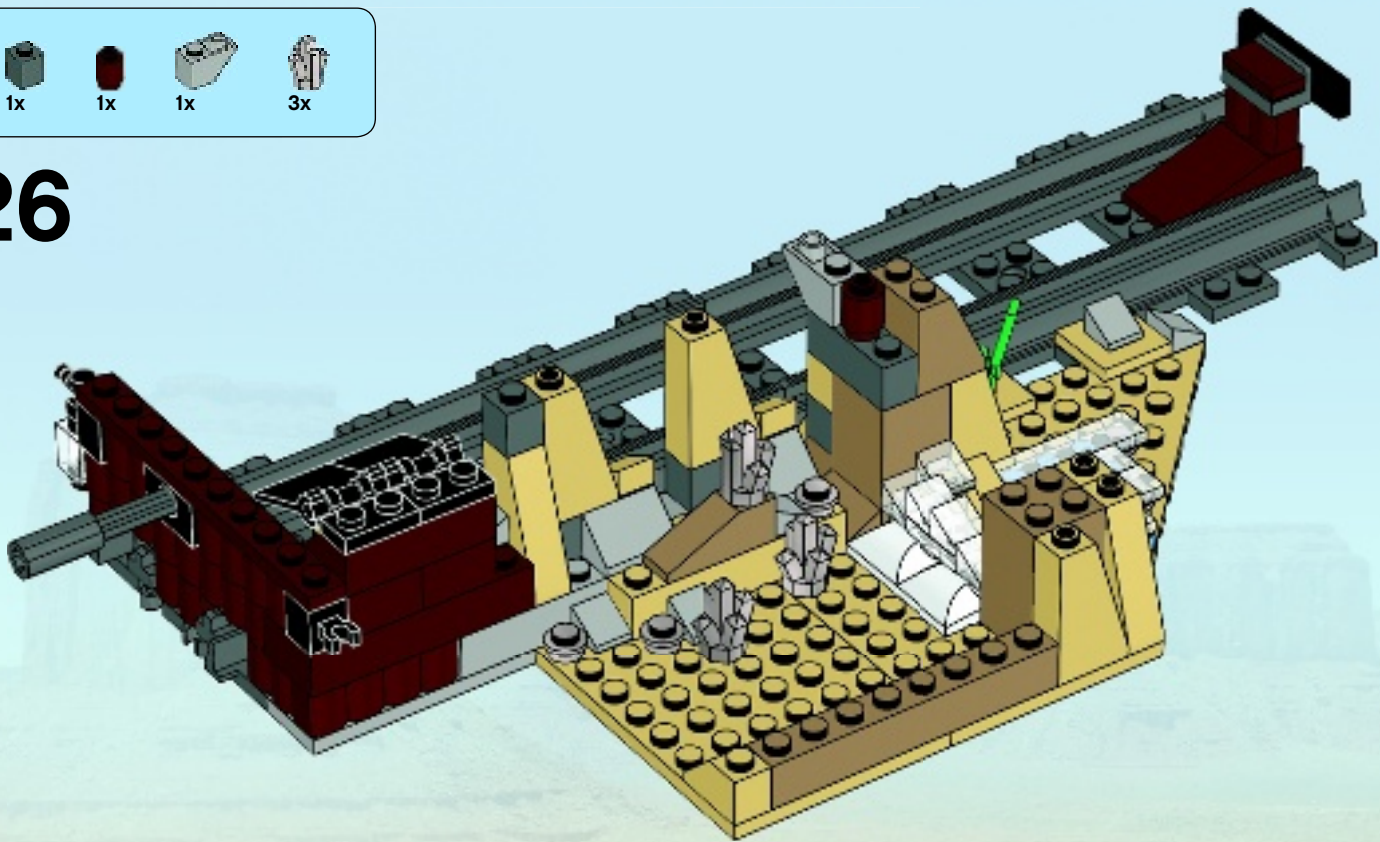

27

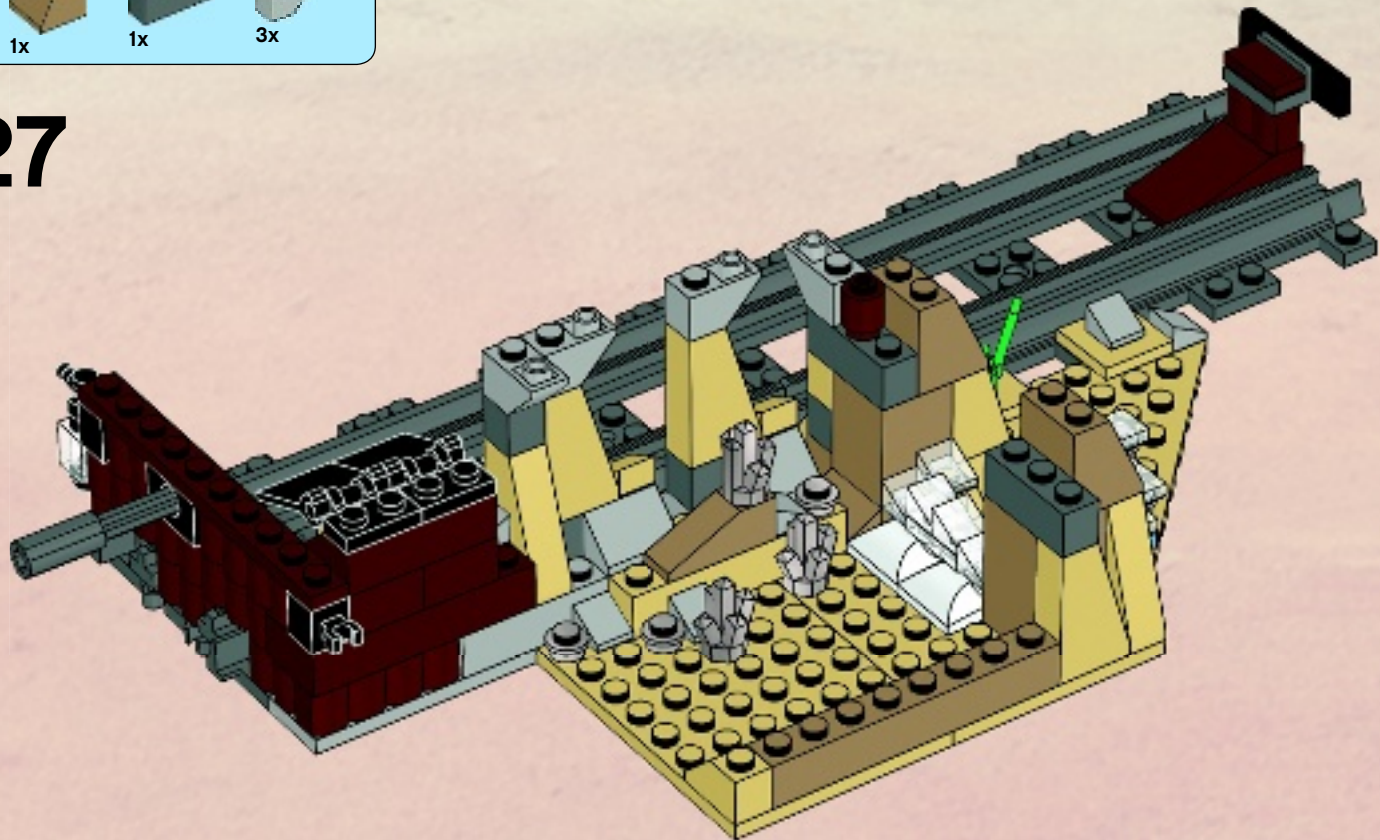

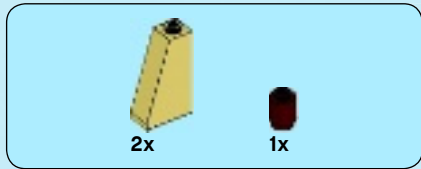

28

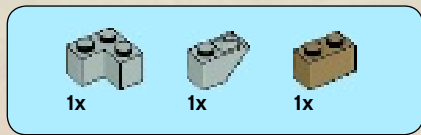
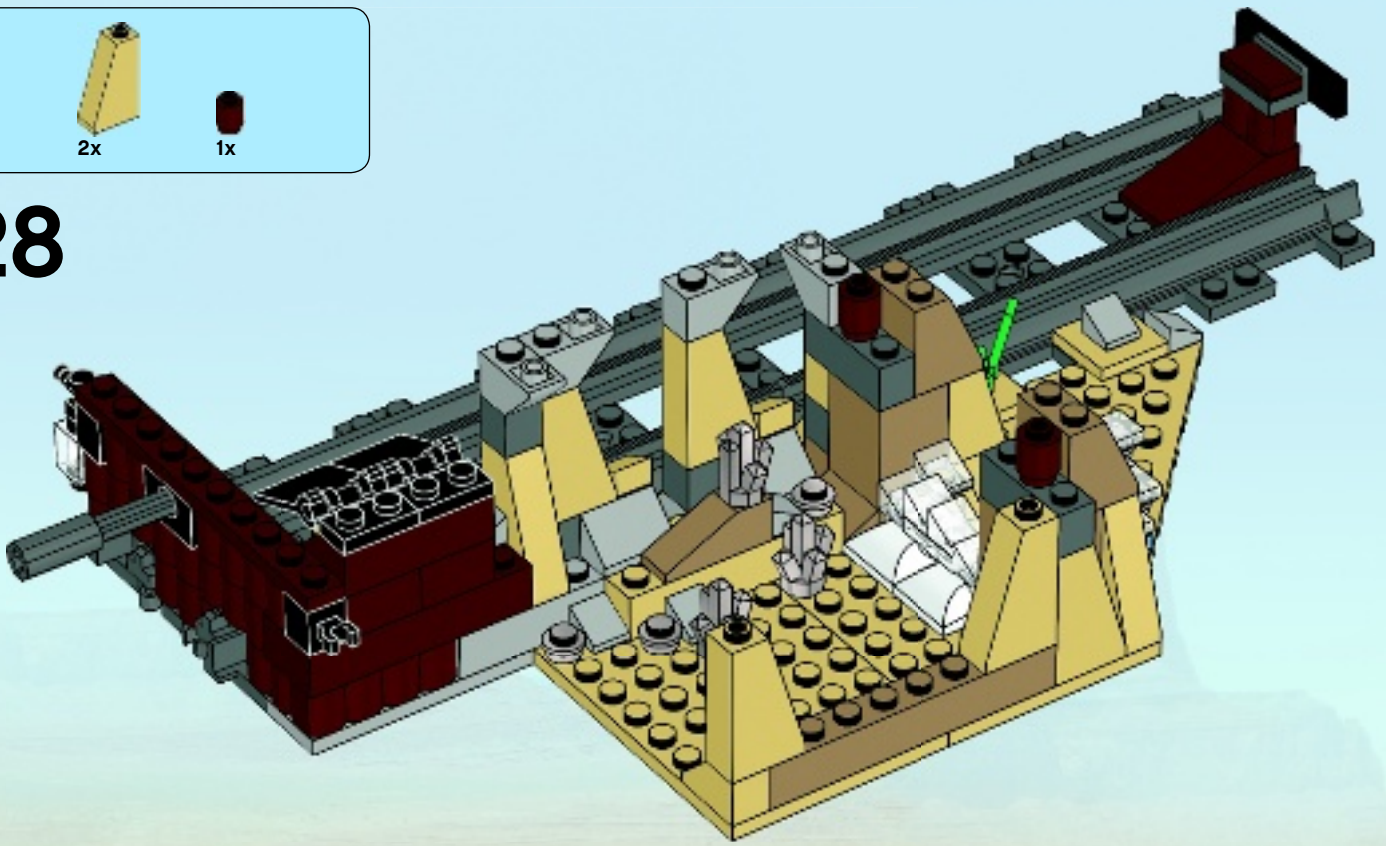

29

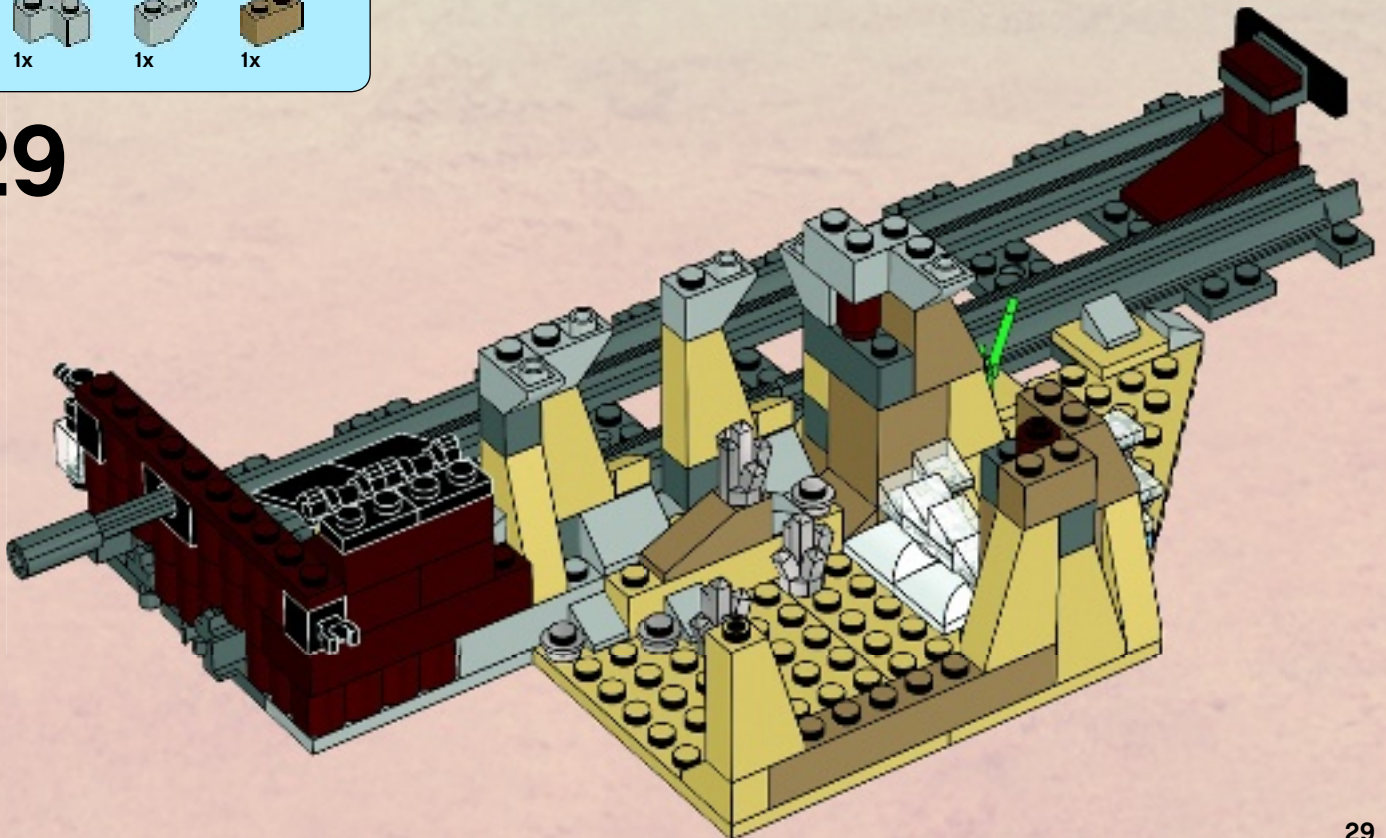

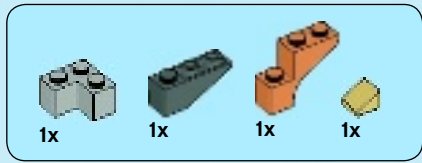

30

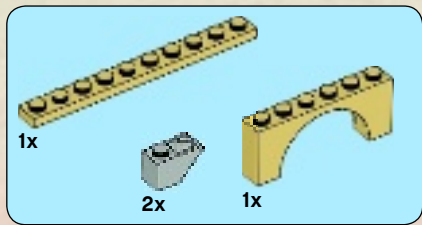
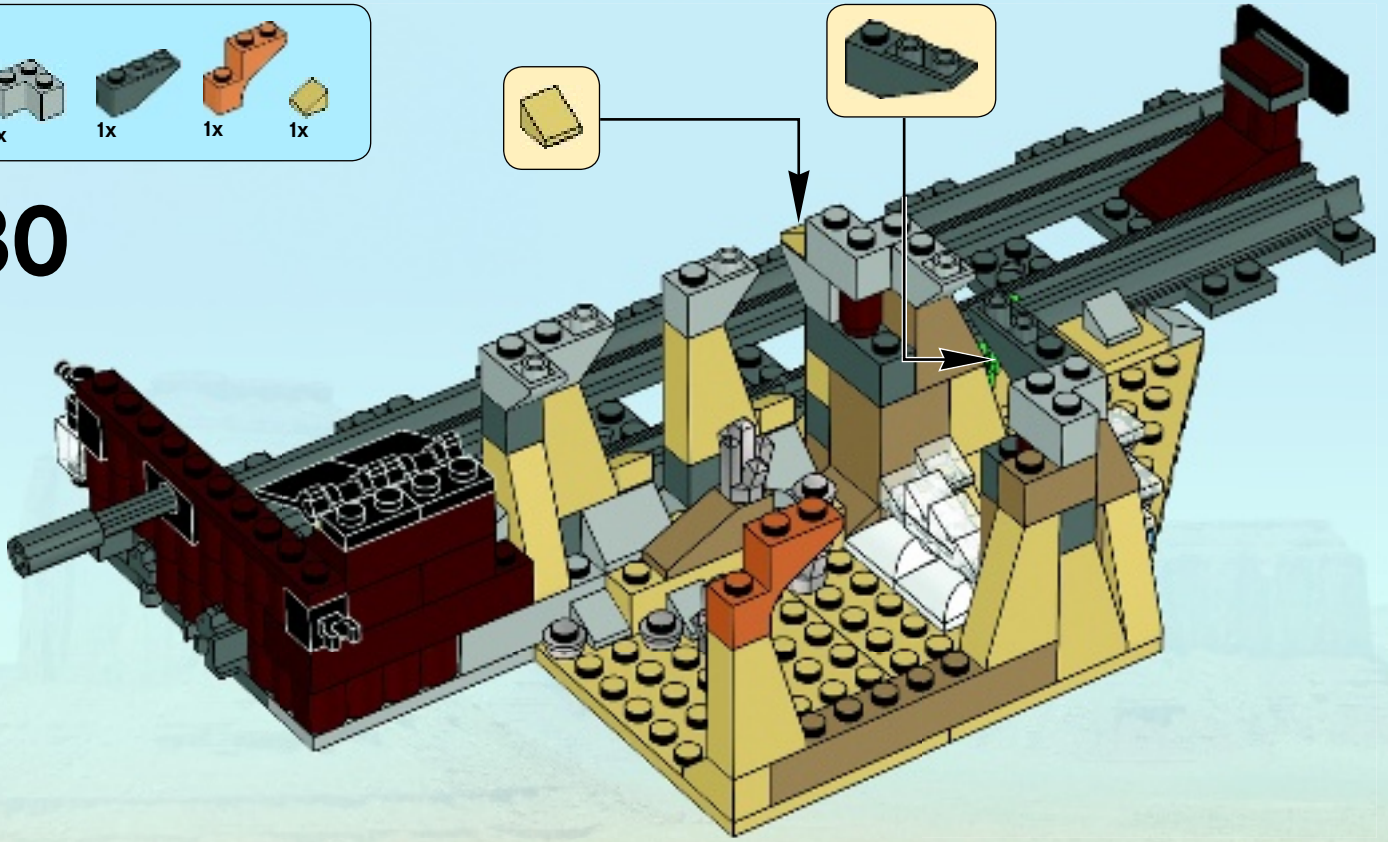

31

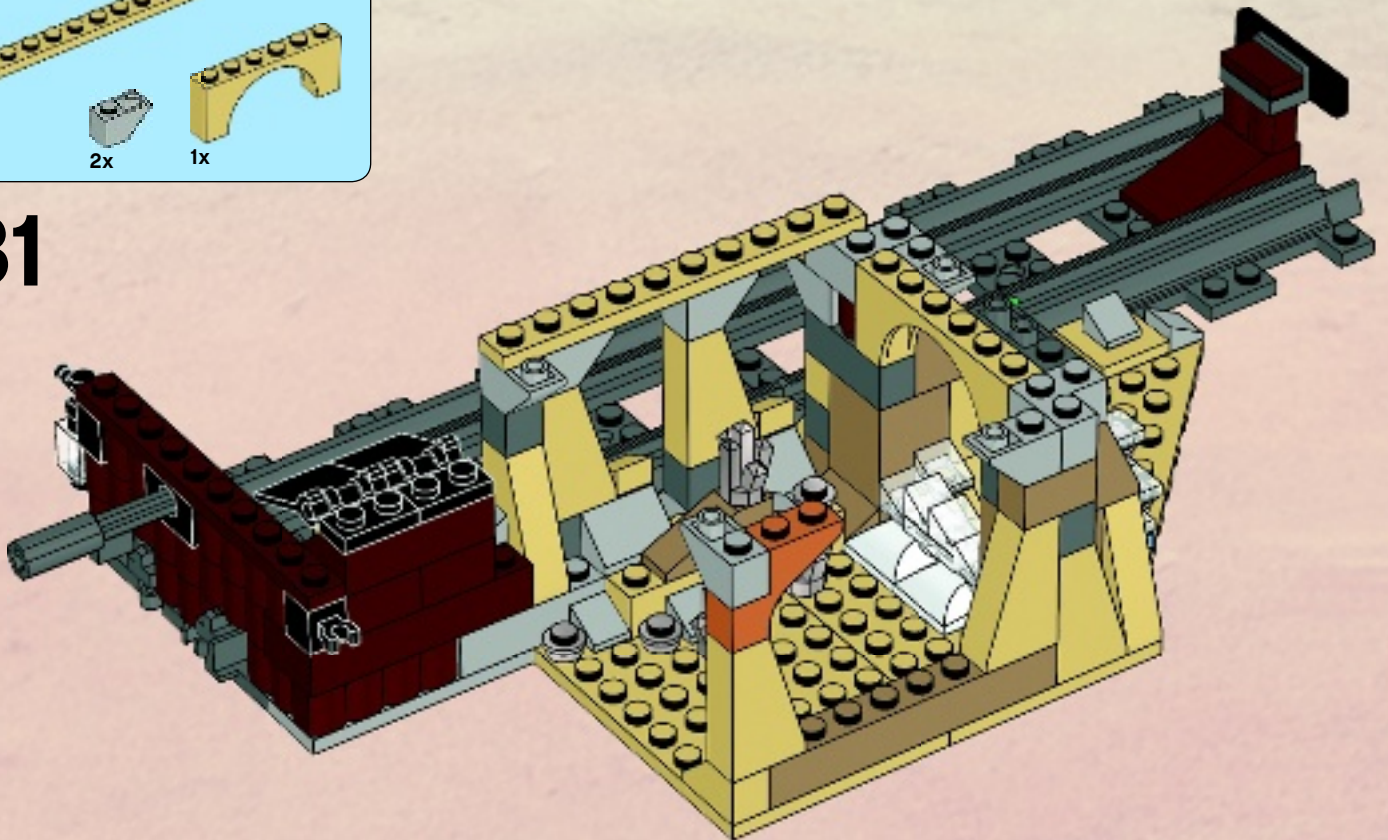

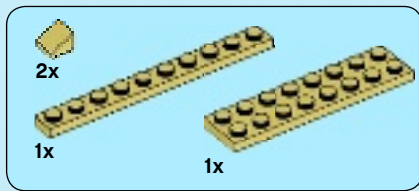

32

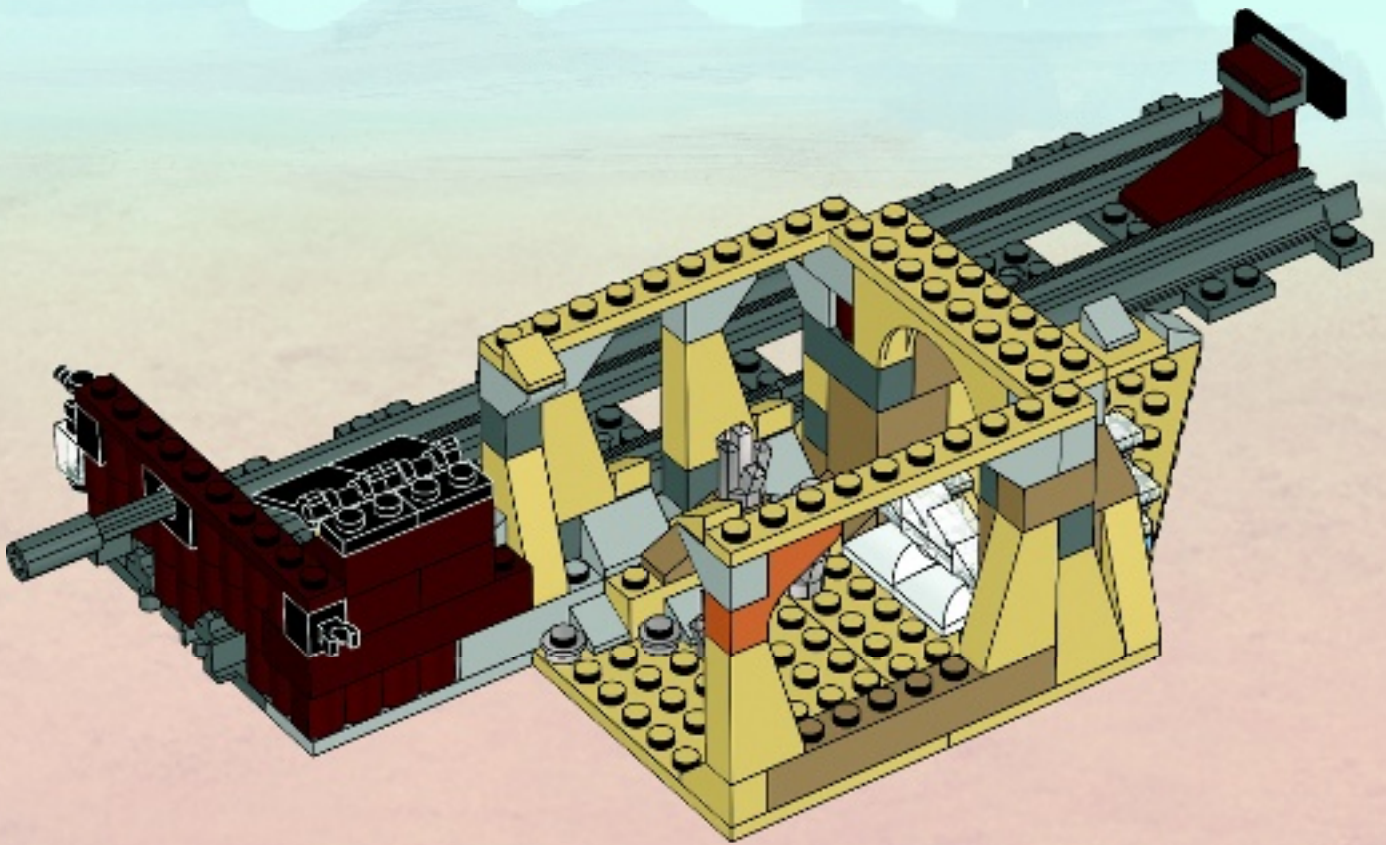

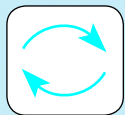

33

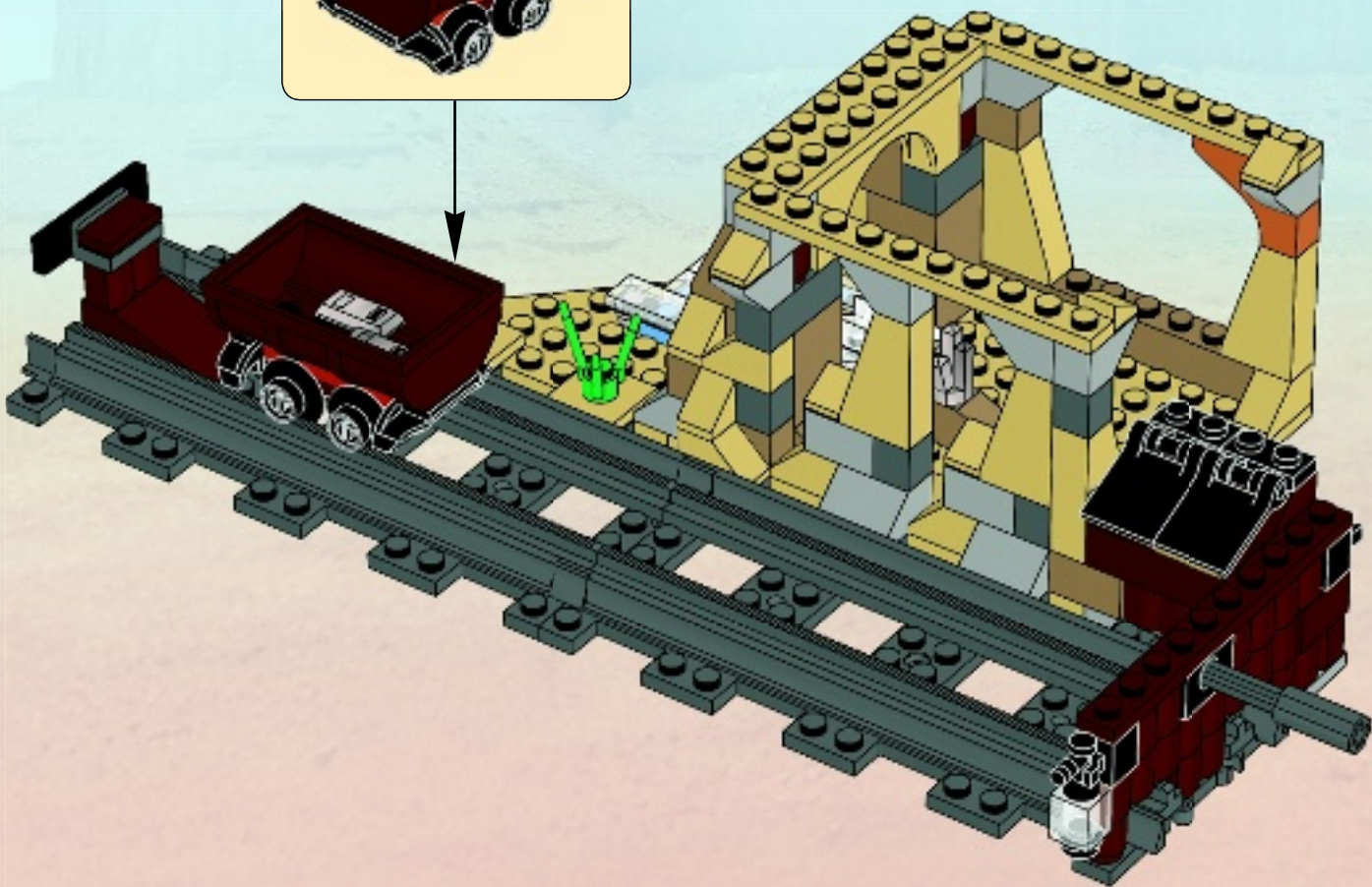



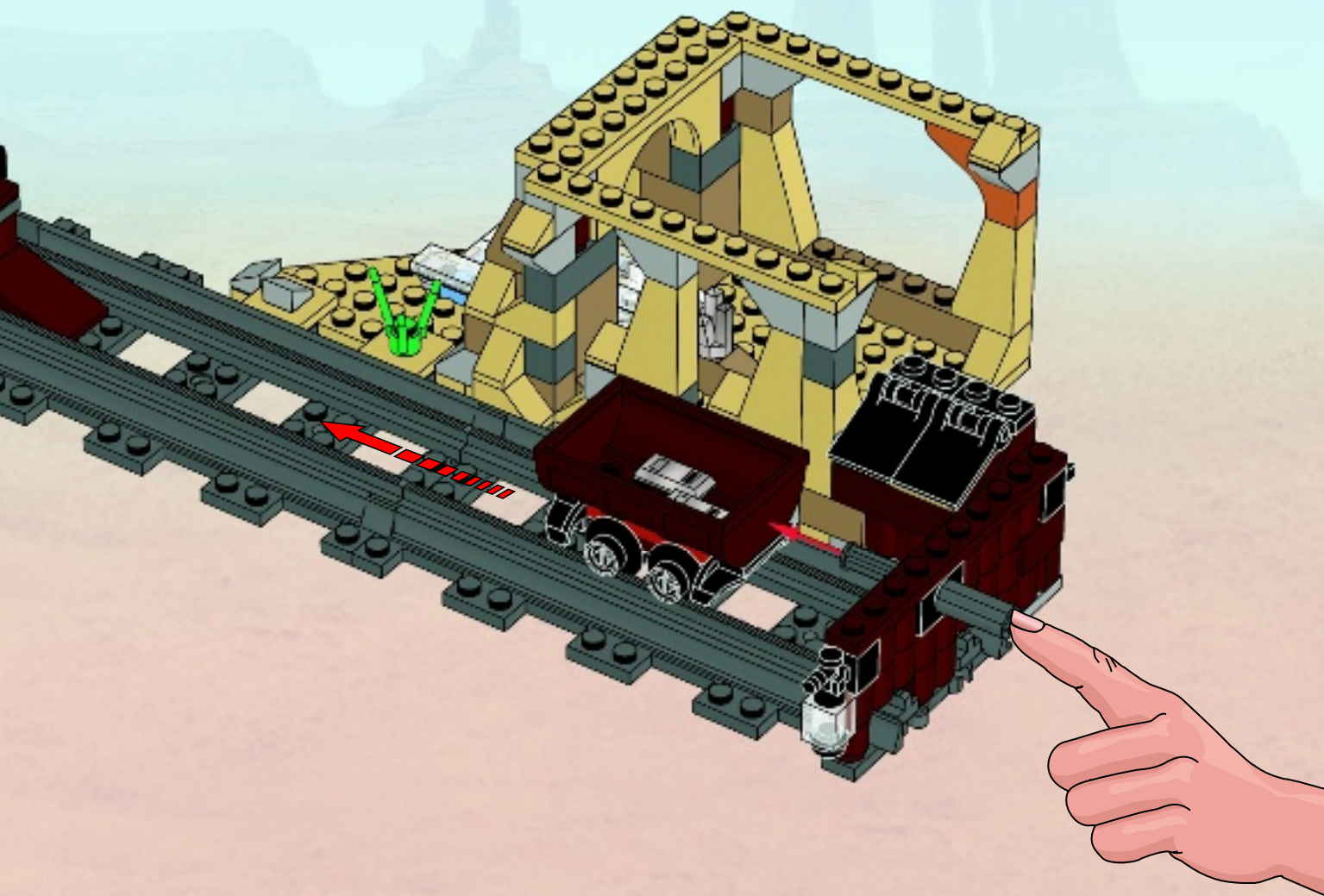

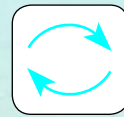
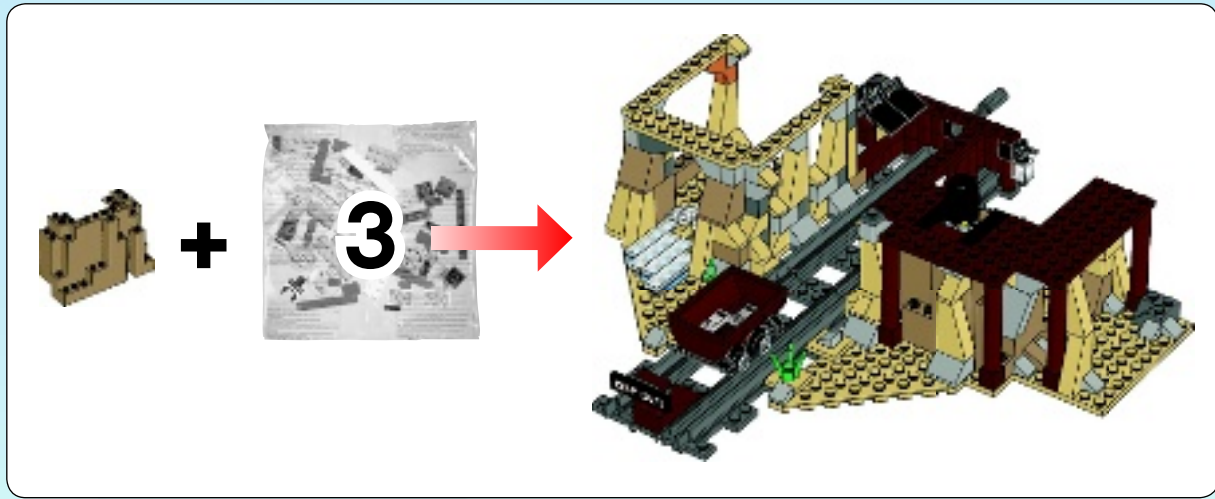

34

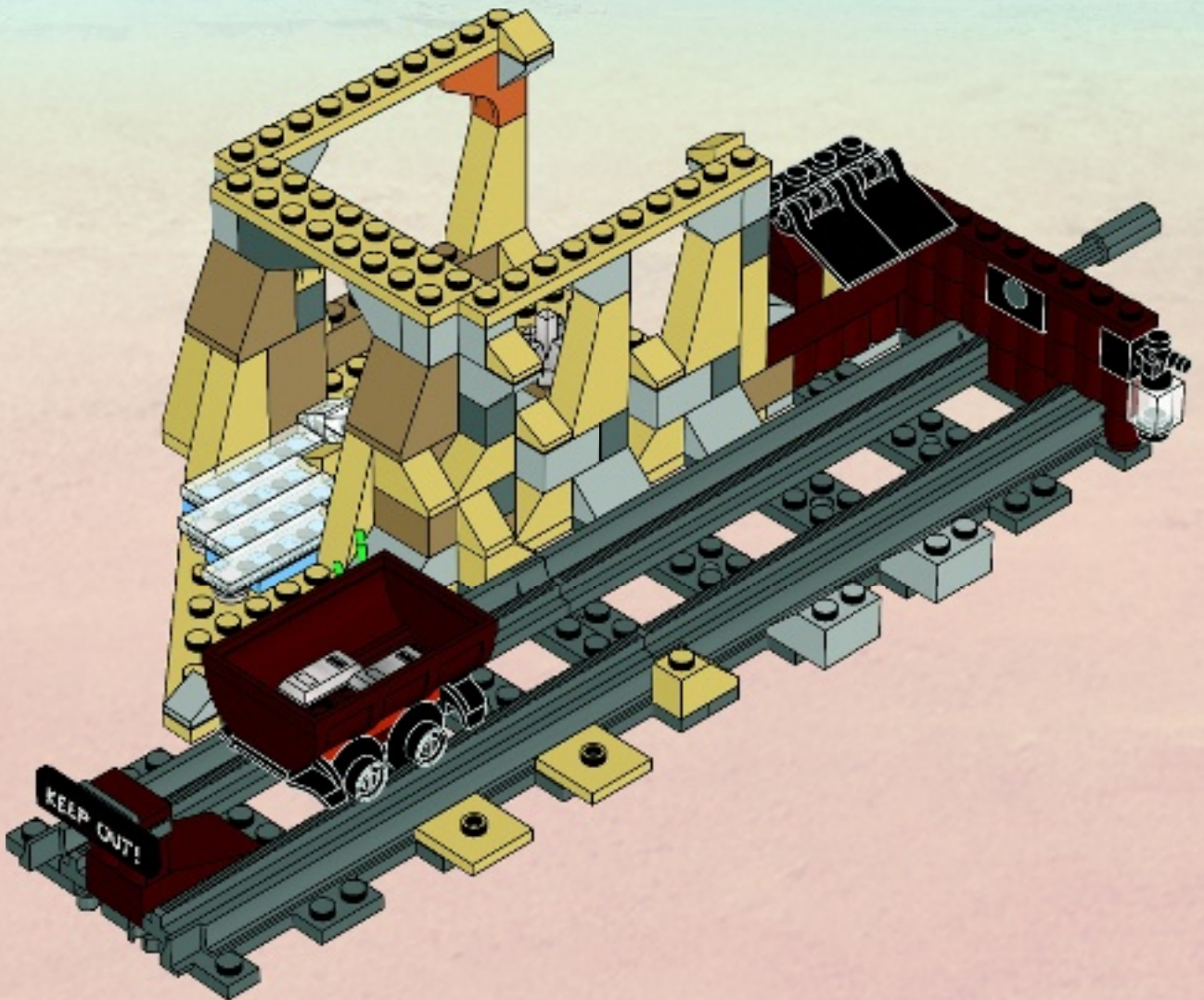

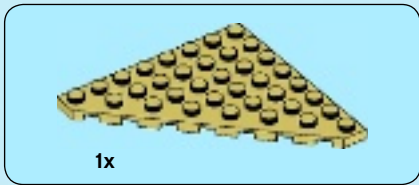

35

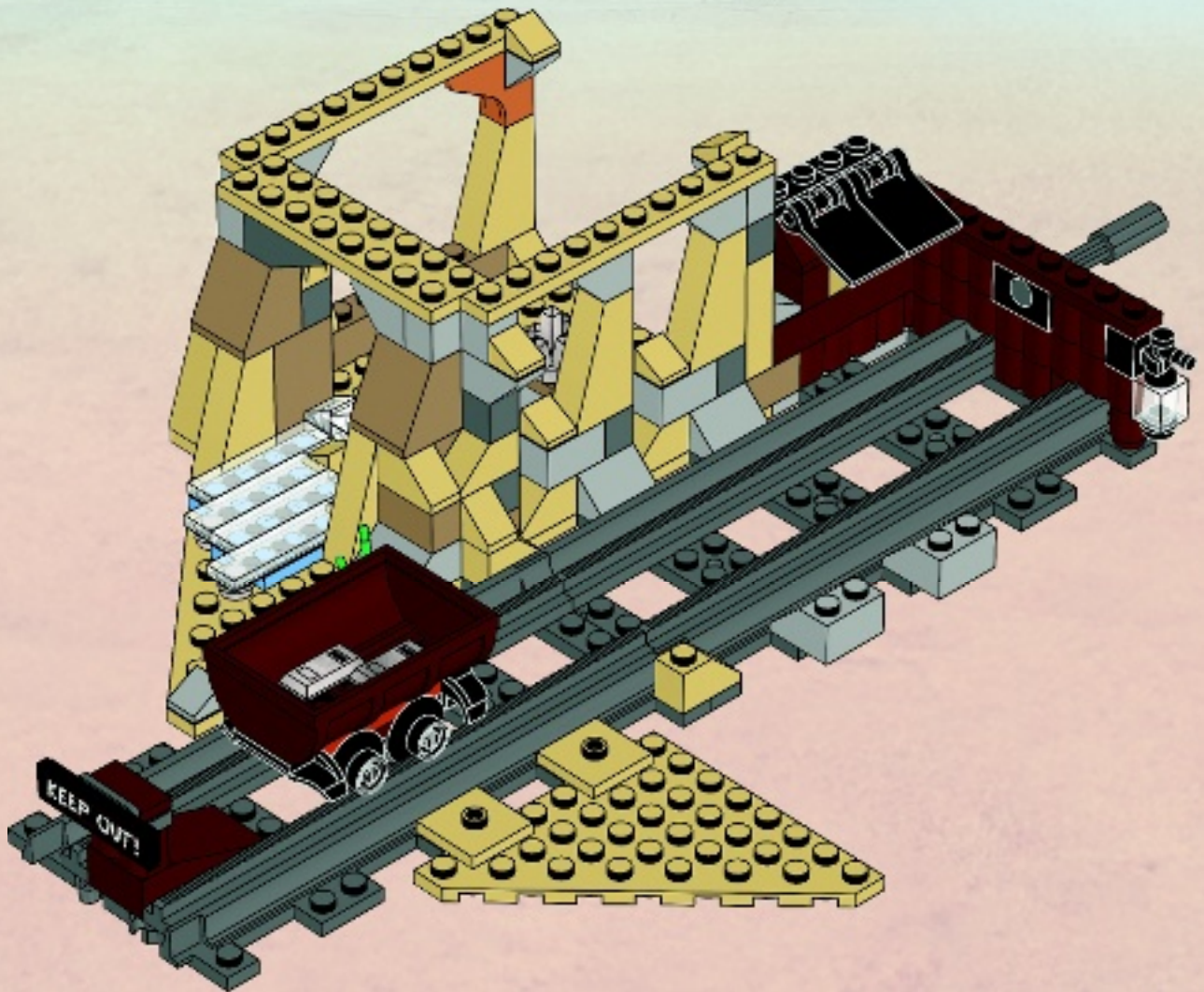

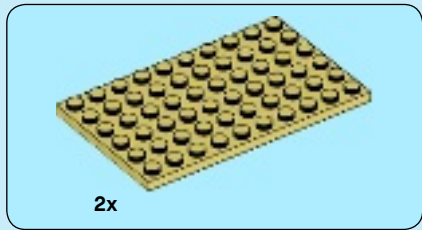

# 36

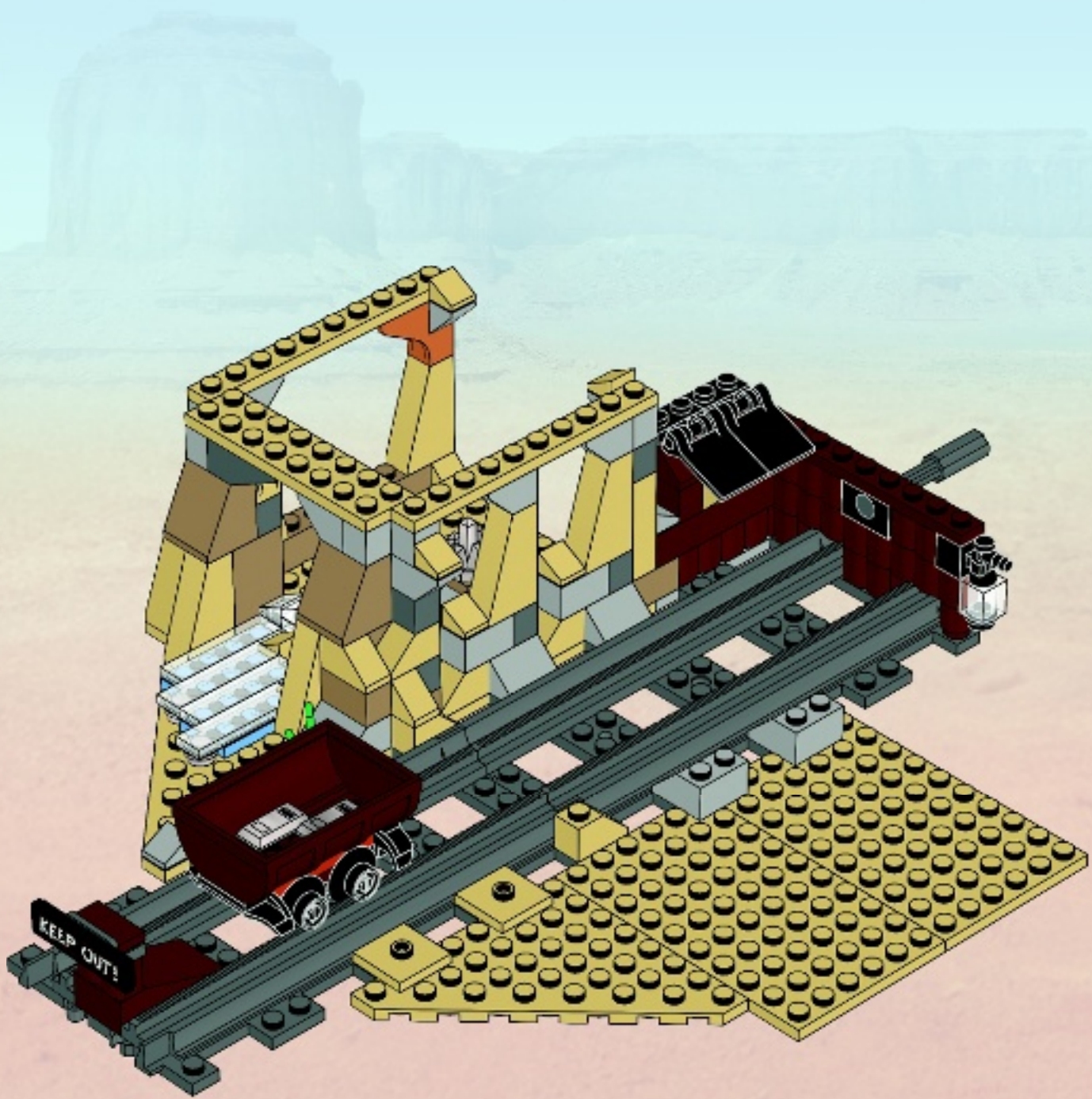

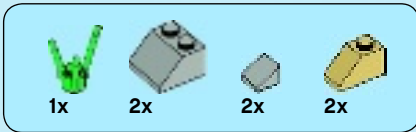

# 37

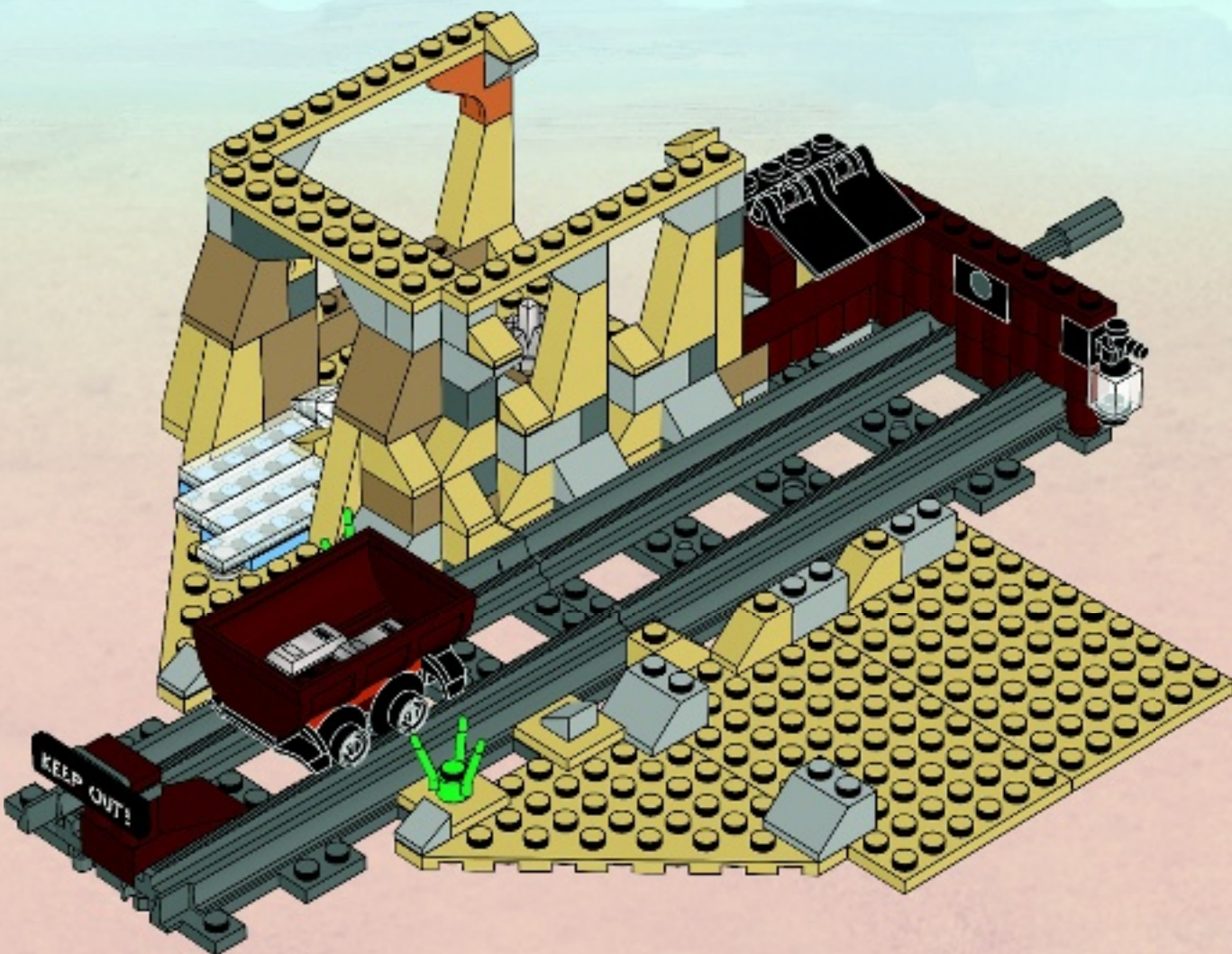



2x

# 38

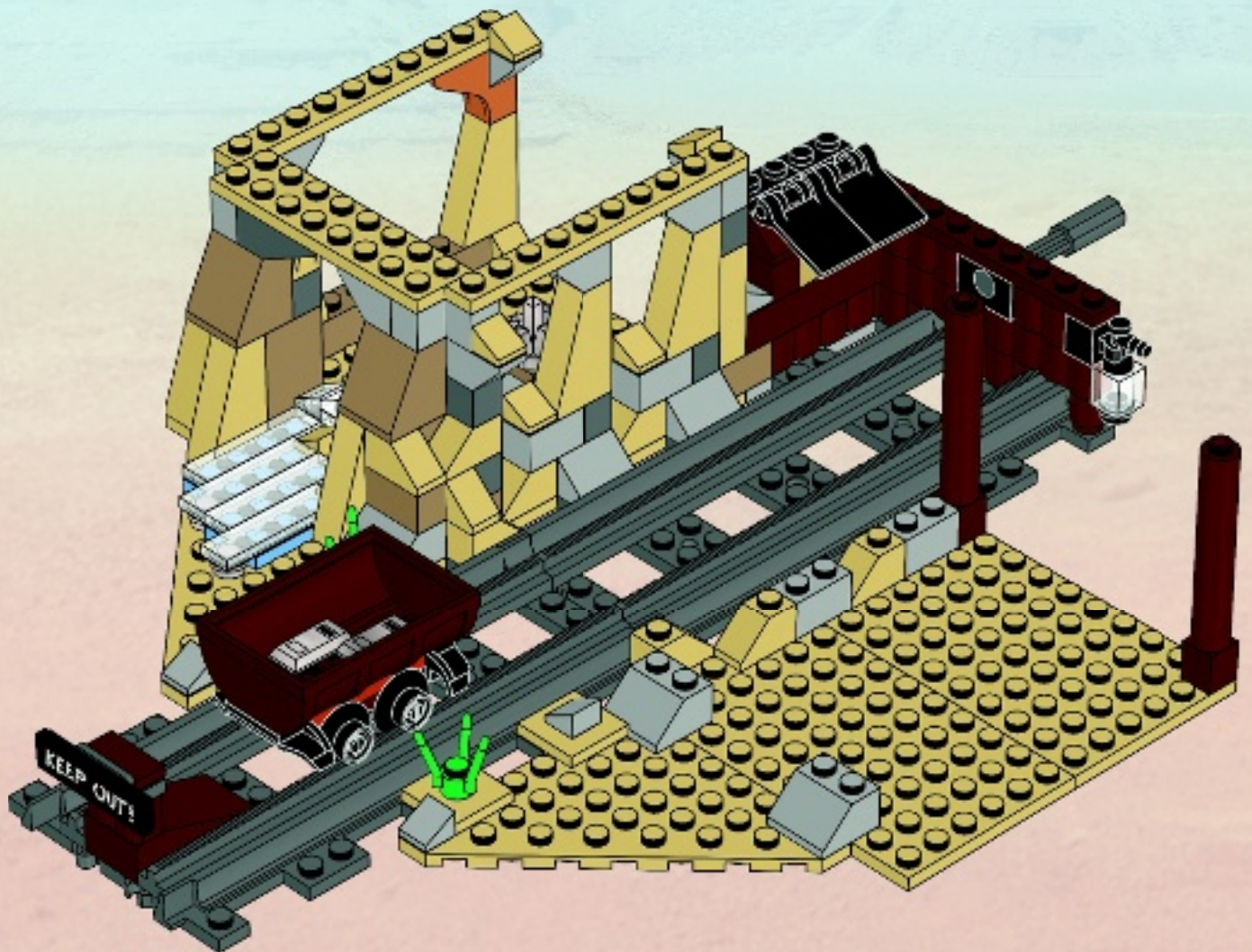

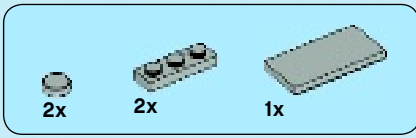

# 39

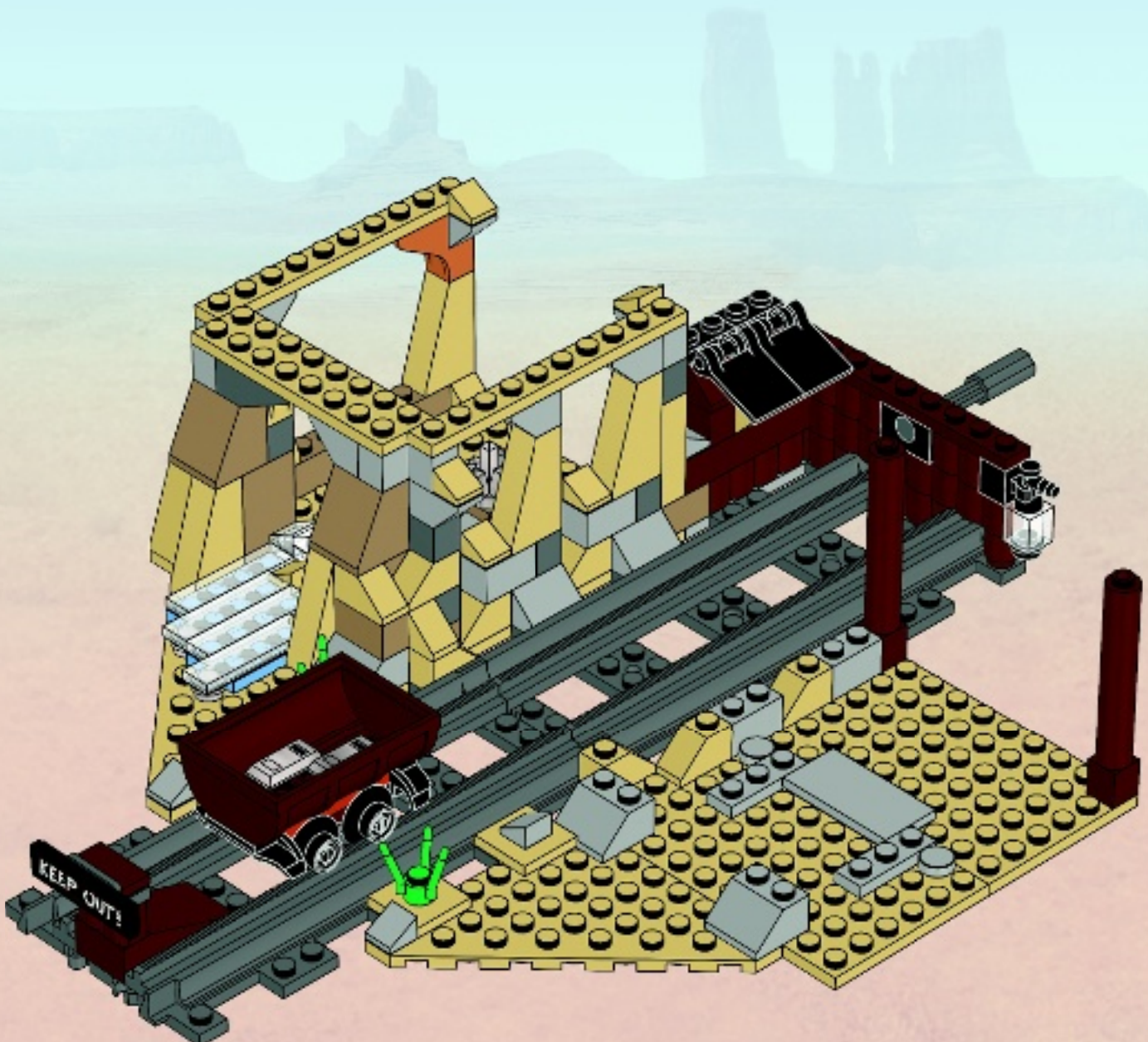

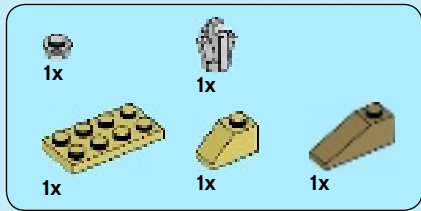

# 40

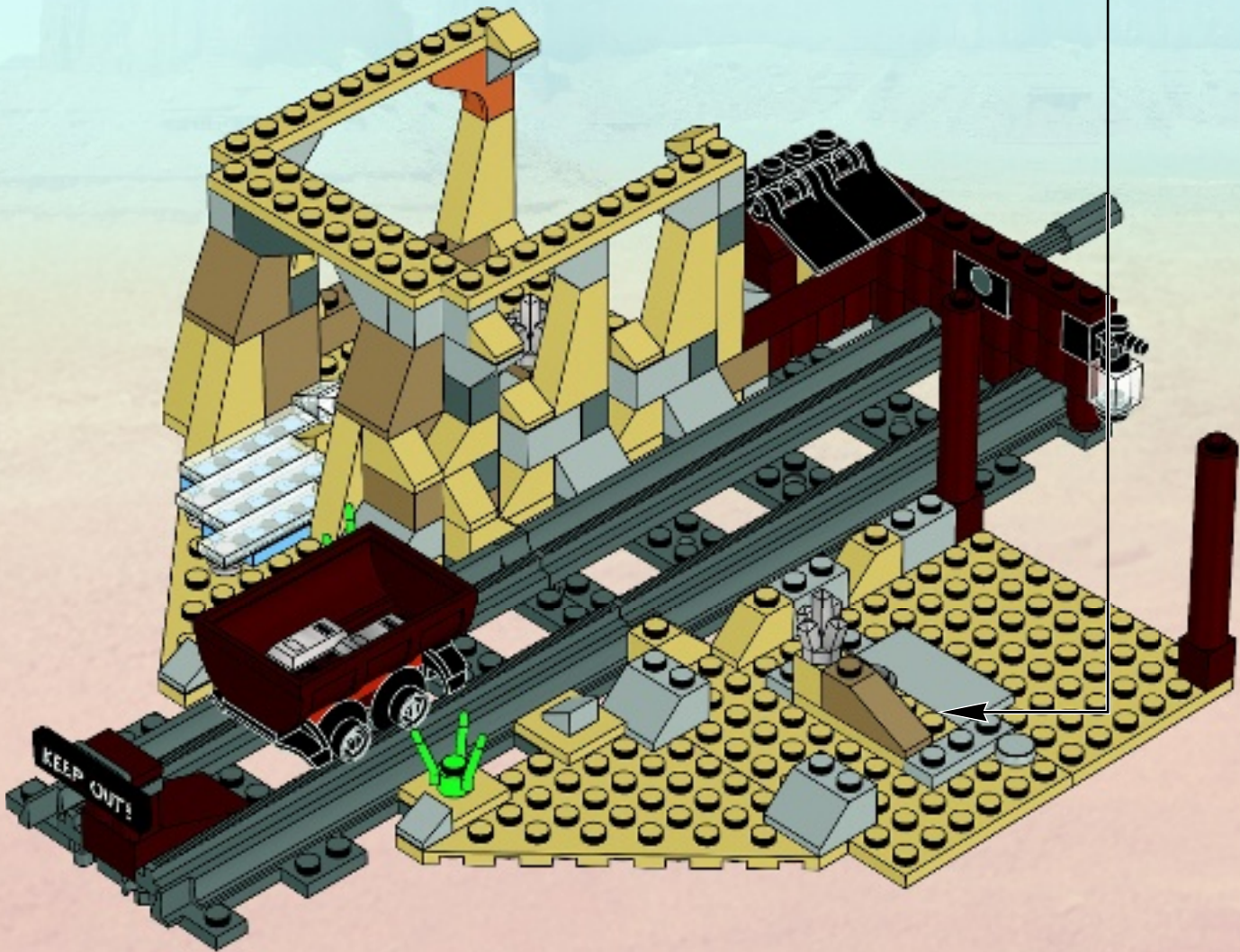
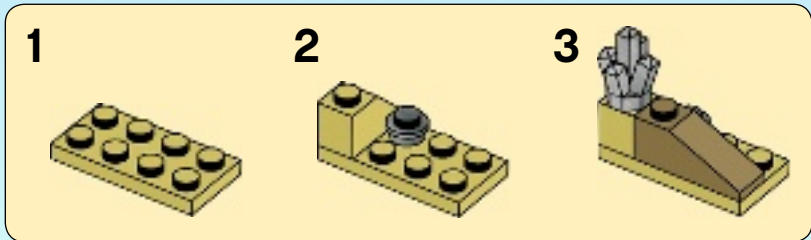





41

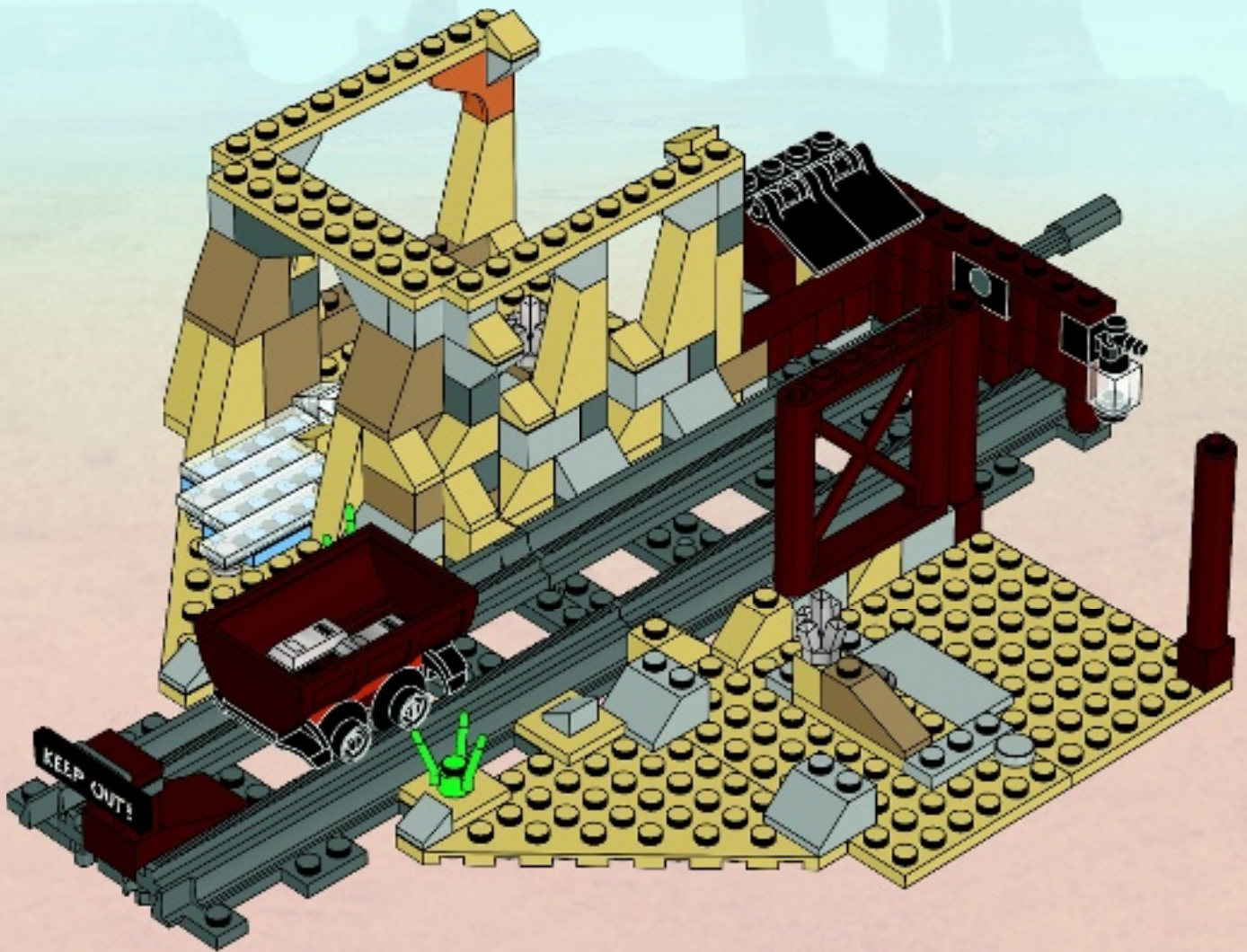

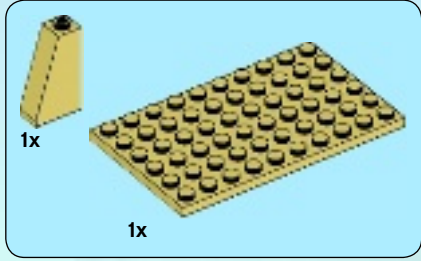
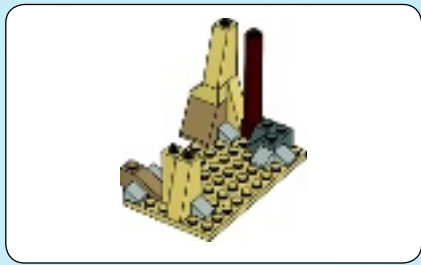

1

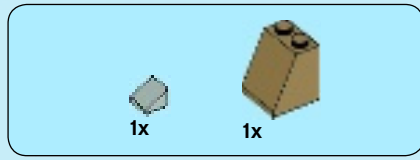
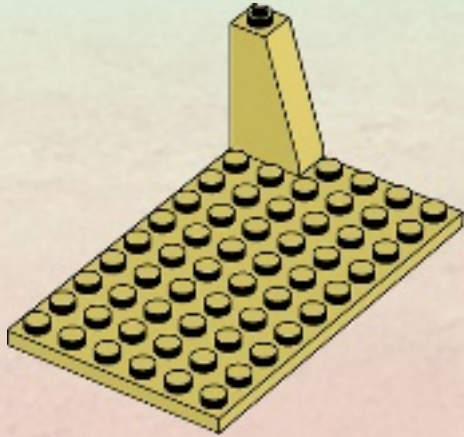

2

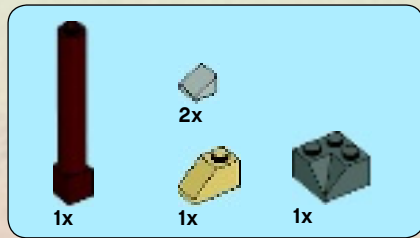
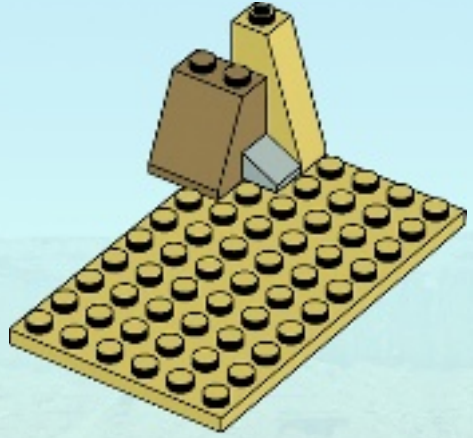

3

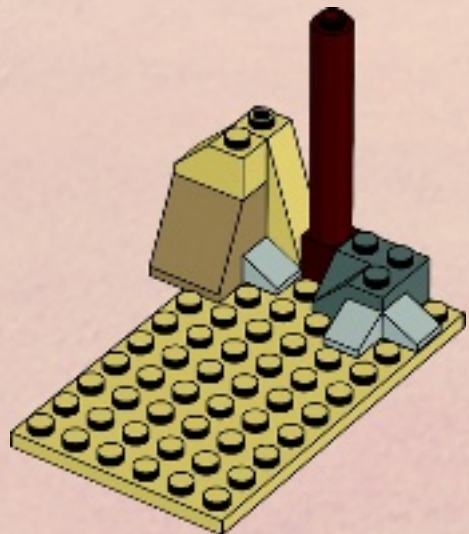

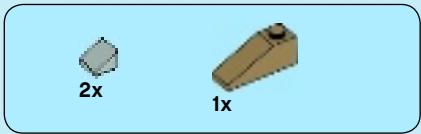

4

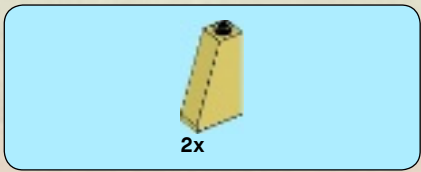
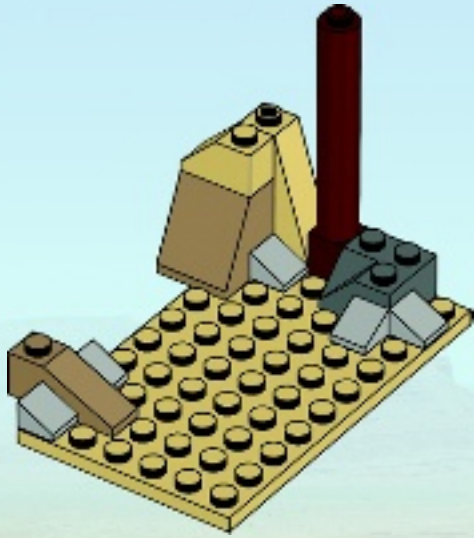

5

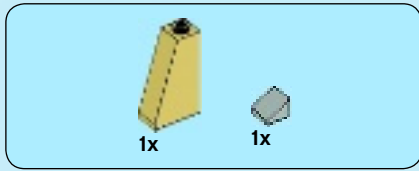
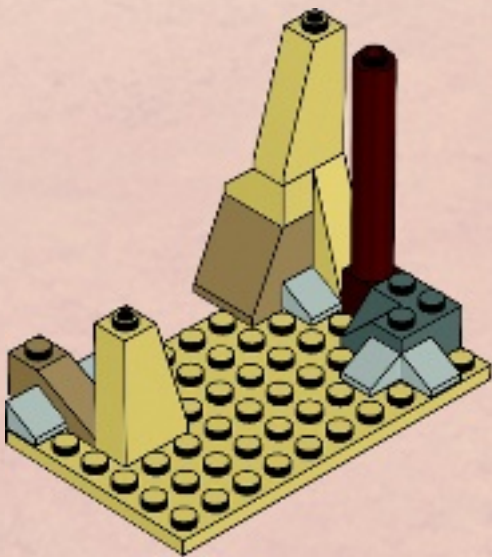

6

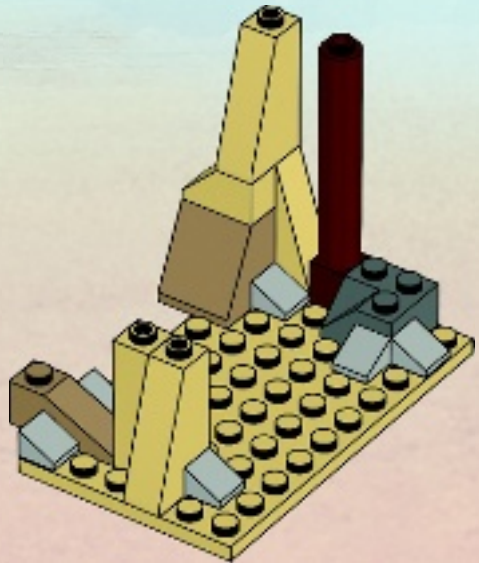

42

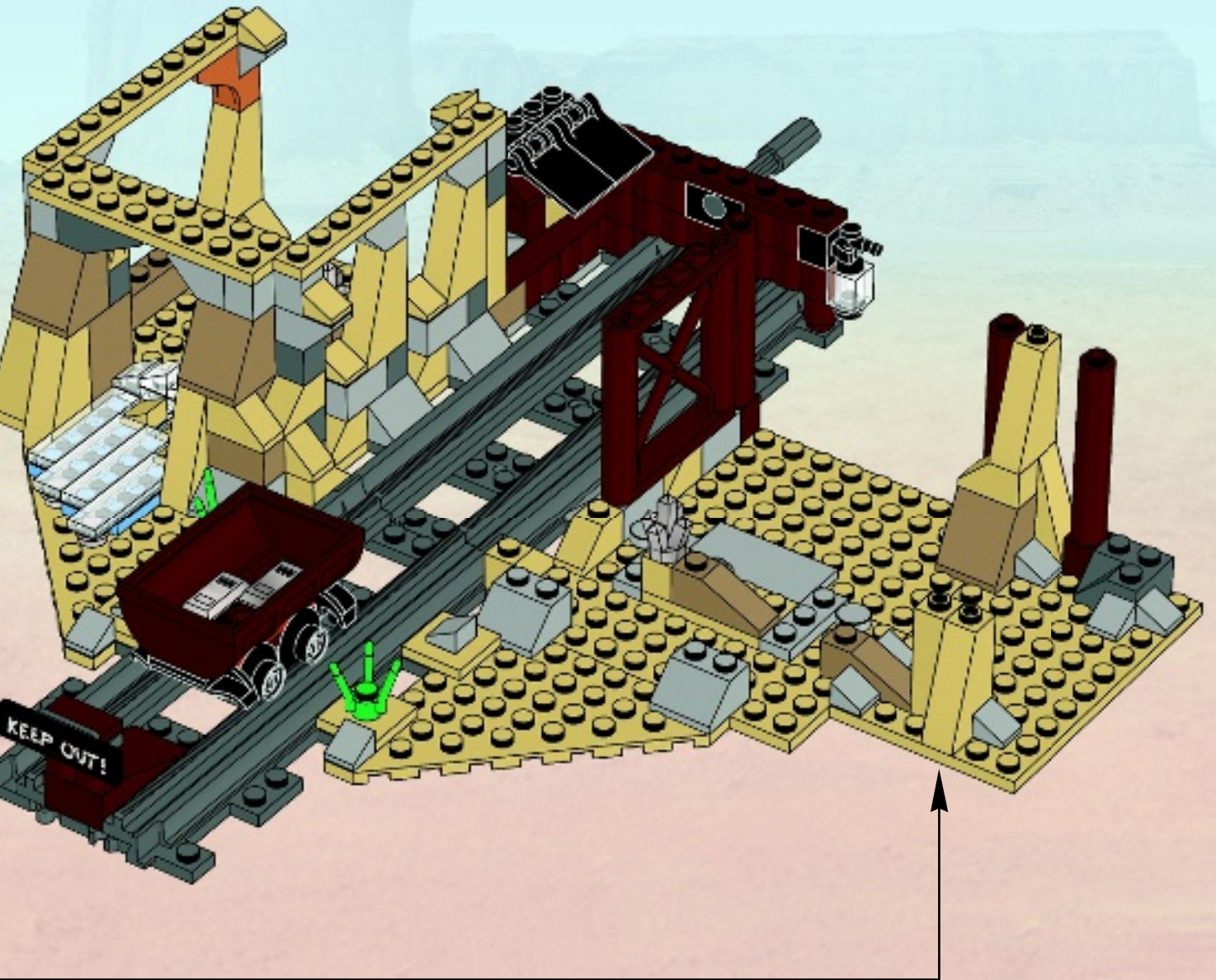

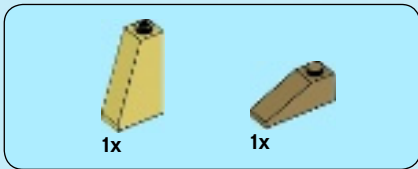

# 43

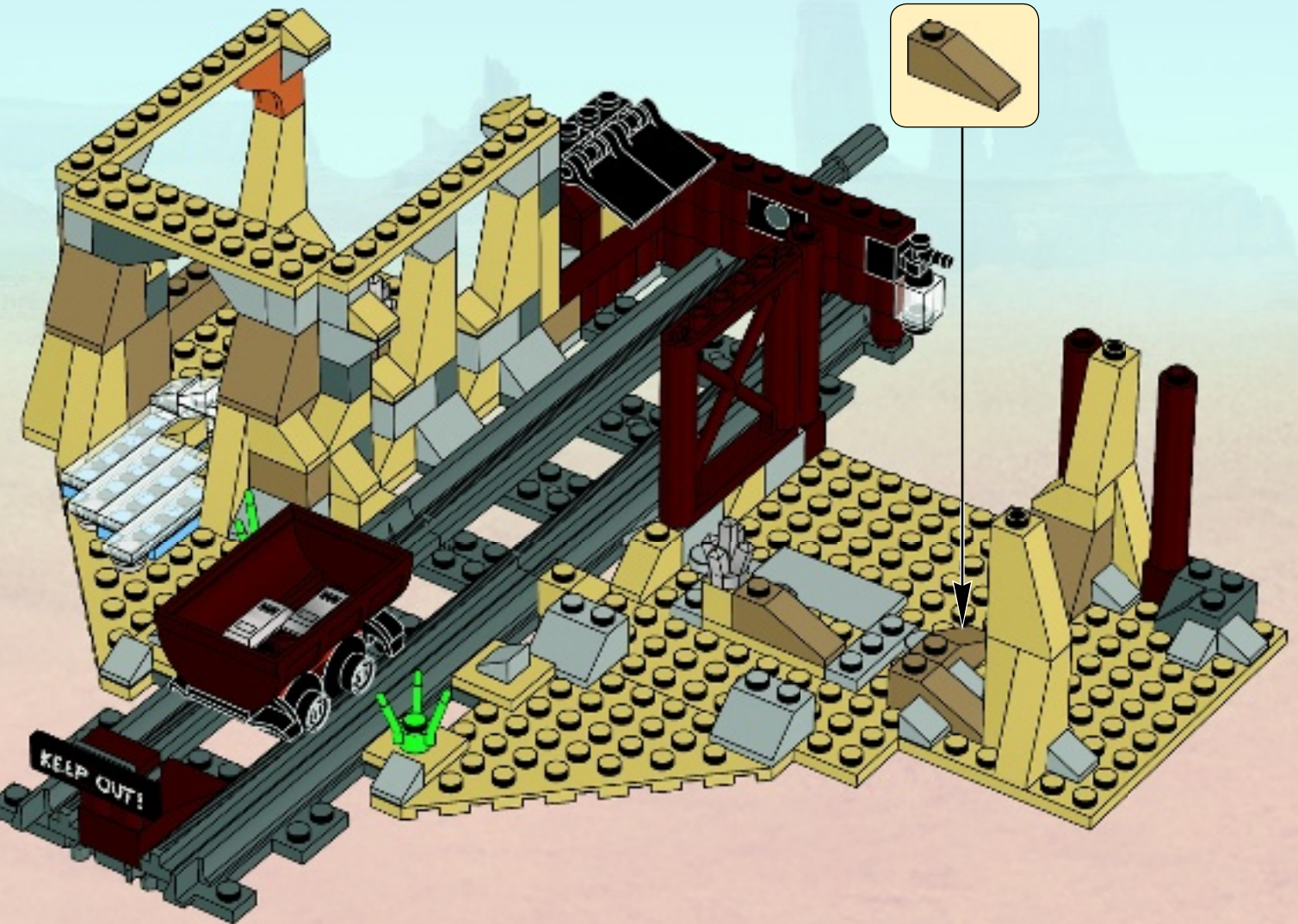

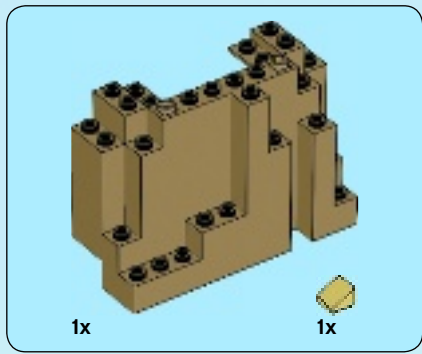

44

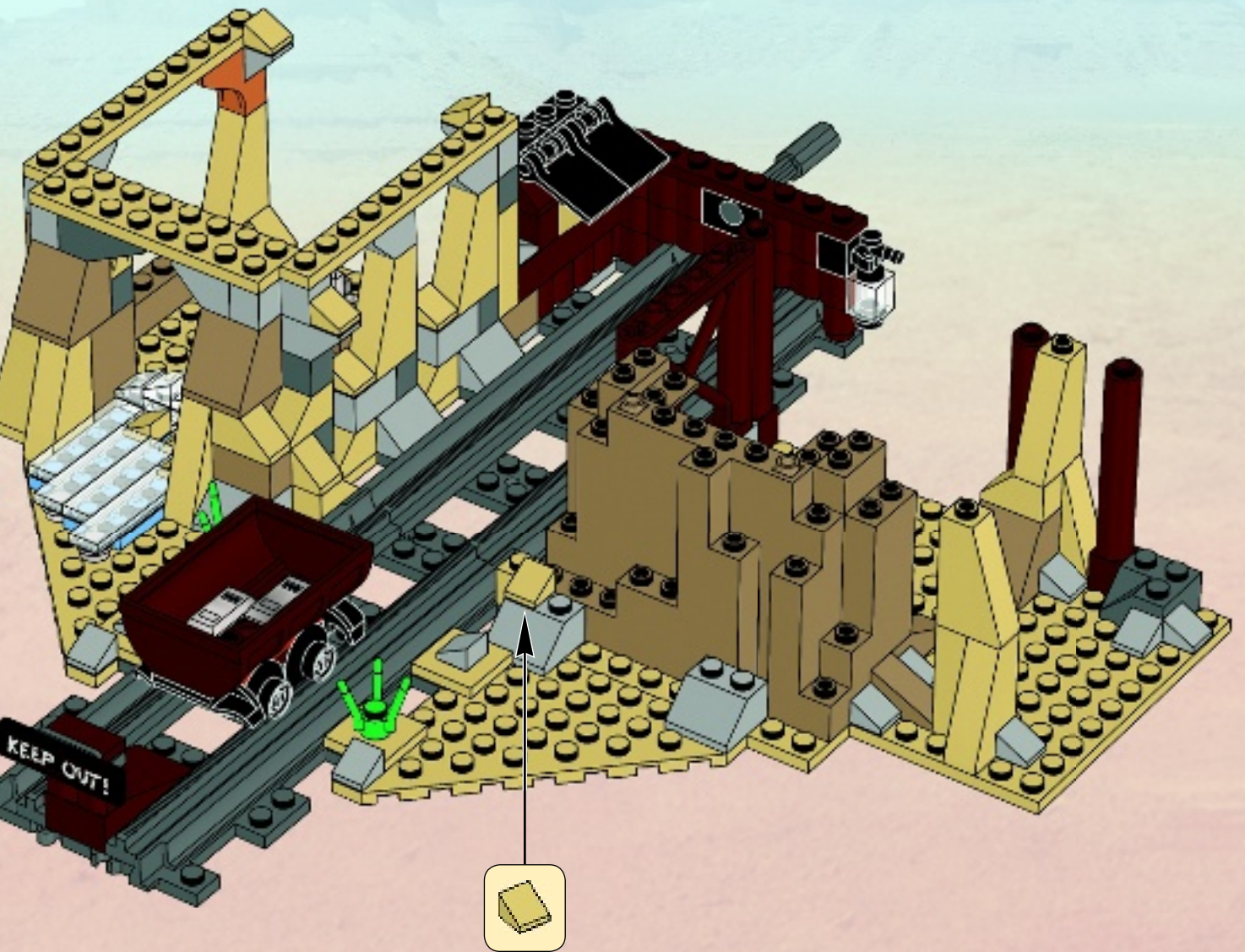

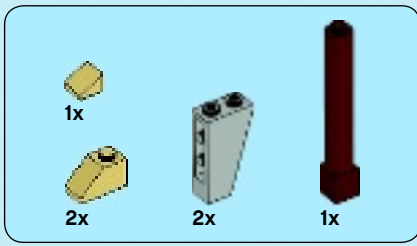

45

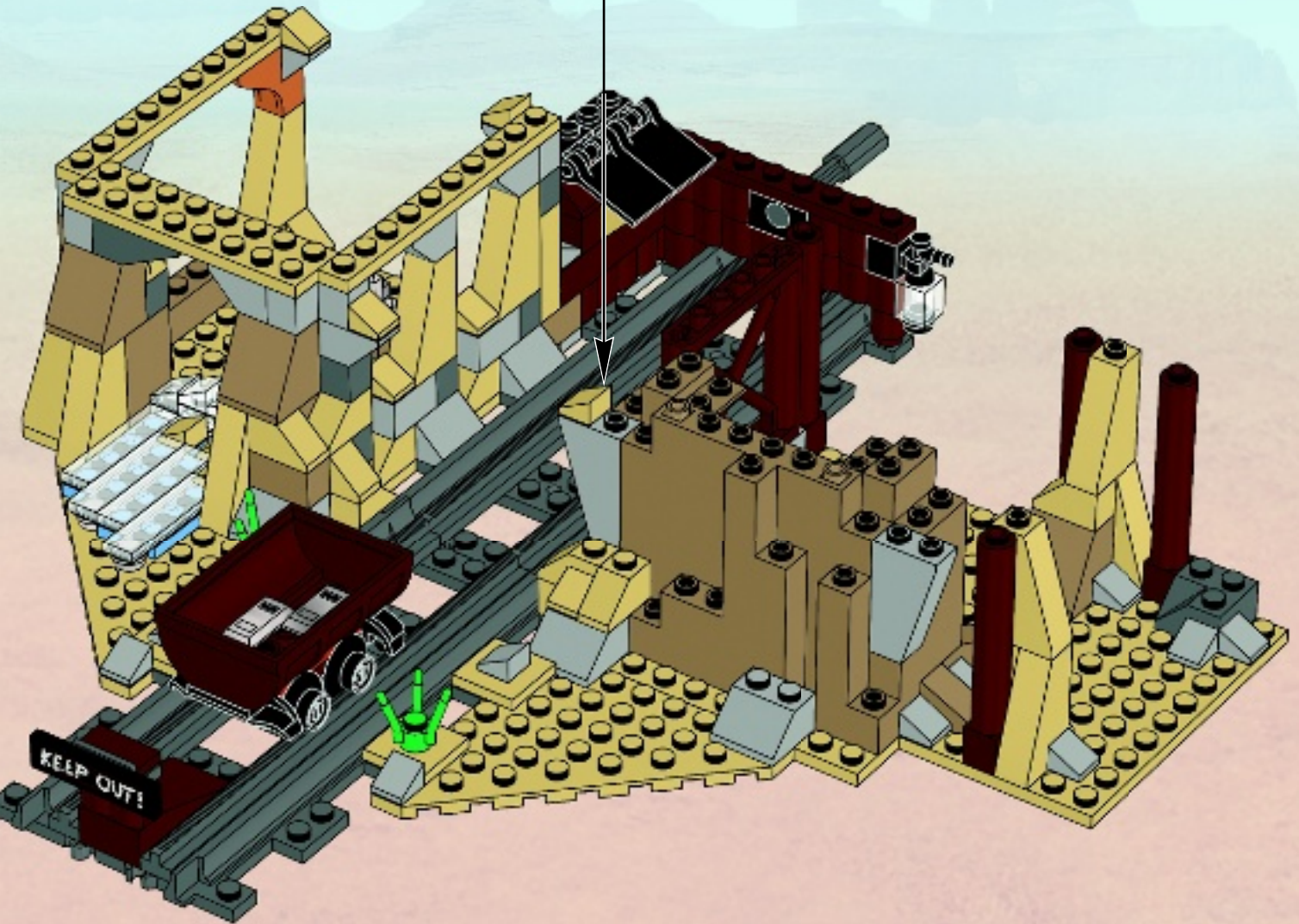
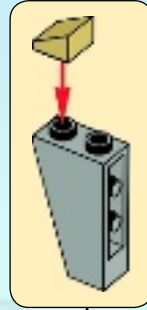

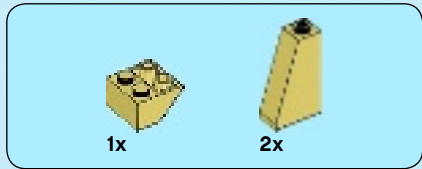

# 46

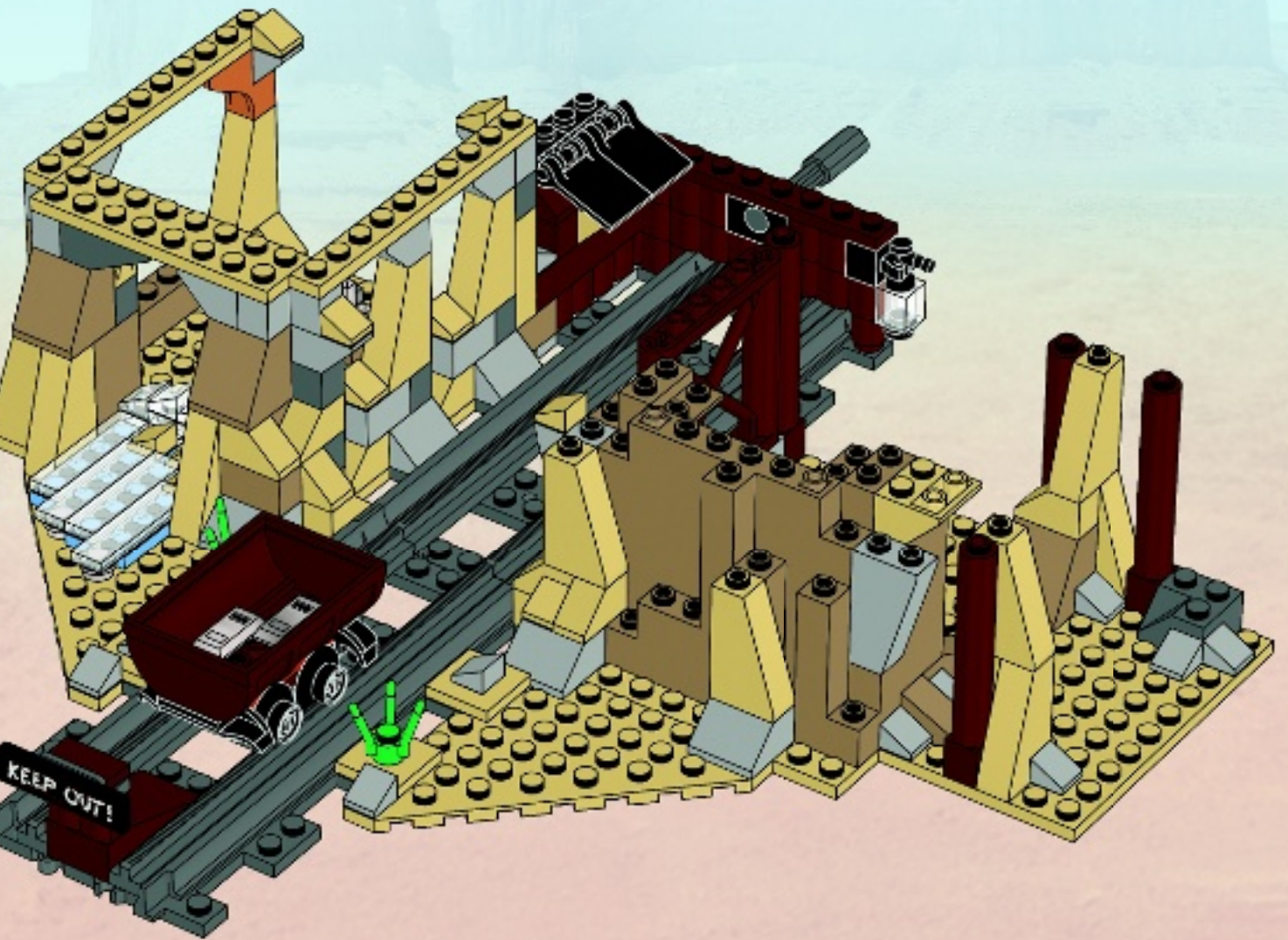





2x



1x

# 47

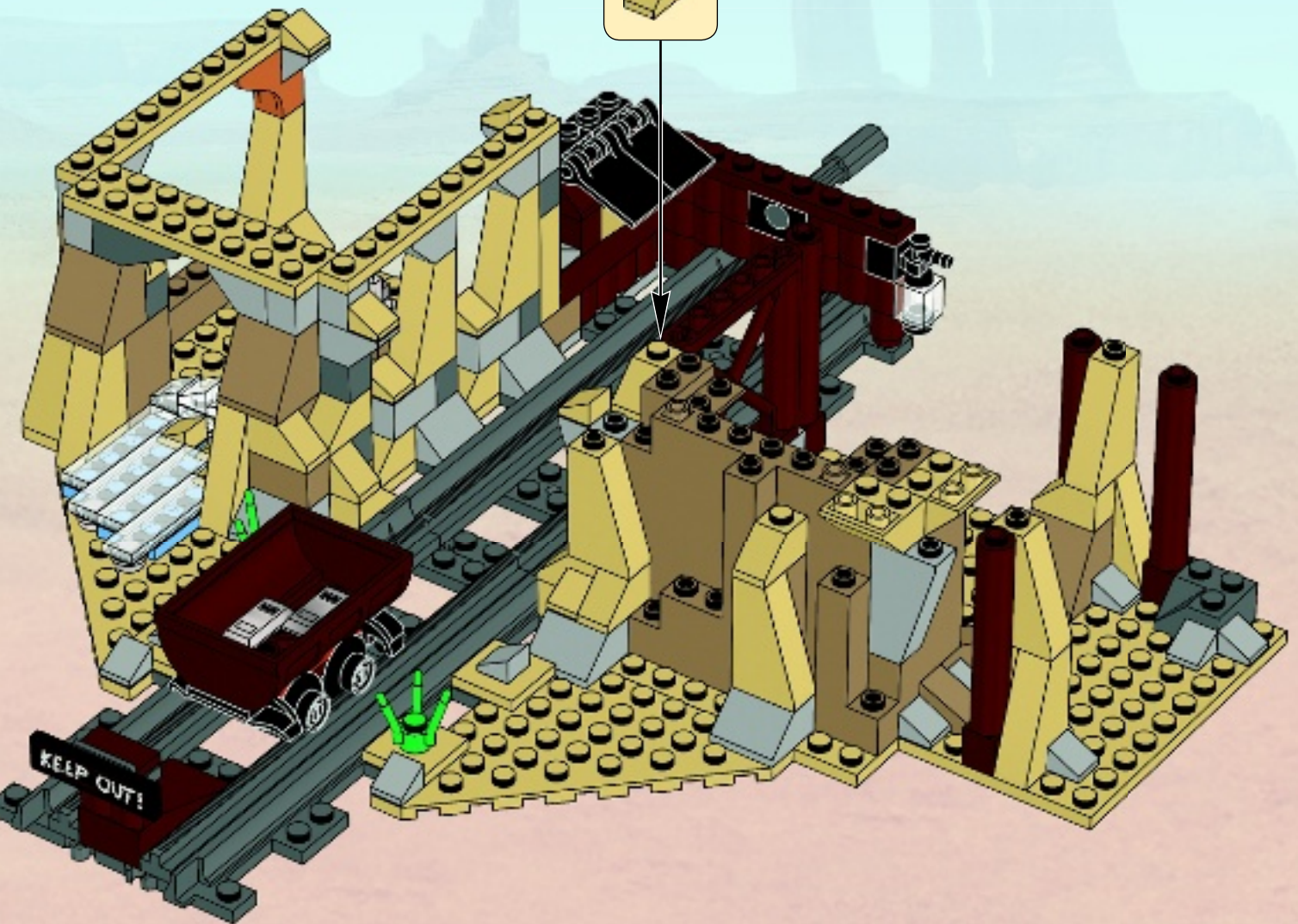

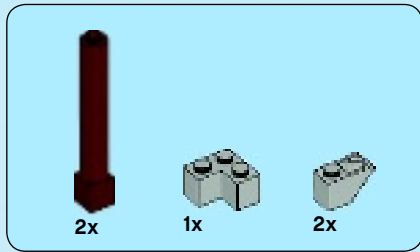

48

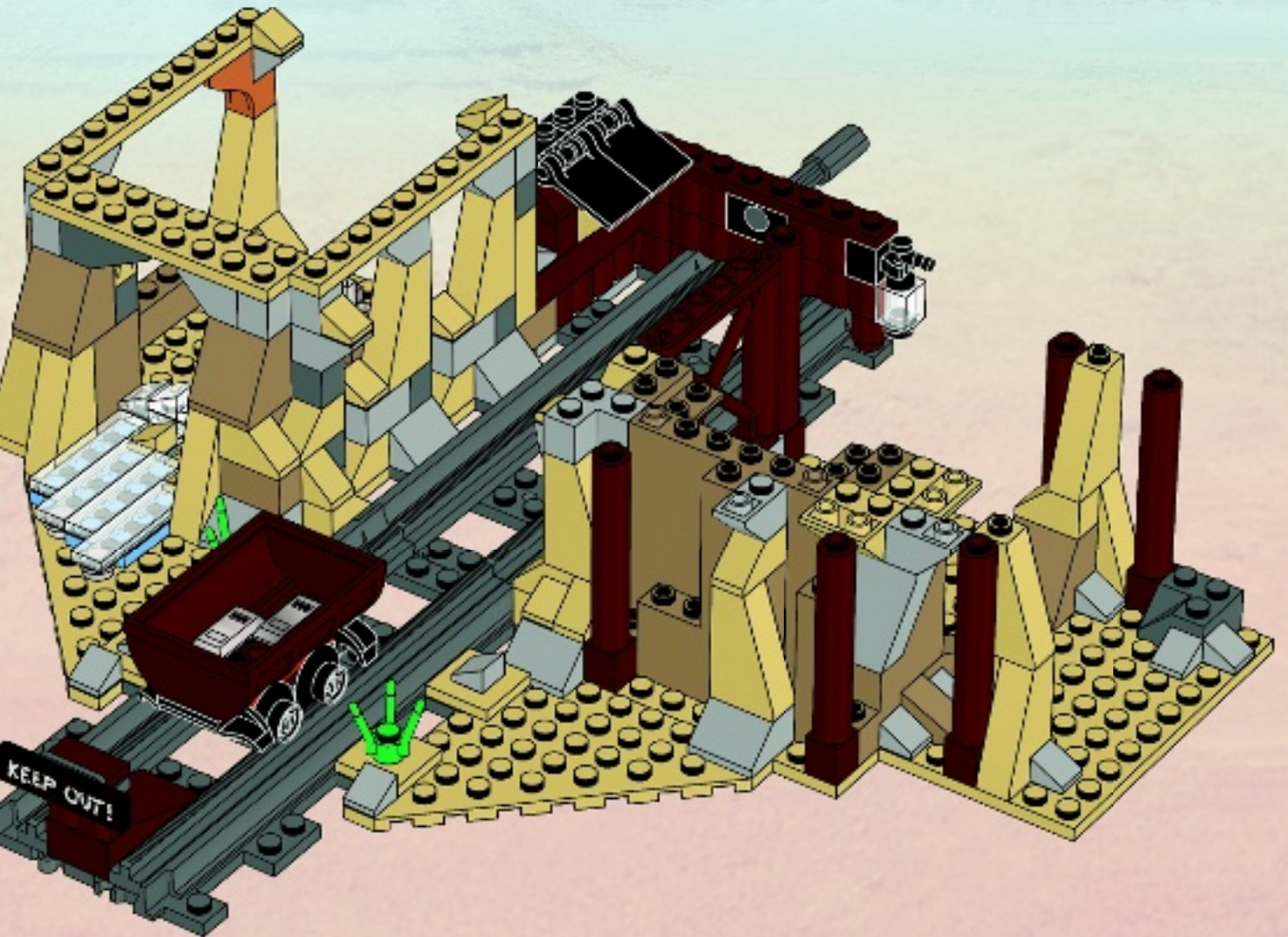

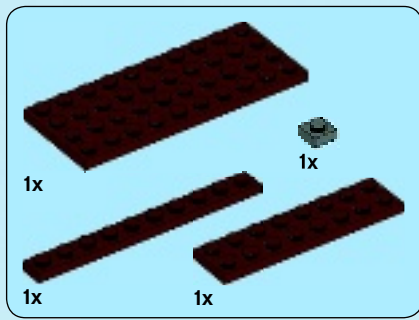

49

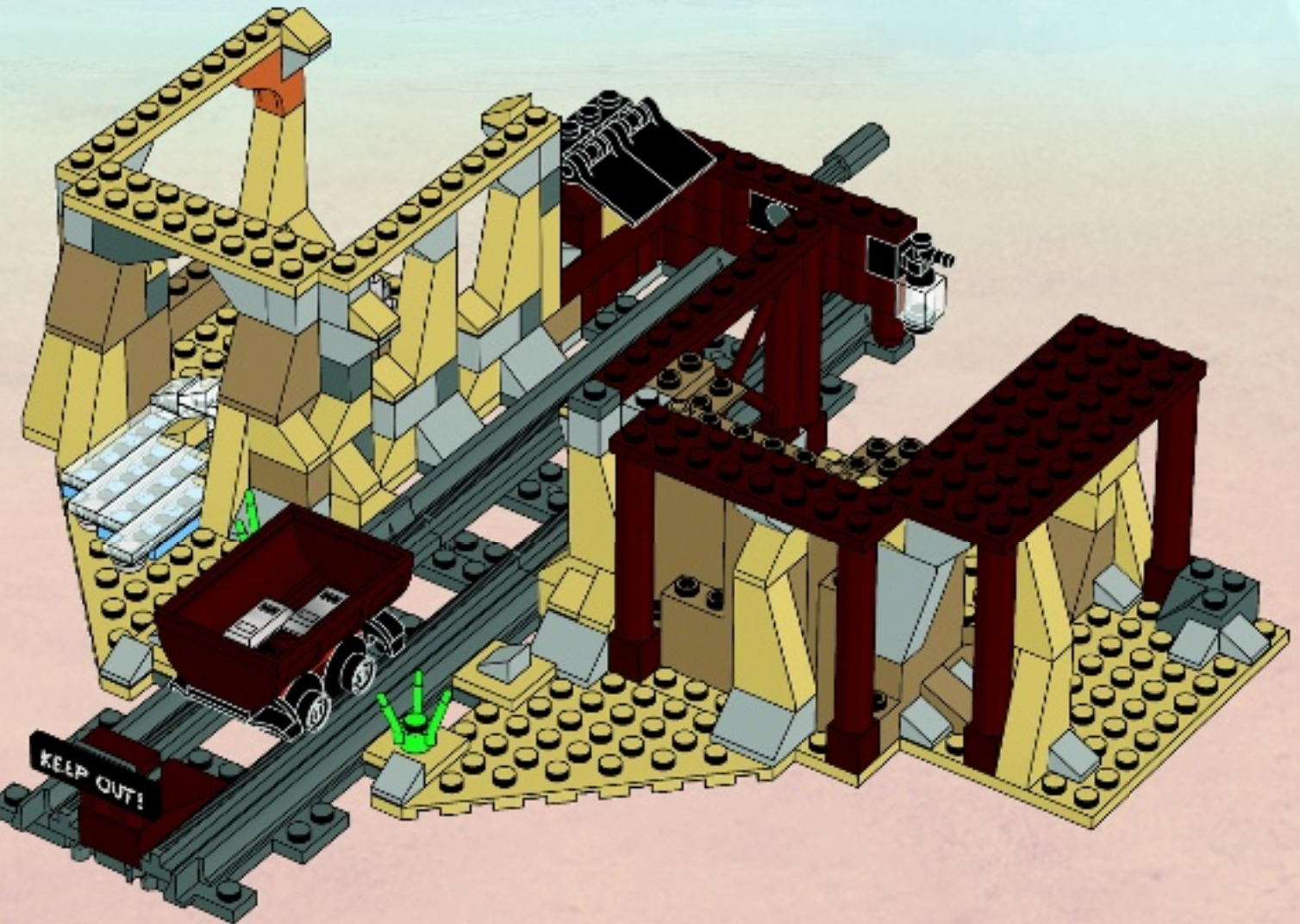

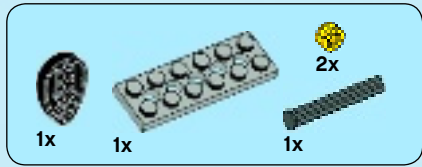

# 50

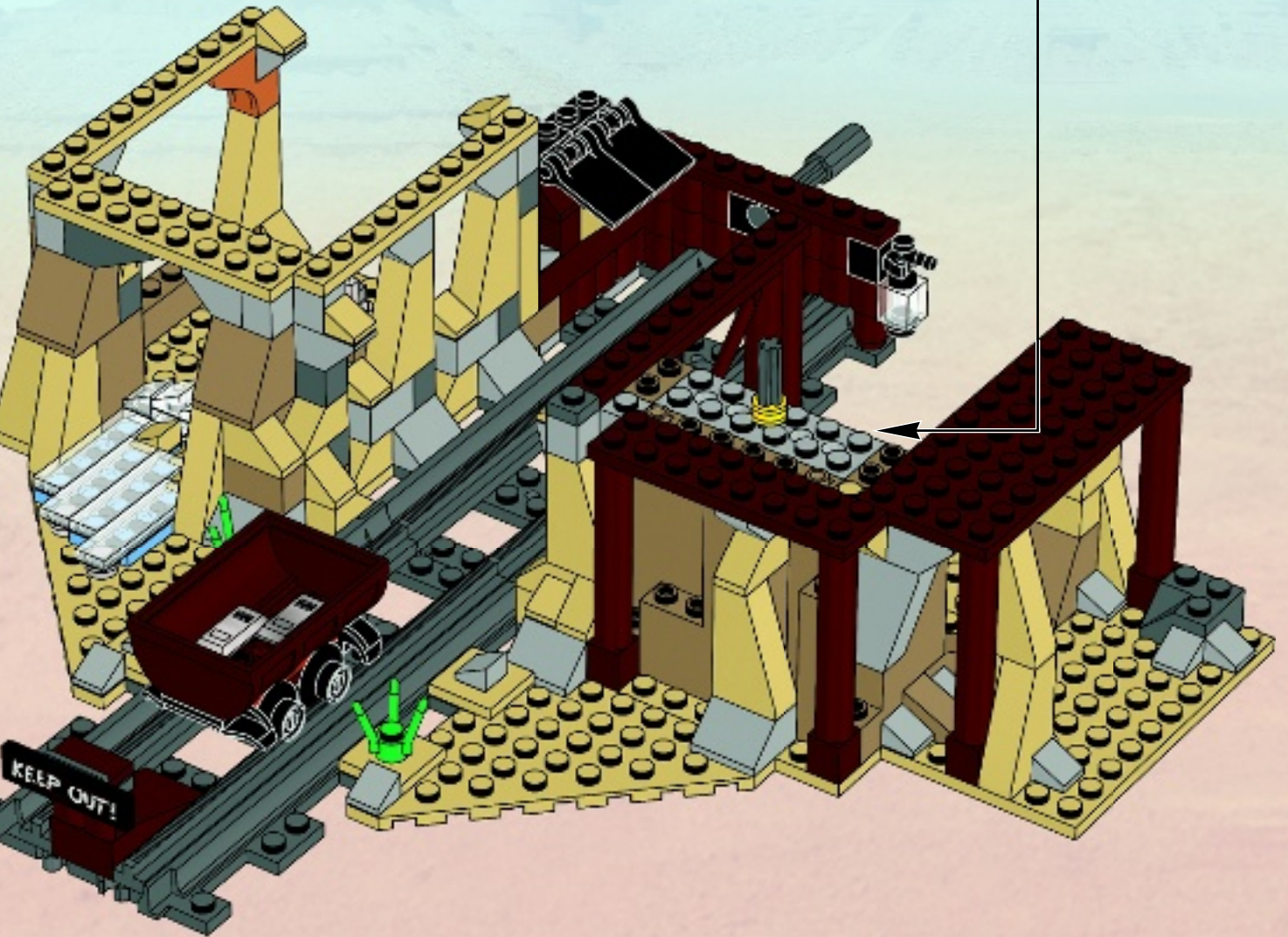
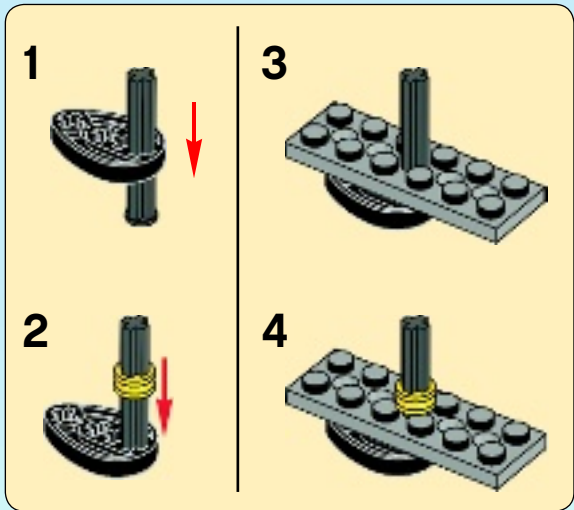



# 51

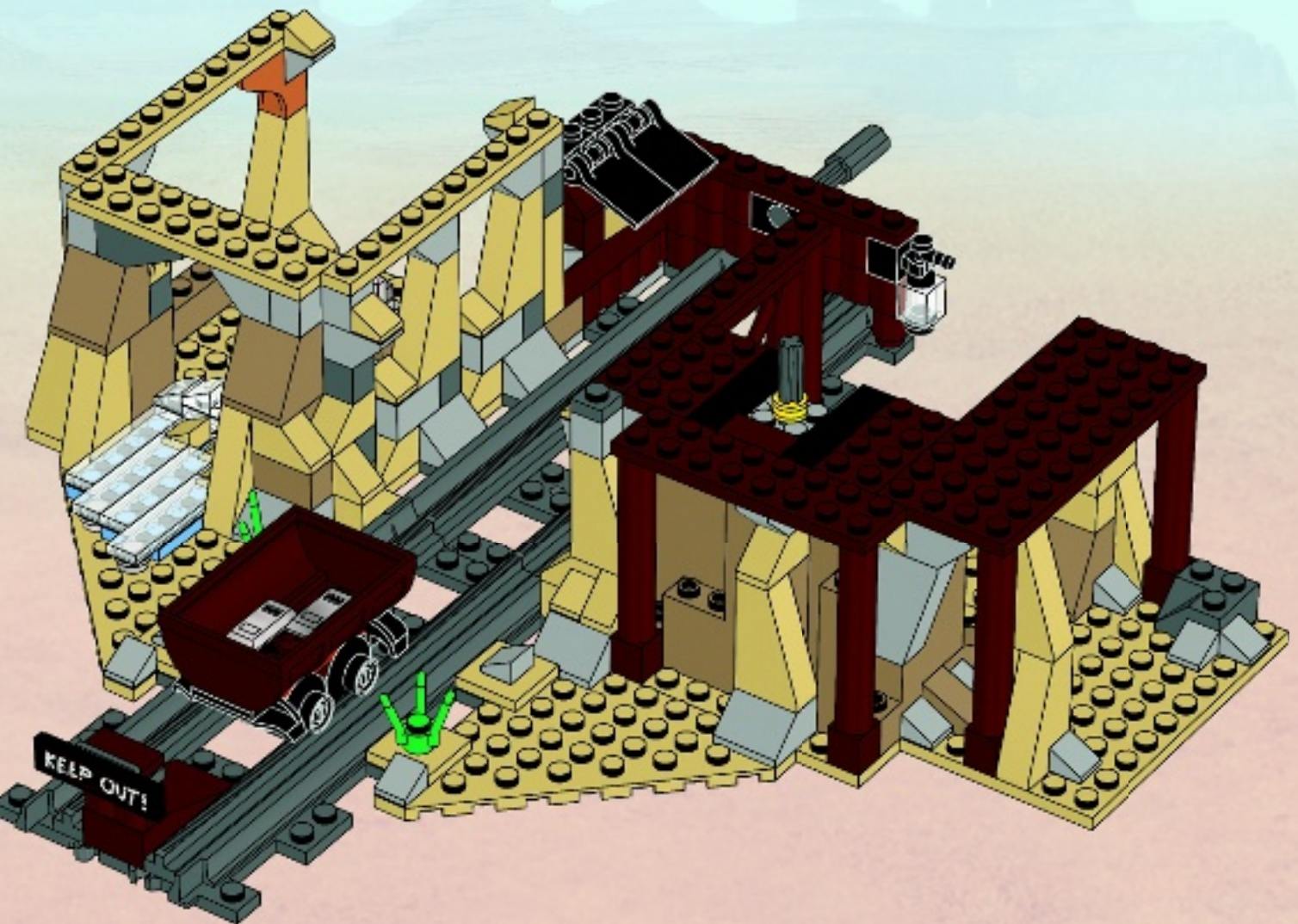



1x

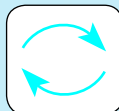

# 52

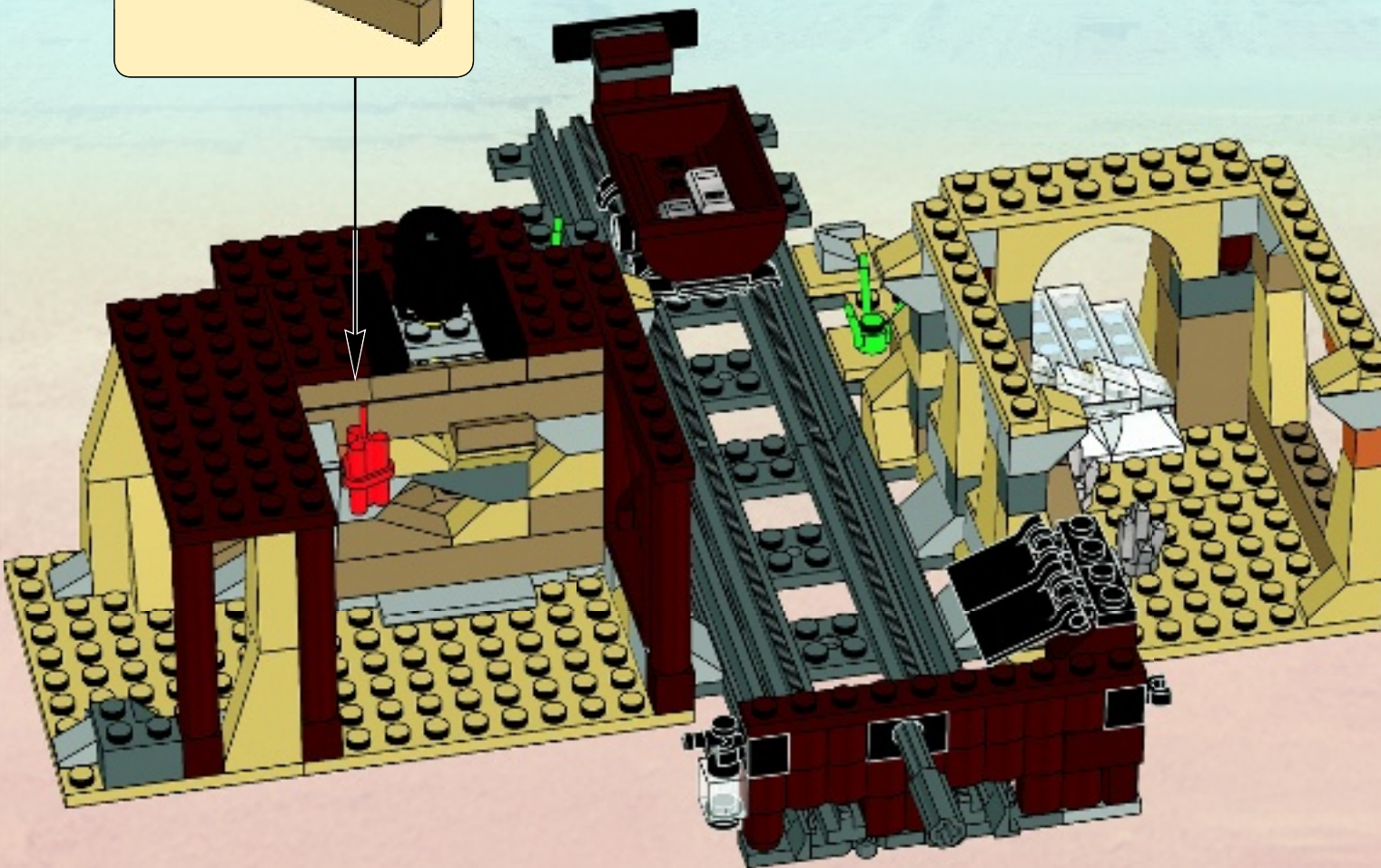
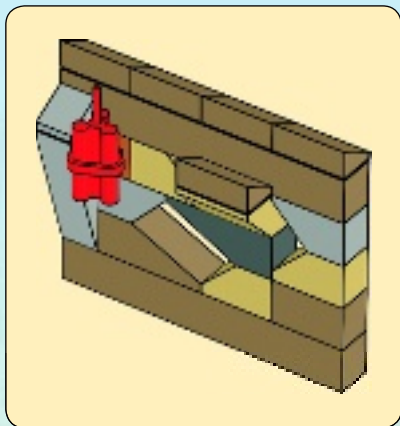

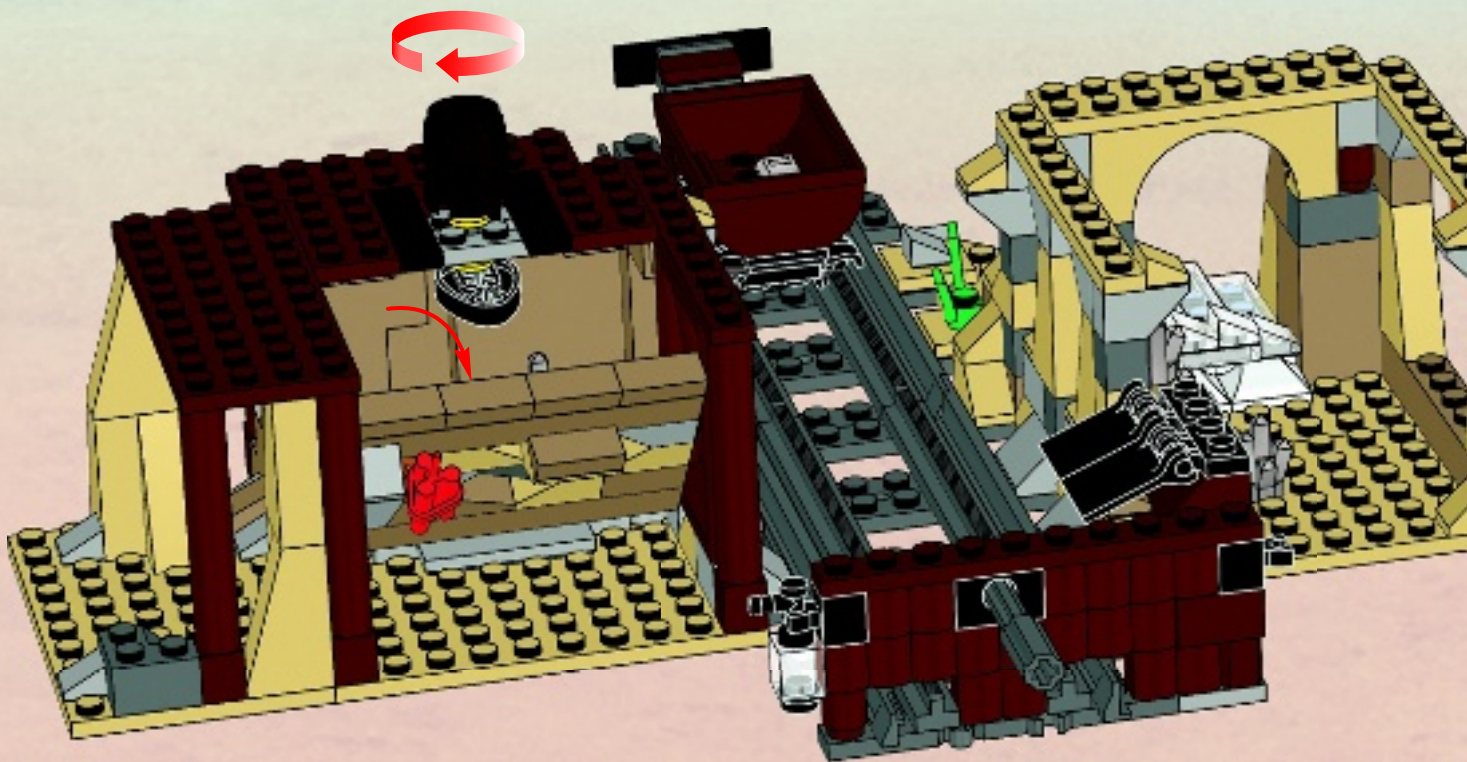

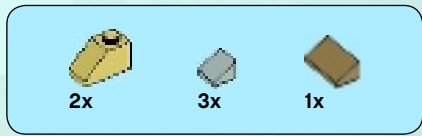
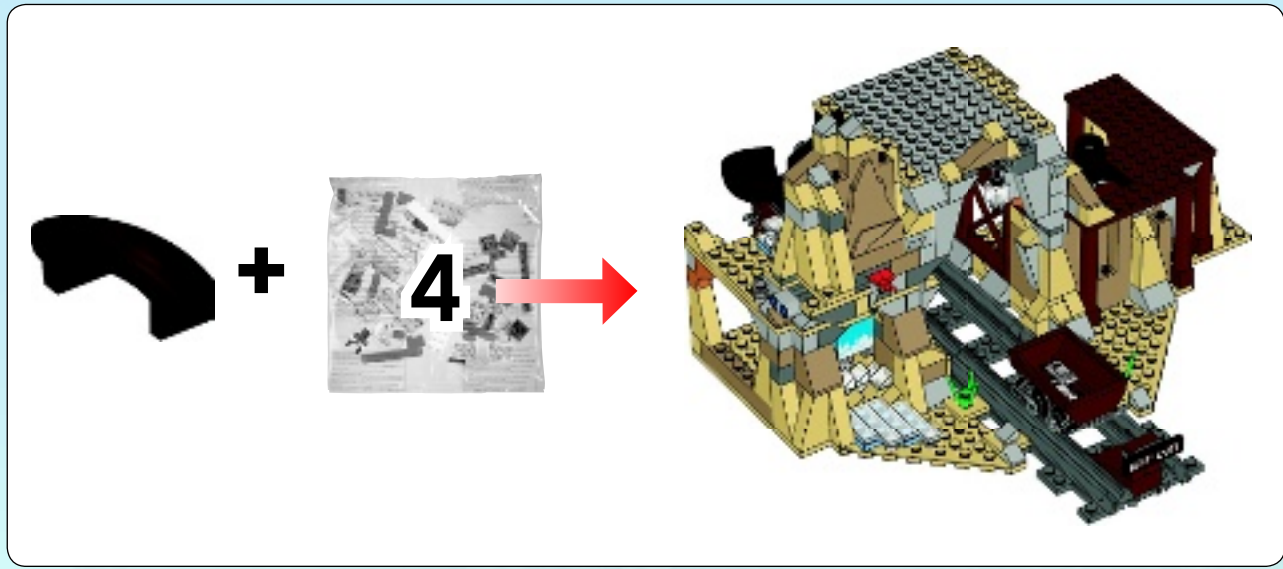

53

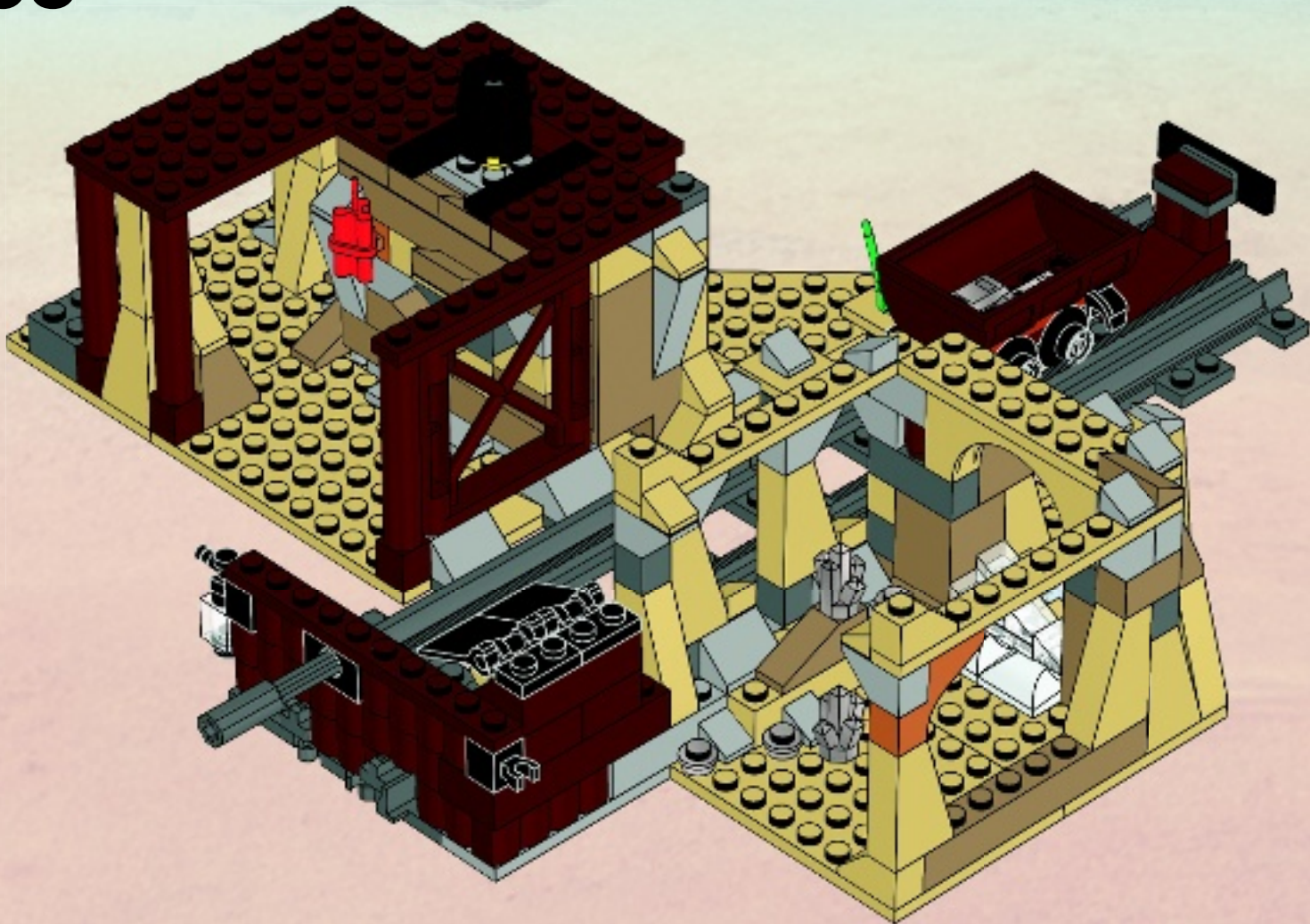



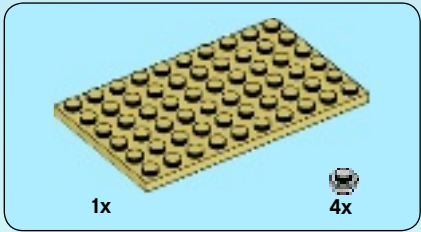
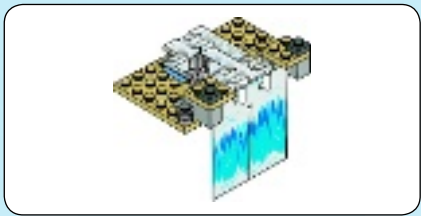

1

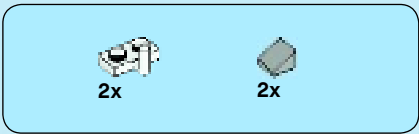
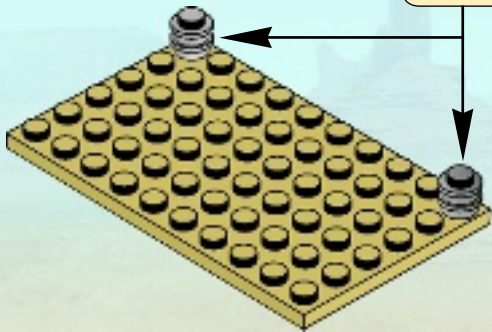
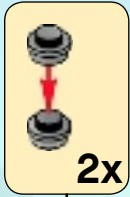

3

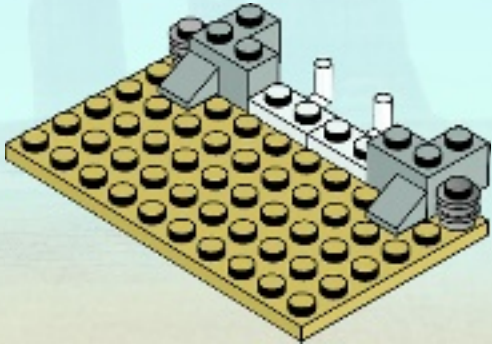

2

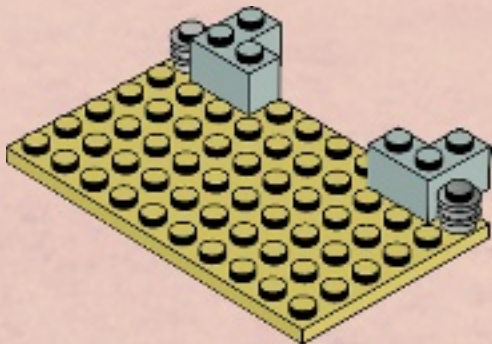

4

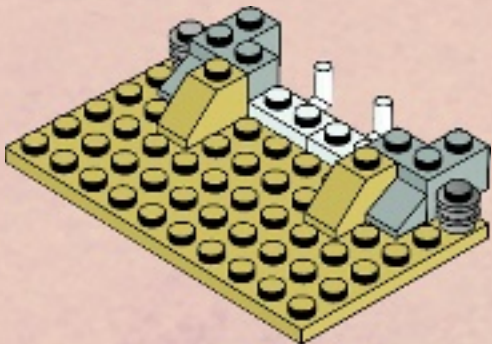

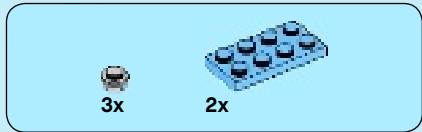

5

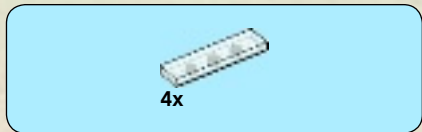
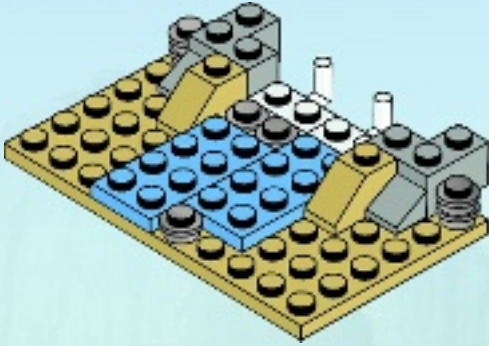

6

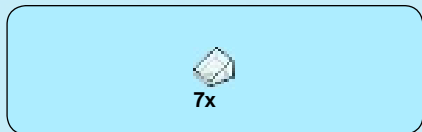
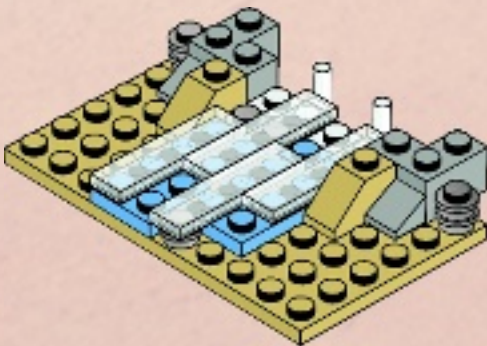

7

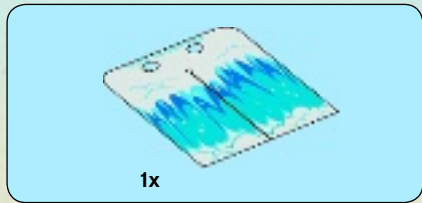
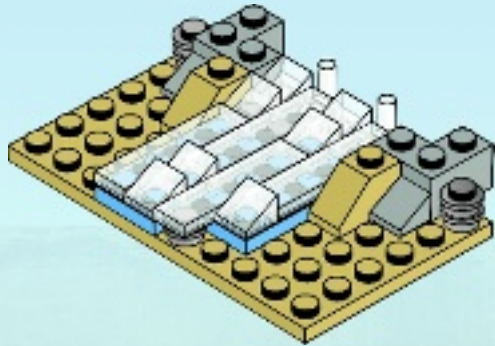

8

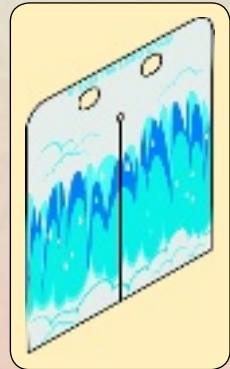
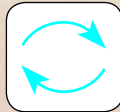



2x

9



2x



1x

10



11

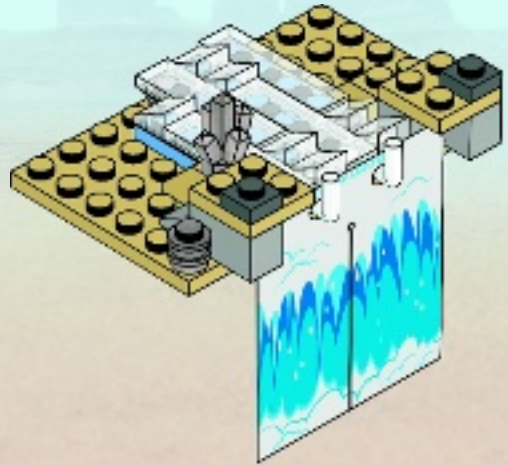

54

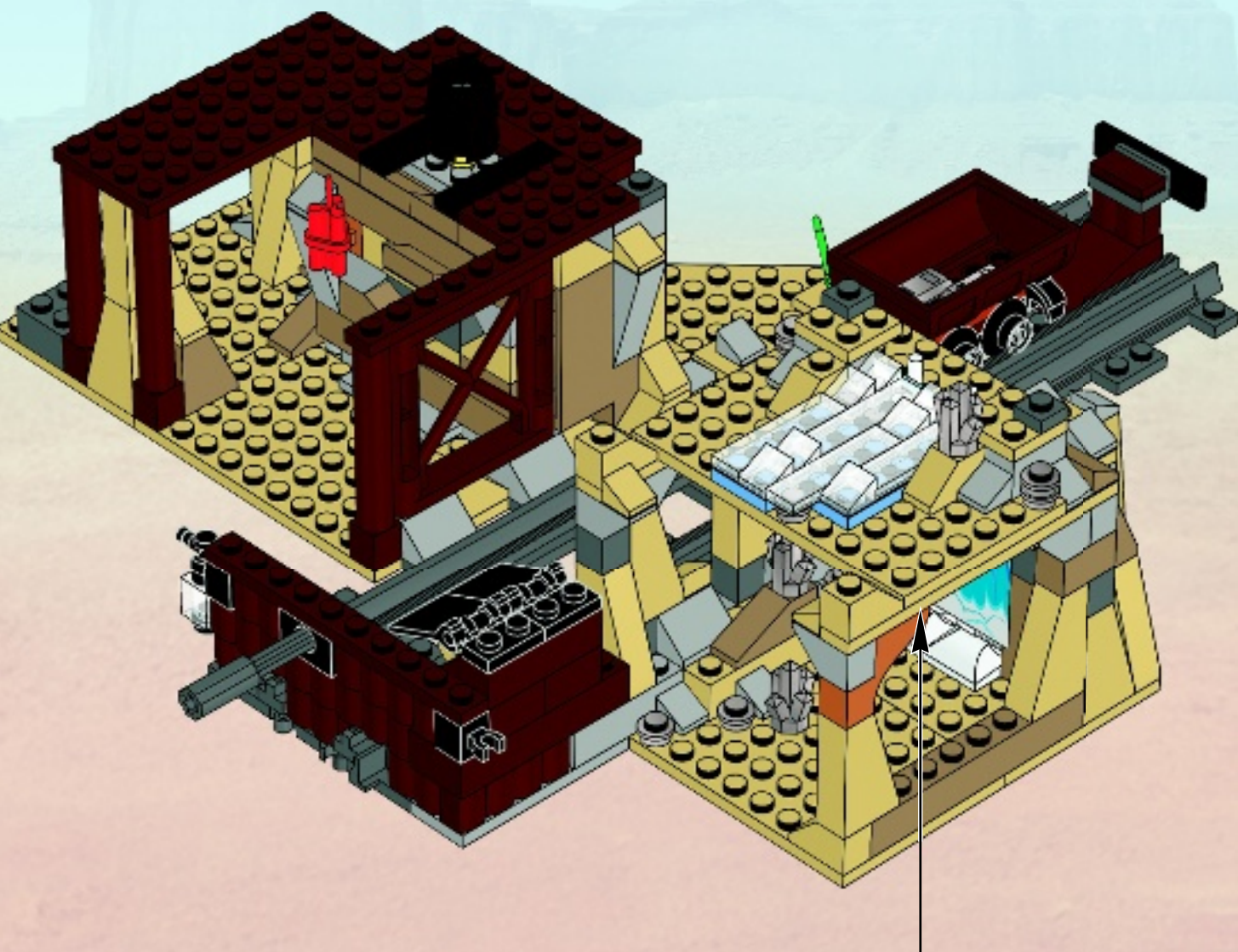

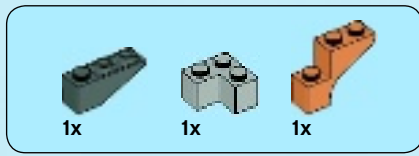

55

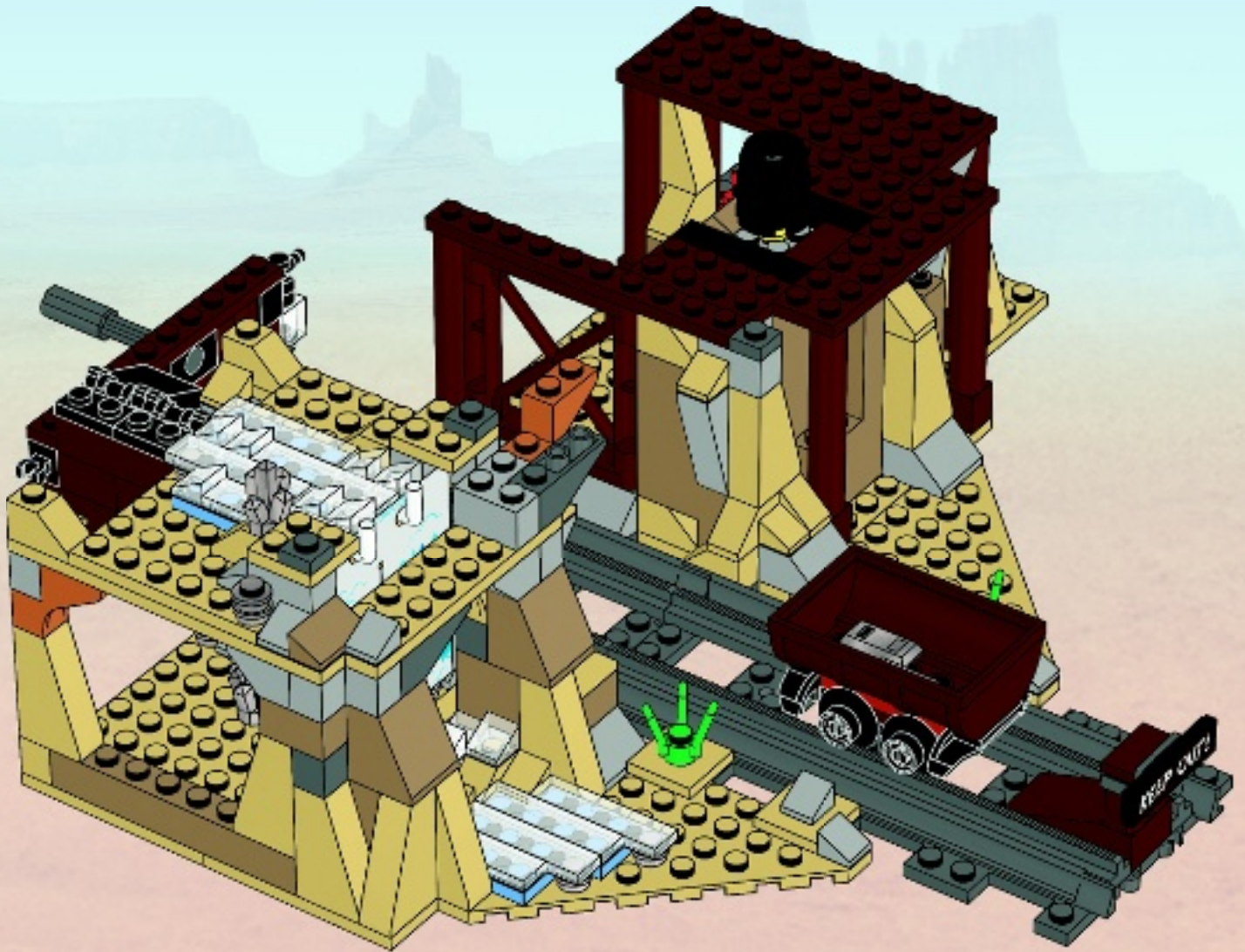
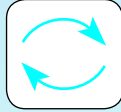



1x



1x

# 56

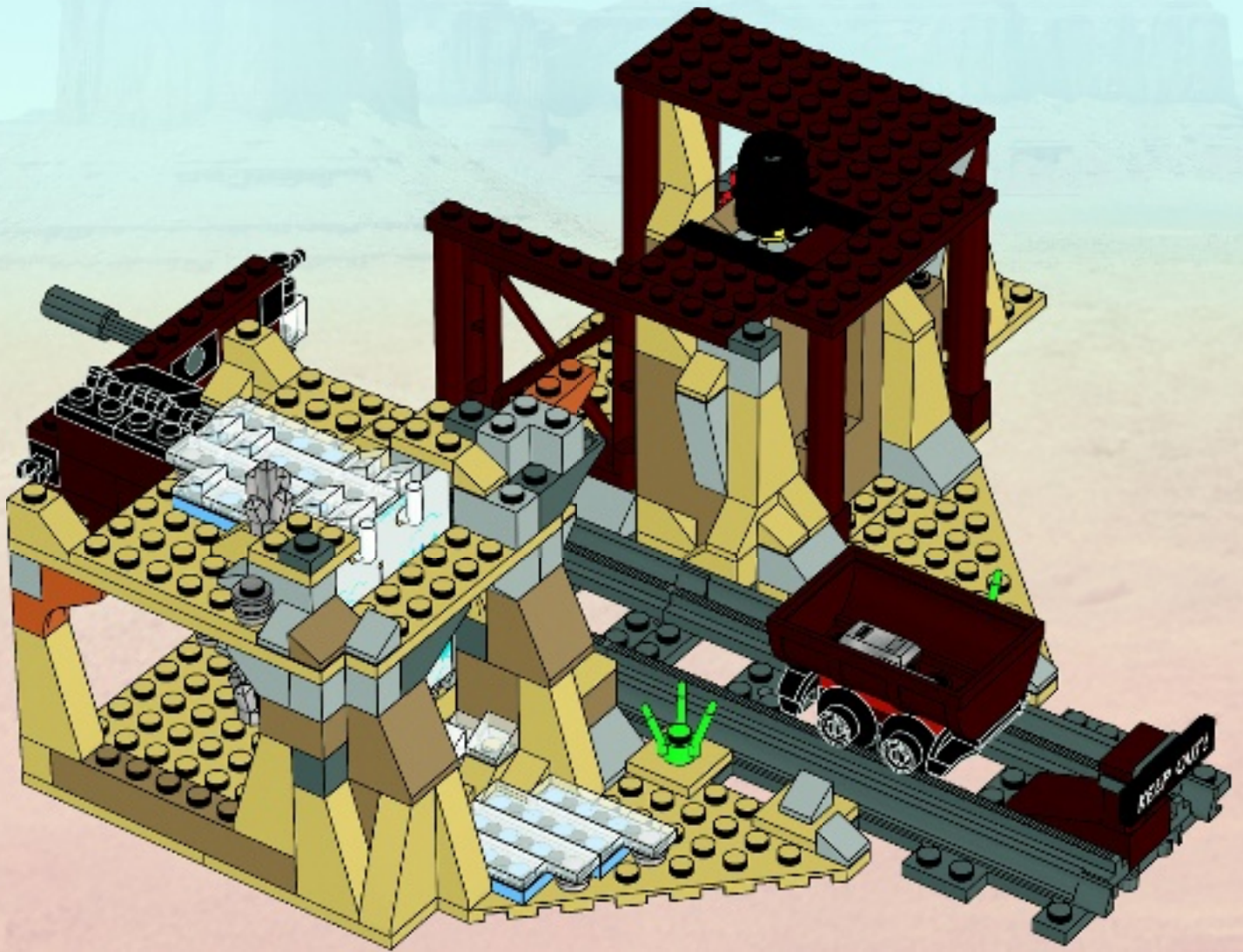



1x



2x

# 57

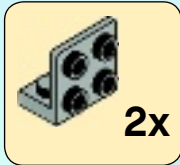

2x

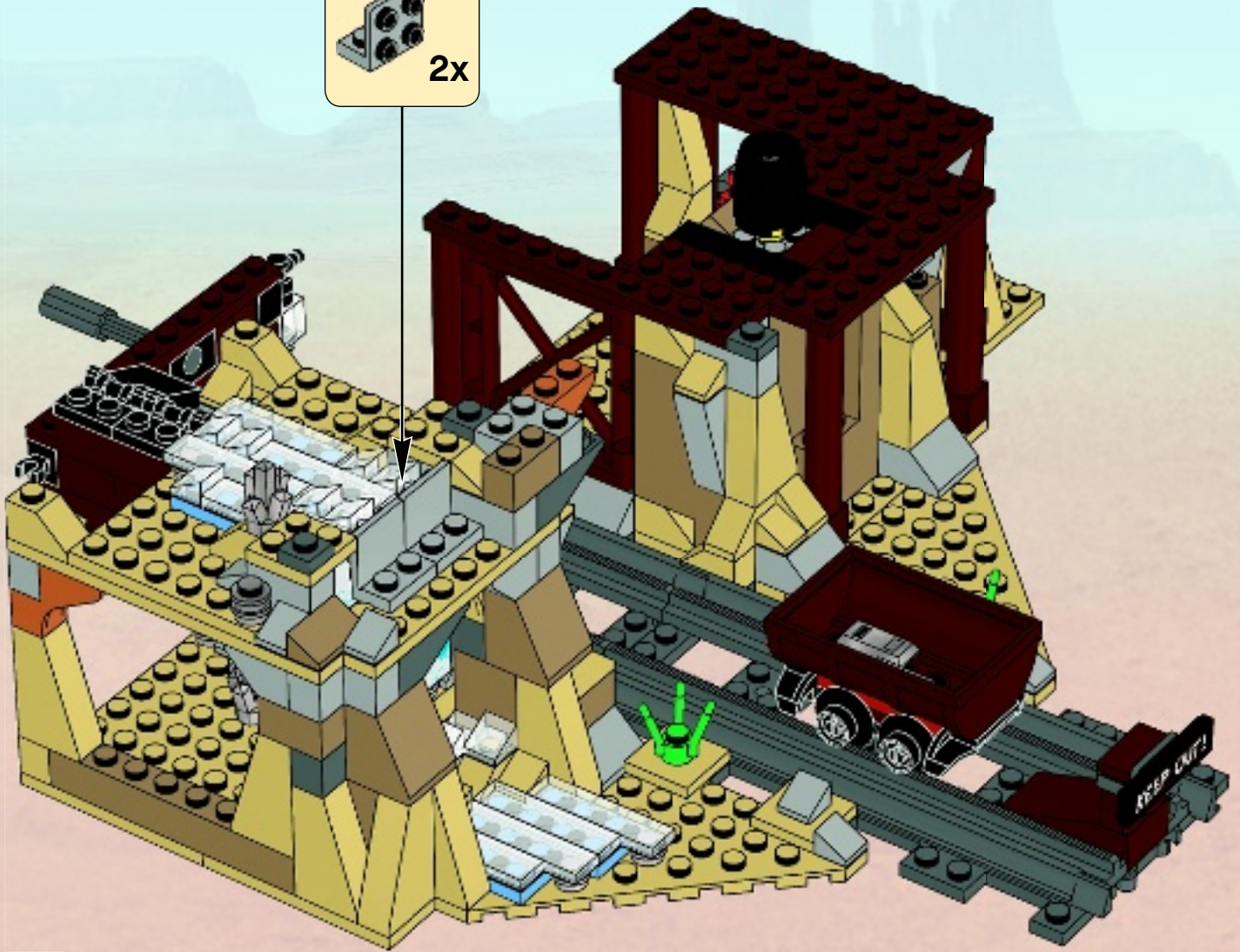

1x  2x 

# 58

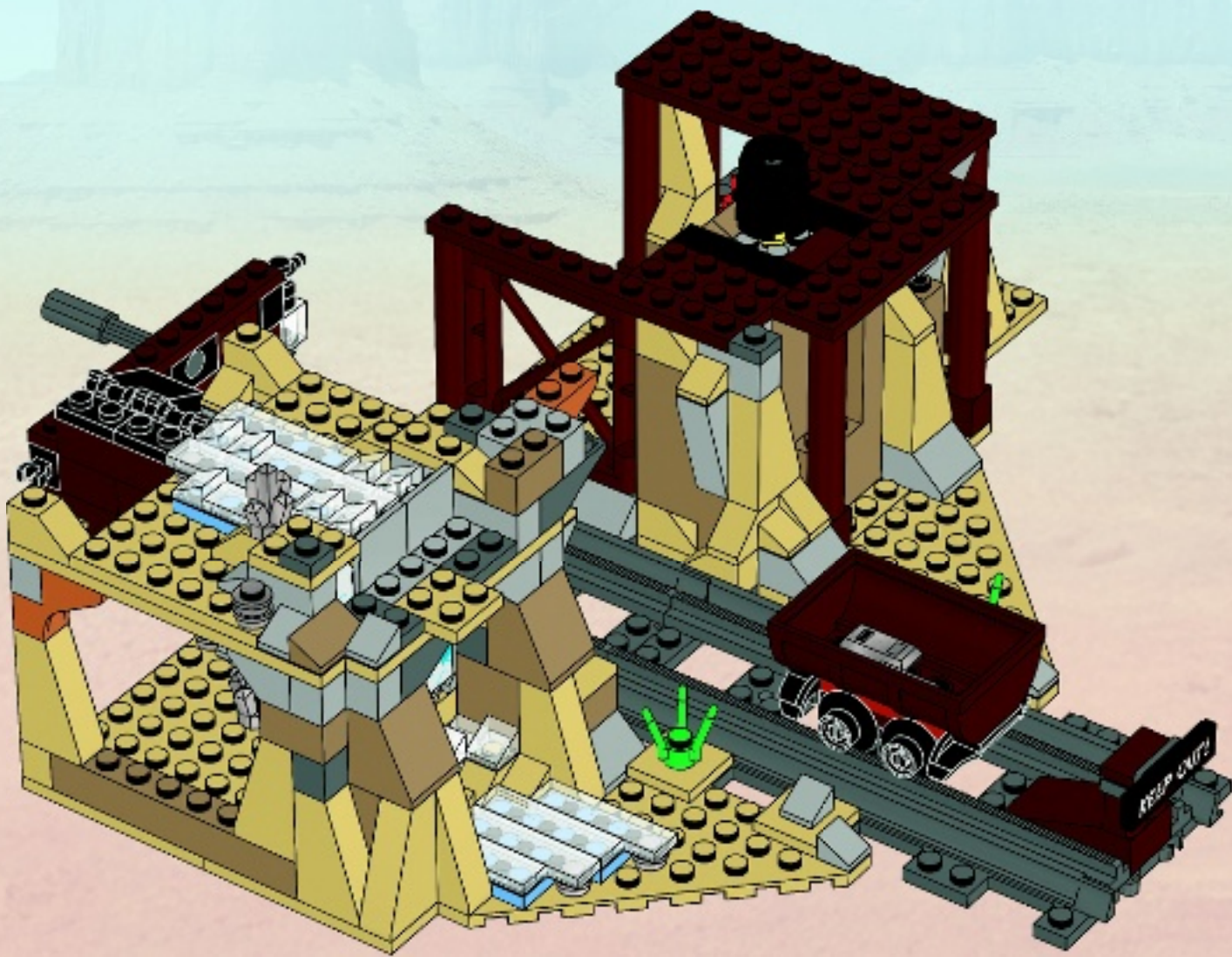





2x



1x

# 59





# 60

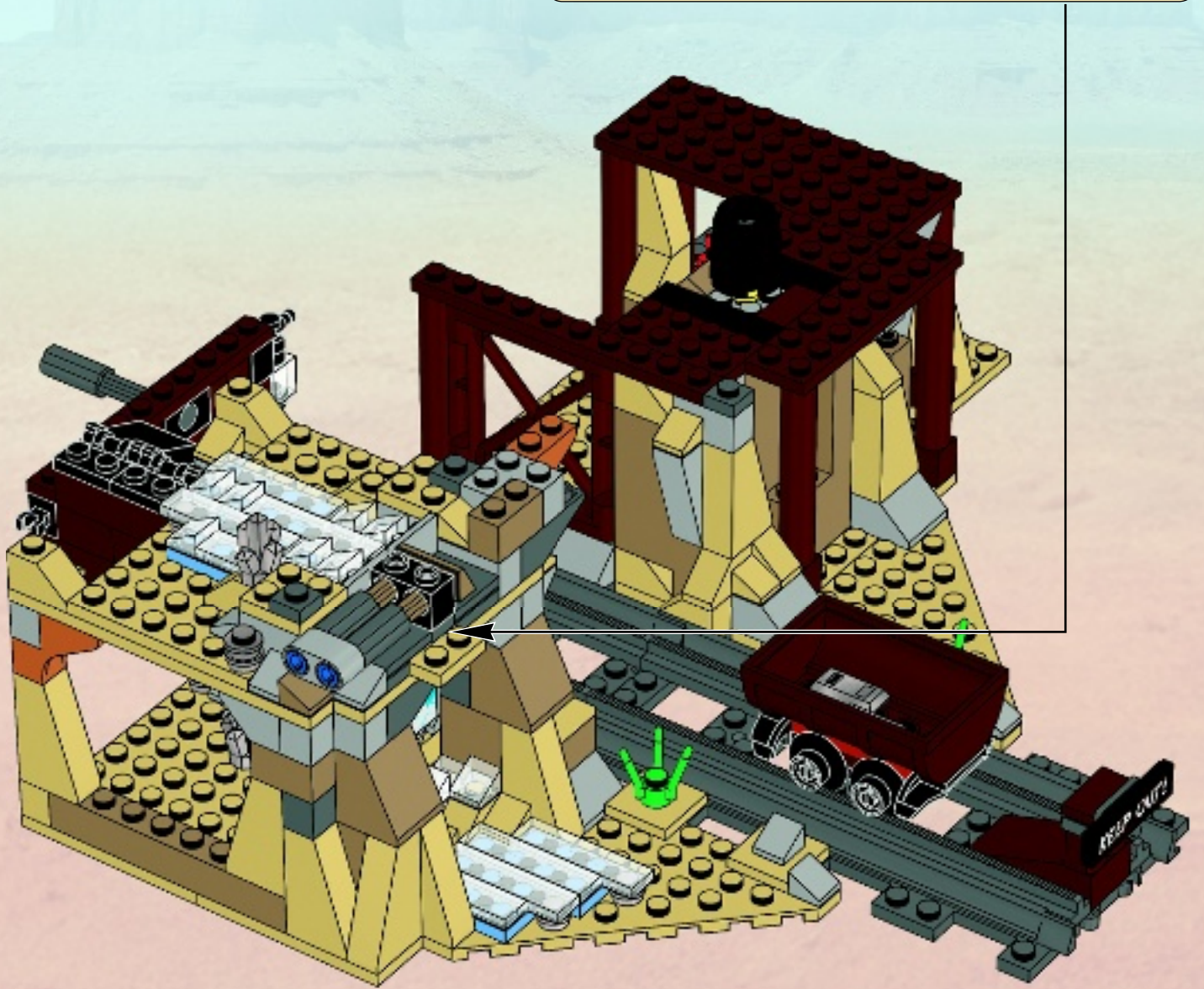
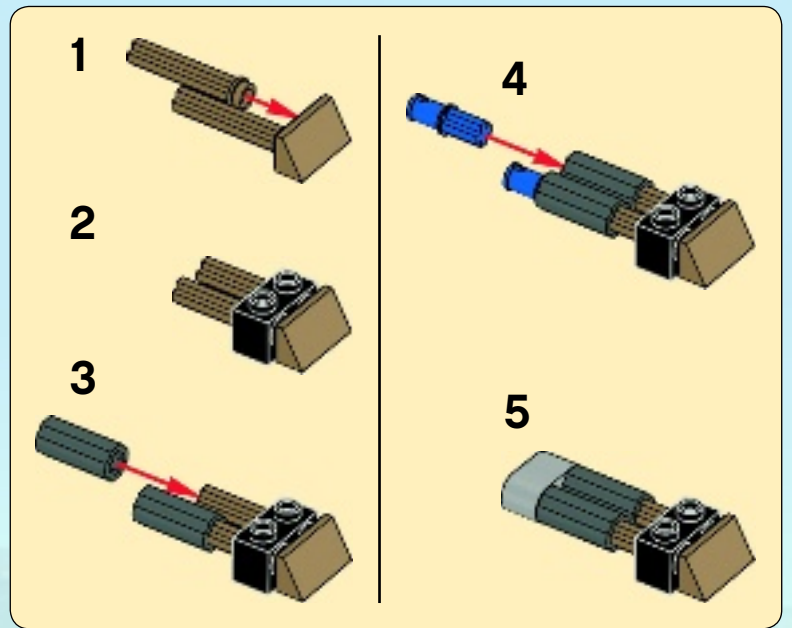

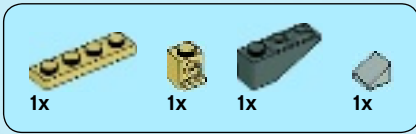

# 61

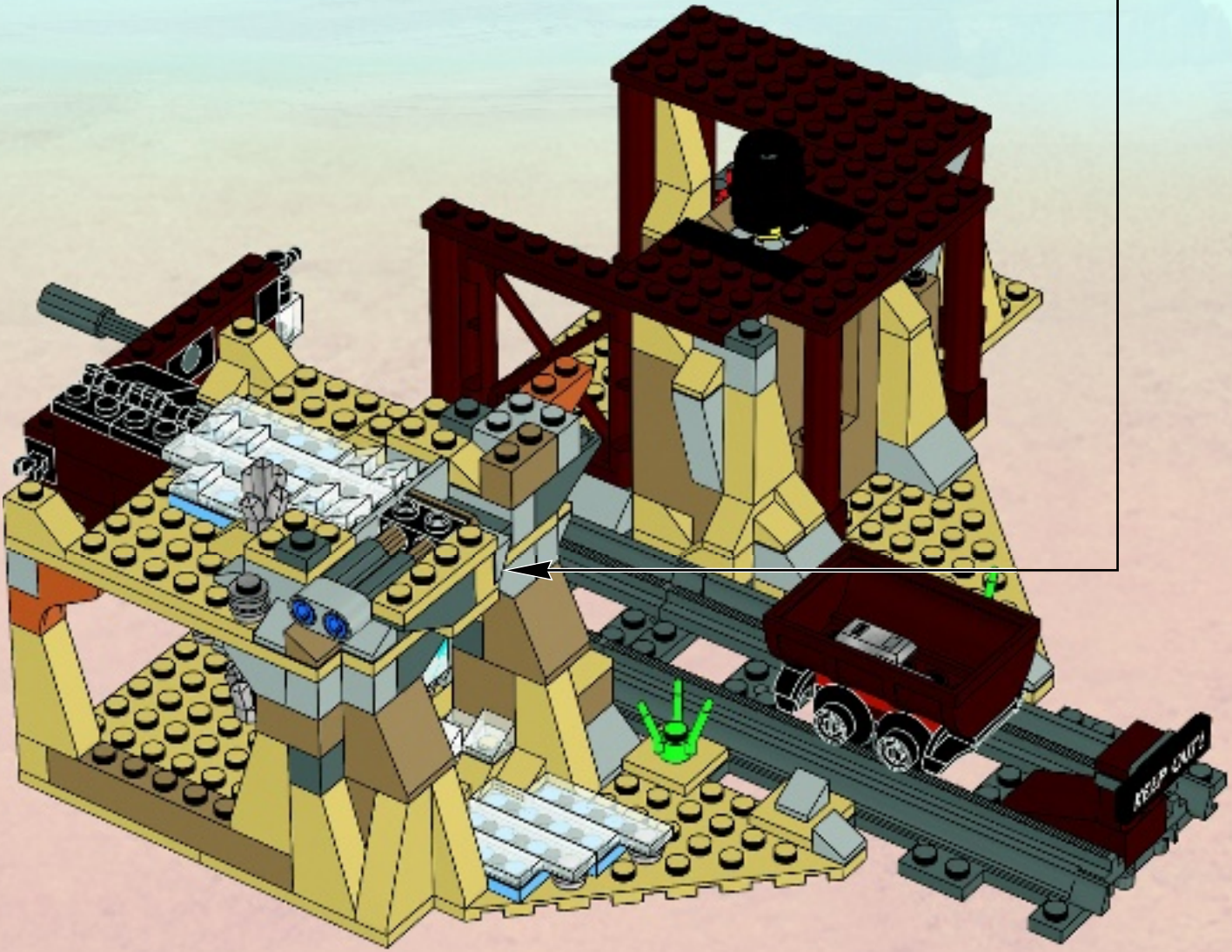
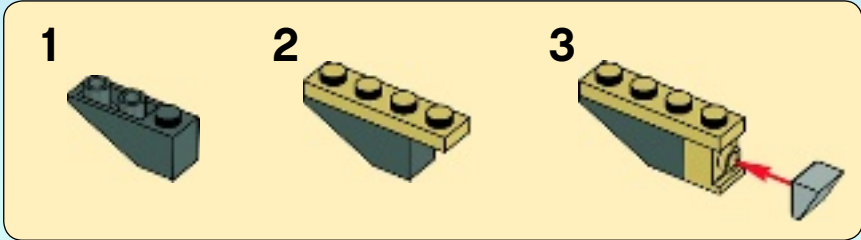



# 62

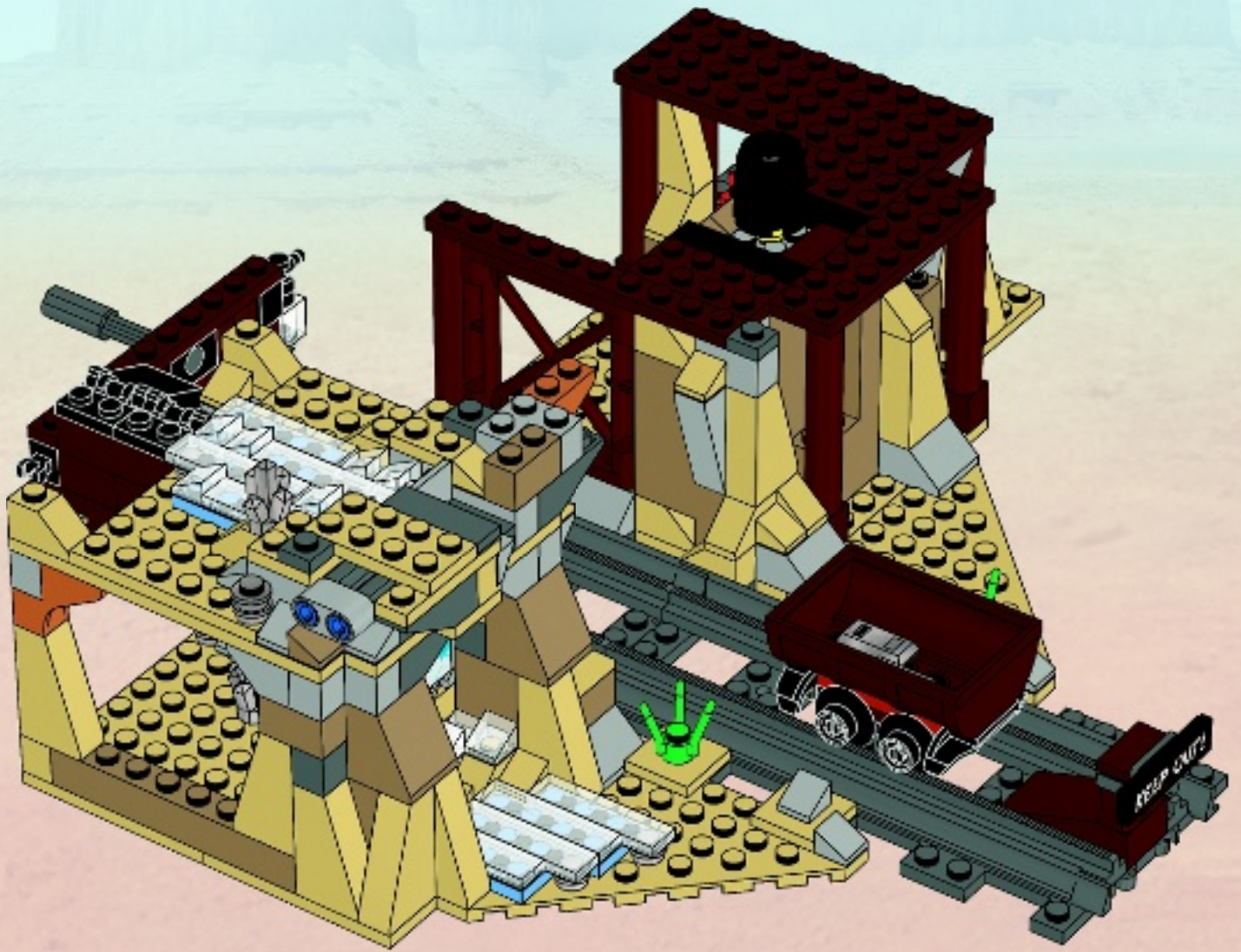

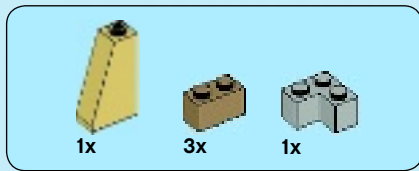

# 63

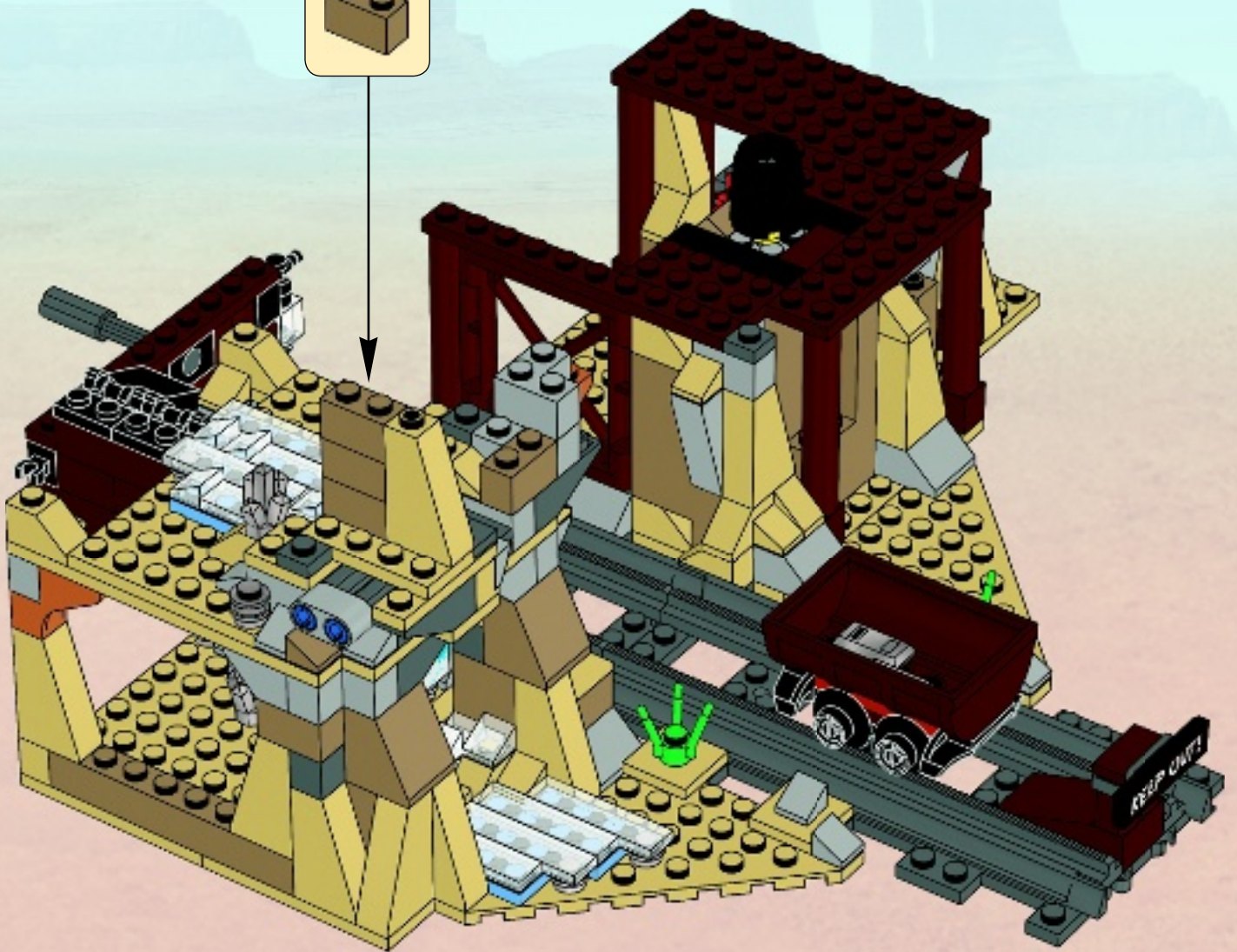
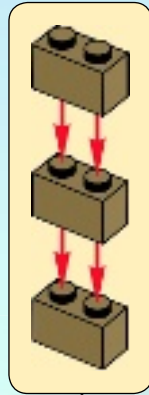



2x

# 64

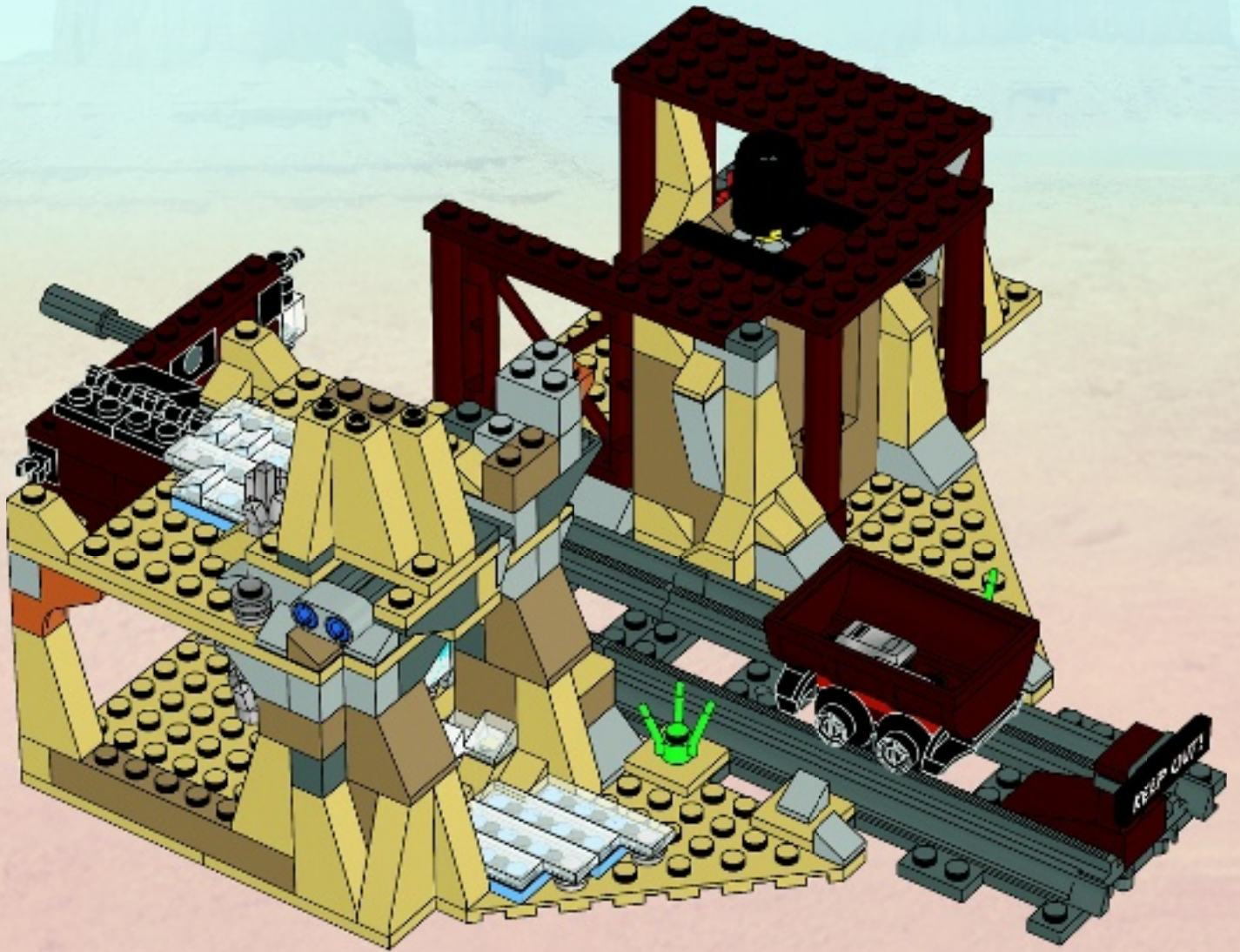



# 65



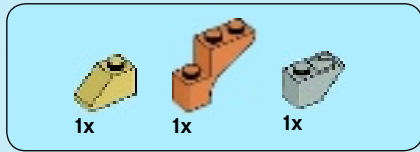

# 66

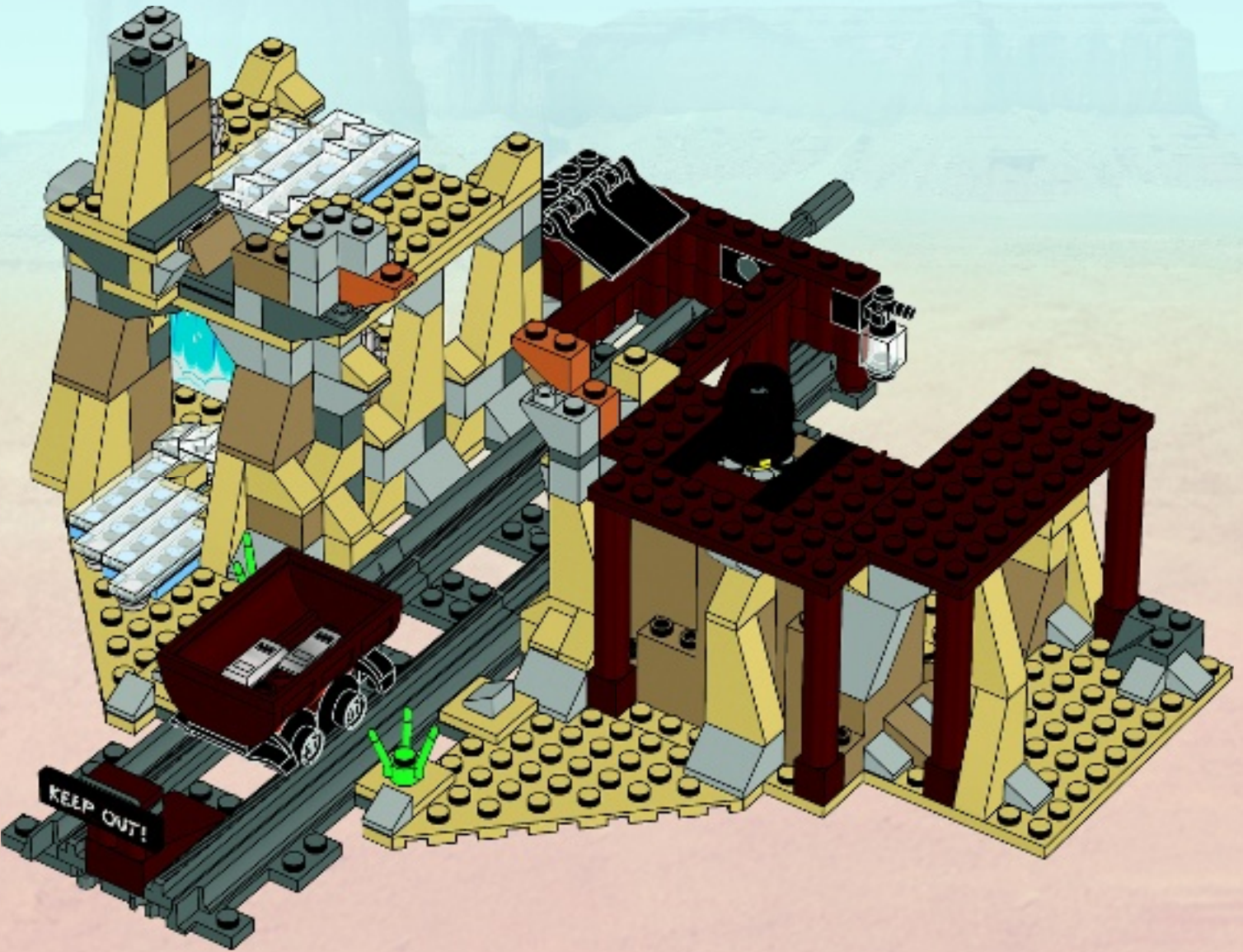
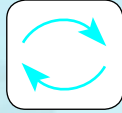





2x



1x

# 67

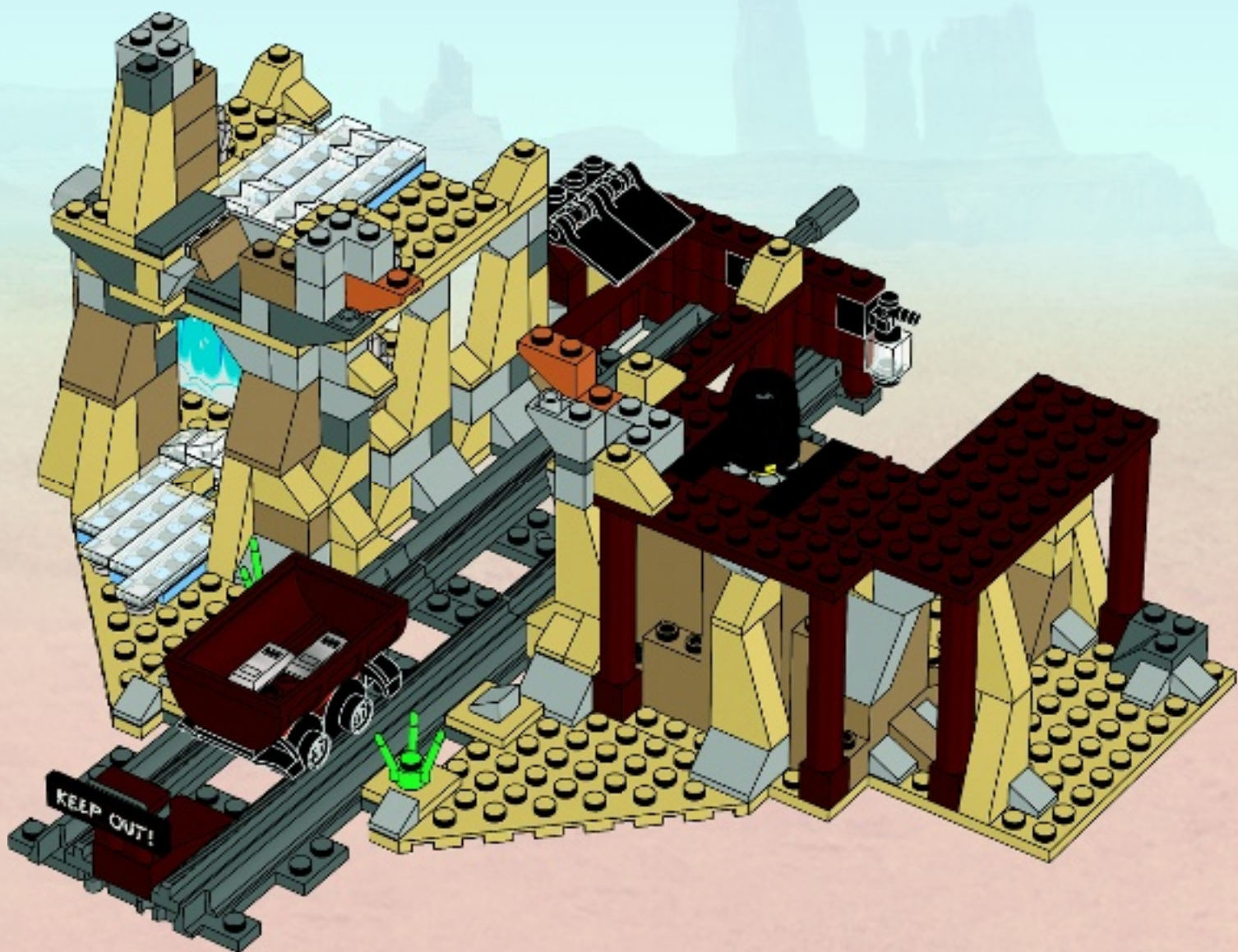



1x



1x

# 68

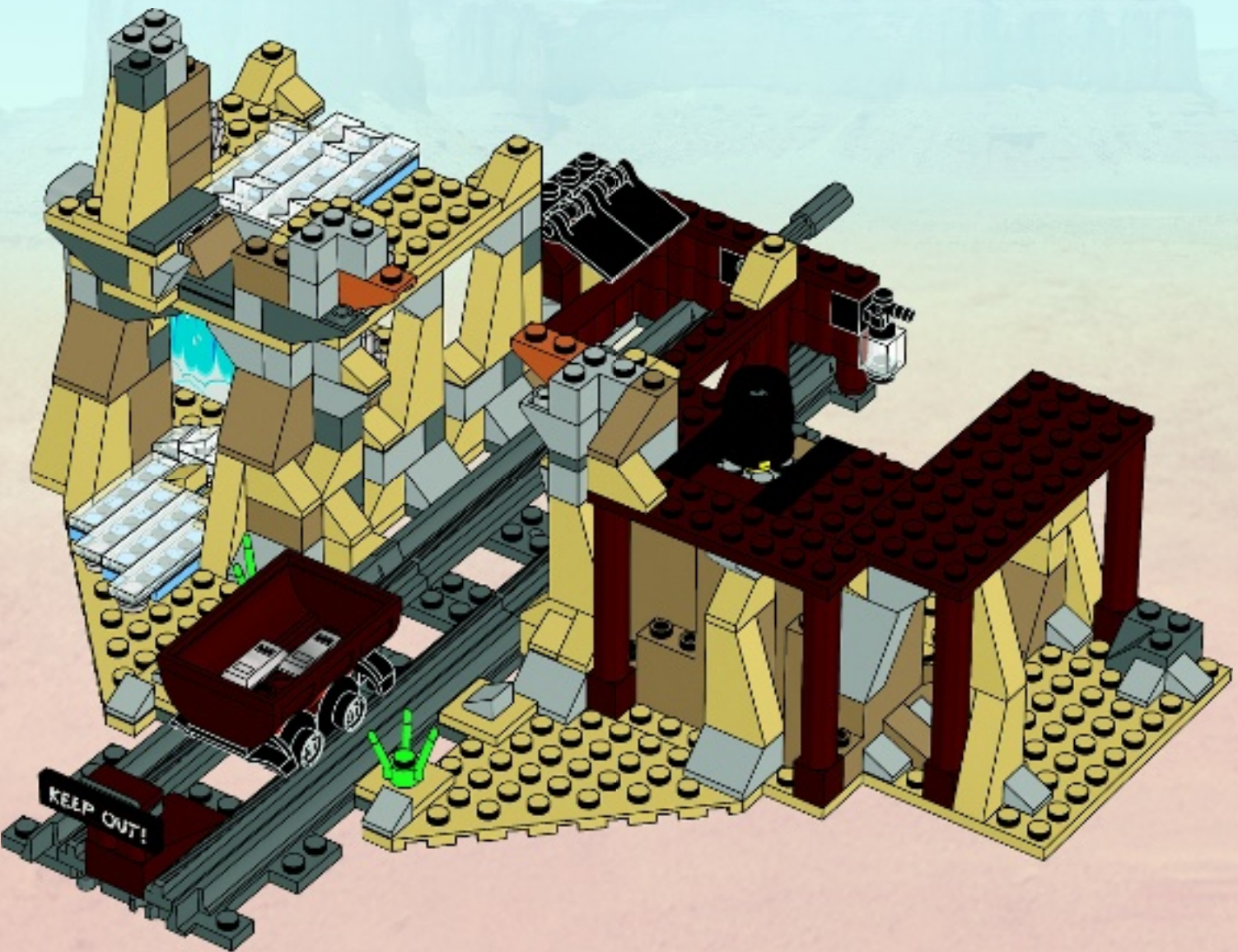

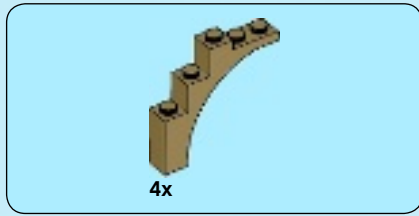

69

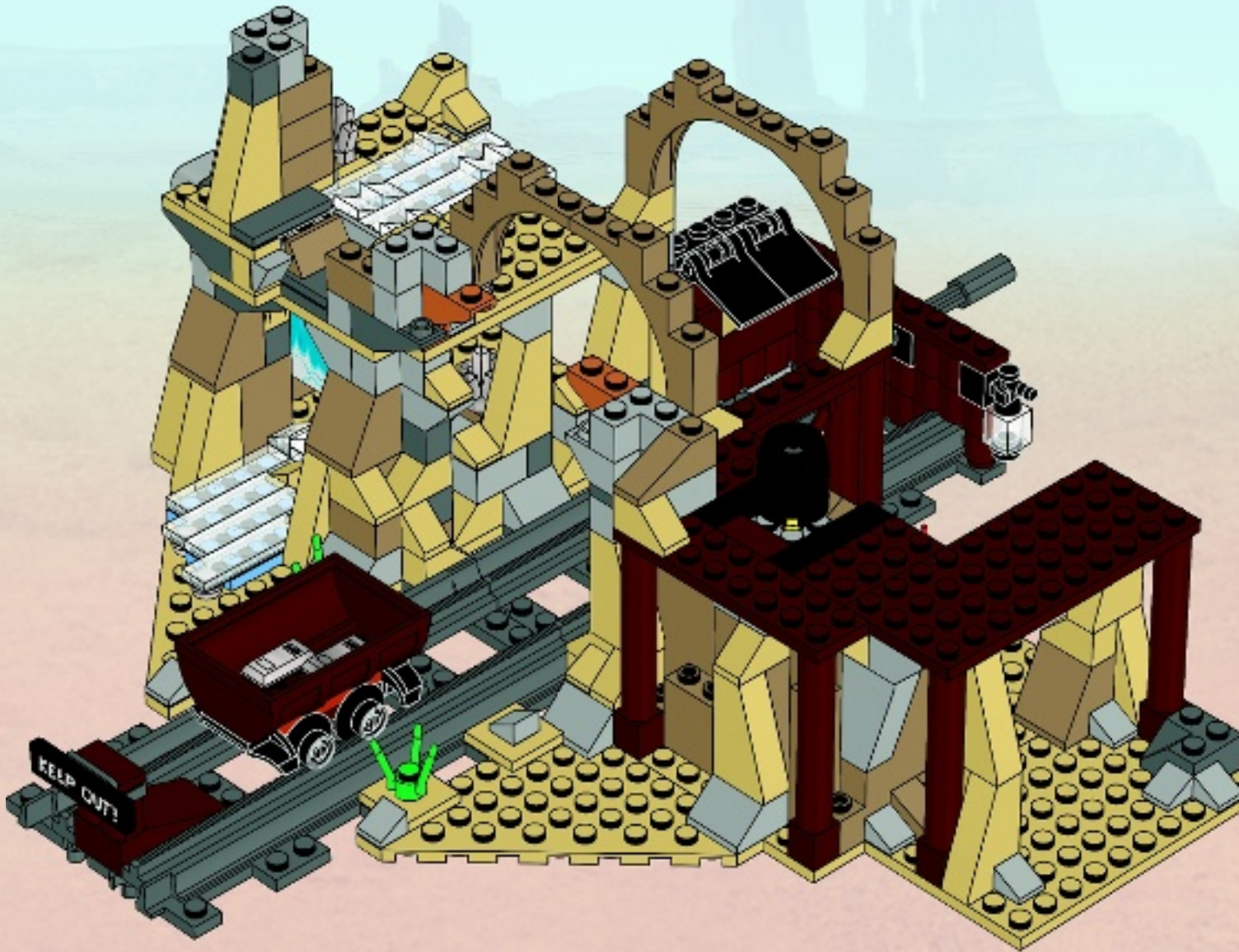

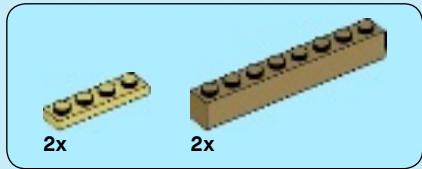

# 70

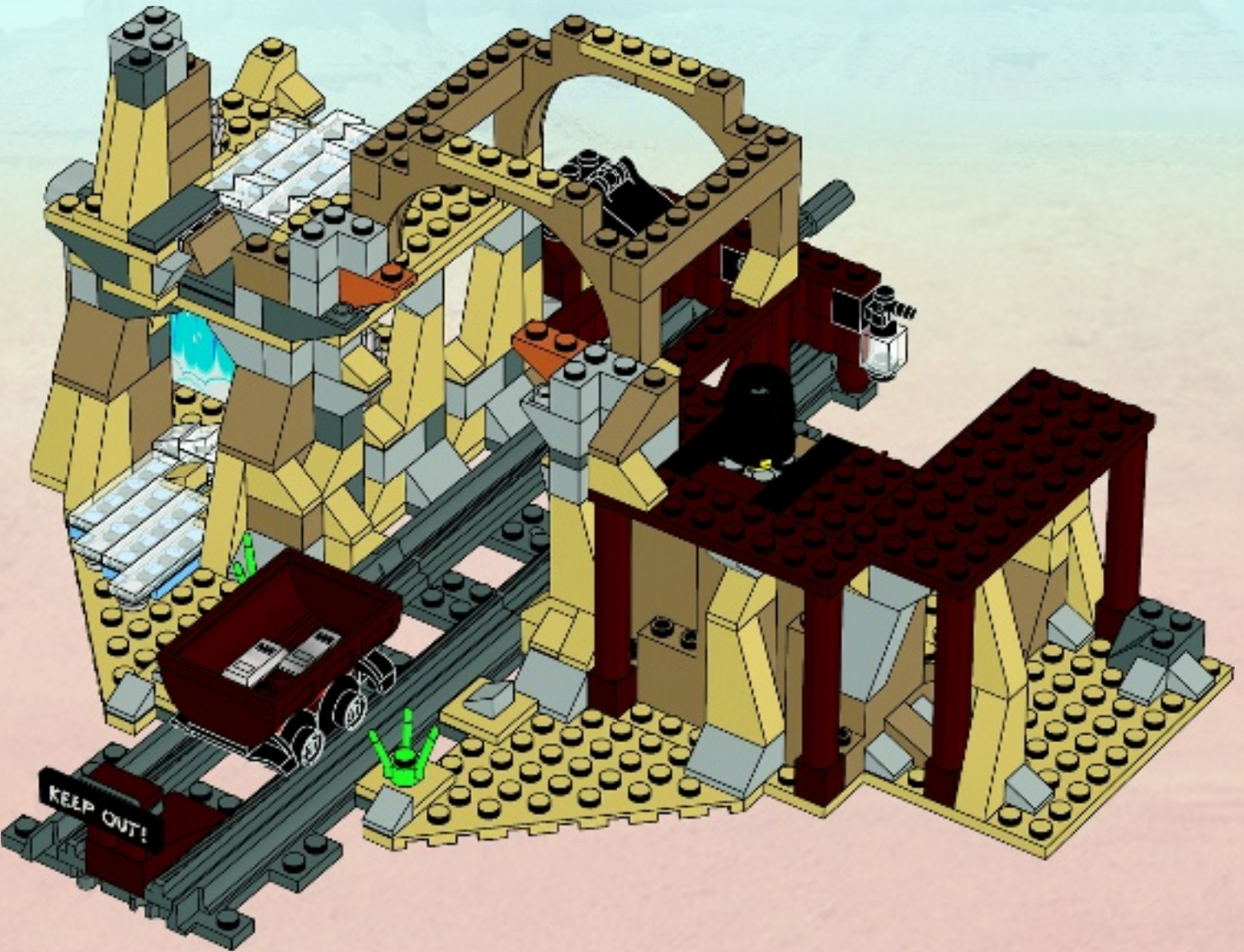



2x



1x



1x

# 71

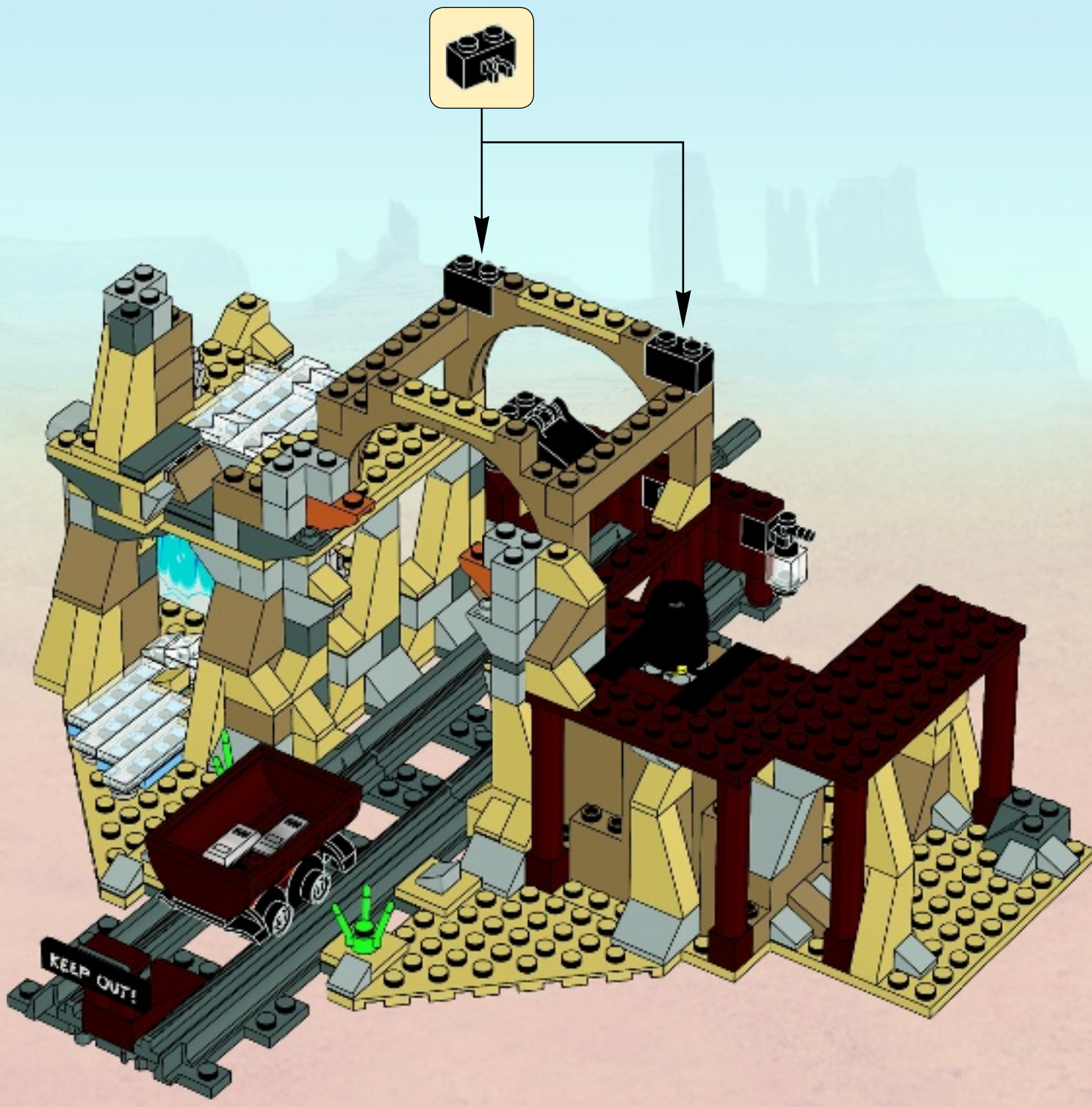

1x 1x 2x

# 72

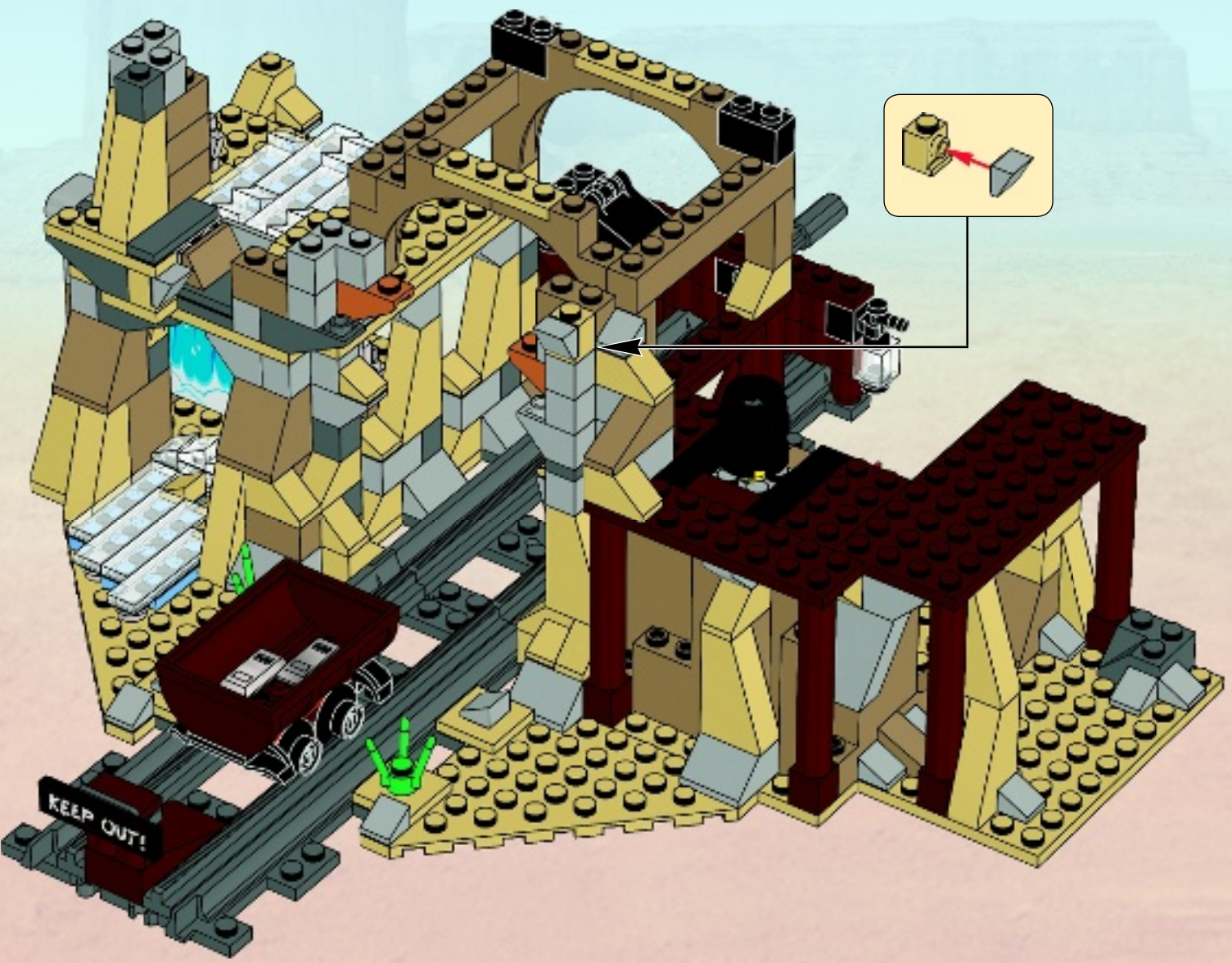



4x

# 73

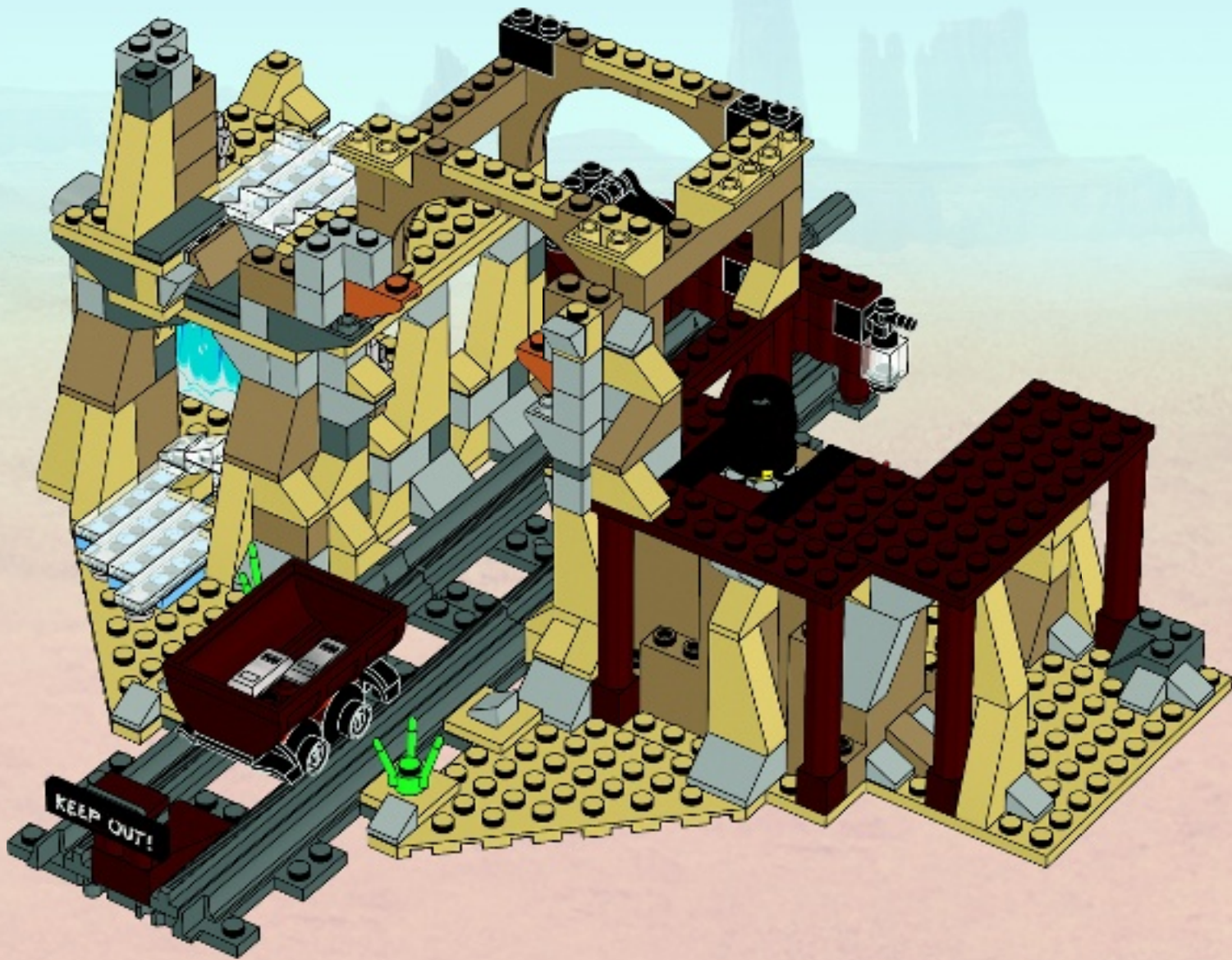

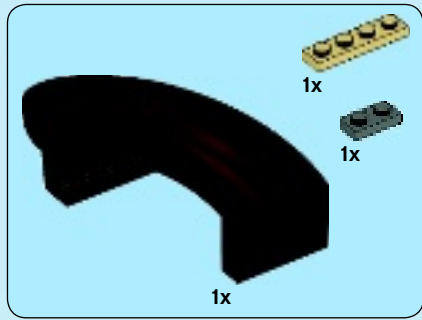

74

