



# STAR WARS

TM



7965



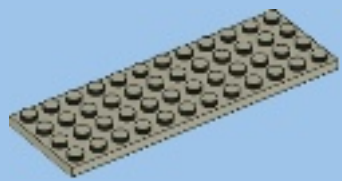

2x

67

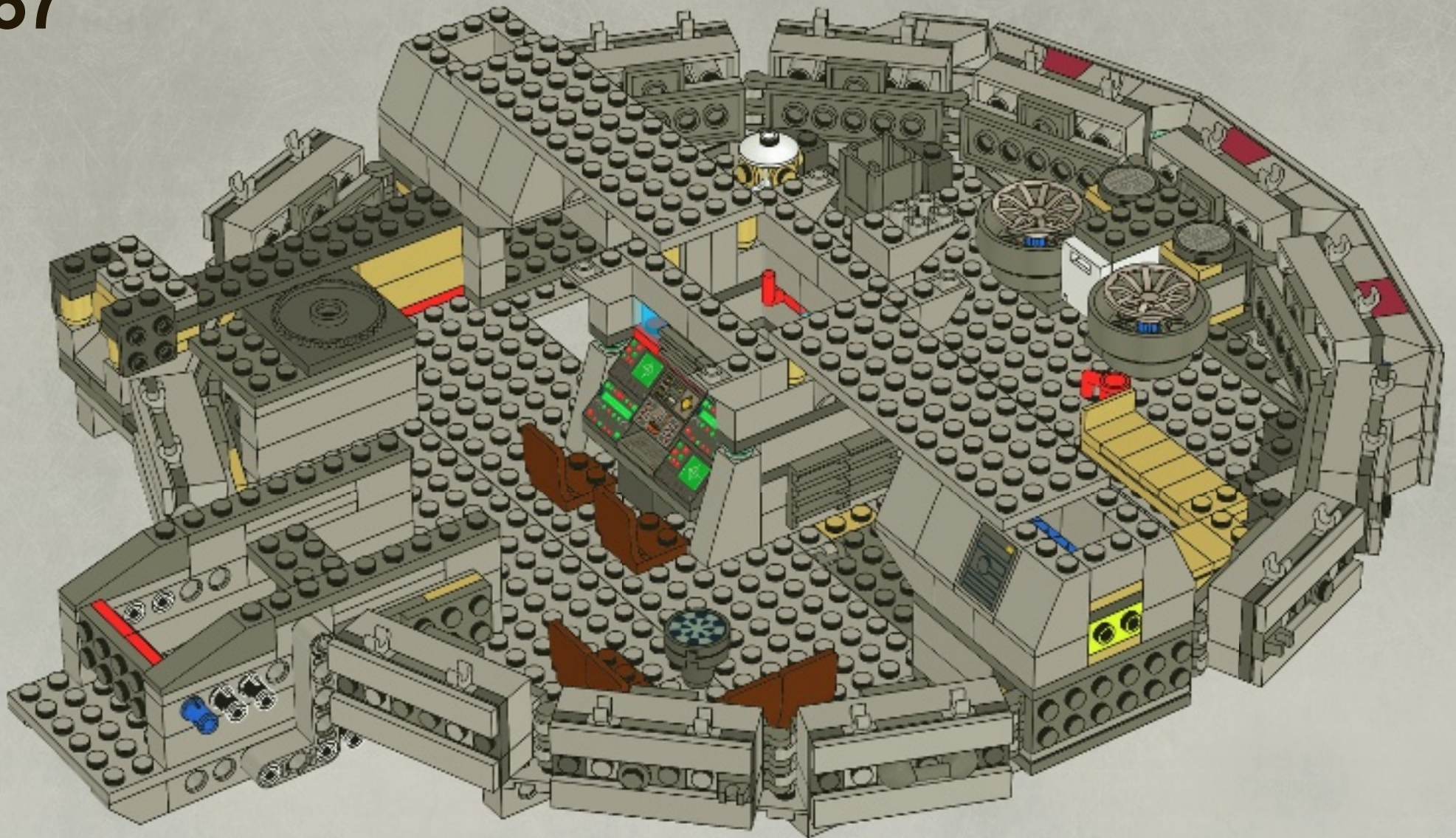

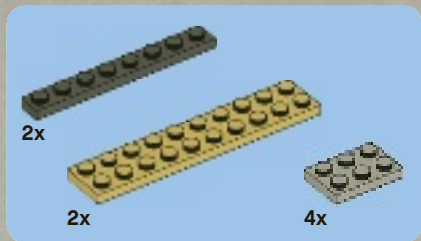

68

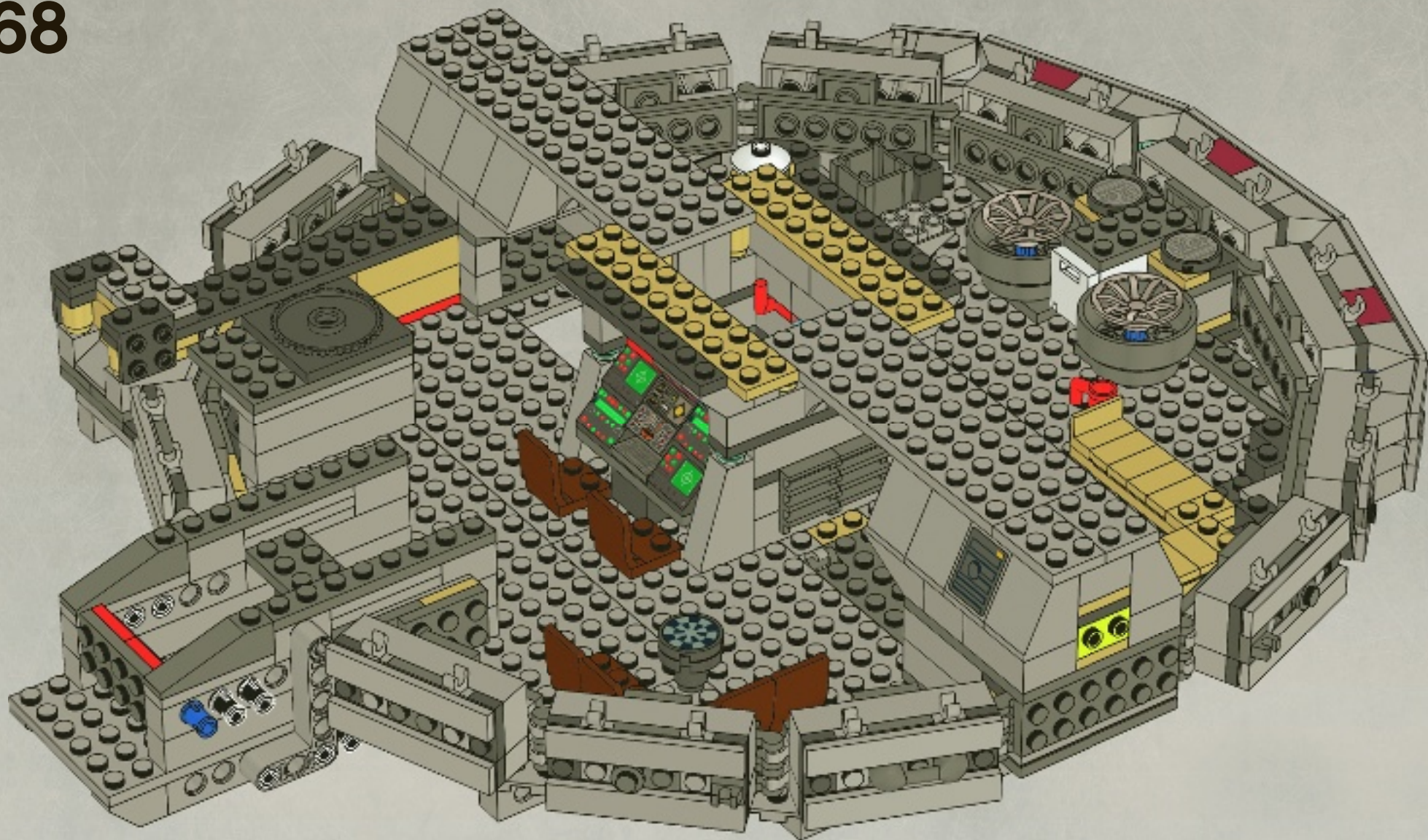

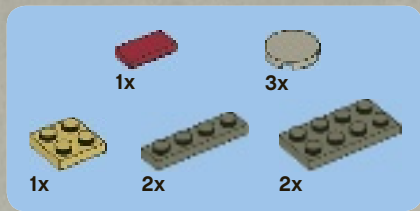

69

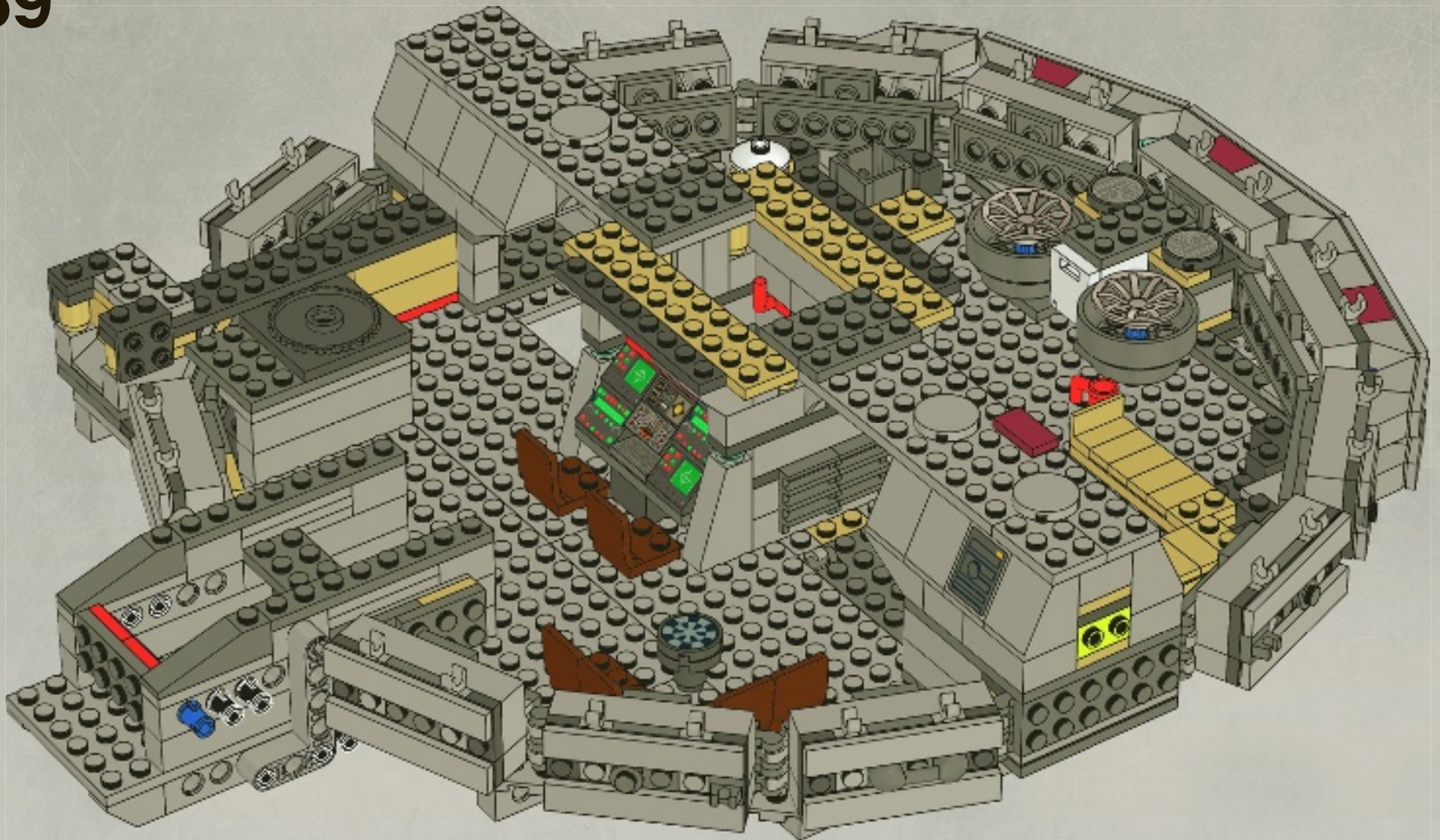

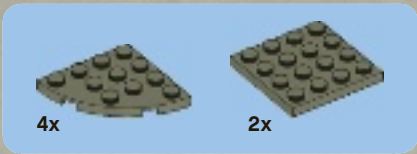

70

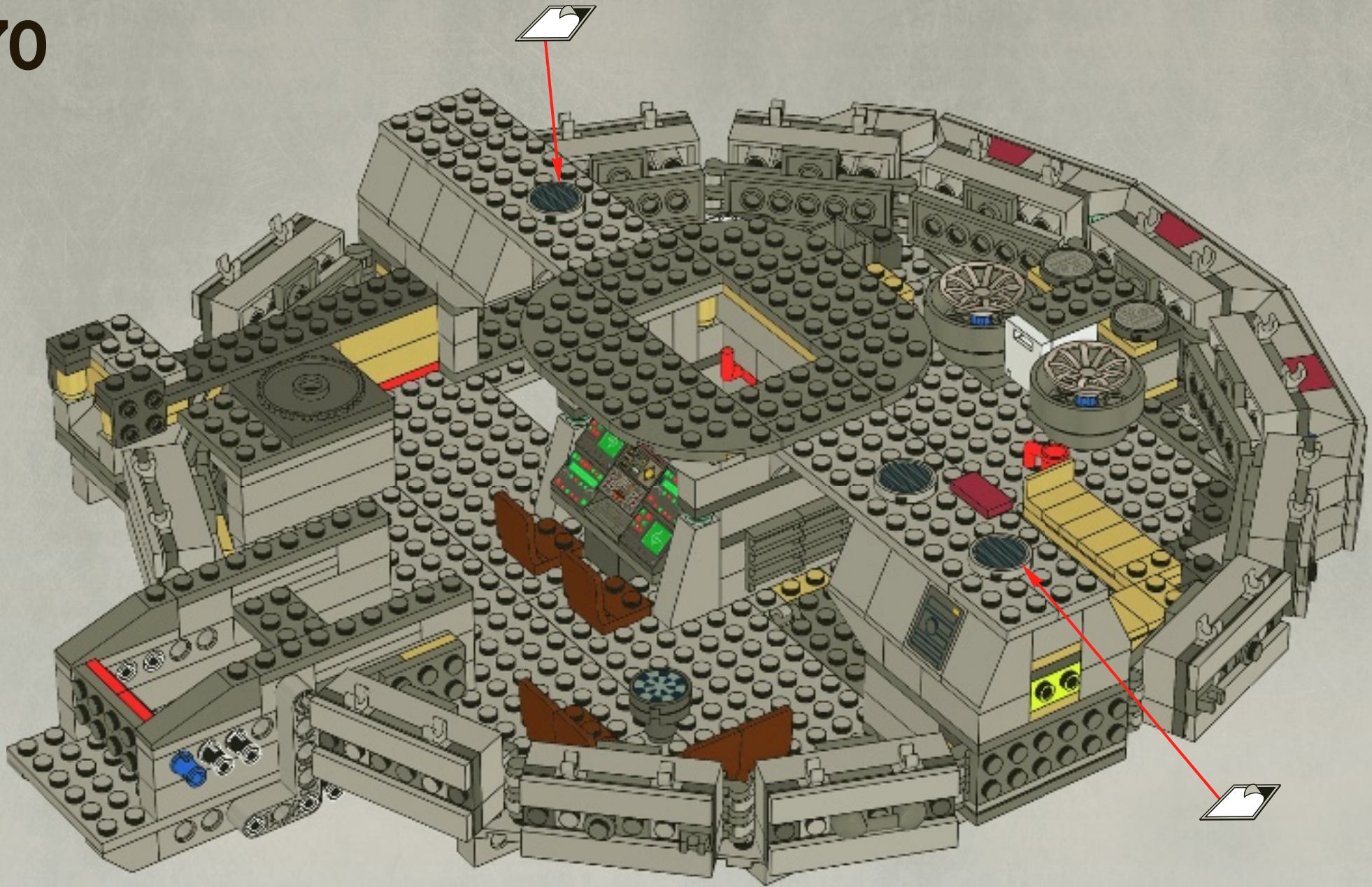

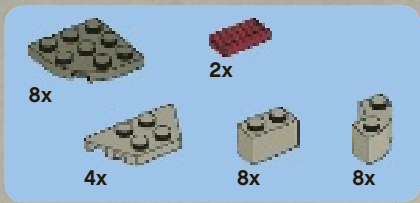

# 71

1

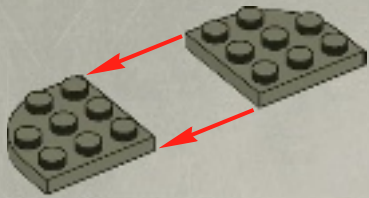

2

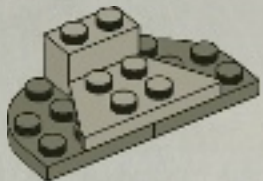

3

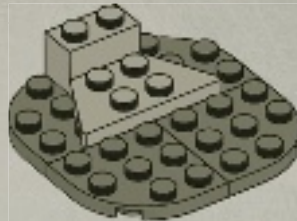

4

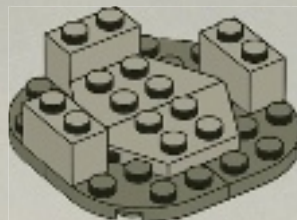

5

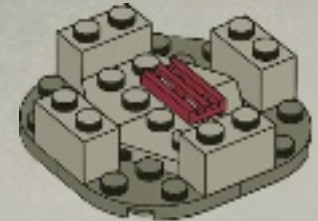

6

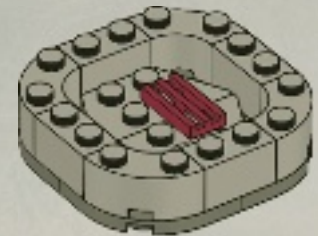

2x

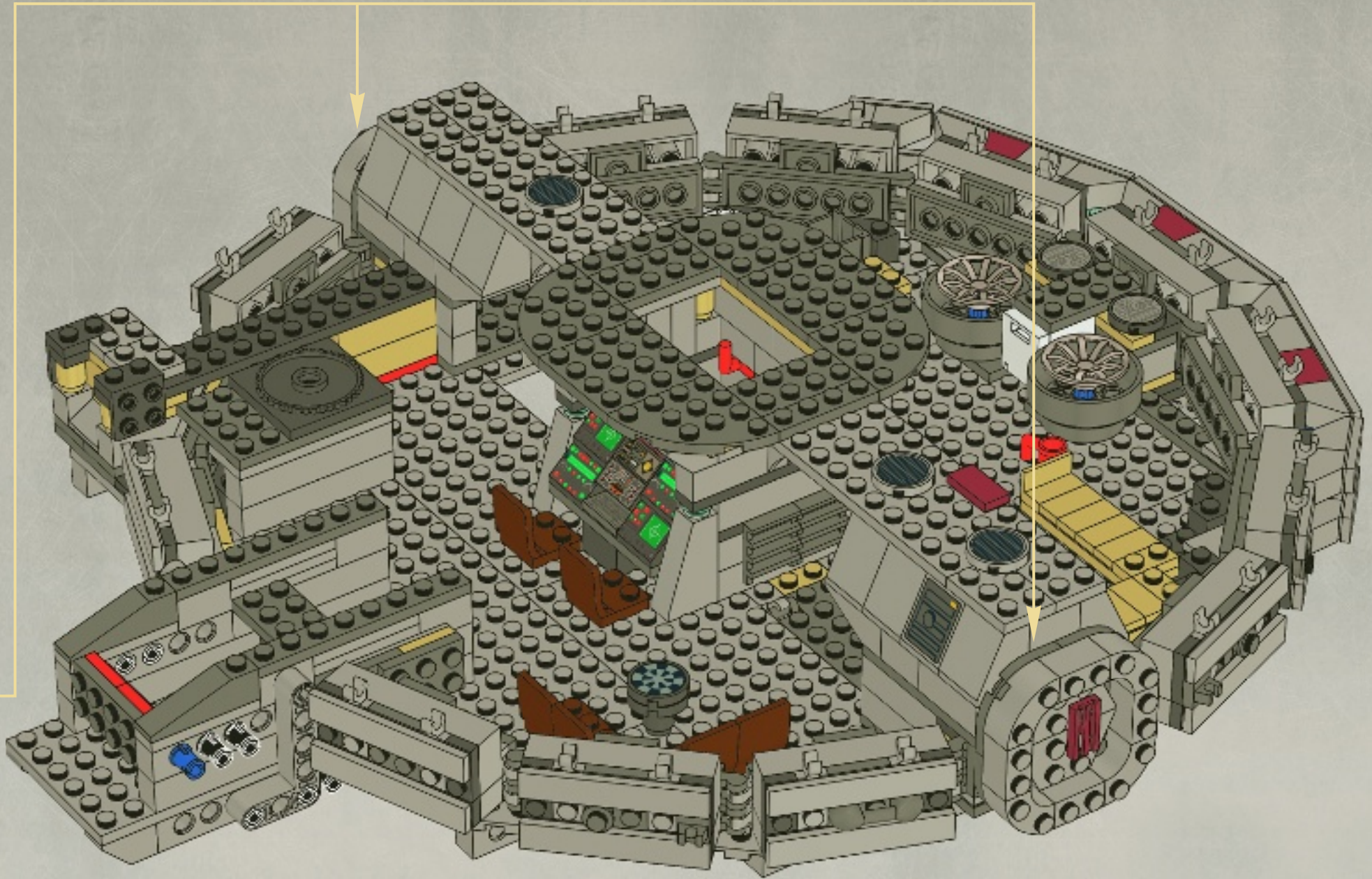

- 1x
- 1x
- 1x
- 1x
- 2x
- 1x

72

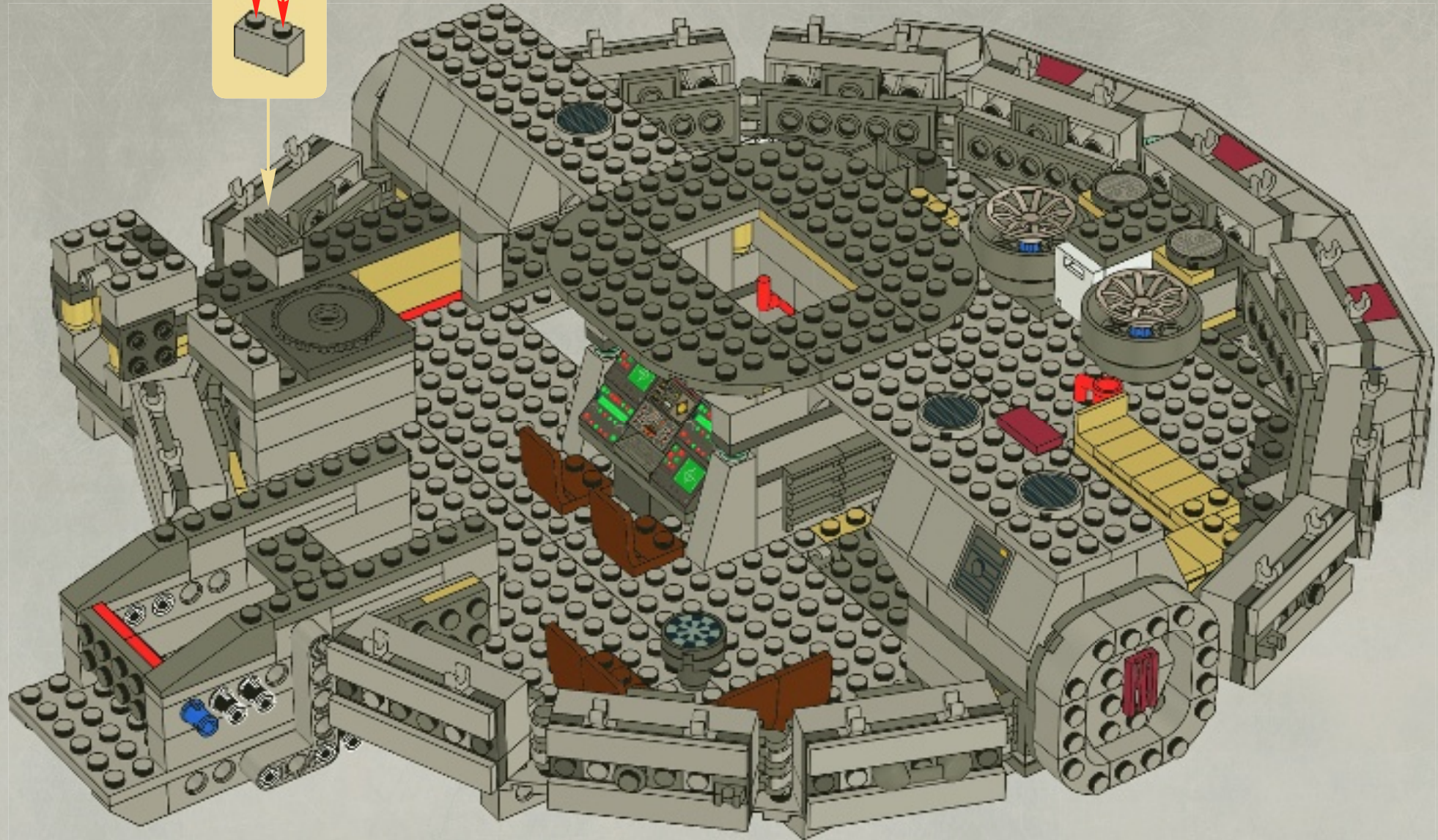
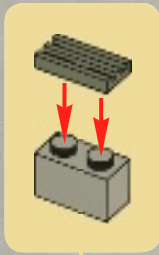





2x



1x



1x

# 73

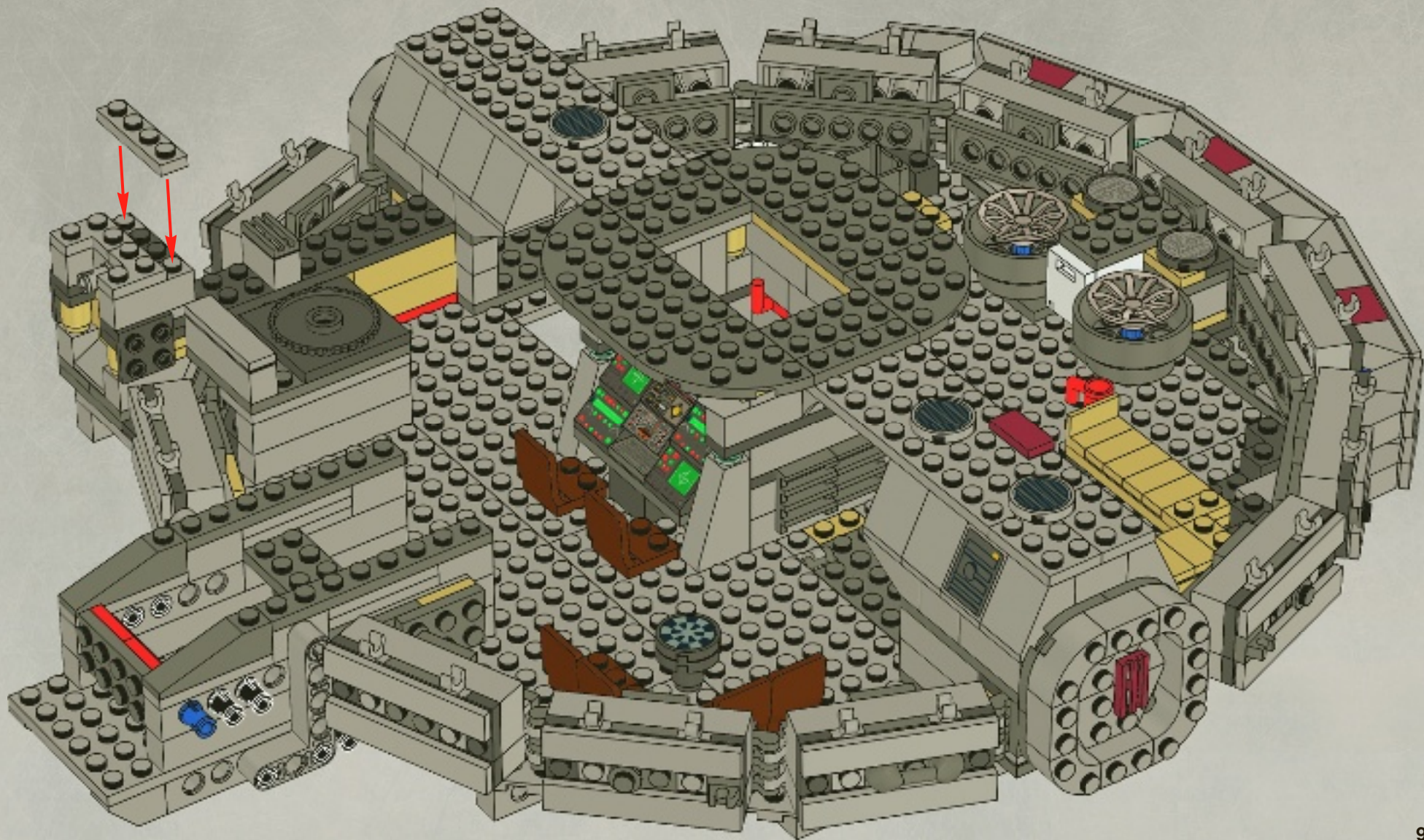



2x



2x



1x

# 74

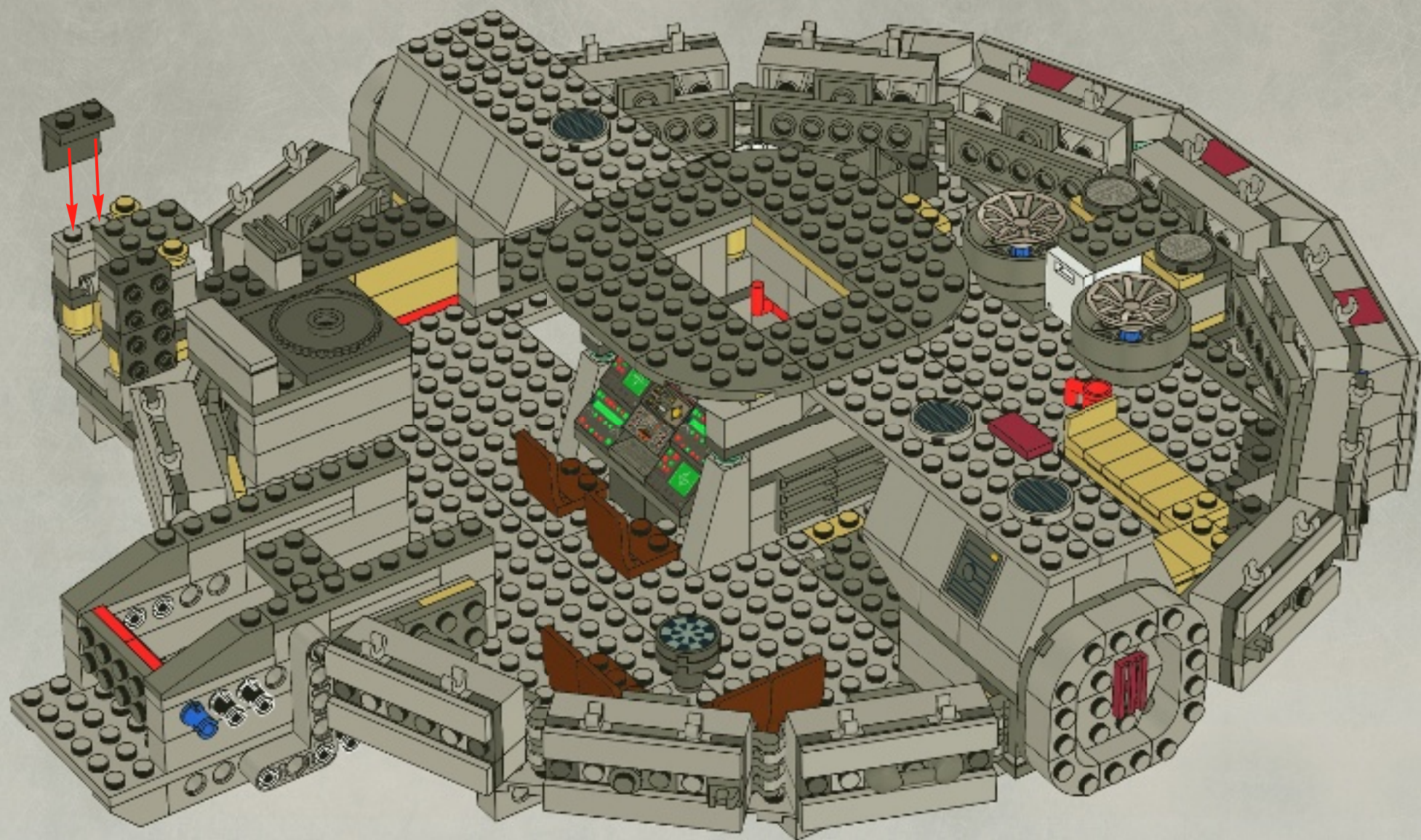



1

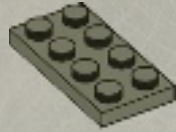

2

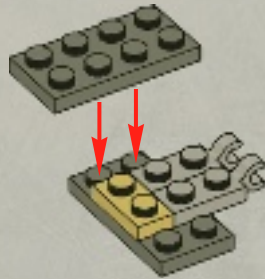

3

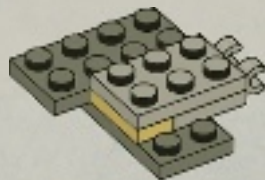

4

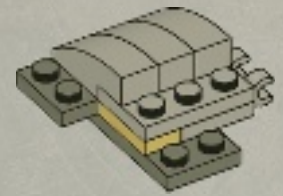

5

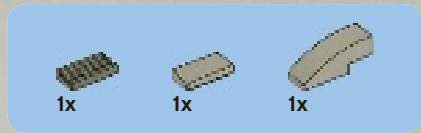
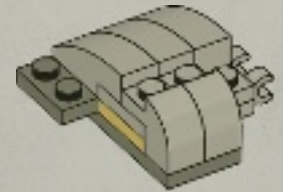

6

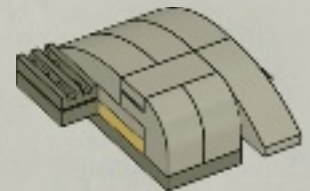

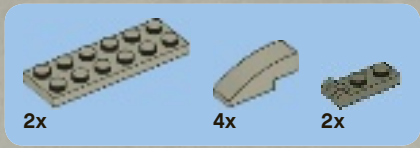

7

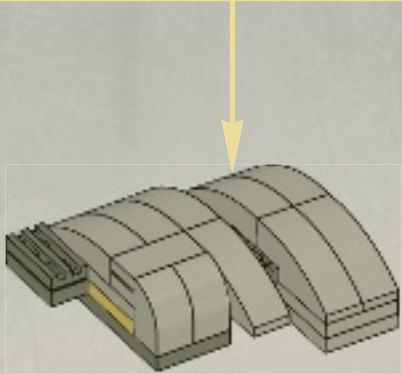
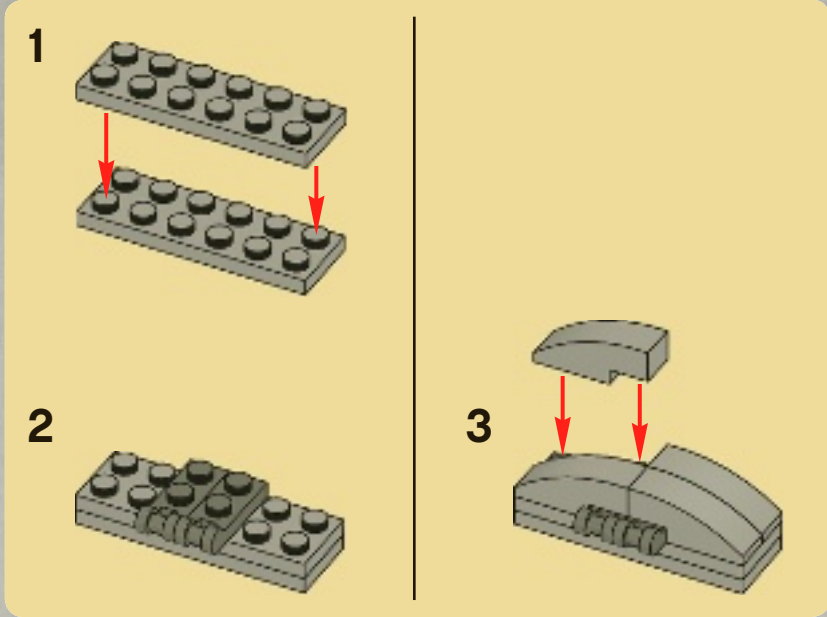

8

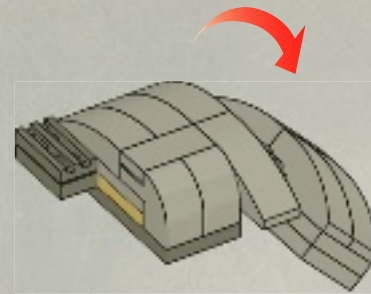

75

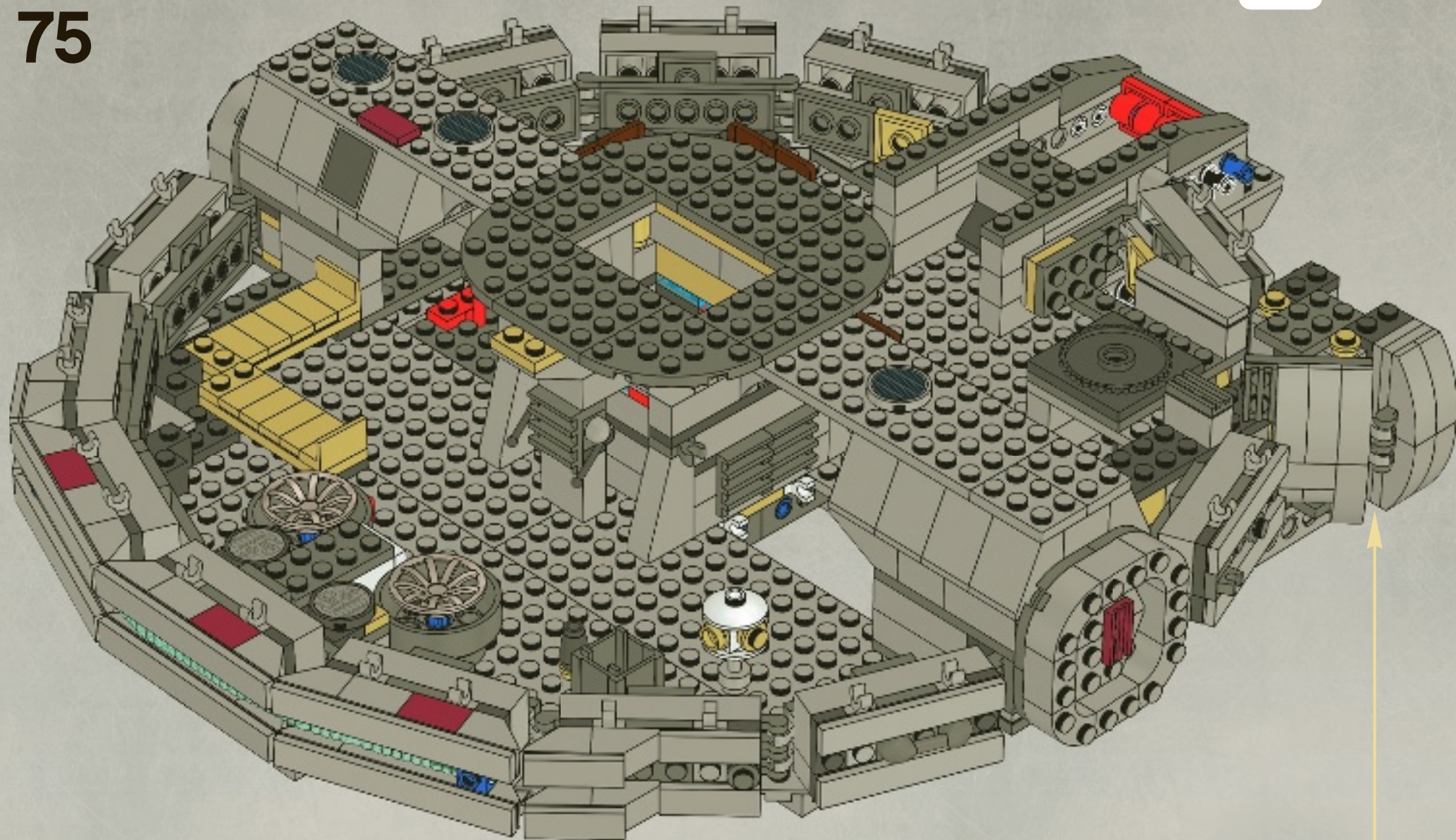



# 76

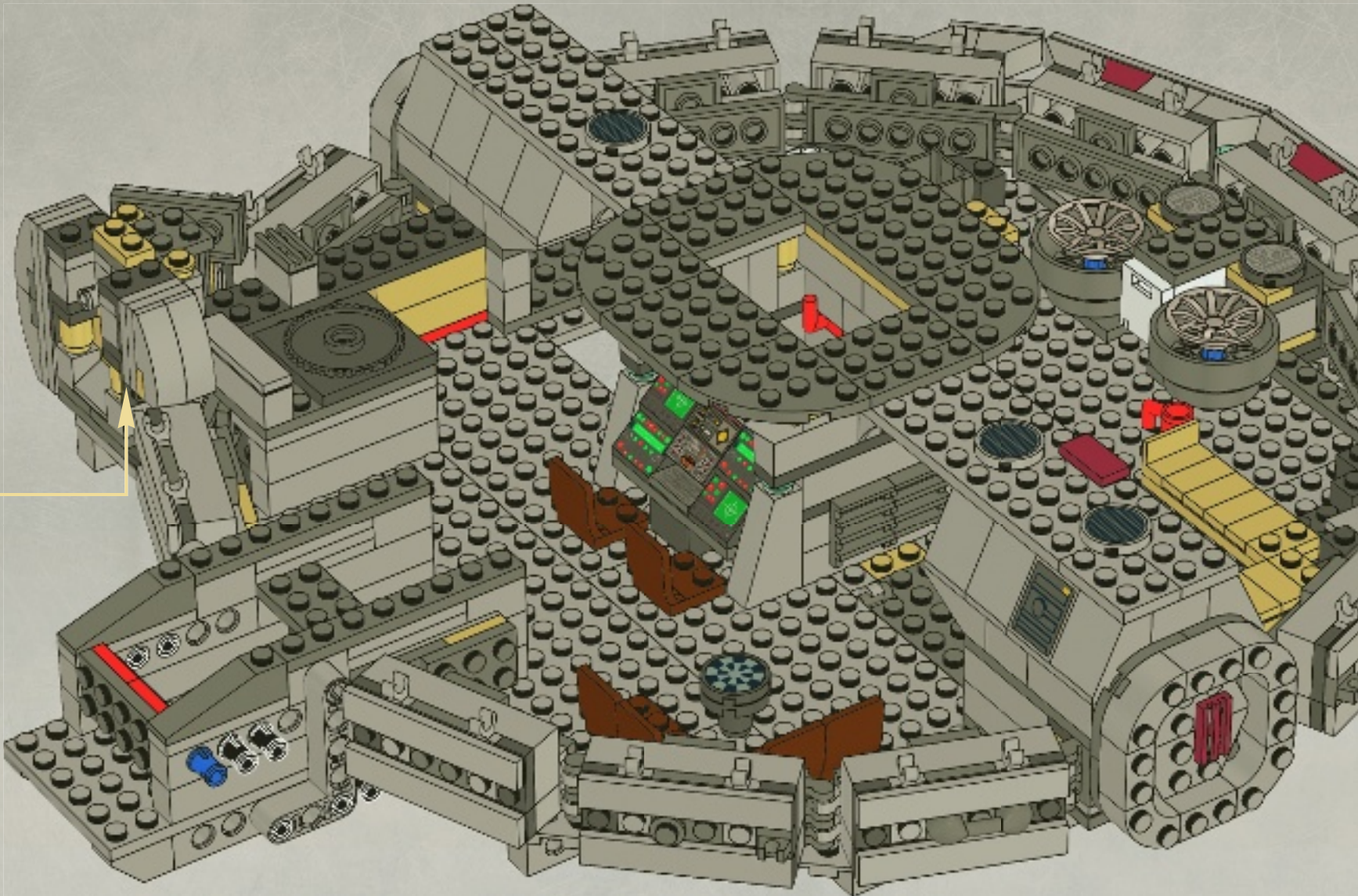
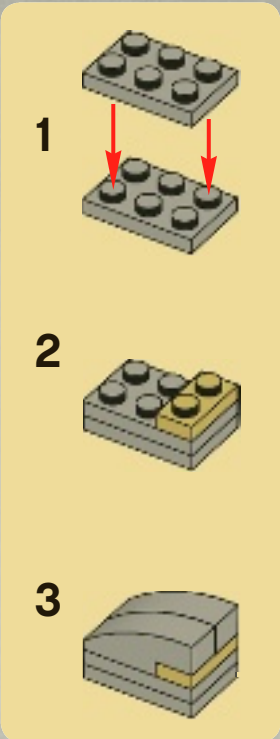



77

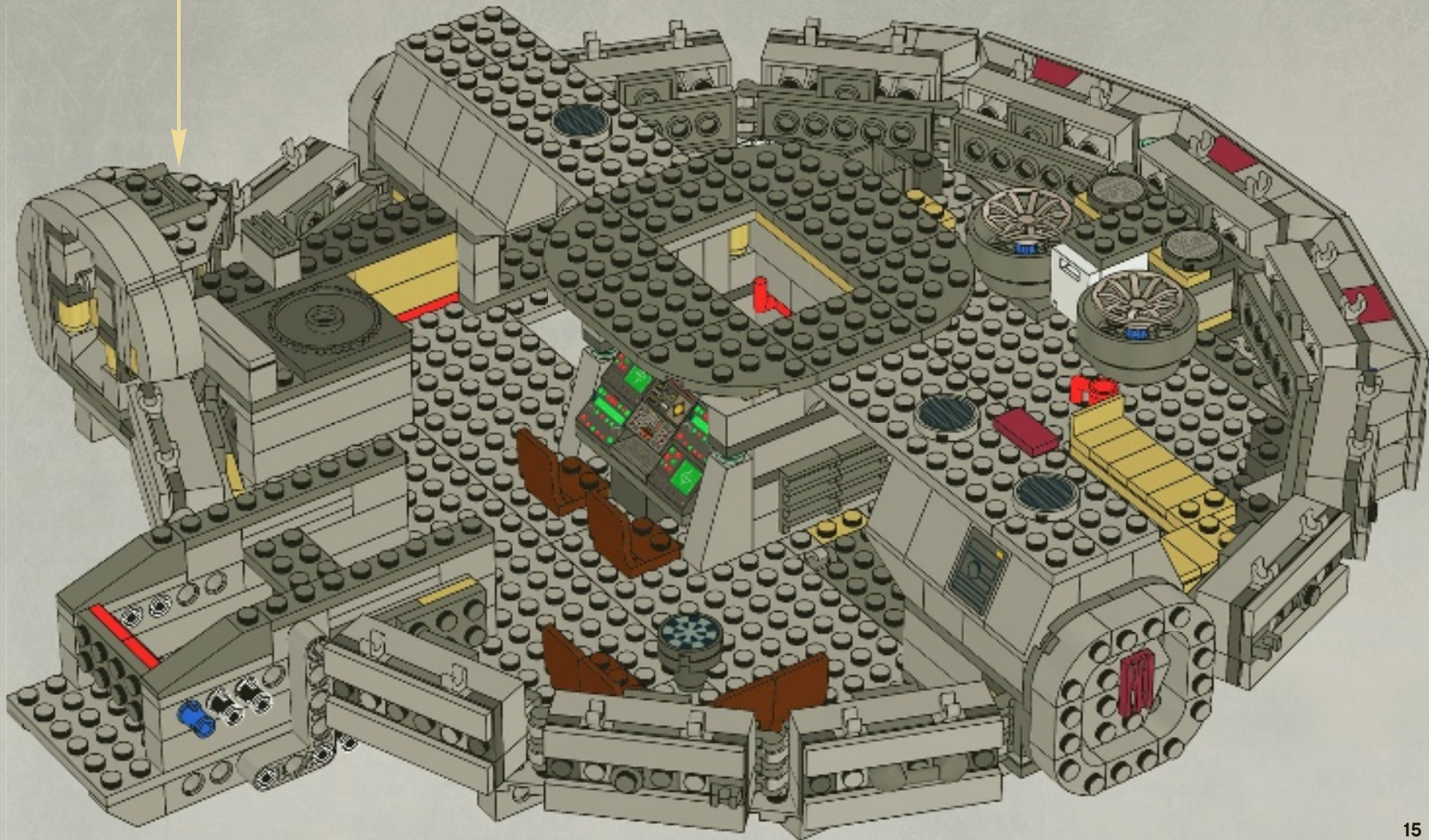

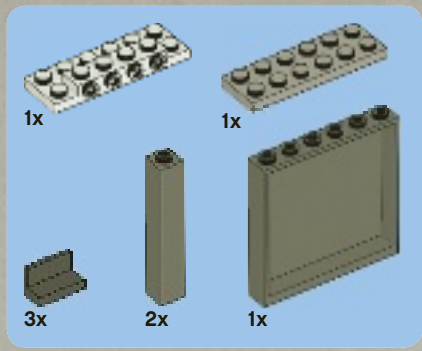

78

1

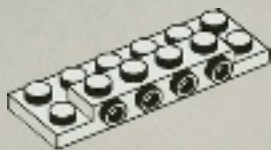

2

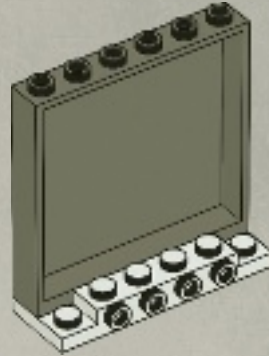

3

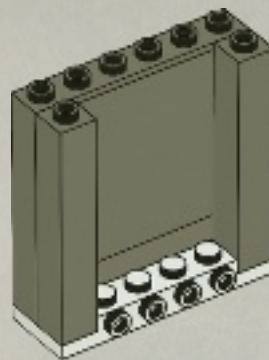

4

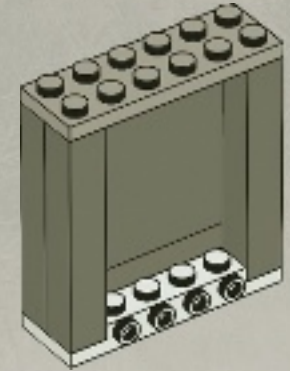

5

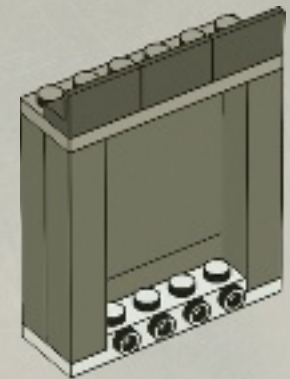



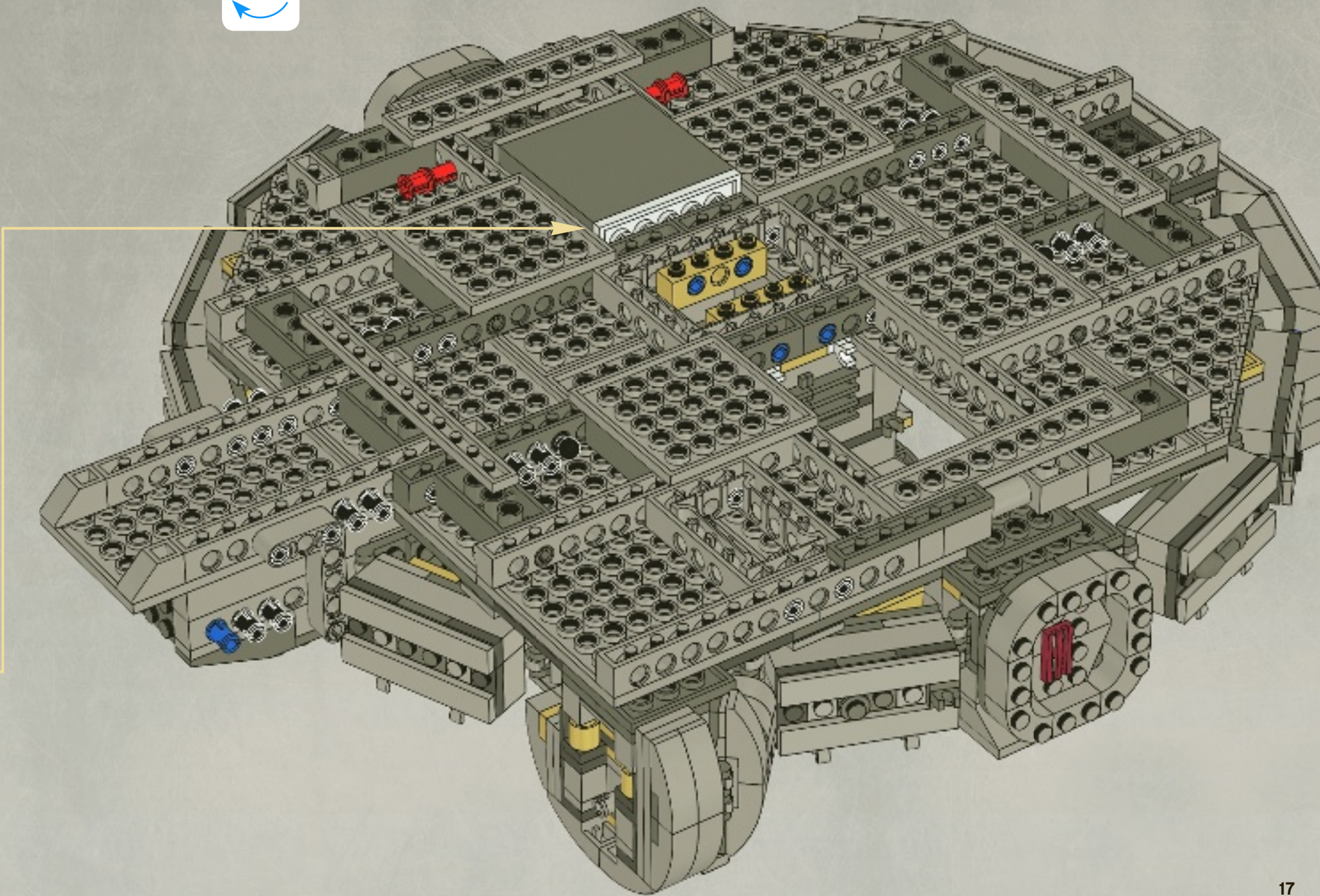

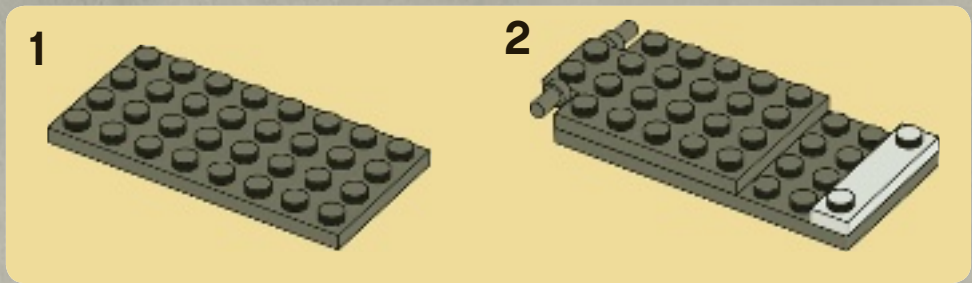
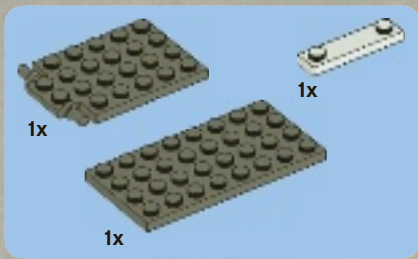

79

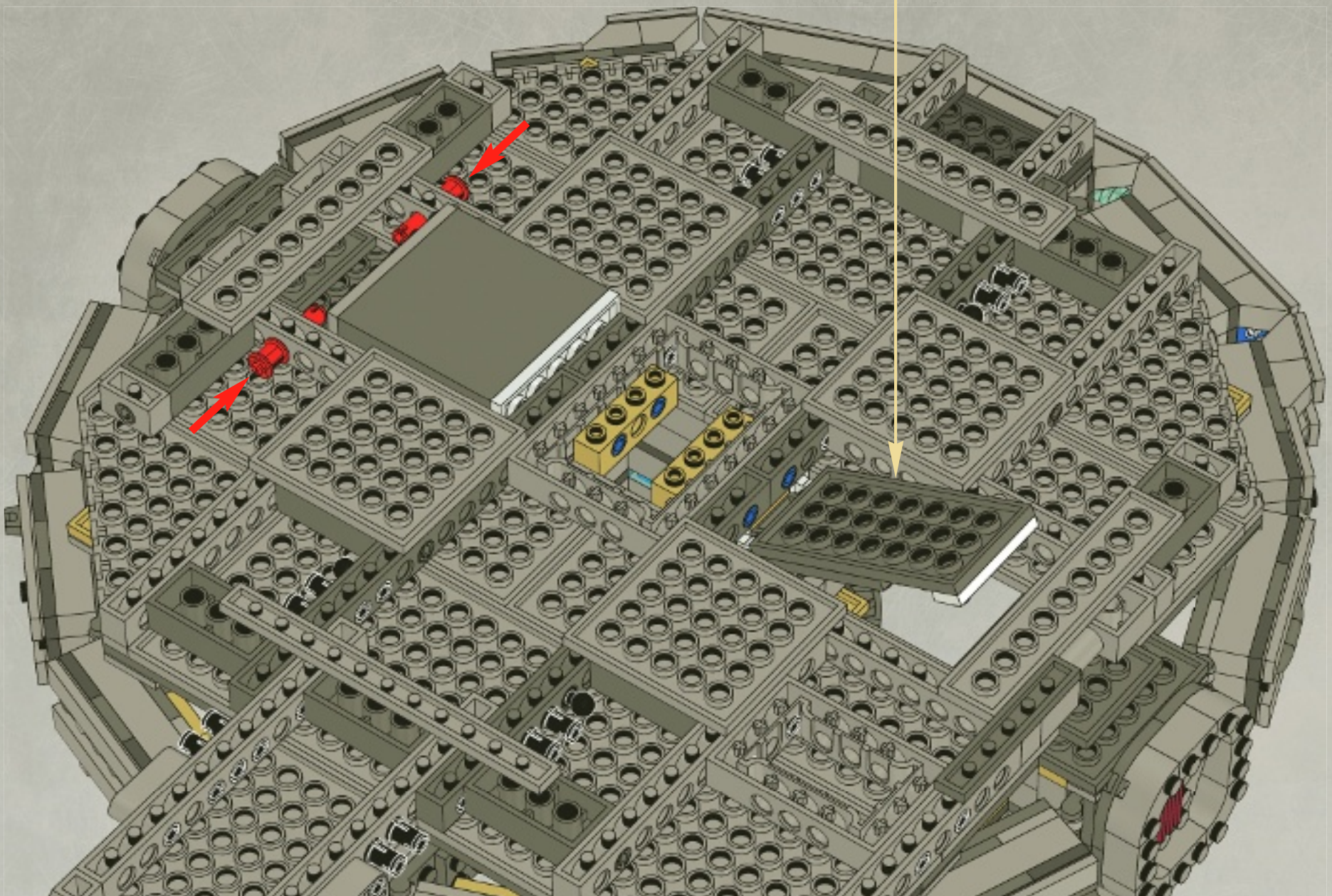

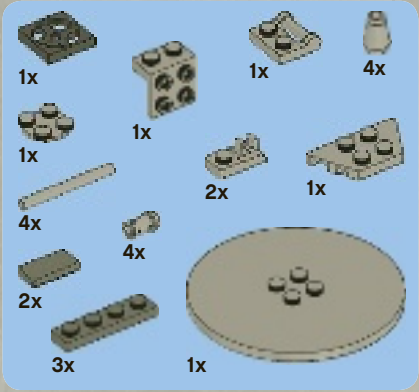

80

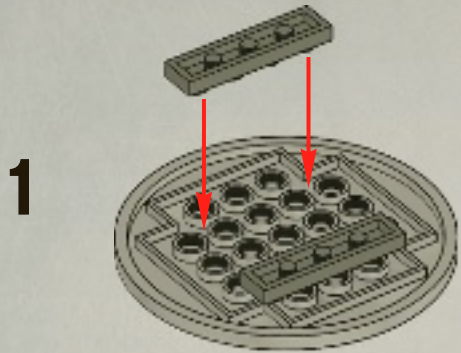

2

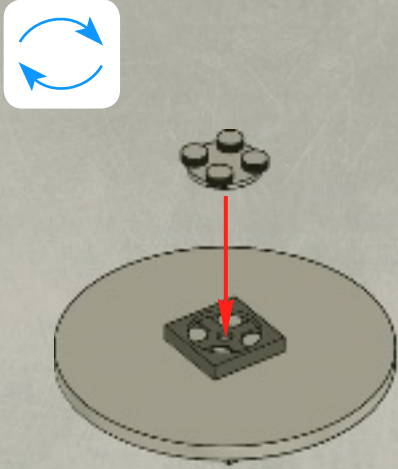

3

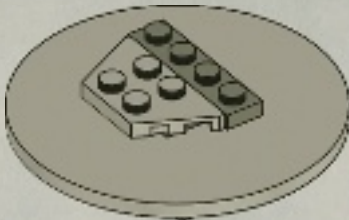

4



5



1

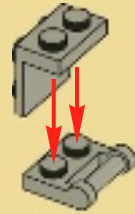

2

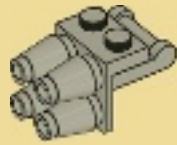

3

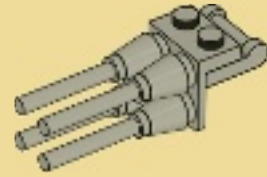

4

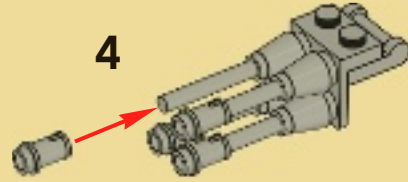

6

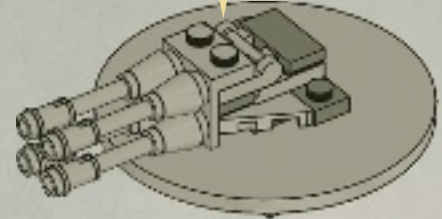

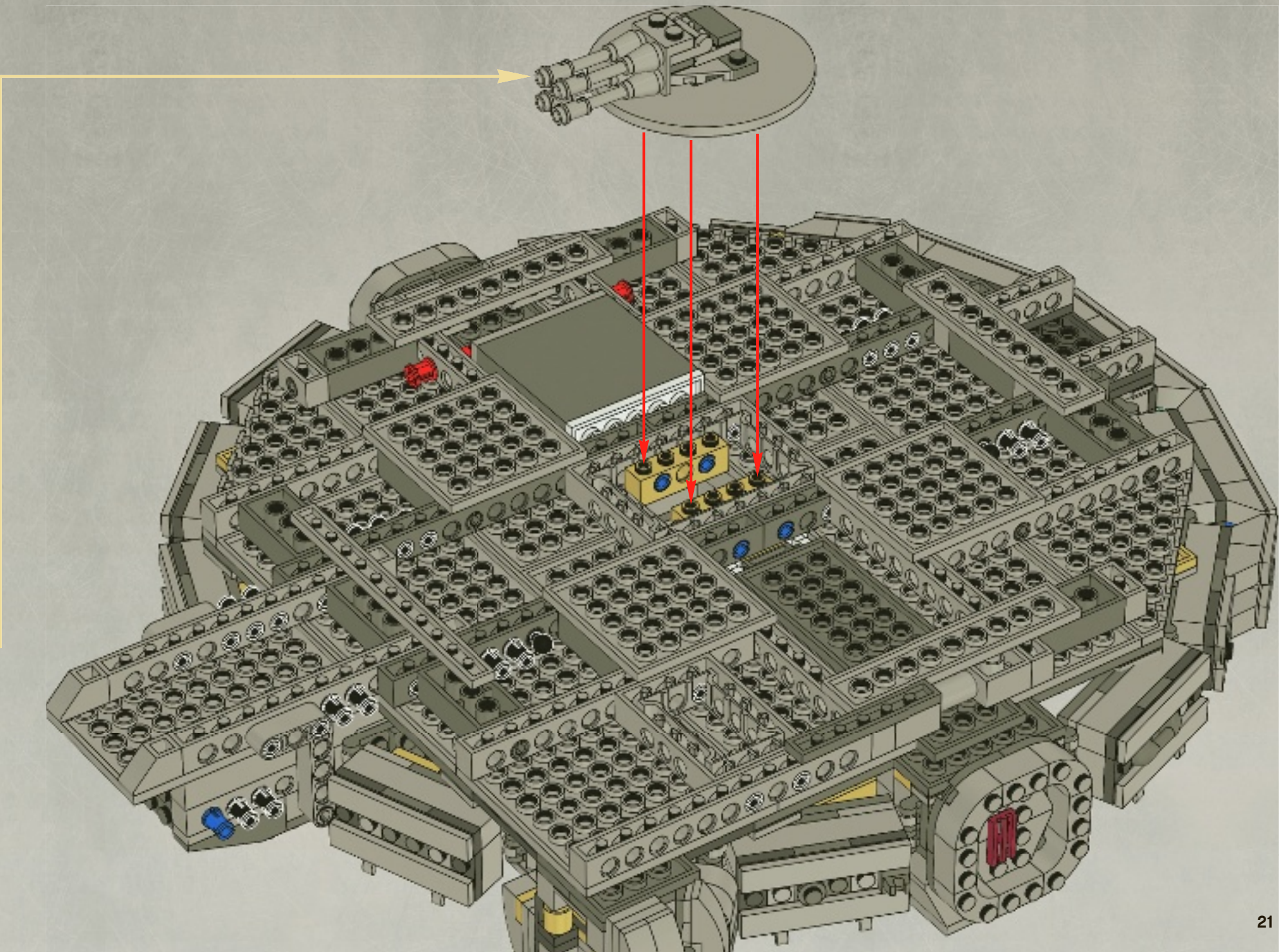

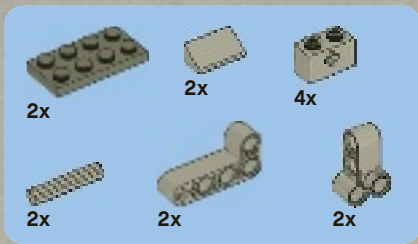

# 81

1

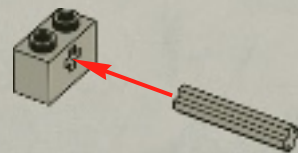

2

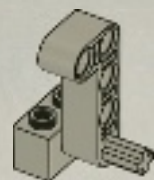

3

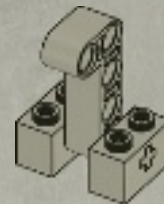

4

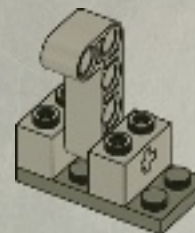

5

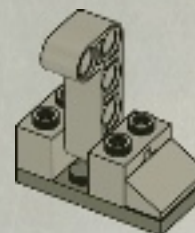

2x

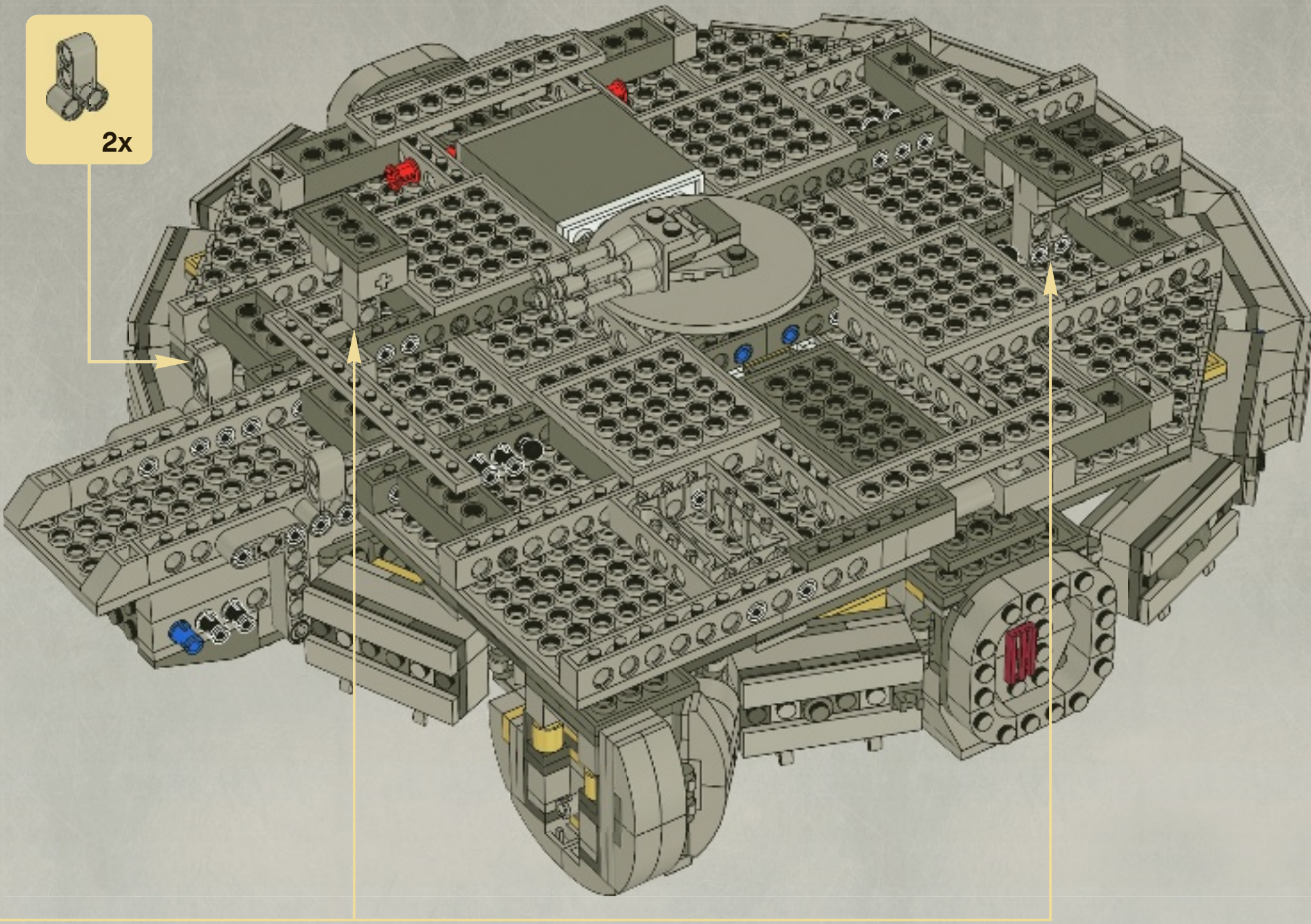
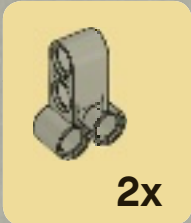

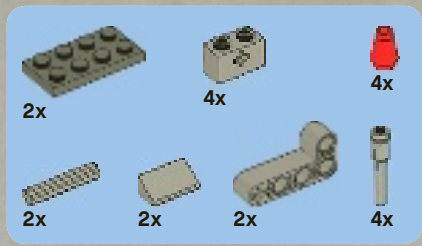

# 82

1

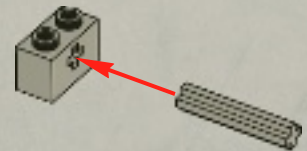

2

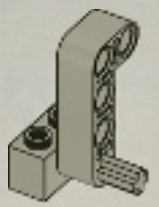

3

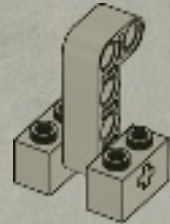

4

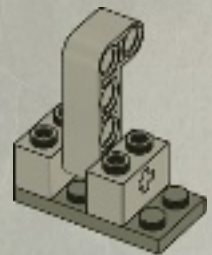

5

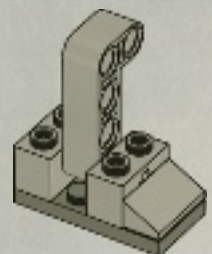

2x



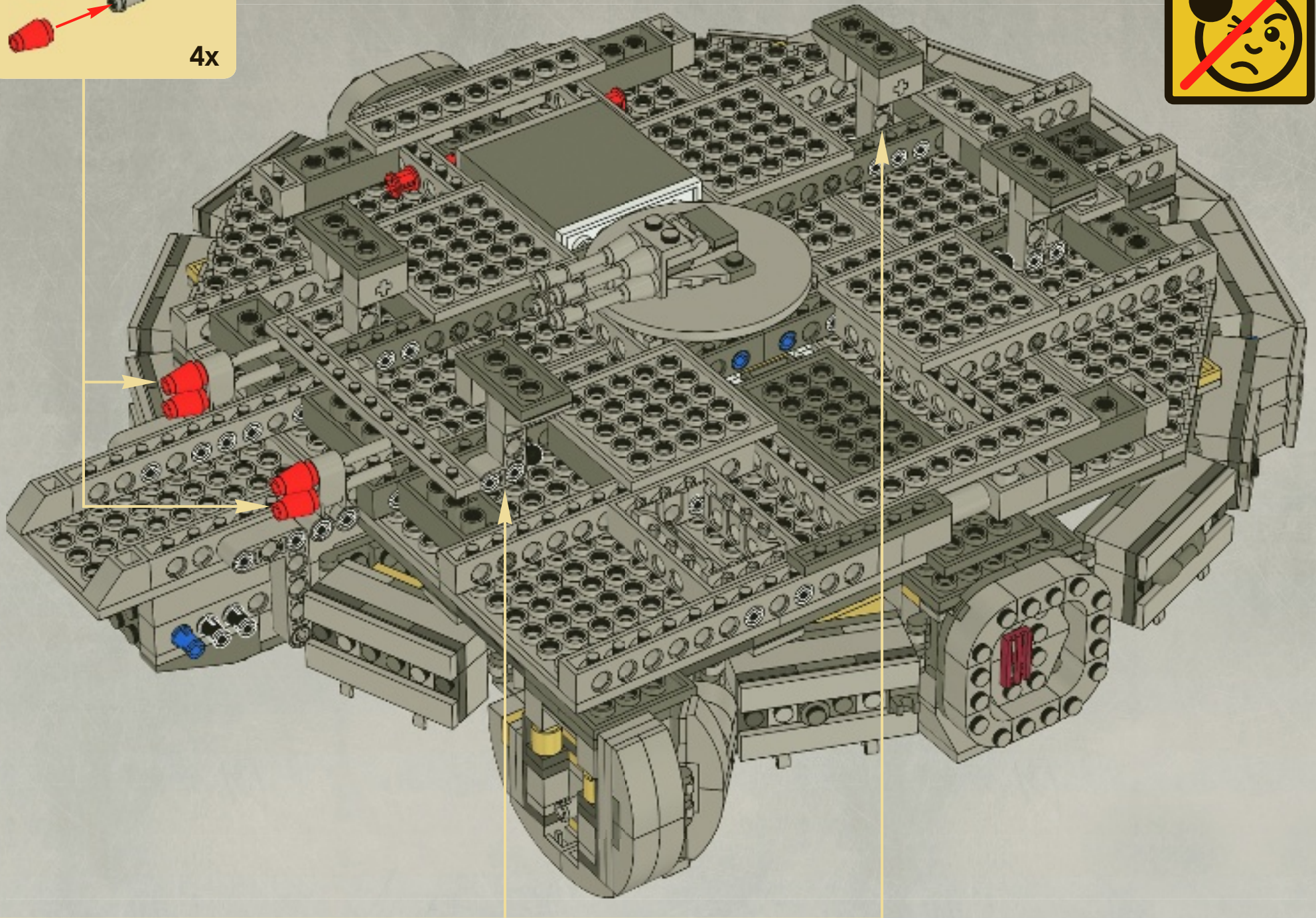
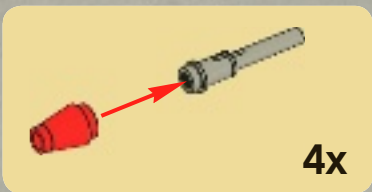



83

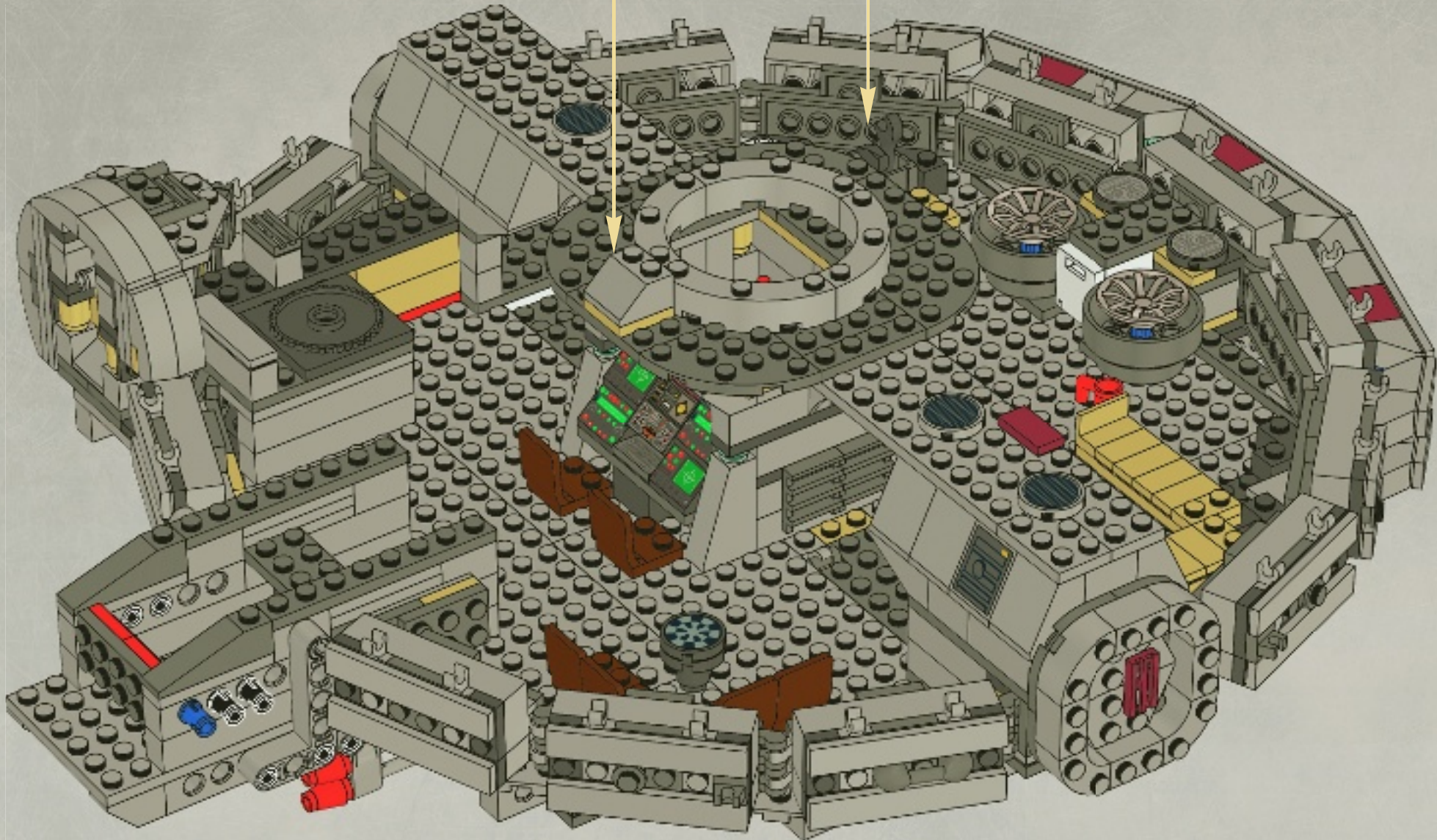
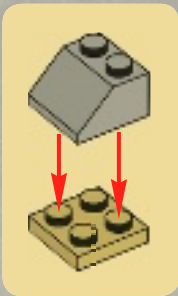

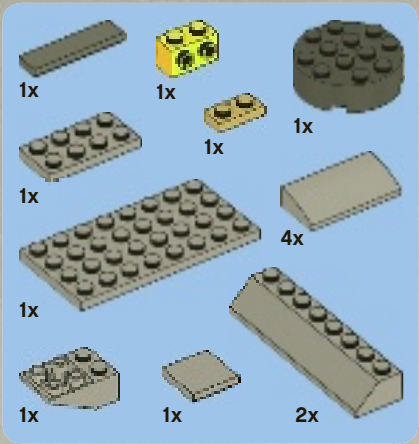

84

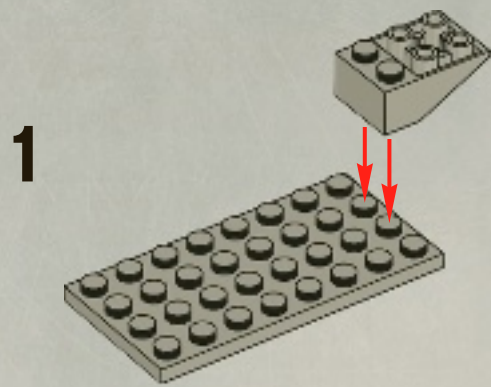

2

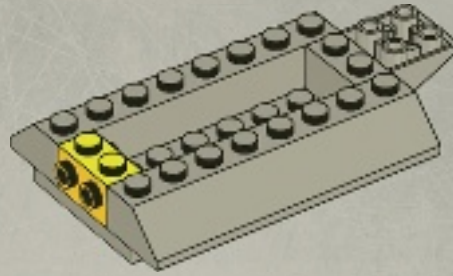

4

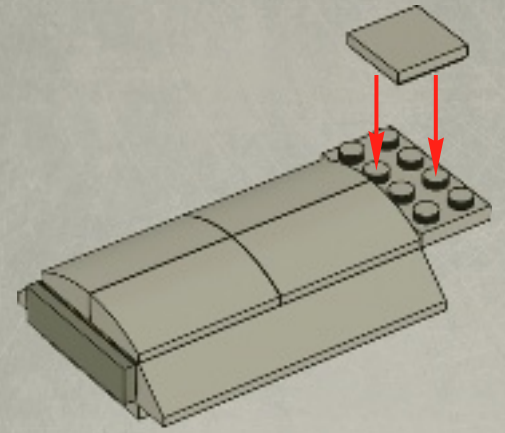

3

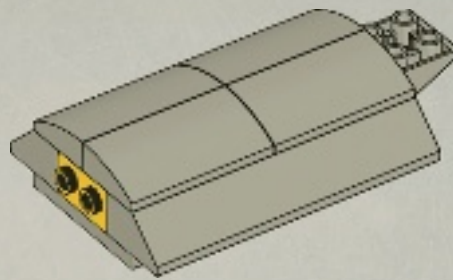

5

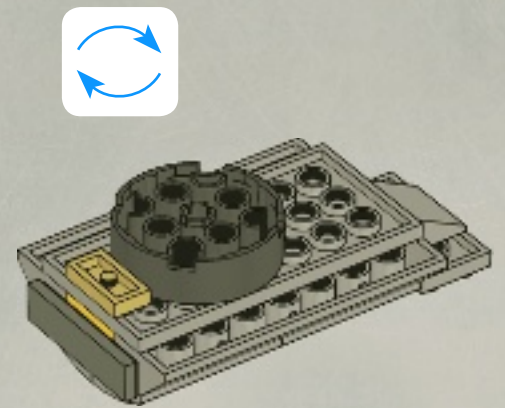

6

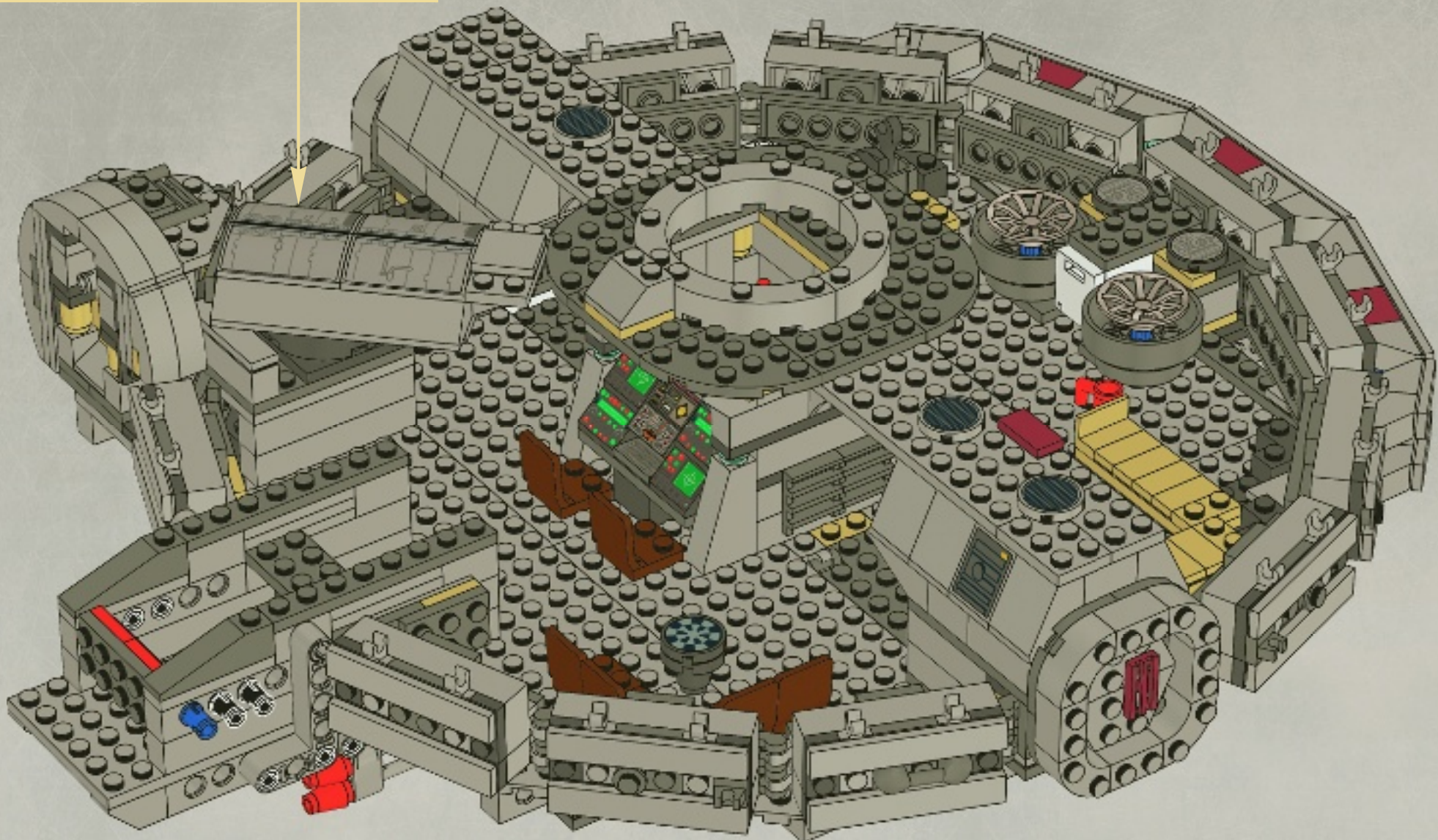
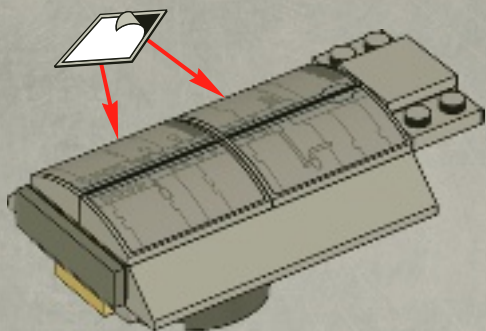

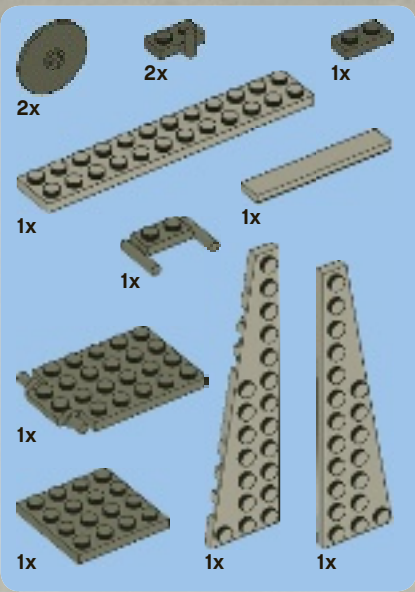

85

1

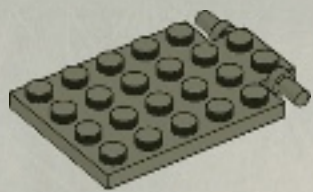

2

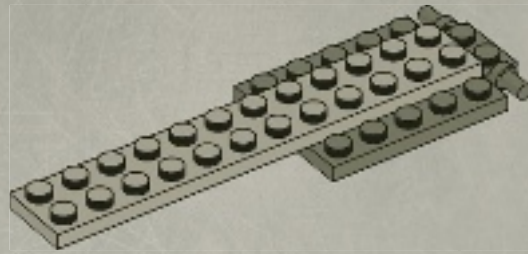

3

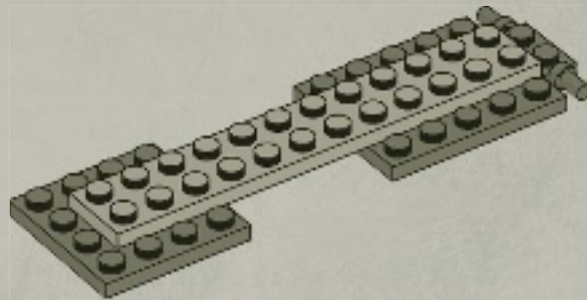

4

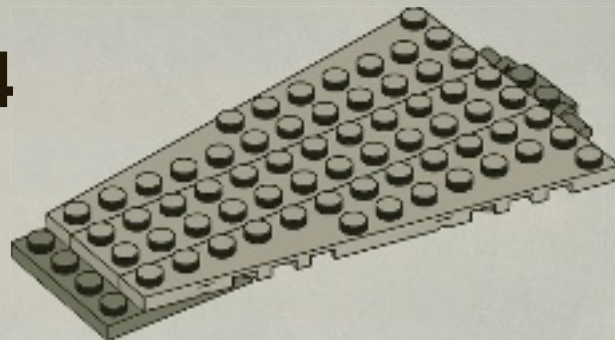

5

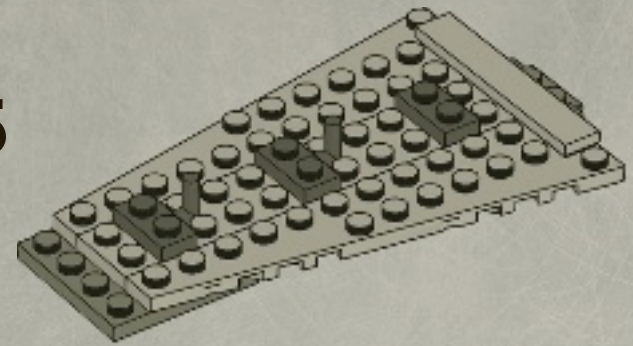

1



2



2x

6

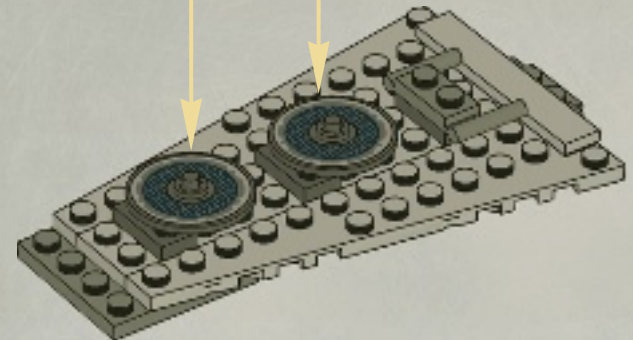

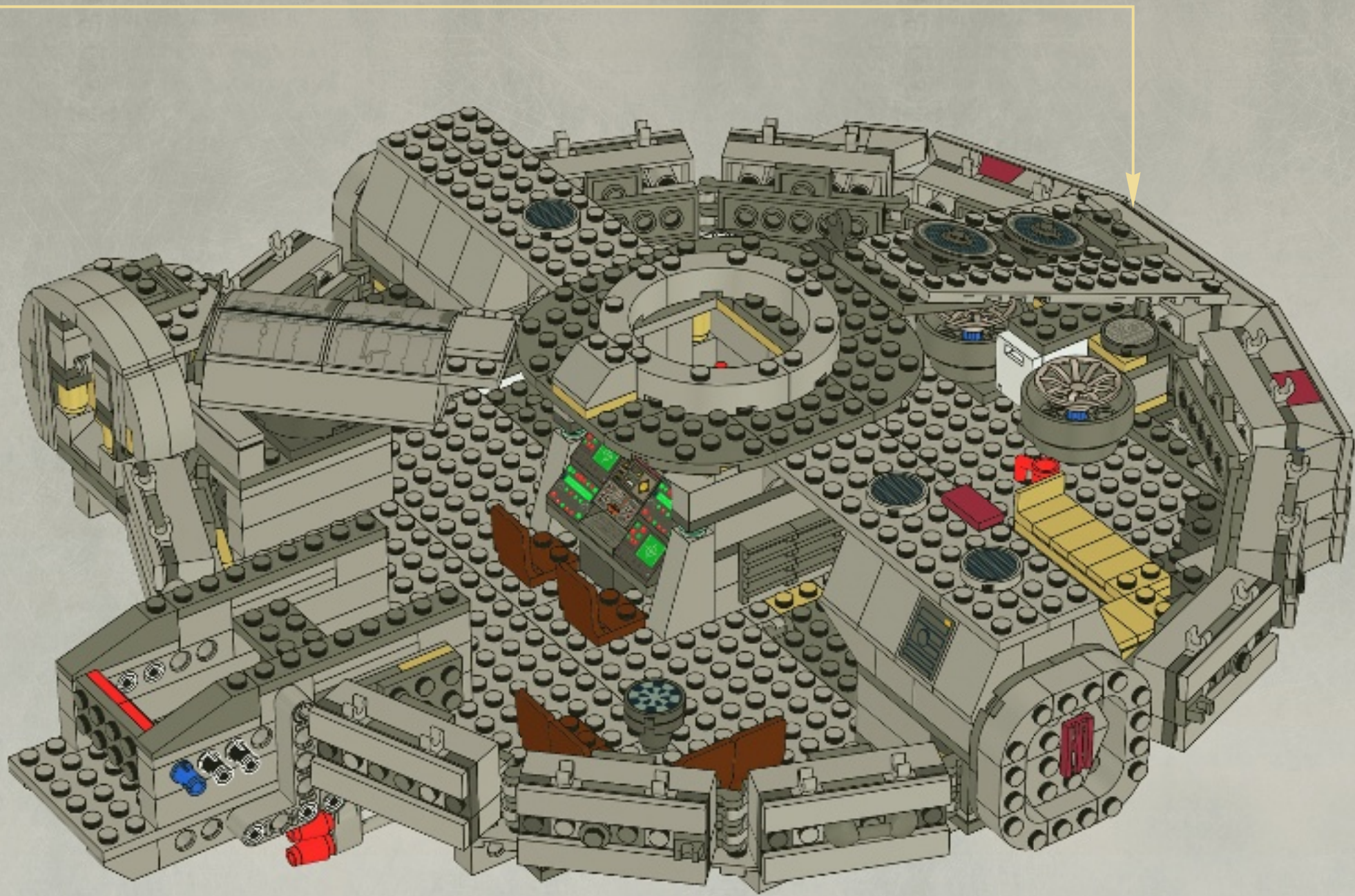

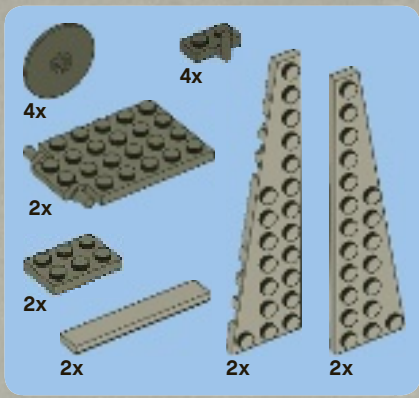

86

1

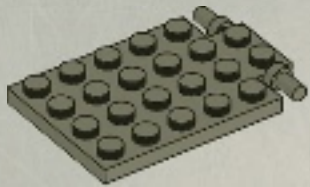

2

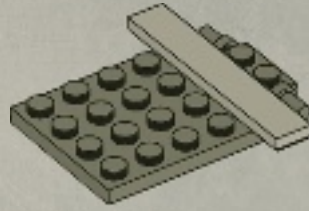

3

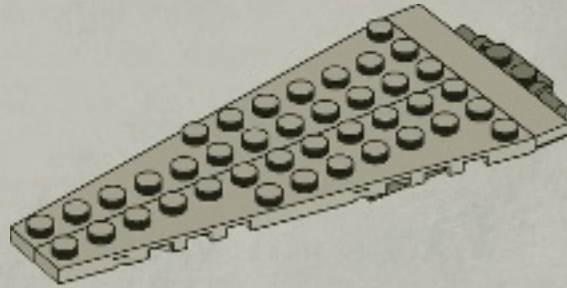

4

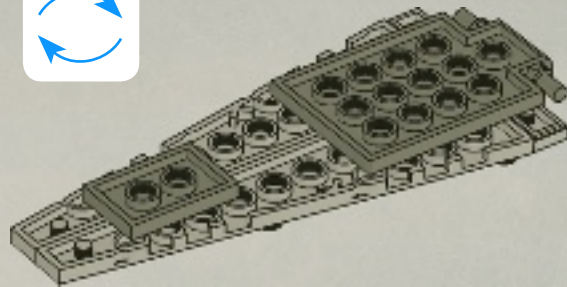

5

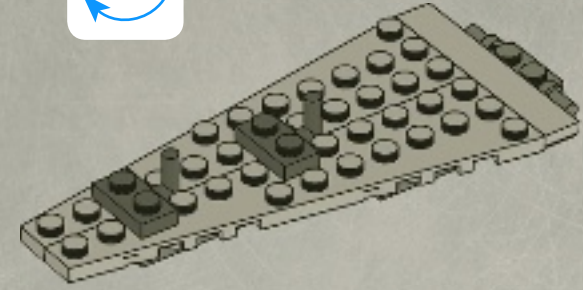

1



2



2x

6

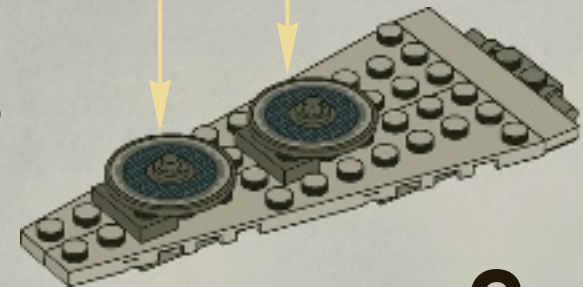

2x

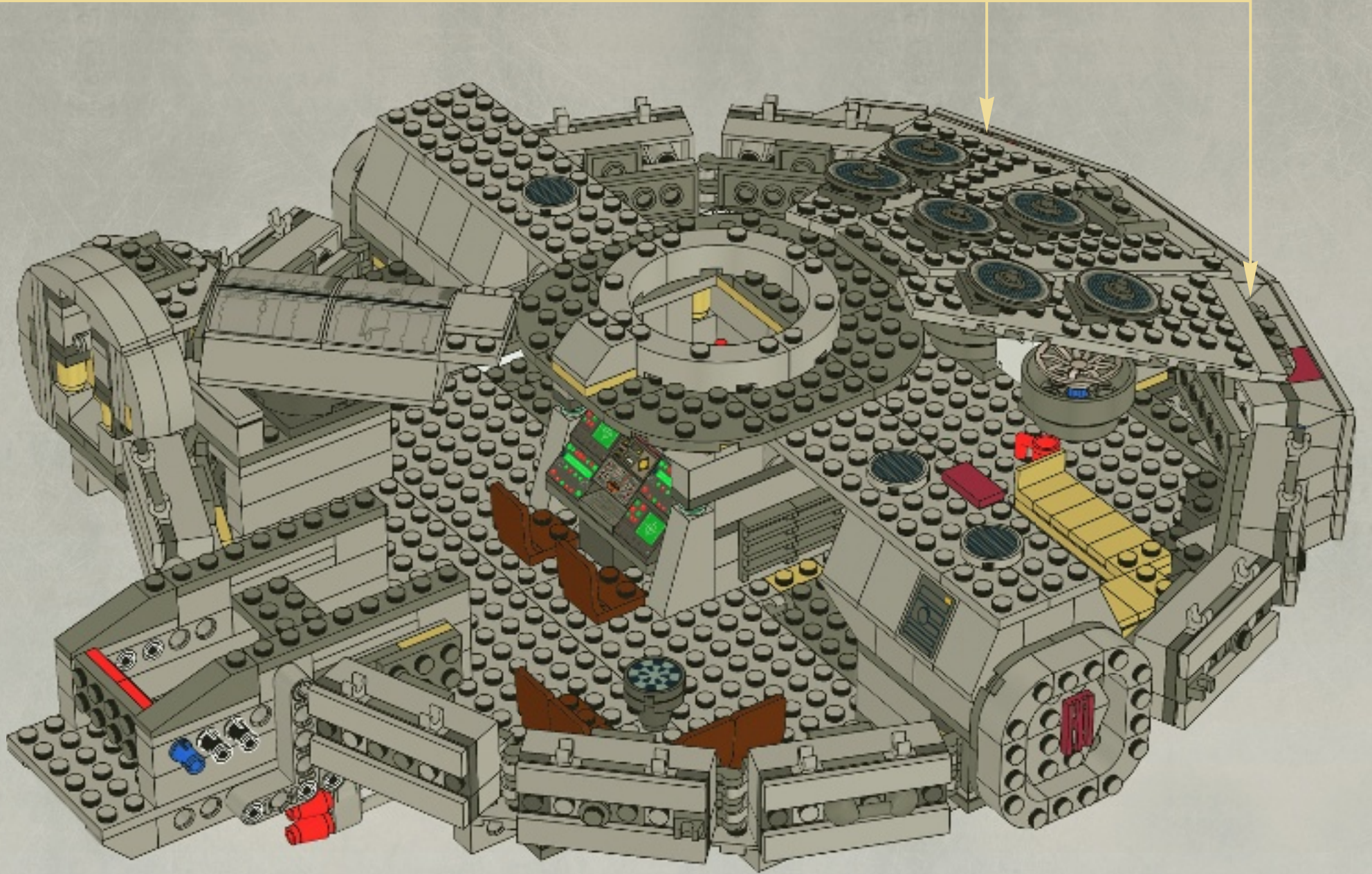



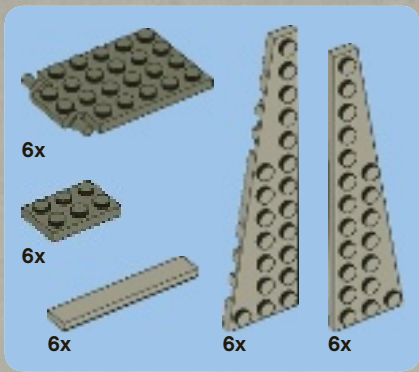

87

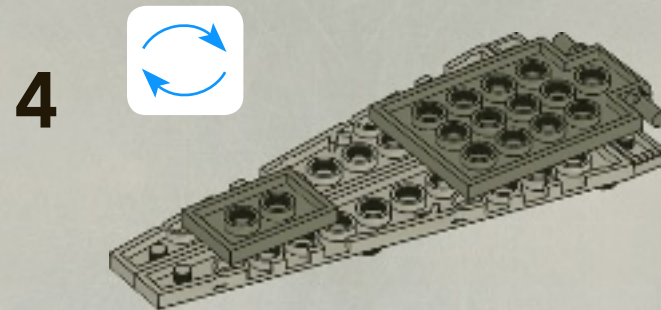
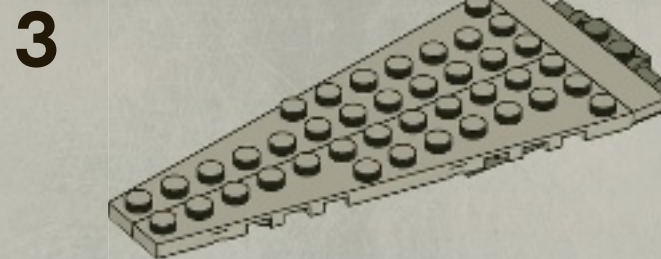
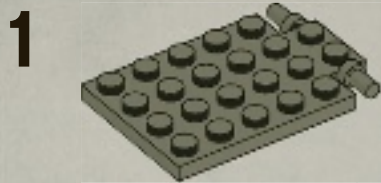

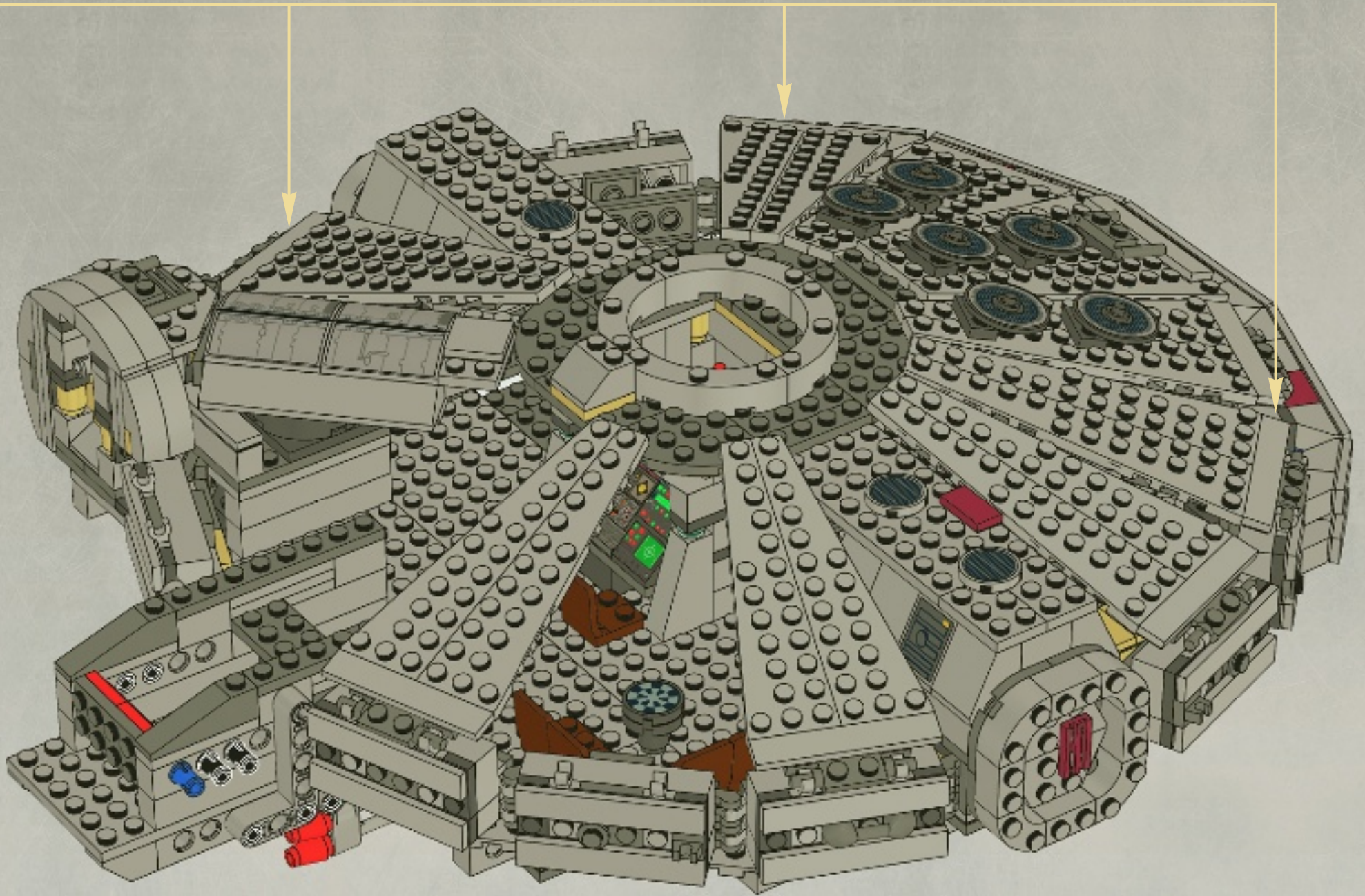

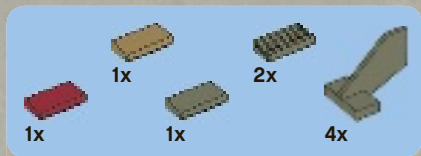

88

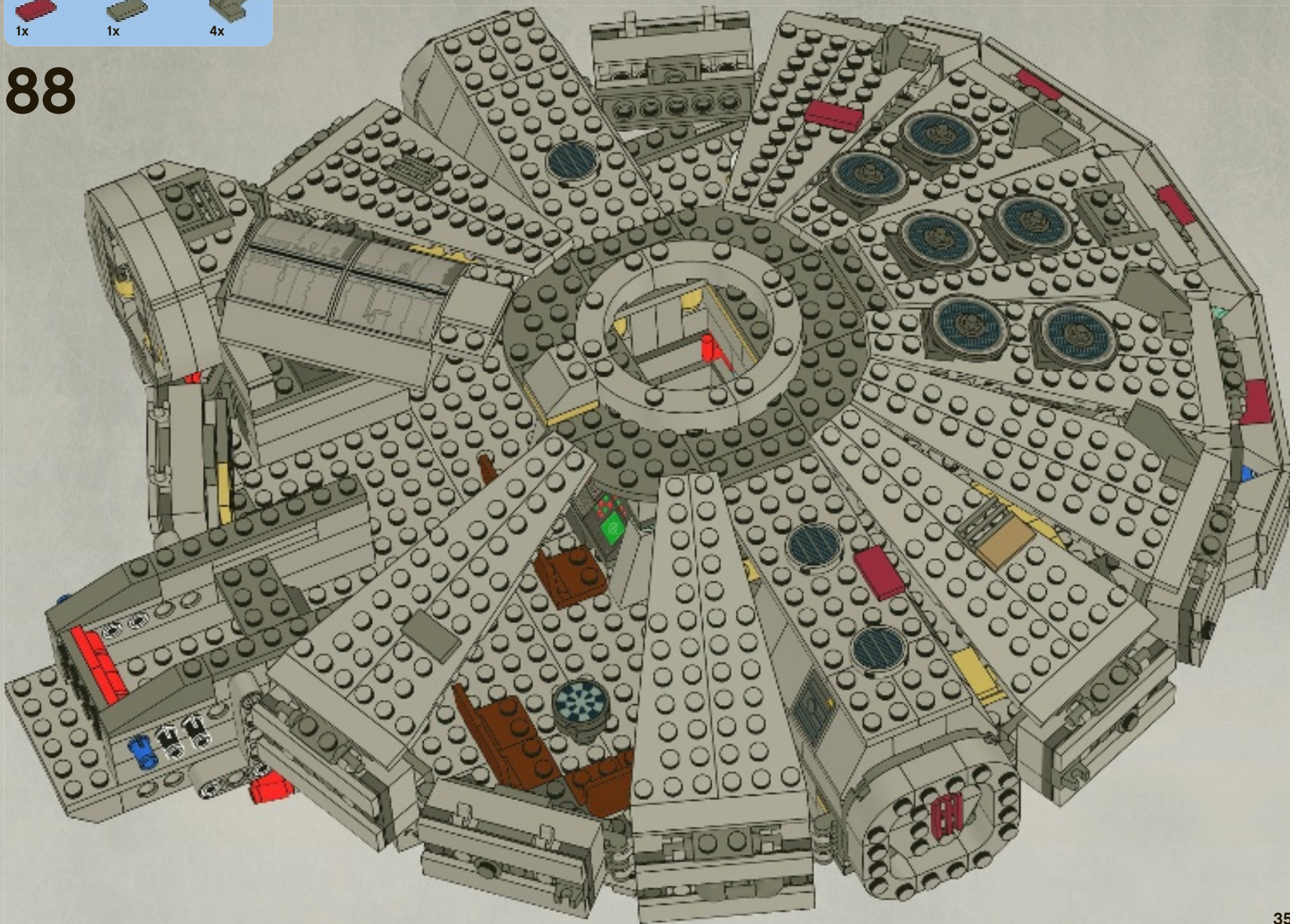

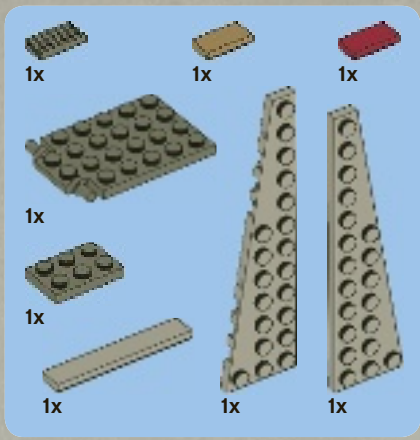

# 89

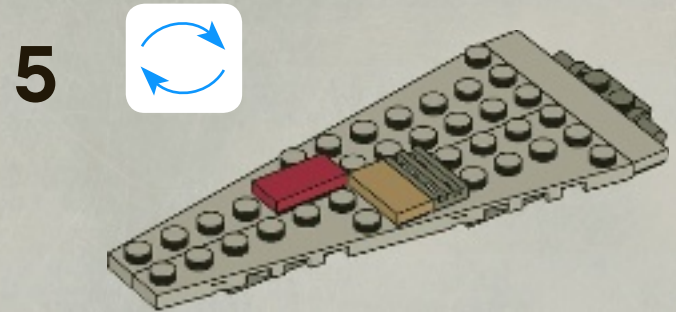
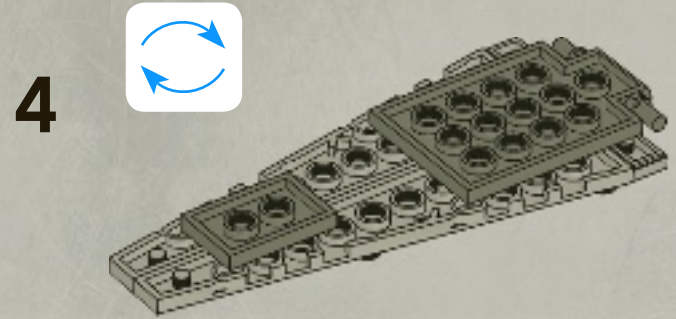
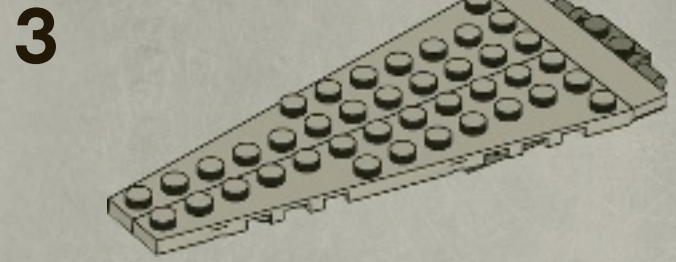
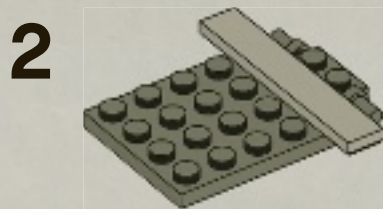
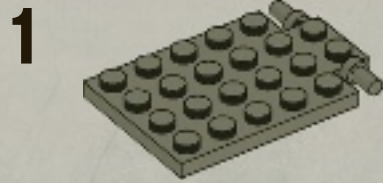

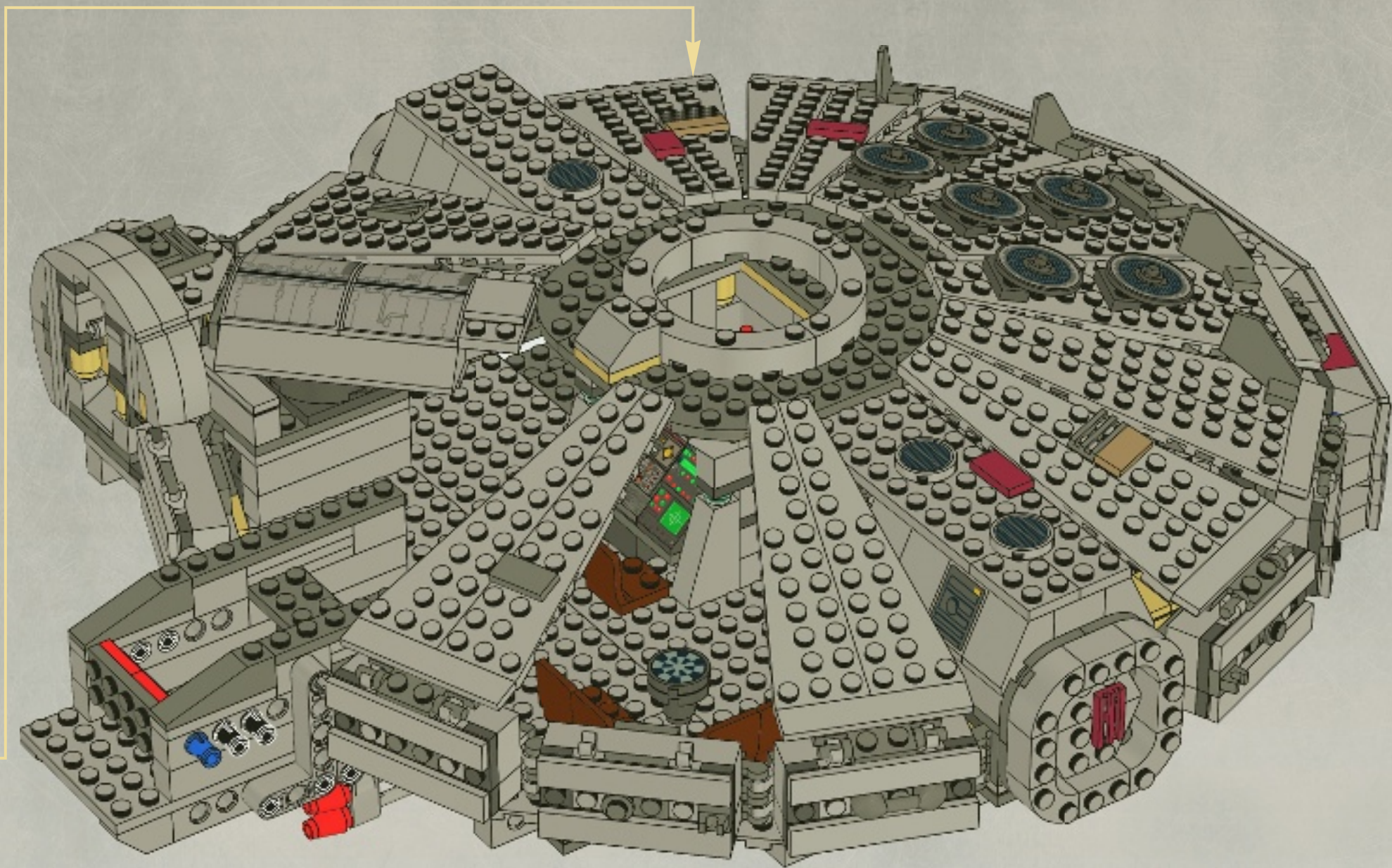

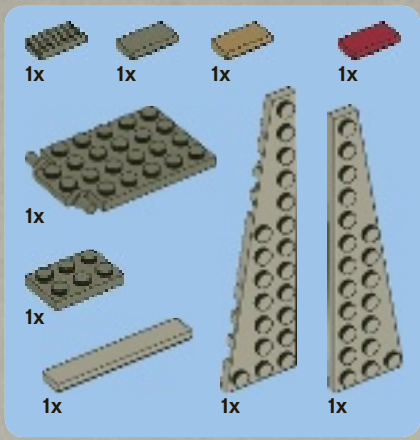

90

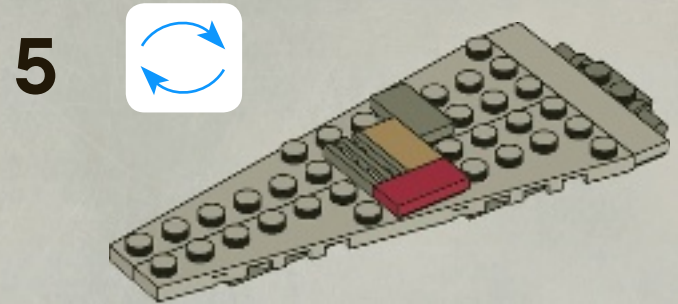
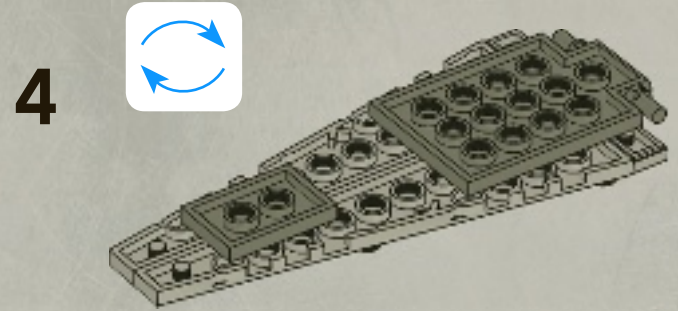
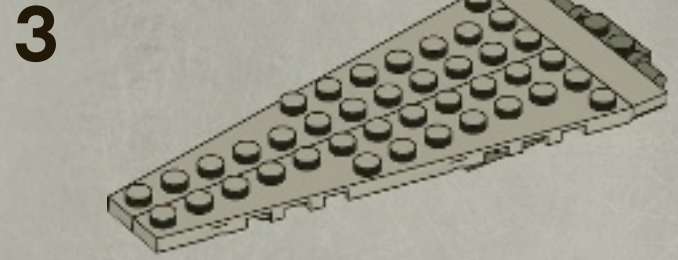
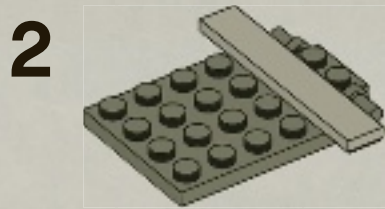
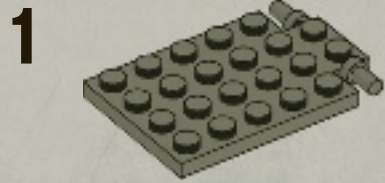

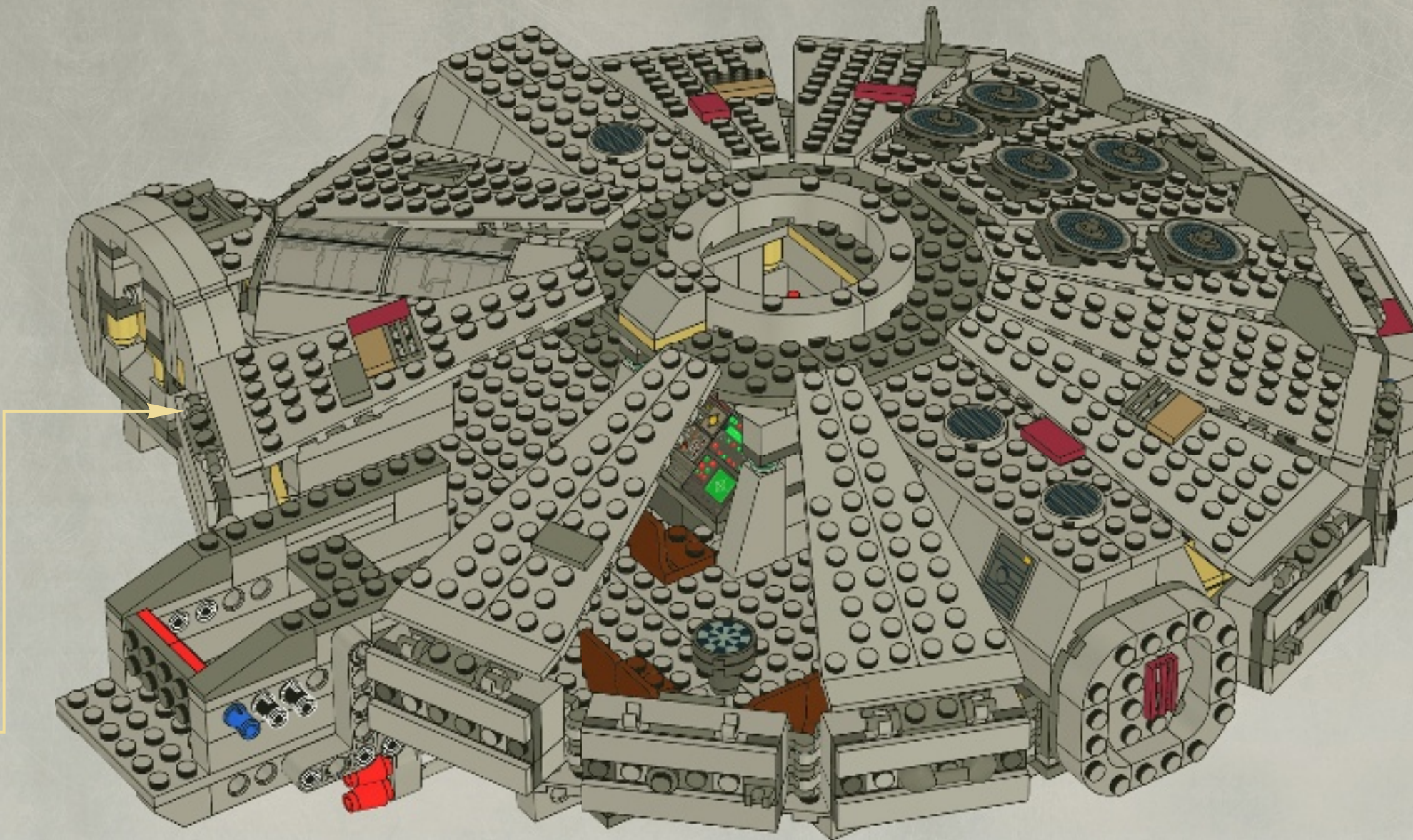

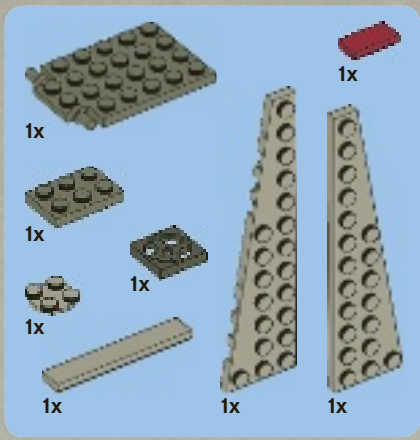

# 91

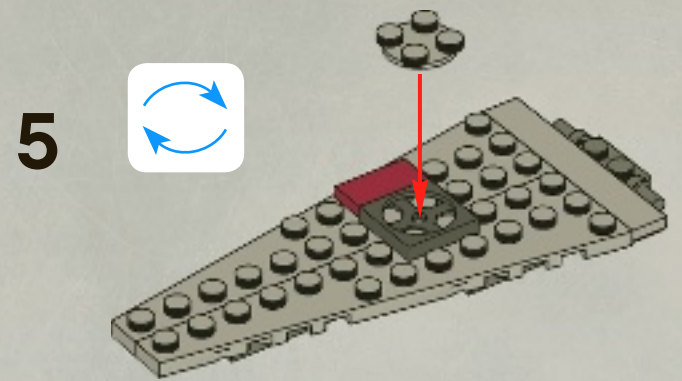
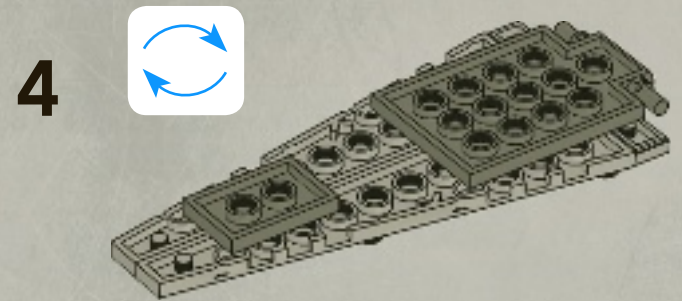
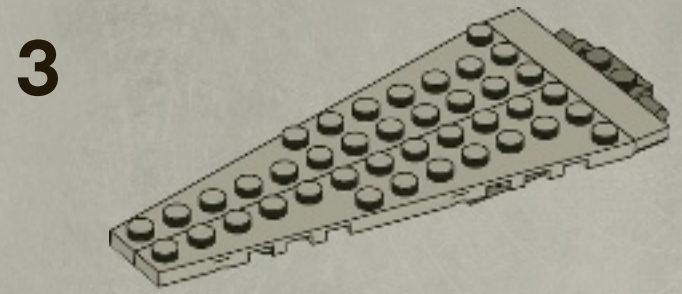
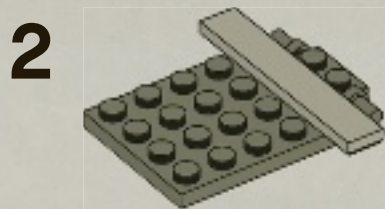
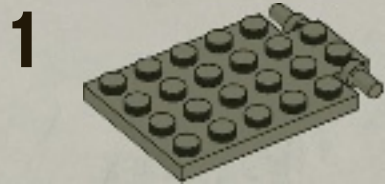



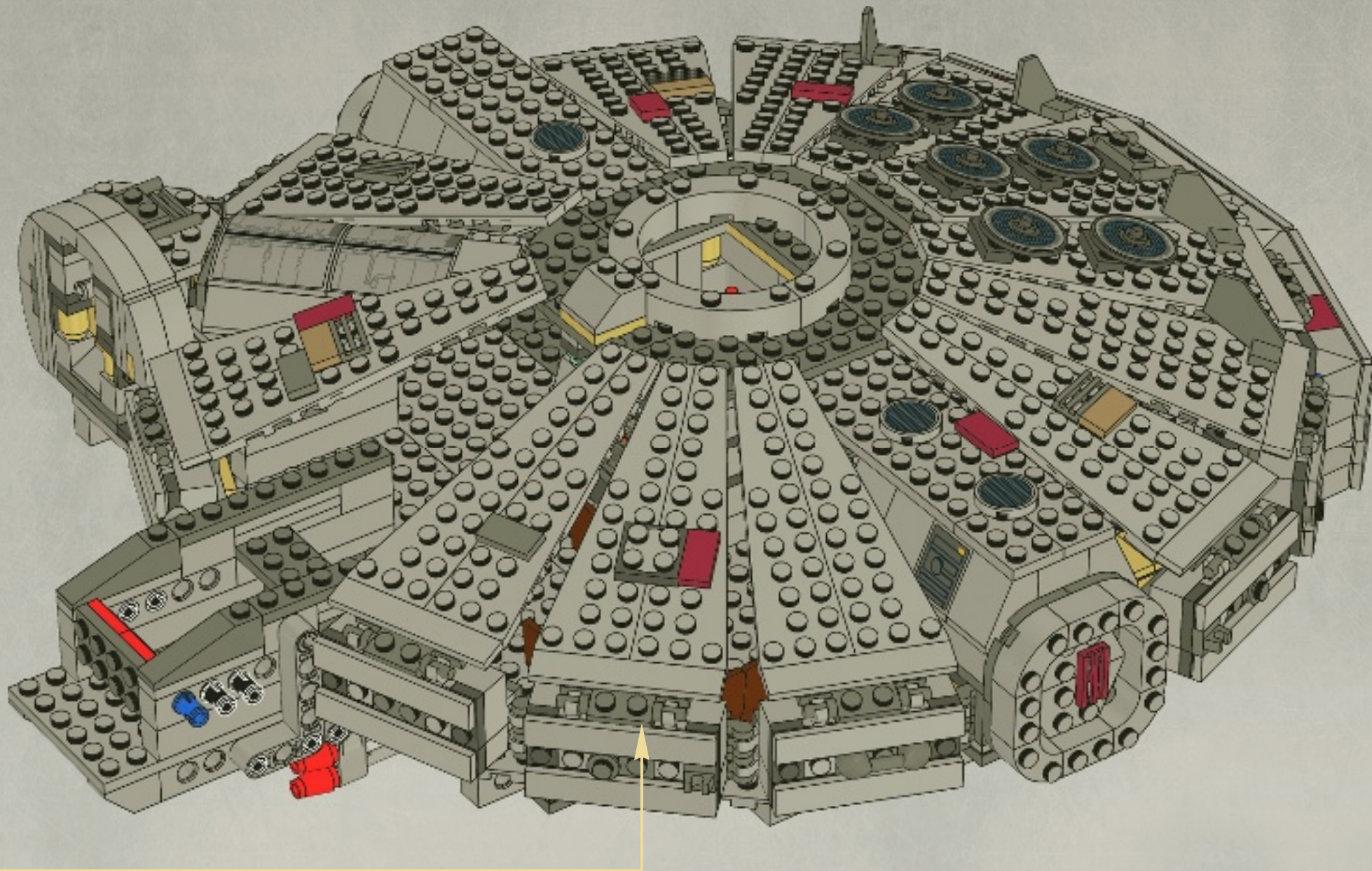

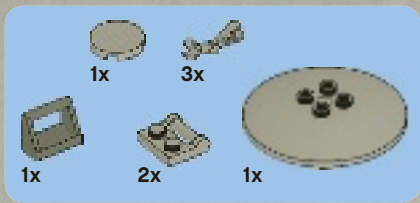

92

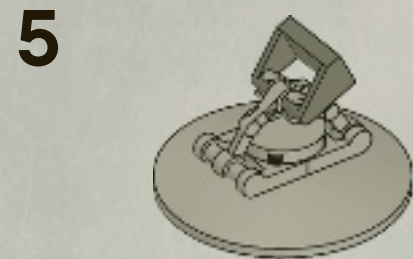
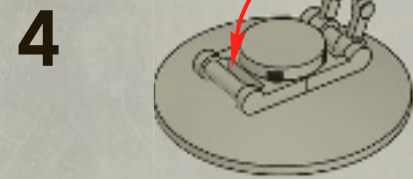
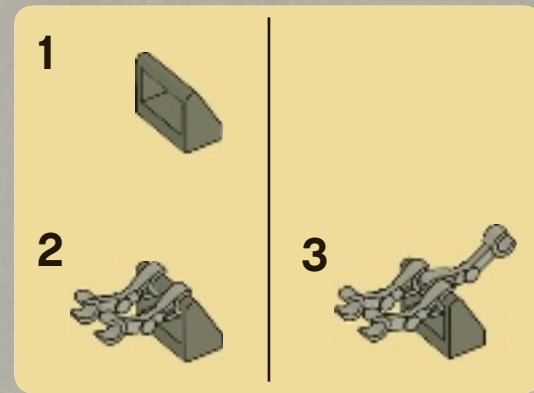
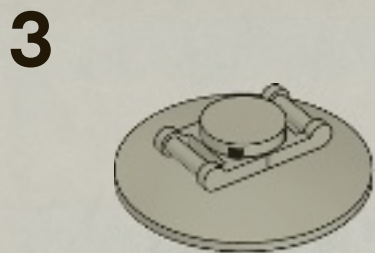
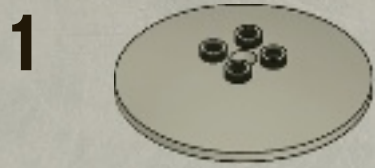

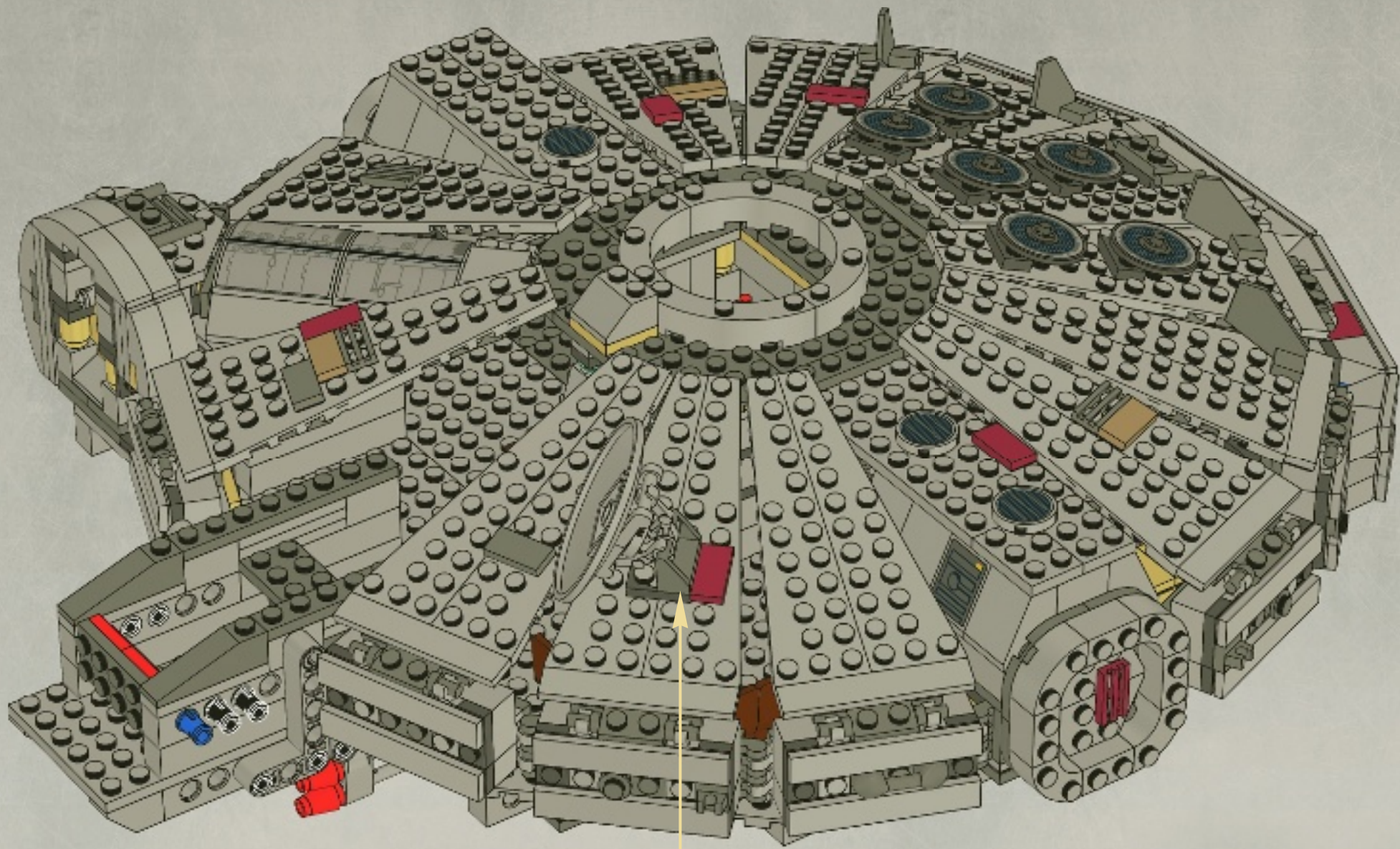

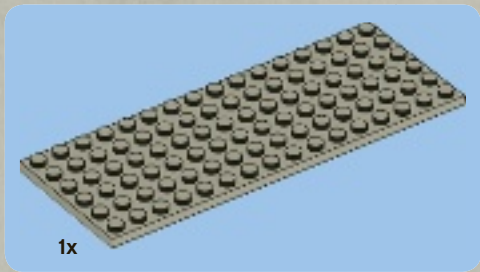

1x

1

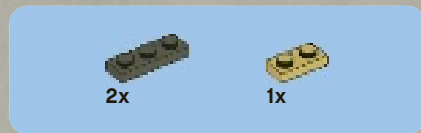
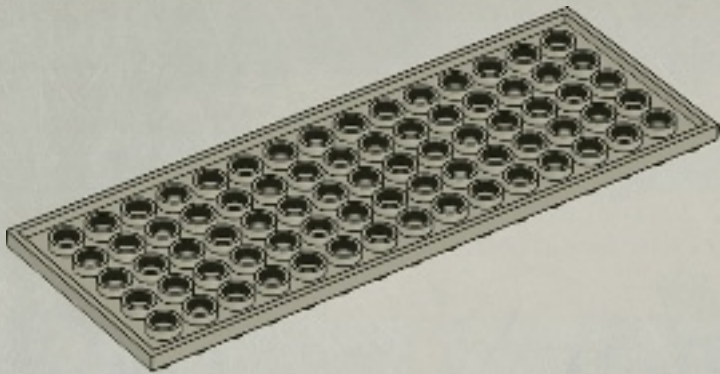

2x

1x

2

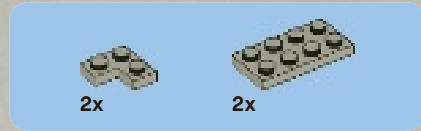
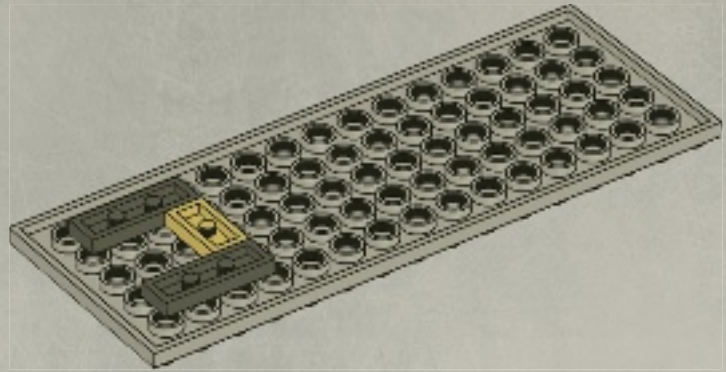

2x

2x

3

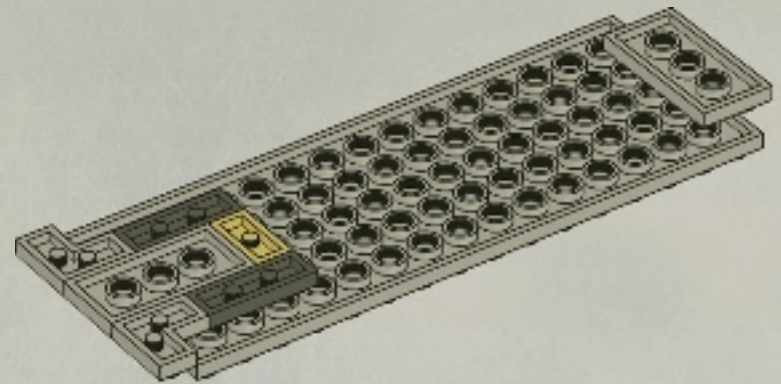

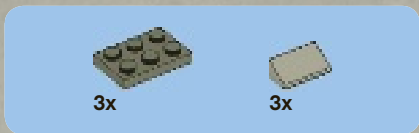

4

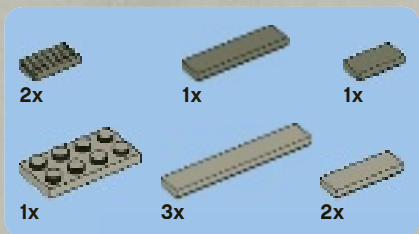
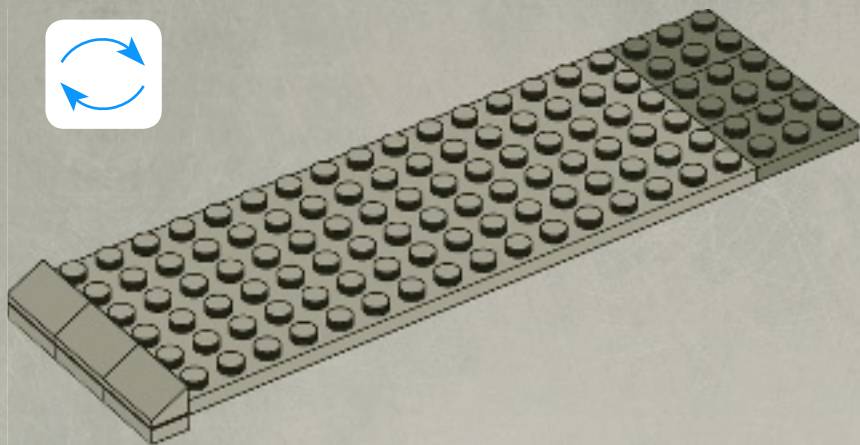

5

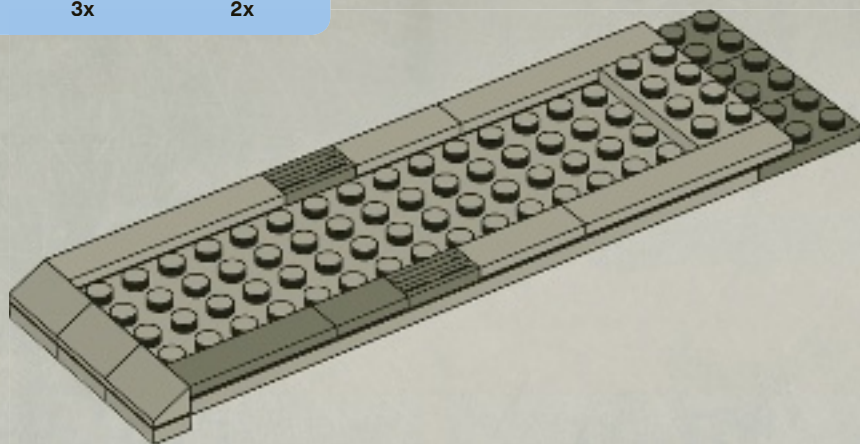

6

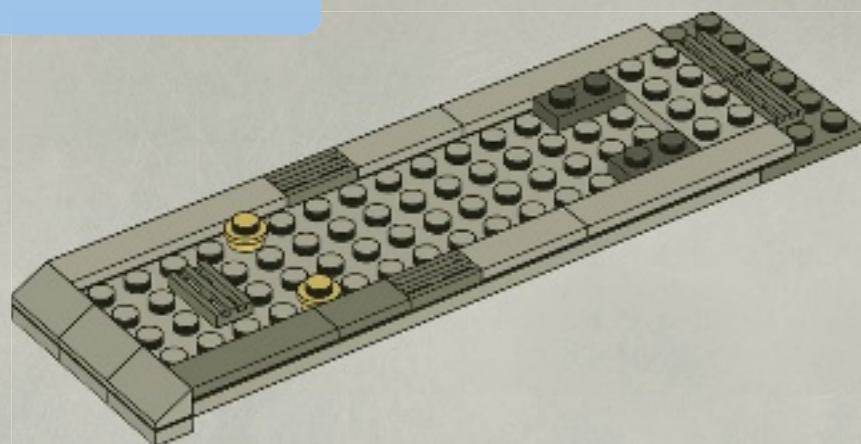



1x

7

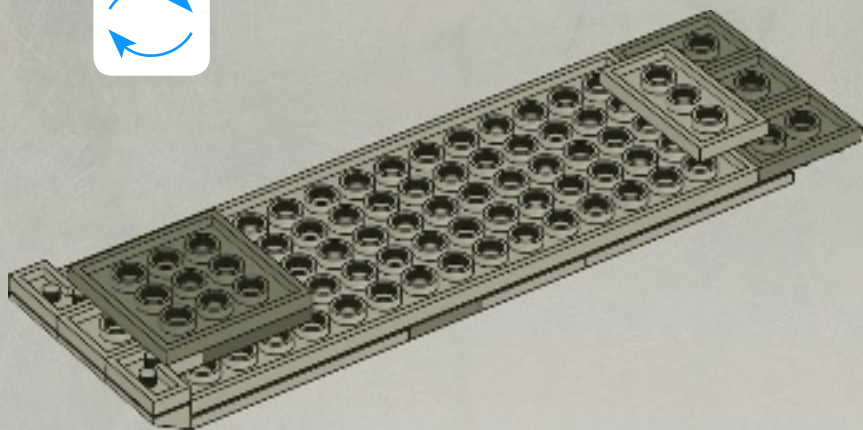

2x

8

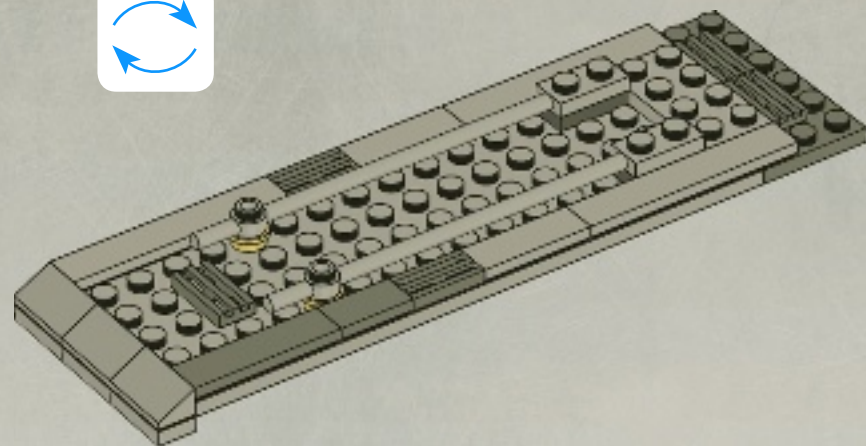

93

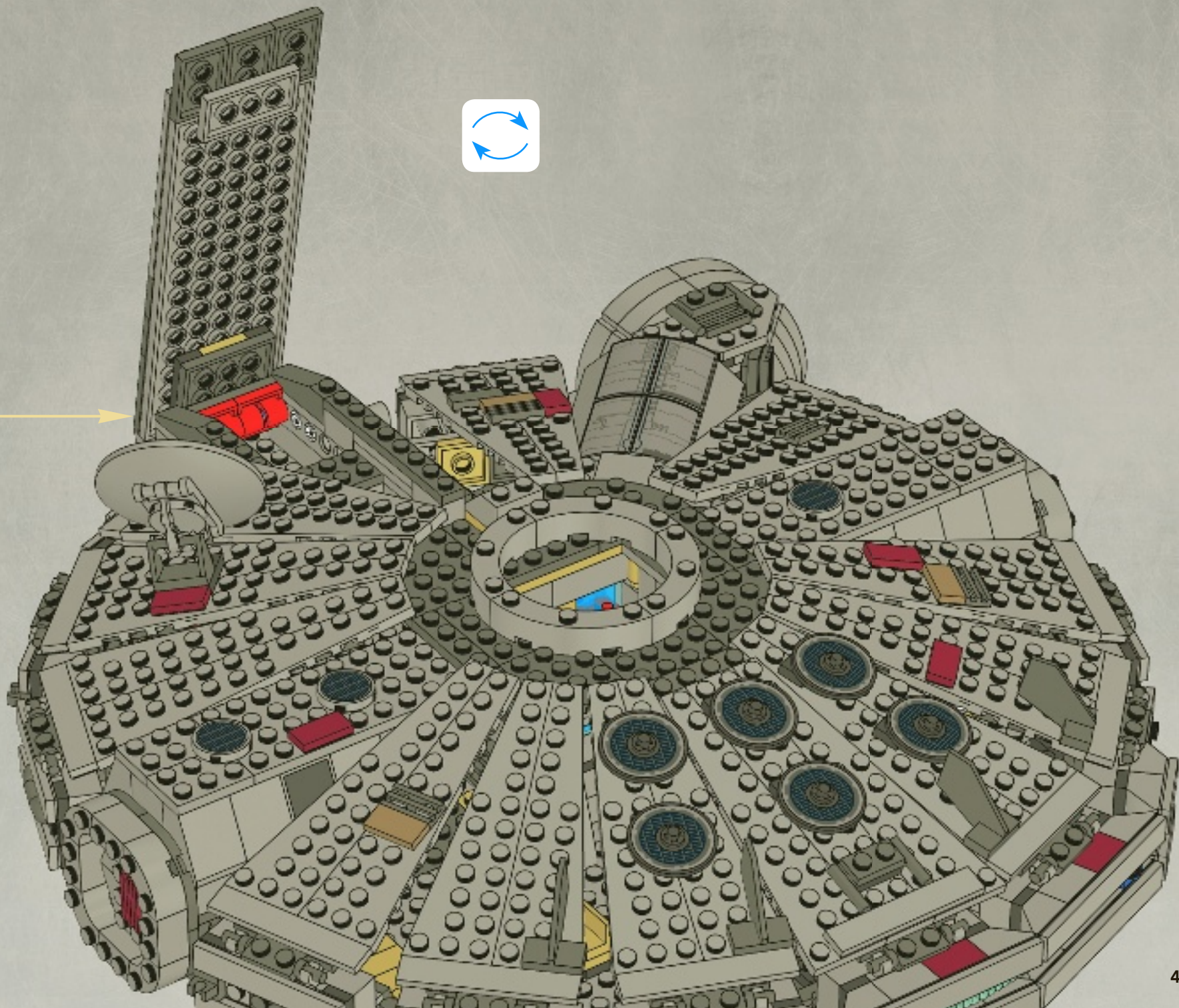

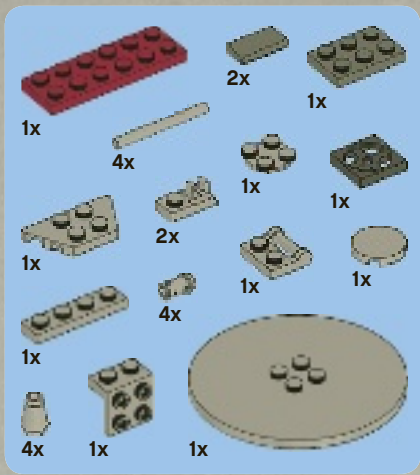

94

1



2

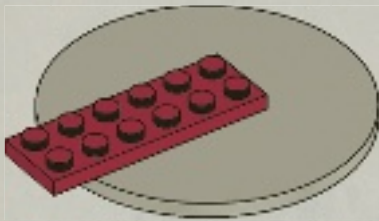

3

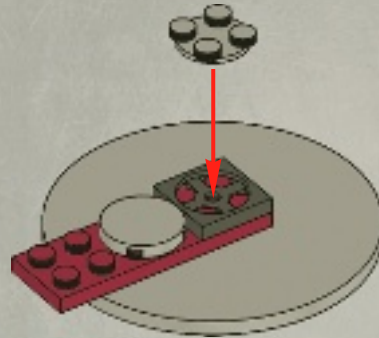

4

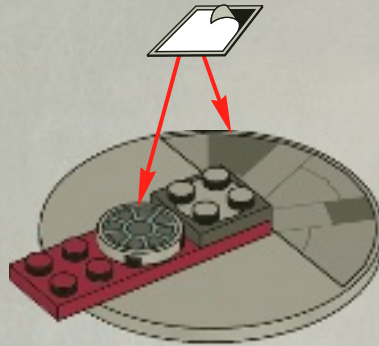



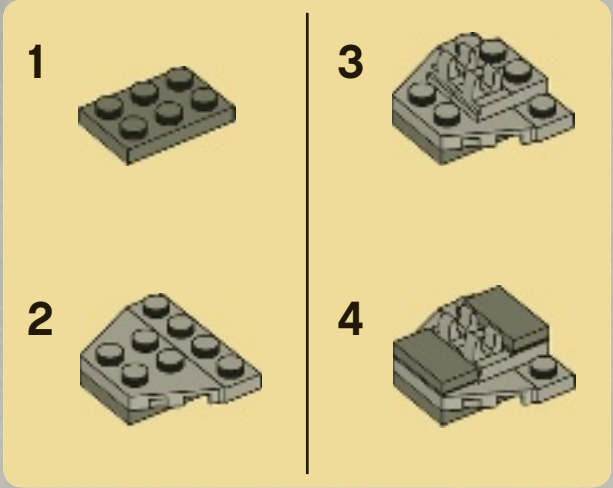

5

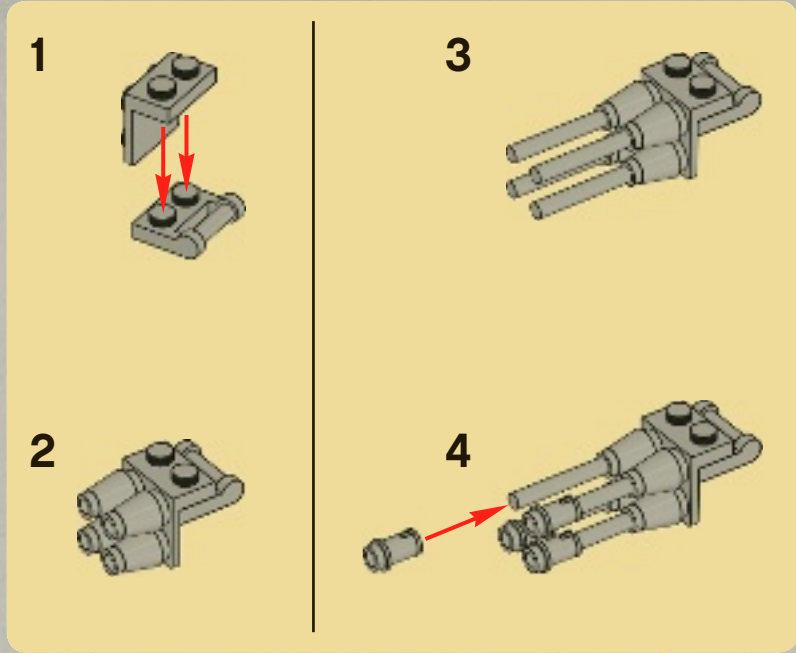
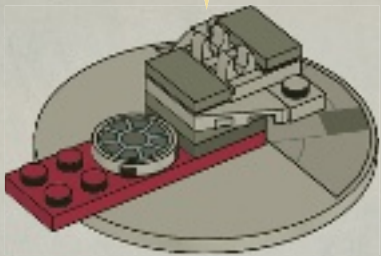

6

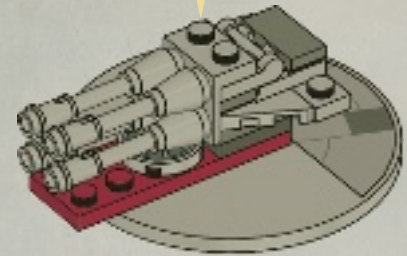

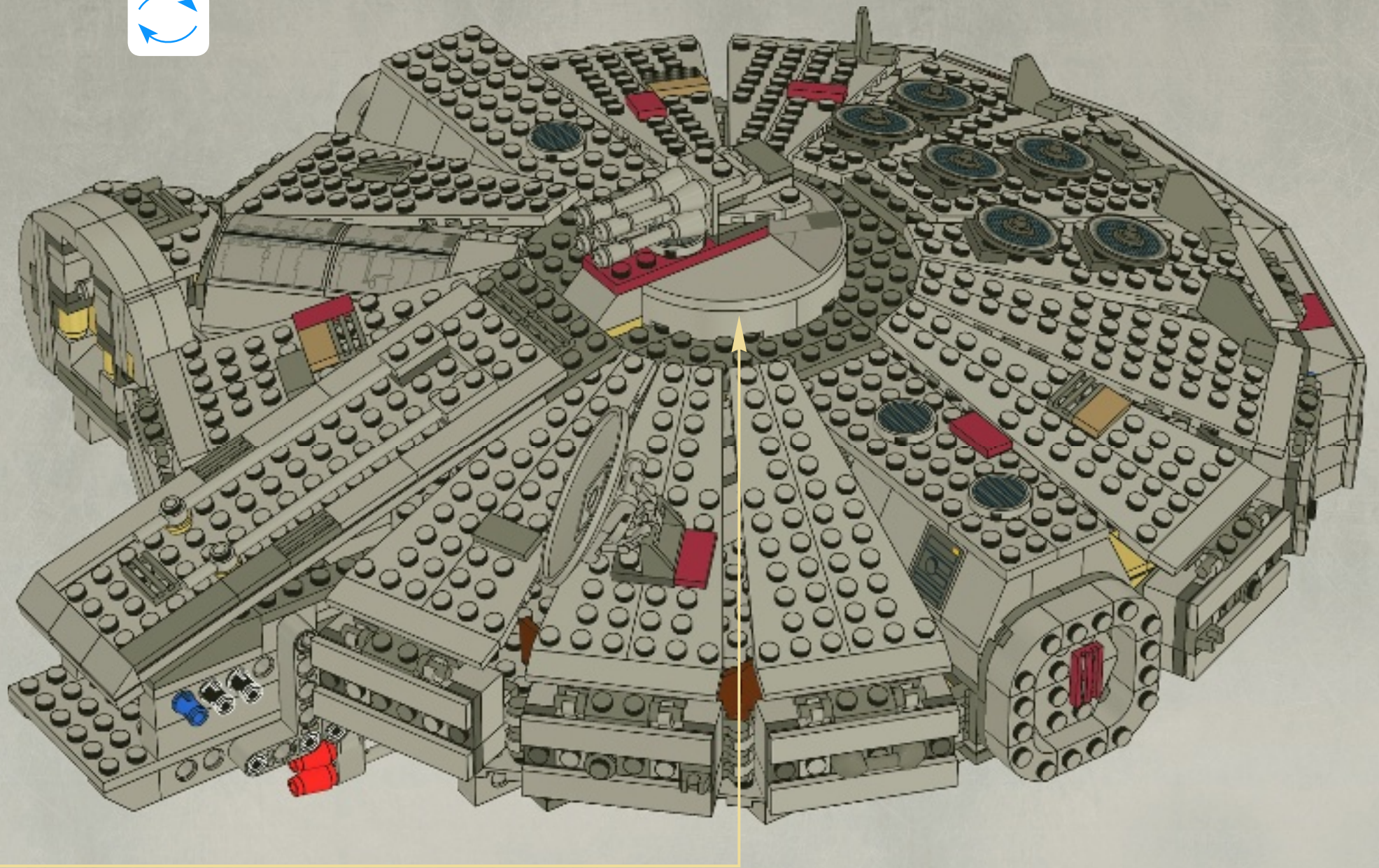

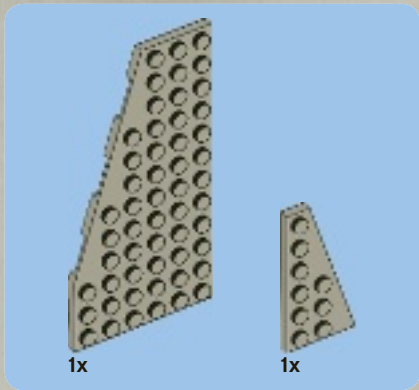

1

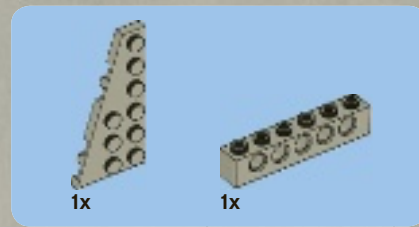
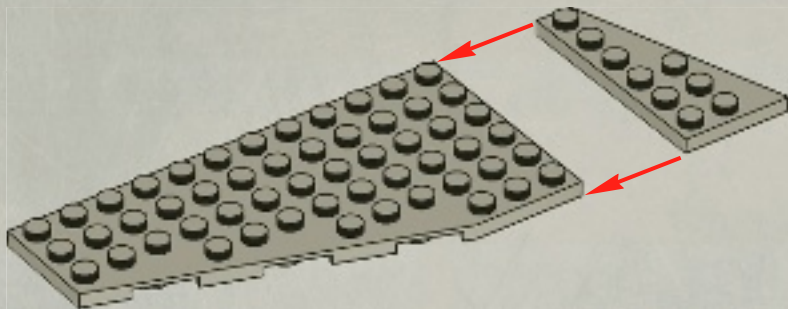

2

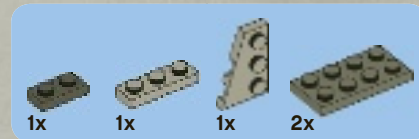
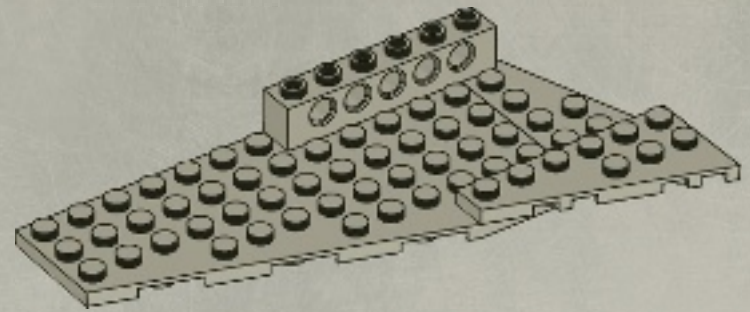

3

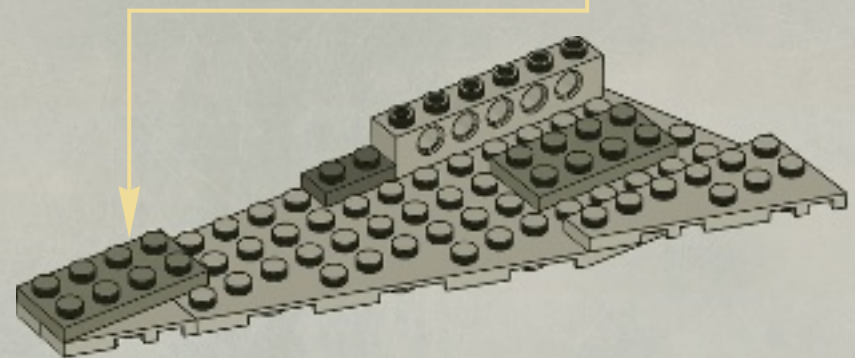
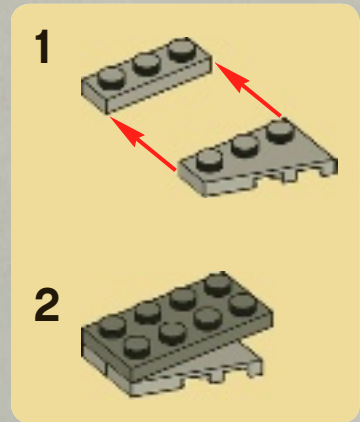

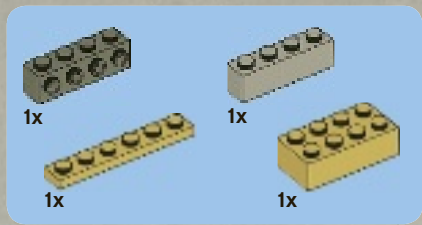

4

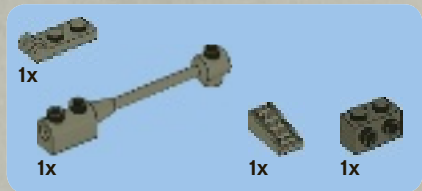
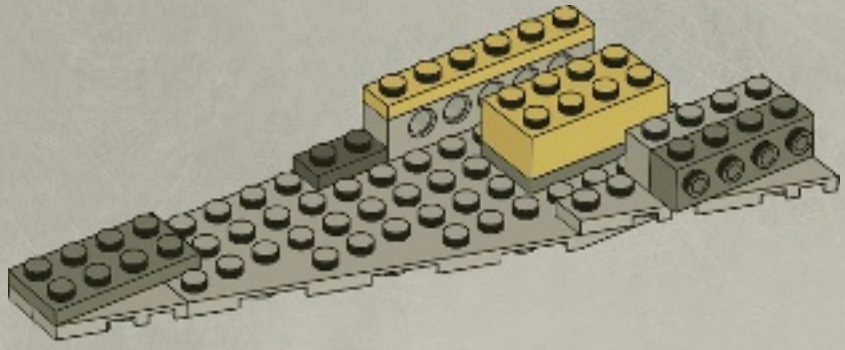

5

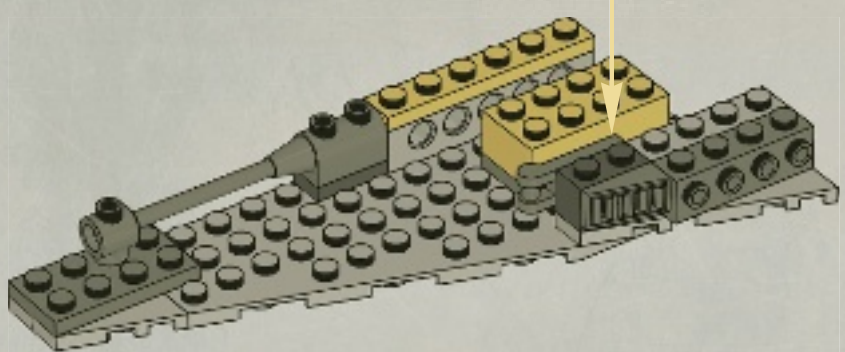
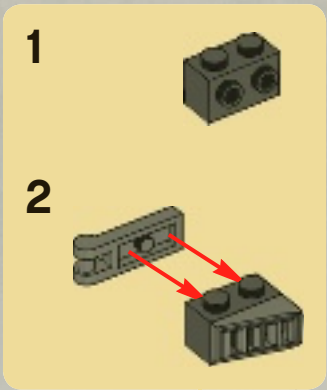

6

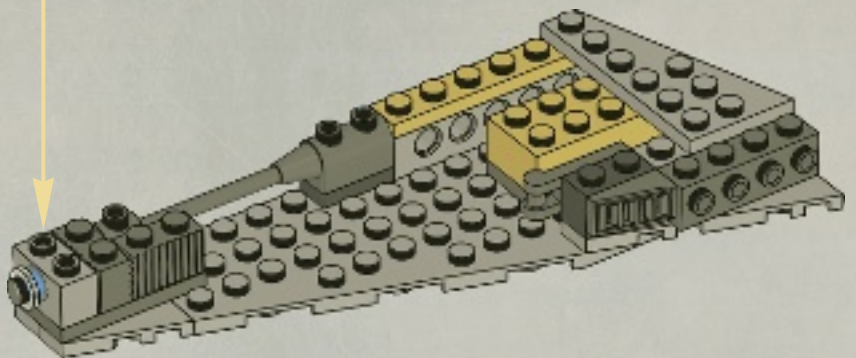

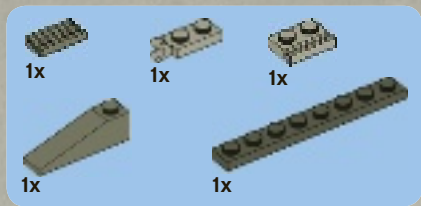

7

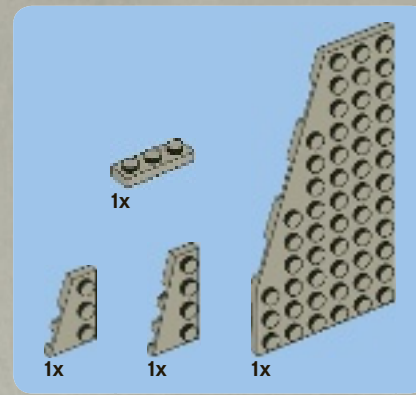
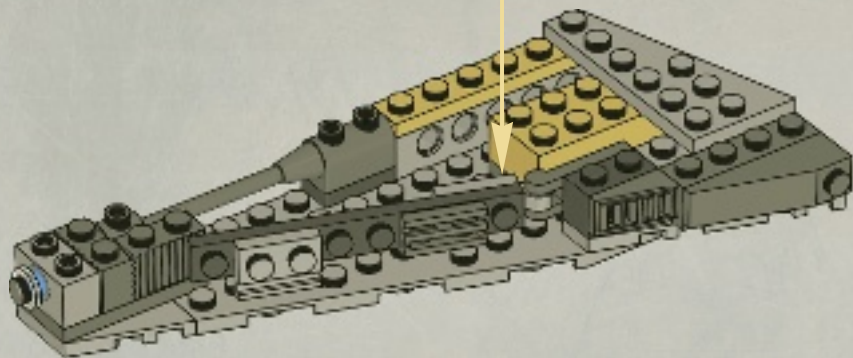
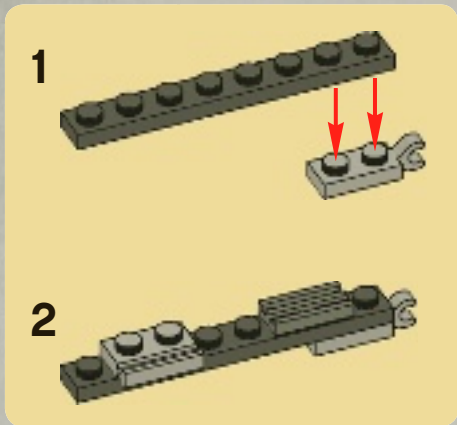

8

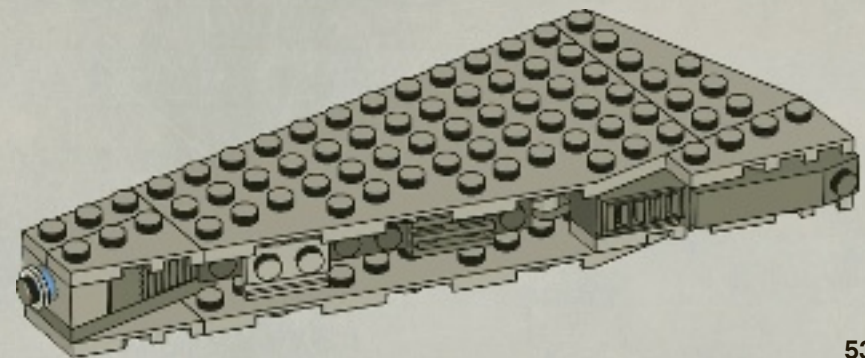

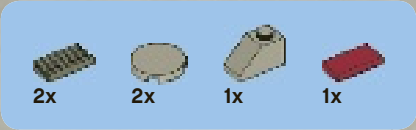

9

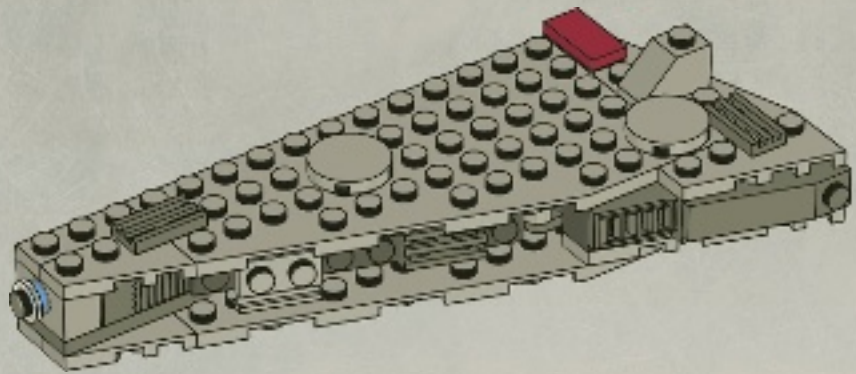

10

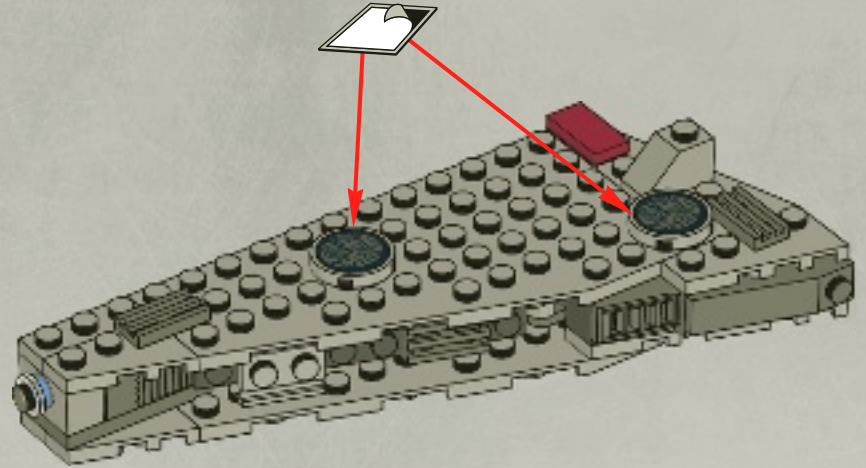

95

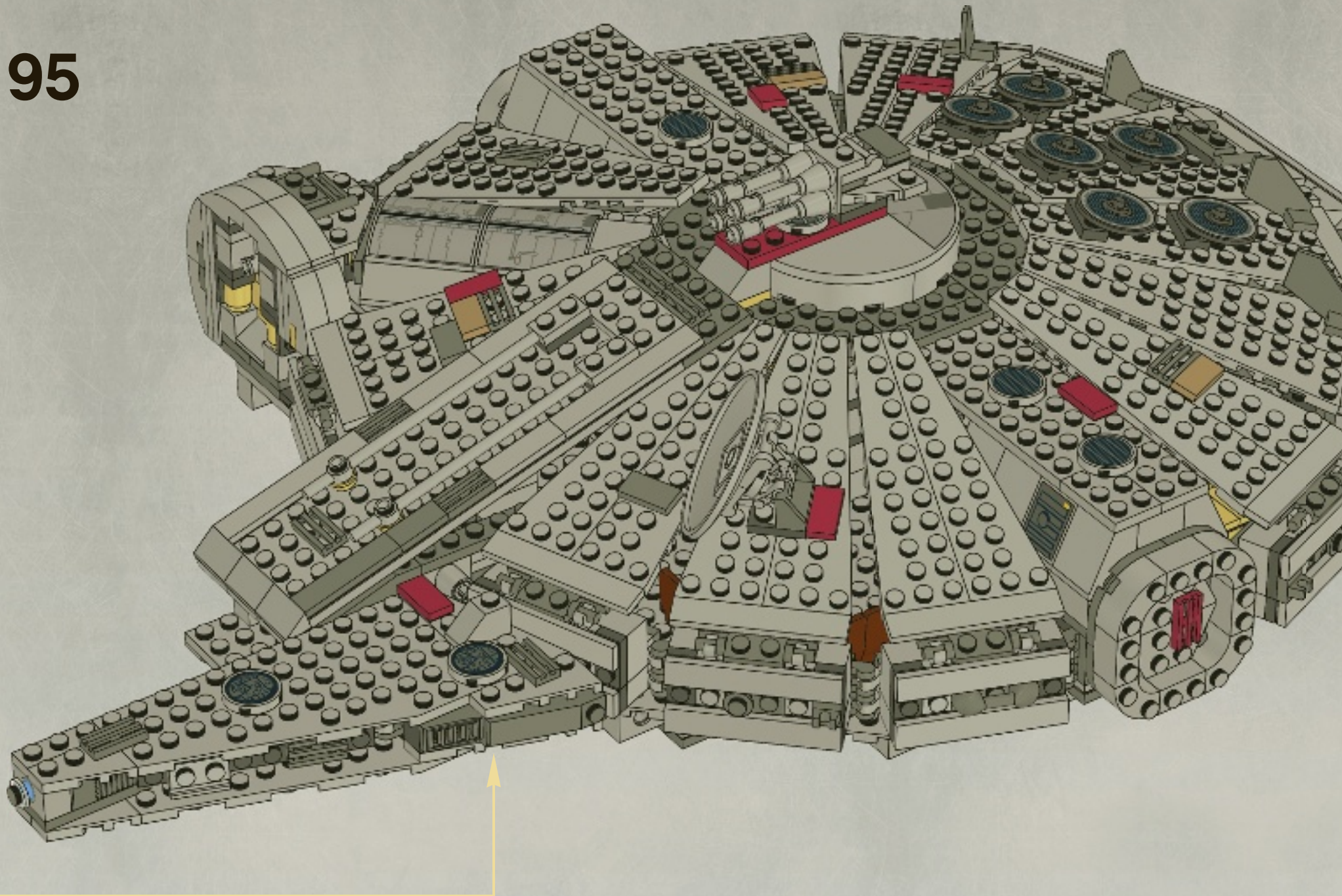

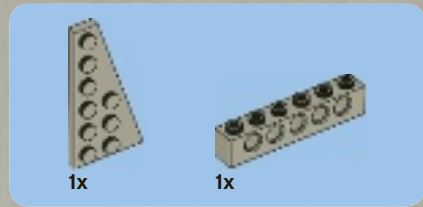

2

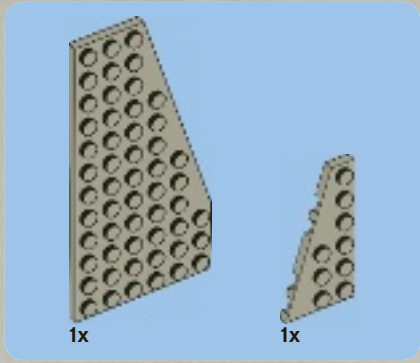
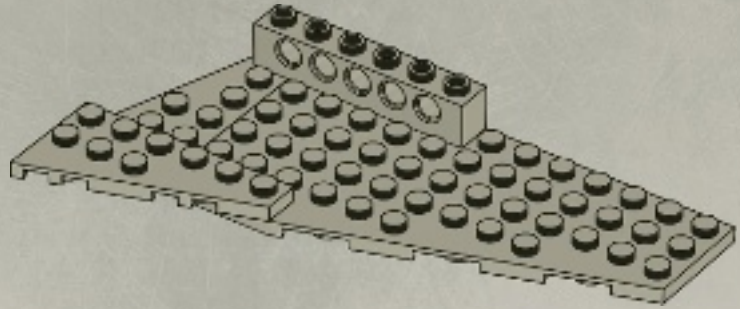

1

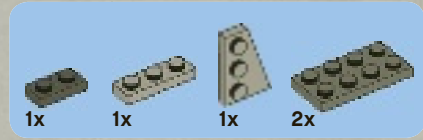
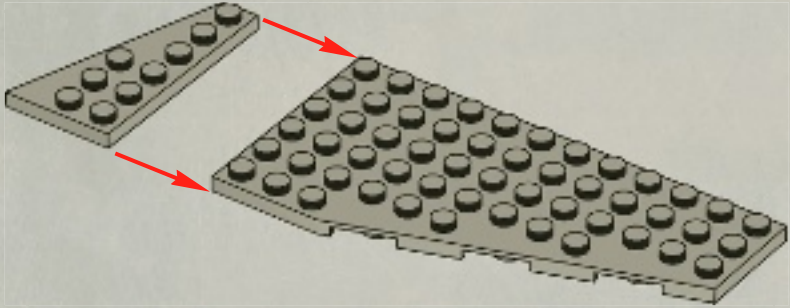

3

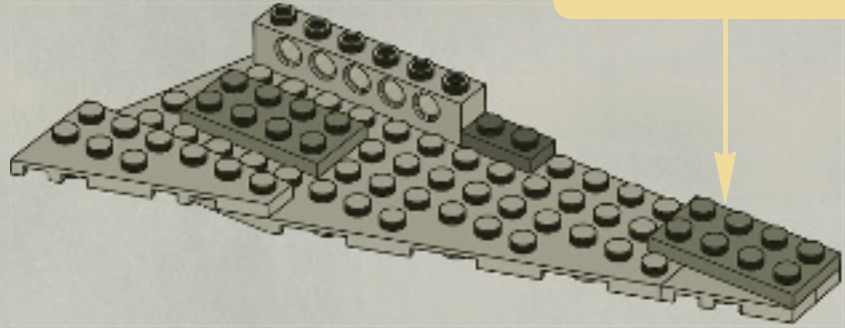
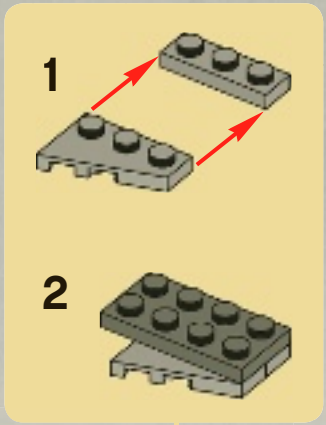



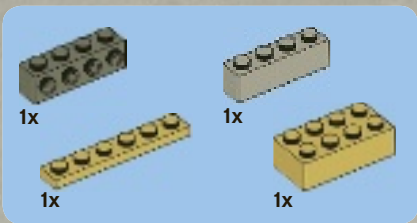

4

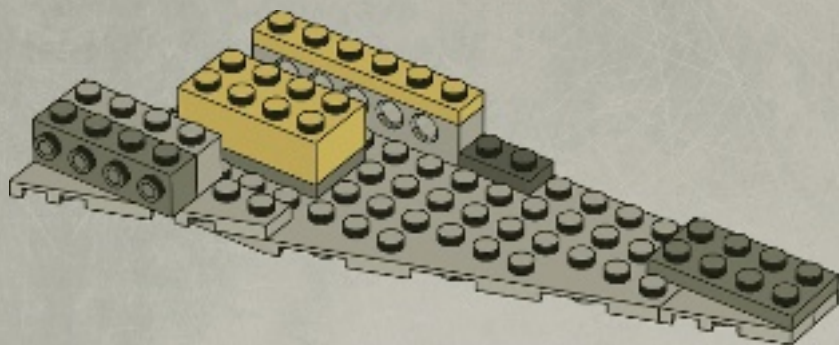

5

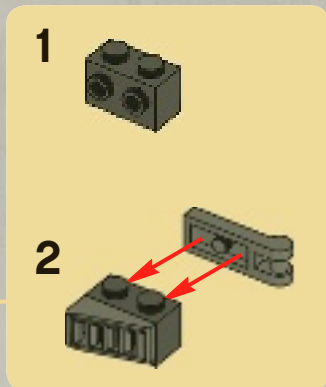
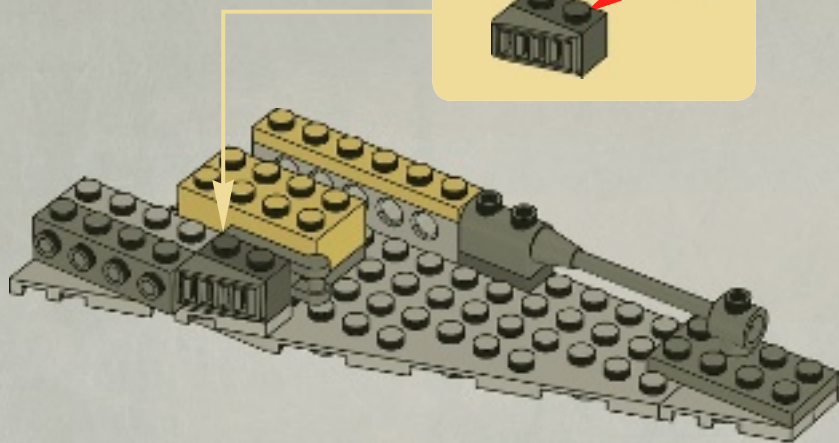

6

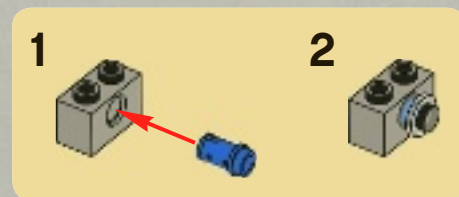
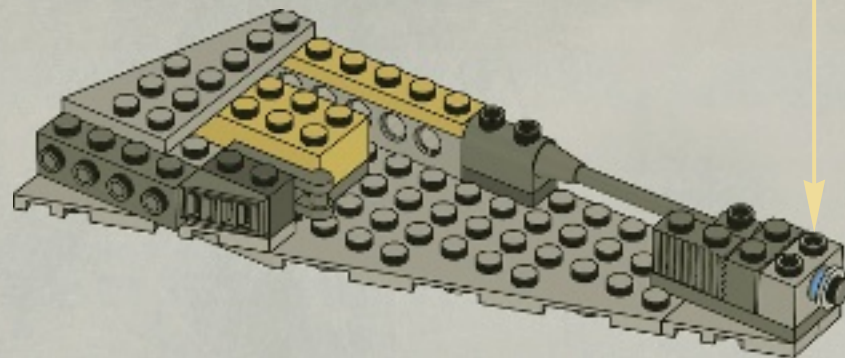

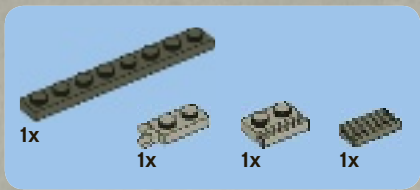

7

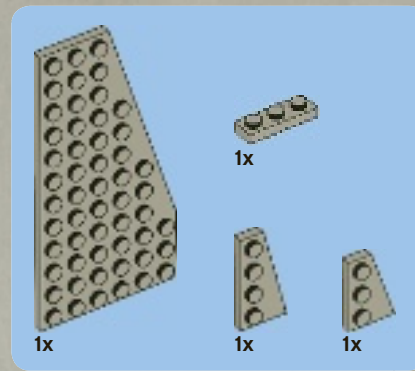
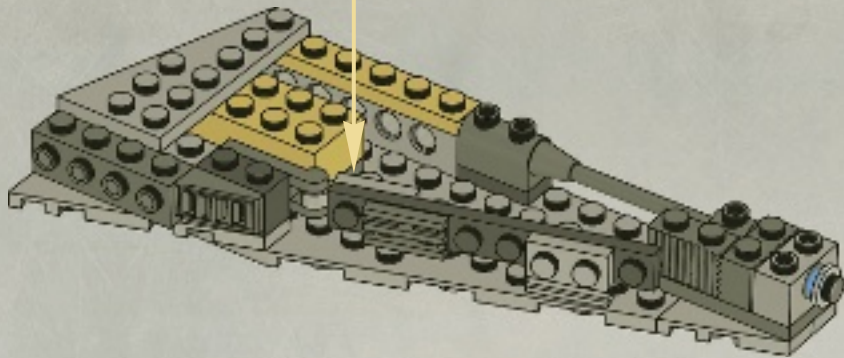
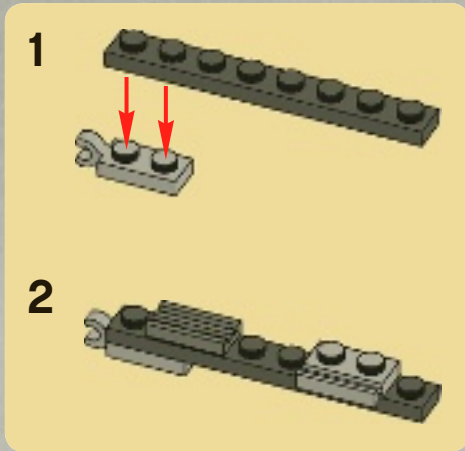

8

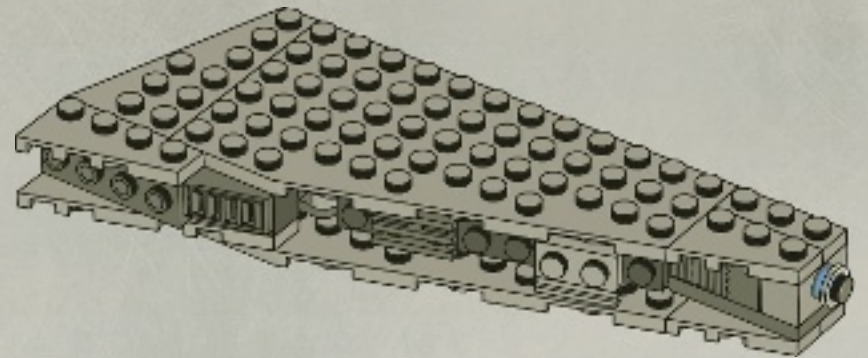



9

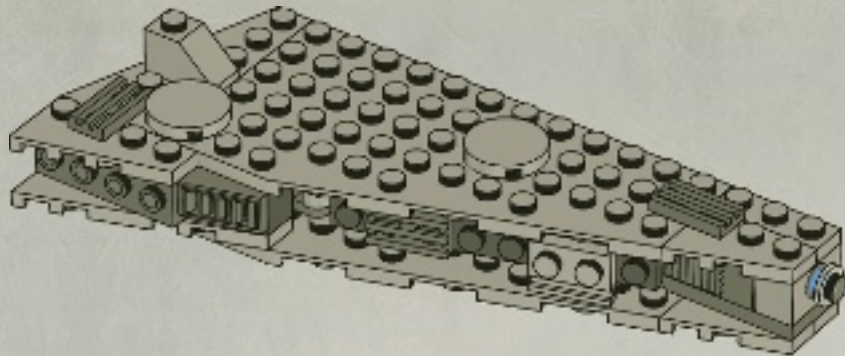

10

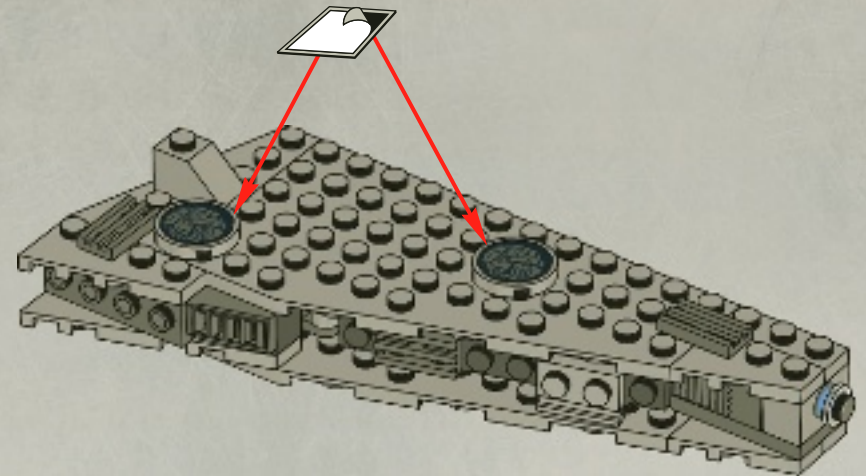

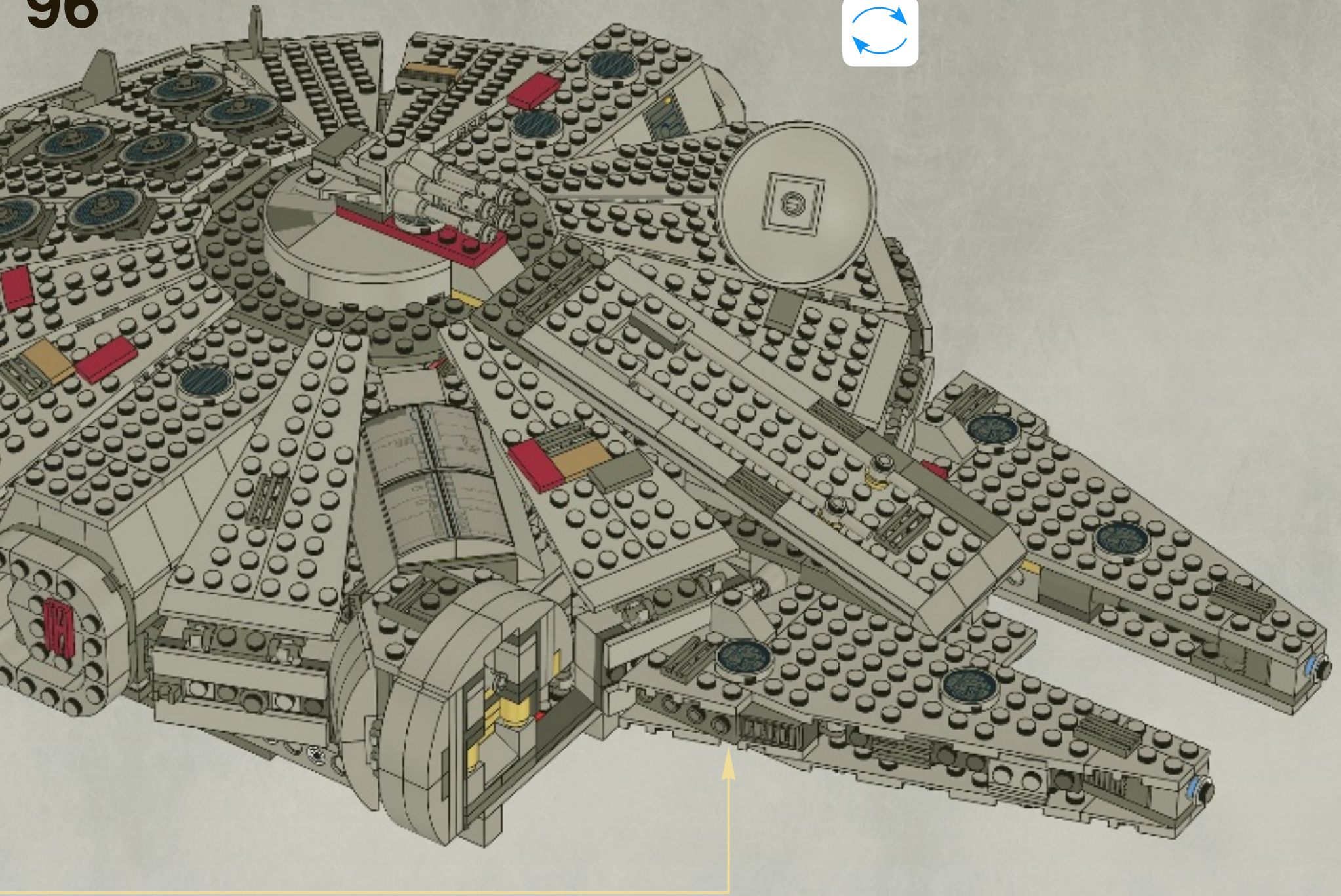



1



2

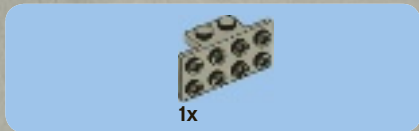
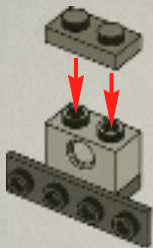

3



4

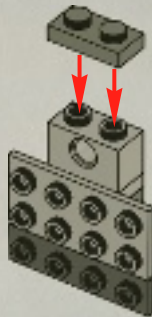

5

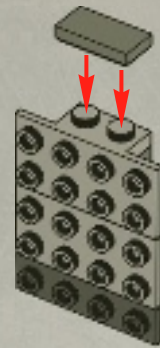

6

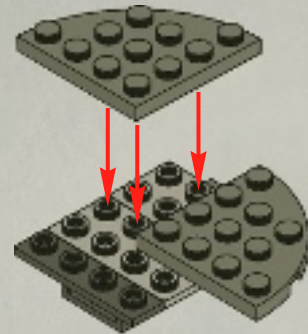



1x

7

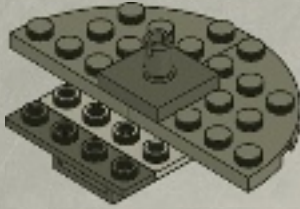

2x

8

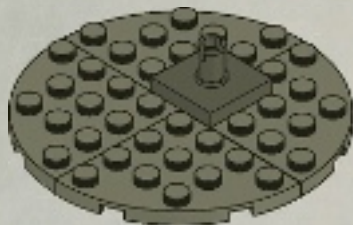

1x



2x

9

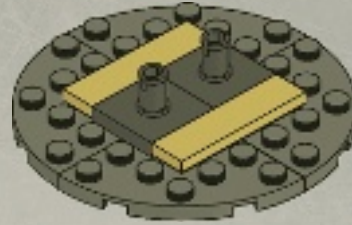

4x

10

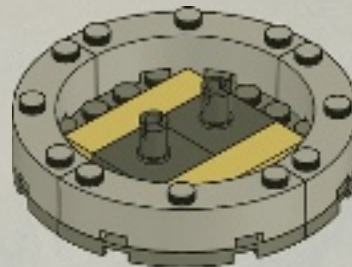

2x

11

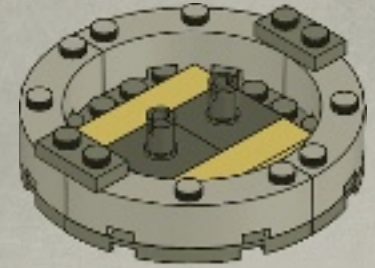

4x

12

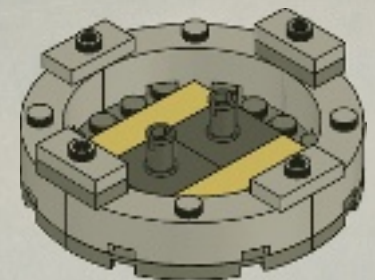

97

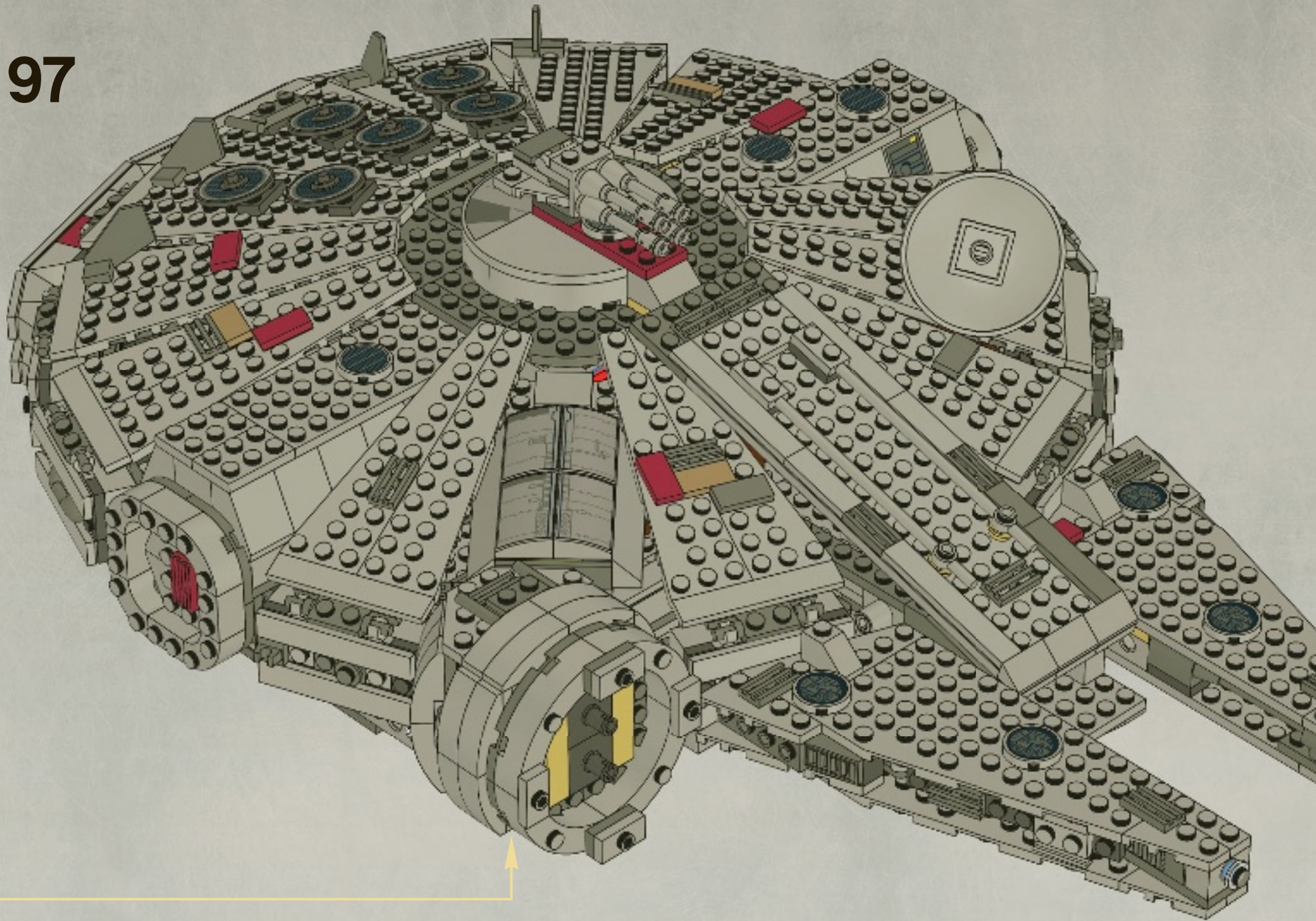



1x

1

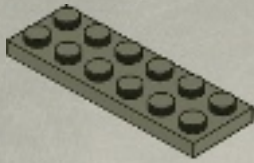

1x

2

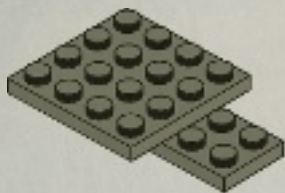

1x



1x

3

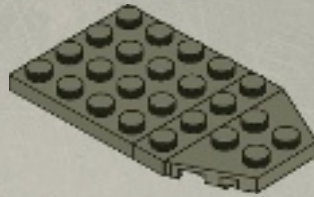

1x



2x

4

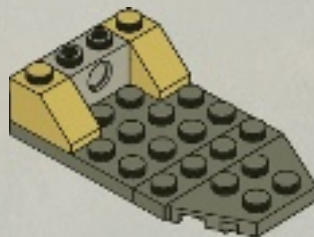

1x



1x



2x

5

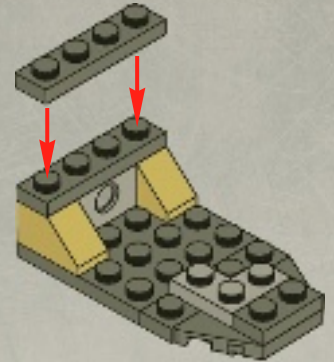

2x



1x



1x

6

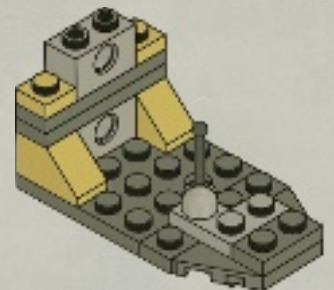





7

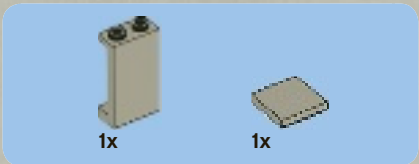
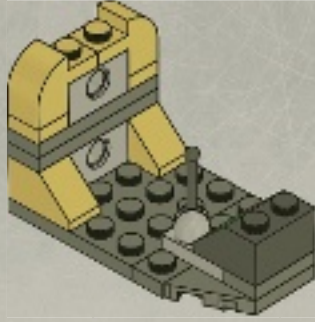

8

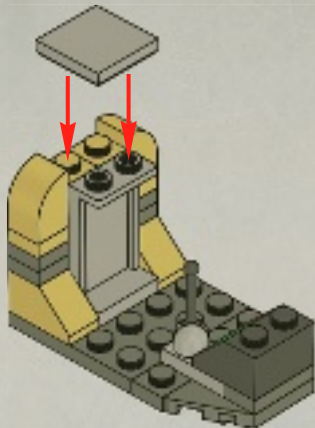

9

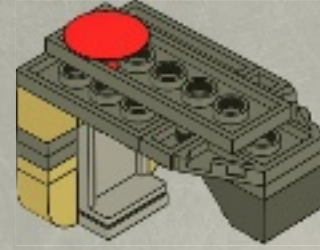

10



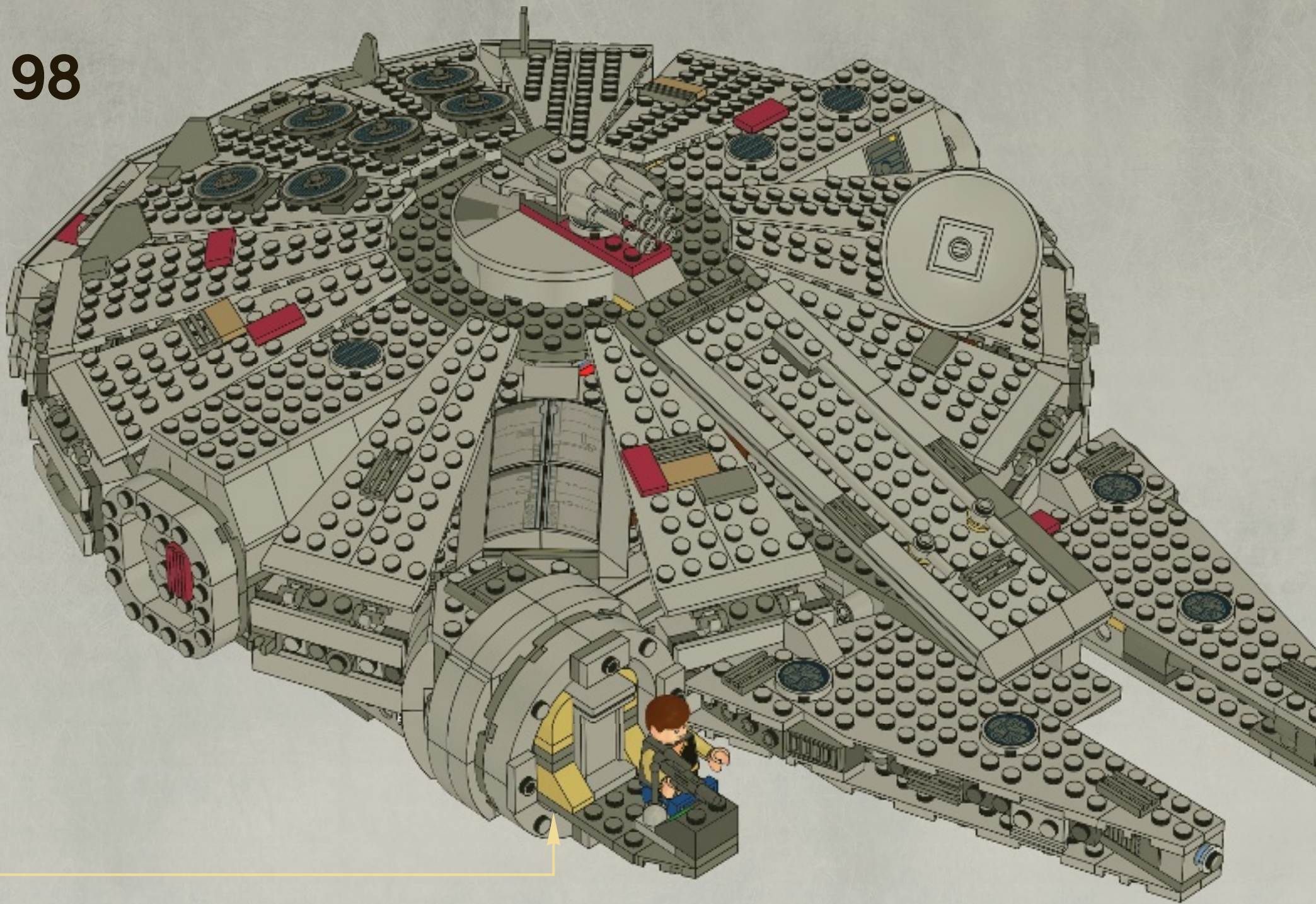



99

1

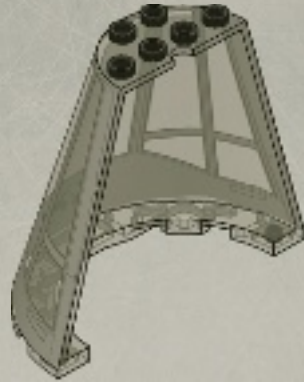

2

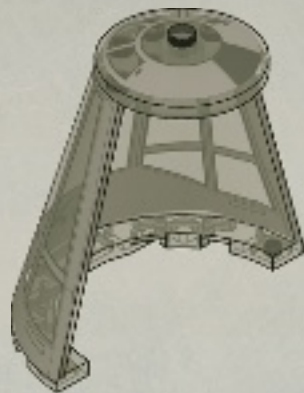

3

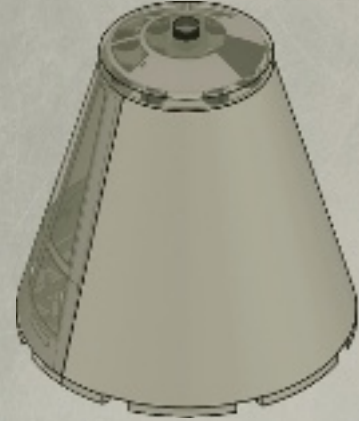

4

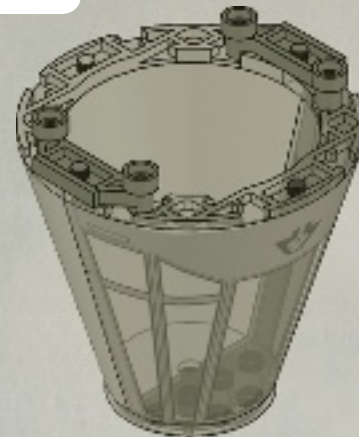

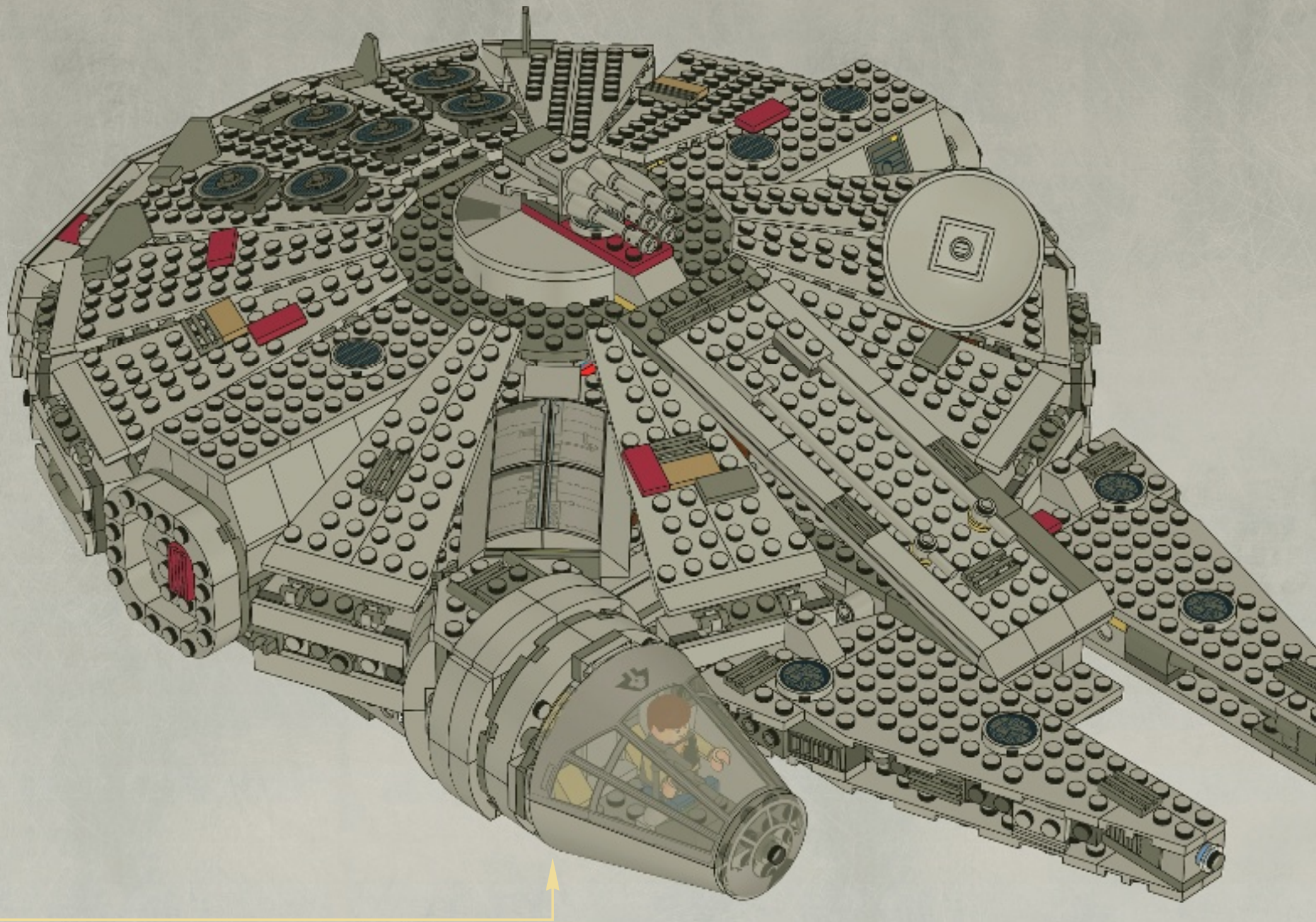

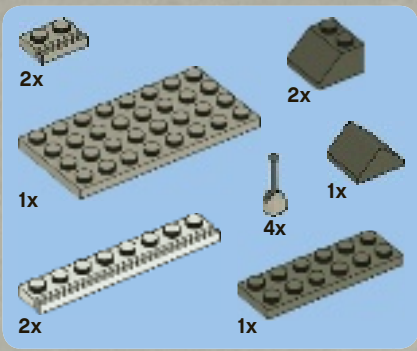

# 100

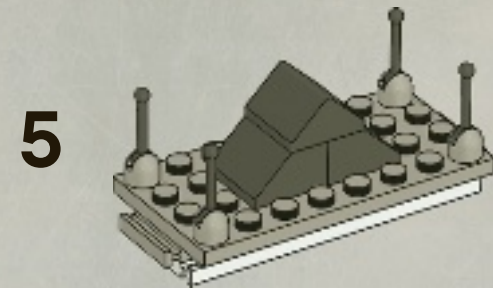
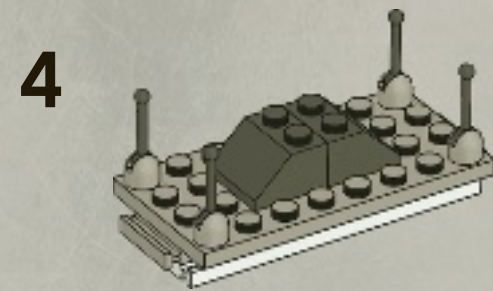
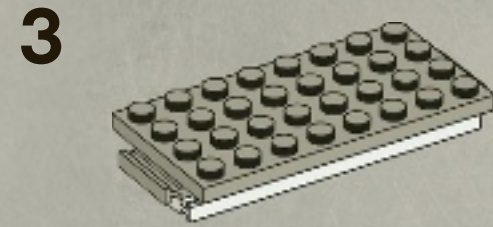
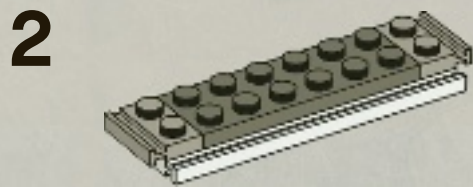
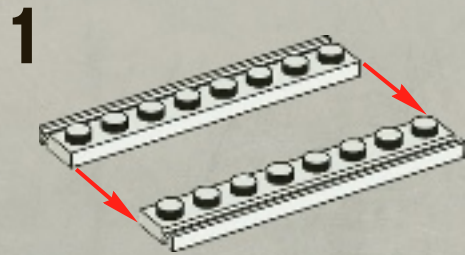

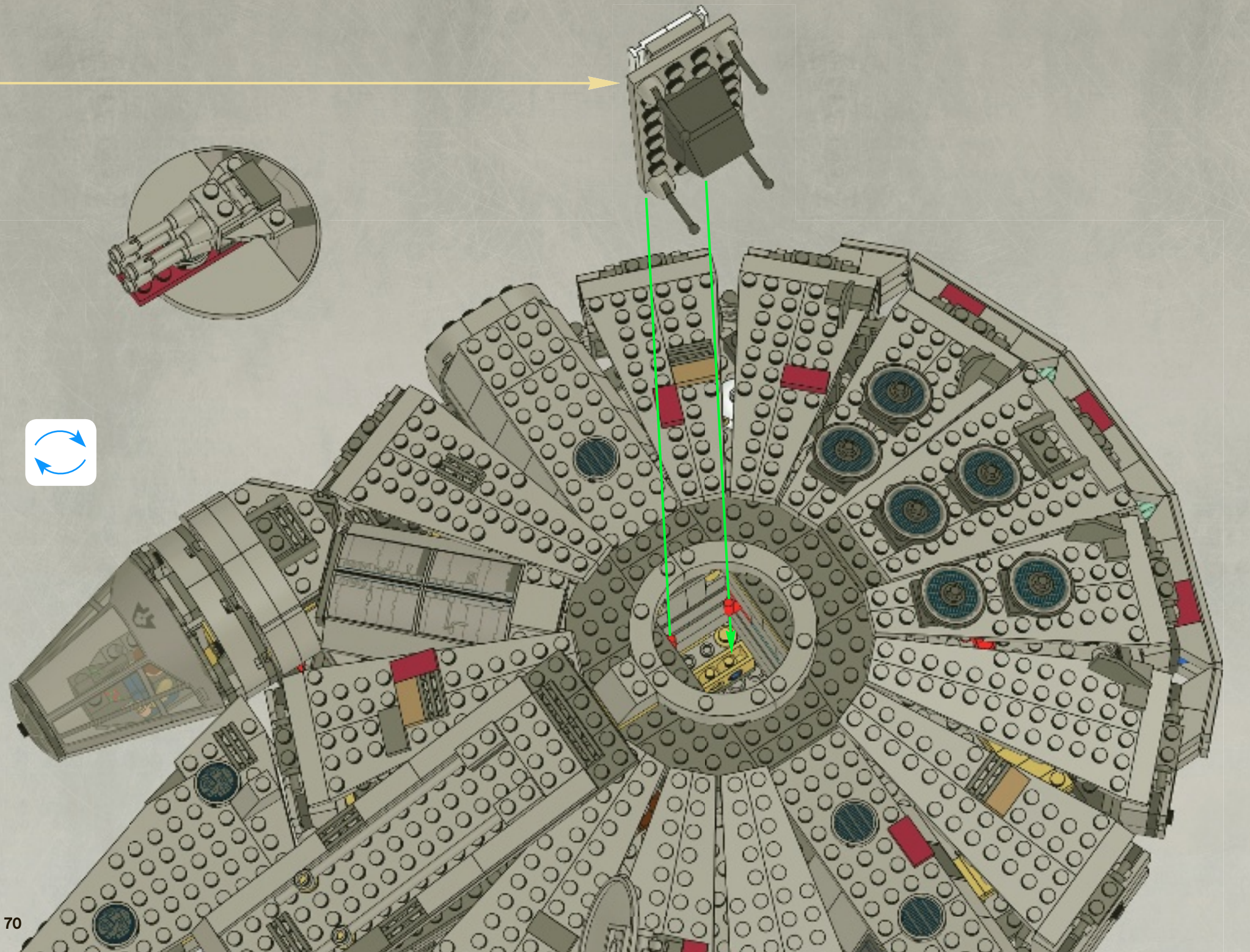
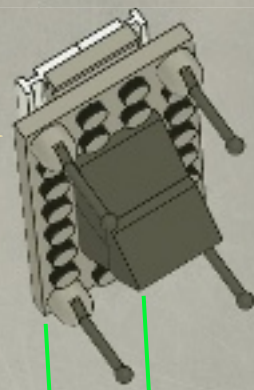
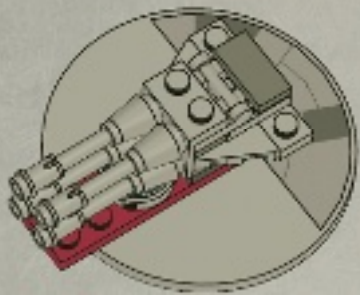

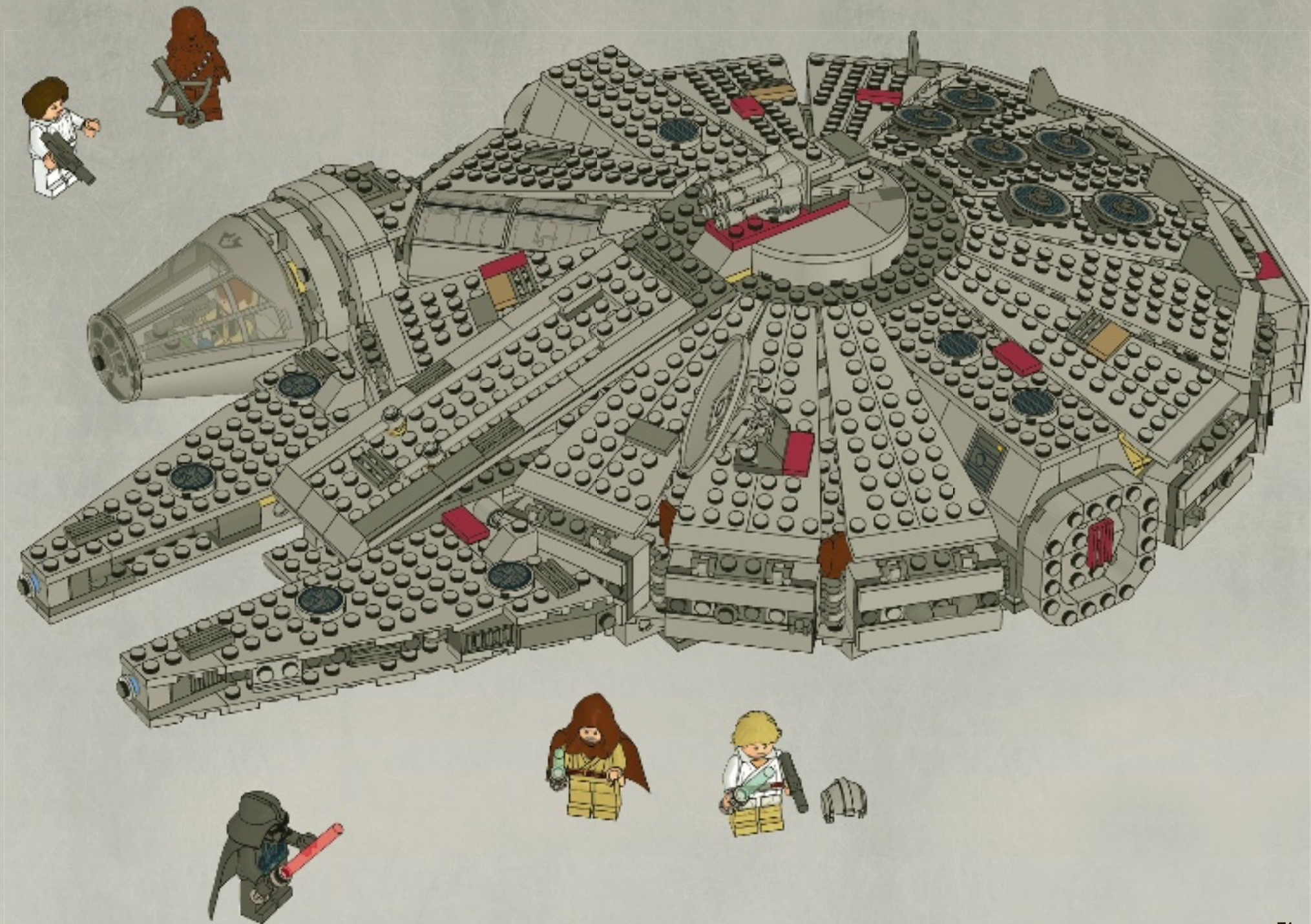

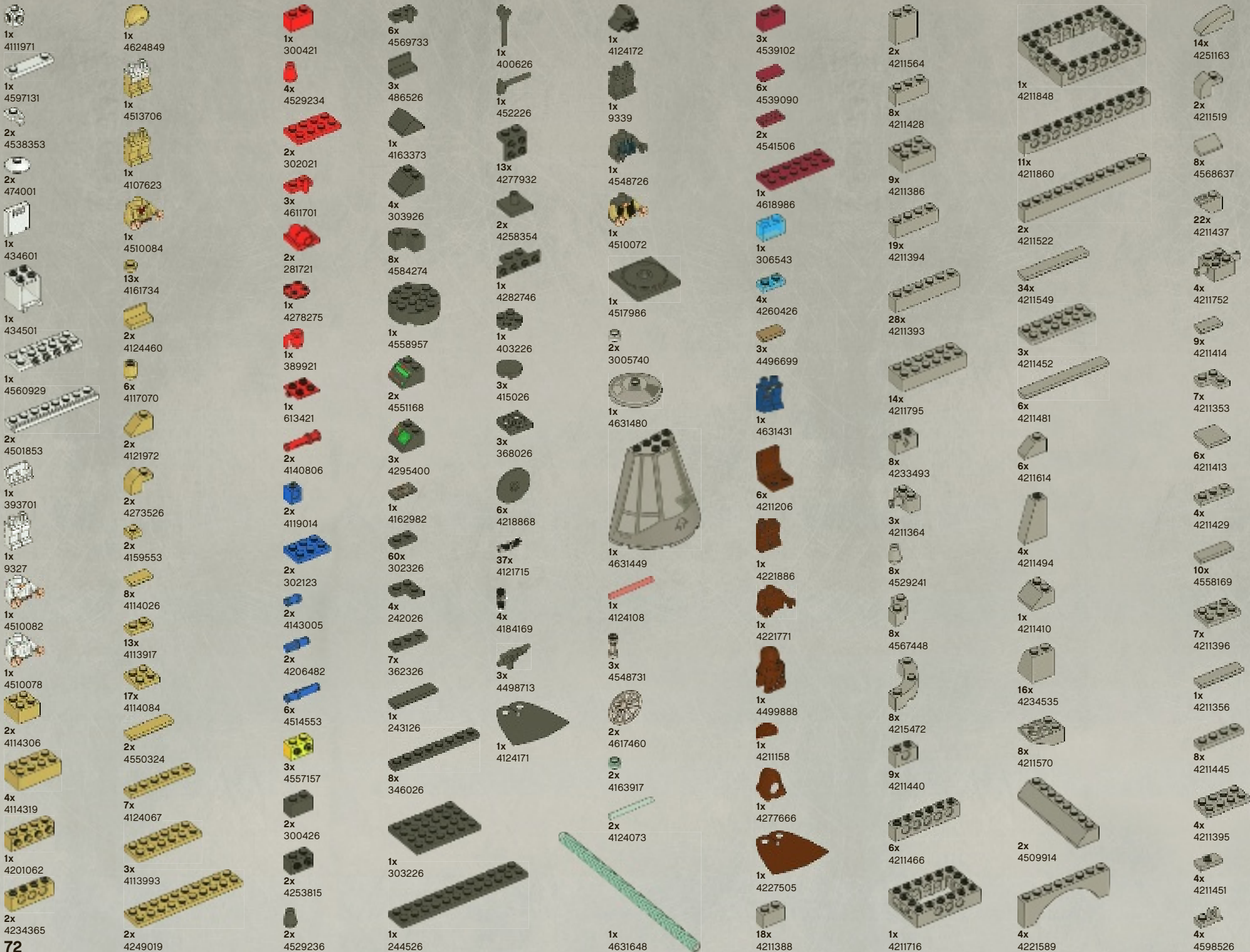

1x 4111971  
 1x 4597131  
 2x 4538353  
 2x 474001  
 1x 434601  
 1x 434501  
 1x 4560929  
 2x 4501853  
 1x 393701  
 1x 9327  
 1x 4510082  
 1x 4510078  
 2x 4114306  
 4x 4114319  
 1x 4201062  
 2x 4234365

1x 4624849  
 1x 4513706  
 1x 4107623  
 1x 4510084  
 13x 4161734  
 2x 4124460  
 6x 4117070  
 2x 4121972  
 2x 4273526  
 2x 4159553  
 8x 4114026  
 13x 4113917  
 17x 4114084  
 2x 4550324  
 7x 4124067  
 3x 4113993  
 2x 4249019

1x 300421  
 4x 4529234  
 2x 302021  
 3x 4611701  
 2x 281721  
 1x 4278275  
 1x 389921  
 1x 613421  
 2x 4140806  
 2x 4119014  
 2x 302123  
 2x 4143005  
 2x 4206482  
 6x 4514553  
 3x 4557157  
 2x 300426  
 2x 4253815  
 2x 4529236

6x 4569733  
 3x 486526  
 1x 4163373  
 4x 303926  
 8x 4584274  
 1x 4558957  
 2x 4551168  
 3x 4295400  
 1x 4162982  
 60x 302326  
 4x 242026  
 7x 362326  
 1x 243126  
 8x 346026  
 1x 303226  
 1x 244526

1x 400626  
 1x 452226  
 13x 4277932  
 2x 4258354  
 1x 4282746  
 1x 403226  
 3x 415026  
 3x 368026  
 6x 4218868  
 37x 4121715  
 4x 4184169  
 3x 4498713  
 1x 4124171

1x 4124172  
 1x 9339  
 1x 4548726  
 1x 4510072  
 1x 4517986  
 2x 3005740  
 1x 4631480  
 1x 4631449  
 1x 4124108  
 3x 4548731  
 2x 4617460  
 2x 4163917  
 2x 4124073  
 1x 4631648

3x 4539102  
 6x 4539090  
 2x 4541506  
 1x 4618986  
 1x 306543  
 4x 4260426  
 3x 4496699  
 1x 4631431  
 6x 4211206  
 1x 4221886  
 1x 4221771  
 1x 4499888  
 1x 4211158  
 1x 4277666  
 1x 4227505  
 18x 4211388

2x 4211564  
 8x 4211428  
 9x 4211386  
 19x 4211394  
 28x 4211393  
 14x 4211795  
 8x 4233493  
 3x 4211364  
 8x 4529241  
 8x 4567448  
 8x 4215472  
 9x 4211440  
 6x 4211466  
 1x 4211716

1x 4211848  
 11x 4211860  
 2x 4211522  
 34x 4211549  
 3x 4211452  
 6x 4211481  
 6x 4211614  
 4x 4211494  
 1x 4211410  
 16x 4234535  
 8x 4211570  
 2x 4509914  
 4x 4221589

14x 4251163  
 2x 4211519  
 8x 4568637  
 22x 4211437  
 4x 4211752  
 9x 4211414  
 7x 4211353  
 6x 4211413  
 4x 4211429  
 10x 4558169  
 7x 4211396  
 1x 4211356  
 8x 4211445  
 4x 4211395  
 4x 4211451  
 4x 4598526



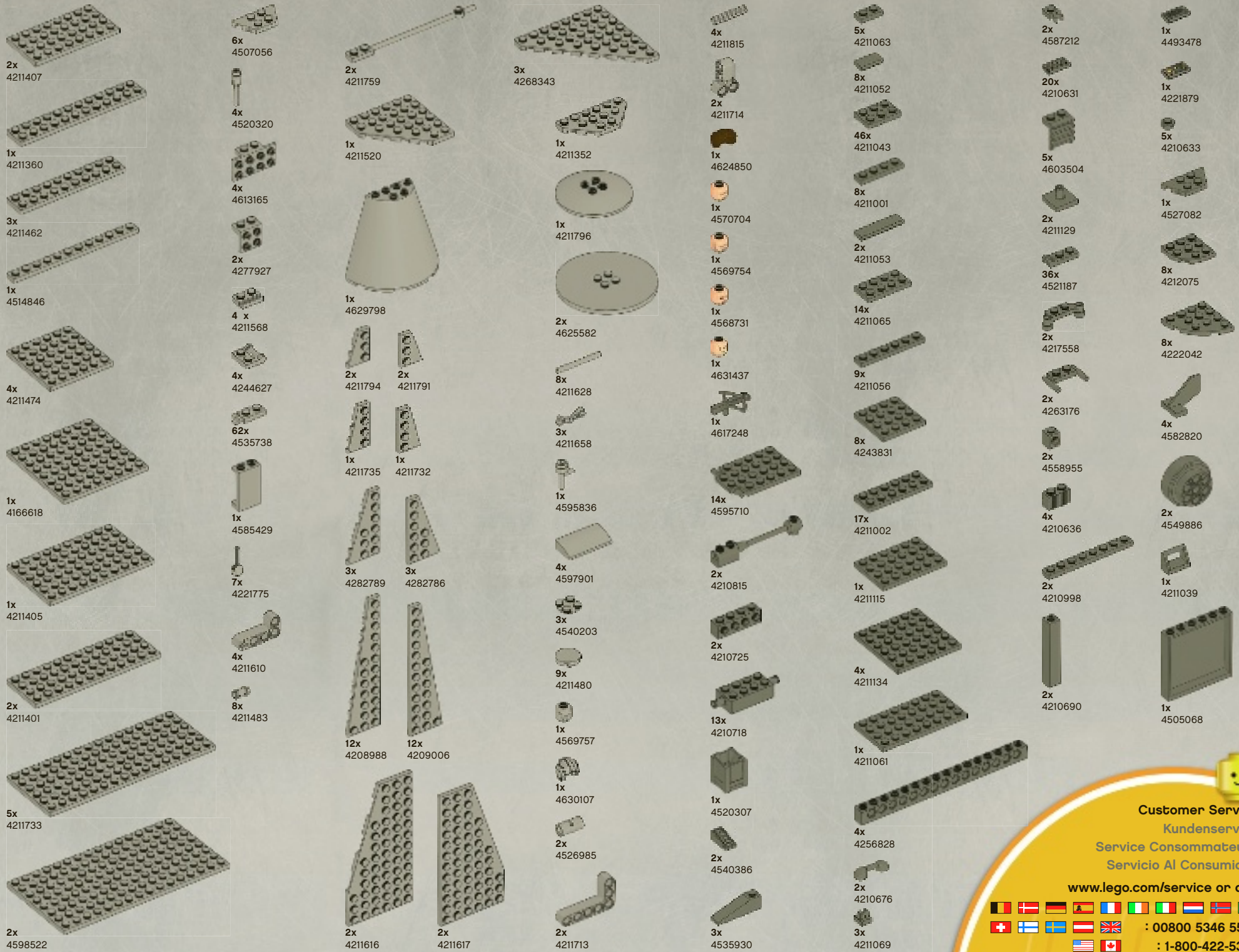

**Customer Service**  
**Kundenservice**  
**Service Consommateurs**  
**Servicio Al Consumidor**

[www.lego.com/service](http://www.lego.com/service) or dial

**: 00800 5346 5555**  
**: 1-800-422-5346**





Darth Vader™



Han Solo™



Luke Skywalker™



Chewbacca™



Obi-Wan Kenobi™



Princess  
Leia Organa™



7956



7957



7959



7961



7962



7964

# STAR WARS





# STAR WARS III

THE CLONE WARS™



[videogames.LEGO.com](http://videogames.LEGO.com)  
[www.LucasArts.com](http://www.LucasArts.com)

LucasArts and the LucasArts logo are registered trademarks of Lucasfilm Ltd. © 2006-2010, Lucasfilm Entertainment Company Ltd. or Lucasfilm Ltd. & © or TM as indicated. All rights reserved. LEGO, the LEGO logo and the Minifigure are trademarks of The LEGO Group. © 2005-2010 The LEGO Group. All rights reserved.





[www.LEGOclub.com](http://www.LEGOclub.com)



LEGO® Club Email



LEGO® Club Magazine

**LEGO club**™

**FREE! GRATIS! GRATUIT!**

**SIGN UP ONLINE!**

**[www.LEGOclub.com](http://www.LEGOclub.com)**

VISIT THE WORLD'S  
BIGGEST LEGO® SHOP!  
[www.LEGOshop.com](http://www.LEGOshop.com)

GO TO  
[www.LEGOclub.com](http://www.LEGOclub.com)

00800 5346 5555\*

1-866-534-6258 • 1-877-518-5346

US & Canada only

Canada seulement



\* Freephone. Mobile charges may apply.  
\* Numéro sans frais. Des frais peuvent s'appliquer avec les téléphones cellulaires.  
\* Gebührenfrei, Kosten für Anrufe aus Mobilfunknetzen können abweichen.  
\* Gratis telefoonnummer vanaf vaste lijn.  
\* Det er et gratis nummer, når du ringer fra fasttelefon.  
\* Det är gratis, när du ringer från en fast telefon.  
\* Numéro sans frais. Des frais peuvent s'appliquer avec les téléphones portables.



# WIN!

Go to [www.LEGOsurvey.com/product](http://www.LEGOsurvey.com/product) to fill out a survey for a chance to win a cool LEGO® Product. No purchase necessary. Open to all residents where not prohibited.

 [www.LEGO.com](http://www.LEGO.com)



## [www.LEGOsurvey.com/product](http://www.LEGOsurvey.com/product)

### GEWINNE!

Nimm an der Umfrage auf [www.LEGOsurvey.com/product](http://www.LEGOsurvey.com/product) LEGO teil und hab die Chance ein cooles LEGO® Produkt zu gewinnen!

Die Teilnahme am Gewinnspiel führt zu keinerlei Kaufverpflichtungen. Teilnahme in allen nicht ausgeschlossenen Ländern möglich.

### WIN!

Ga naar [www.LEGOsurvey.com/product](http://www.LEGOsurvey.com/product), vul een enquêteformulier in en maak kans op een cool LEGO® product.

Geen aankoopverplichting. Iedereen mag deelnemen, uitgezonderd ingezetenden van landen waar een enquêteverbod geldt.

### GAGNE!

Visite [www.LEGOsurvey.com/product](http://www.LEGOsurvey.com/product) pour répondre à un questionnaire et avoir une chance de gagner un produit LEGO® très cool!

Aucune obligation d'achat. Ouvert à tous les résidents des pays autorisés.

### 当てよう!

[www.LEGOsurvey.com/product](http://www.LEGOsurvey.com/product) にアクセスして、アンケートにご記入ください。当選者にはレゴ®製品を差し上げます。

お買い上げの必要はありません。禁止されていない限り、すべての皆様にご利用いただけます。