

LEGO

RACERS

7967



1

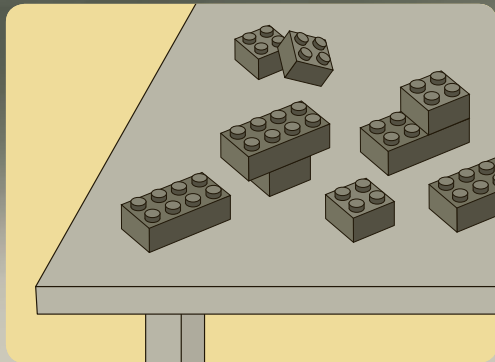

2





1

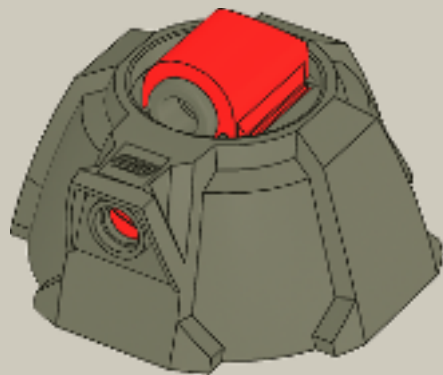

2

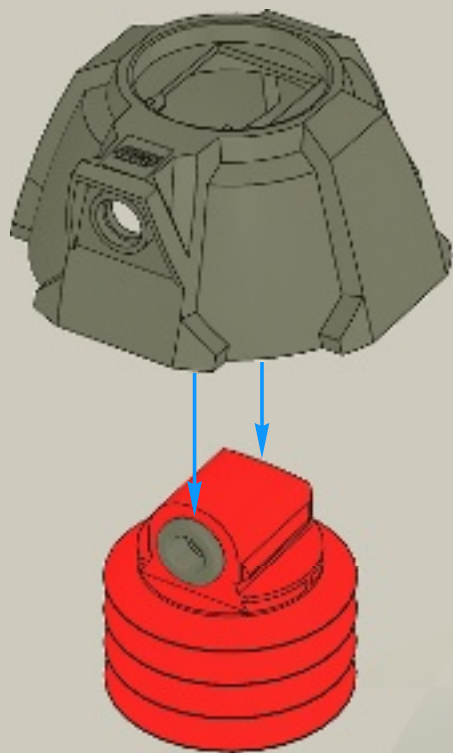

3

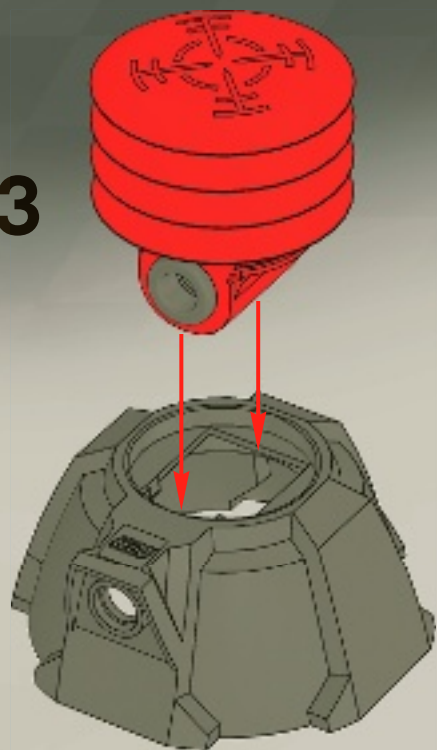

4

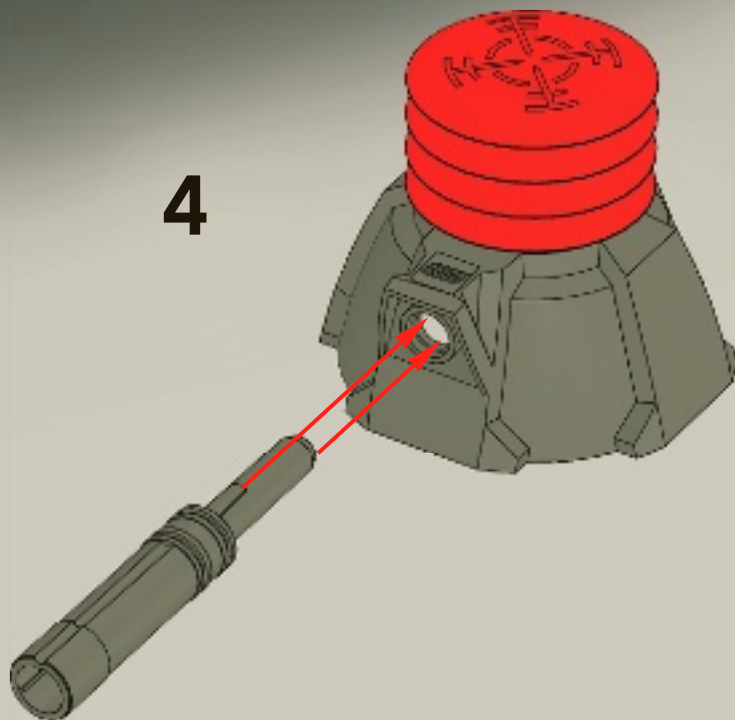



5

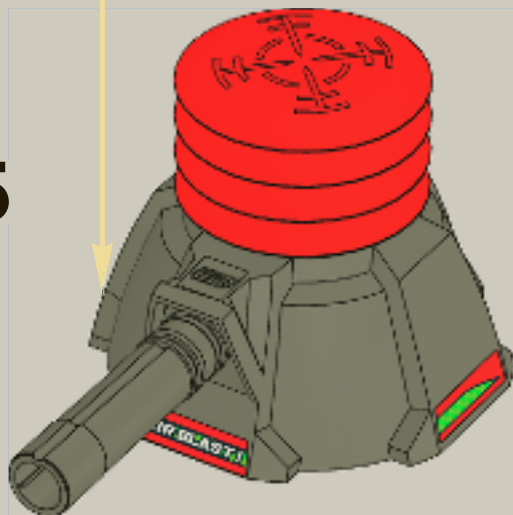



1

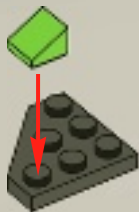

2

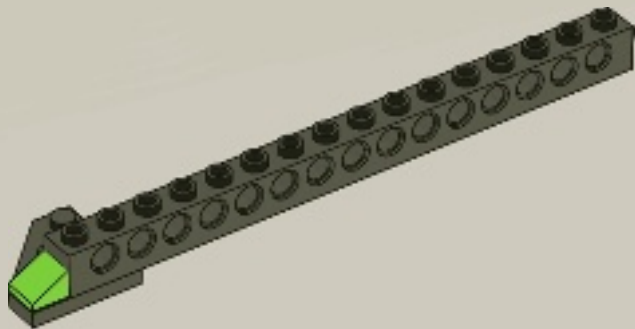

3

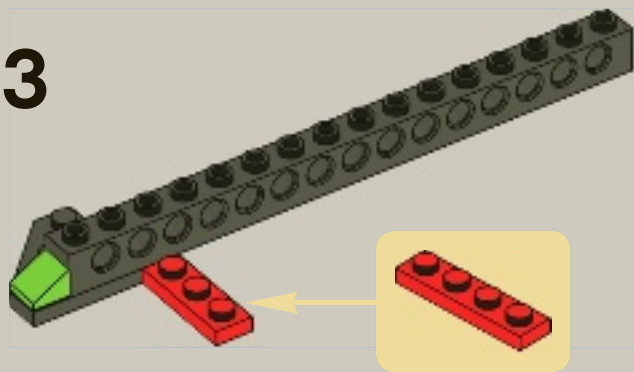

4

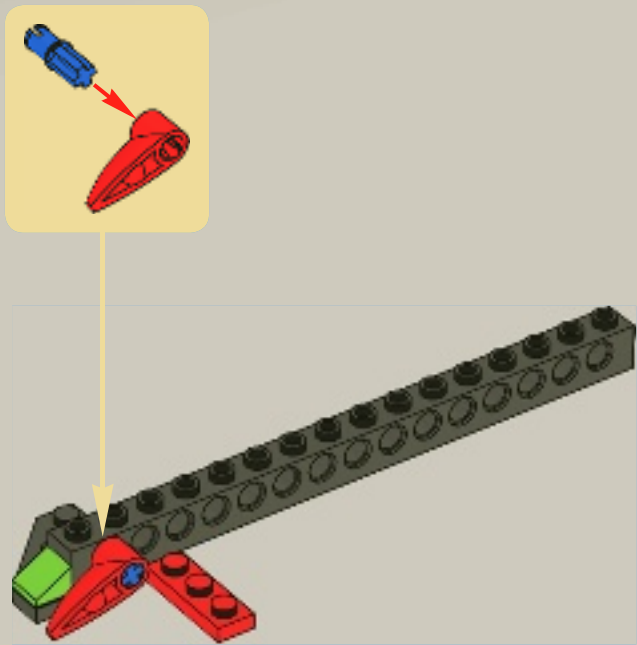

1

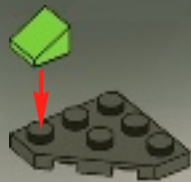

2

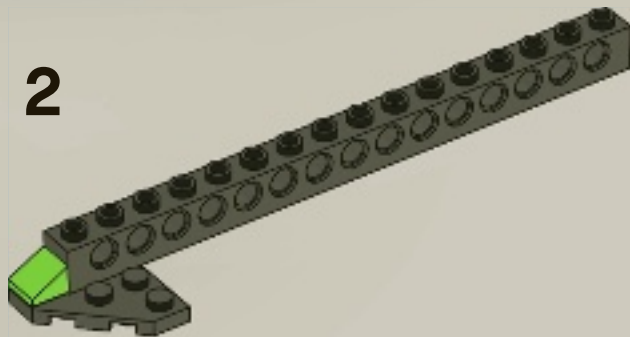

8

3

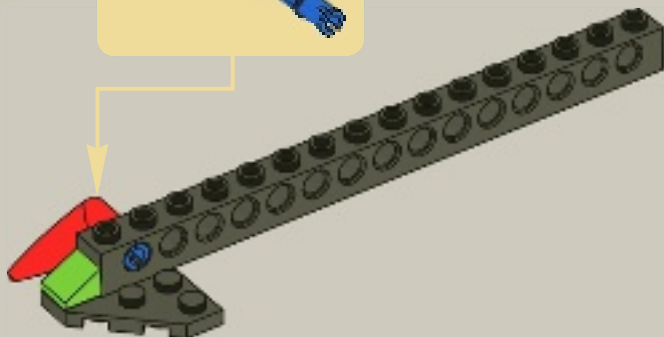
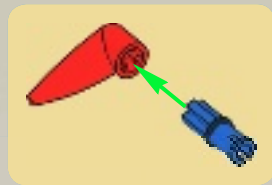

5

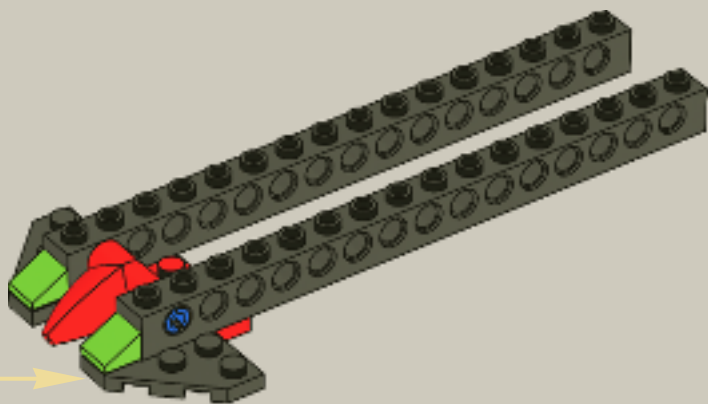

6

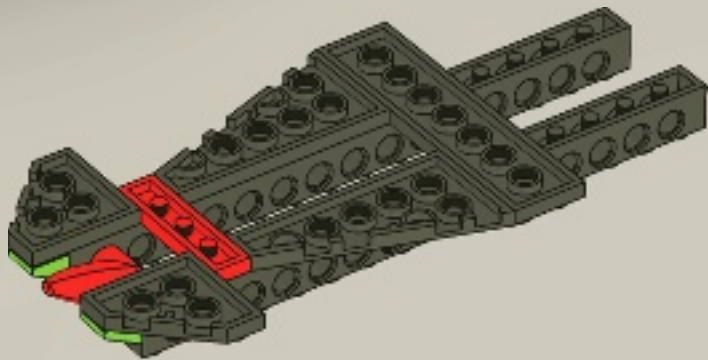

7

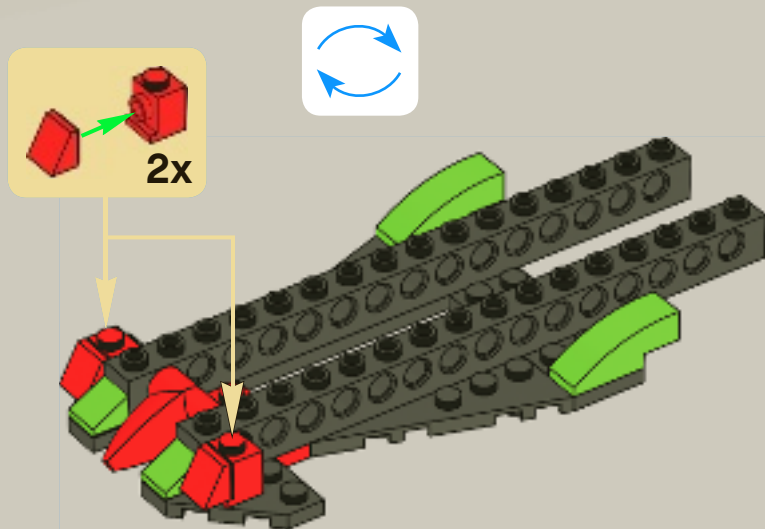

8

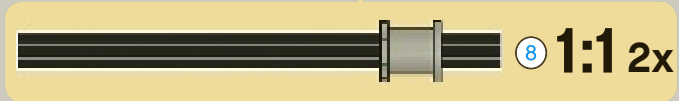
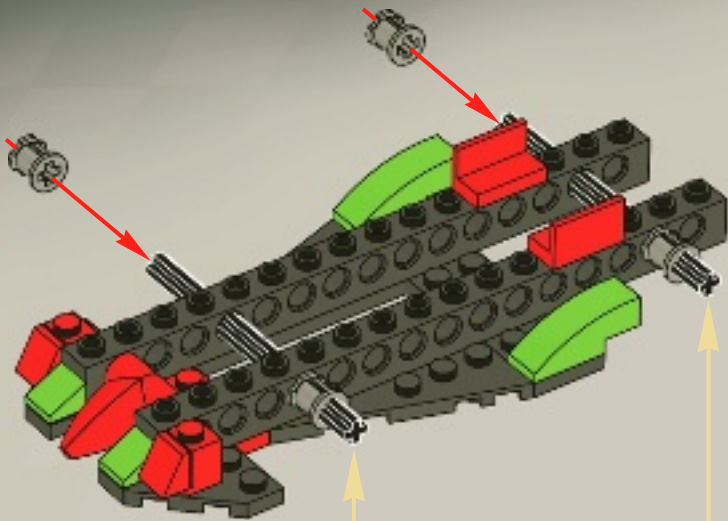

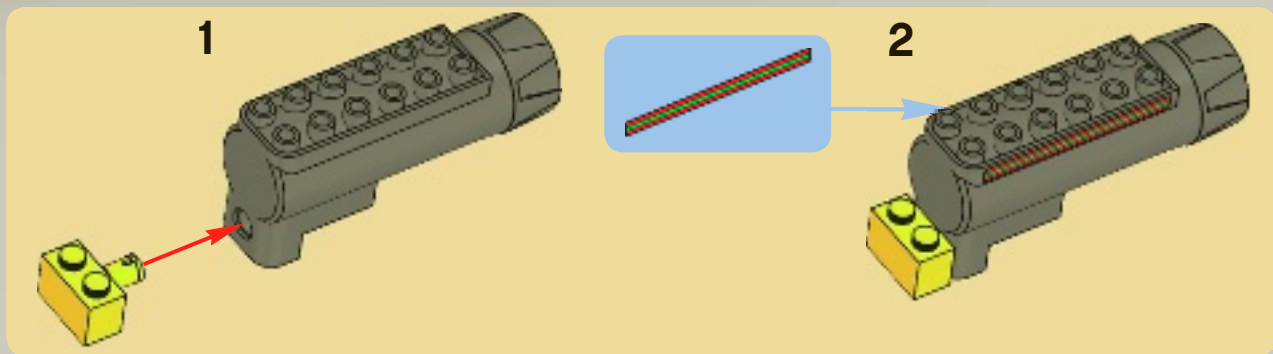

9

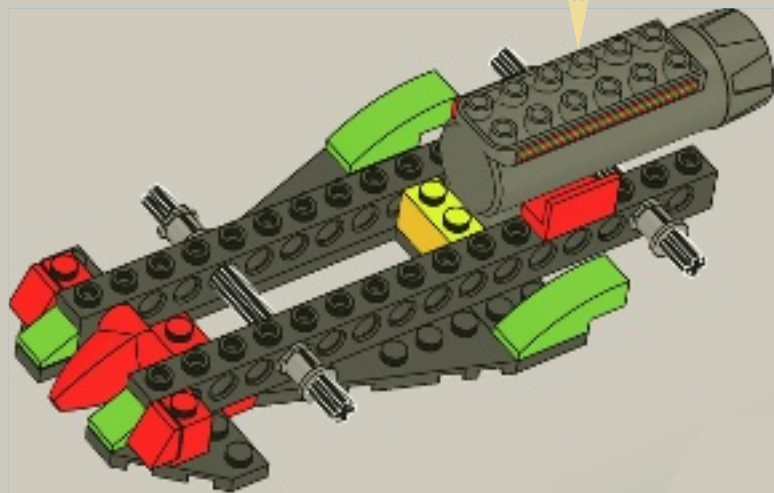

10

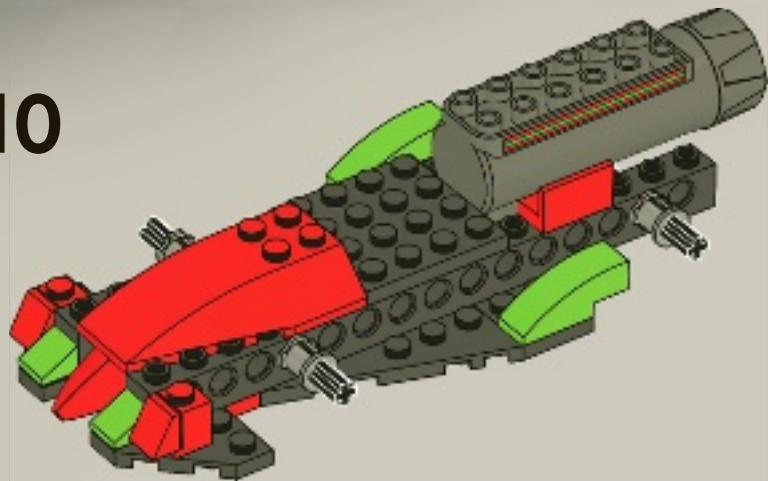

11

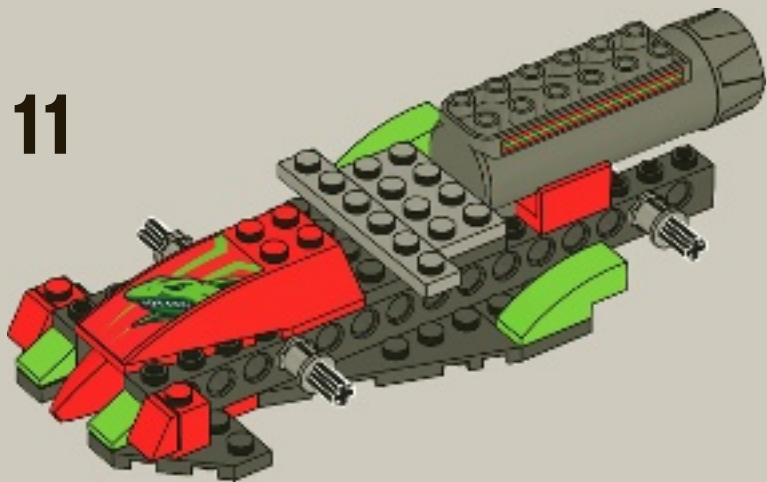

12

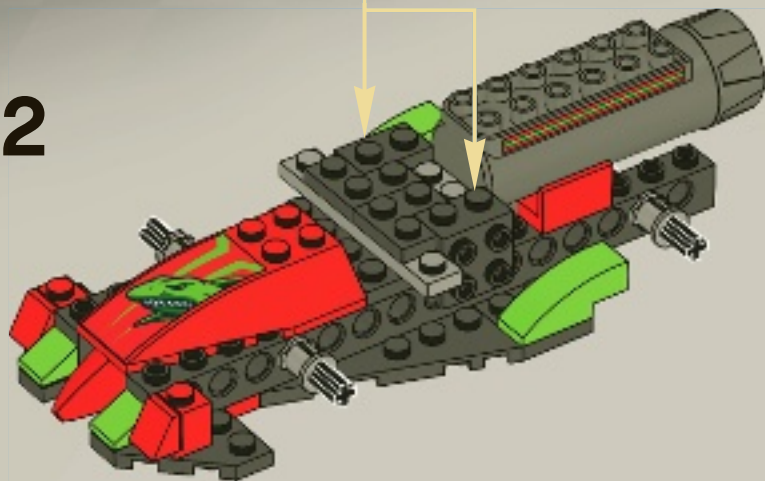

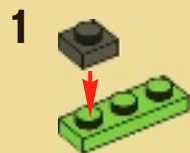

13

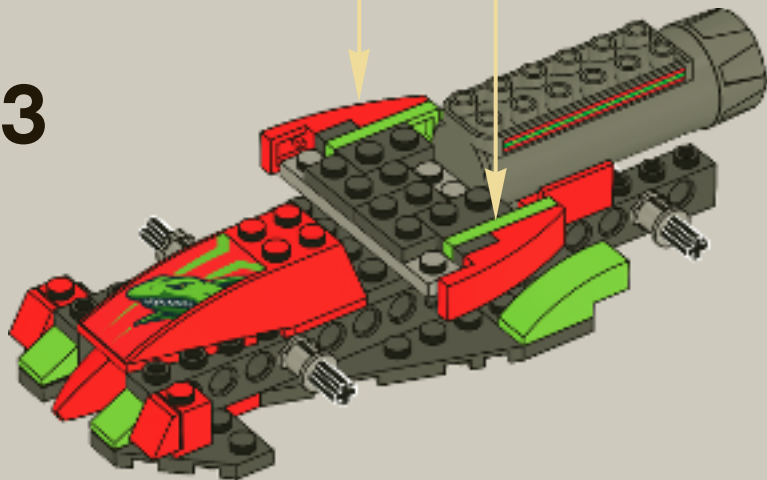

14

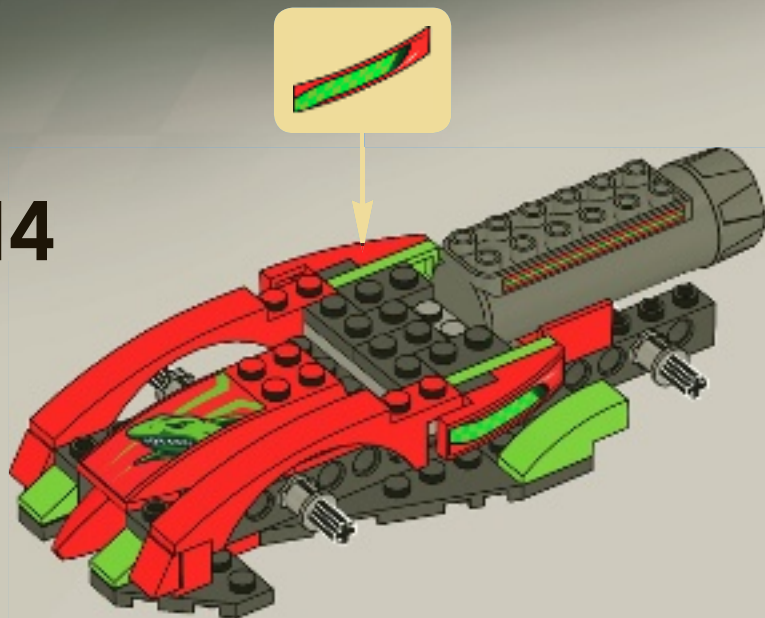

15

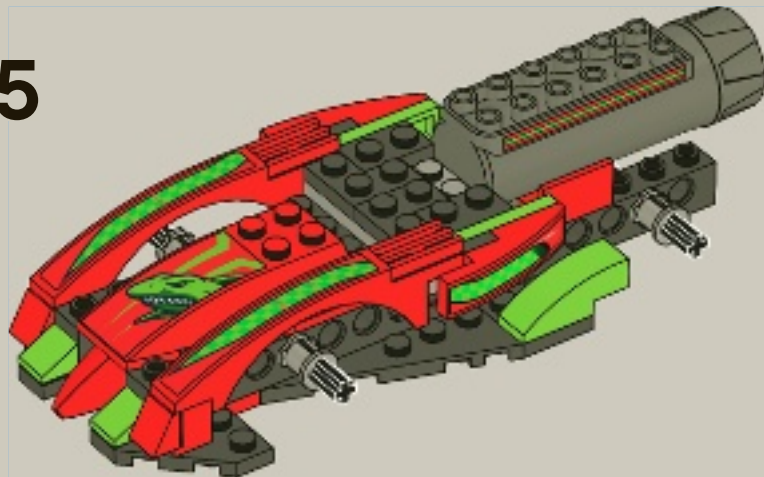

16

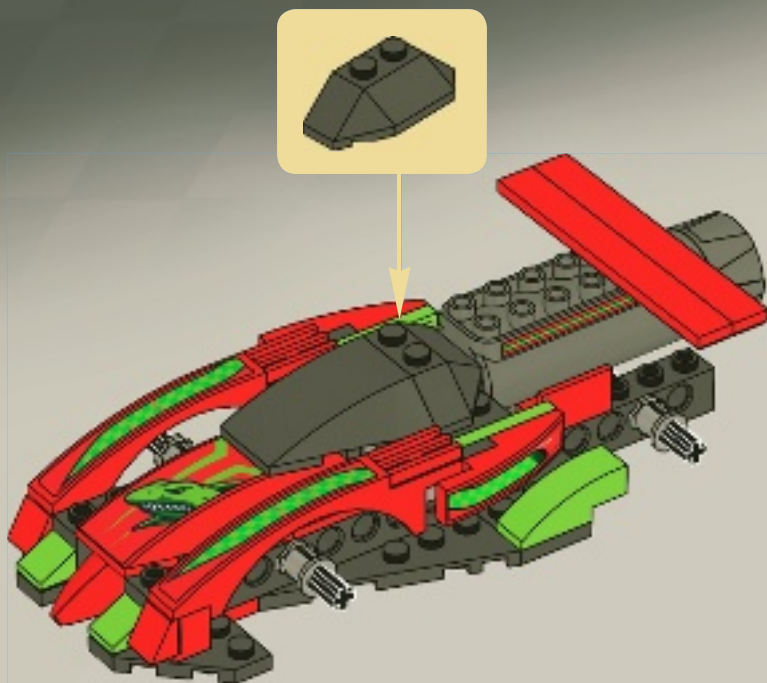

17

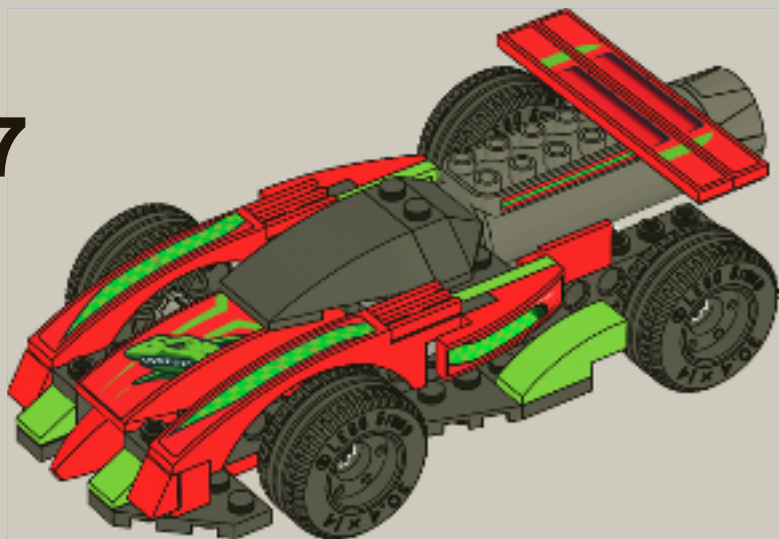

18

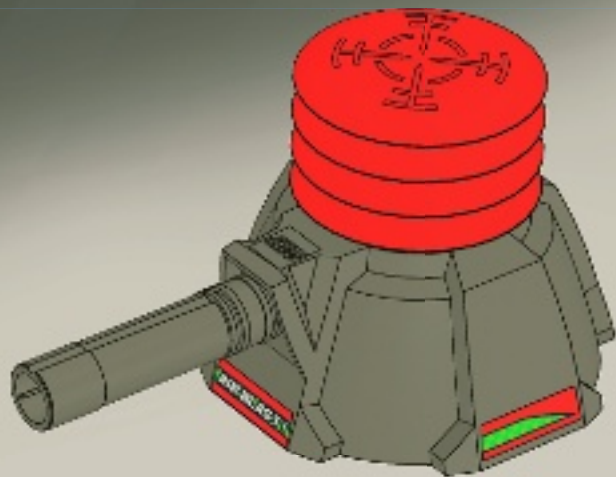

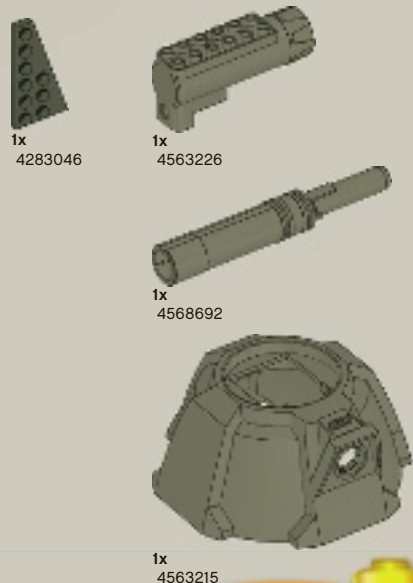

Customer Service
Kundenservice
Service Consommateurs
Servicio Al Consumidor

www.lego.com/service or dial

: 00800 5346 5555

: 1-800-422-5346



WIN!

Go to www.nielsen.com/LEGO
to fill out a survey for a chance
to win a cool LEGO® Product.

No purchase necessary.

Open to all residents where not prohibited.



www.LEGO.com

www.nielsen.com/LEGO

GEWINNE!

Nimm an der Umfrage auf
www.nielsen.com/LEGO
teil und hab die Chance ein cooles
LEGO® Produkt zu gewinnen!

Die Teilnahme am Gewinnspiel führt zu keinerlei
Kaufverpflichtungen. Teilnahme in allen nicht
ausgeschlossenen Ländern möglich.

WIN!

Ga naar www.nielsen.com/LEGO,
vul een enquêteformulier in en
maak kans op een
cool LEGO® product.

Geen aankoopverplichting.
Iedereen mag deelnemen, uitgezonderd
ingezetenden
van landen waar een enquêteverbod geldt.

GAGNE!

Visite www.nielsen.com/LEGO
pour répondre à un questionnaire
et avoir une chance de gagner
un produit LEGO® très cool!

Aucune obligation d'achat.
Ouvert à tous les résidents des pays
autorisés.

当てよう!

www.nielsen.com/LEGO
にアクセスして、
アンケートにご記入ください。
当選者にはレゴ®製品を
差し上げます。

お買い上げの必要はありません。
禁止されていない限り、すべての皆様にご利用いただけます。