

The LEGO logo is displayed in its characteristic white font with a black outline, set against a red rectangular background.

ATLANTIS

7984



WARNING: CHOKING HAZARD.
Toy contains small parts and a small ball.
Not for children under 3 years.

1

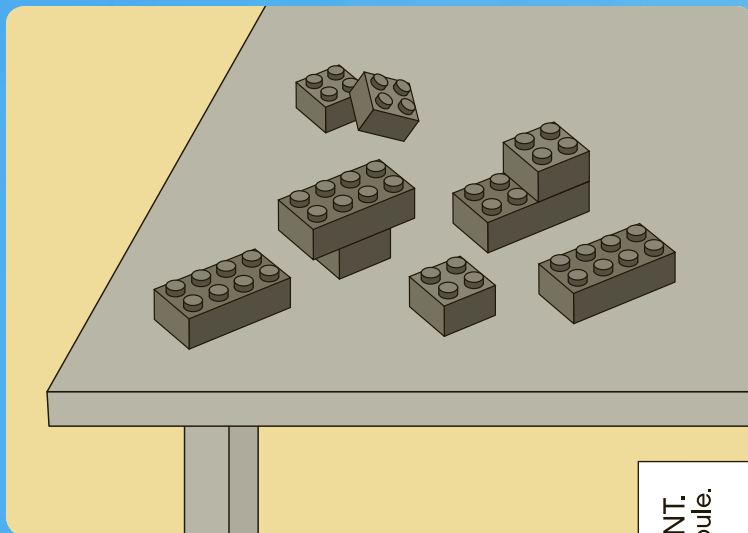
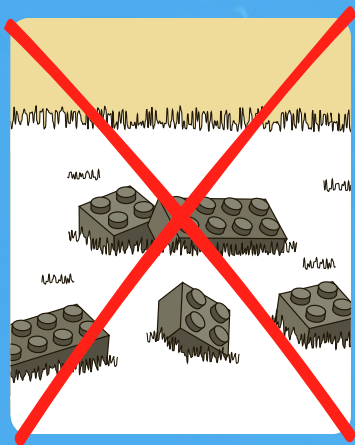

2



 **AVERTISSEMENT : RISQUE D'ÉTOUFFEMENT.**
Le jouet contient des petites pièces ainsi qu'une petite boule.
Il ne convient pas aux enfants de moins de 3 ans.

 **ADVERTENCIA: PELIGRO DE ASFIXIA.**
Juguete que contiene partes pequeñas y una pelota pequeña.
No recomendado para niños menores de 3 años.

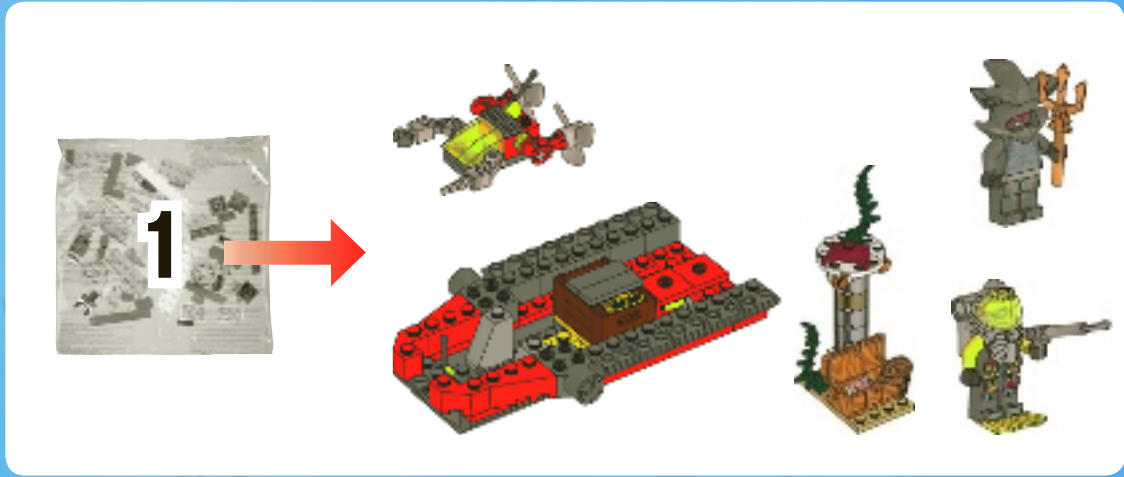

3



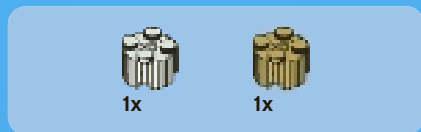
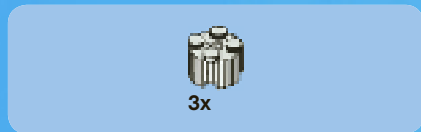



2x



1x

5



1x



2x

6

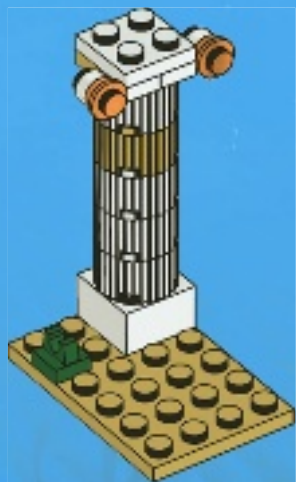

1x



1x

7



2x



1x

8



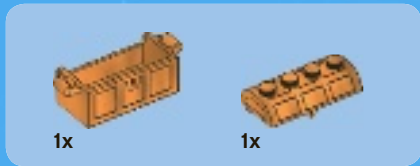

9

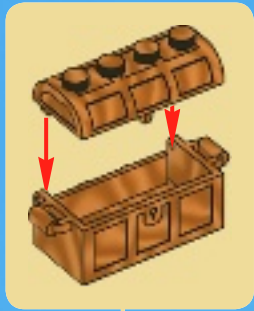

10





1x

1



2x



2x

2

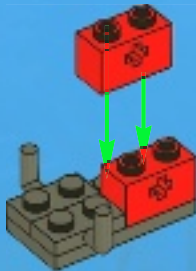

5

1:1



1x

5



1x

3

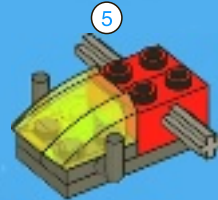

2x



2x

4

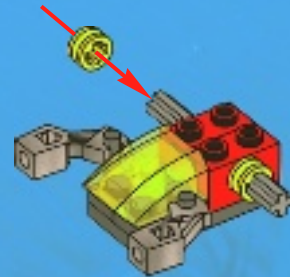



2x



1x

5

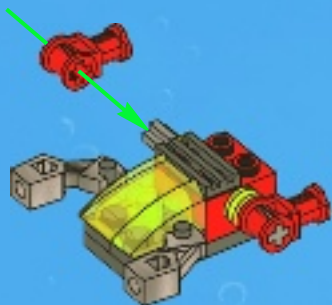

2x

6

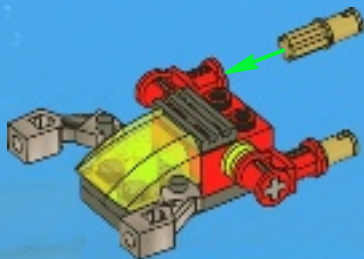

2x

7

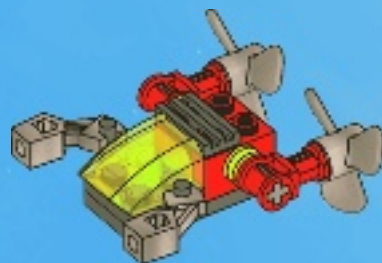

1x



1x



1x

8

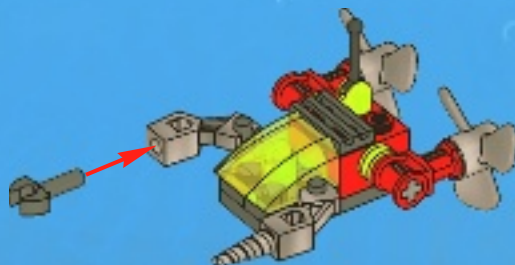

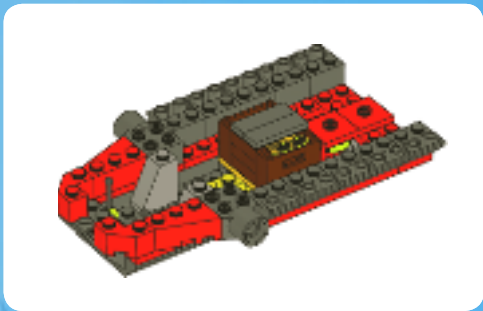

1

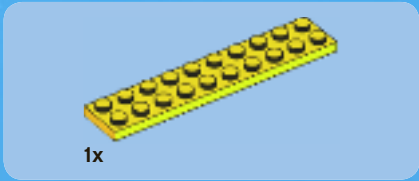
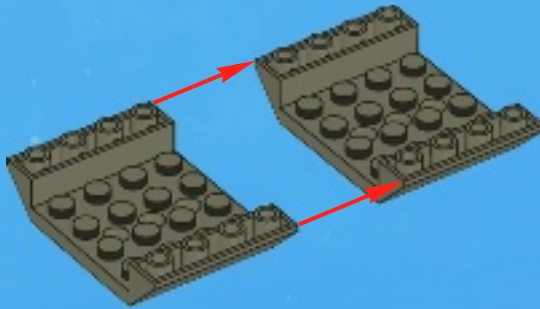

2

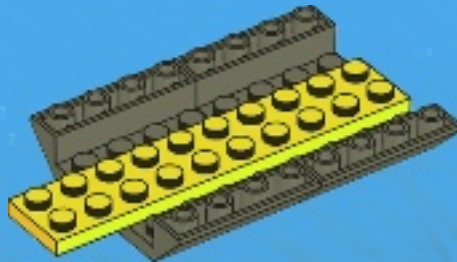

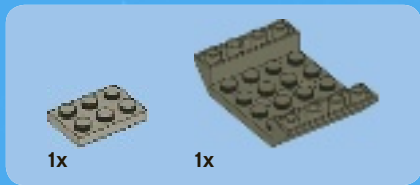

3

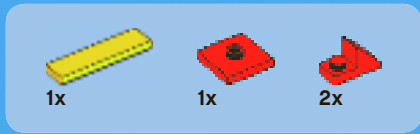
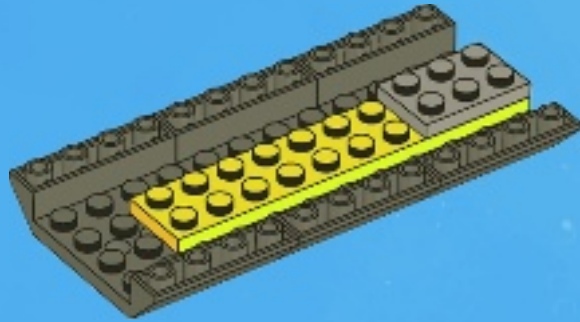

4

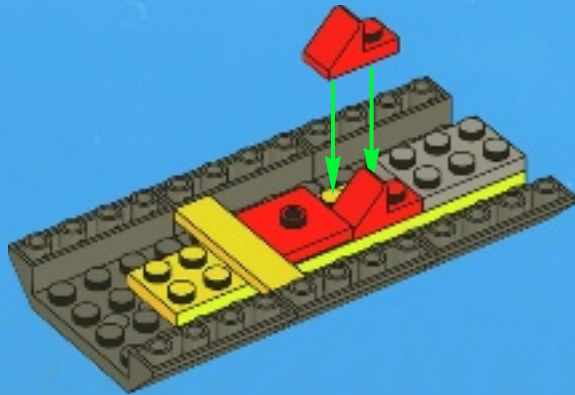



1x



1x

5

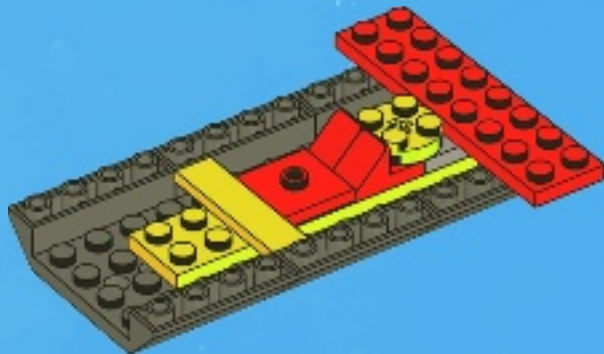

2x



2x

6

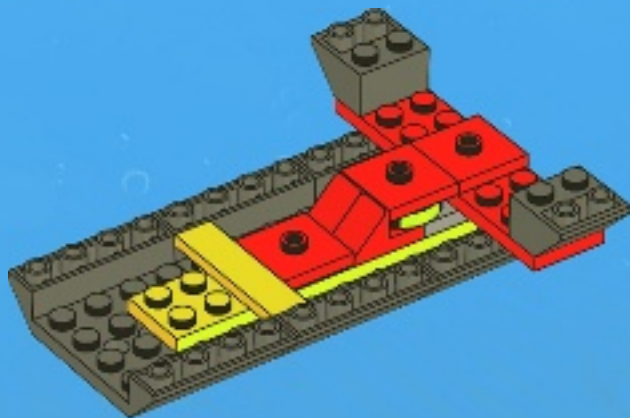



7

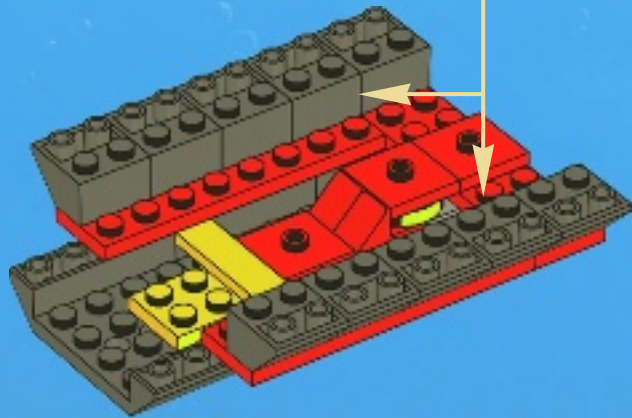
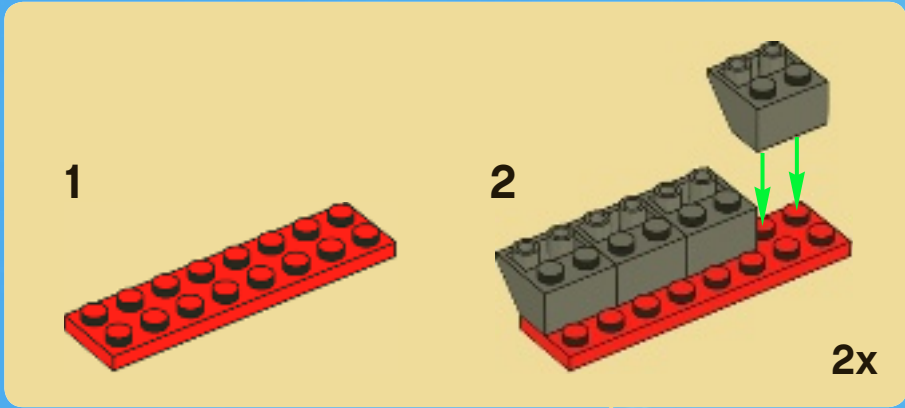



1x

8

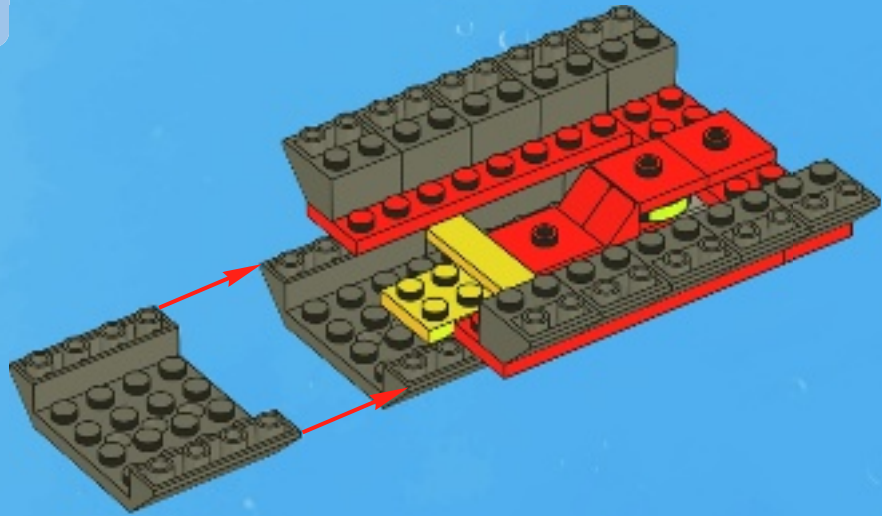

2x

9

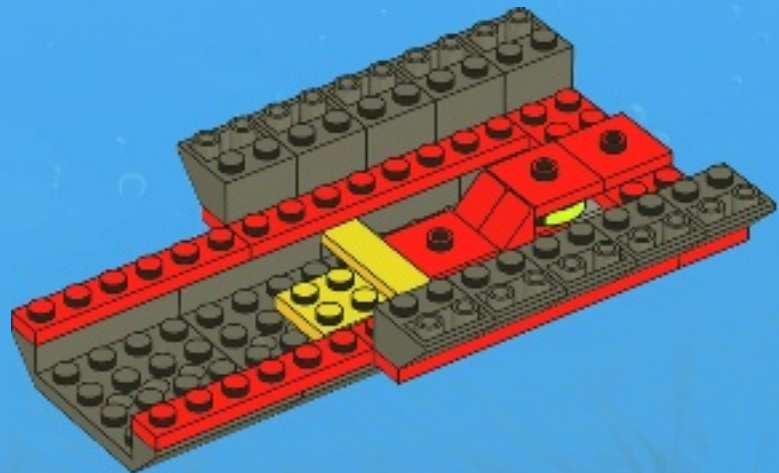



2x



2x



2x

10



2x

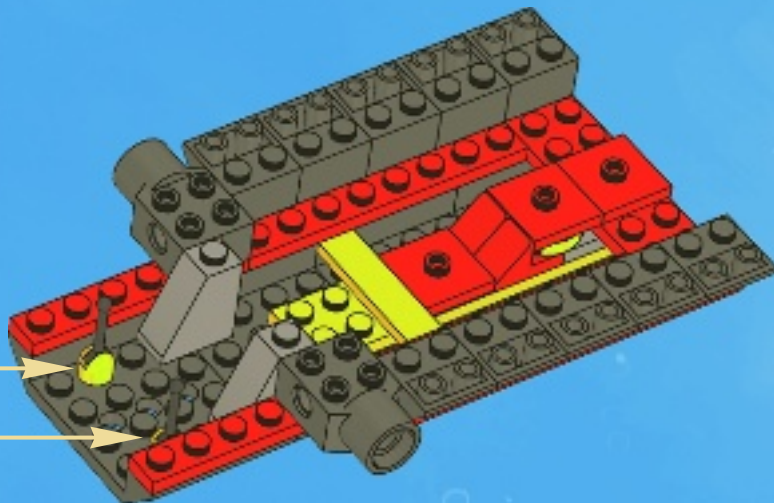

2x

11

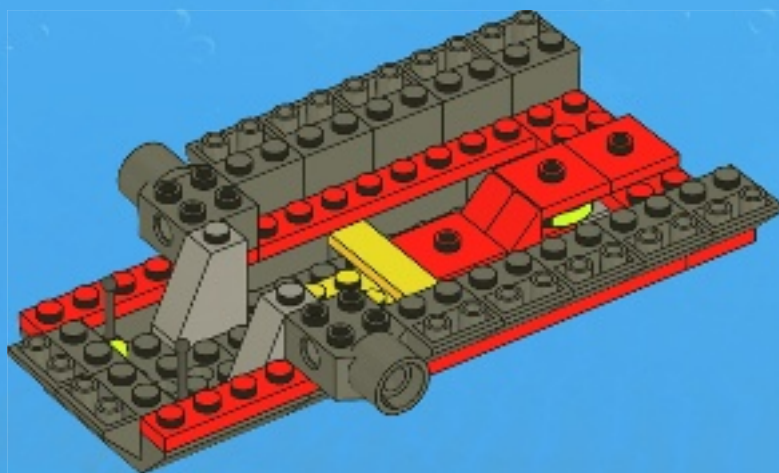



1x



1x



2x

12

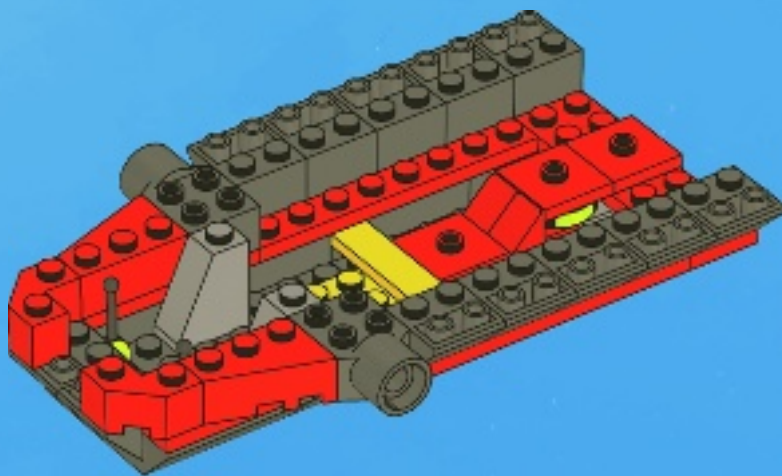

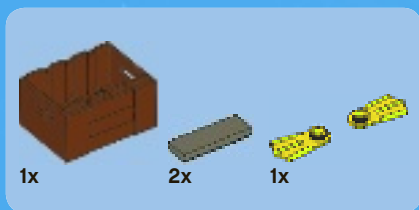

13

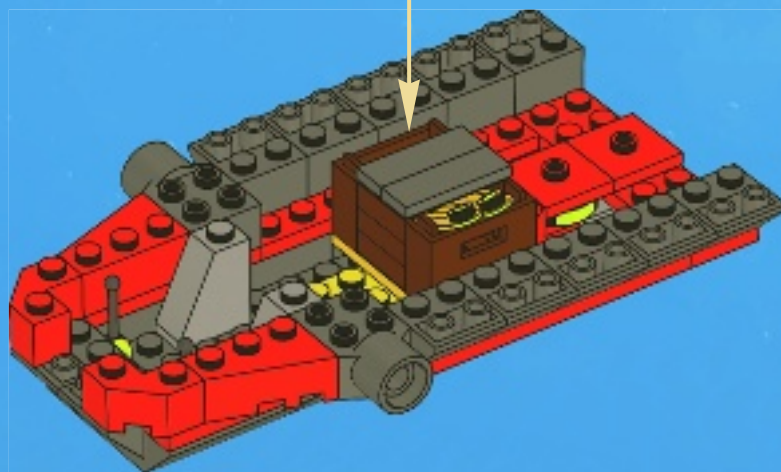



2



2x



1x

14

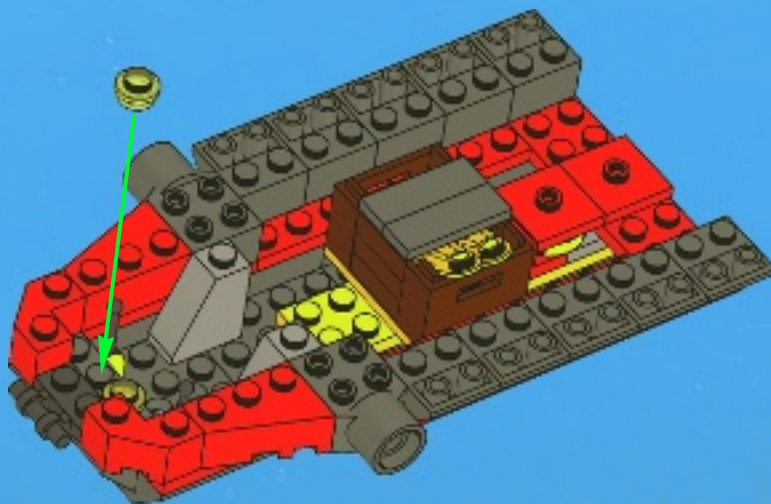



1x



1x

15

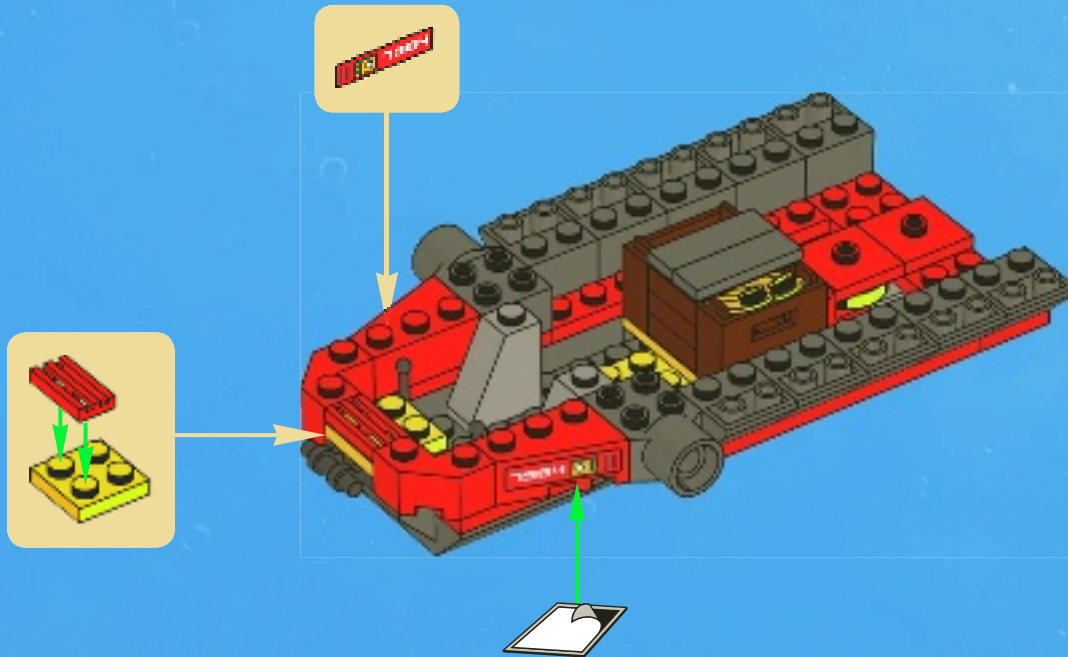



16

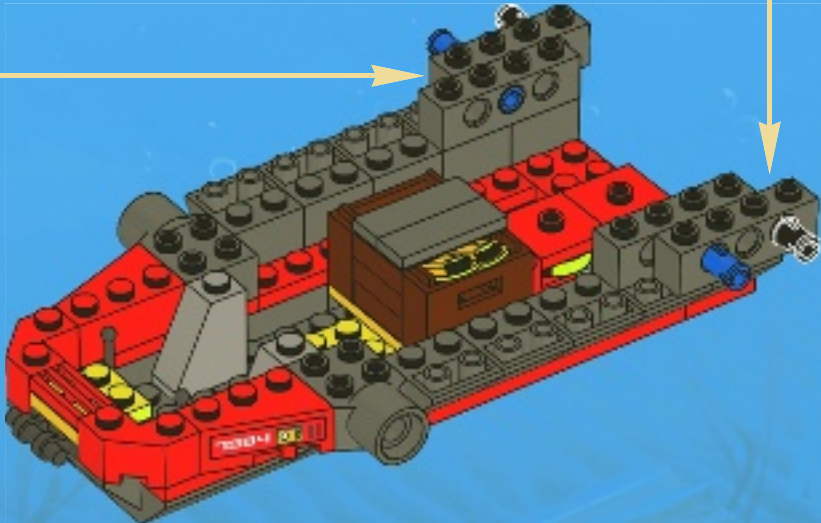
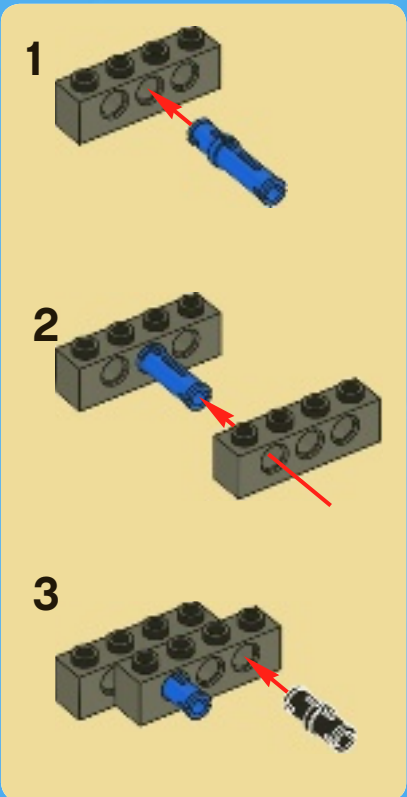
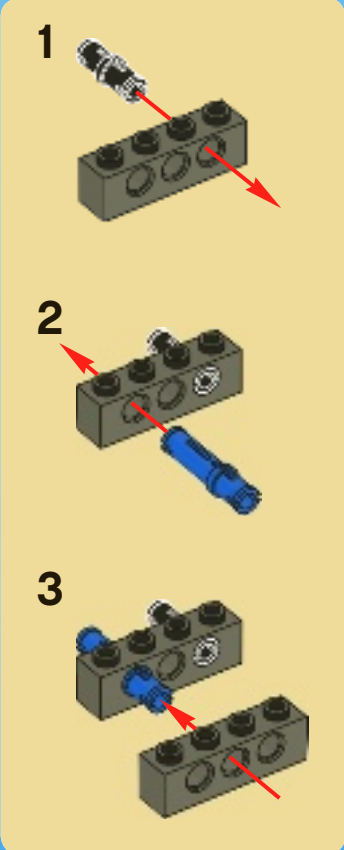

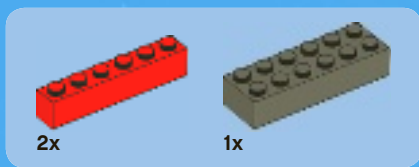

17

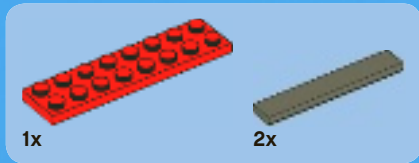
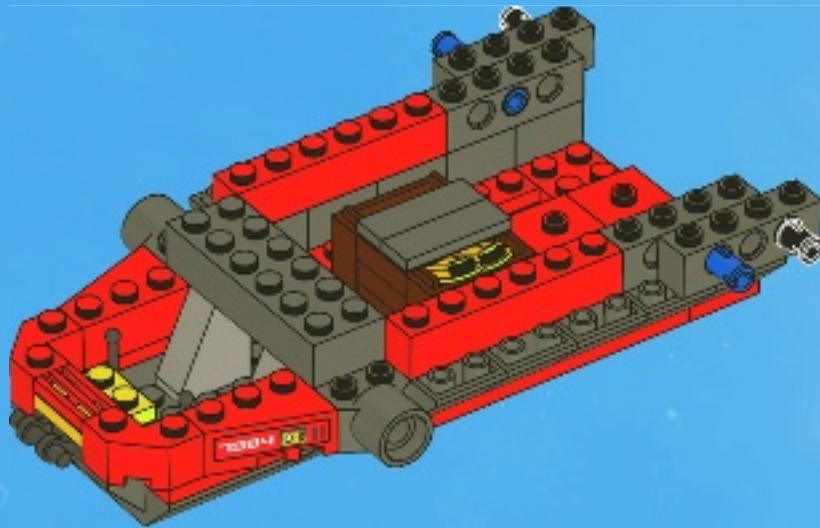

18

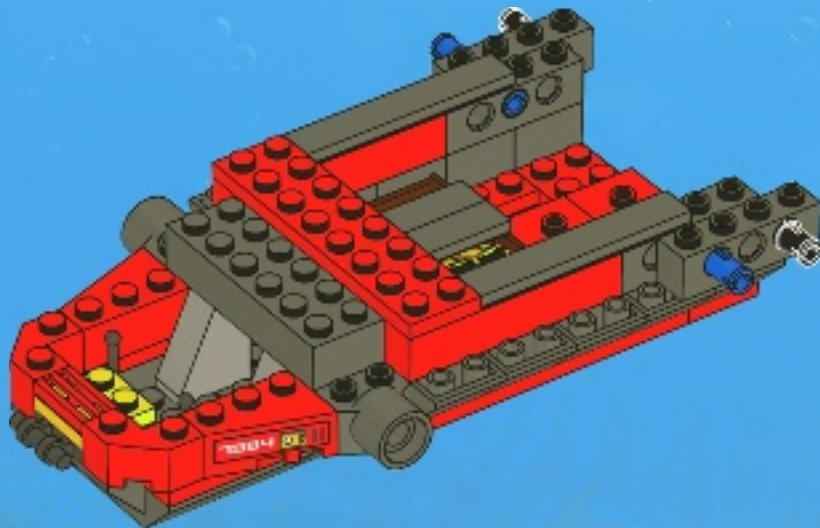



4x

19

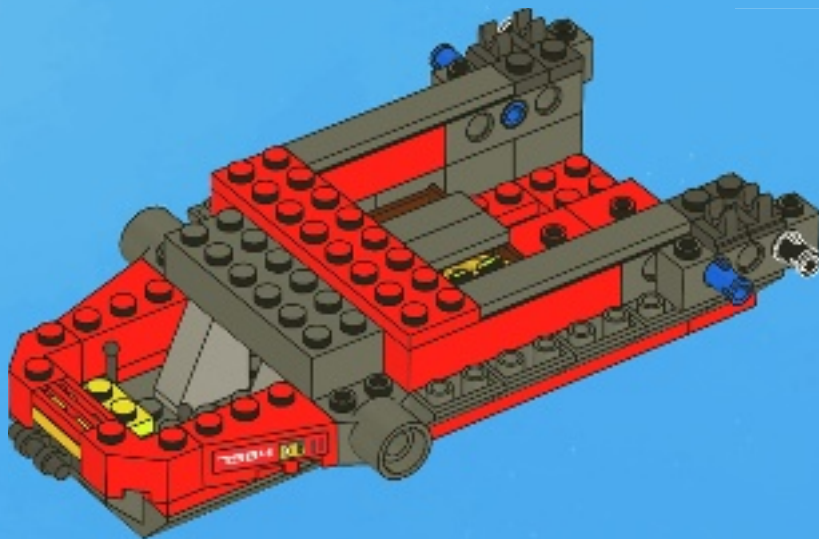



6x

20

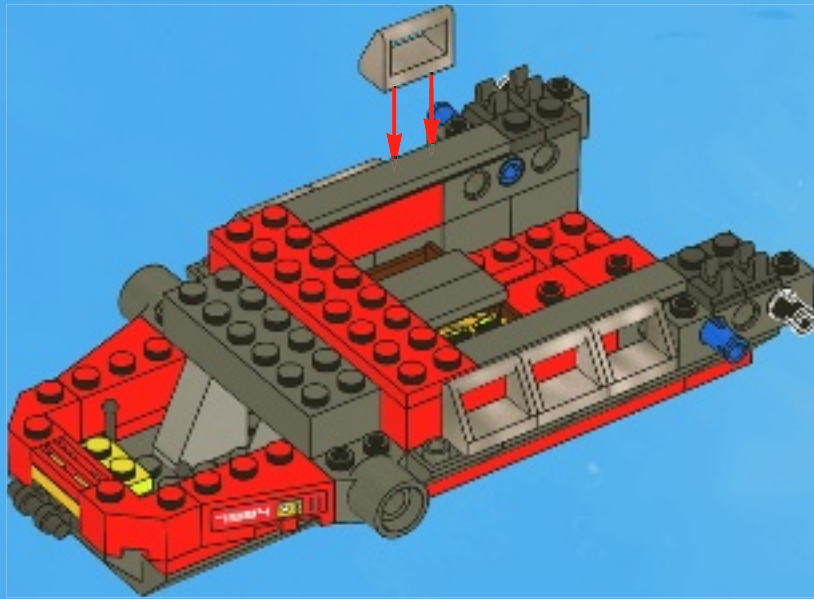

2x



2x

21

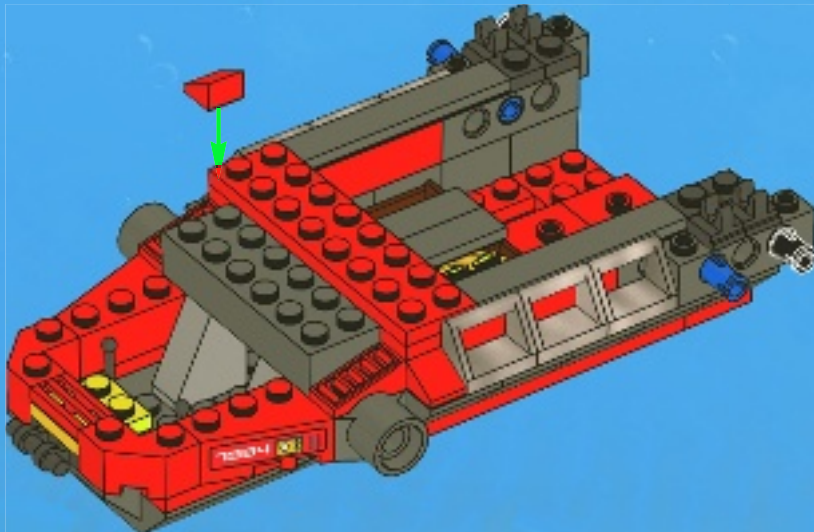



1x



4x

22

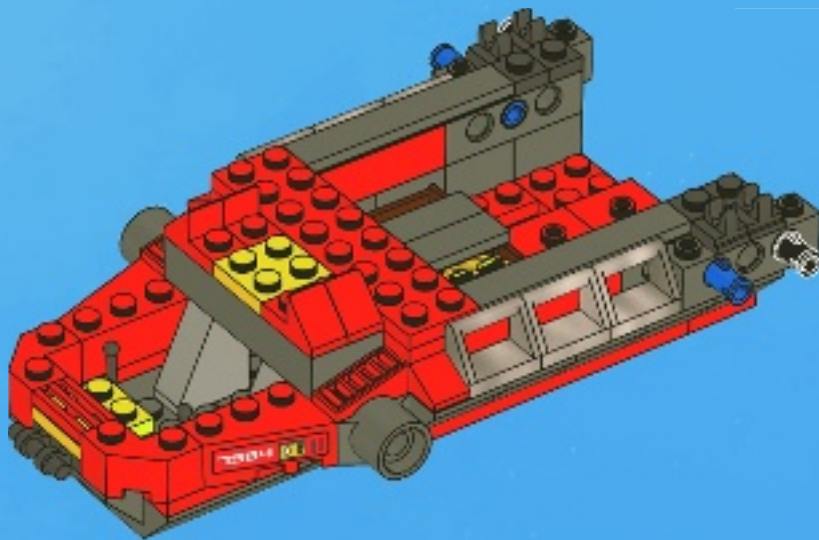



2x



4x

23

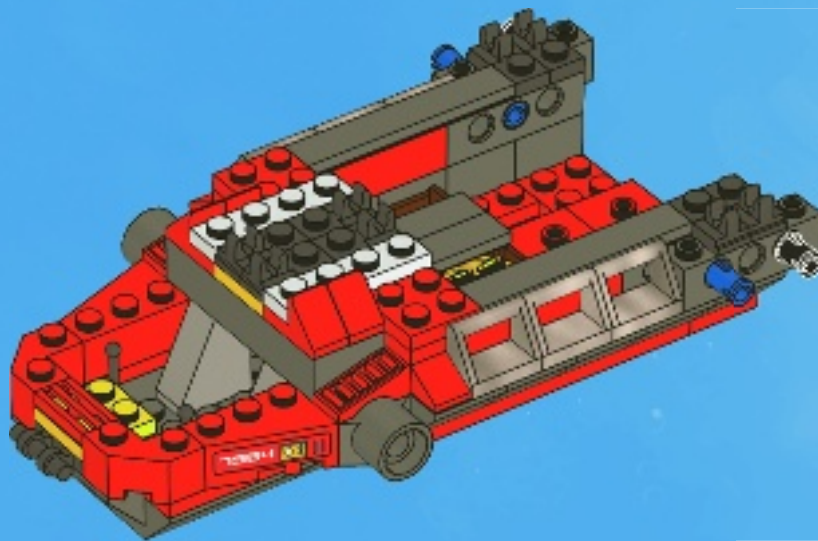

2x



2x

24

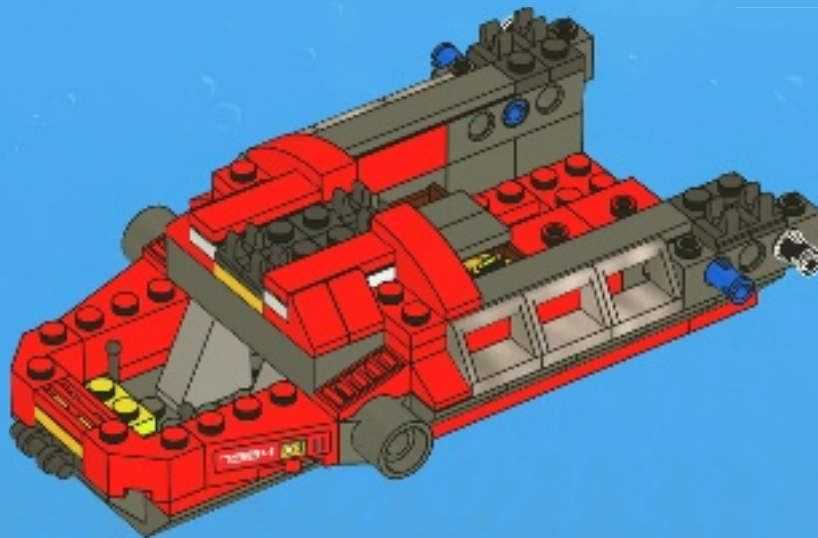

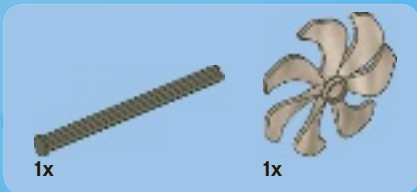

1

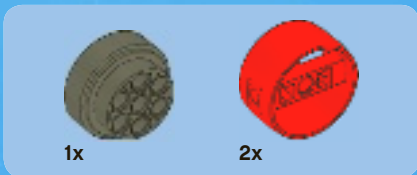
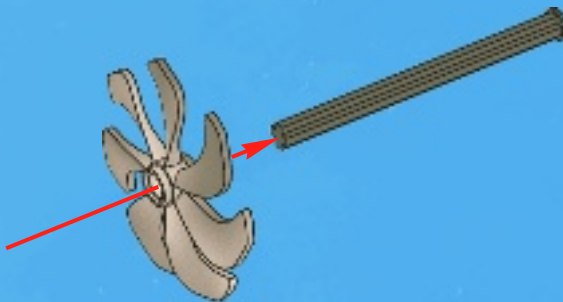

2

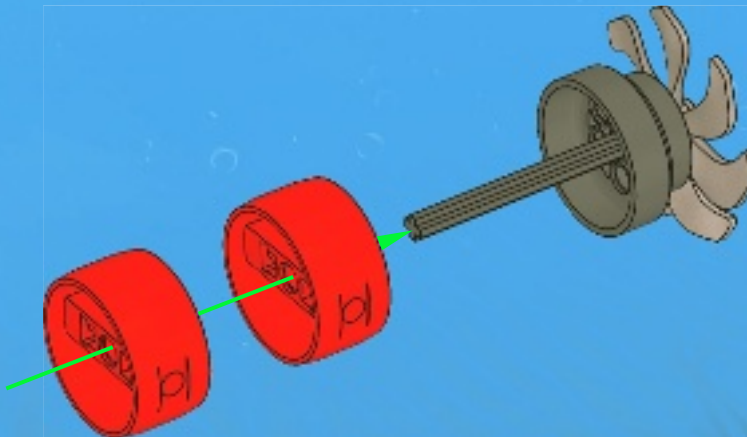

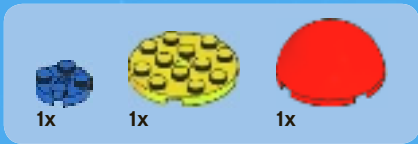

3

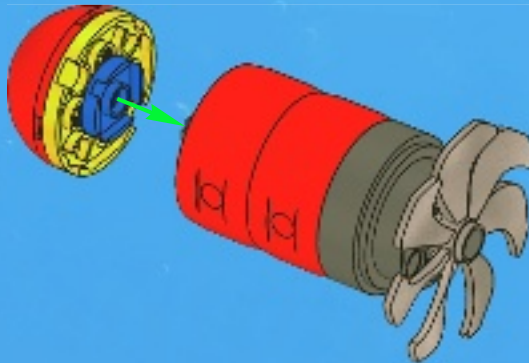
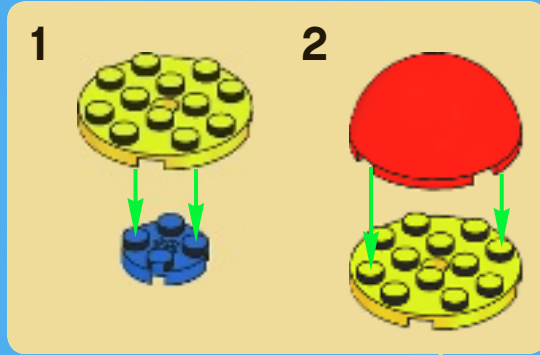

2x

25

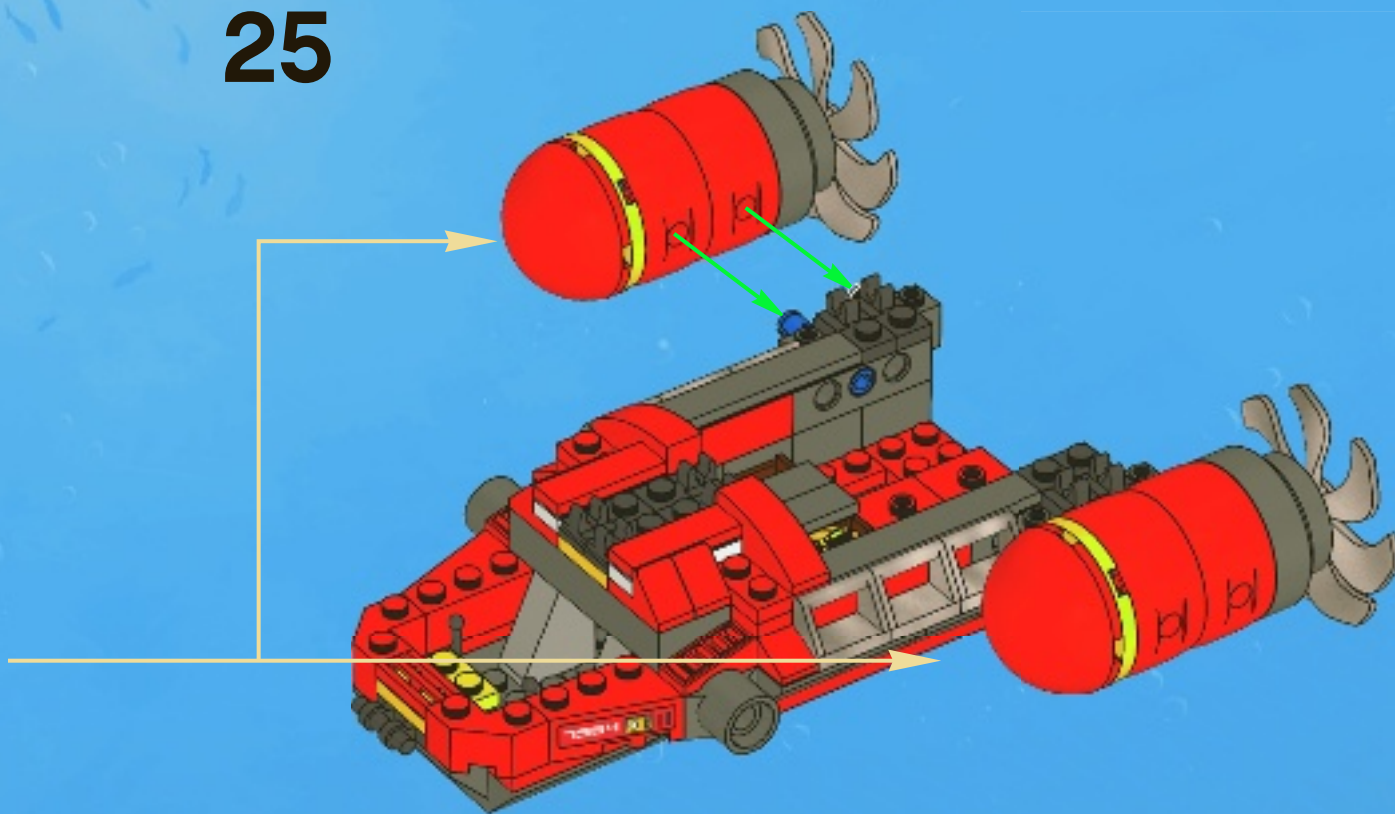



26

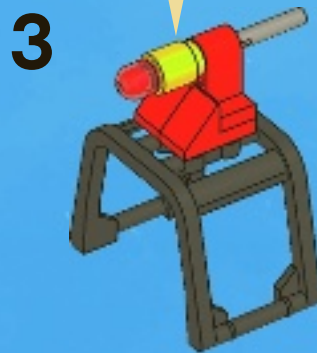
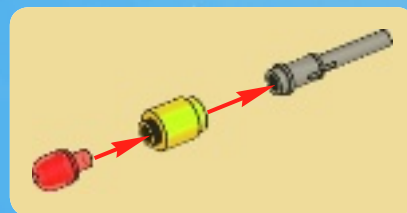
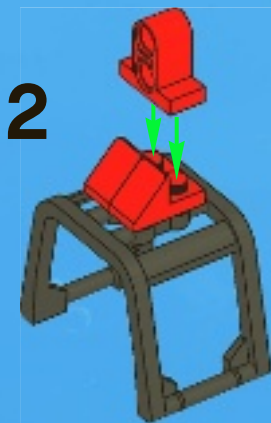
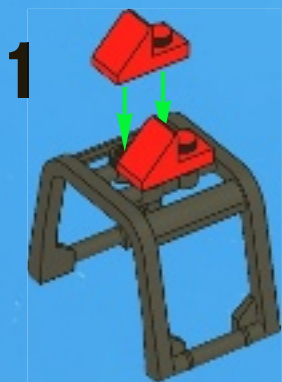

2x

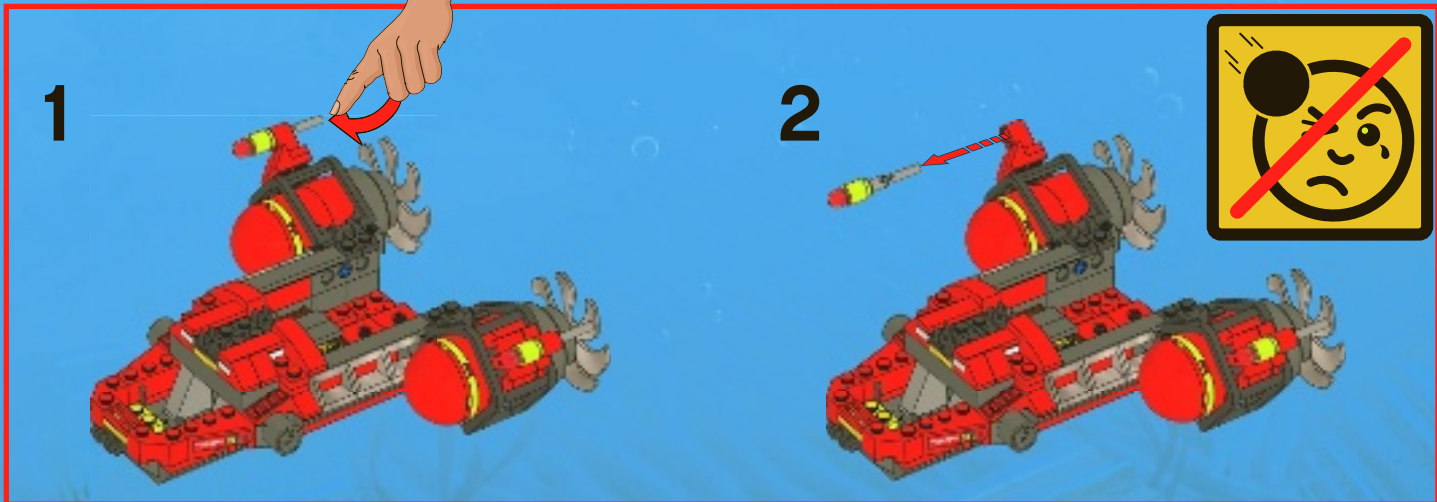
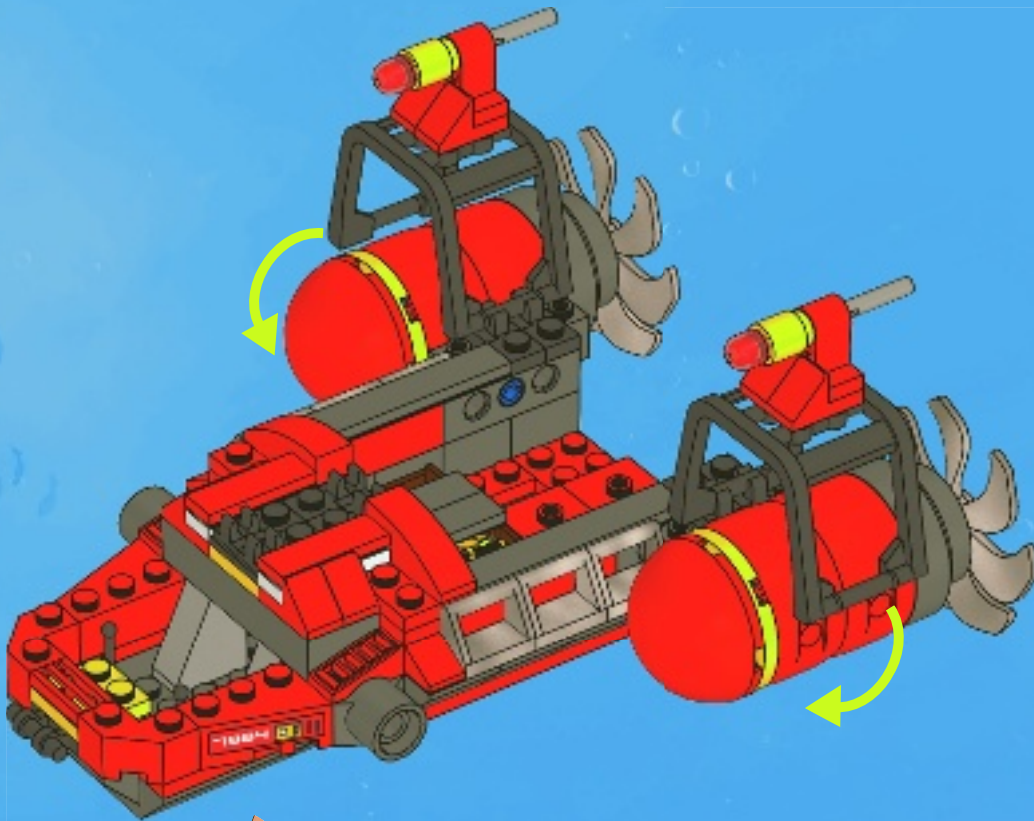



1x

1

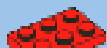

1x



4x

2

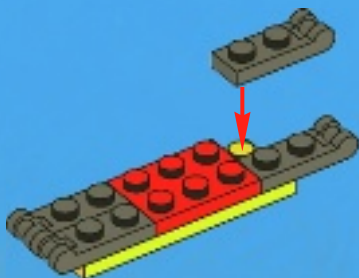

4x

3

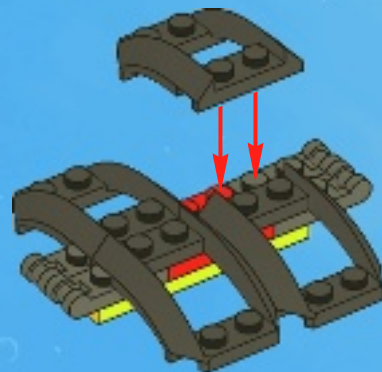

2x



4x

4

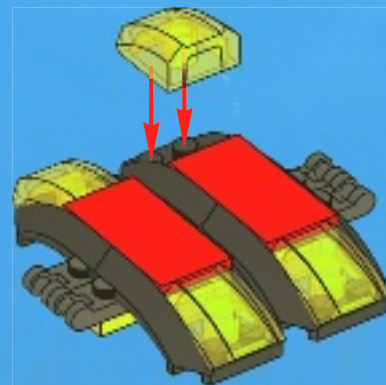



1x



1x

5

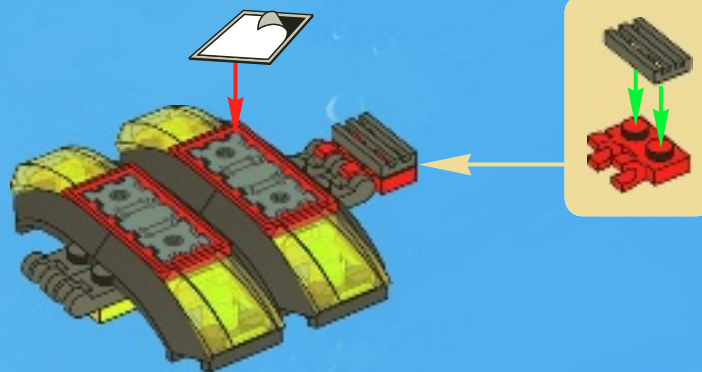

27

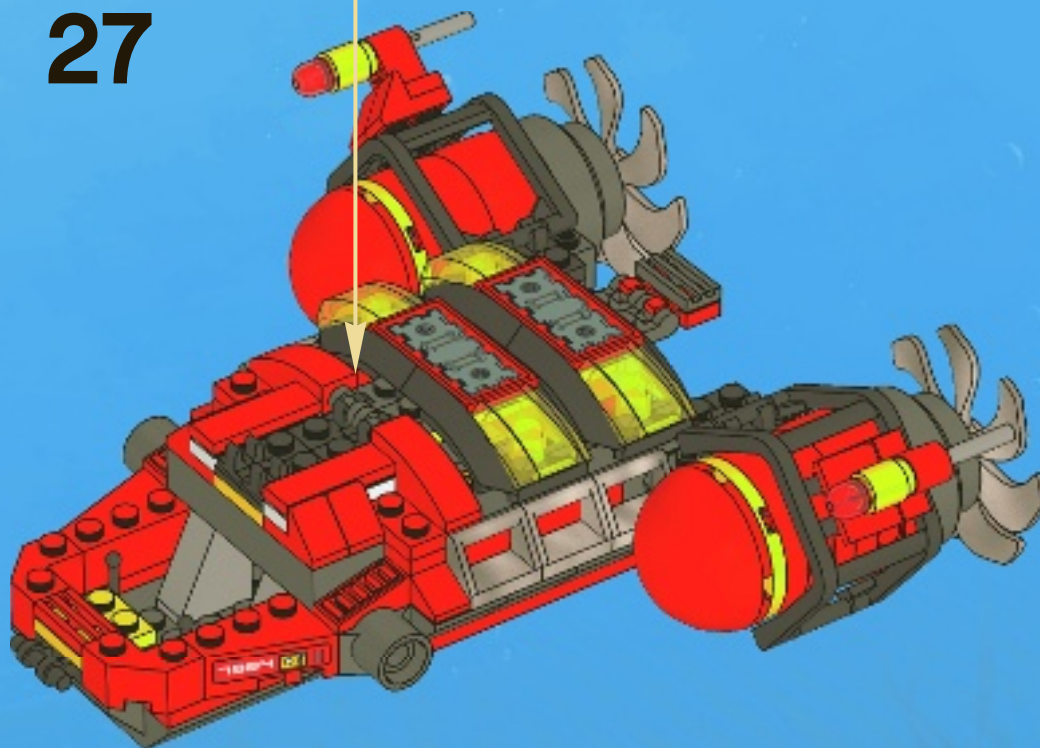

4x

2x

2x

28

1

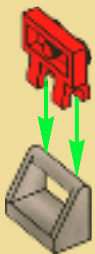

2



2x



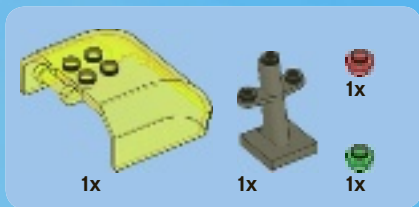

29

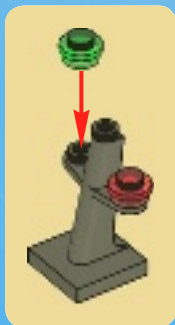



1



2

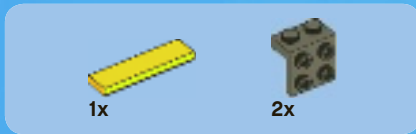
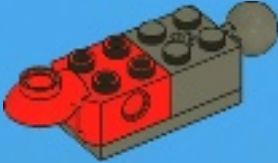

3

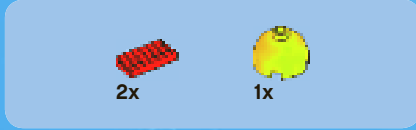
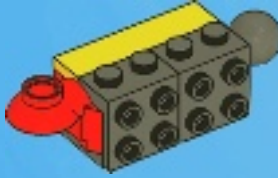

4

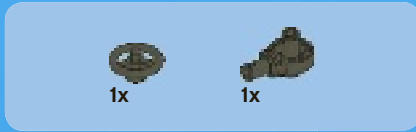
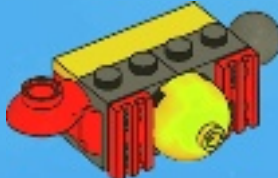

5

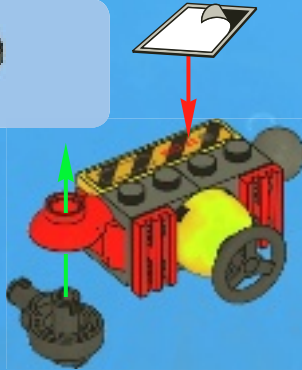

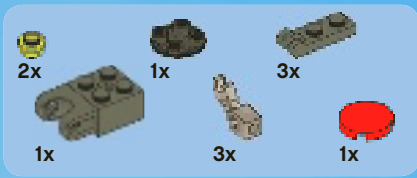

6

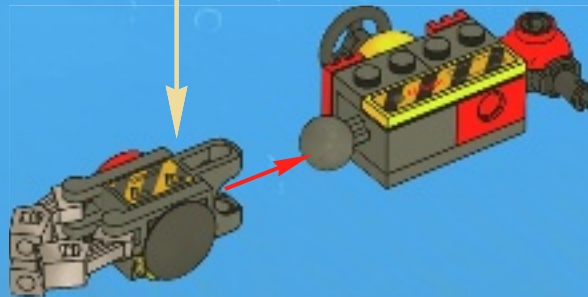
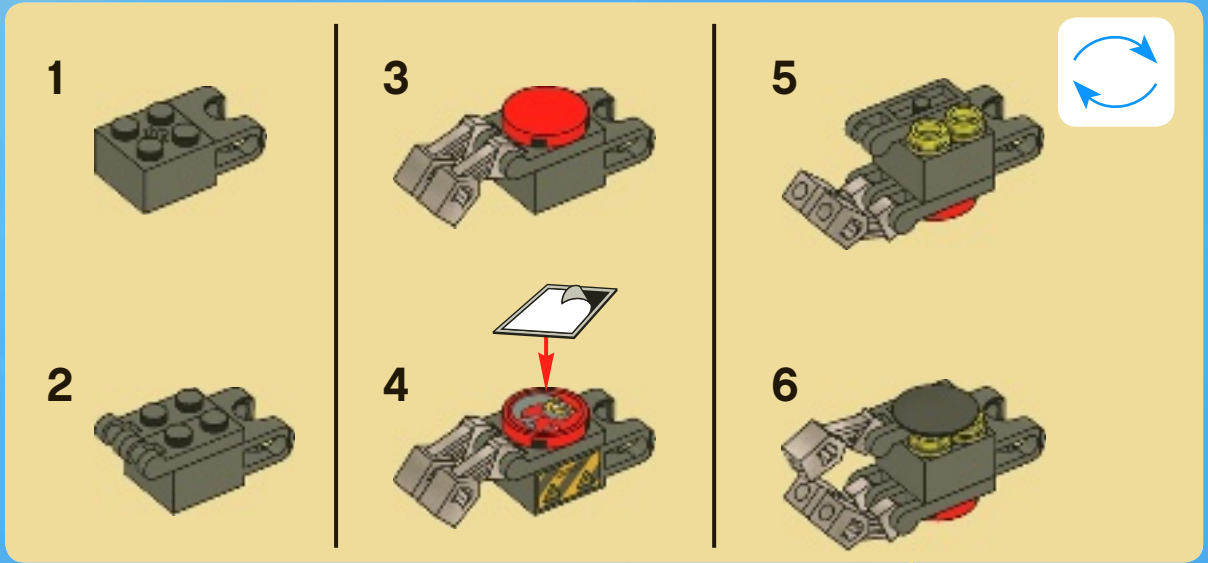

30





1



2



3

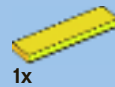
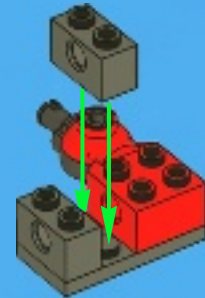

4





2x



1x

5



1x

6

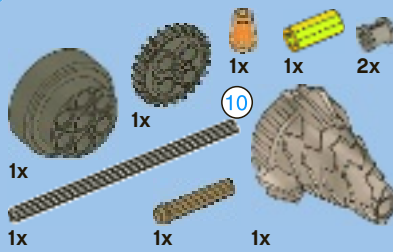

7

1

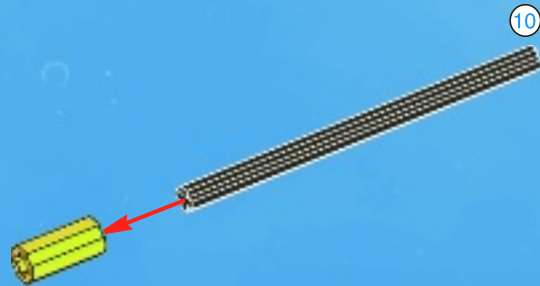

2

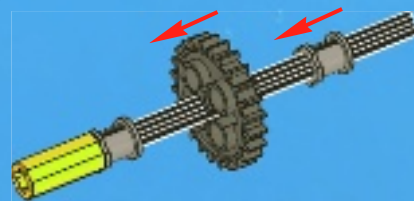

1:1

3

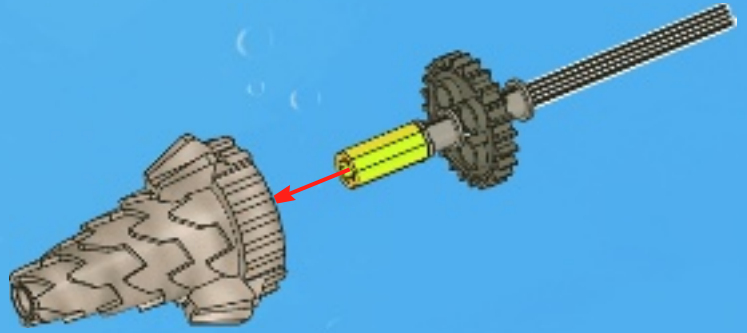

4

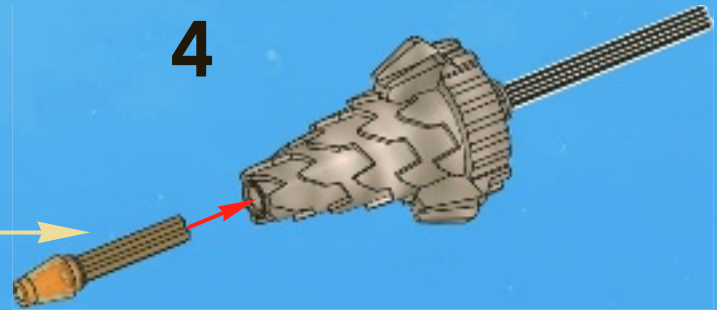
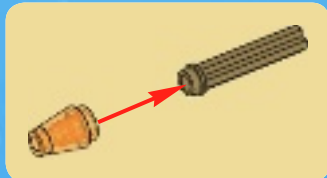

5

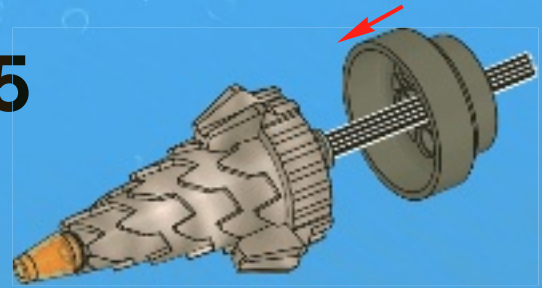



1x

6

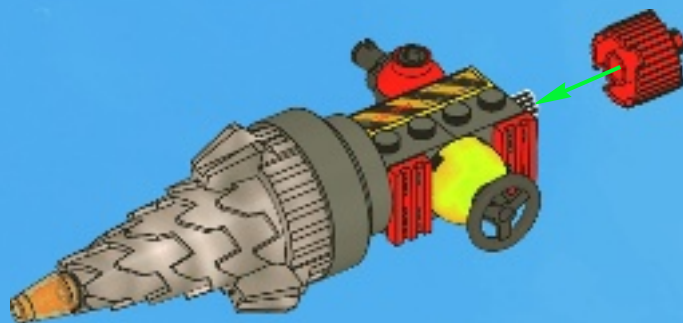

31

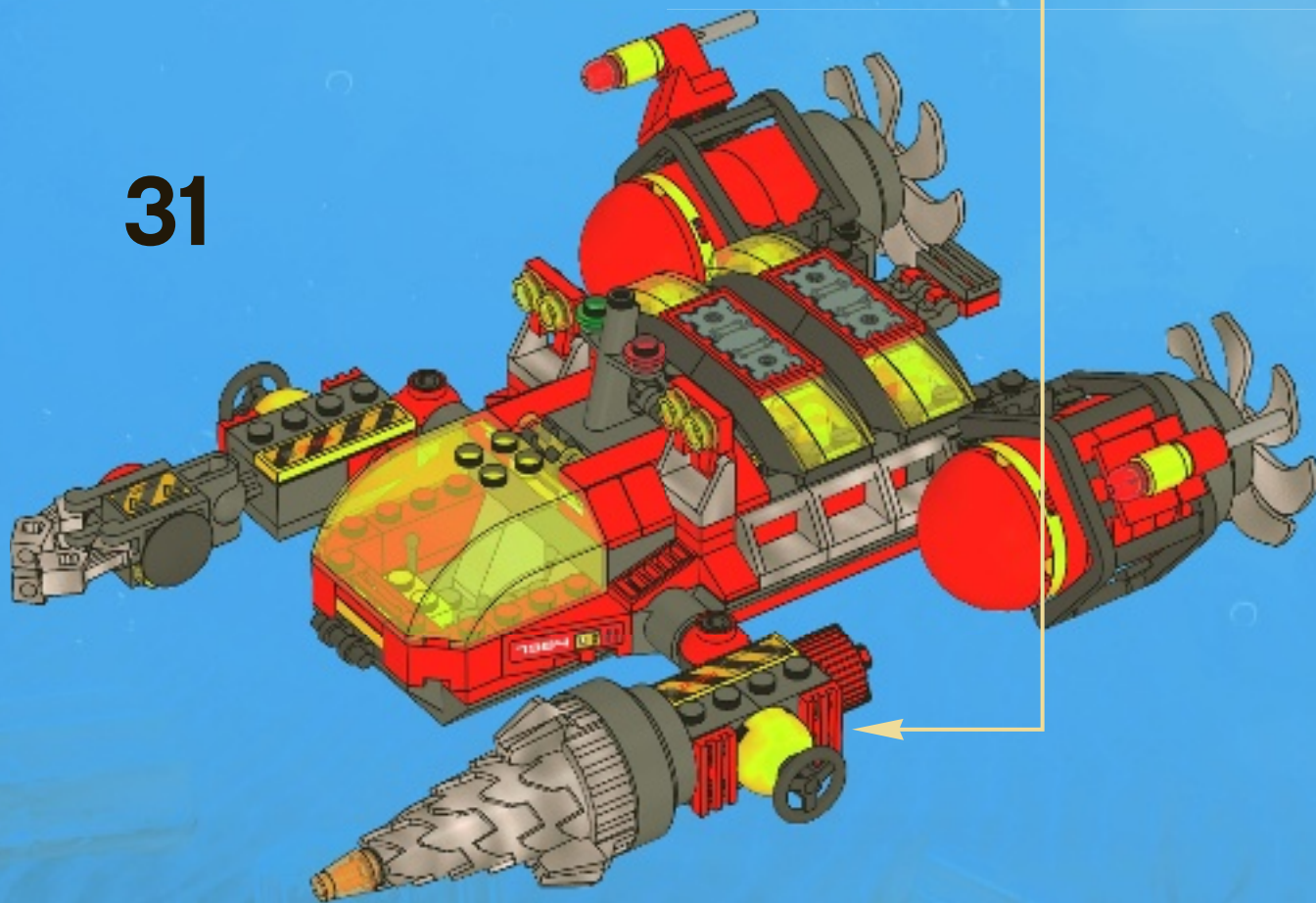

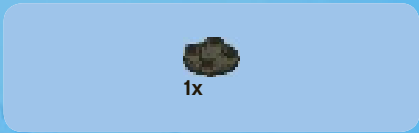

1

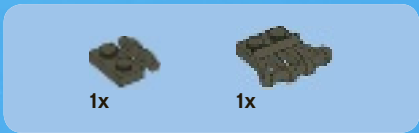

2

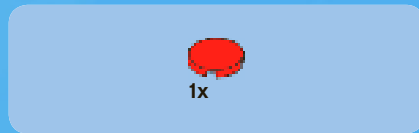

3



4

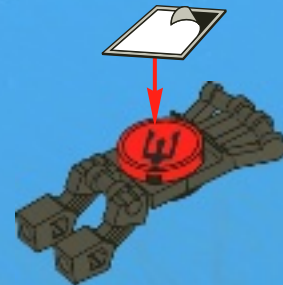



2x

5



2x

6



32

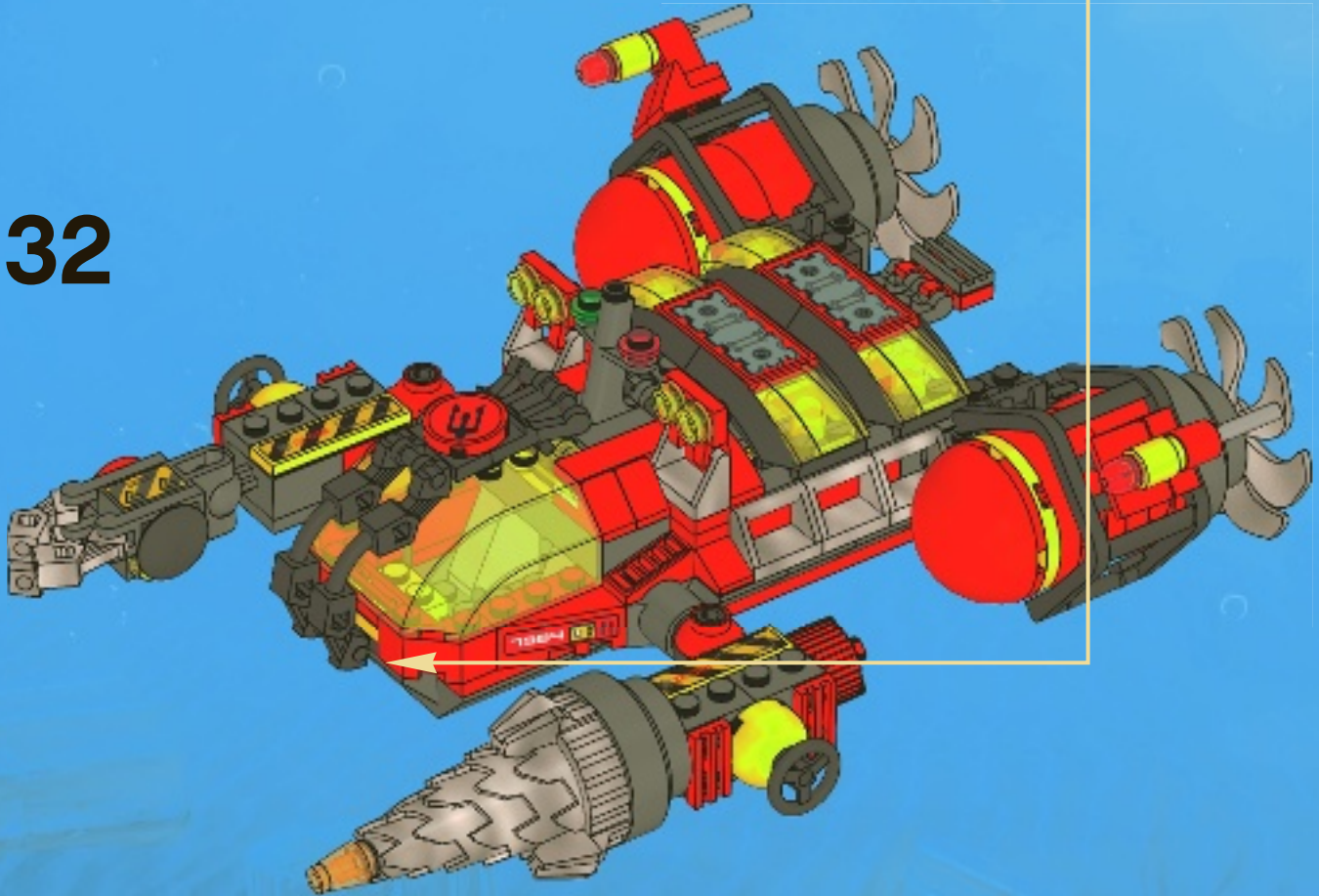

33

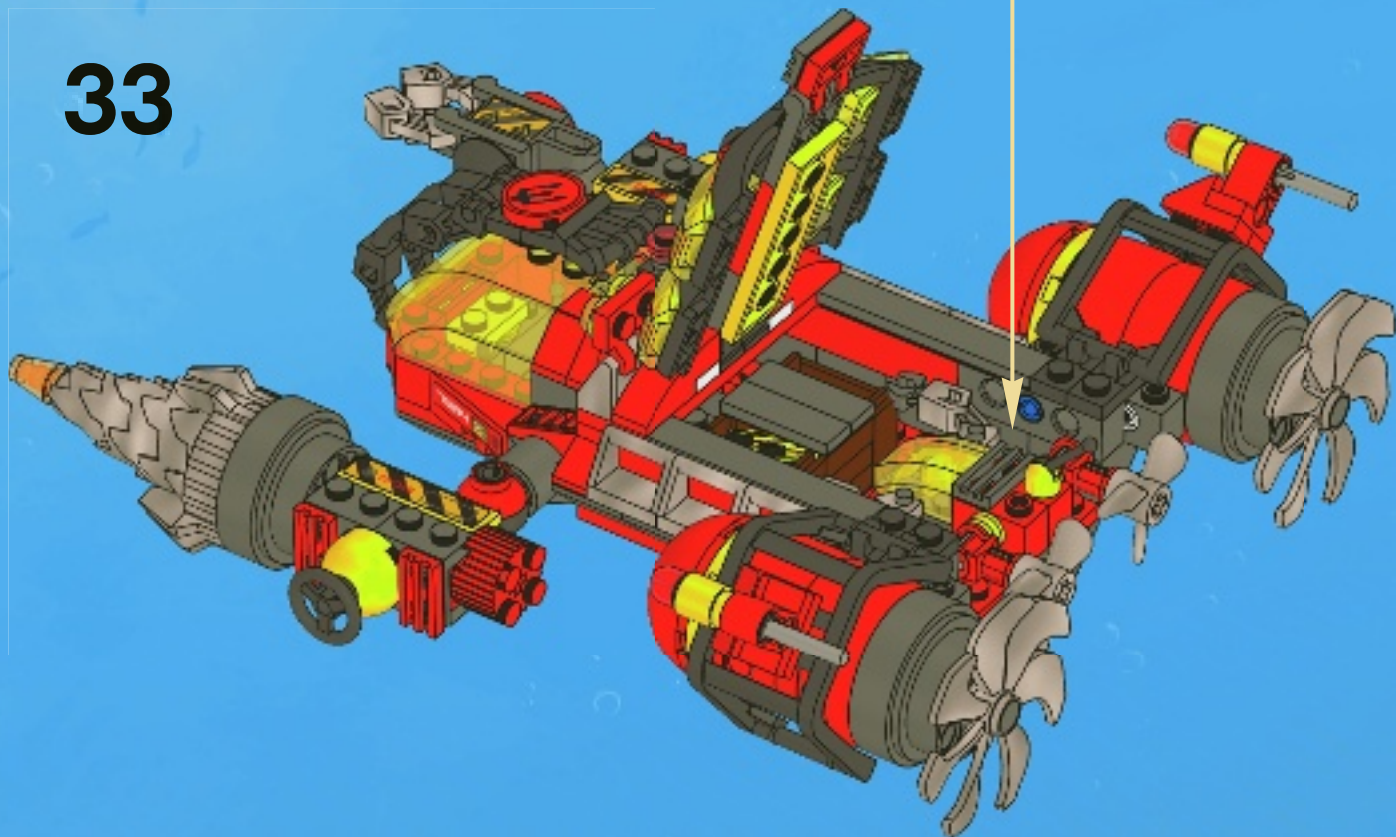
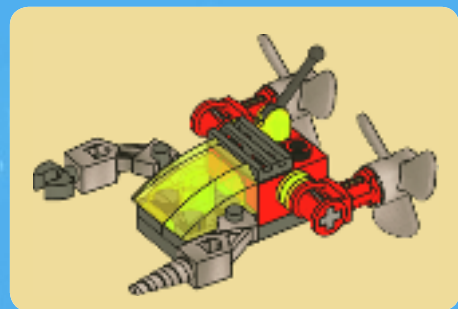



7976

7985

7977



7984

7978

7985



1x
300301

4x
4603123

1x
302201

2x
371001

2x
408101

1x
4515347

1x
4612717

1x
4113917

1x
4114001

2x
4186017

2x
300921

4x
303421

1x
302121

Customer Service

Kundenservice

Service Consommateurs

Servicio Al Consumidor

www.lego.com/service or dial



00800 5346 5555 :

1-800-422-5346 :



2x
4513987

2x
4225923

1x
4612108

2x
4581525

1x
4526929

1x
4527765

2x
4504379

2x
4540382

10x
4603263

2x
4251162

2x
4533742

1x
302121

2x
4560179

2x
366621

5x
241221

2x
4207715

3x
4556153

3x
4581308

2x
415021

2x
4612720

4x
4570494

2x
4118897

2x
403223

2x
4514553

2x
306224

2x
4216656

2x
302224

3x
243124

1x
379524

1x
383224

1x
403224

2x
4515349

3x
74156

1x
4615095

1x
4613918

2x
4239601

1x
4519010

8x
4598528

1x
4599960

2x
4140588

1x
4604304

2x
4278359

4x
4623154

2x
4613736

1x
4587501

2x
4153044

2x
4539385

4x
4525236

2x
4213374

2x
4121715

1x
373726

1x
4248937

1x
3005741

1x
4614508

2x
4497943

1x
4113954

1x
4119483

8x
3005744

1x
4611109

1x
4610674

5x
4602942

1x
3005748

1x
4566927

2x
4612418

2x
4294148

1x
4613808

1x
4567338

1x
4211185

2x
4515374

1x
4211396

1x
4613550

2x
4520320

2x
4211622

1x
4211639

1x
4210875

1x
4619760

2x
4225973

1x
4497253

2x
4211111

4x
4213607

12x
4211000

4x
4549999

2x
4568734

3x
4211065

2x
4210651

2x
4210631

2x
4611703

4x
4277928

7x
4521187

1x
4614153

1x
4614552

1x
4614155

1x
4614518

1x
4567411

3x
4549886

1x
4514558

1x
4289542

2x
4499858

2x
4523159

1x
4541394

1x
4541393

1x
4595077

8x
4614461

5x
4625564

1x
4613444

1x
4612829

2x
4612827

2x
4612828

1x
4609774

5

10



www.LEGOclub.com



LEGO® Club Email

LEGO club™

FREE! GRATIS! GRATUIT!



LEGO® Club Magazine

SIGN UP ONLINE!

www.LEGOclub.com



00800 5346 5555*



1-866-534-6258 • 1-877-518-5346

US & Canada only

Canada seulement

* Freephone. Mobile charges may apply.
* Numéro sans frais. Des frais peuvent s'appliquer avec les téléphones cellulaires.
* Gebührenfrei, Kosten für Anrufe aus Mobilfunknetzen können abweichen.
* Gratis telefonnummer vanaf vaste lijn.
* Det er et gratis nummer, når du ringer fra fasttelefon.
* Det är gratis, när du ringer från en fast telefon.
* Numéro sans frais. Des frais peuvent s'appliquer avec les téléphones portables.



WIN!

Go to www.LEGOsurvey.com/product to fill out a survey for a chance to win a cool LEGO® Product.

No purchase necessary.

Open to all residents where not prohibited.



www.LEGOsurvey.com/product

GEWINNE! WIN!

Nimm an der Umfrage auf www.LEGOsurvey.com/product teil und hab die Chance ein cooles LEGO® Produkt zu gewinnen!

Die Teilnahme am Gewinnspiel führt zu keinerlei Kaufverpflichtungen. Teilnahme in allen nicht ausgeschlossenen Ländern möglich.

Ga naar www.LEGOsurvey.com/product, vul een enquêteformulier in en maak kans op een cool LEGO® product.

Geen aankoopverplichting. Iedereen mag deelnemen, uitgezonderd ingezetenden van landen waar een enquêteverbod geldt.

GAGNE! 当てよう!

Visite www.LEGOsurvey.com/product pour répondre à un questionnaire et avoir une chance de gagner un produit LEGO® très cool!

Aucune obligation d'achat. Ouvert à tous les résidents des pays autorisés.

www.LEGOsurvey.com/product にアクセスして、アンケートにご記入ください。当選者にはレゴ製品を差し上げます。

お買い上げの必要はありません。

禁止されていない限り、すべての皆様にご利用いただけます。