

The LEGO logo is displayed in its characteristic white, bold, sans-serif font with a black outline, set against a red square background.

# ATLANTIS

8080



**WARNING: CHOKING HAZARD.**  
Toy contains small parts and a small ball.  
Not for children under 3 years.

# 1

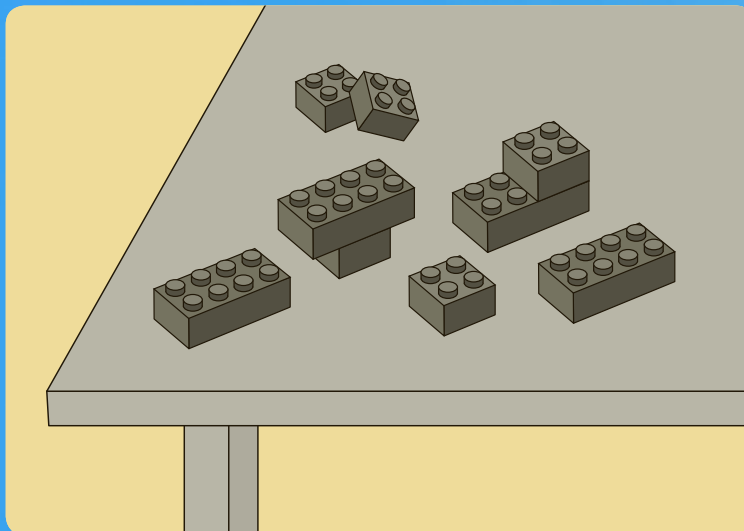
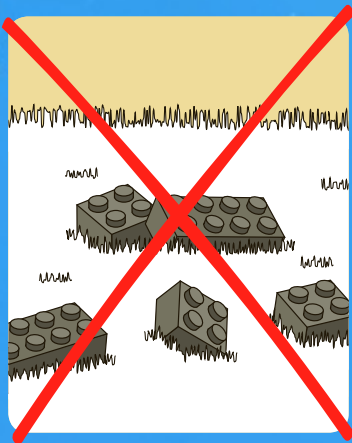

# 2

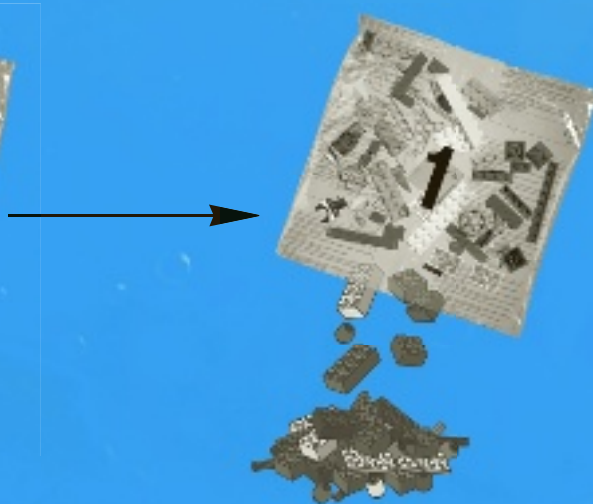

IMPORTANT: Never modify the elements or use other projectiles than provided with this toy.

IMPORTANT : Ne jamais modifier les éléments ni utiliser d'autres projectiles que ceux fournis avec ce jouet.

2 IMPORTANTE: No modifique los elementos ni utilice otros proyectiles diferentes a los suministrados junto con este juguete.



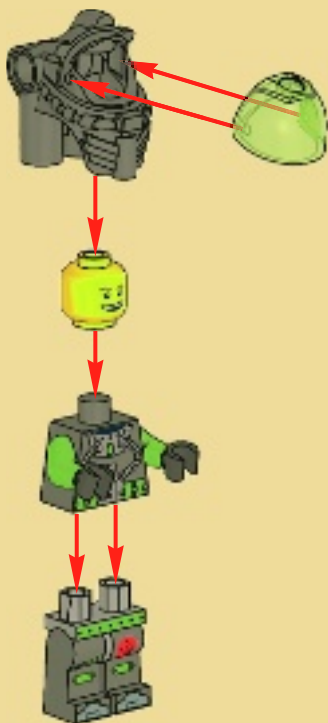

**AVERTISSEMENT : RISQUE D'ÉTOUFFEMENT.**

Le jouet contient des petites pièces ainsi qu'une petite boule. Il ne convient pas aux enfants de moins de 3 ans.



**ADVERTENCIA: PELIGRO DE ASFIXIA.**

Juguete que contiene partes pequeñas y una pelota pequeña. No recomendado para niños menores de 3 años.



1x



2x

# 1



1x

# 2





1x



2x



2x

# 3



2x

# 4

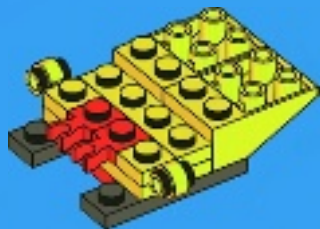

1x



2x

# 5

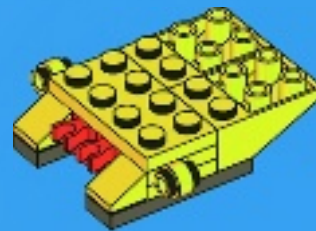

1x

# 6

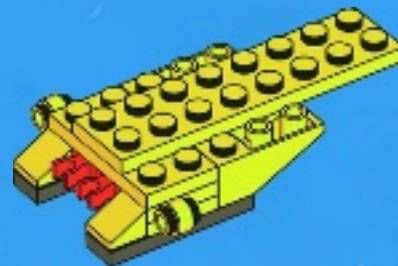



1x



1x



1x

# 7

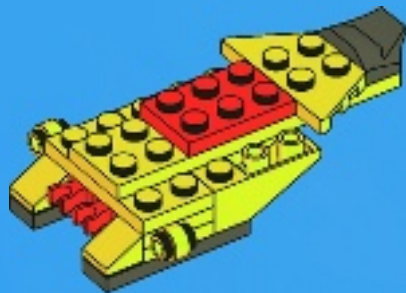

1x



1x

# 8

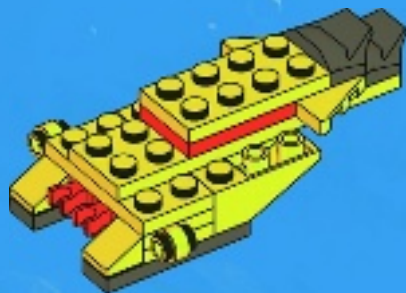



2x

9

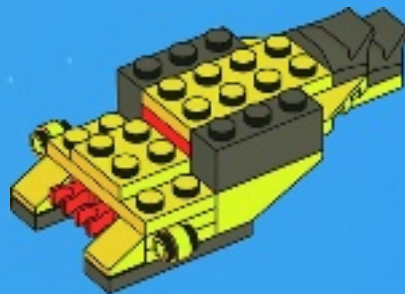

4x

10

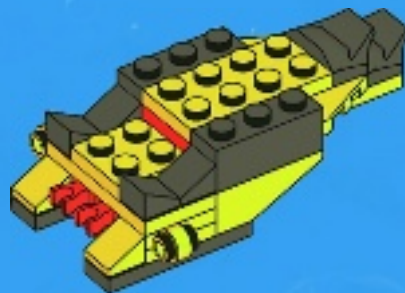



1x



1x

# 11

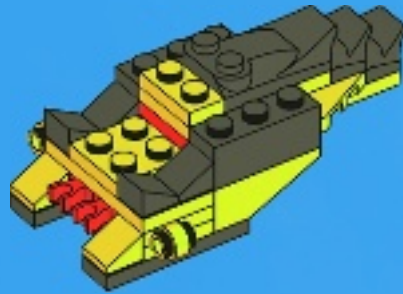

2x



2x



2x

# 12



1



2

2x

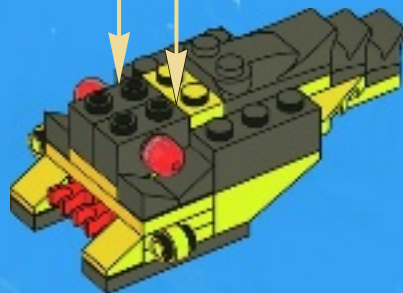





4x



1x

# 13

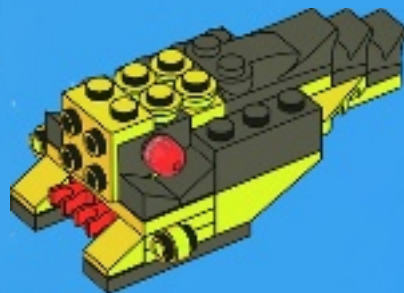

2x

# 14

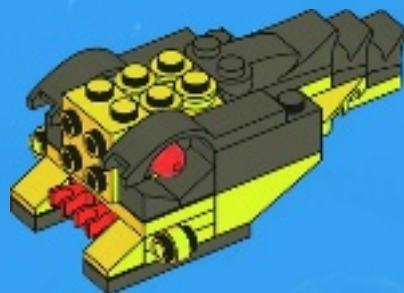



# 15

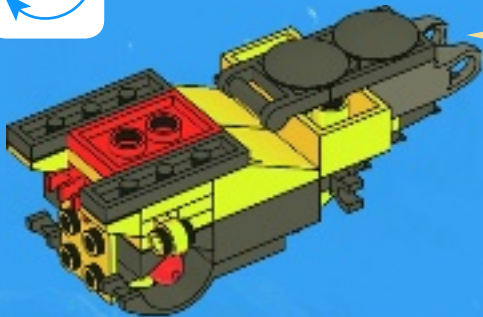
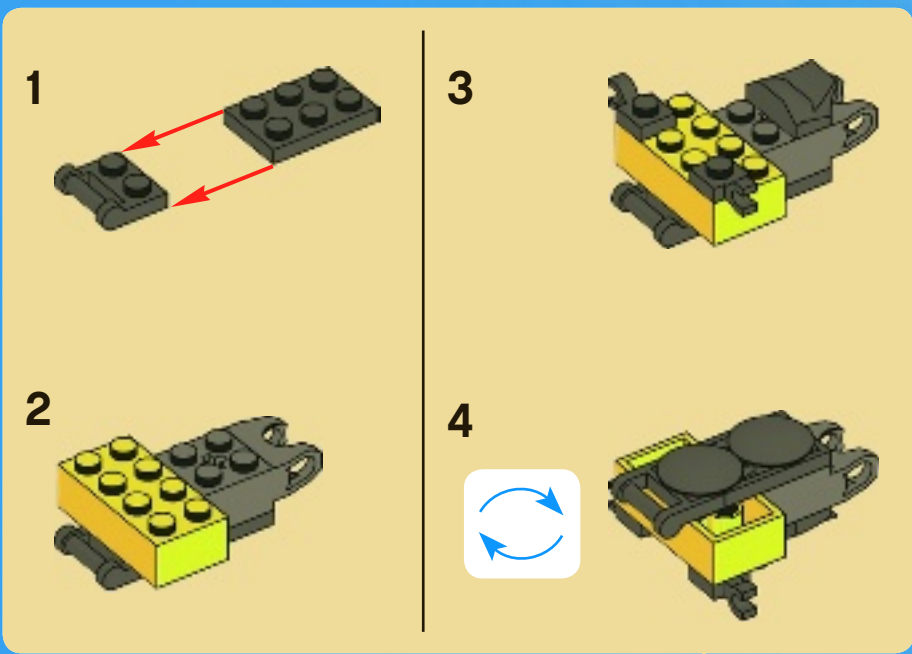



# 16

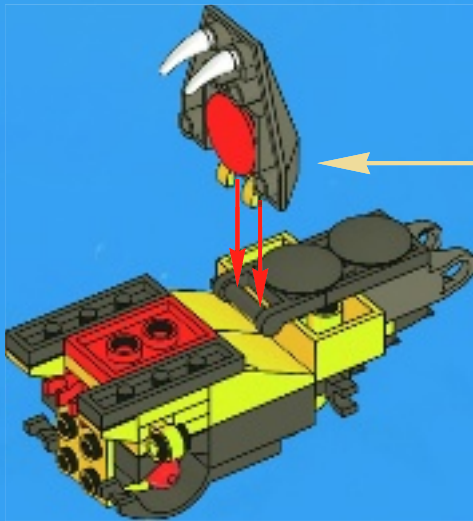



2x

# 17

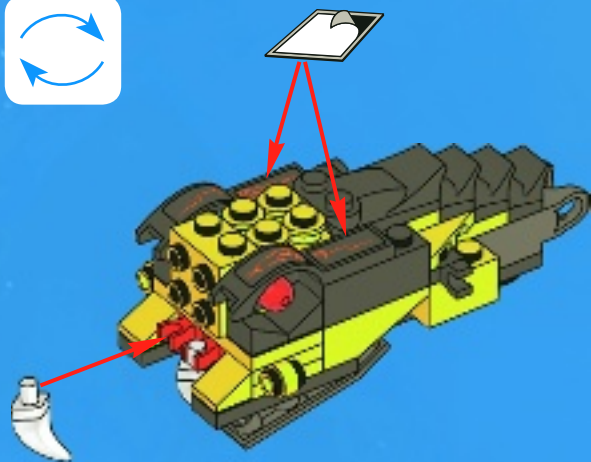

1x



1x

# 18







# 19

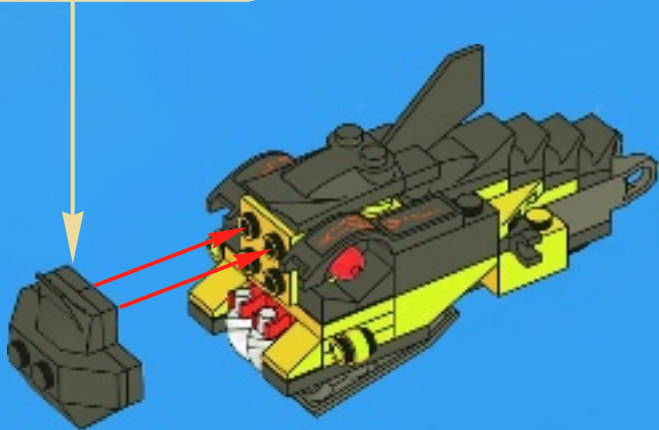
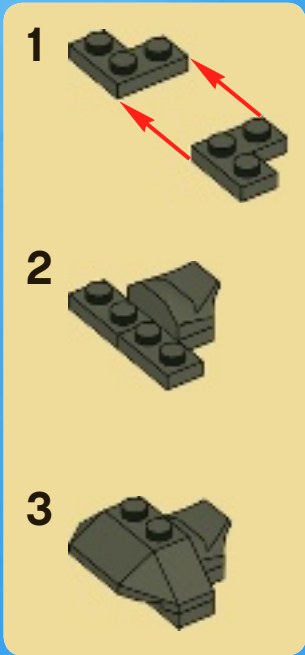

# 20



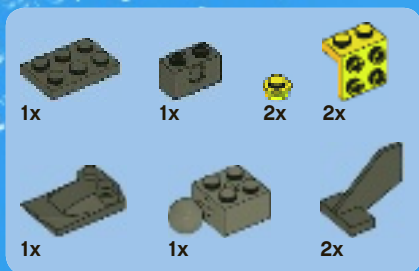

# 21

1



2

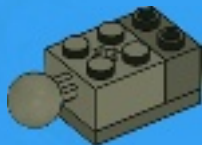

3



4



5



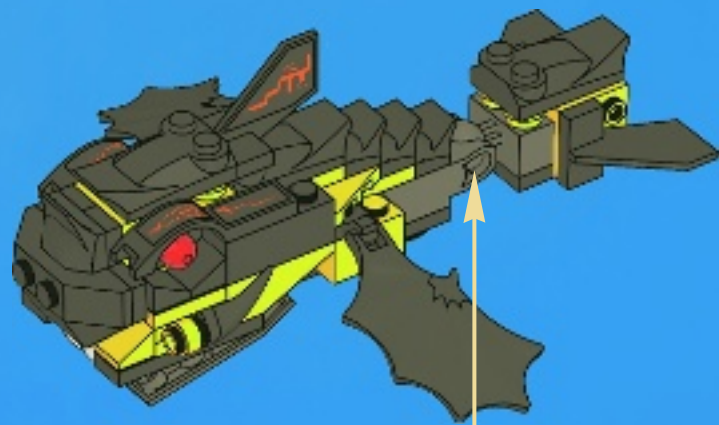



1

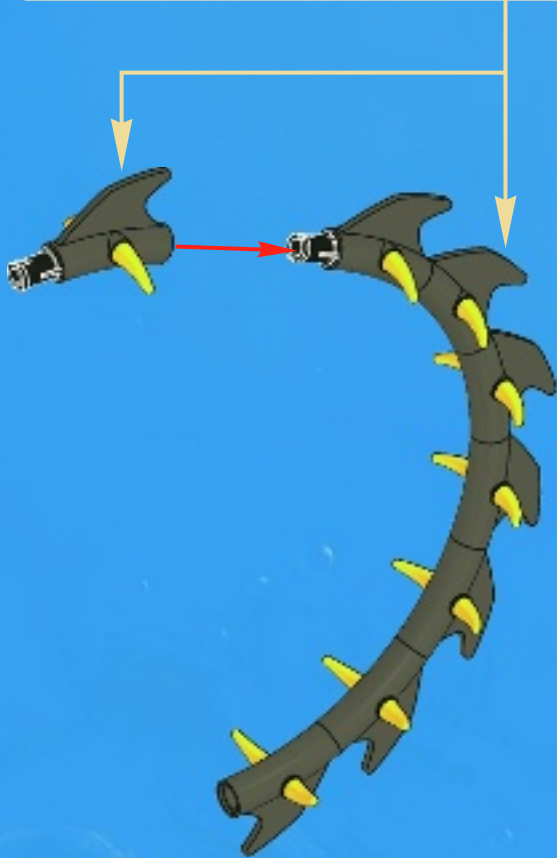





1x

2

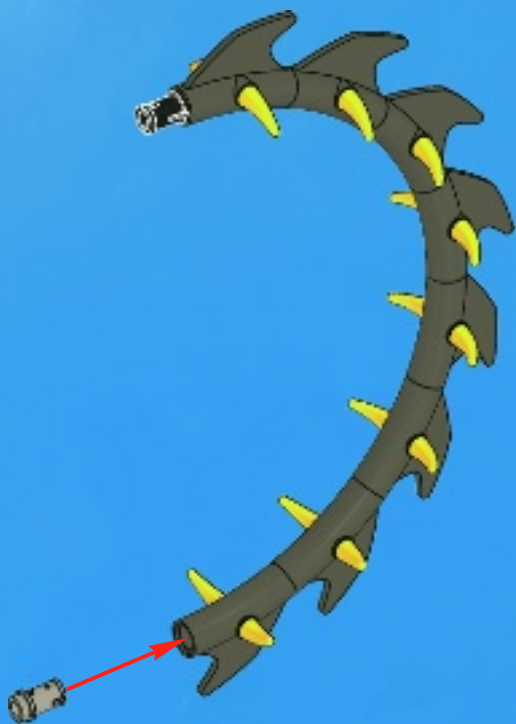

1x

3



4



22





1x

1



1x

2





1x



1x

# 3



1x



4x

# 5



4x



1x

# 4



1x

# 6

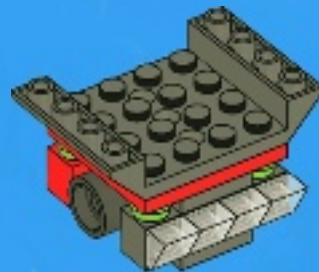





1x



2x

# 7



1x

# 8





1x



2x

# 9

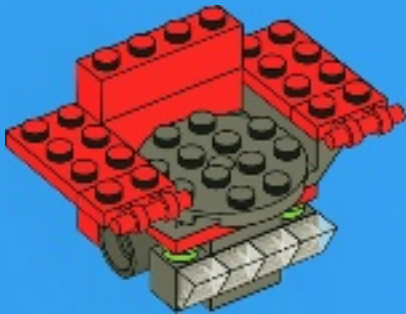

2x



2x

# 10

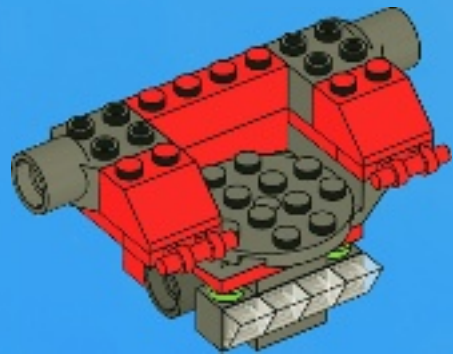

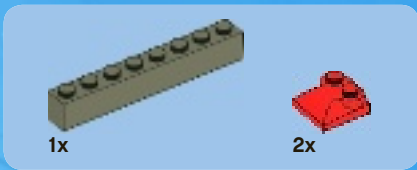

11

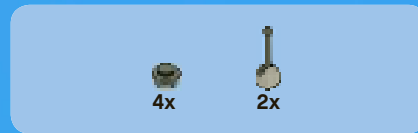
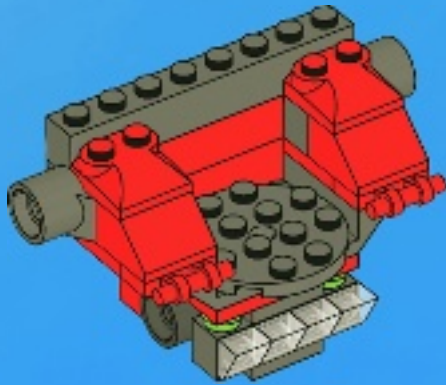

12

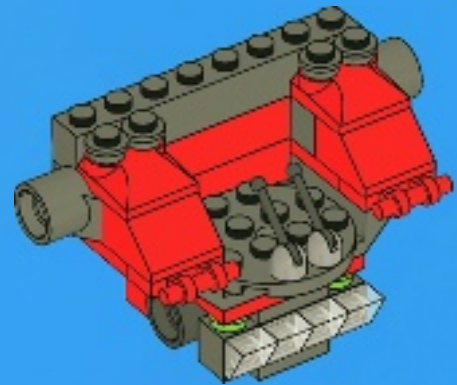



1x



2x

# 13

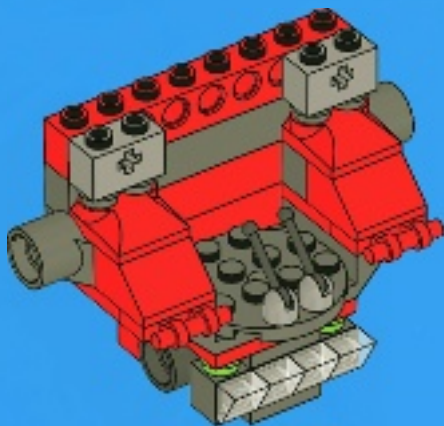

2x



1x

# 14

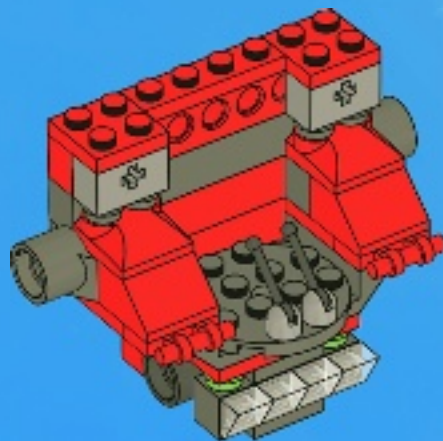



2x



2x



1x

# 15

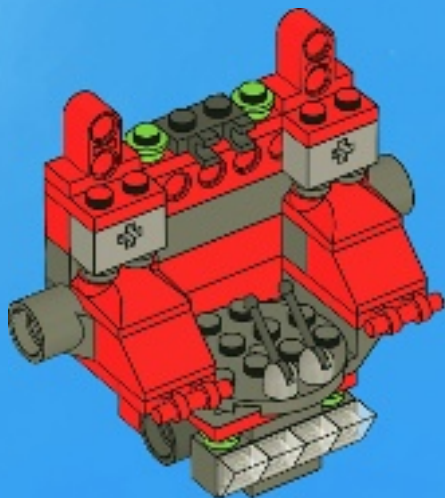

2x



1x

# 16

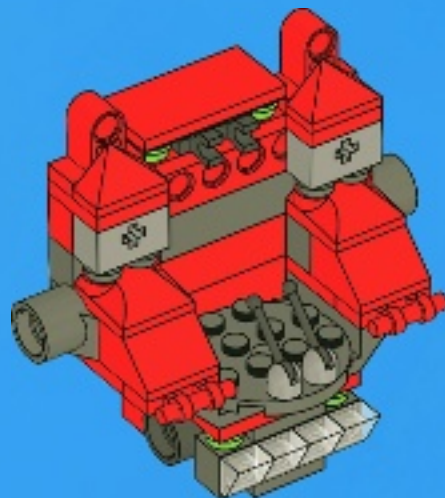





1x



5x

# 17

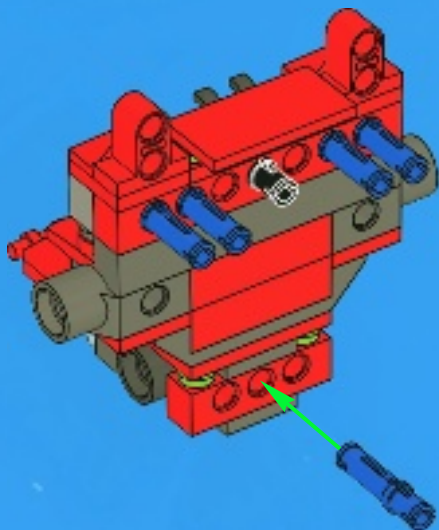

1x

# 18

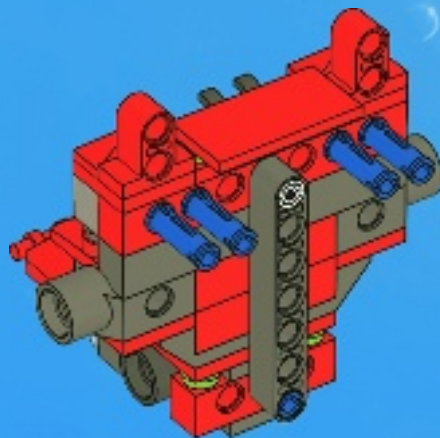

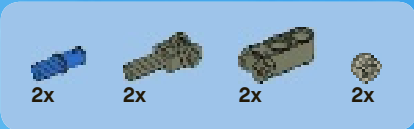

# 19

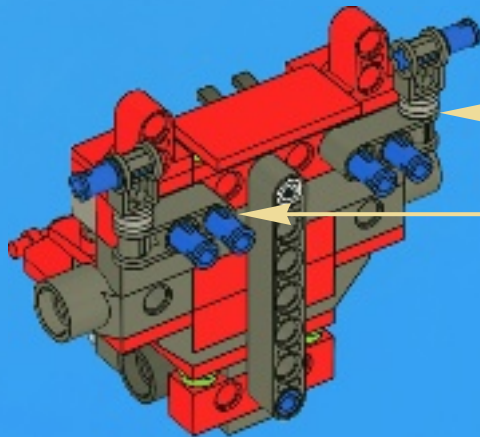



20

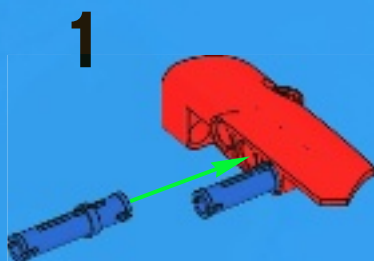

2



3

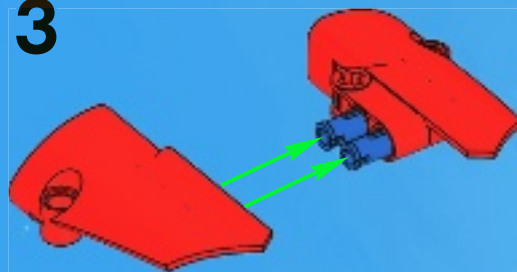

4

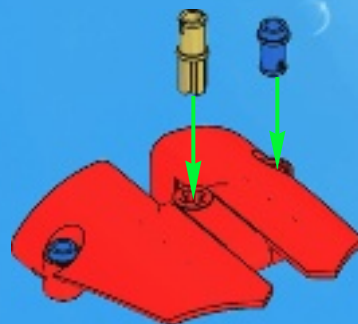

5



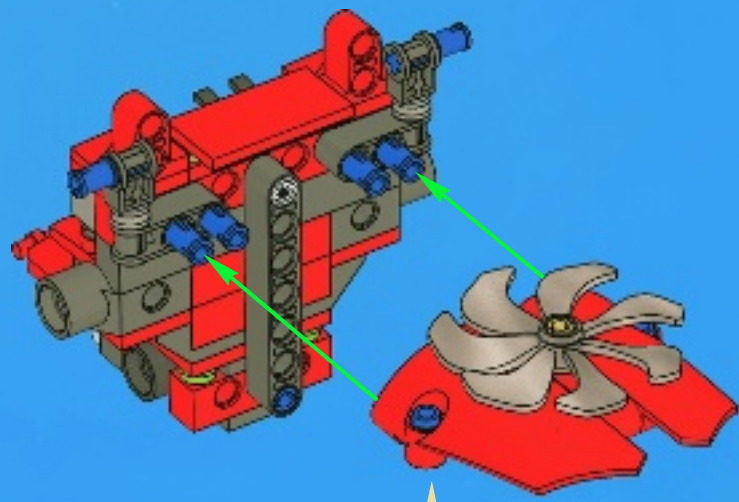



2x

# 21

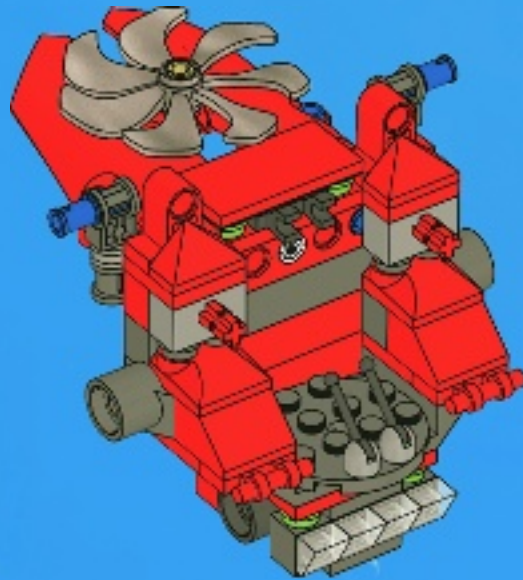





2x



8x

# 22

1



2



2x

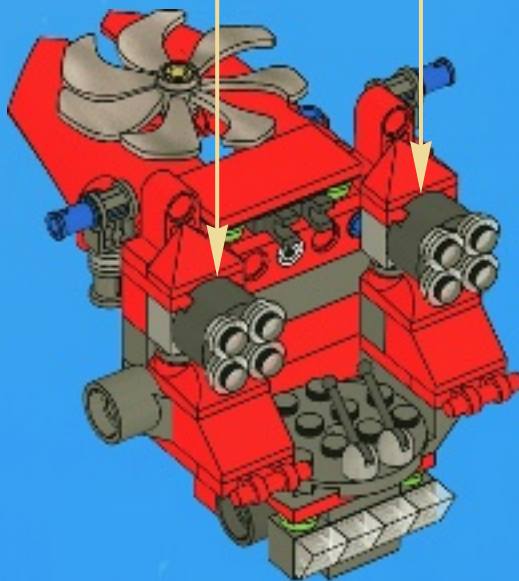

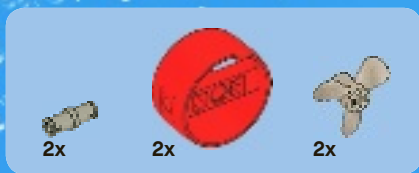

23

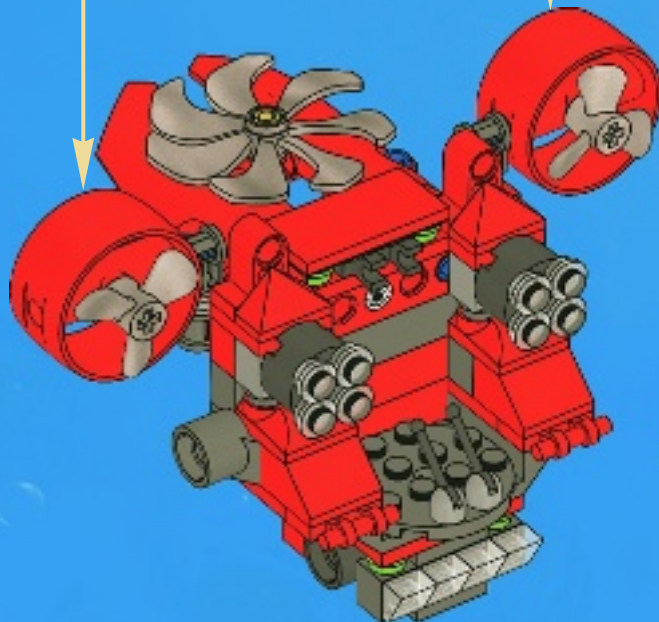
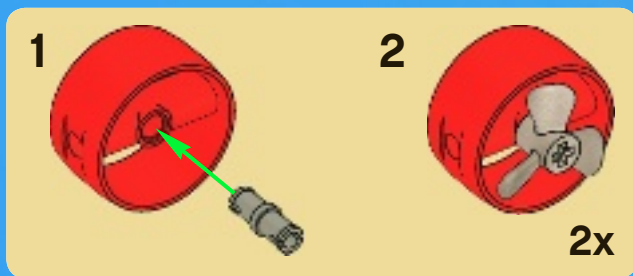

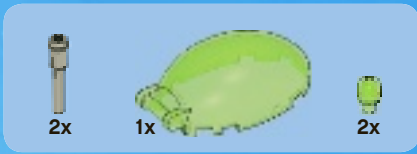

24

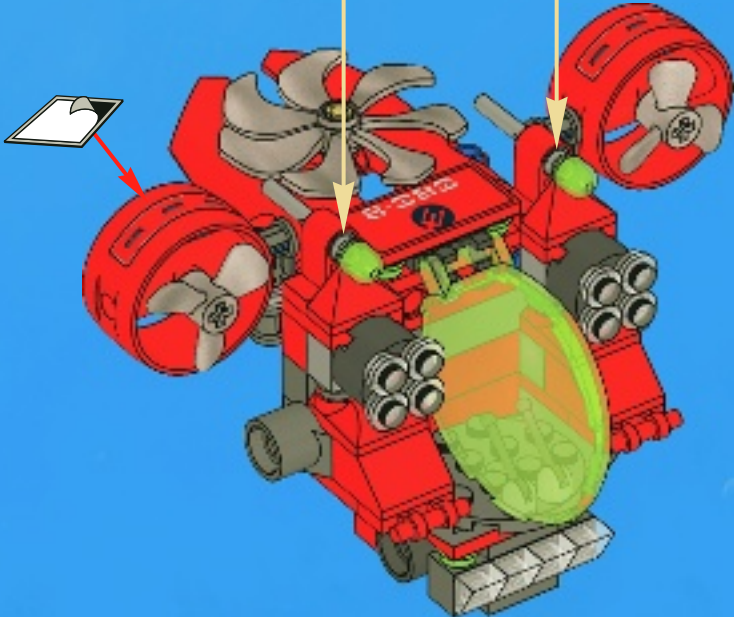

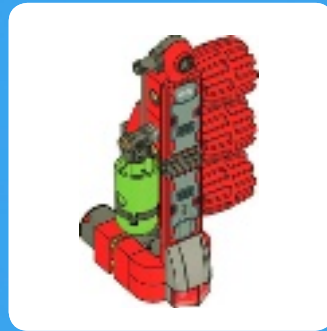

1x

1



2x



1x



1x

2





1x

# 3



2x



1x



1x

# 4

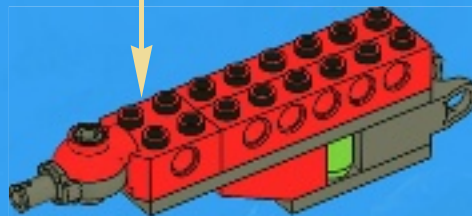
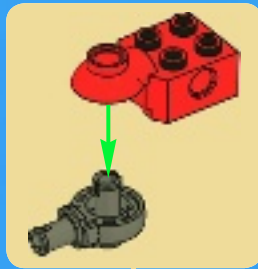





1x

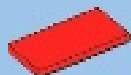

2x

# 5



# 6

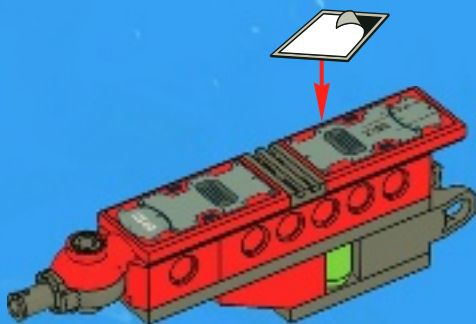



2x

1



1x

2



4x

3



1x

4





2x

5



1x

6



4x

7



1x

8





1x



1x

# 9

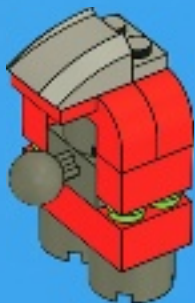

2x



2x

# 10

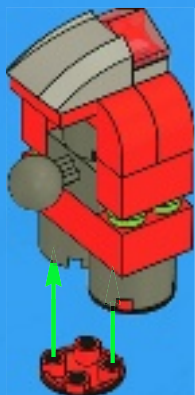

# 11

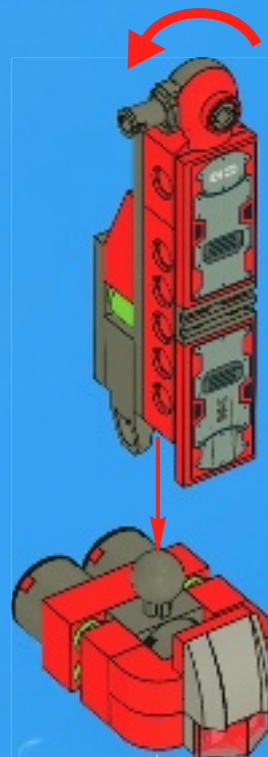



12

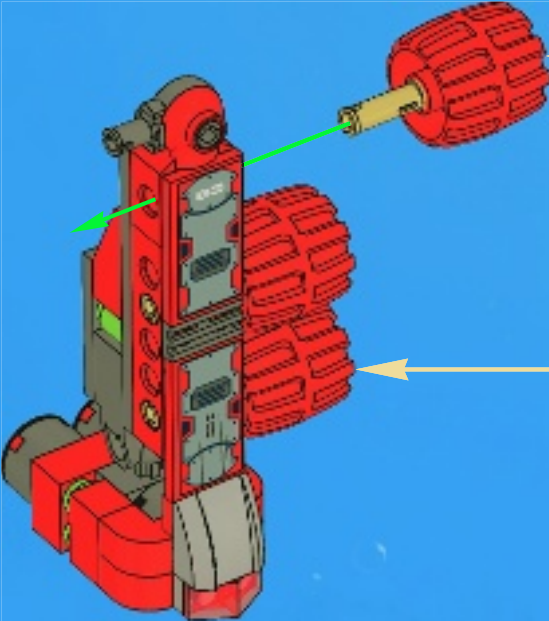
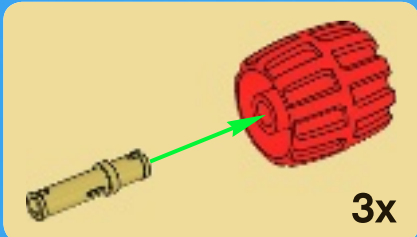





# 13

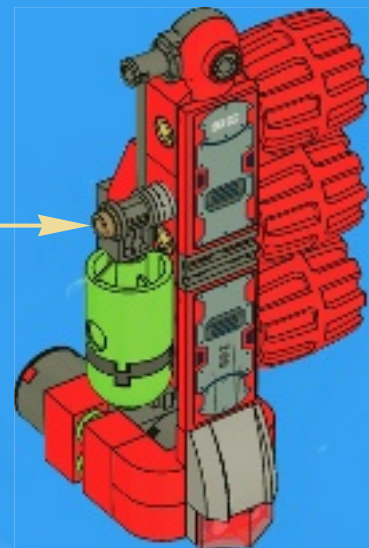
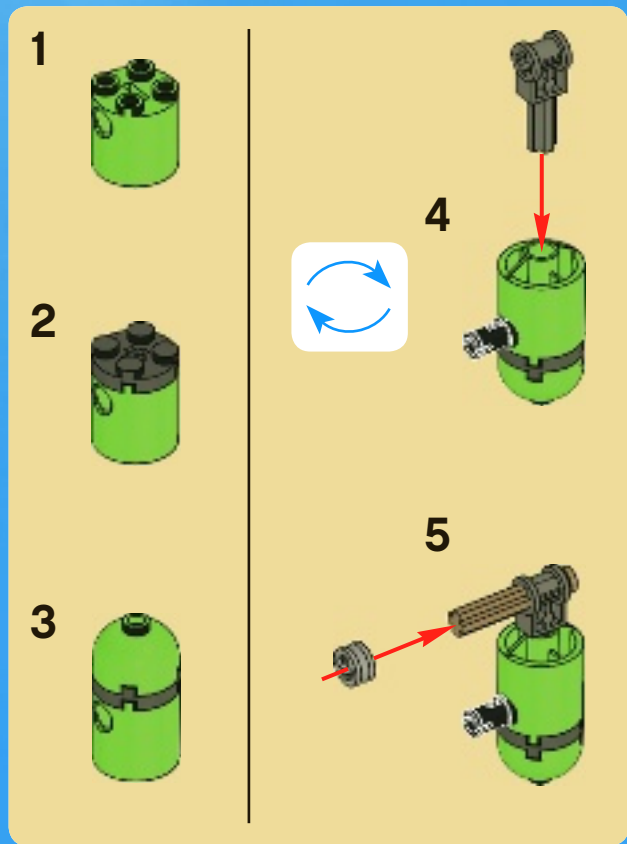

14

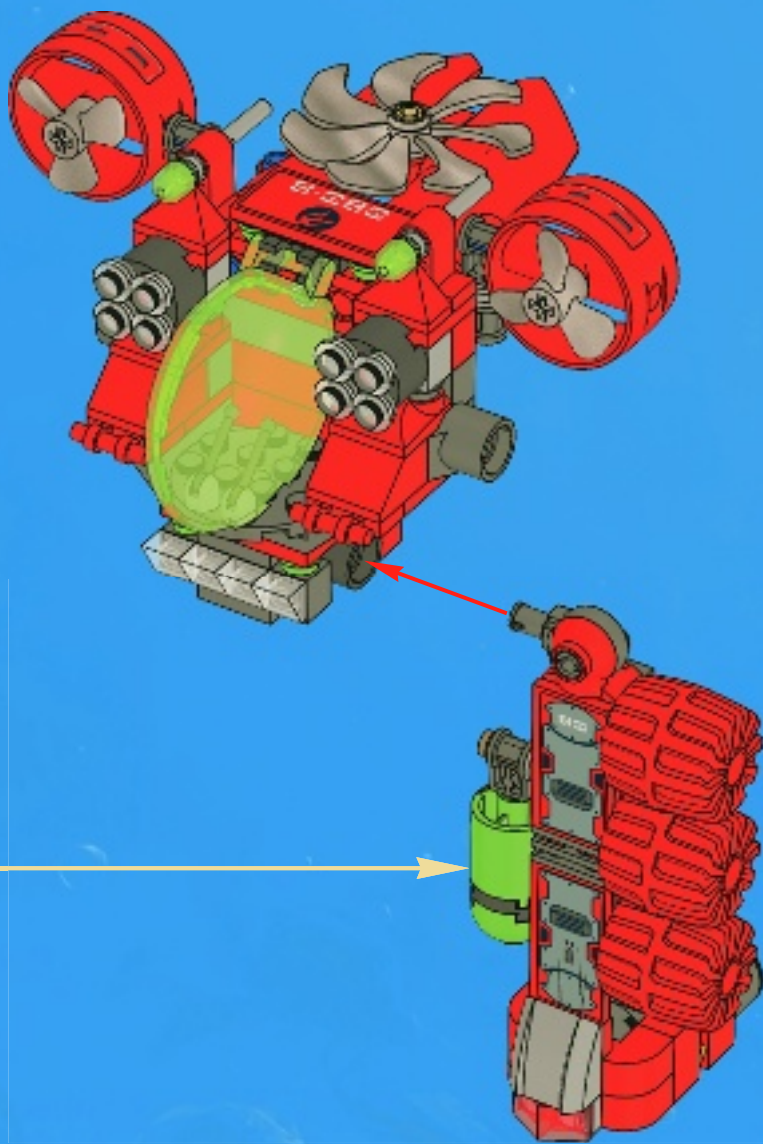

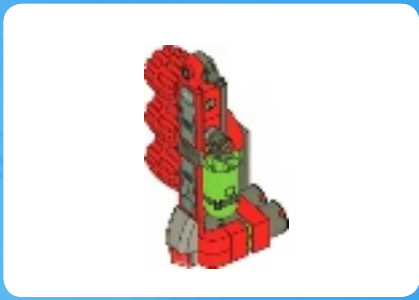

1



2

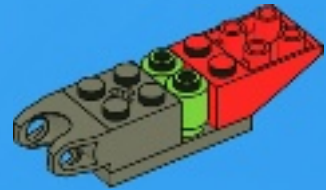

3

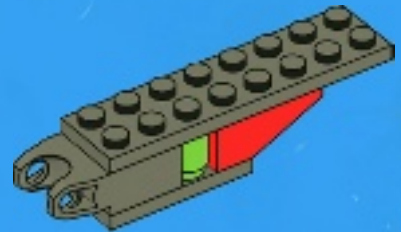



4

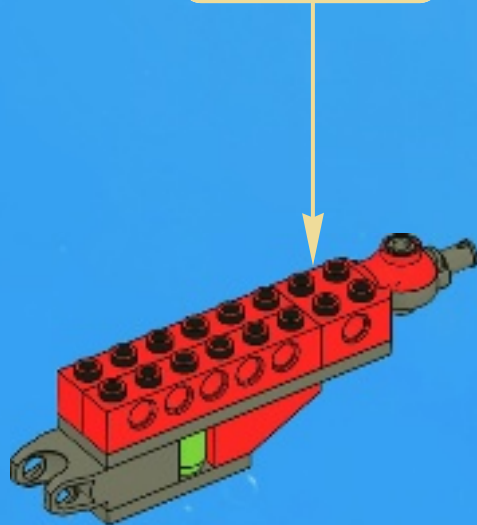
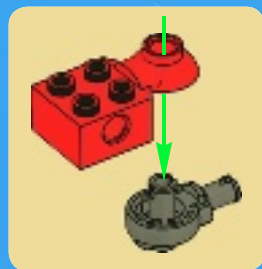

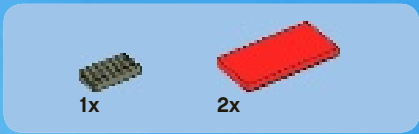

5

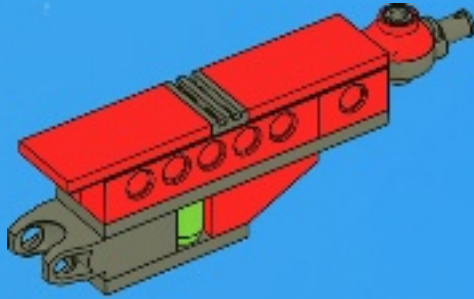

6

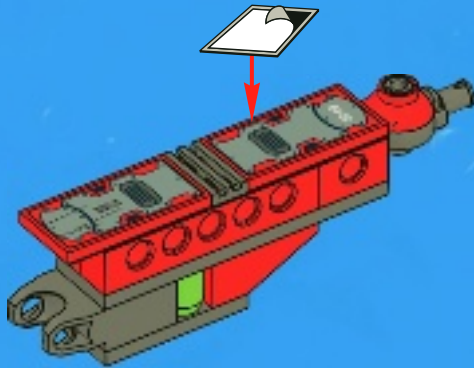



2x

1



1x

2



4x

3



1x

4







2x

5



1x

6

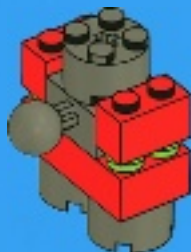

4x

7



1x

8





1x



1x

# 9

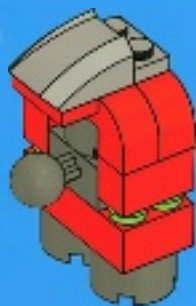

2x



2x

# 10

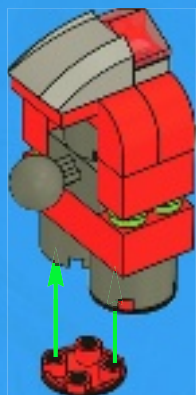

# 11

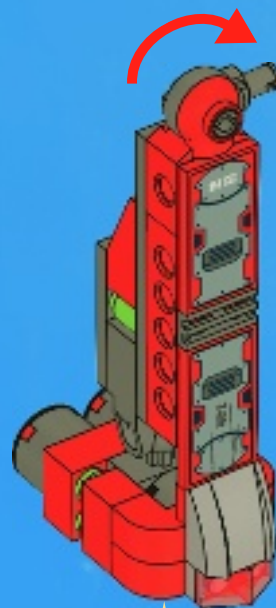



12

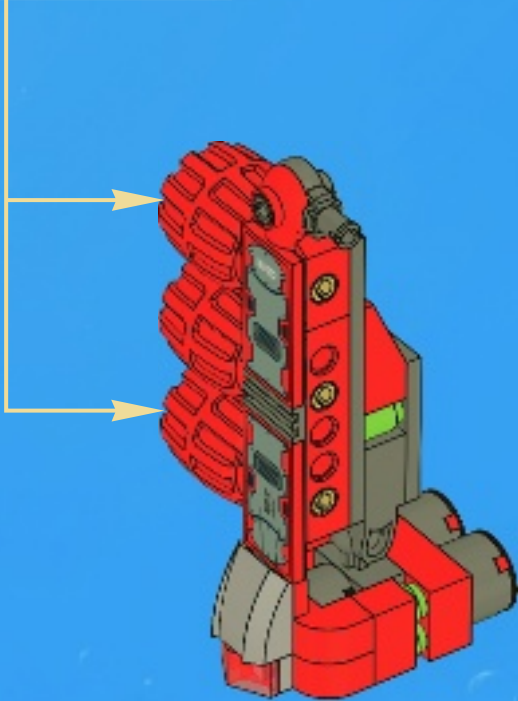
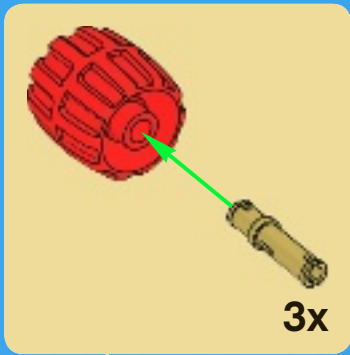



# 13

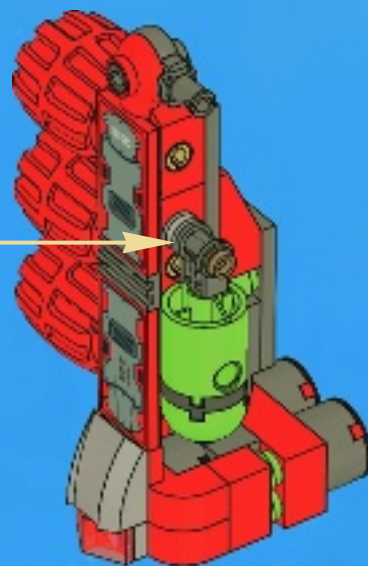
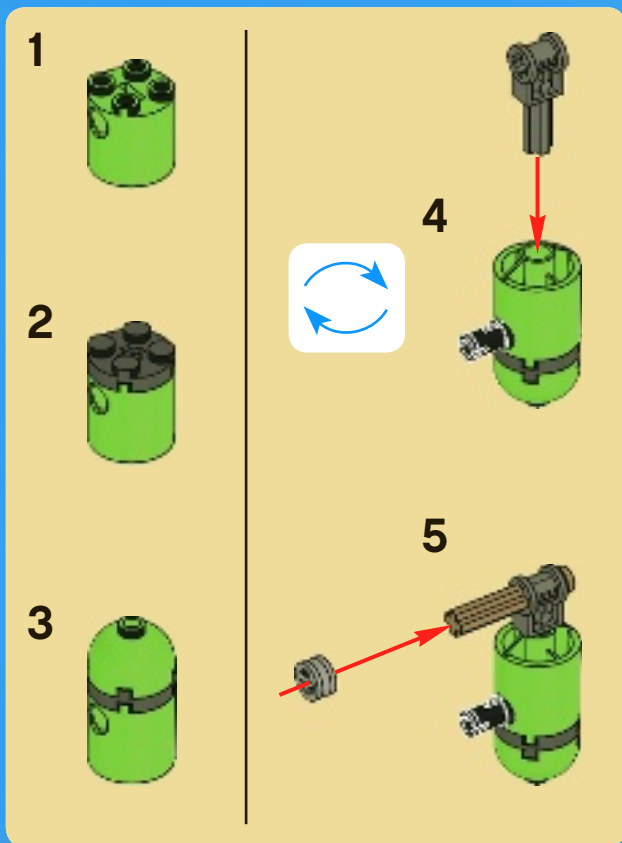

14

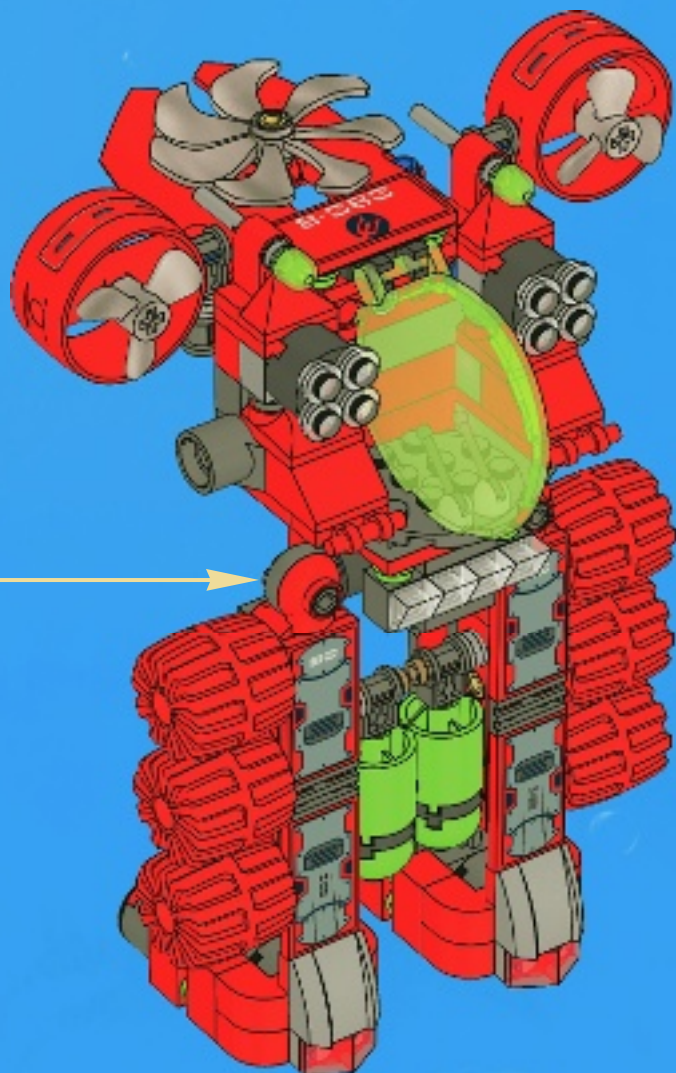



# 15

1

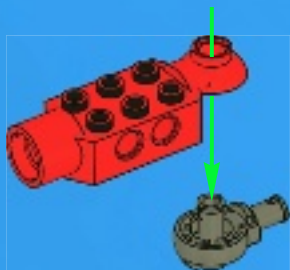

2

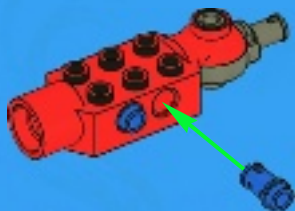

3



4



5





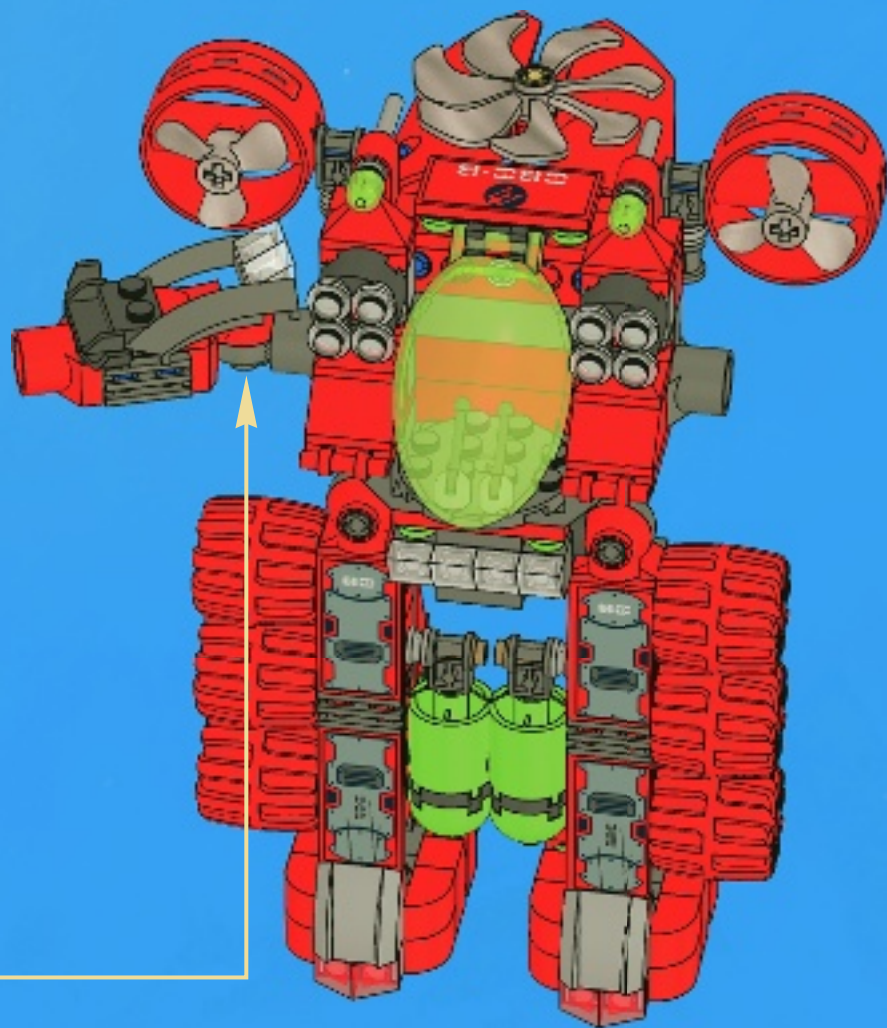



# 16

1

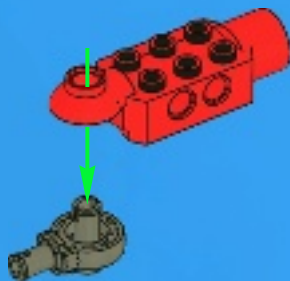

2

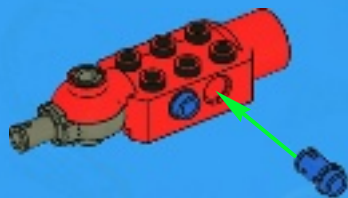

3

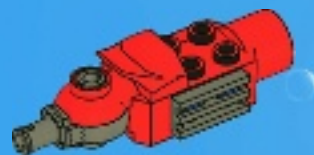

4



5



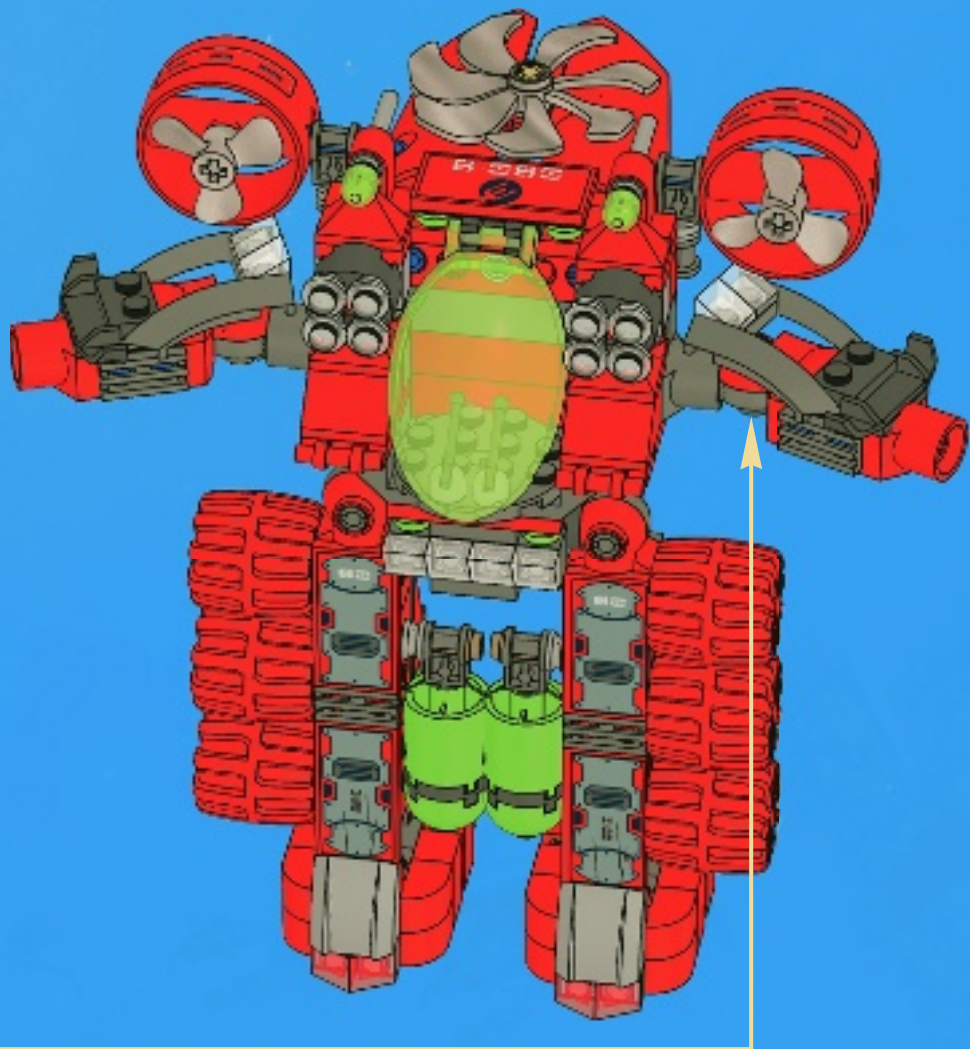



1x



1x

1

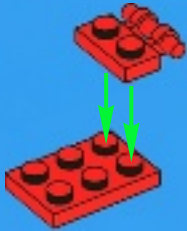

1x

2



1x



1x

3

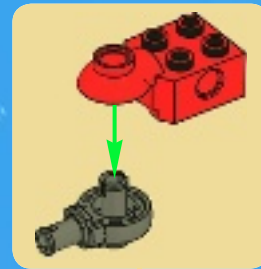

1x



1x

4





1x



1x

5



4x



4x

6

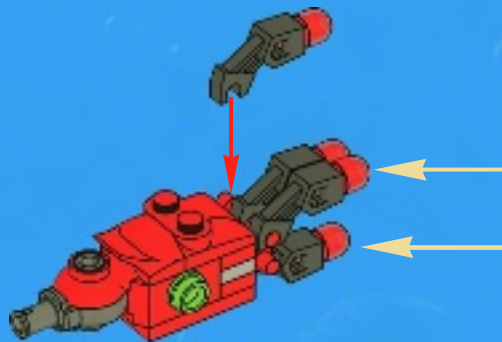
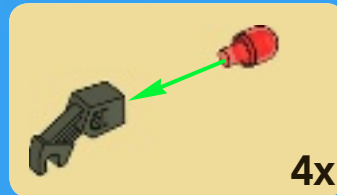



17

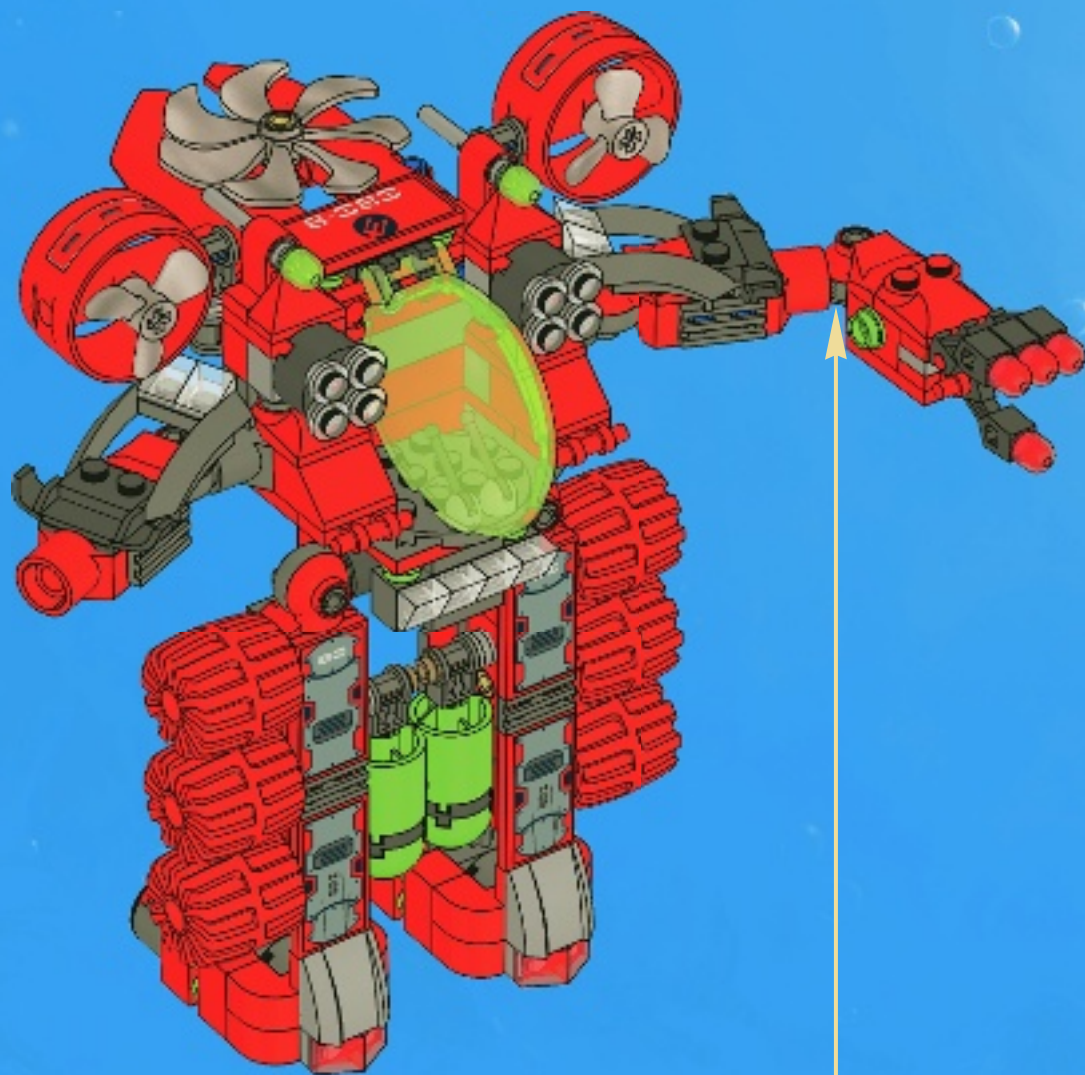





1x



1x

1

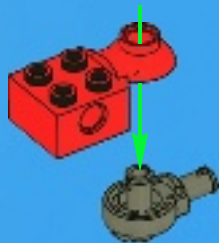

1x

2



1x

3



2x



1x

4

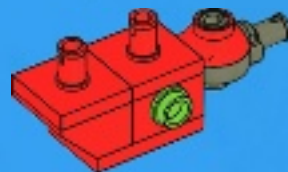

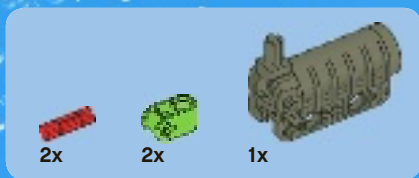

5

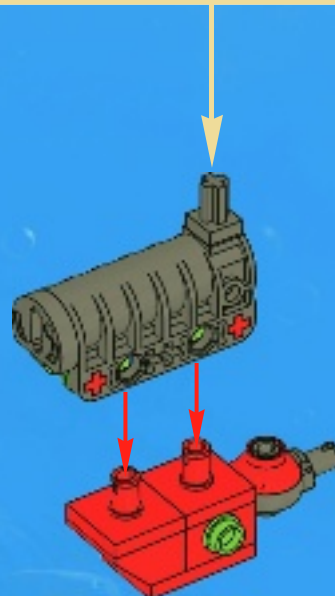
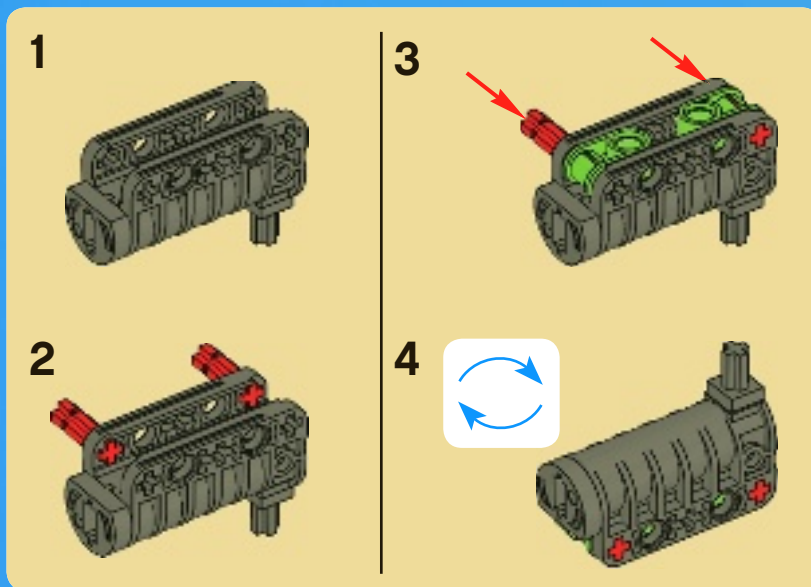



6

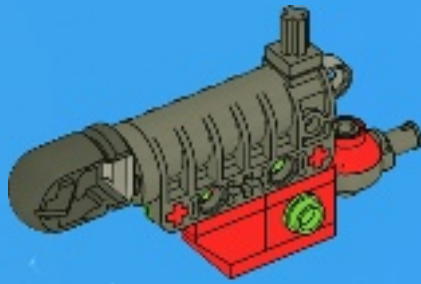

18

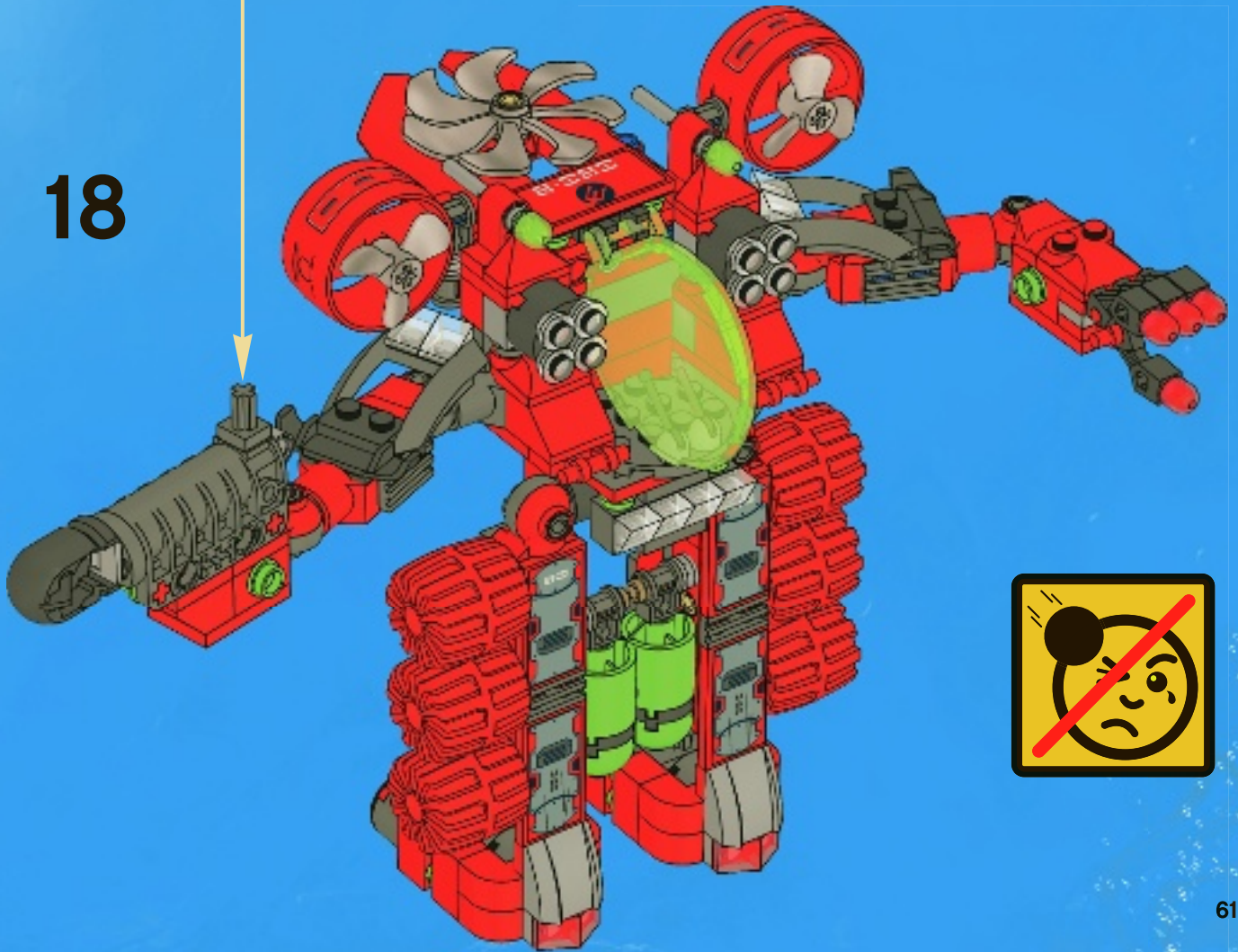



19

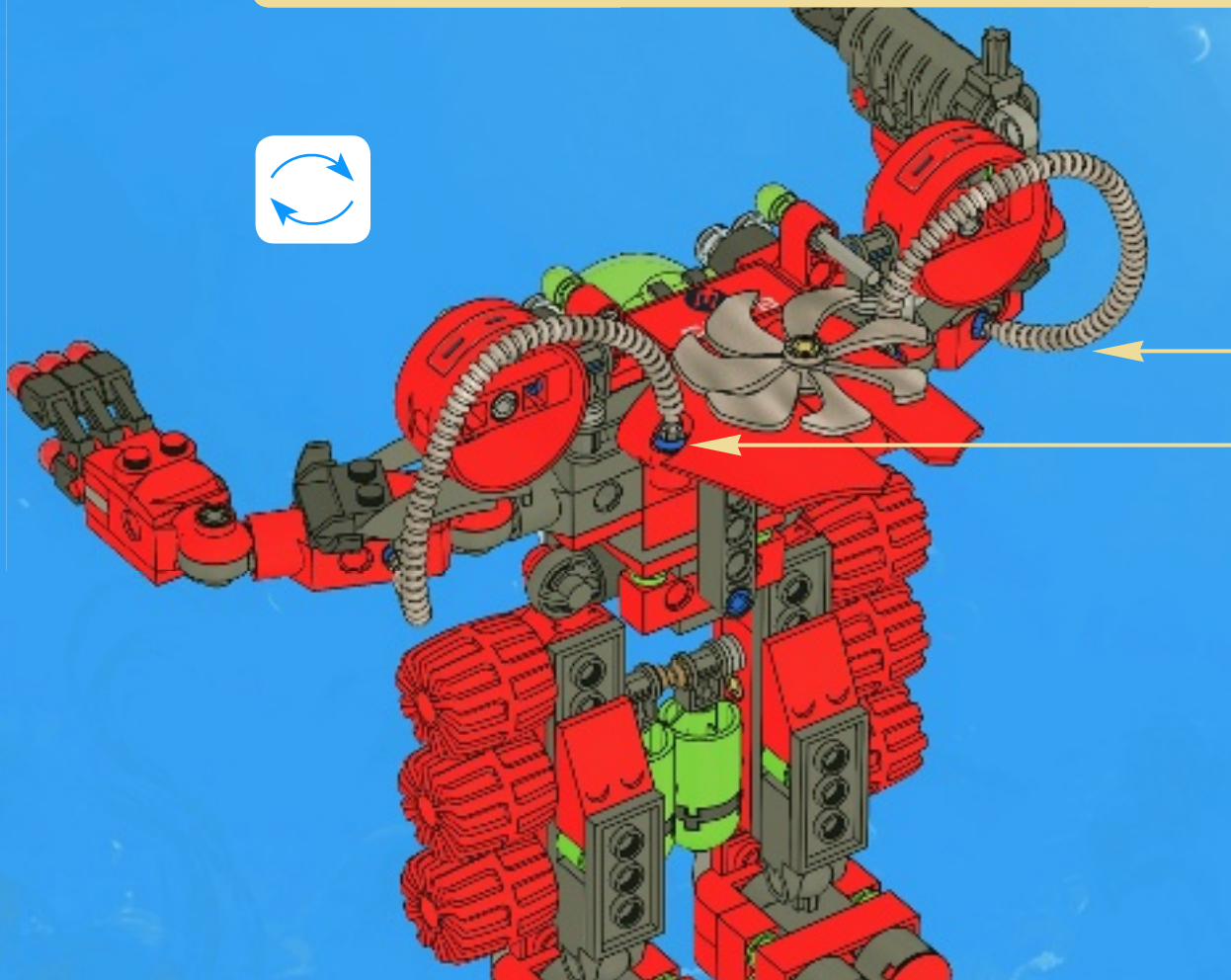



20

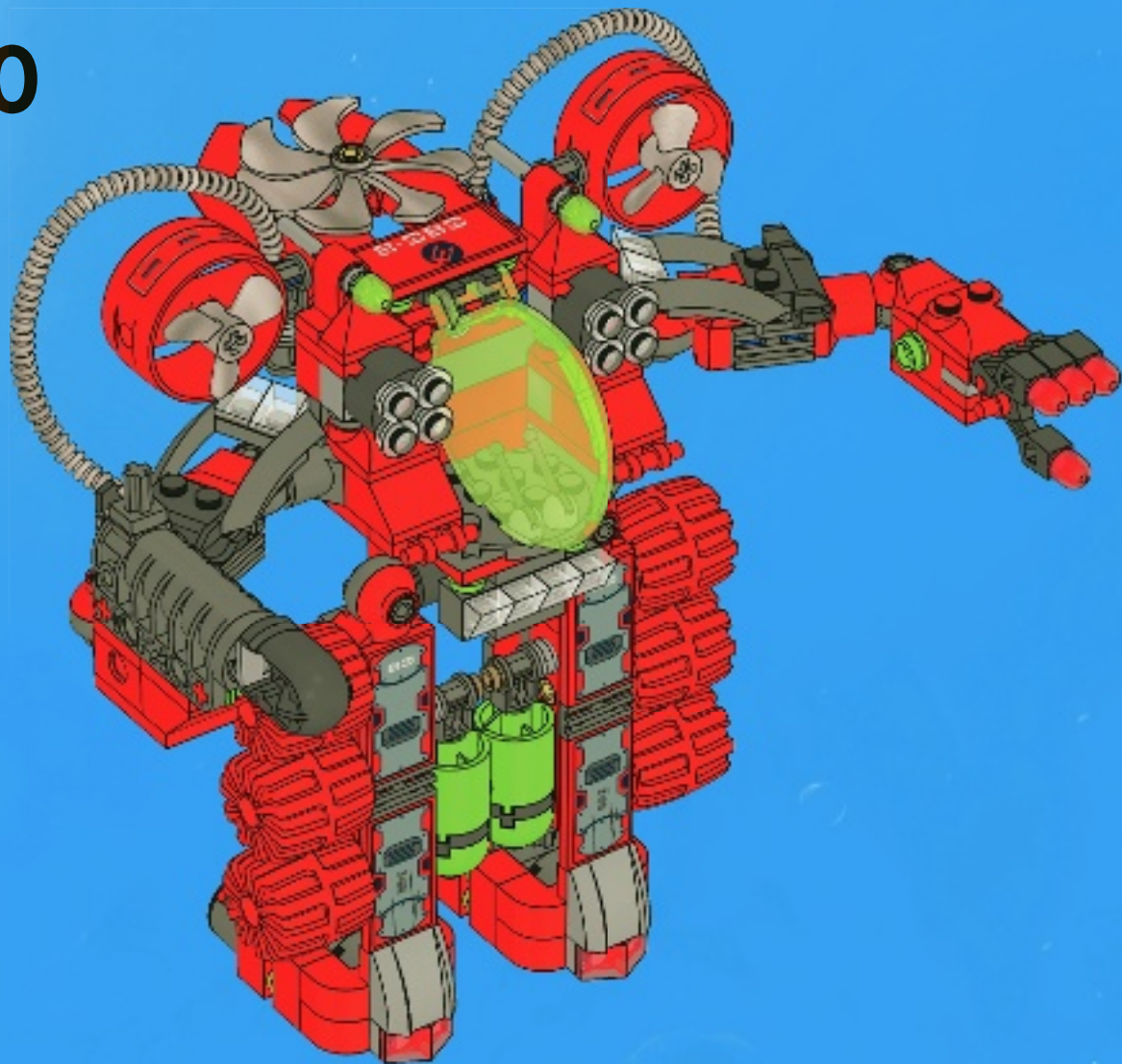

1

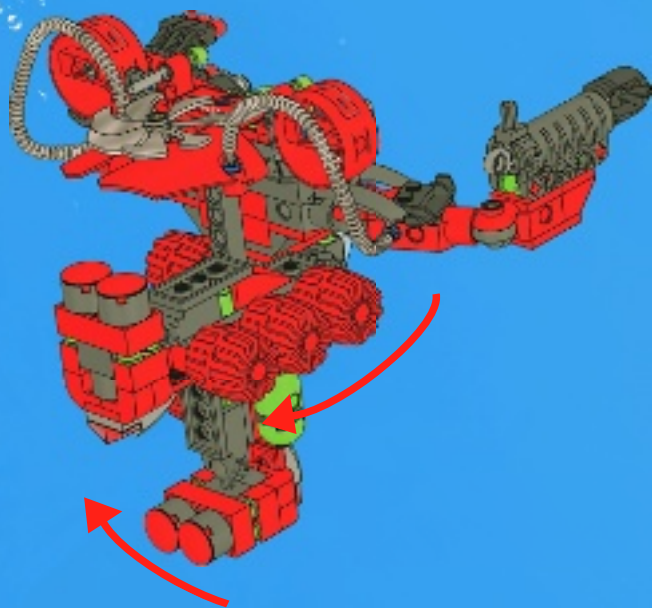

3

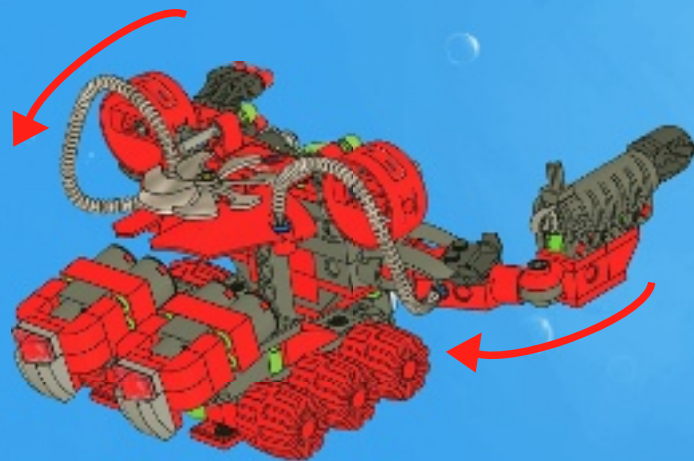

2

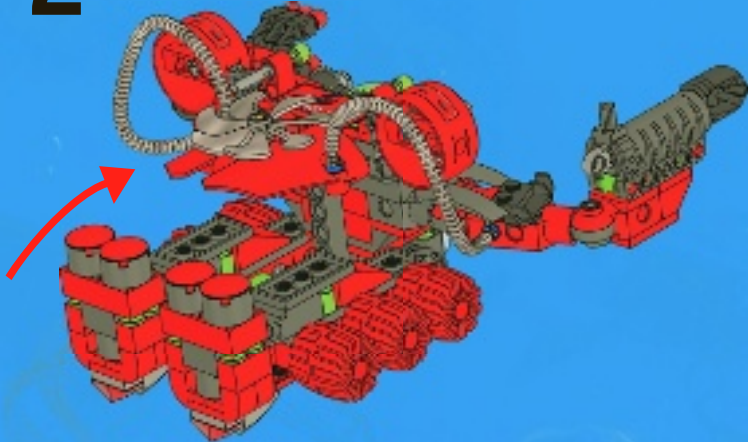

4

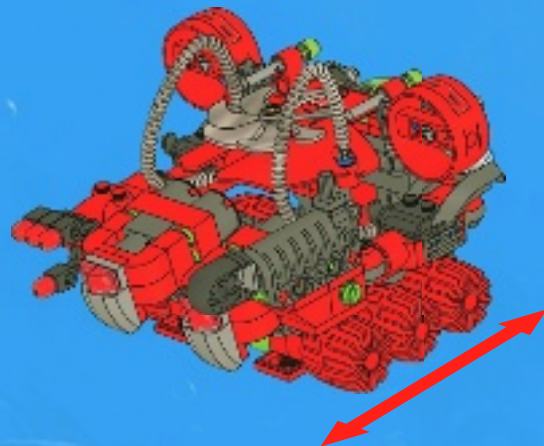





2x  
4568387

2x  
4566256

1x  
4186017

6x  
4514554

8x  
4143005

2x  
4206482

7x  
4514553

8x  
4244362

8x  
3005740

4x  
4244363

6x  
4497943

1x  
4565199

2x  
4570508

1x  
4563481

2x  
4566927

2x  
4233493

3x  
4211398

2x  
4221775

2x  
4162889

2x  
4520320

4x  
4211573

3x  
4211483

2x  
4211807

1x  
4299625

4x  
4212454

2x  
4279734

2x  
4550627

16x  
4183133

2x  
4261453

1x  
4570036

1x  
4568036

6x  
4522784

1x  
4211099

1x  
4495931

2x  
4210857

4x  
4210665

1x  
4210725

2x  
4225973

3x  
4497253

3x  
4524353

6x  
4249139

1x  
4549999

1x  
4210906

4x  
4211065

2x  
4210997

4x  
4210631

2x  
4561465

2x  
4294289

1x  
4518308

1x  
4570738

2x  
4570481

1x  
4563482

4x  
4210633

1x  
4528323

1x  
4563473



Customer Service

Kundenservice

Service Consommateurs

Servicio Al Consumidor

[www.lego.com/service](http://www.lego.com/service) or dial



00800 5346 5555 :



1-800-422-5346 :



4x  
300421



2x  
301021



2x  
300121



2x  
4585455



4x  
4225923



1x  
370121



4x  
389421



1x  
370221



2x  
4195004



2x  
303921



1x  
366021



2x  
4500462



8x  
609121

2x  
302221



8x  
302121



1x  
371021



5x  
4560179



1x  
4243814



2x  
4207715



4x  
4140585



2x  
246021



2x  
4588003



1x  
415021



4x  
4278275



3x  
4220516



3x  
4220515



1x  
4175442



6x  
4520122



2x  
4570494



1x  
4540798



1x  
4540801



4x  
4142865



1x  
300124



2x  
4504381



2x  
374724



2x  
408124



1x  
302324



1x  
371024



3x  
302024

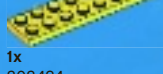

1x  
303424



3x  
4277925



1x  
4556156



6x  
614124



1x  
4260192



1x  
4570027



16x  
4568389



2x  
362226



1x  
4275826



2x  
614326



3x  
370026



4x  
4504382



1x  
4213298



2x  
242026



2x  
302126



2x  
371026

2x  
4517925



1x  
4556158



1x  
4225201



2x  
4277774



2x  
403226



2x  
4278359



4x  
4294996



3x  
4563477



8x  
4563474



2x  
4277967



3x  
4529173



2x  
4504187



4x  
4218581



3x  
4285883



11x  
4121715





8058



8058



8075



8075



8077



8077





8078



8078



8076



8076





# ATLANTIS

## MAP OF ATLANTIS

LO 230:23-5  
LA 40:22-7  
ETA 02:43:00

SIM 440:00-5  
IN 10:11-1  
OUT 30-33-33







DESTINATION  
LOCATED

L0 220-69-3  
L8 35140-8  
E18 00-03-20



# Atlantis.LEGO.com

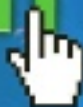







FREE! GRATIS! GRATUIT!





club  
MAGAZINE™

www.LEGOclub.com



00800 5346 5555\*        

  1-866-534-6258 • 1-877-518-5346

US & Canada only

Canada seule ment



VISIT THE WORLD'S  
BIGGEST LEGO® SHOP!

www.LEGOshop.com

\* Freephone. Mobile charges may apply. \* Numéro sans Frais. Des Frais peuvent s'appliquer avec les téléphones cellulaires. \* Gebührenfrei, Kosten für Anrufe aus Mobilfunknetzen können abweichen.  
\* Gratis telefonnummer vanaf vaste lijn. \* Det er ett gratis nummer, när du ringer från FastTelefon. \* Det är gratis, när du ringer från en Fast Telefon.





**YES! I want to join the LEGO® Club FREE! OUI! Je veux m'abonner au Club LEGO® GRATUITEMENT! Ja! Ich möchte Mitglied im kostenlosen LEGO® Club werden. Ja! Ik wil graag GRATIS lid worden van de LEGO® Club. Ja! Jeg ønsker å melde meg inn i LEGO® Club gratis! Ja! Jag vill gå med i LEGO® Club GRATIS!**

First name · Prénom  
Vorname · Voornaam  
Fornavn · Förnamn

Last name · Nom de Famille  
Name · Achternaam  
Etternavn · Efternavn

Date of Birth · Date de naissance  
Geburtsstag · Geboortedatum  
Fødselsdato · Fødselsdato

Boy · Garçon  
Junge · Jongen  
Gutt · Pojke

Girl · Fille  
Mädchen · Meisje  
Jente · Flicka

Street · Adresse  
Straße, Hausnr.  
Straat, huisnr. · Adress

City · Ville  
Ort · Woonplaats  
Poststed · Postort

State  
Prov.  
County

Zip/Postcode · Code Postal  
PLZ · Postcode · Postnummer

Country  
Pays · Land

Please tick below if you would like to receive other communication from the LEGO Group. Si vous aimeriez recevoir d'autres communications de la part de la Compagnie LEGO, veuillez s.v.p. cocher ici. Als u graag verdere informatie van de LEGO Groep wilt ontvangen, kruis dan a.u.b. dit vakje aan. Ich möchte über Produkte, Angebote, Aktionen und weitere interessante Themen von der LEGO Gruppe informiert werden\* (bitte ankreuzen). Om du vill få annan information från LEGO Gruppen, sätt kryss här. Hvis du ønsker å motta annen informasjon fra LEGO Gruppen, merker du av her.

Post · Poste  
Per Post

Email · Courriel  
Per E-Mail  
E-Mail

Ich möchte über Produkte, Angebote, Aktionen und weitere interessante Themen von sonstigen LEGO Partnerunternehmen informiert werden\* (bitte ankreuzen).  Per Post  Per E-Mail

Mail to: / Poster à:



BG29

Mail to:



BI09U

Per Post an:



BI09C

Stuur op naar:



BI09N

Send til:



BI09O

Skickas till:



BI09S

LEGO® Club  
P.O. Box 1157  
EnField, CT USA  
06083-1157

LEGO® Club  
33 Bath Road  
Slough SL1 3UF  
United Kingdom

LEGO® Club  
Postfach 14 15  
D-36243 Niederaula

LEGO® Club  
Postbus 40250  
3504 AB Utrecht

LEGO® Club Norge  
Postboks 58  
1314 Vøyenenga

LEGO® Club Sverige  
Ubox 841  
202 29 Malmö

The English language version of the magazine can only be mailed to addresses in the US, Canada, the UK, and Republic of Ireland. Club membership is valid for two years and includes free copies of the LEGO Club Magazine. In the US and Canada please allow up to 6 weeks for delivery of your first magazine. In the UK and Republic of Ireland please allow six to 14 weeks for delivery of your first magazine. By signing this form you consent the LEGO Club to use your child's data for LEGO mailings. The data will only be used for LEGO mailings and will not be sold, rented or otherwise disclosed to any company outside the LEGO Company except for disclosure to companies acting as our agents to help us provide services requested by the child. This coupon is valid for one free membership per person, group or organisation. Photocopied coupons are accepted. La version française du magazine peut être postée uniquement au Canada. L'abonnement est valide pour 2 ans et inclut des exemplaires gratuits du Magazine LEGO. Aux É.-U. et au Canada, allouer 6 semaines pour la livraison initiale. En remplissant ce formulaire, vous consentez à ce que LEGO utilise les informations de votre enfant pour des envois postaux de LEGO. L'information sera utilisée uniquement pour des envois postaux par LEGO et ne sera en aucun cas, vendue, louée, échangée ou divulguée à d'autres compagnies autres que la compagnie LEGO, à l'exception des compagnies affiliées qui nous procurent des services auxquels l'enfant en a fait la demande.

Das deutschsprachige LEGO Club Magazin kann nur an Adressen in Deutschland, Österreich und der Schweiz verschickt werden. Die kostenlose Mitgliedschaft beinhaltet die Zusendung des LEGO Club Magazines und endet nach zwei Jahren. Mit der Anmeldung gehen Sie keine Verpflichtungen ein. Es kann bis zu drei Monate dauern, bis das erste Magazin zugestellt wird. Mit Ihrer Unterschrift erklären Sie sich damit einverstanden, dass die Daten Ihres Kindes zum Zweck einer LEGO Club Mitgliedschaft von der LEGO Gruppe gespeichert und verarbeitet werden. Die Daten werden vertraulich behandelt, nicht an Dritte weitergegeben und nicht veräußert. Externe Dienstleister erhalten Ihre Daten nur, soweit es für die Abwicklung von LEGO Kommunikation erforderlich ist. Wenn Sie von uns nicht mehr kontaktiert werden möchten, können Sie der Verwendung Ihrer Daten für Werbezwecke widersprechen unter: 00800 5346 5555 (Anruf gebührenfrei, Kosten für Anrufe aus Mobilfunknetzen können abweichen). \* Die Einwilligungen kann ich jederzeit (insgesamt oder zum Teil) ohne Einfluss auf die LEGO Club Mitgliedschaft bei der LEGO Gruppe widerrufen. Het LEGO Club Magazine kan alleen worden gestuurd naar adressen in Nederland. Het lidmaatschap is 2 jaar geldig en geeft recht op toezending van het gratis LEGO Club Magazine. Het eerste magazine zal na 12 tot 14 weken toegestuurd worden. Het lidmaatschap kan op ieder moment opgezegd worden. Door dit formulier te tekenen geeft u de LEGO Club toestemming om bovenstaande gegevens te gebruiken voor het toesturen van LEGO mailings. Uw gegevens worden uitsluitend gebruikt voor mailings van LEGO en zullen niet worden verkocht, verhuurd of op welke wijze dan ook verstrekt aan derden buiten de LEGO Groep, uitgezonderd de organisaties die namens ons optreden om de service te verlenen waar uw kind om gevraagd heeft. Den norske utgaven av magasinet sendes kun til adresser i Norge. Medlemskap i klubben gjelder i 2 år og inkluderer gratisutgaver av LEGO Magazine. Pæren opp til seks uker leveringstid for første magasin. Ved å undertegne dette skjemaet, gir du ditt samtykke til at LEGO Club kan bruke opplysningene om barnet ditt i LEGO forsendelser. Dataene vil utelukkende bli brukt i LEGO forsendelser og vil ikke bli solgt, utleid eller på annen måte gjøres tilgjengelig for selskaper utenfor LEGO gruppen, unntatt selskaper som er våre agenter og som hjelper oss å tilby tjenestene barnet etterspør. Dette skjemaet gjelder for ett gratis medlemskap per person, gruppe eller organisasjon. Den svenska versionen av tidningen kan endast skickas till adresser i Sverige. Club-medlemskapet är giltigt i 2 år och innefattar gratis exemplar av LEGO Club Magazine. Vänligen räkna med 6 veckor för leverans av din första tidning. Genom att skicka in det här formuläret godkänner du att LEGO Club använder barnets uppgifter för LEGO utskick. Uppgifterna kommer bara att användas för LEGO utskick och kommer inte att säljas, hyras ut eller vidarebefordras till något företag som inte tillhör LEGO Gruppen, med undantag av företag som agerar som våra ombud för att tillhandahålla tjänster som barnet har begärt. Den här kupongen gäller för ett gratis medlemskap per person, grupp eller organisation.

Parent's signature · Signature d'un parent · Unterschrift Erziehungsberechtigte/r  
Handtekening ouders · Foreldres/Foresattes underskrift · Förälders/Förmyndares underskrift

Date  
Datum  
Date



# WIN!

Go to [www.nielsen.com/LEGO](http://www.nielsen.com/LEGO)  
to fill out a survey for a chance  
to win a cool LEGO® Product.  
No purchase necessary.  
Open to all residents where not prohibited.



## [www.nielsen.com/LEGO](http://www.nielsen.com/LEGO)

### GEWINNE! WIN!

Nimm an der Umfrage auf  
[www.nielsen.com/](http://www.nielsen.com/)  
LEGO teil und hab die Chance ein cooles  
LEGO® Produkt zu gewinnen!

Die Teilnahme am Gewinnspiel führt zu keinerlei  
Kaufverpflichtungen. Teilnahme in allen nicht  
ausgeschlossenen Ländern möglich.

Ga naar [www.nielsen.com/LEGO](http://www.nielsen.com/LEGO),  
vul een enquêteformulier in en  
maak kans op een  
cool LEGO® product.

Geen aankoopverplichting.  
Iedereen mag deelnemen, uitgezonderd  
ingezetenden  
van landen waar een enquêteverbod geldt.

### GAGNE! 当てよう!

Visite [www.nielsen.com/LEGO](http://www.nielsen.com/LEGO)  
pour répondre à un questionnaire  
et avoir une chance de gagner  
un produit LEGO® très cool!

Aucune obligation d'achat.  
Ouvert à tous les résidents des pays  
autorisés.

[www.nielsen.com/LEGO](http://www.nielsen.com/LEGO)にアクセスして、アンケ  
ートにご記入ください。当選者にはレゴ®製品を  
差し上げます。

お買い上げの必要はありません。

禁止されていない限り、すべての皆様にご利用いただけます。