

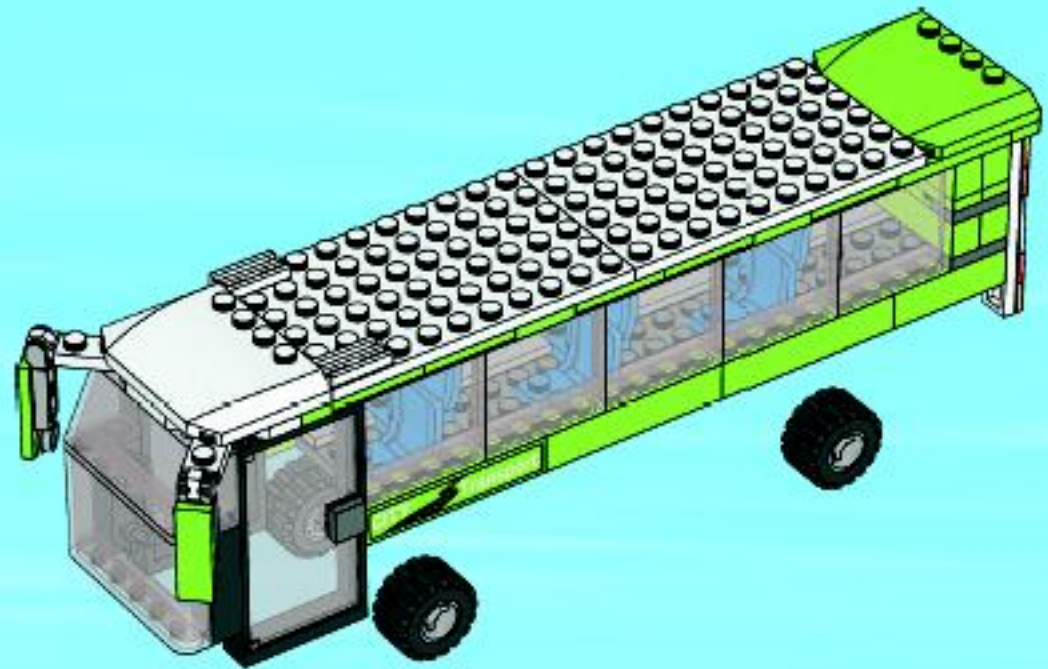

8404

CITY

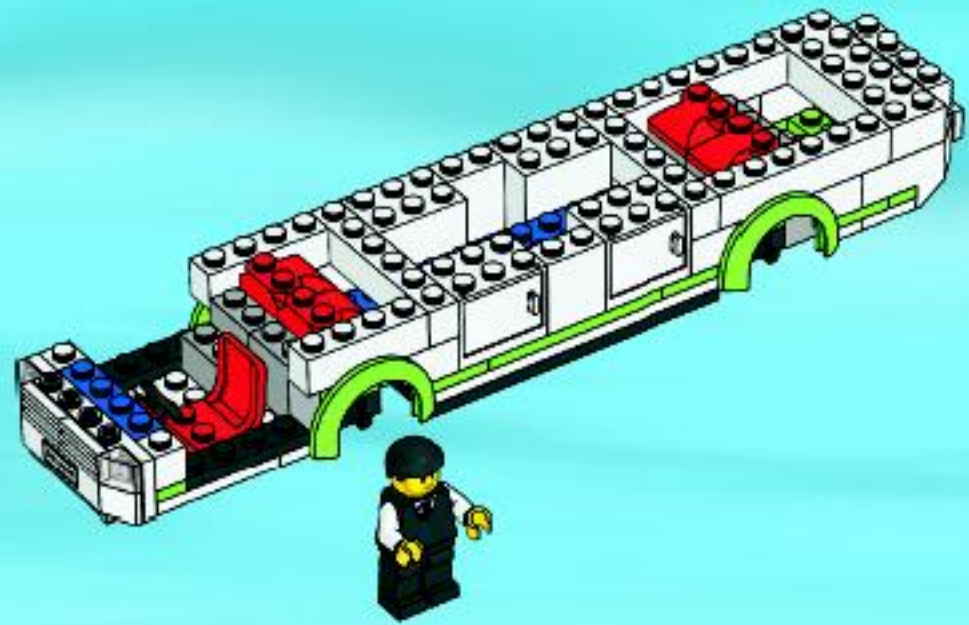



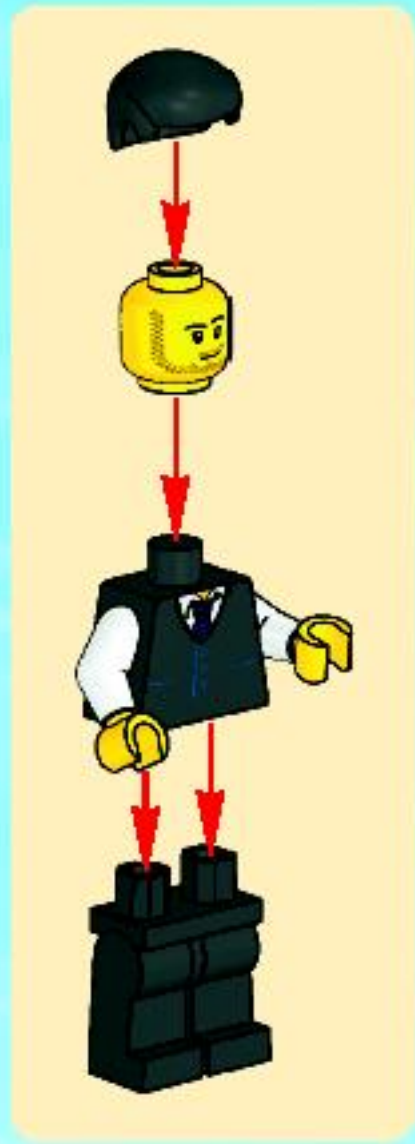
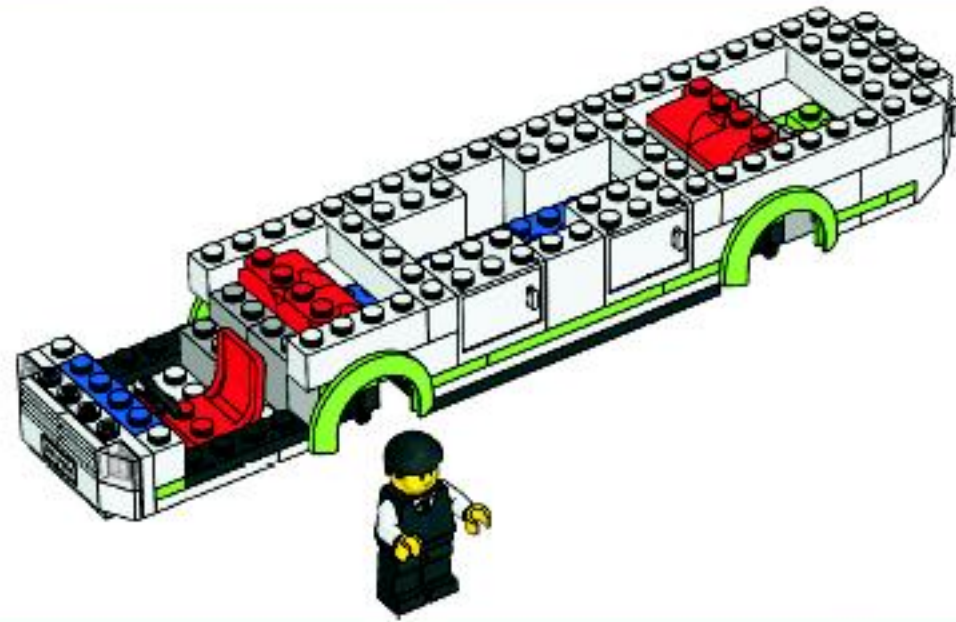

1

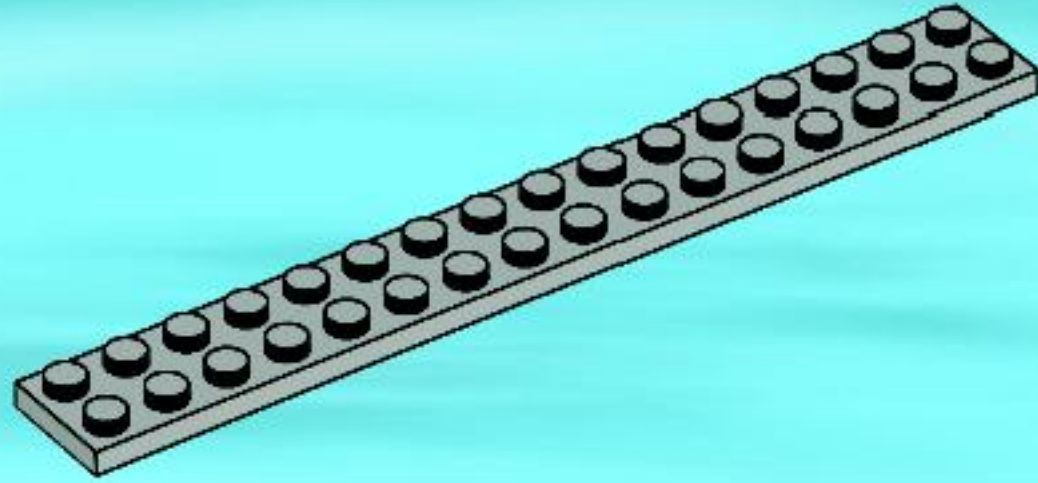

2

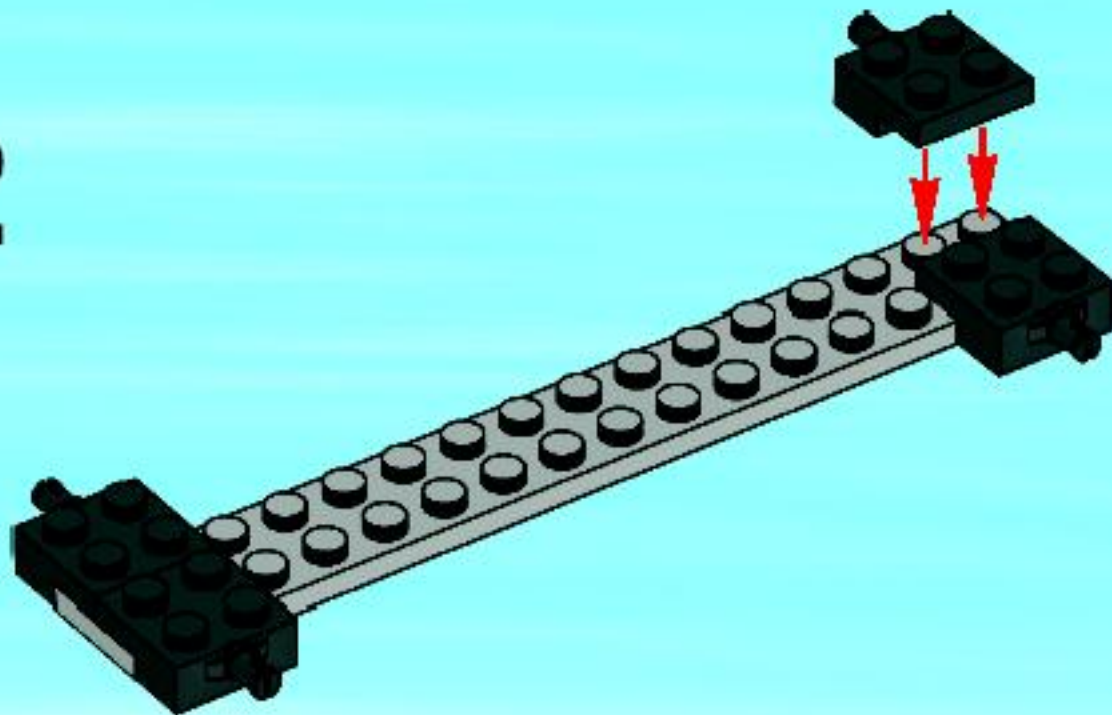

3

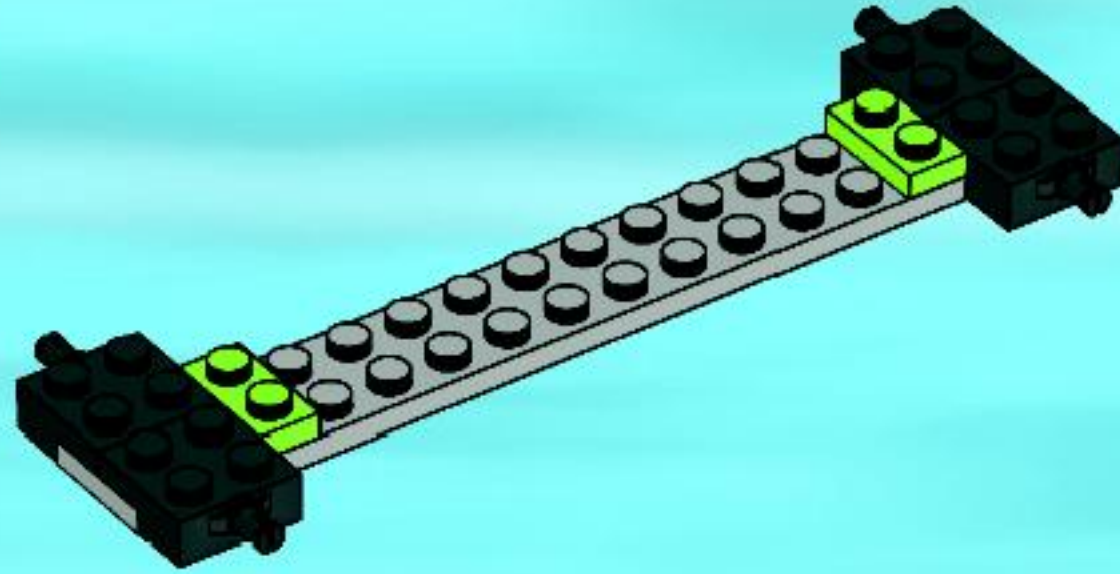

4

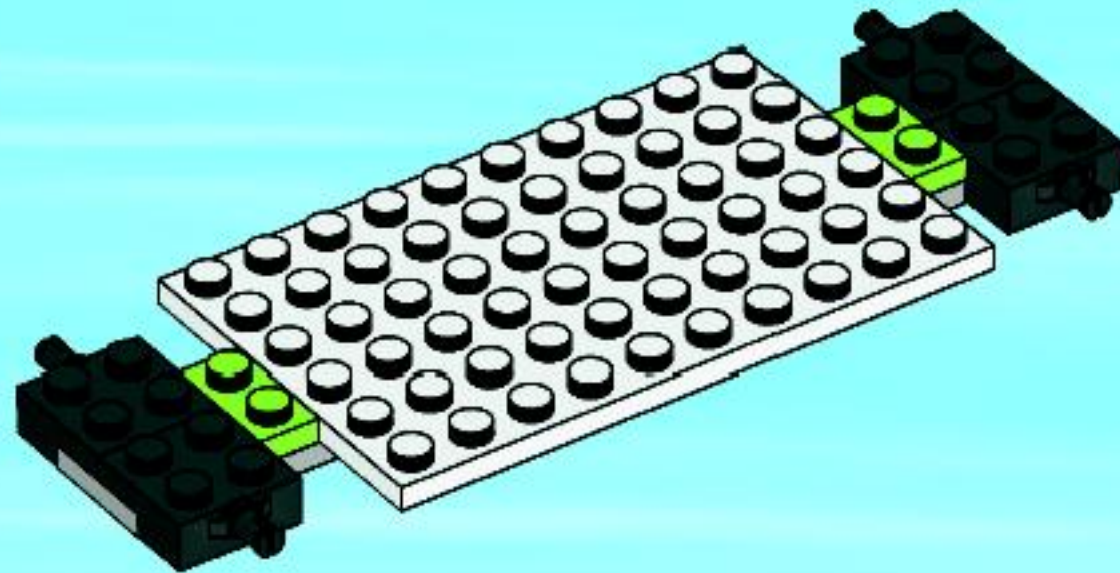

5

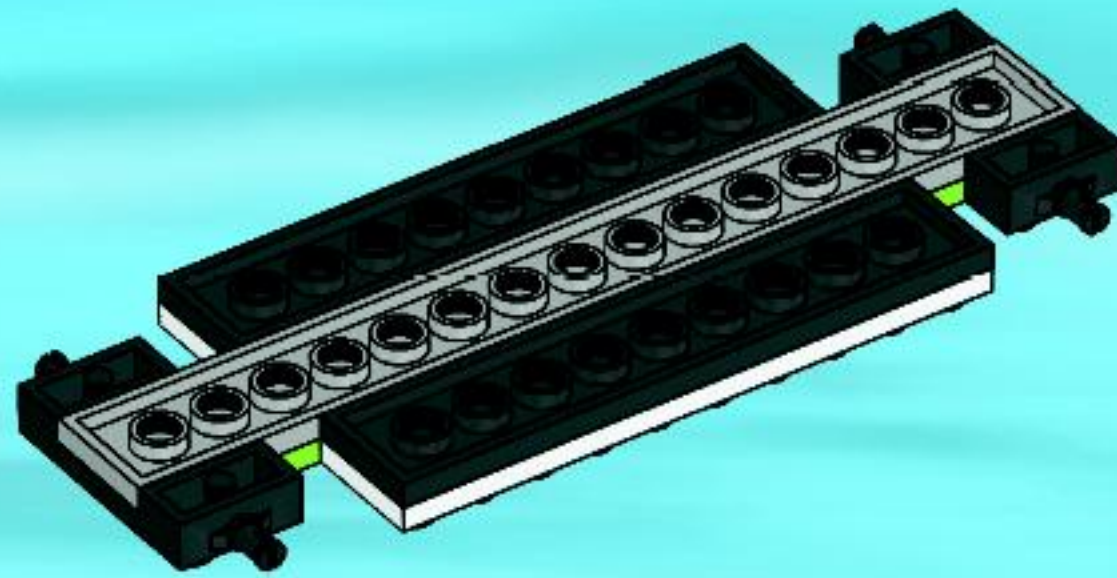

6

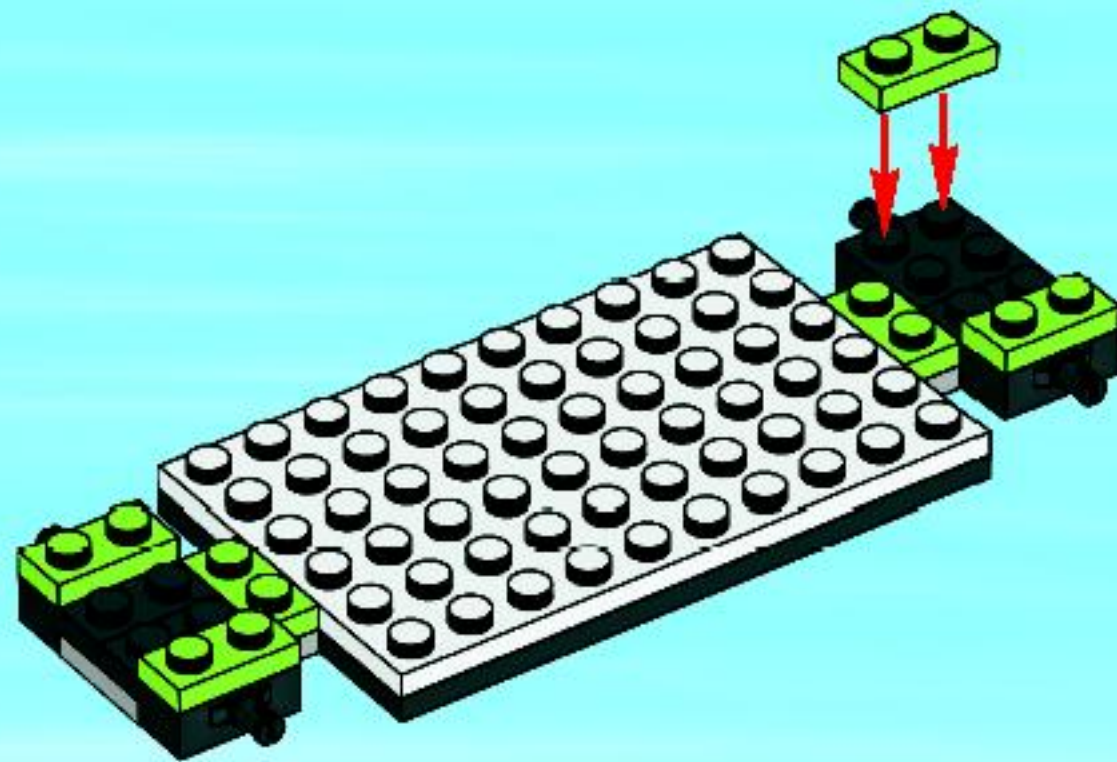

9

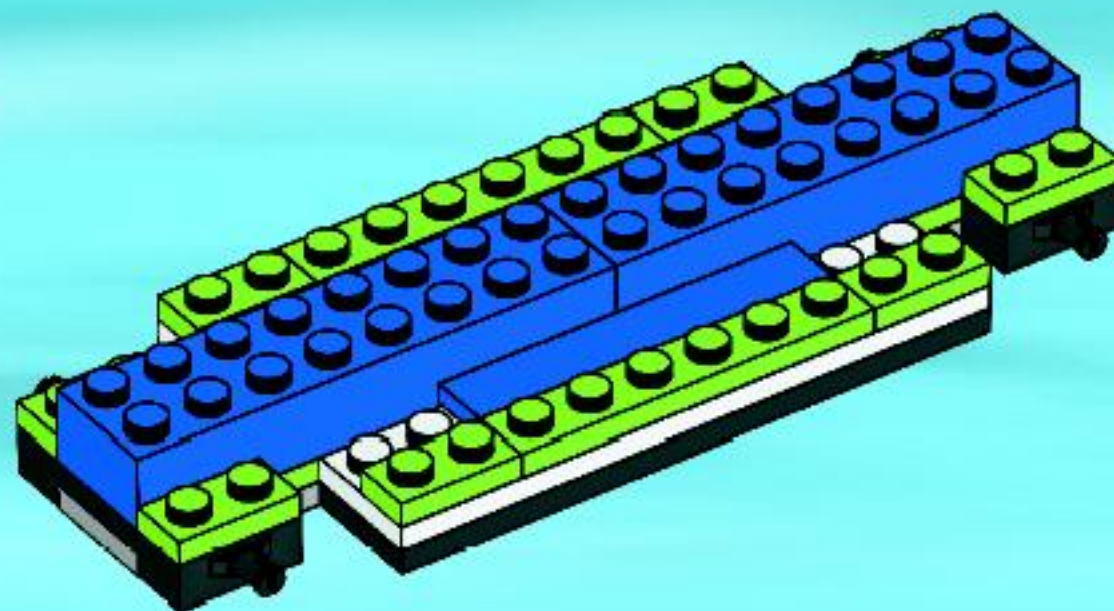

10

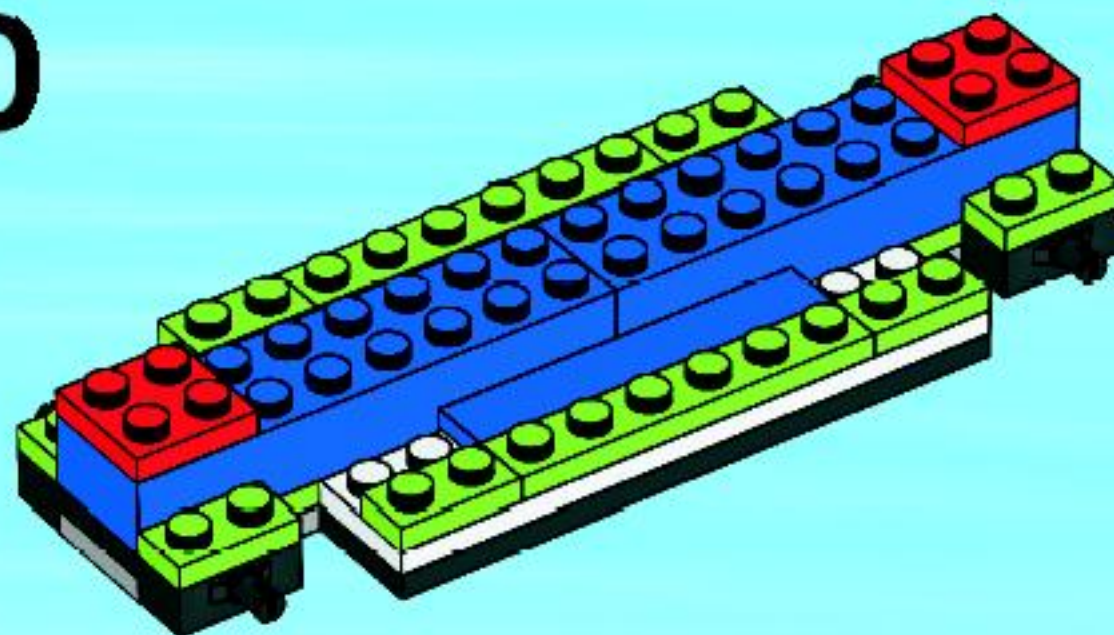

11

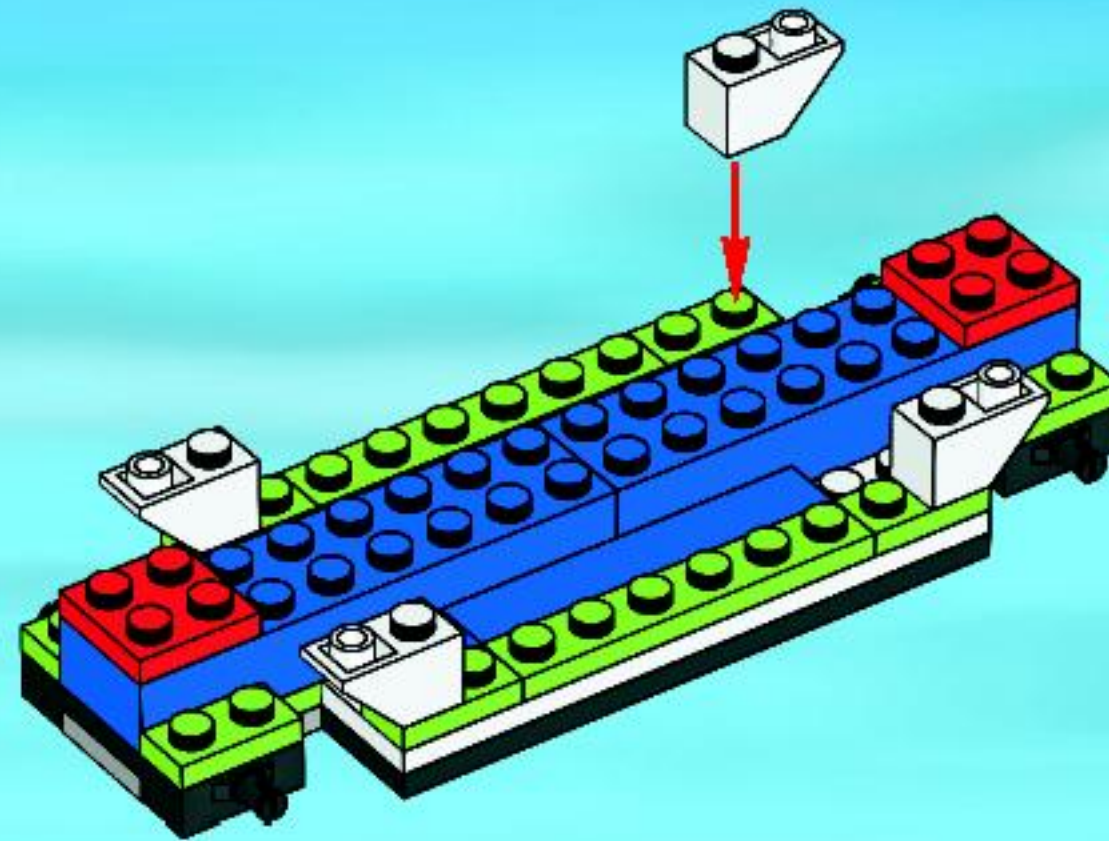

12

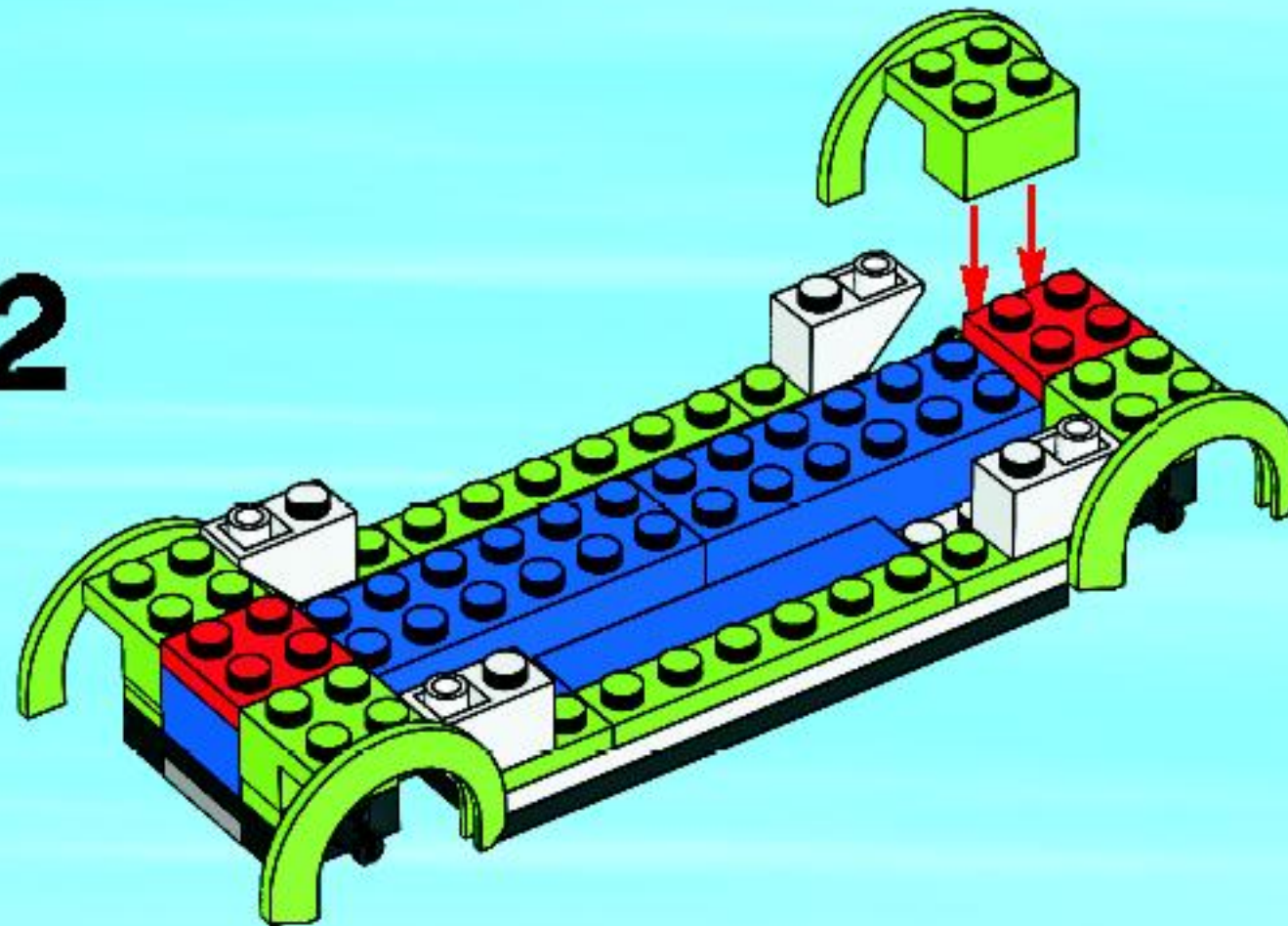

13

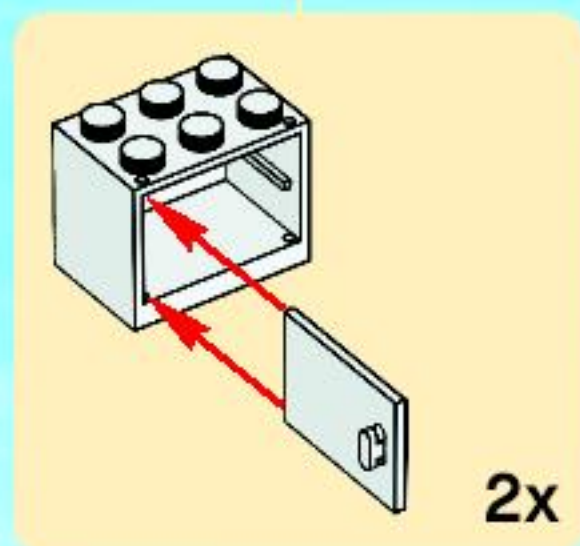
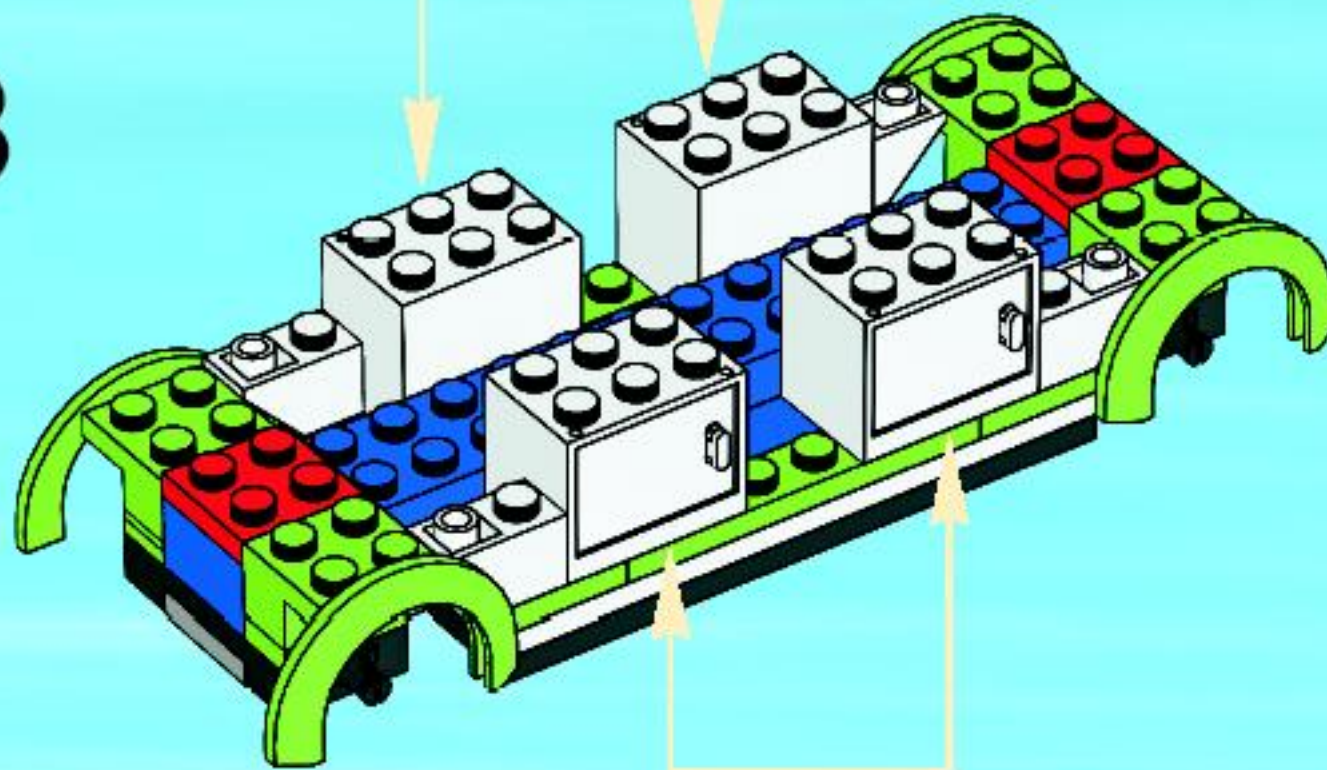
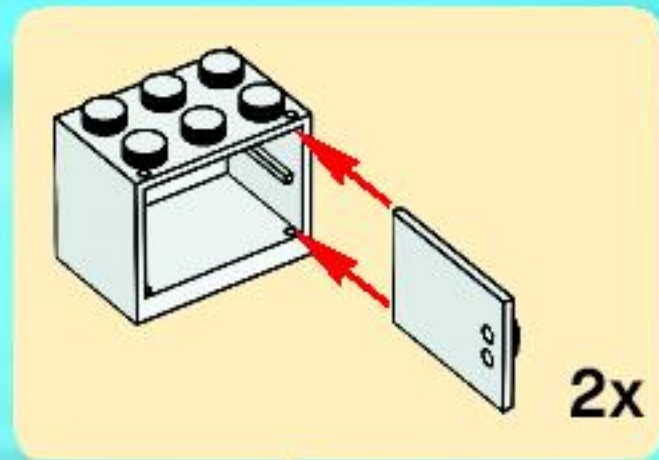

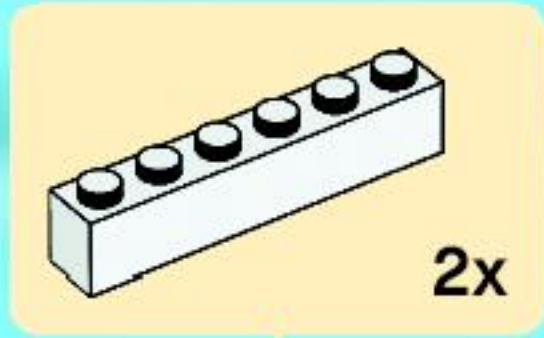

14

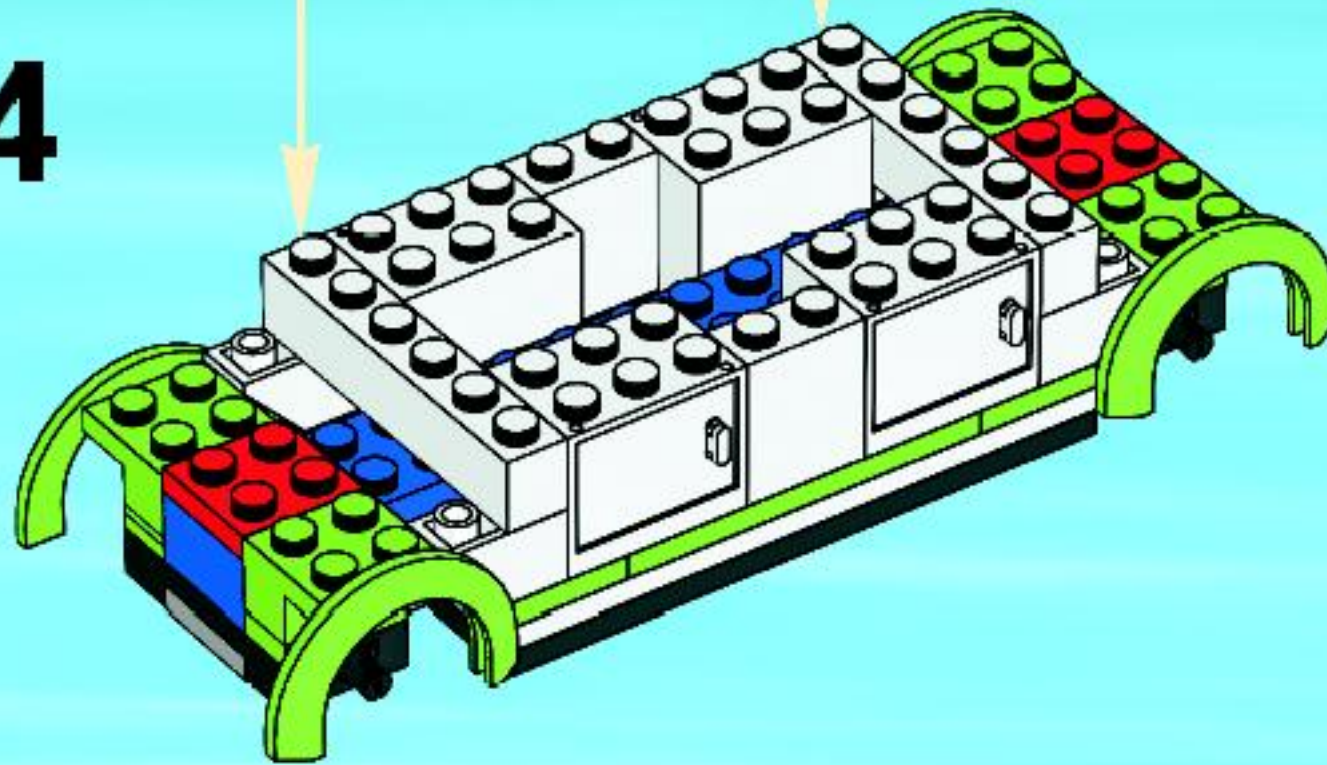

15

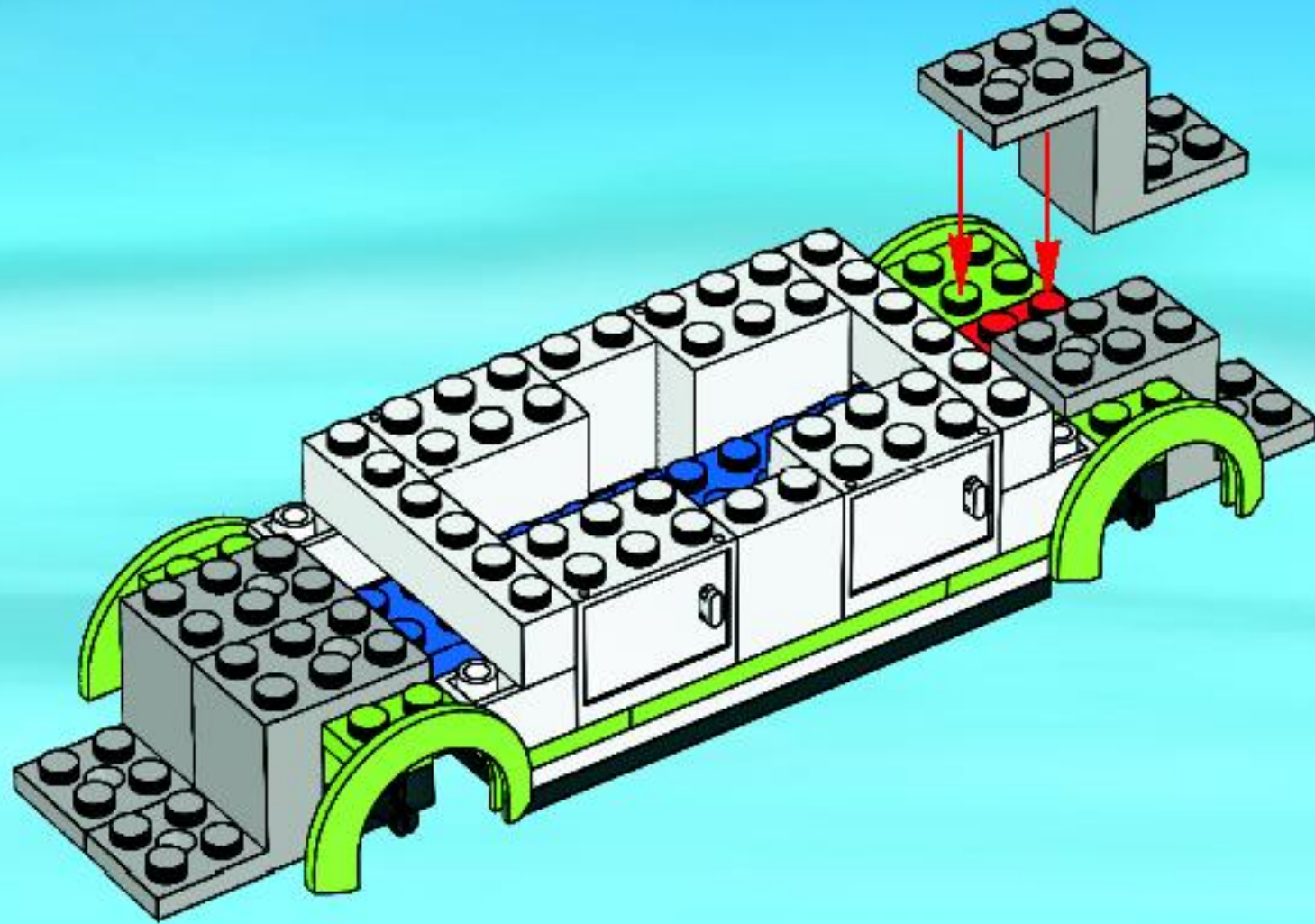

16

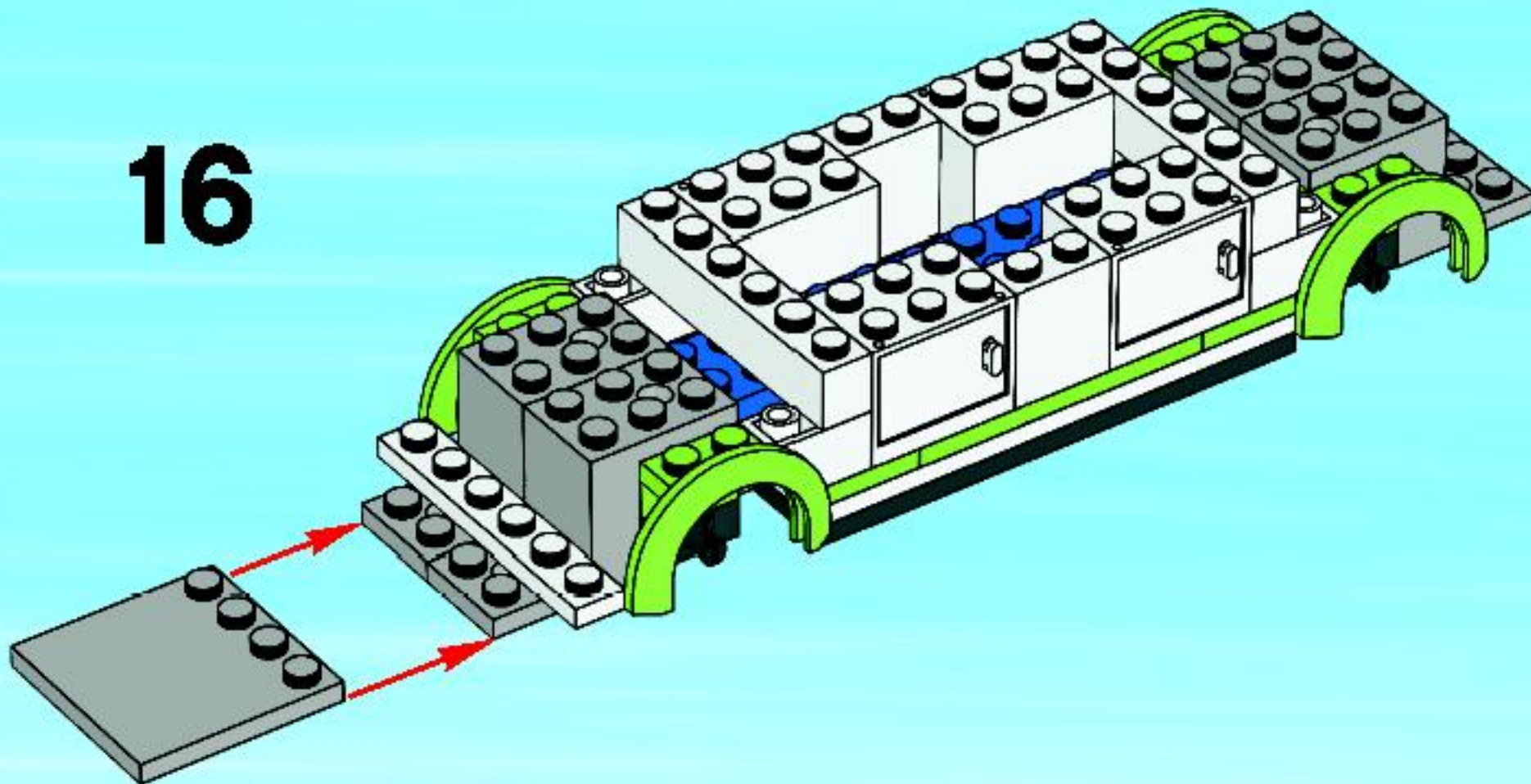

17

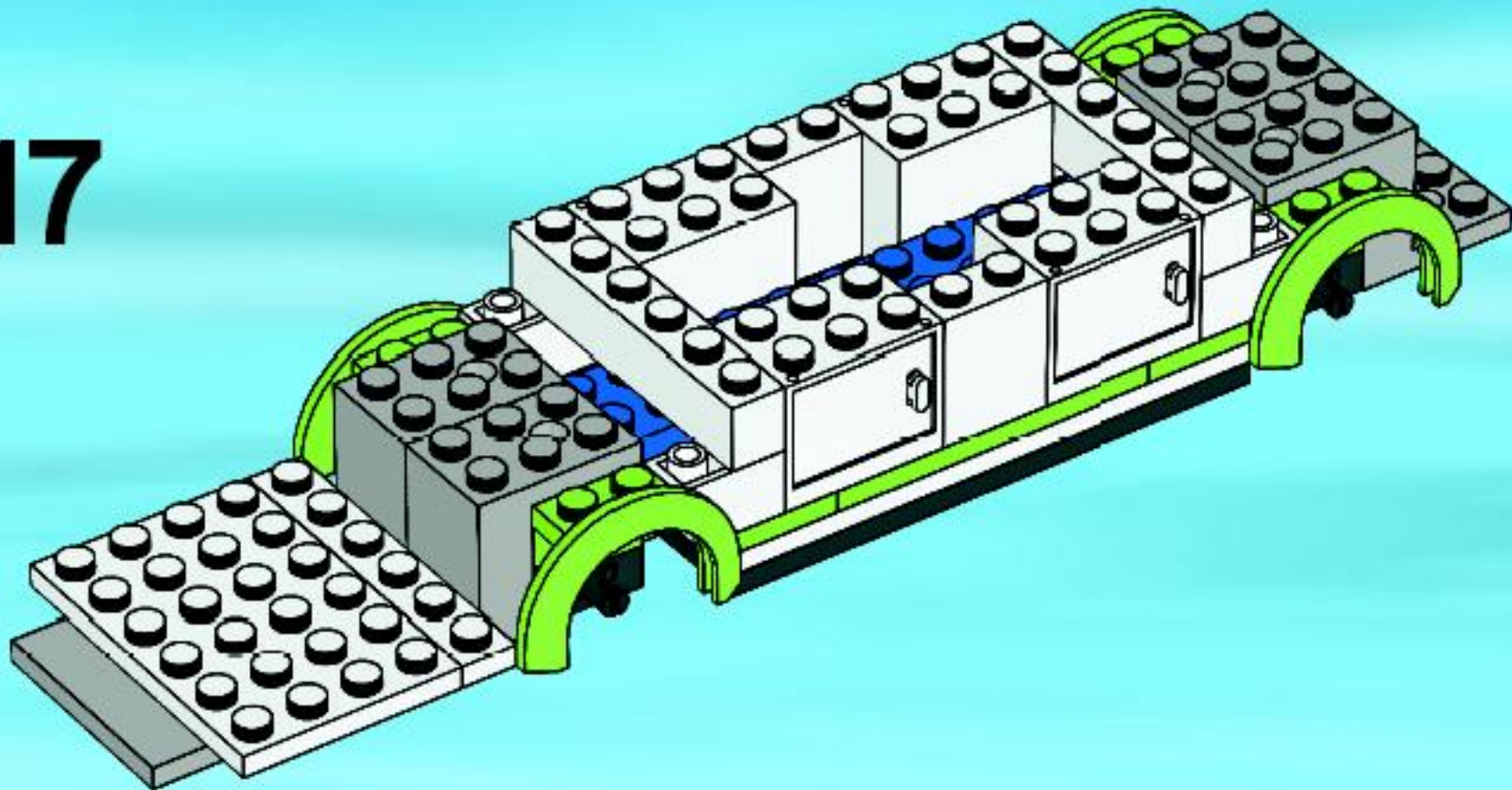

18

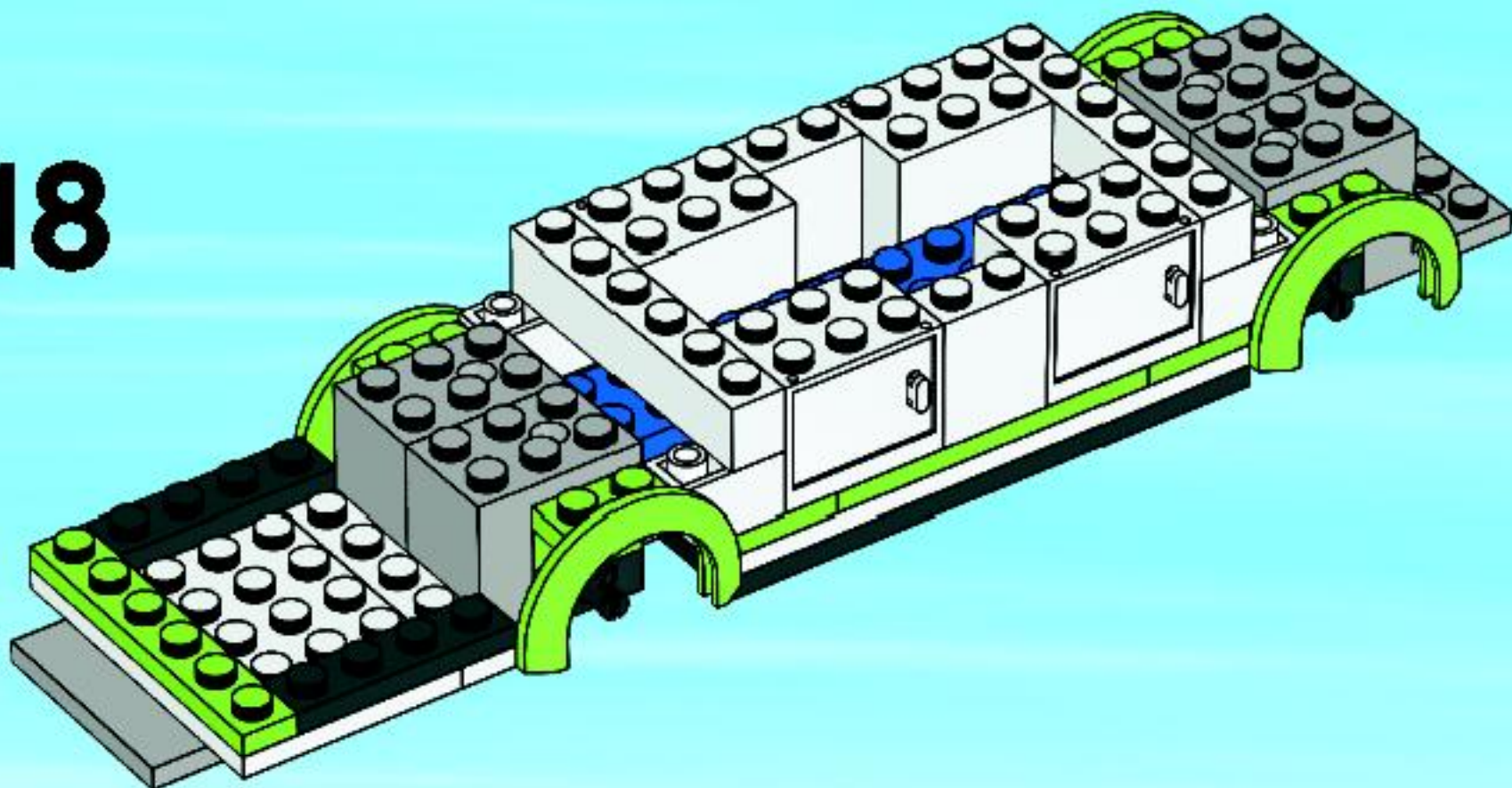

19

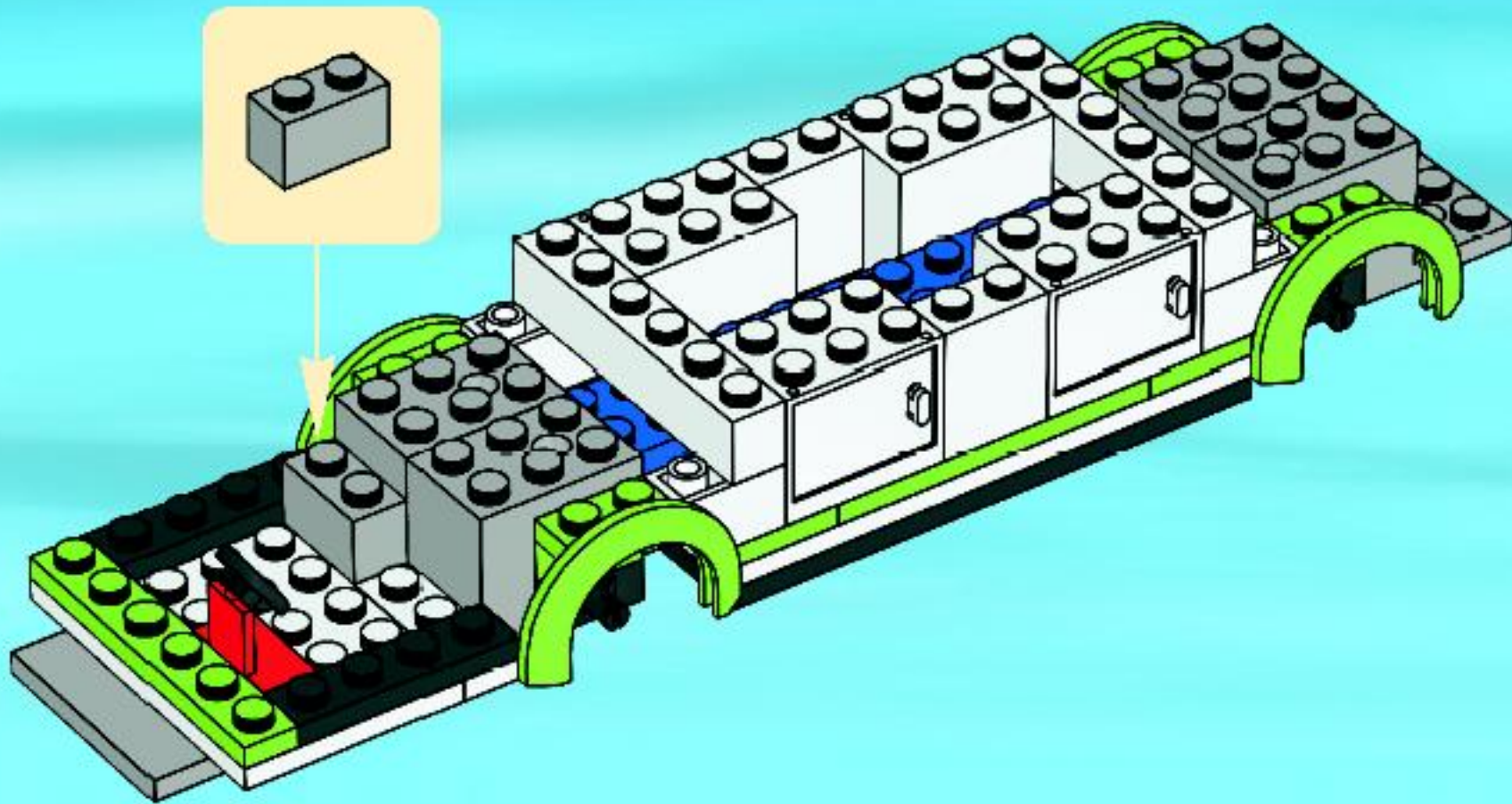

20

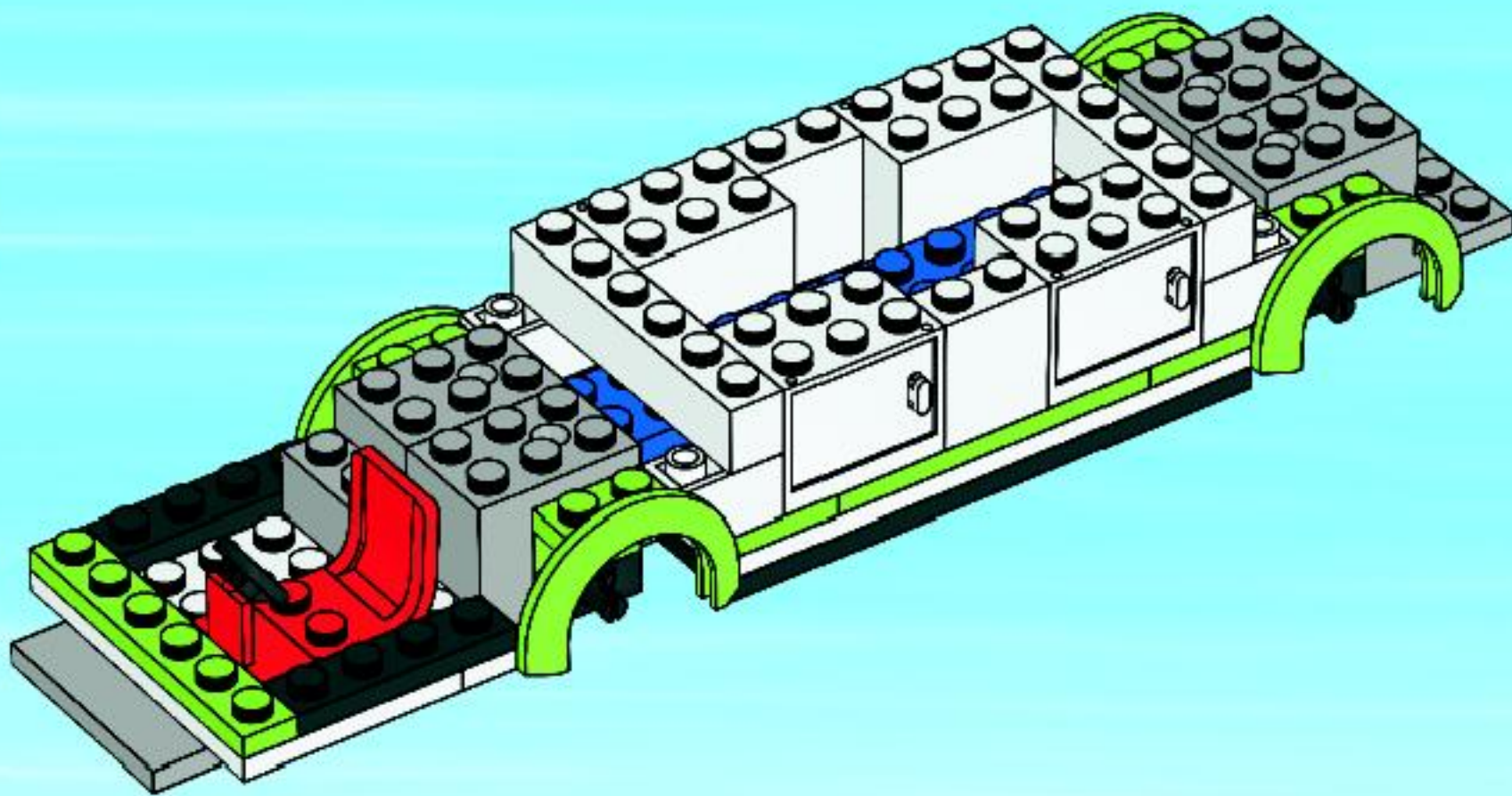

21

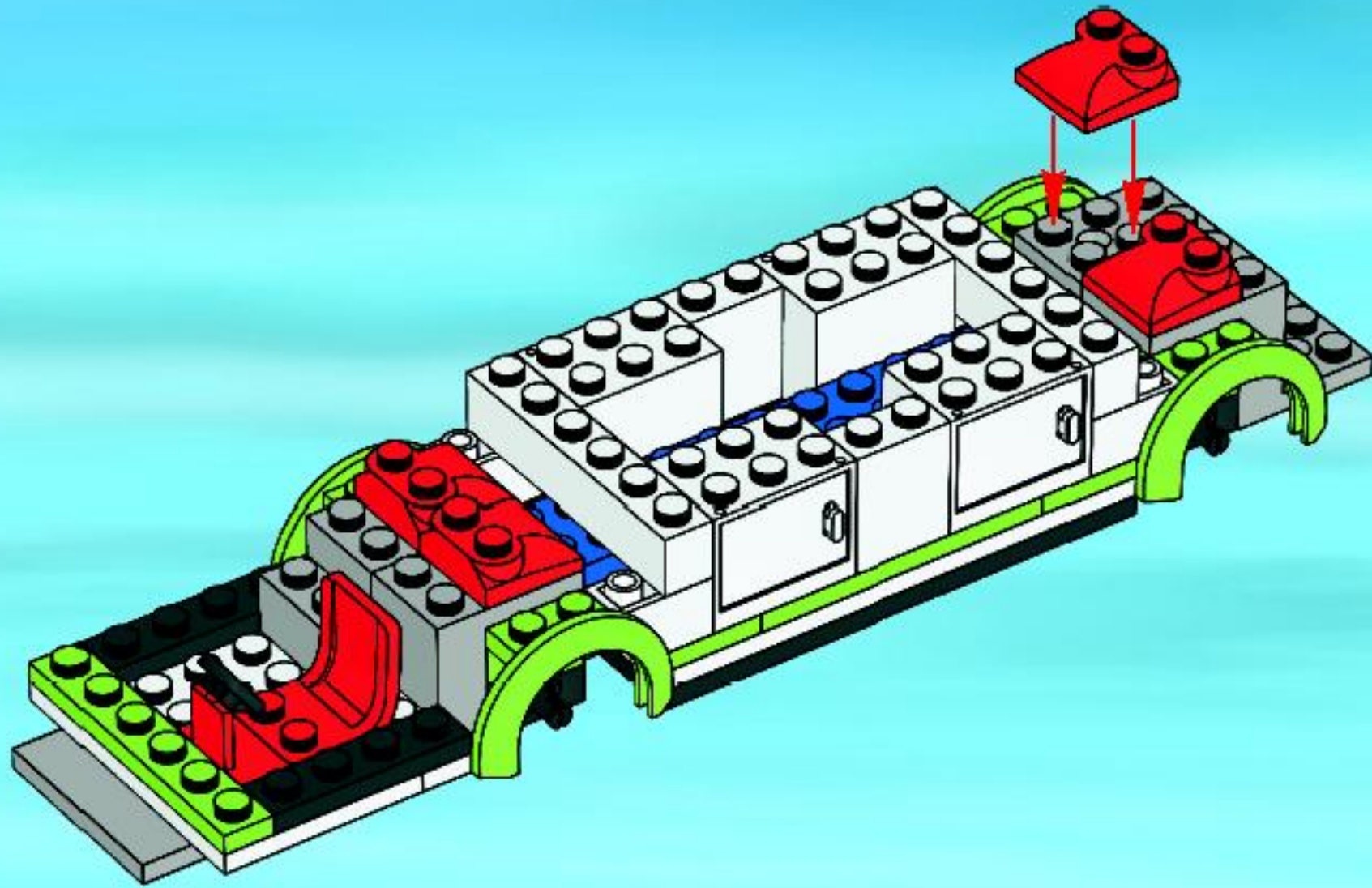

22

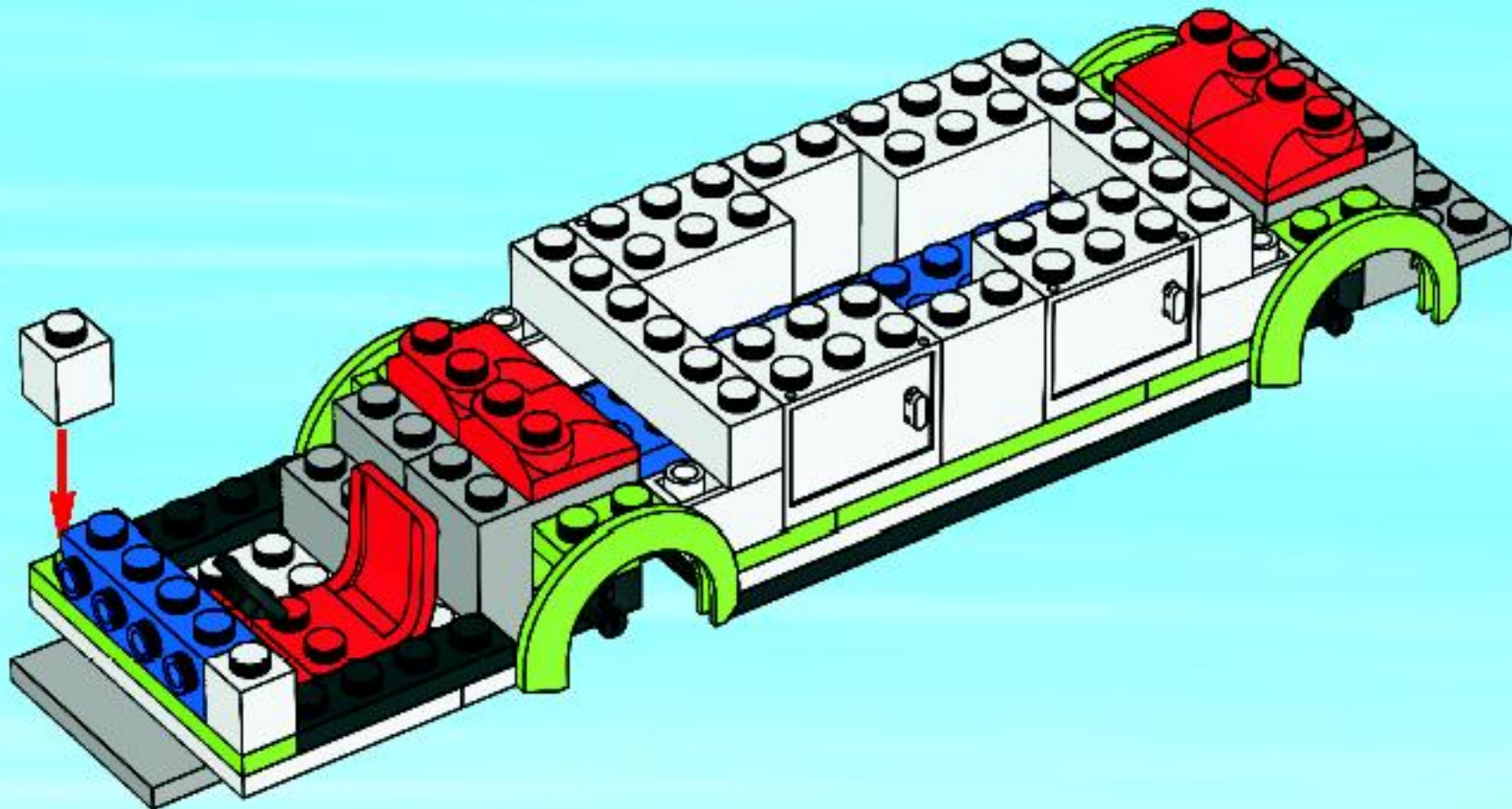

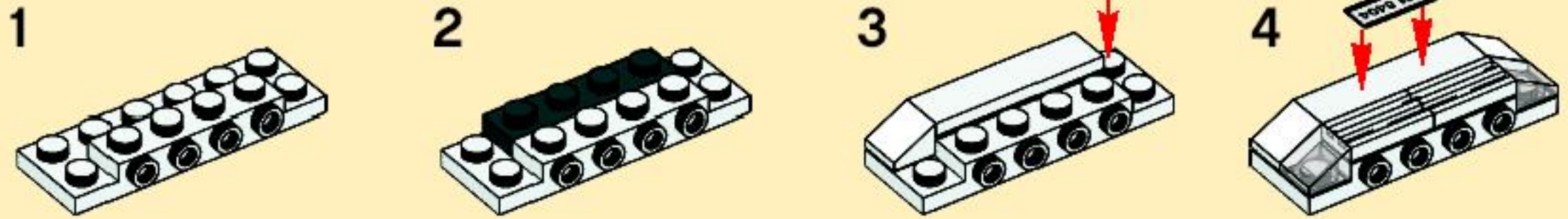

23

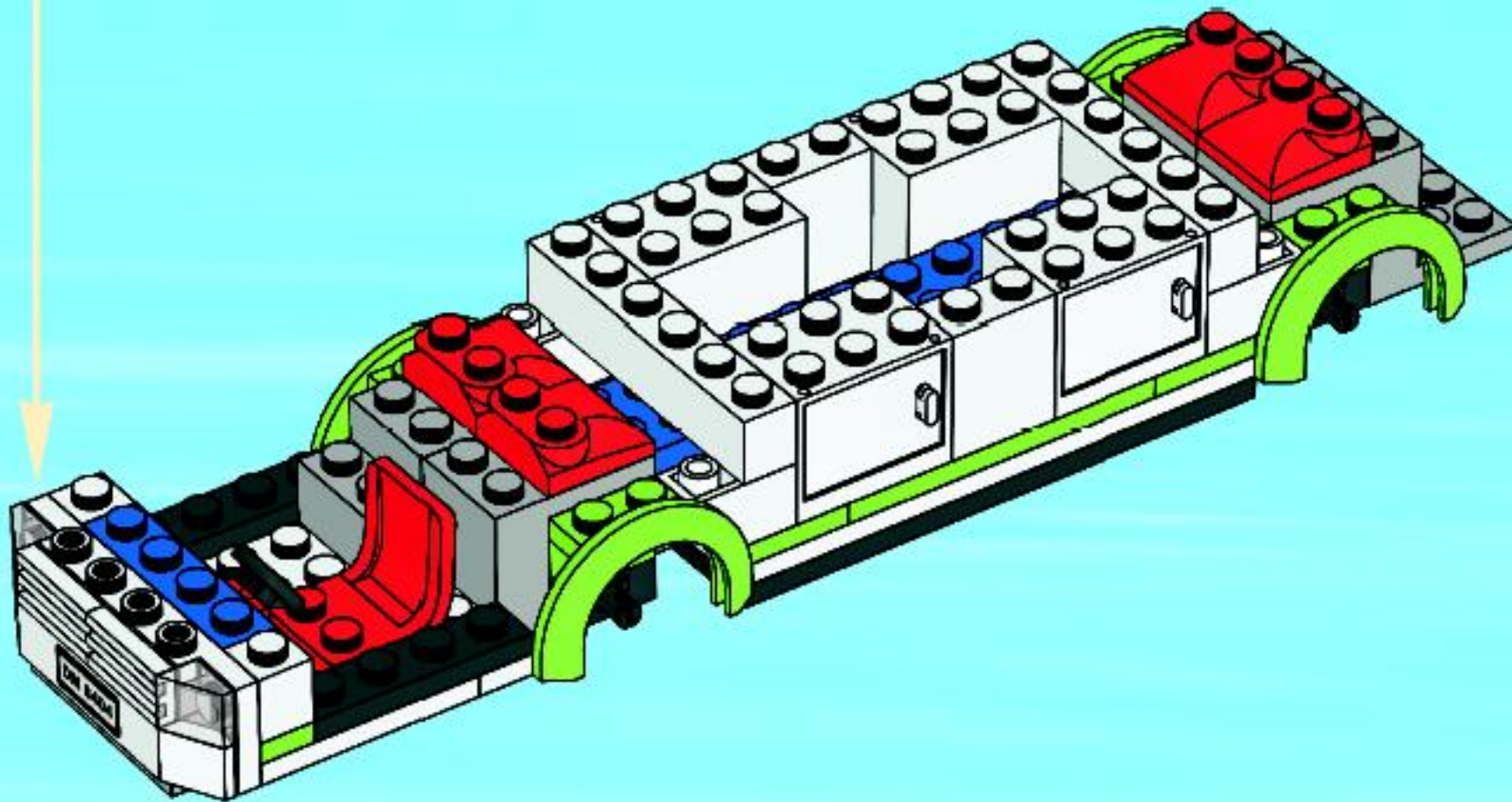

24

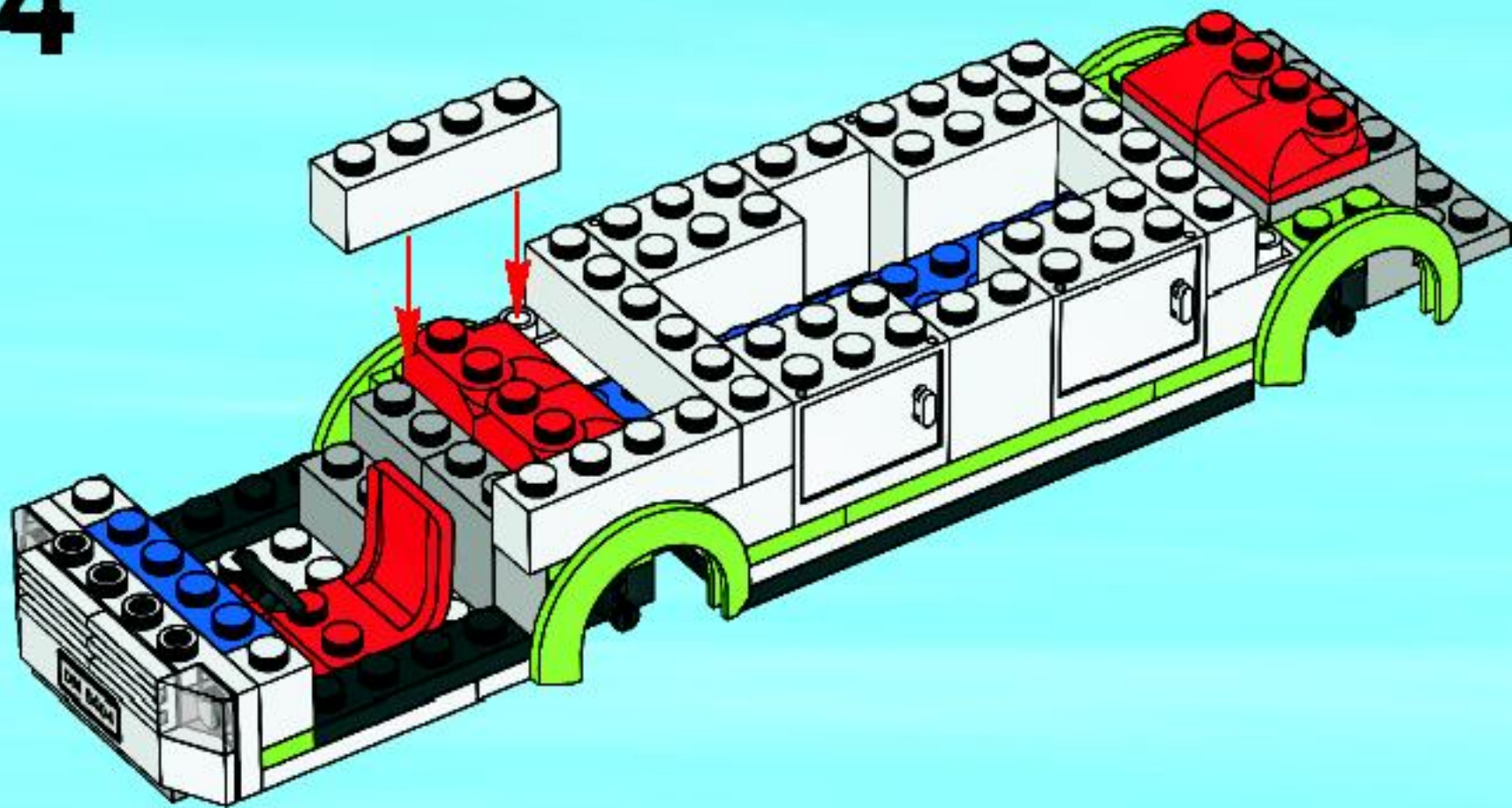

25

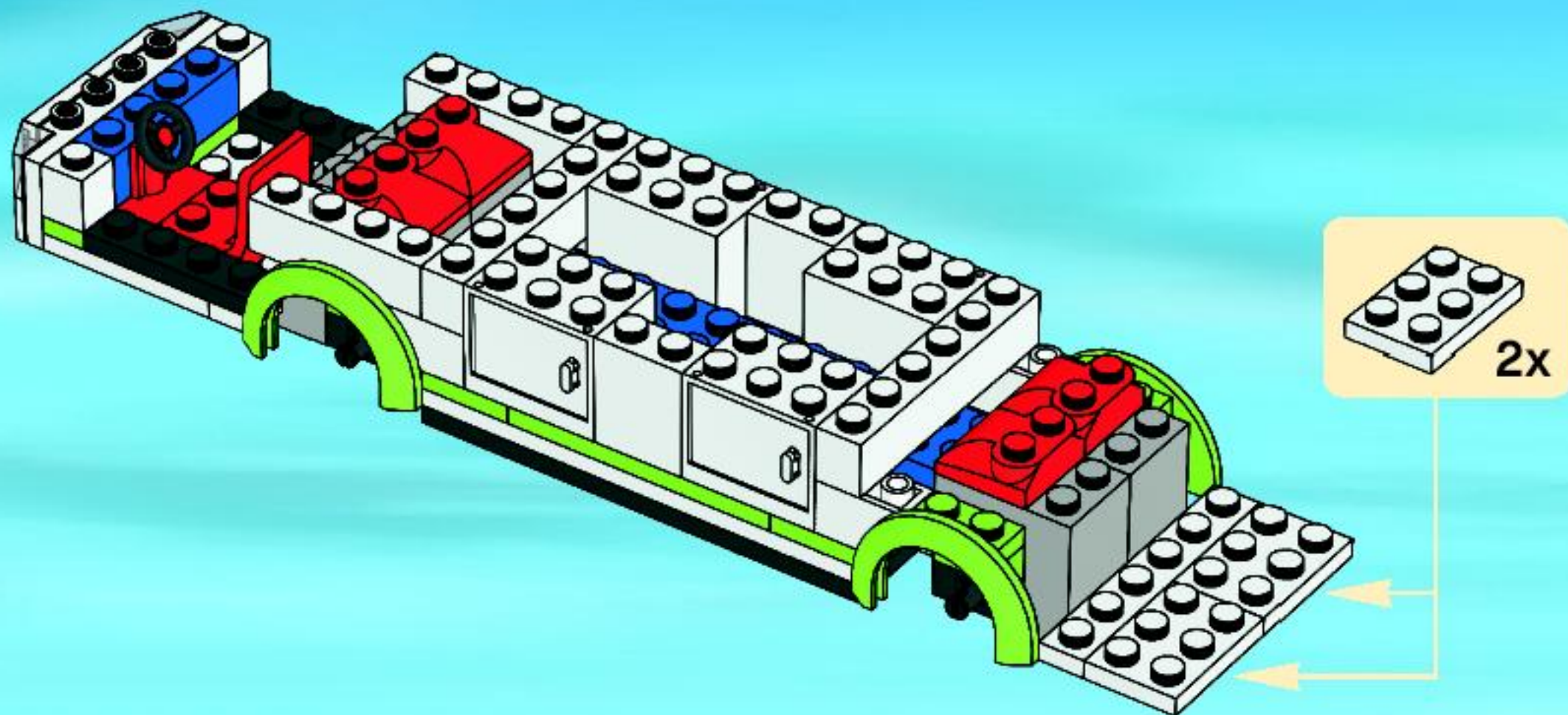

26

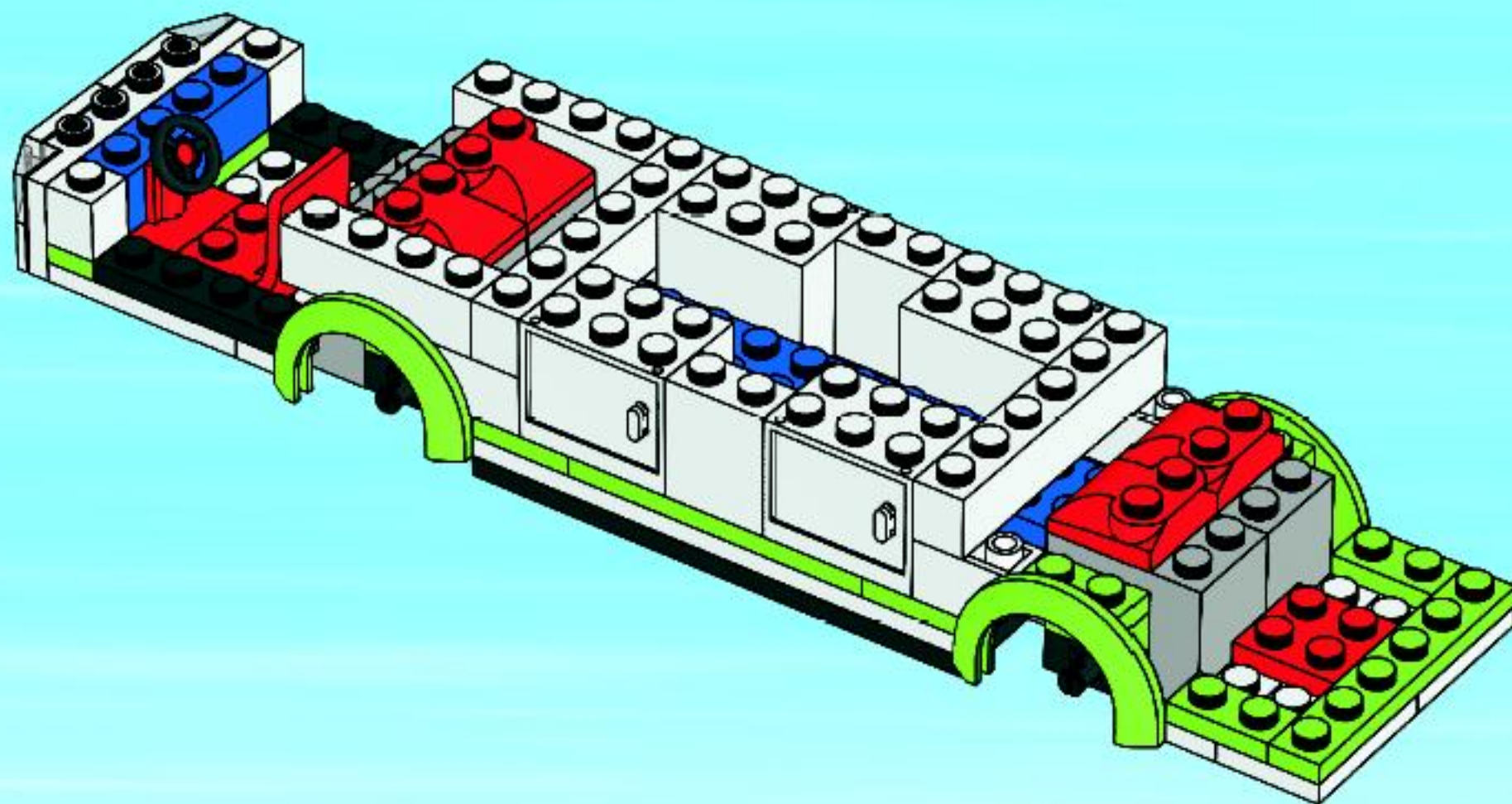

27

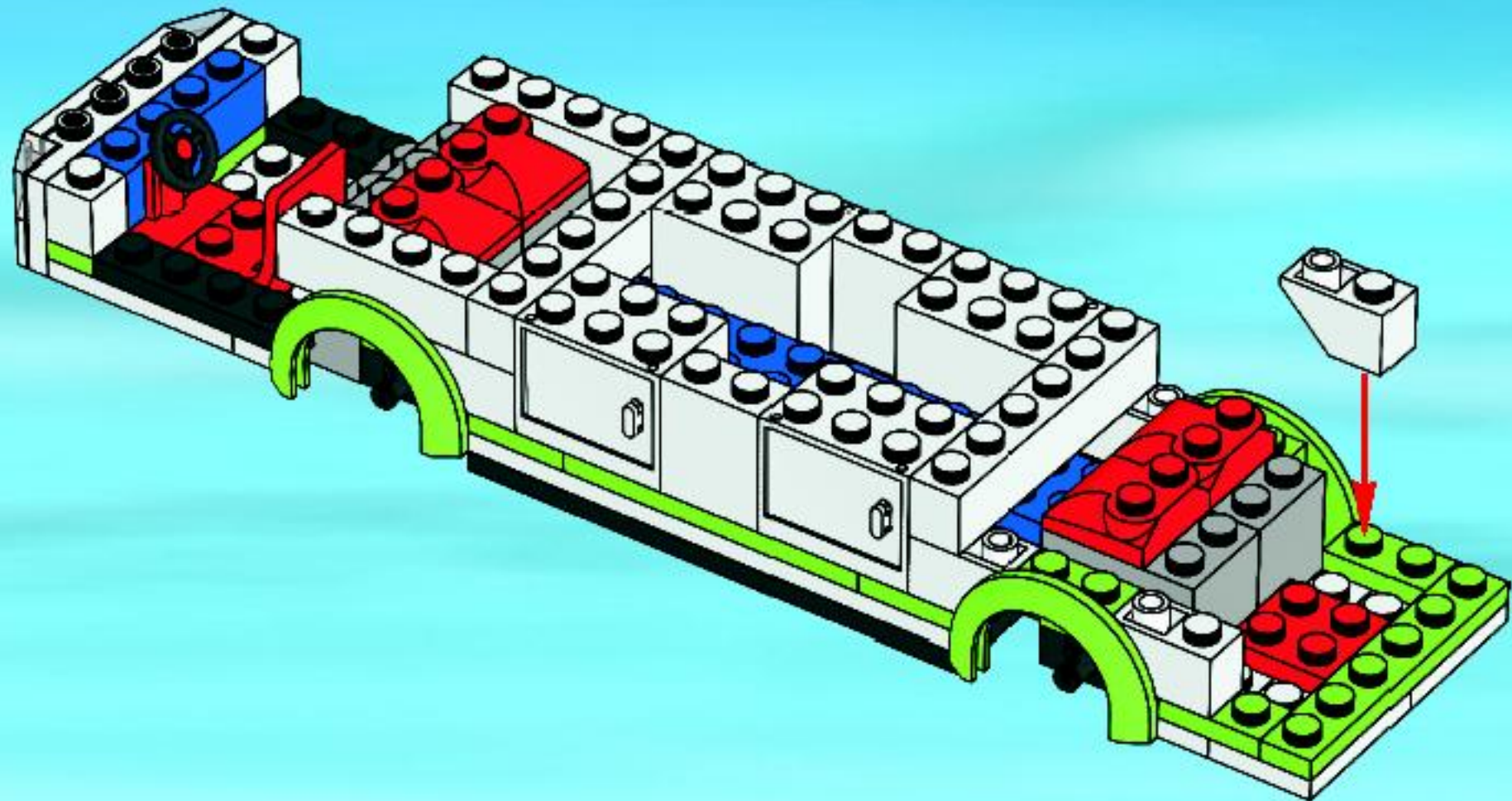

28

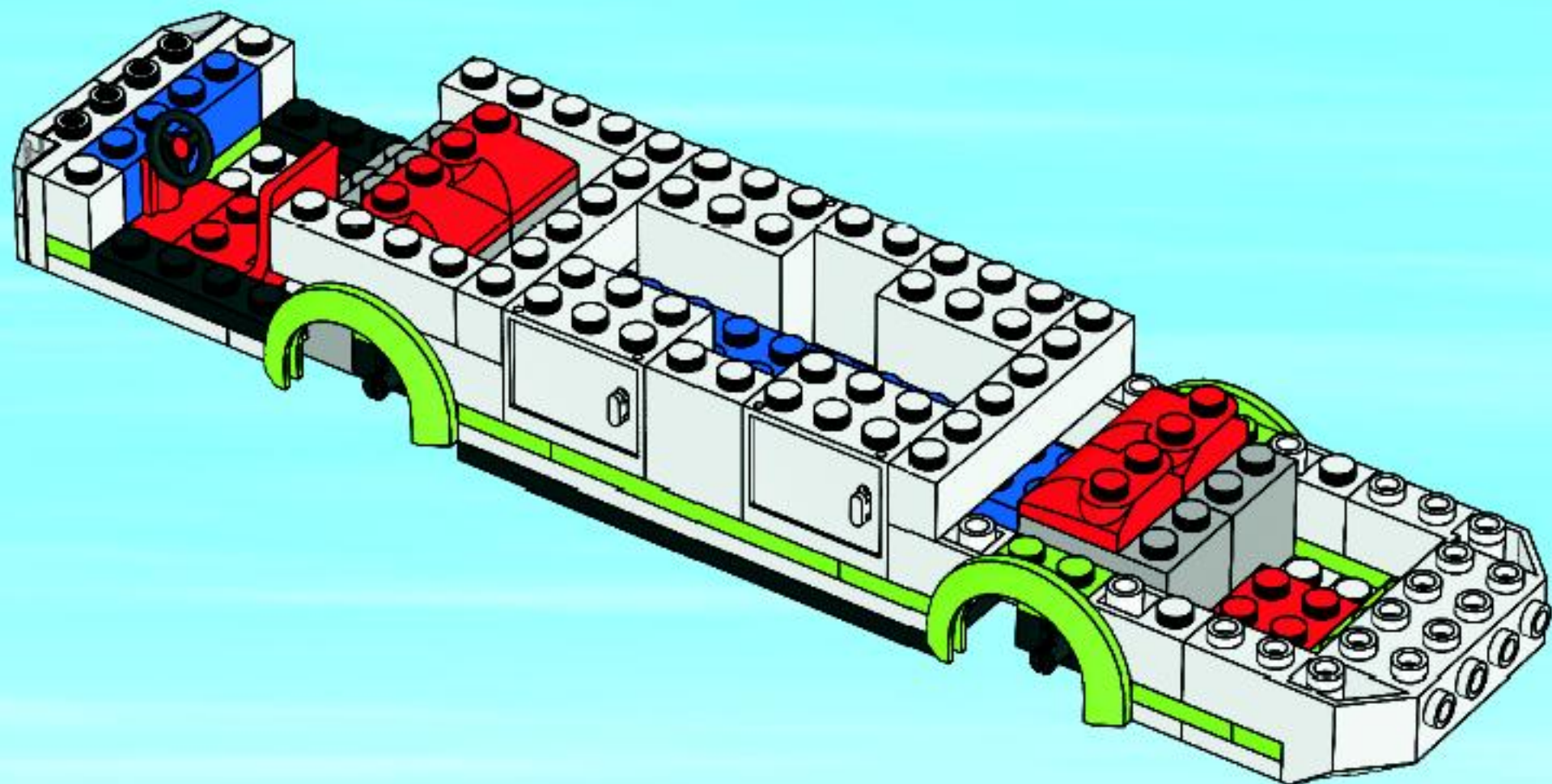

29

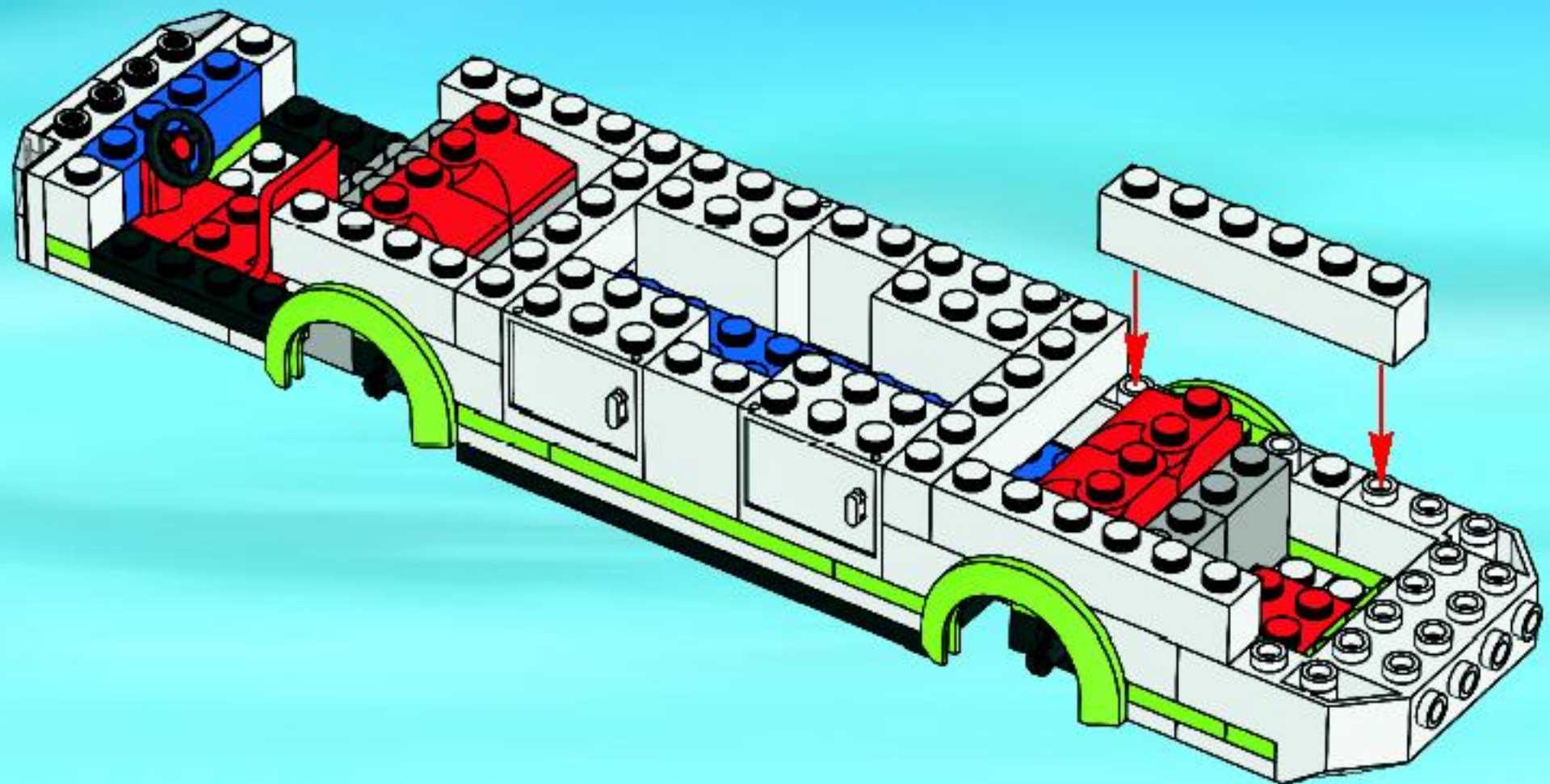

30

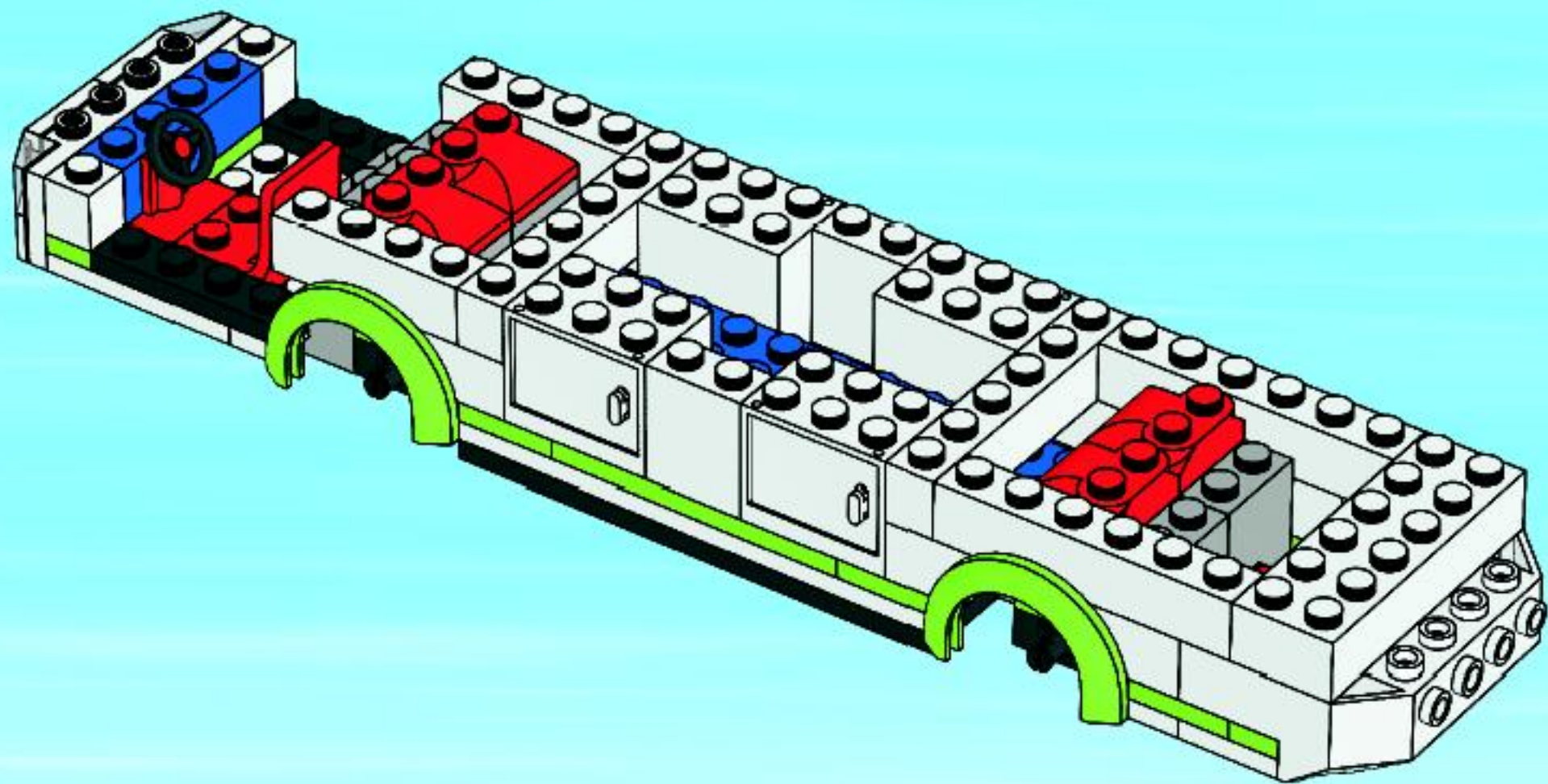

31

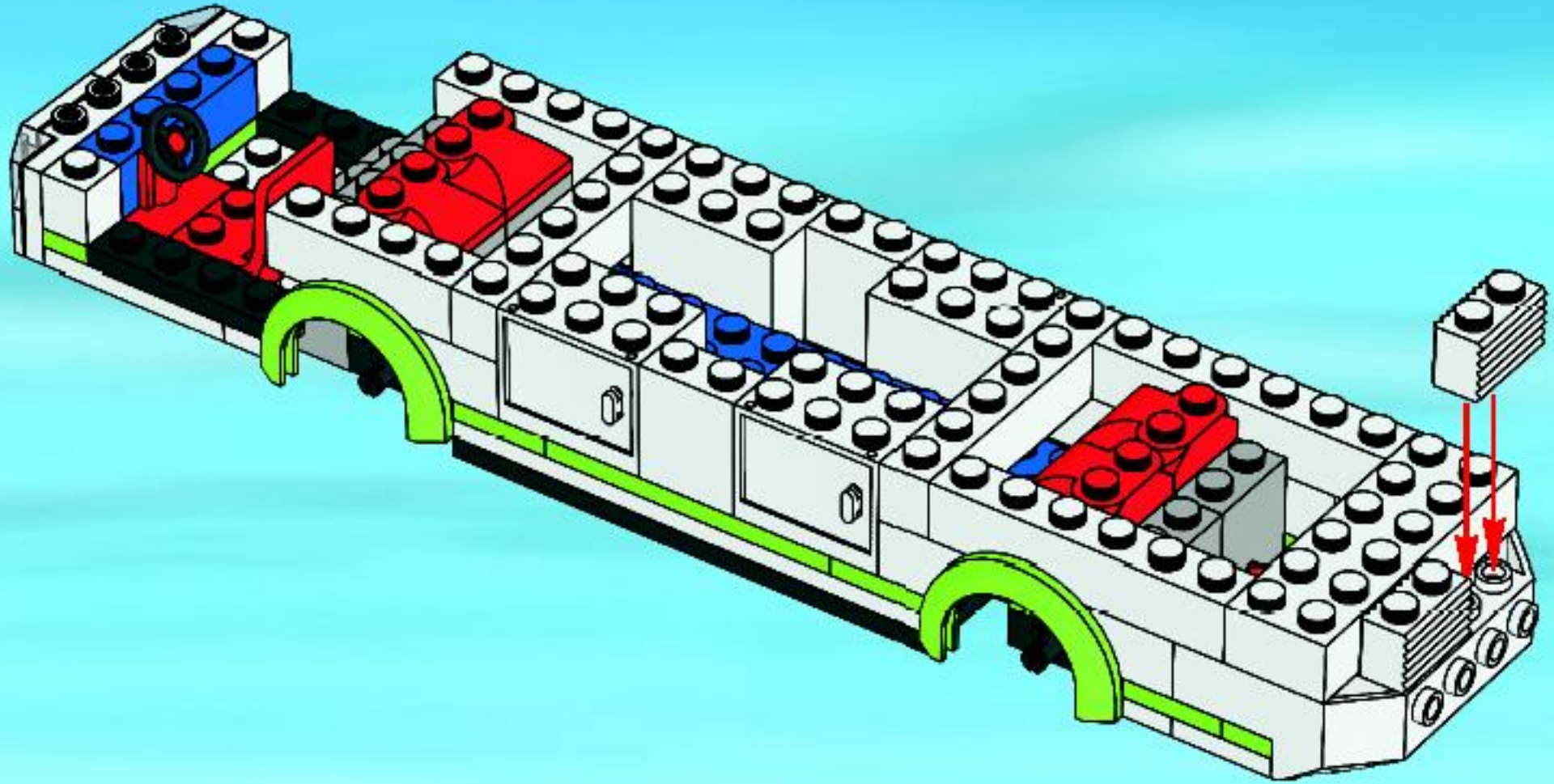

32

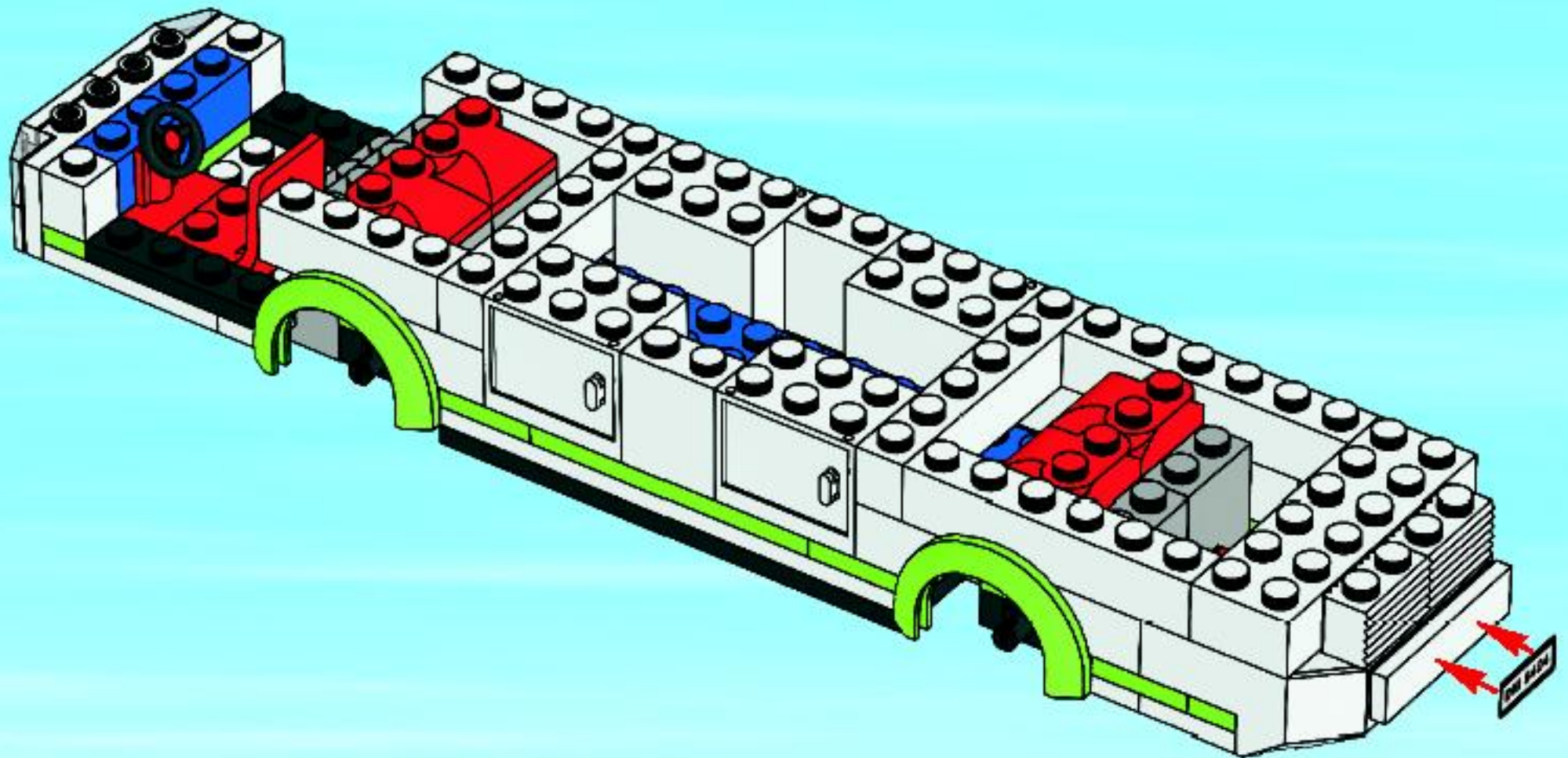

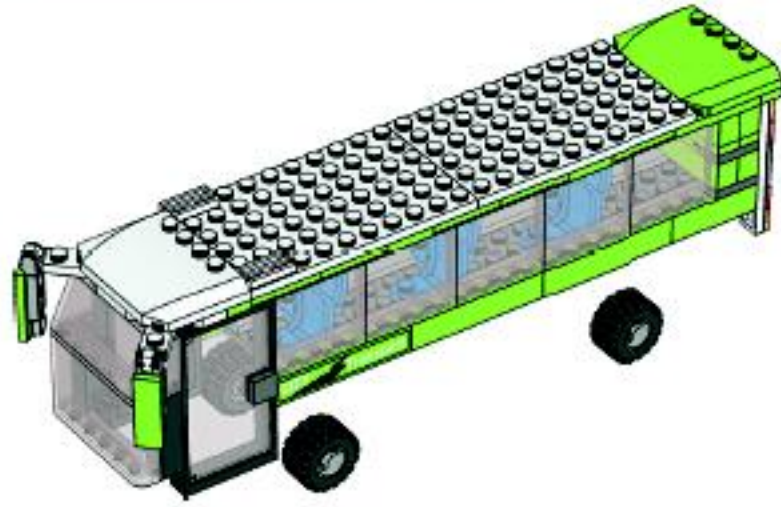

33

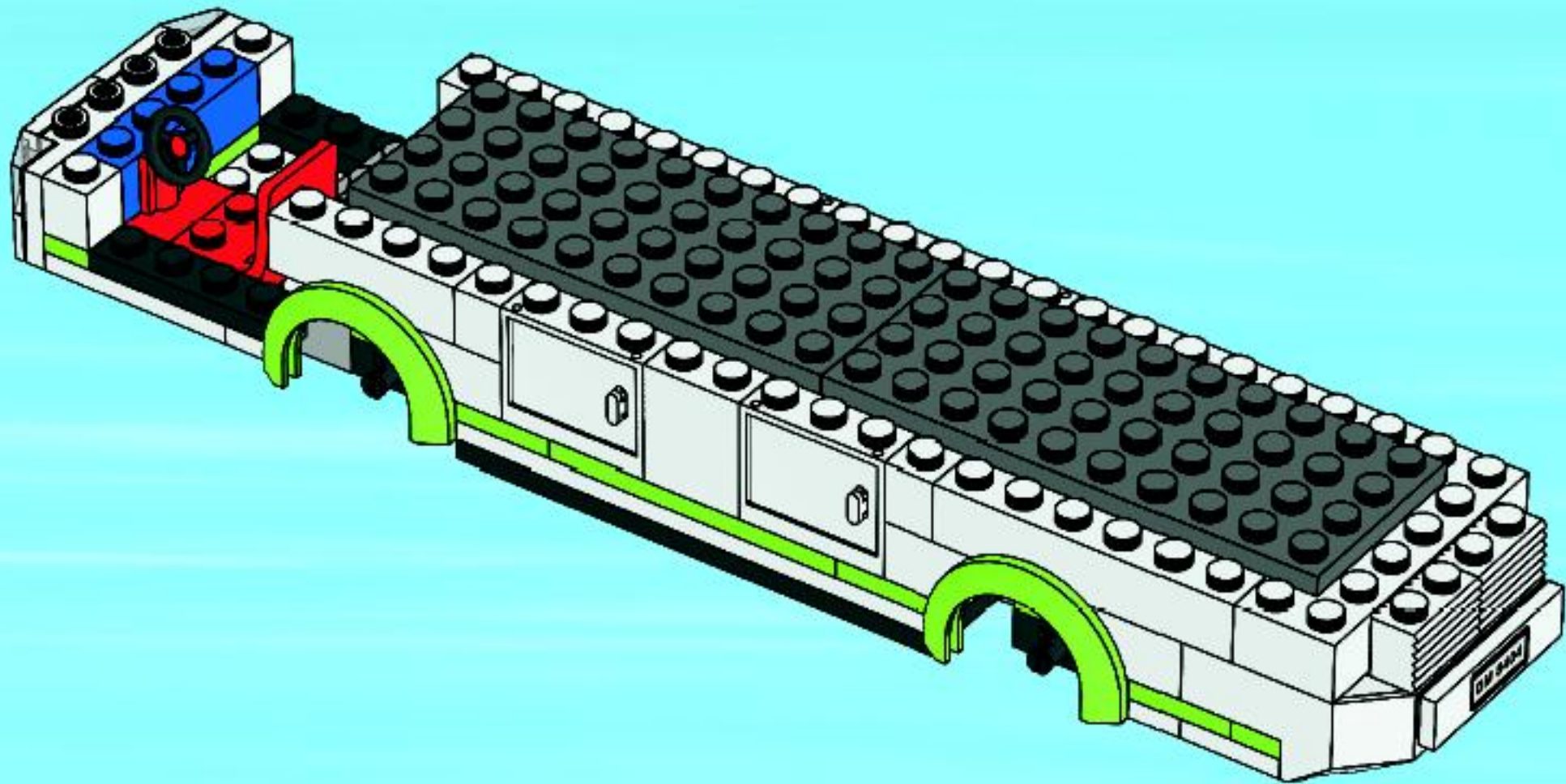

34

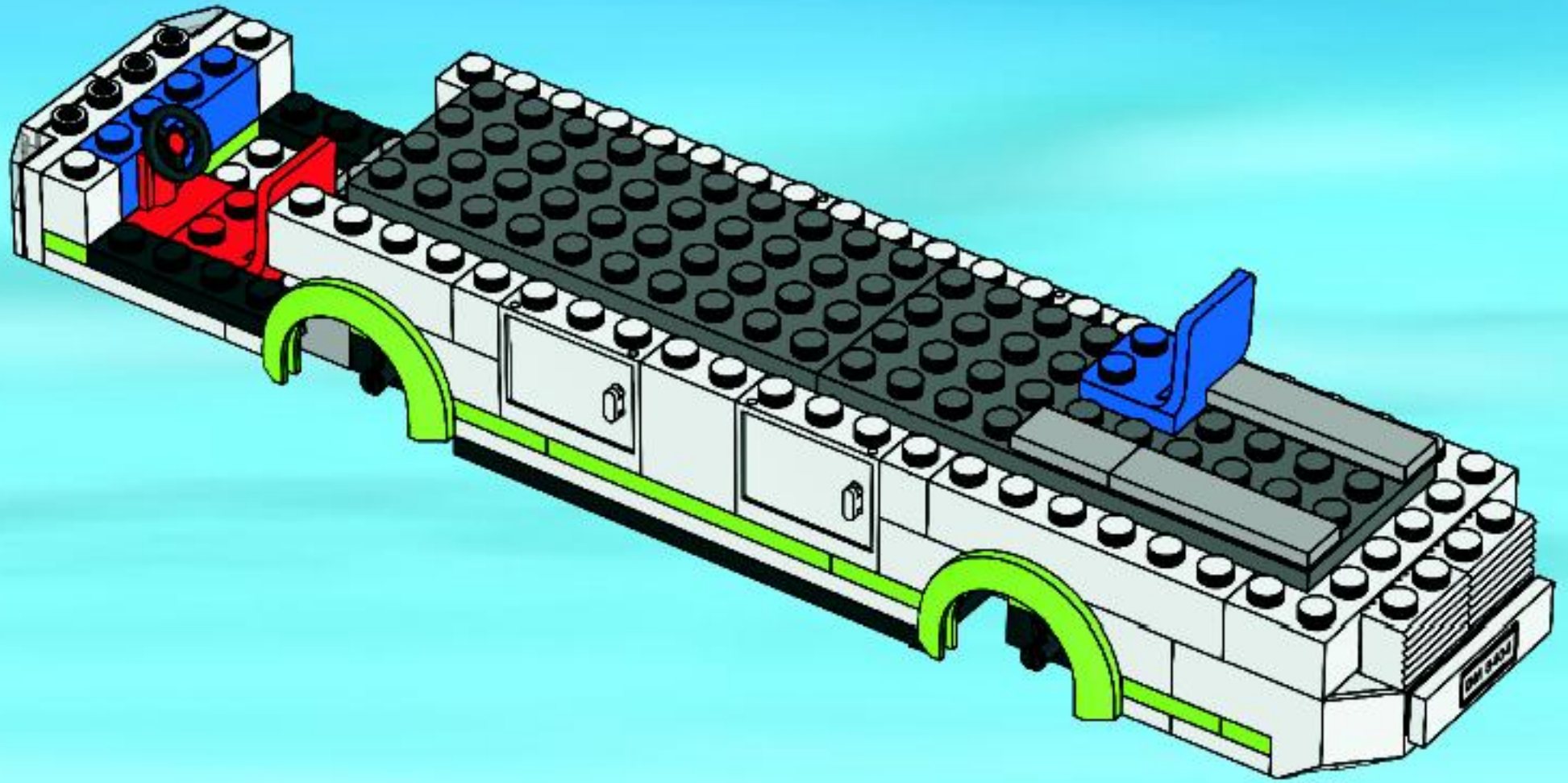

35

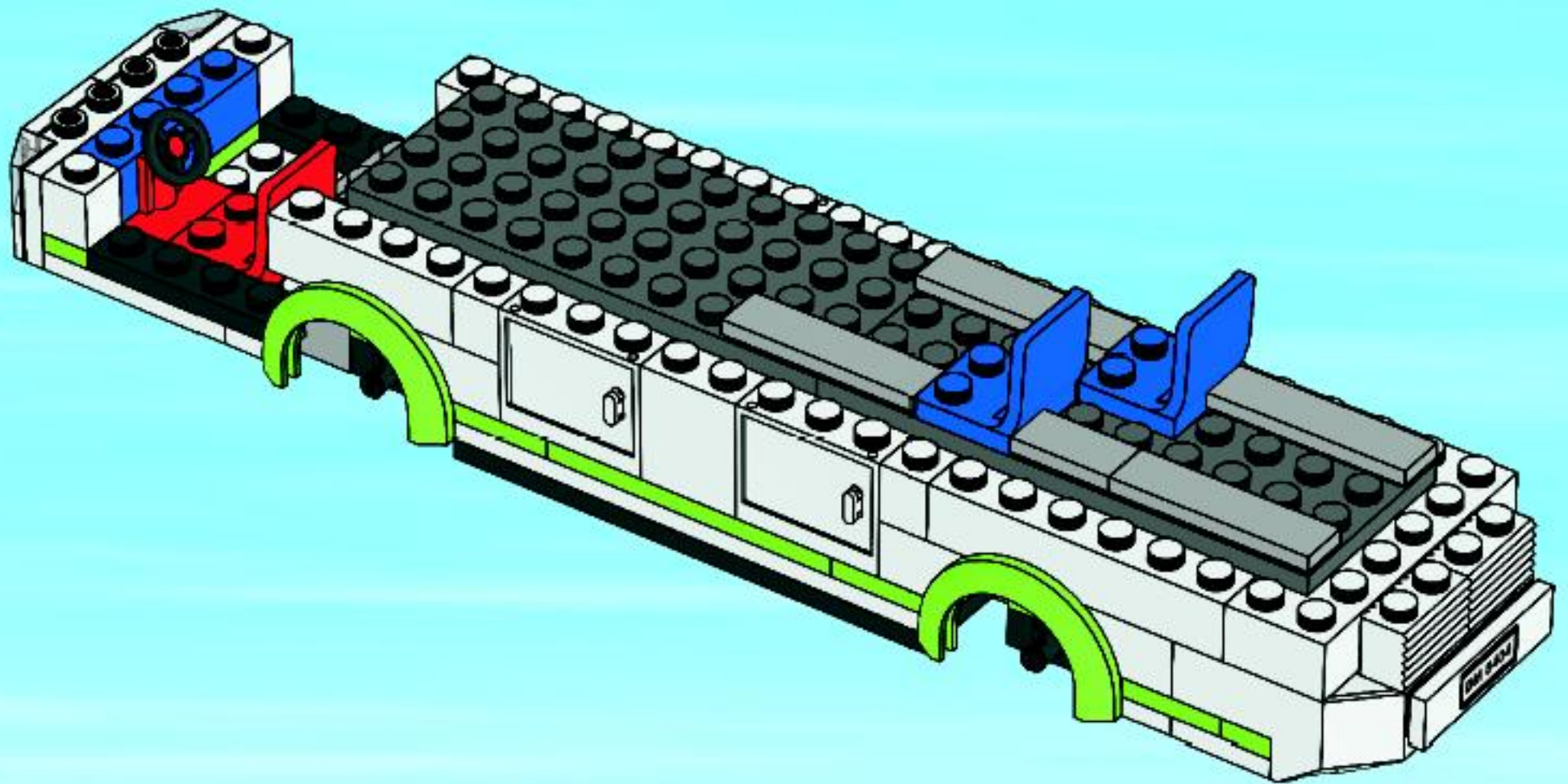

36

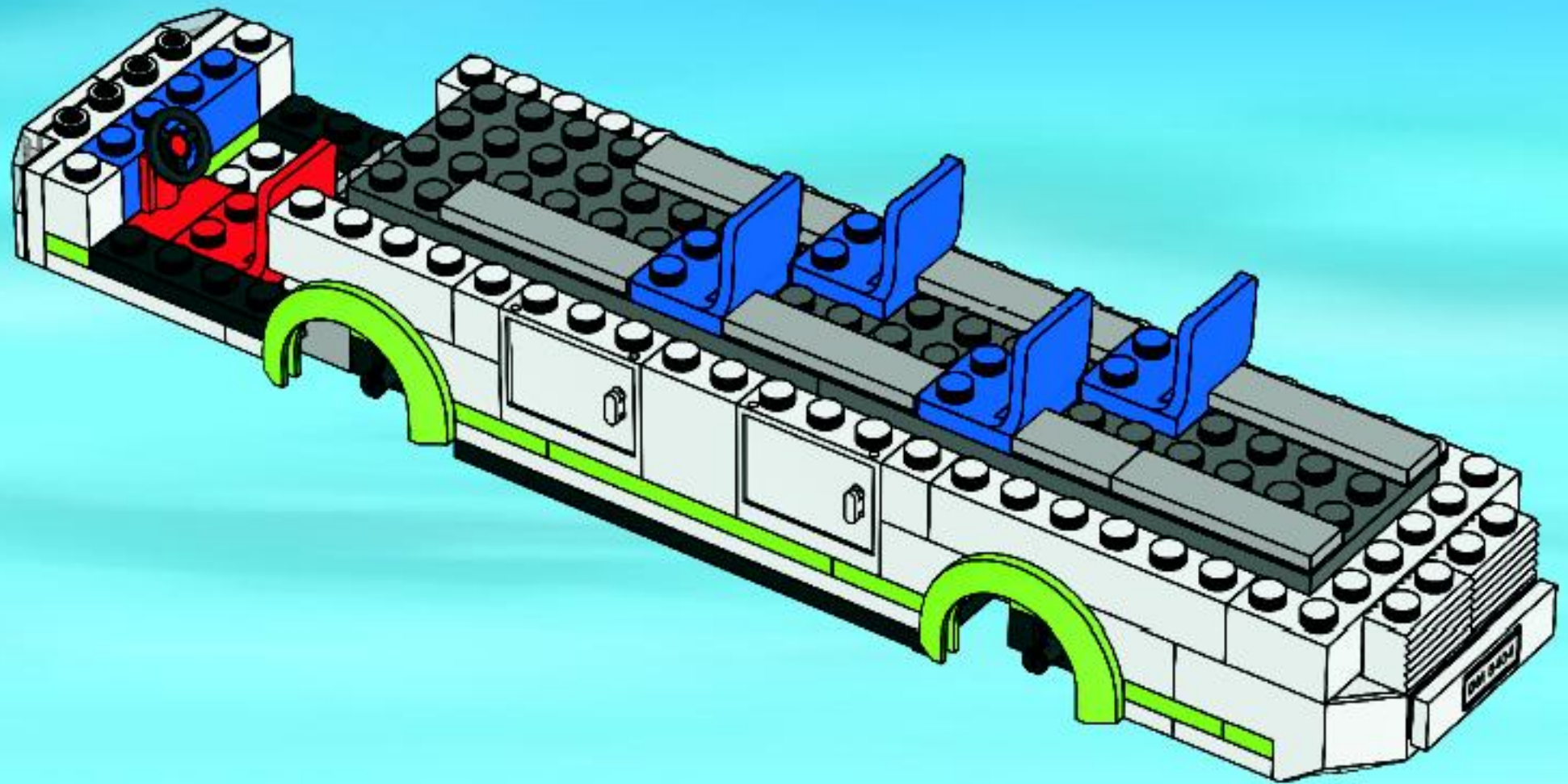

37

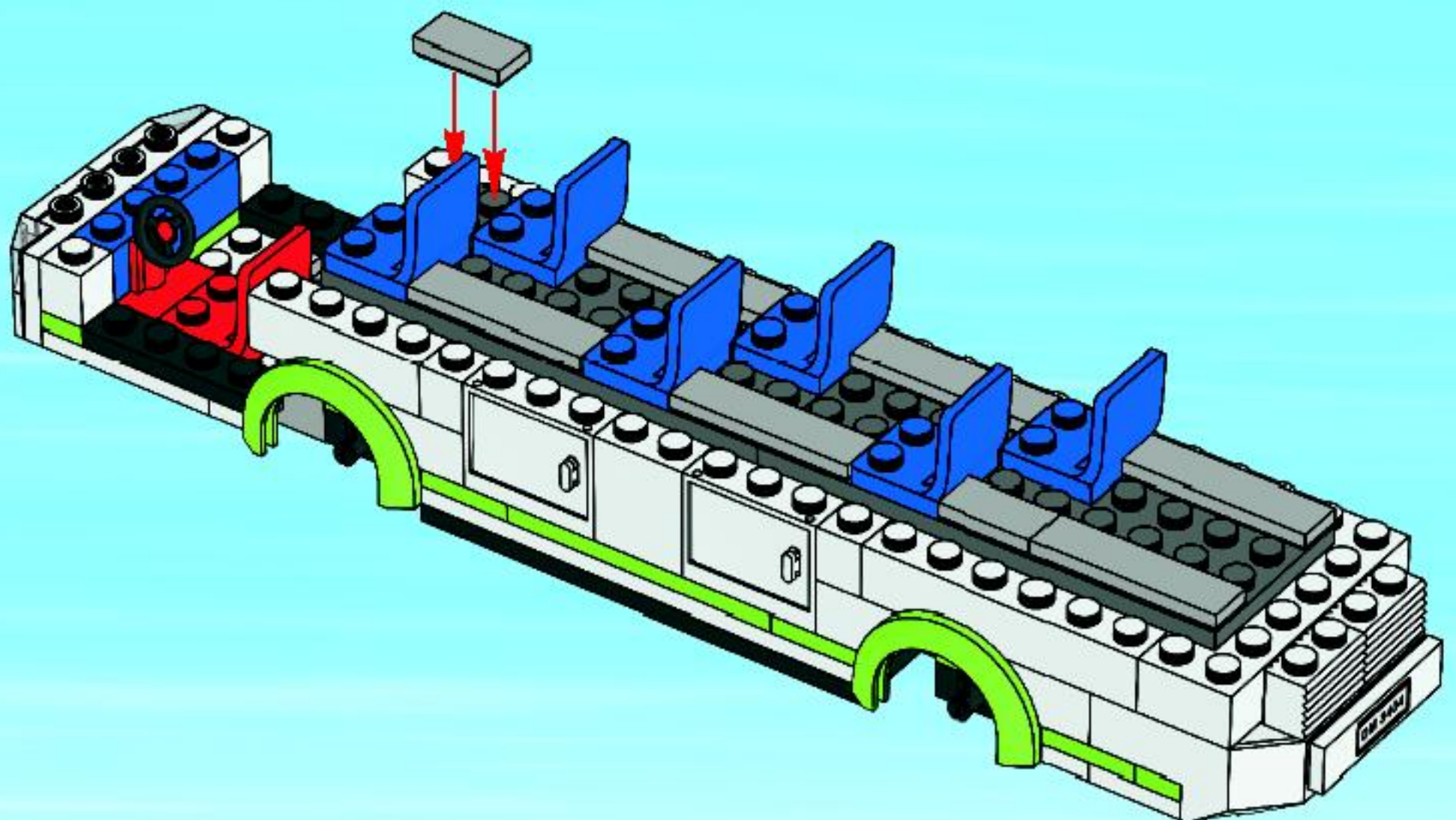

38

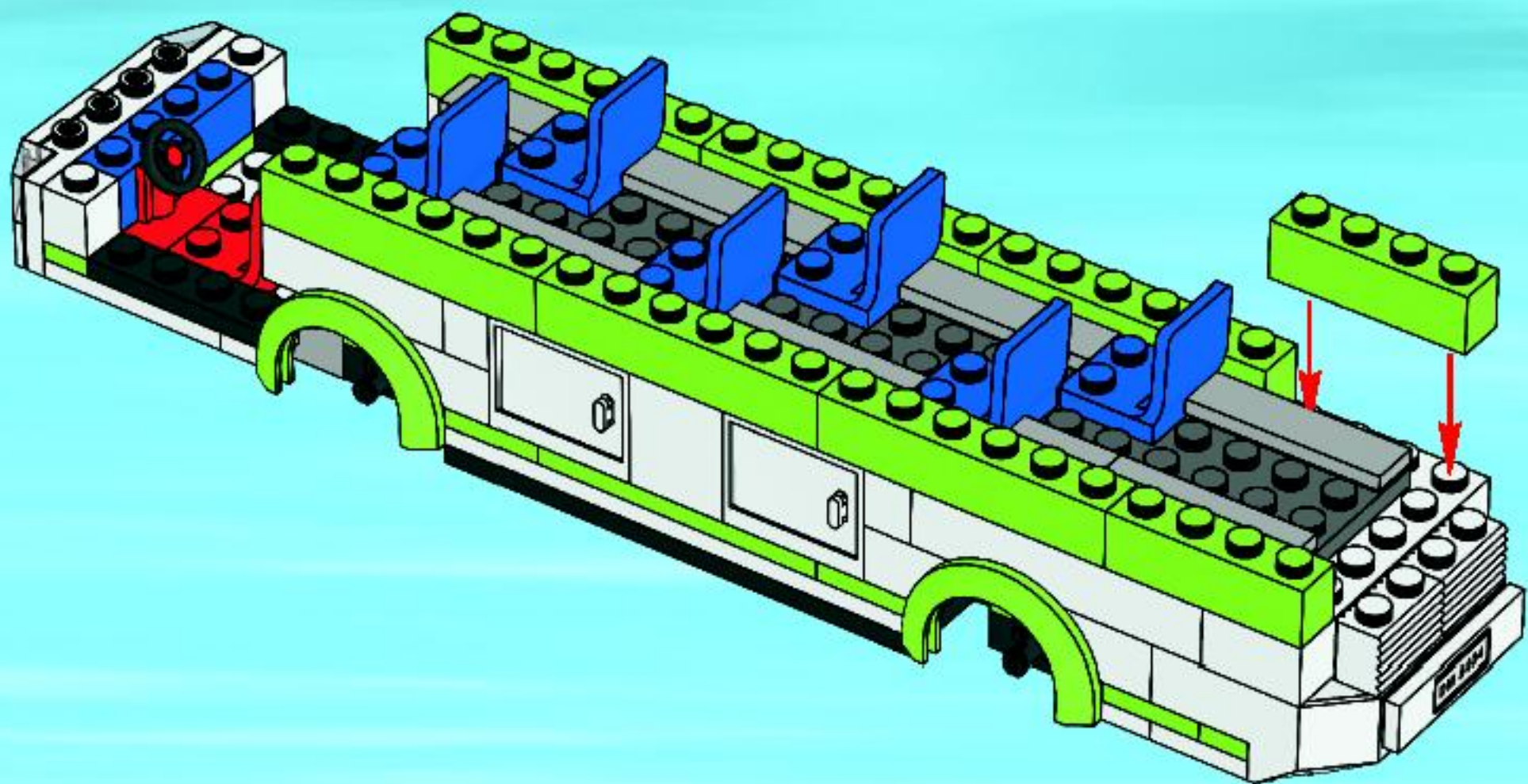

39

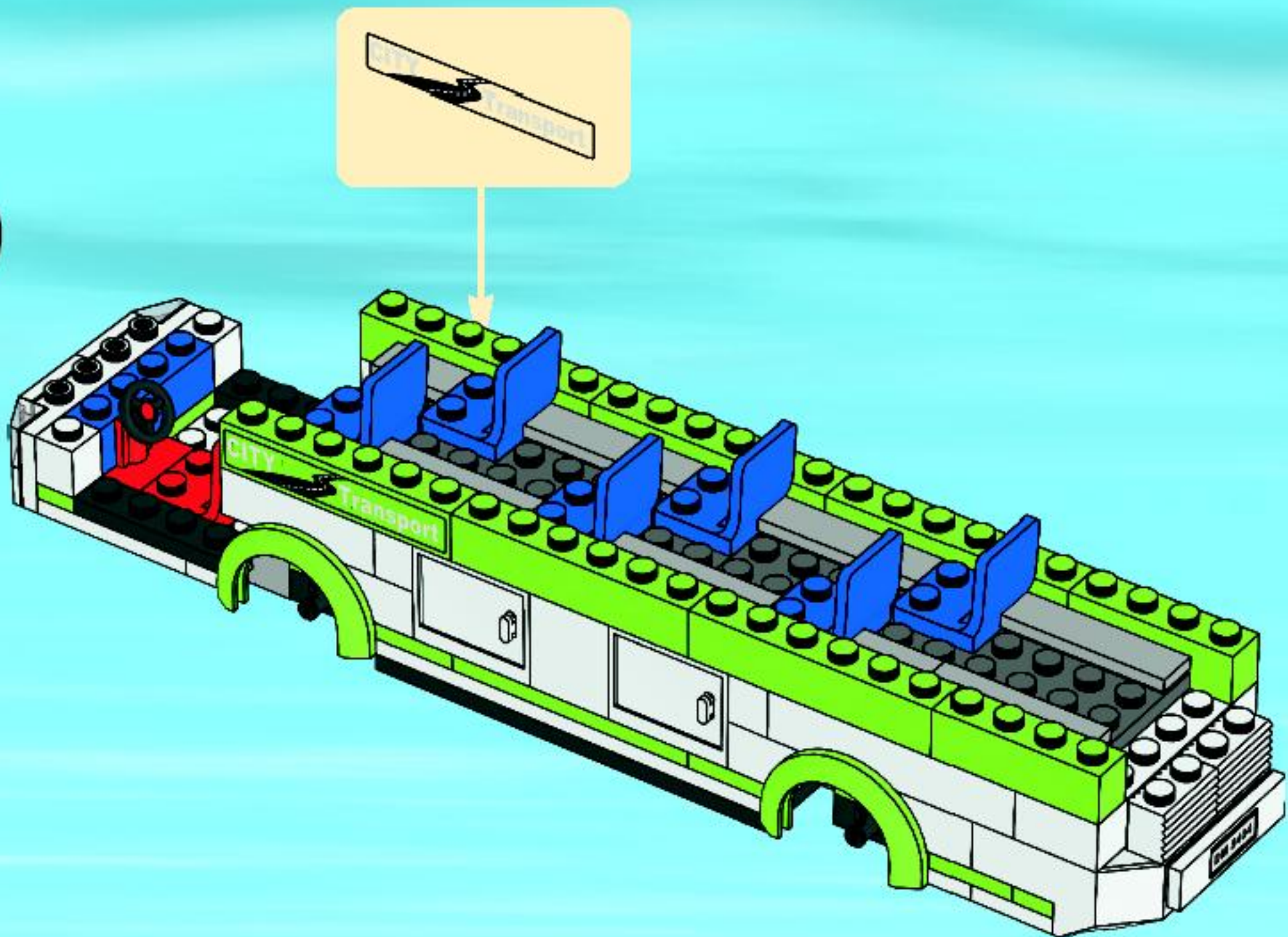

40

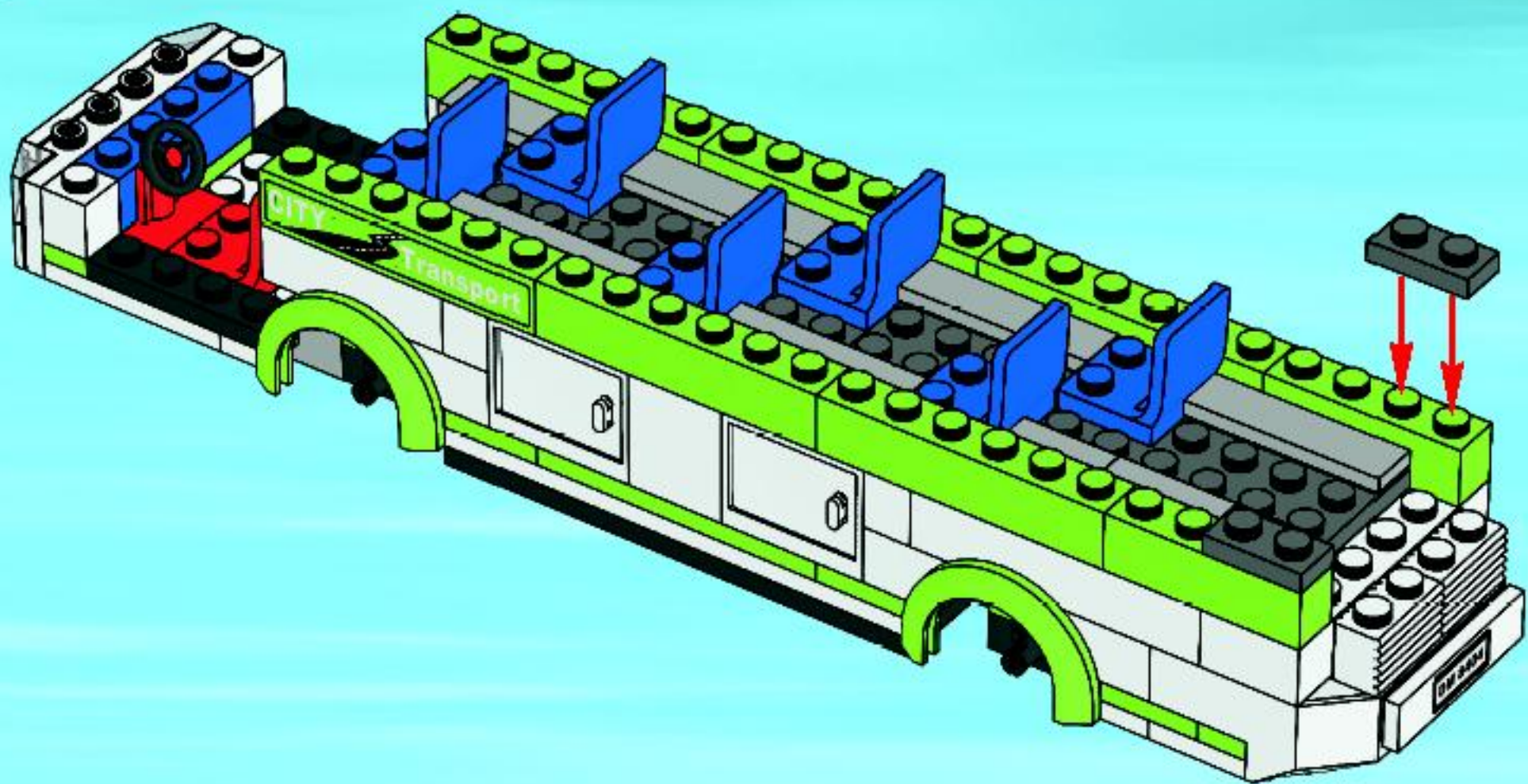

41

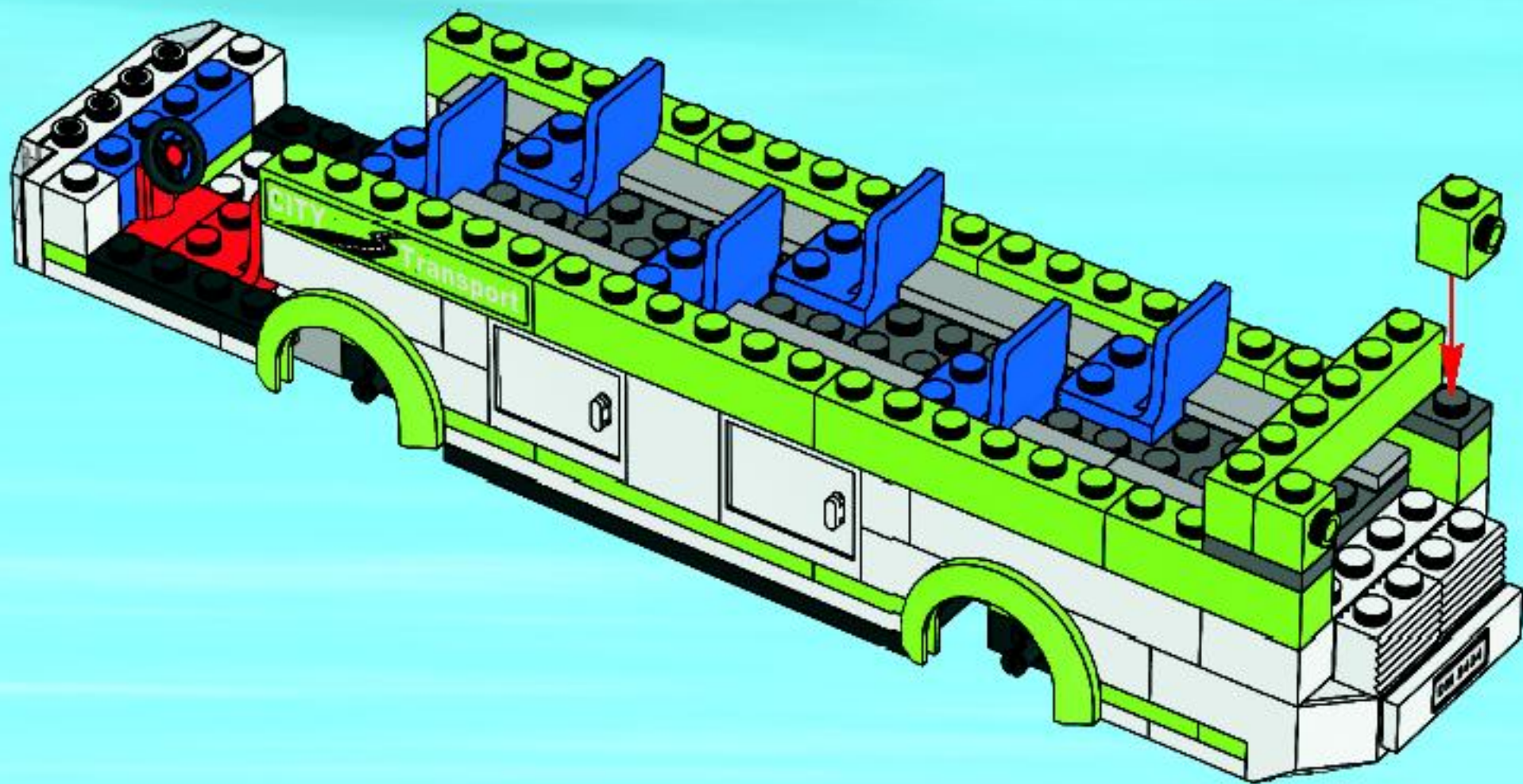

42

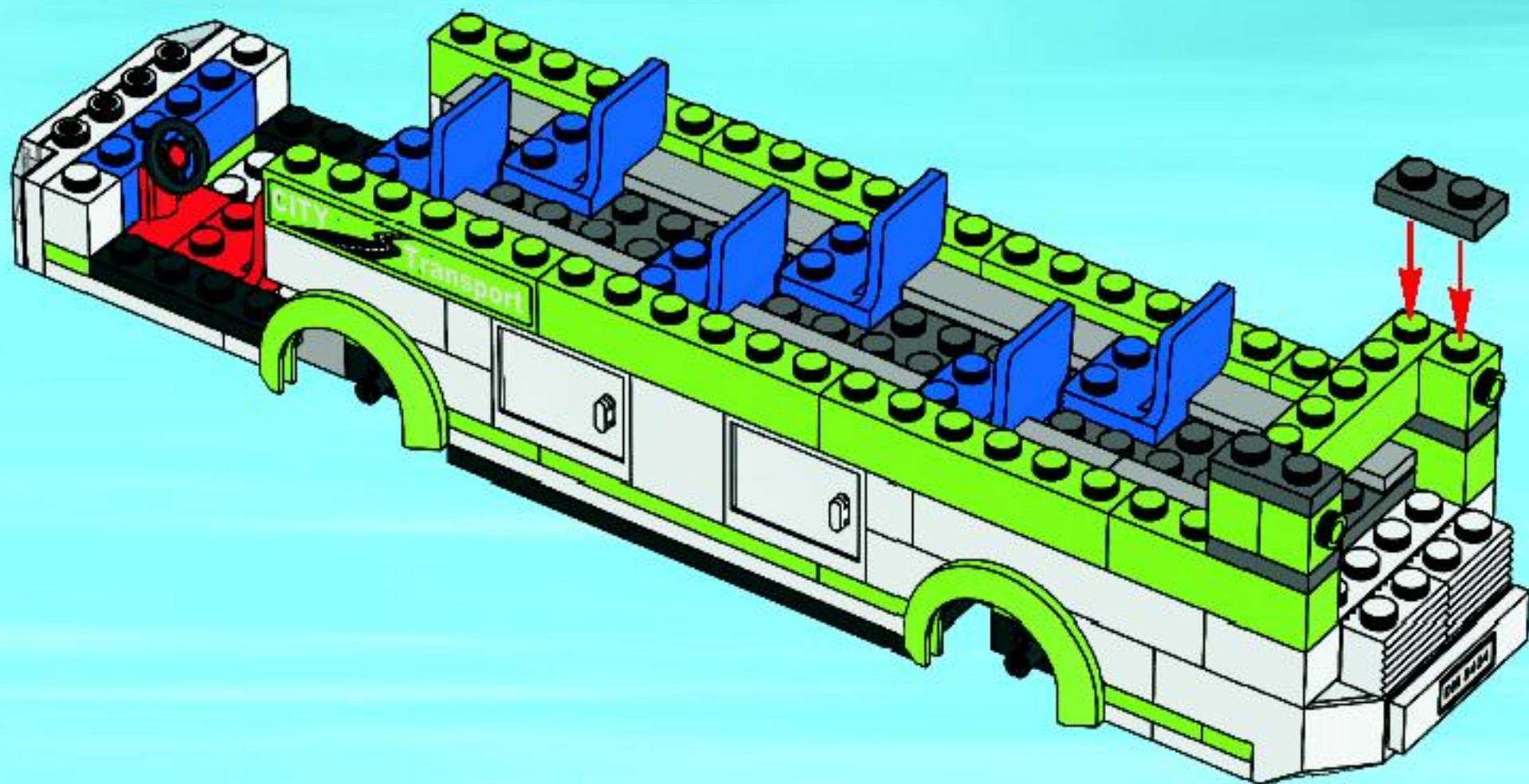

43

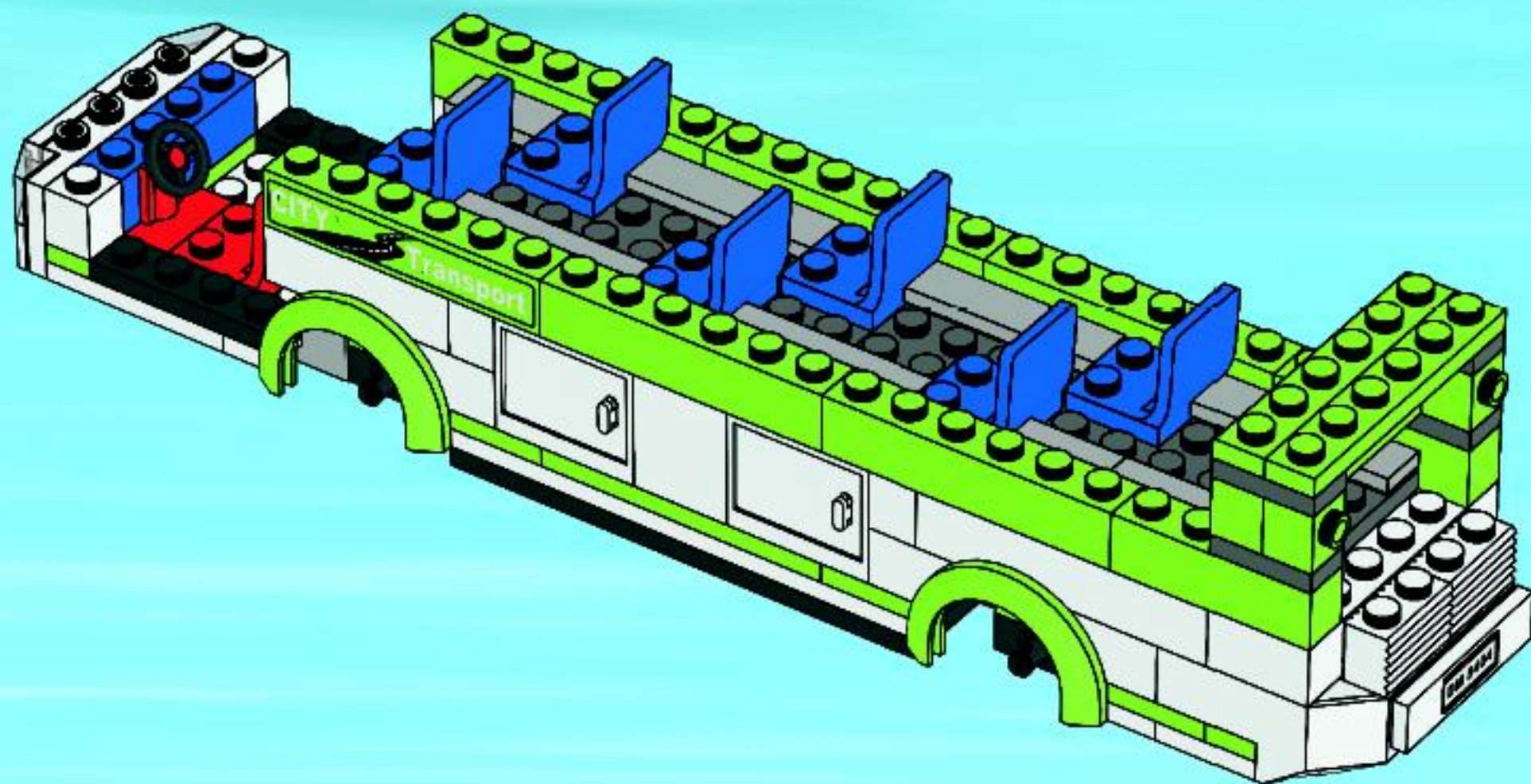

44

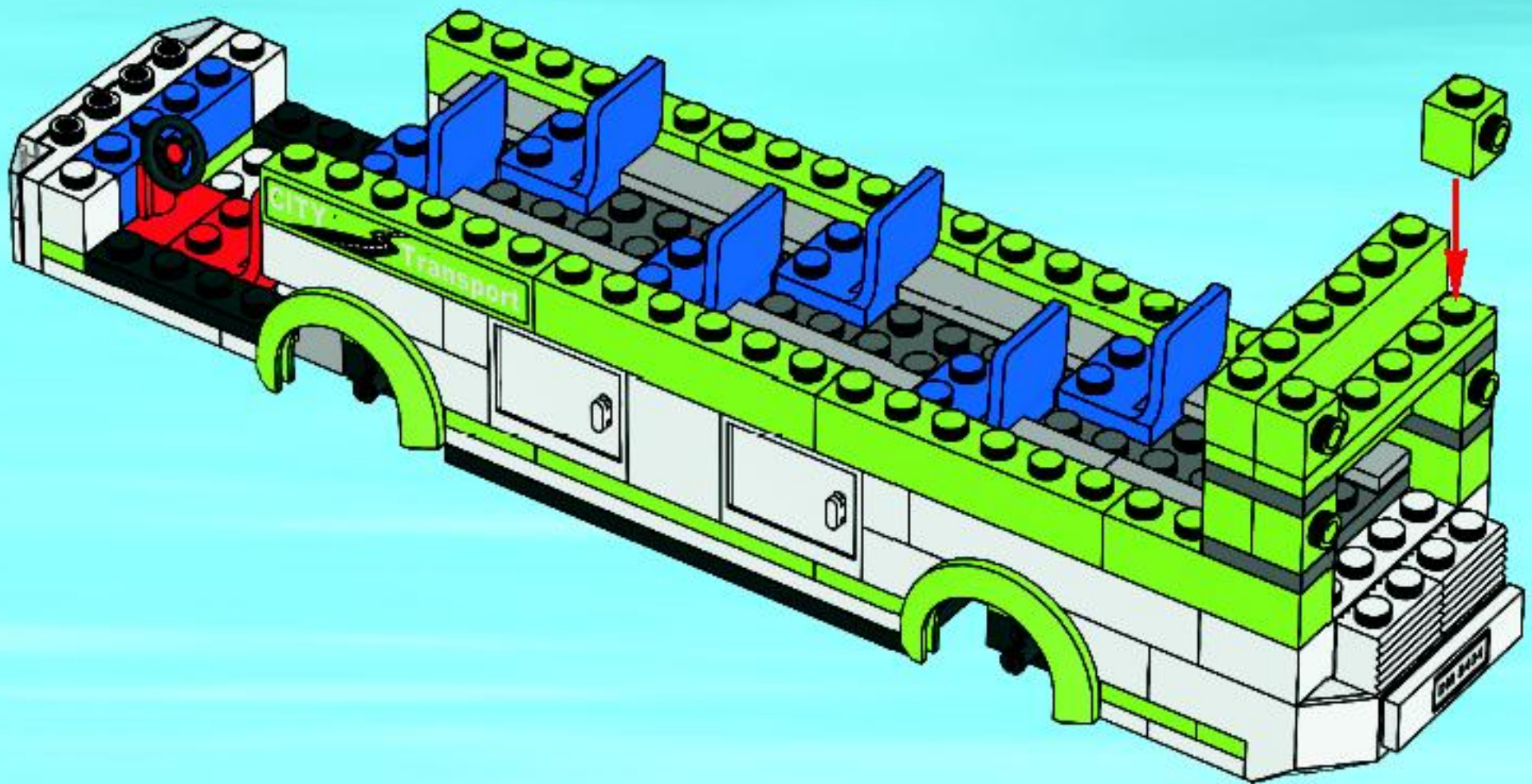

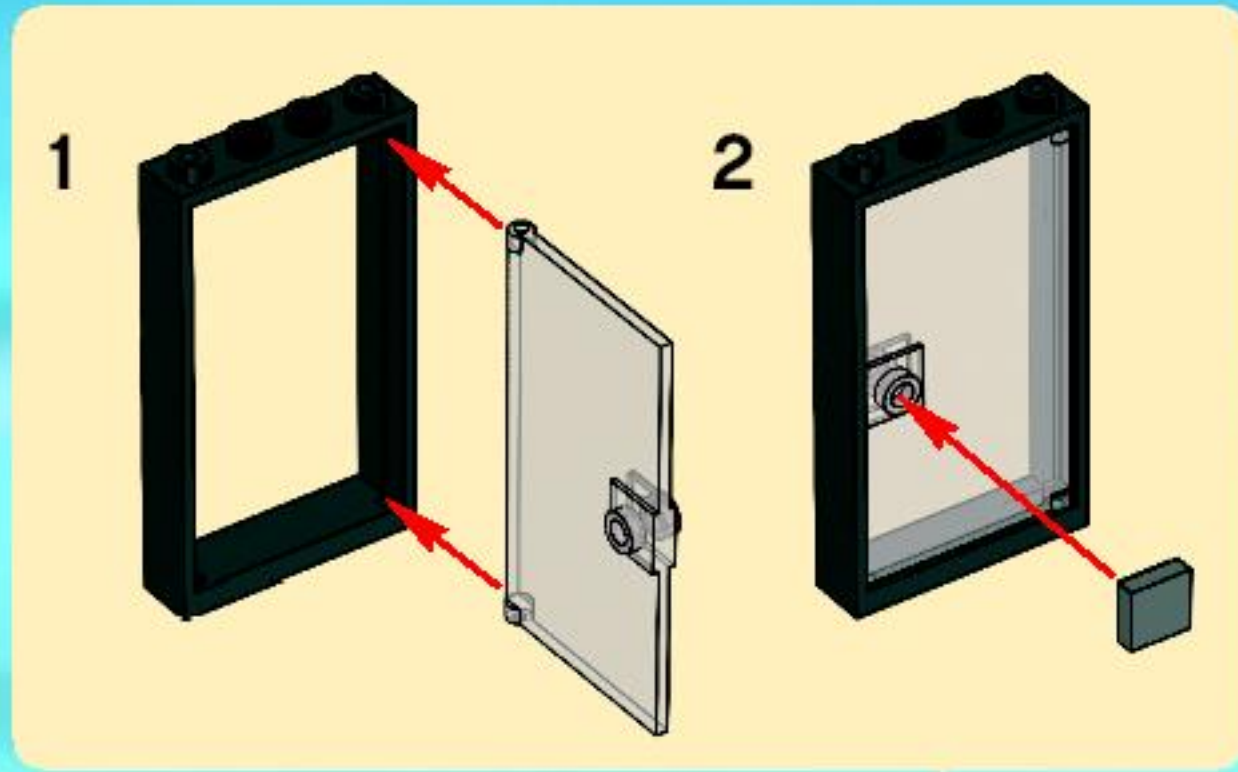

45

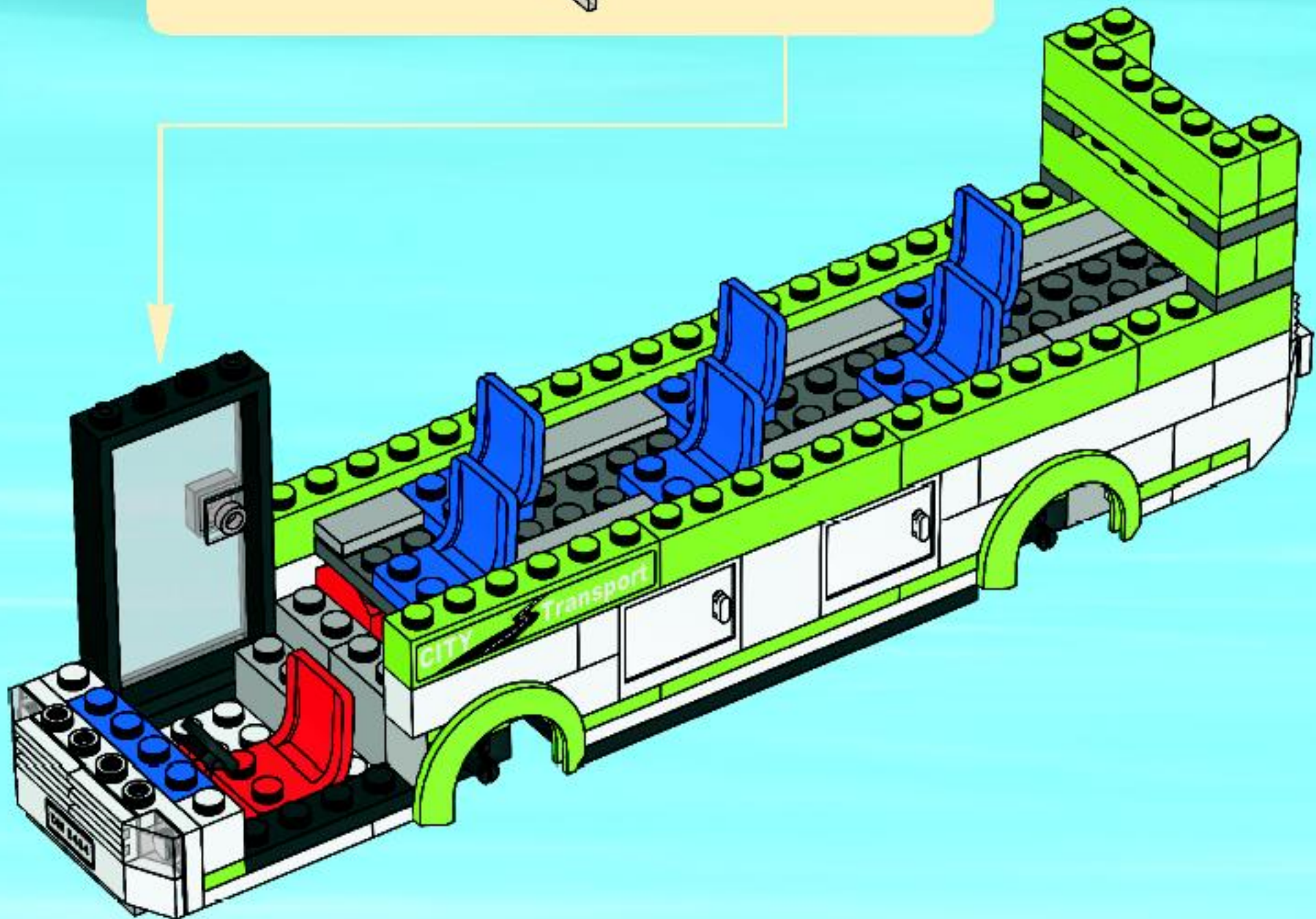

46

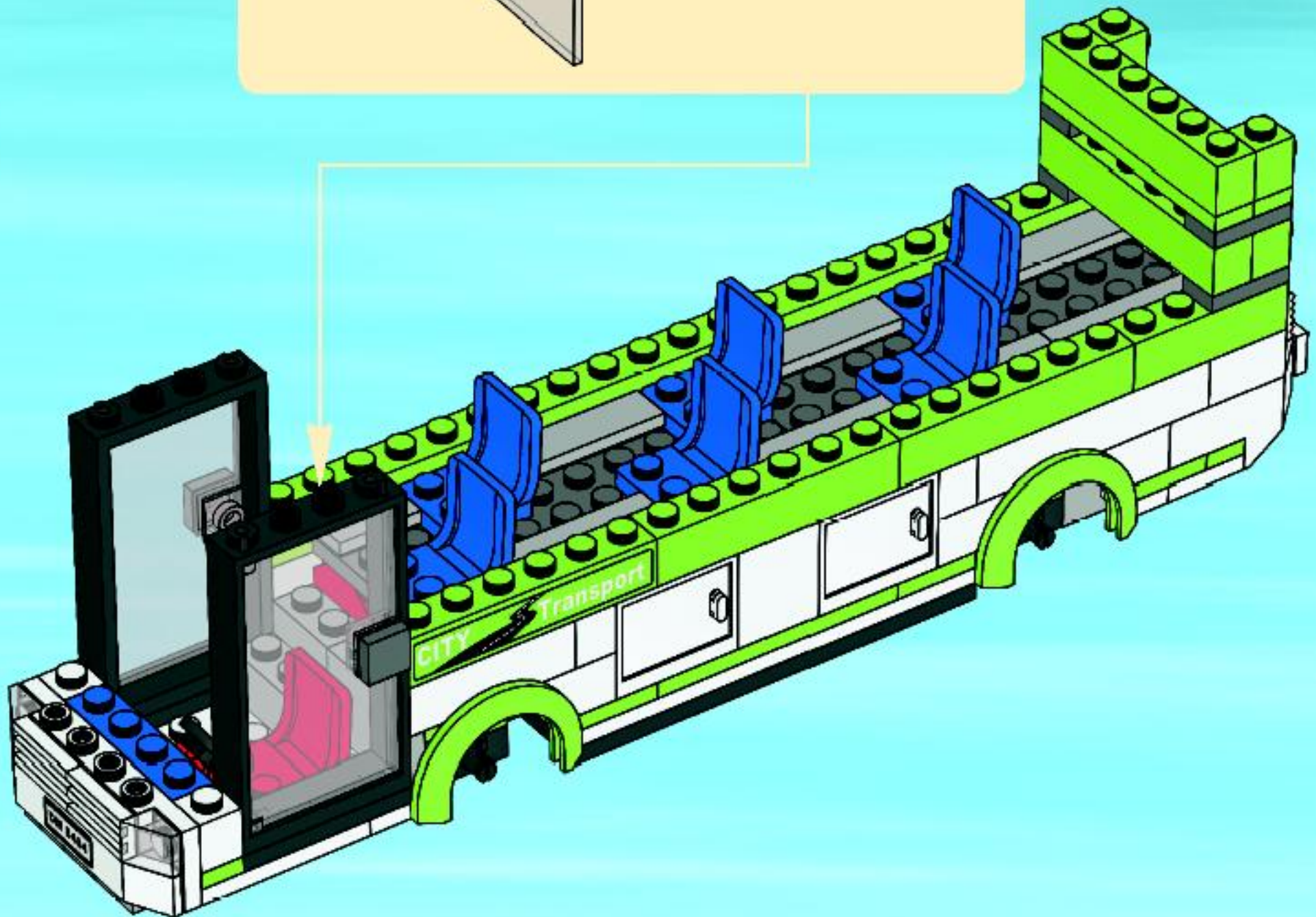
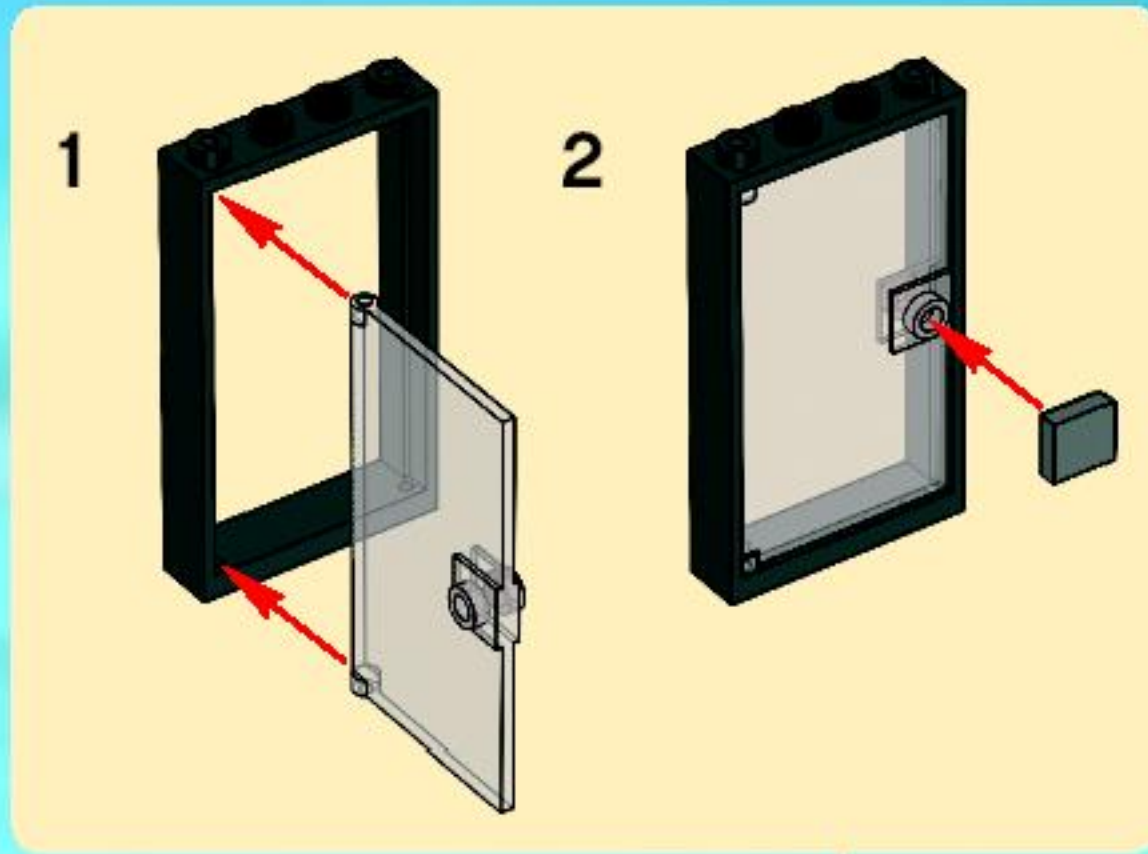

47

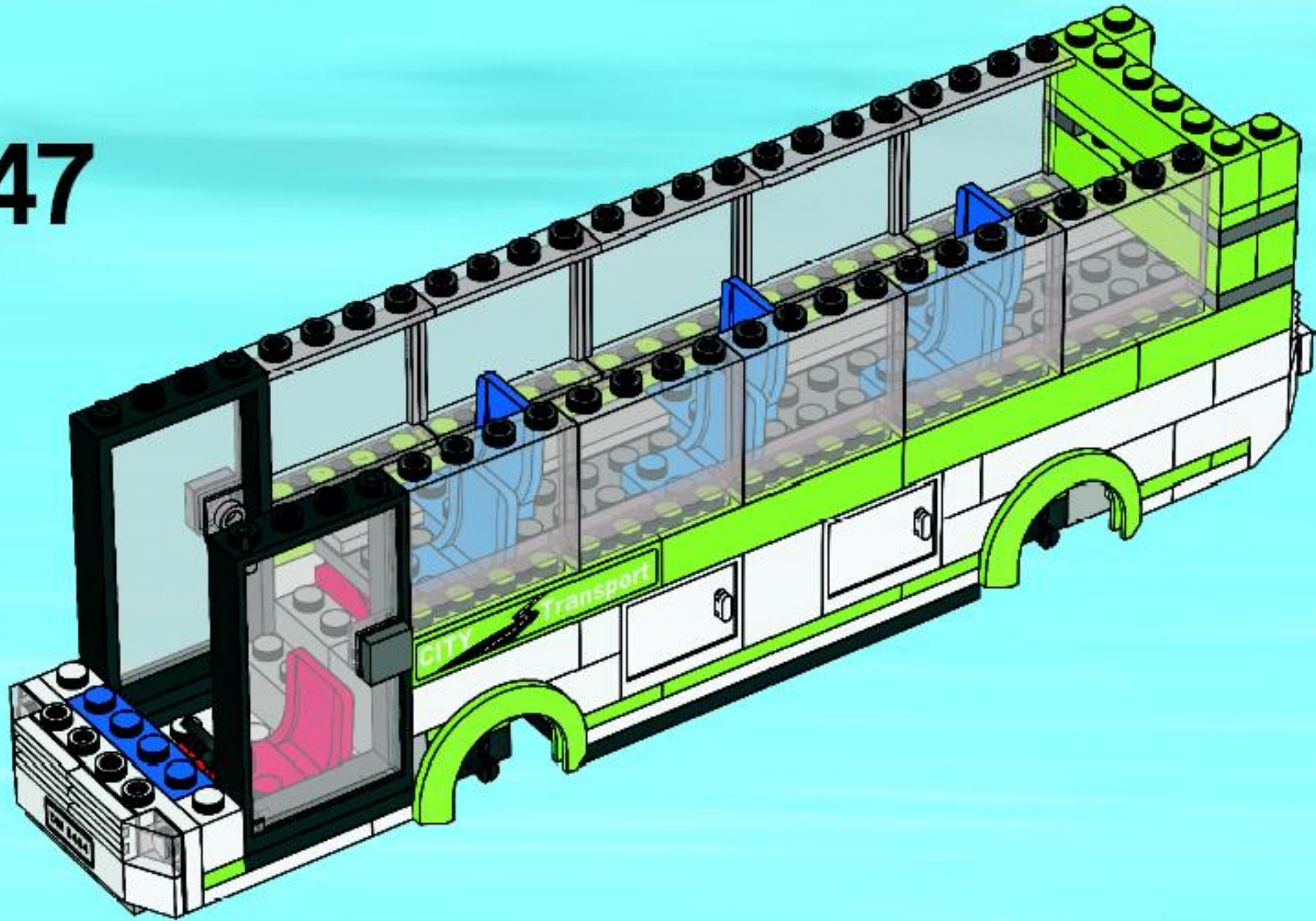

48

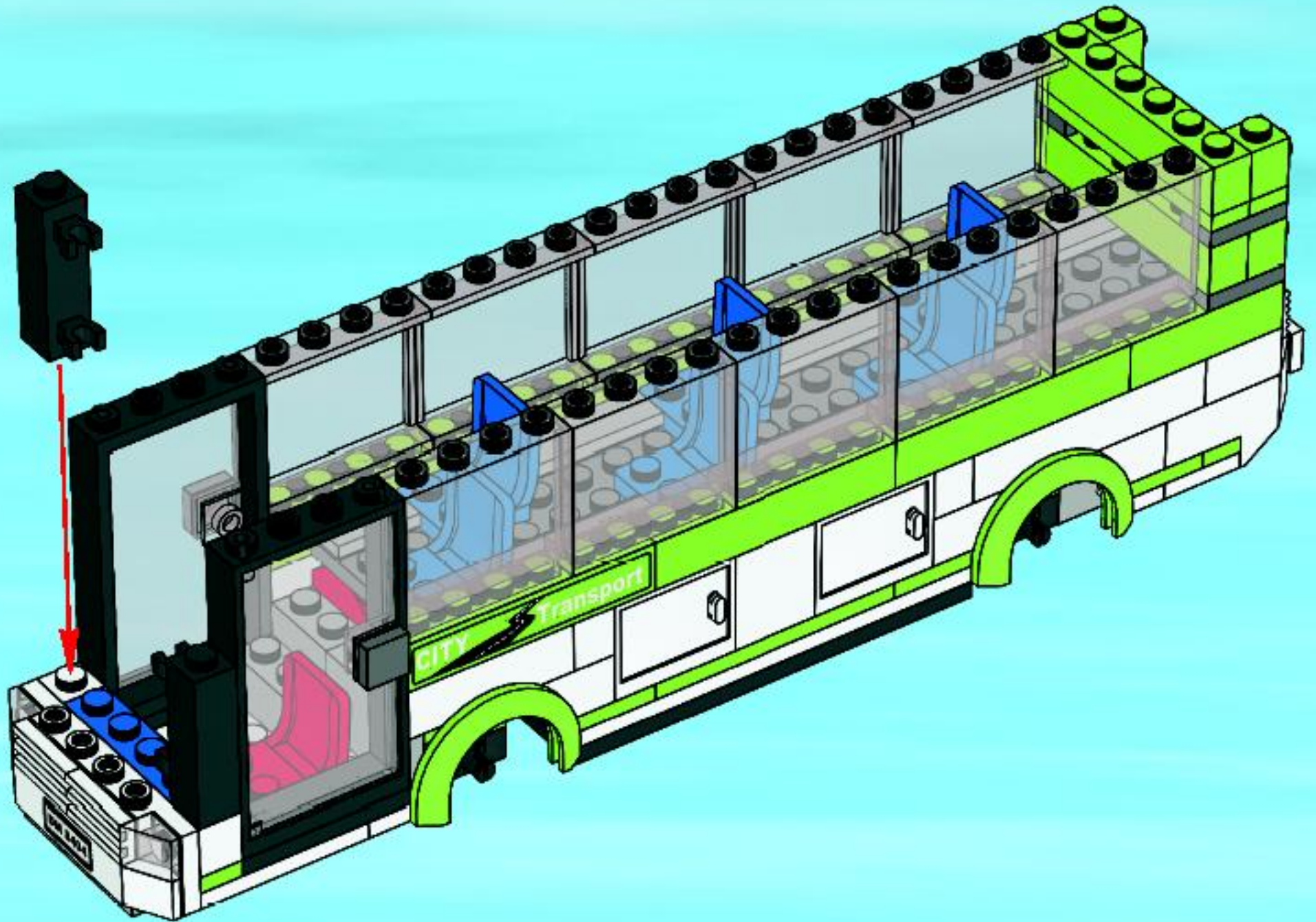

49

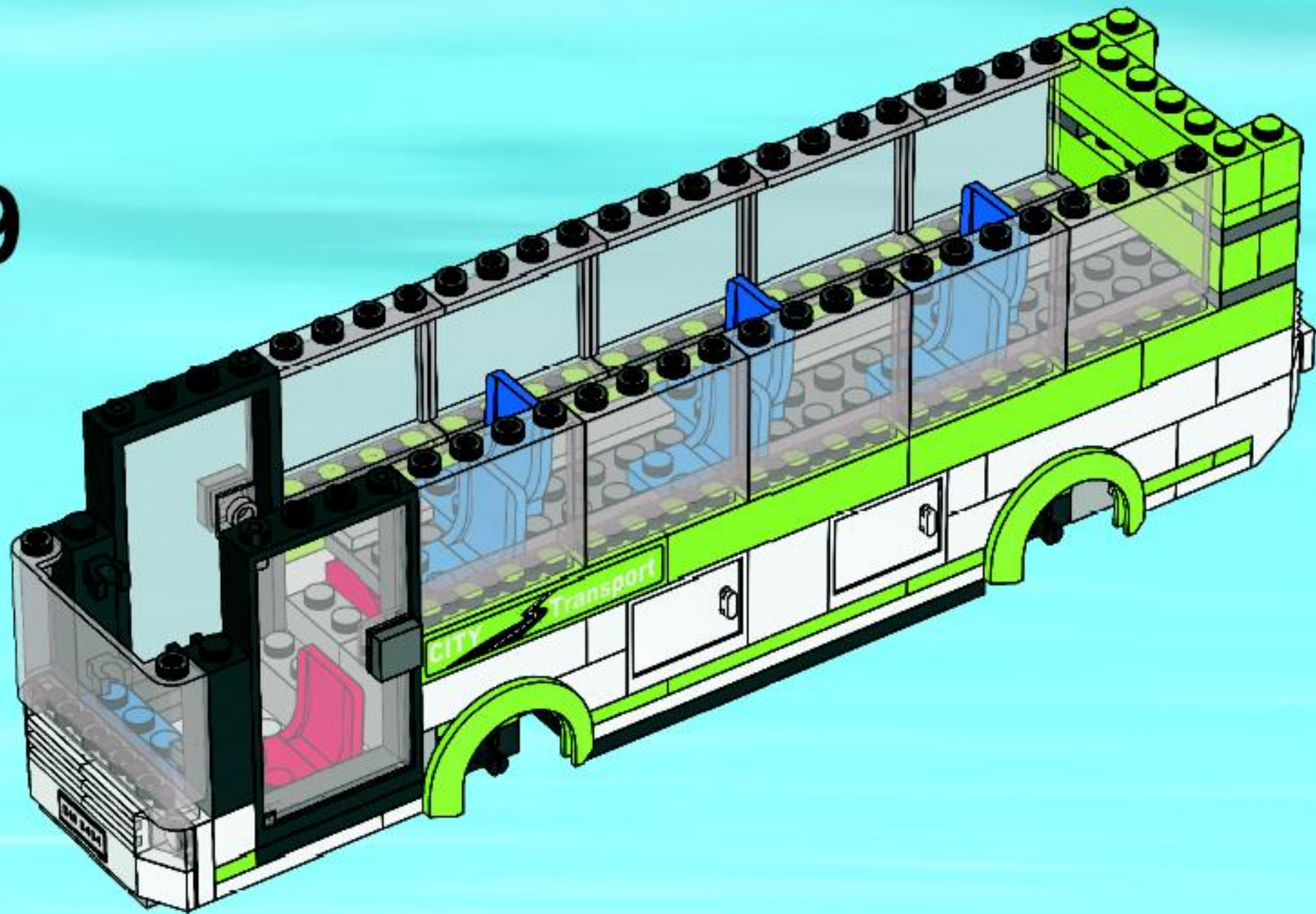

50

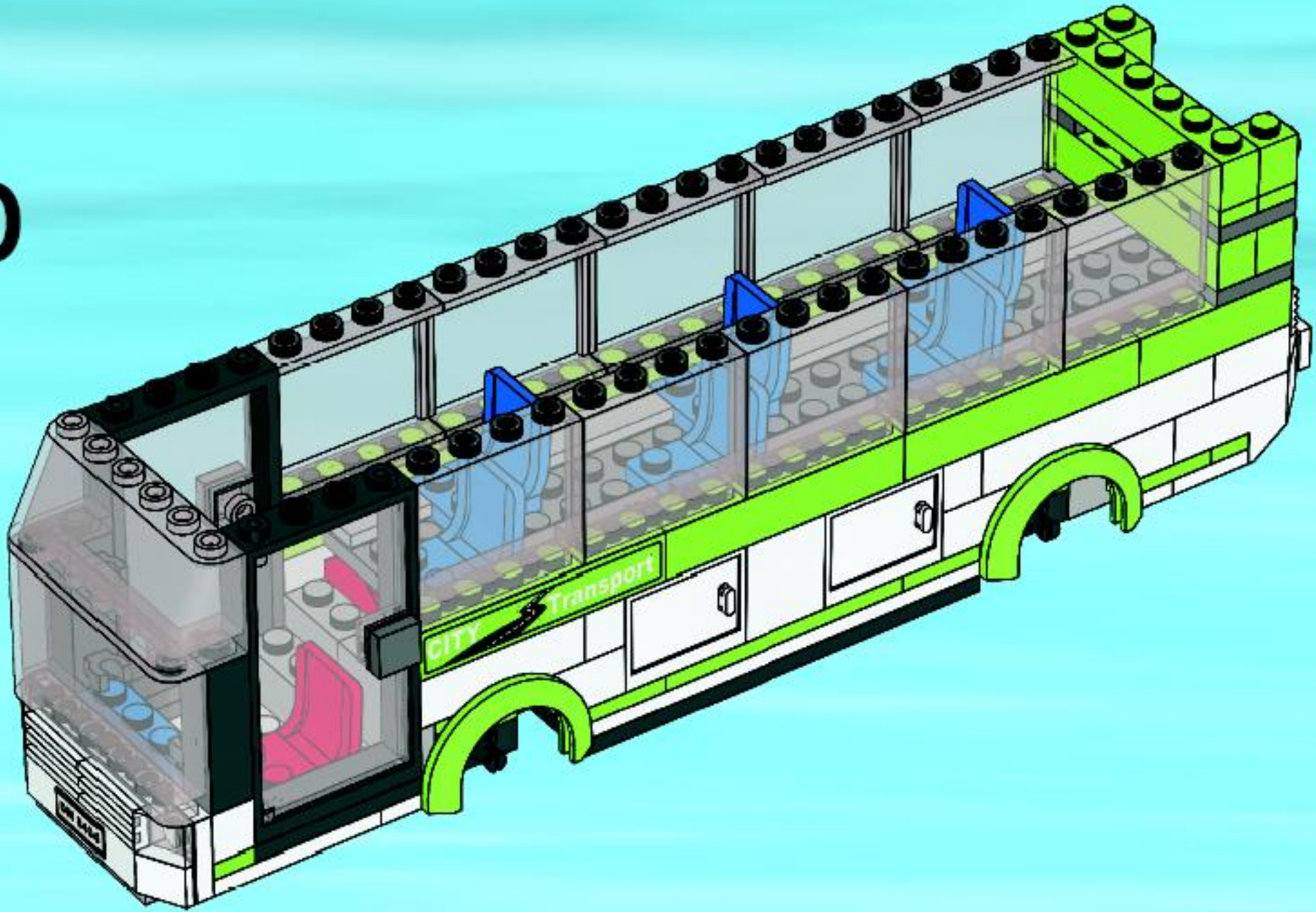

51

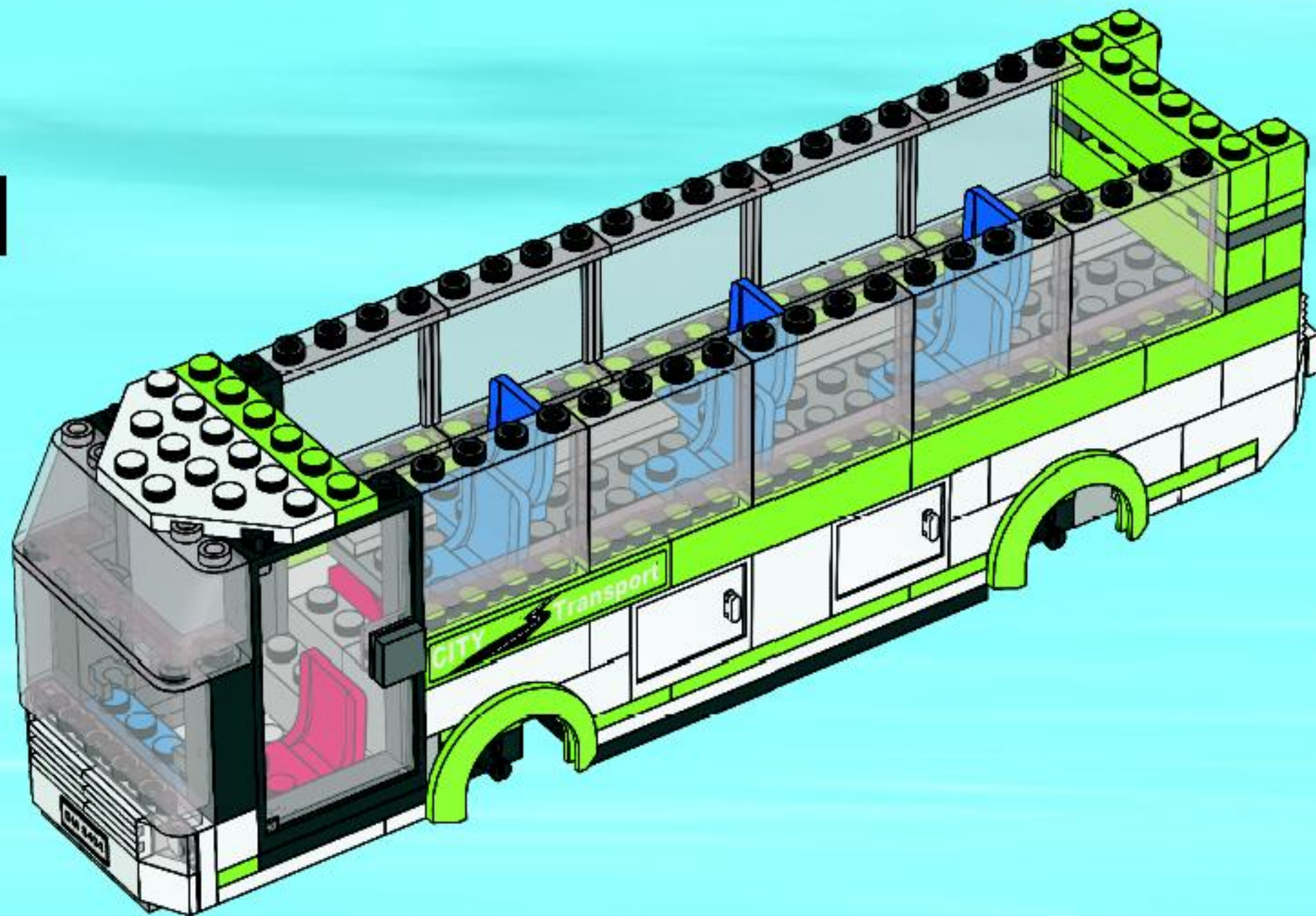

52

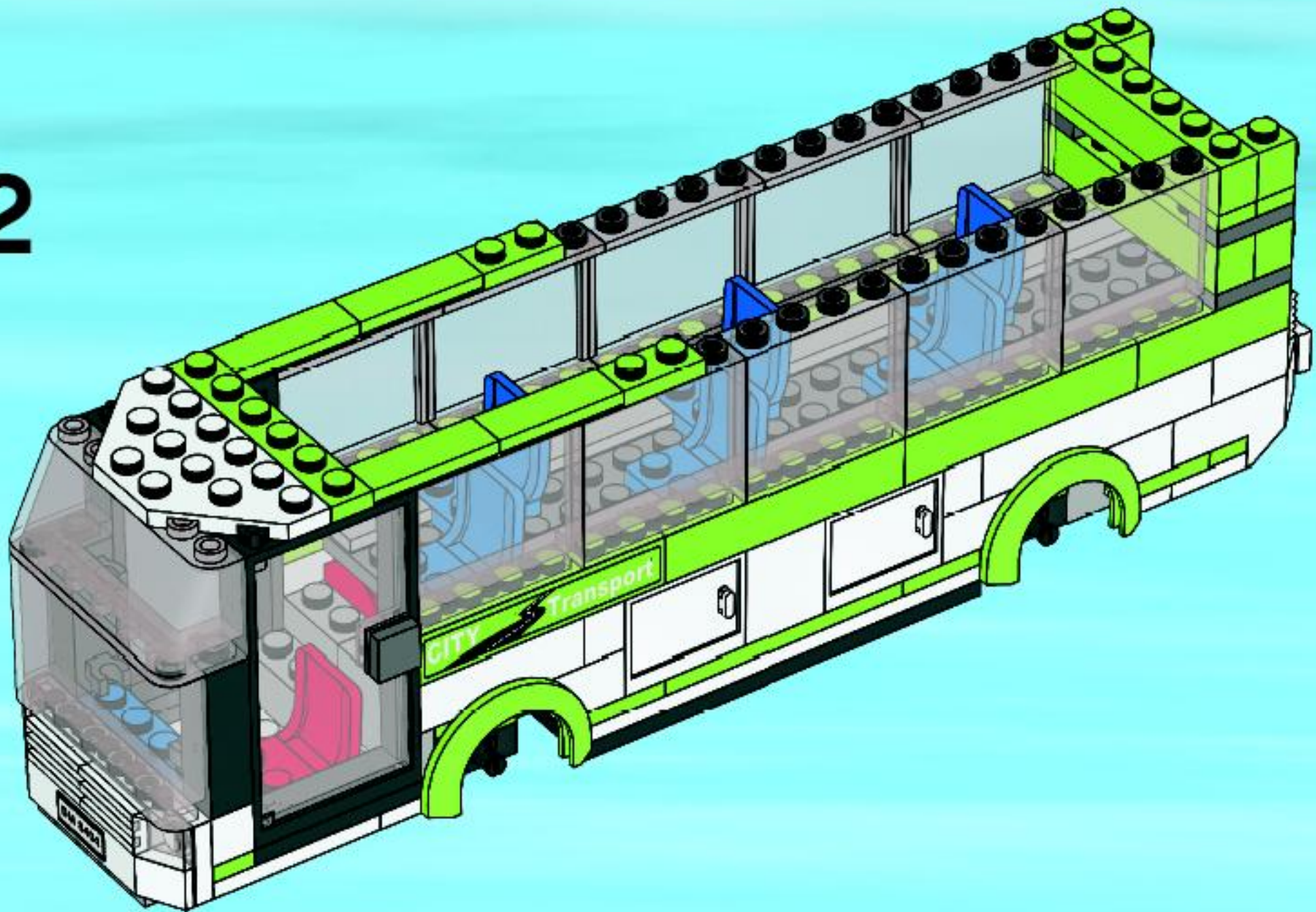

53

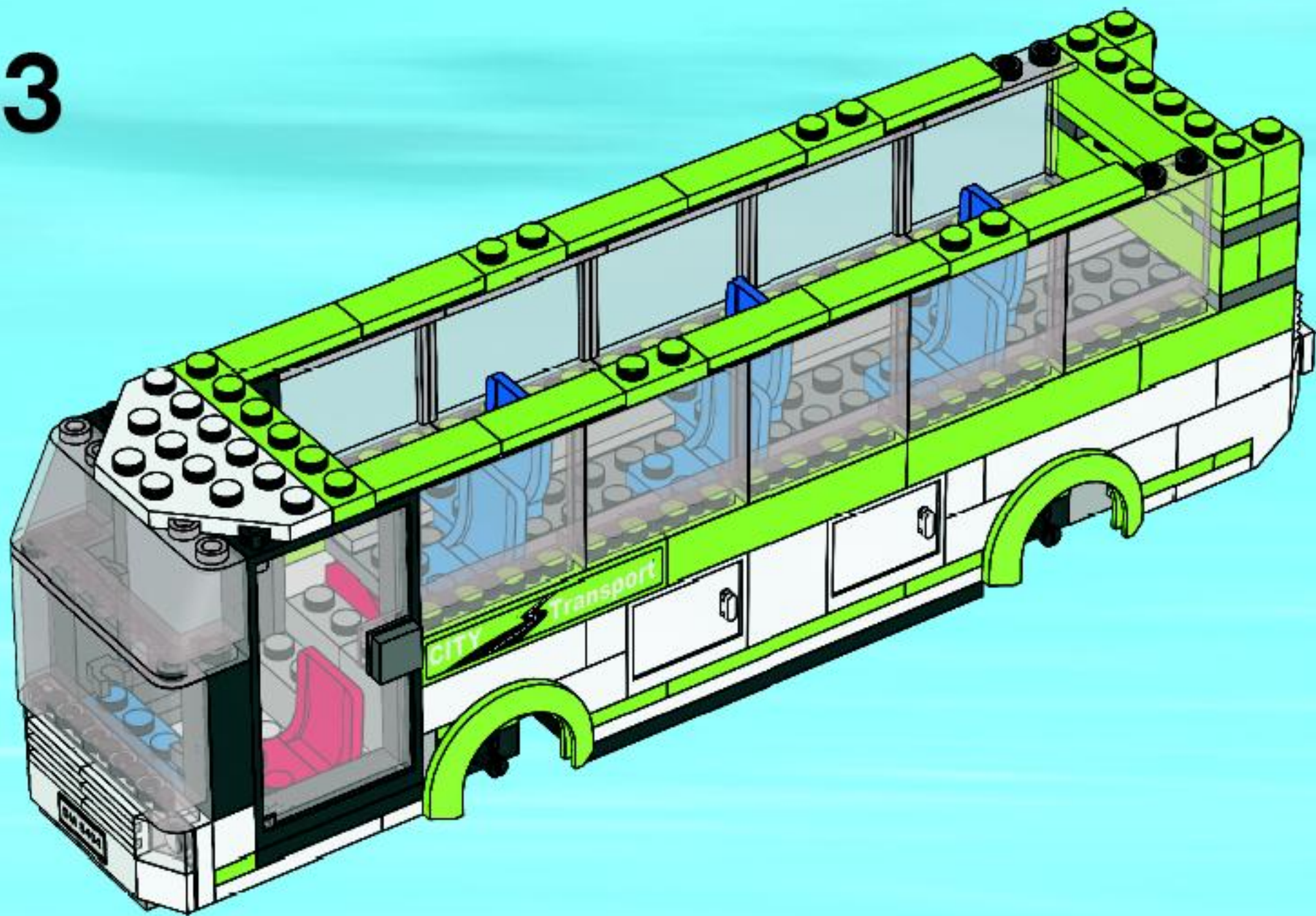

54

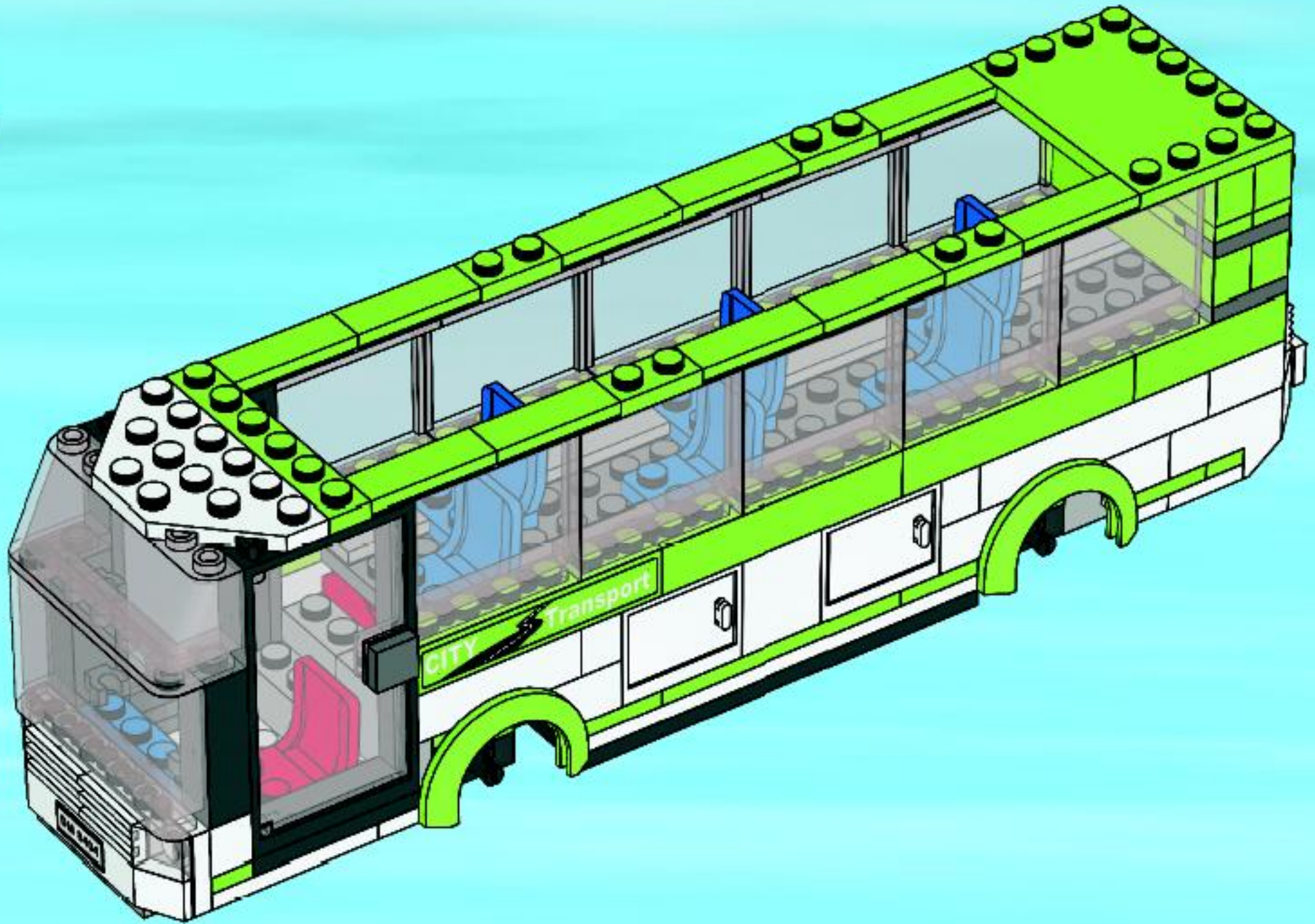

55

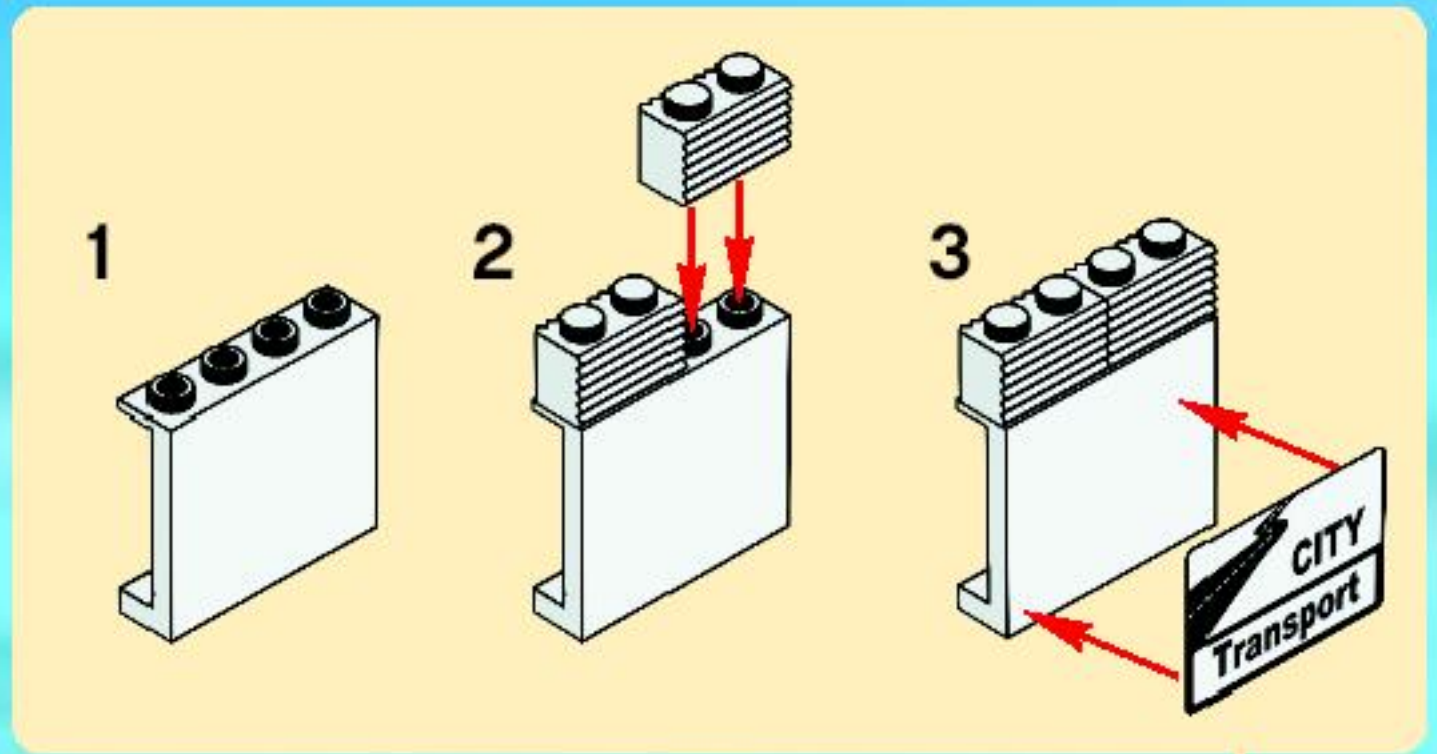

56

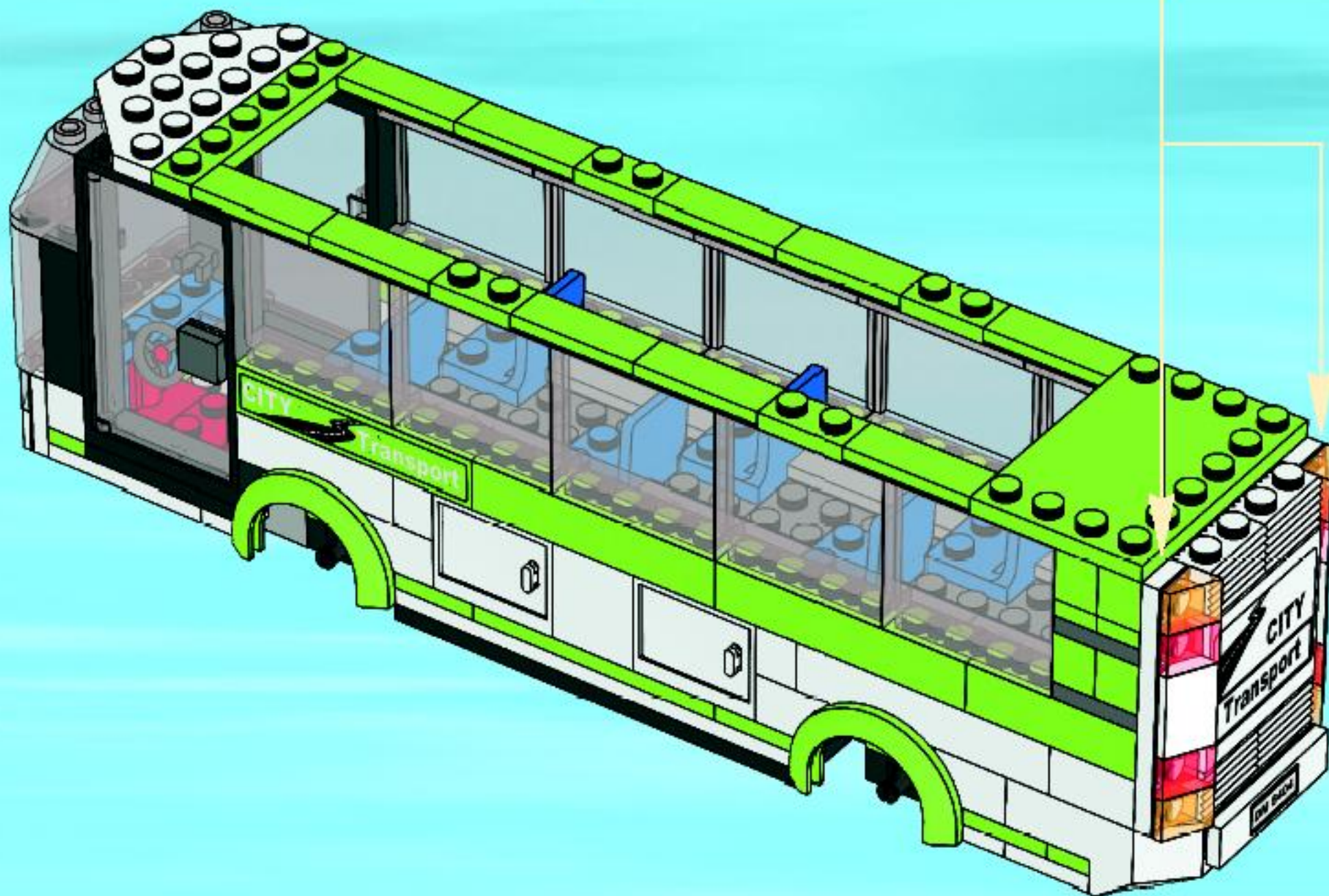
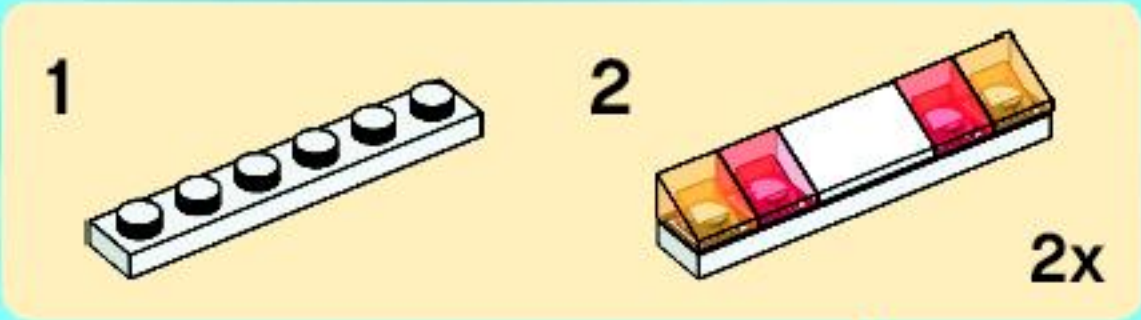

57

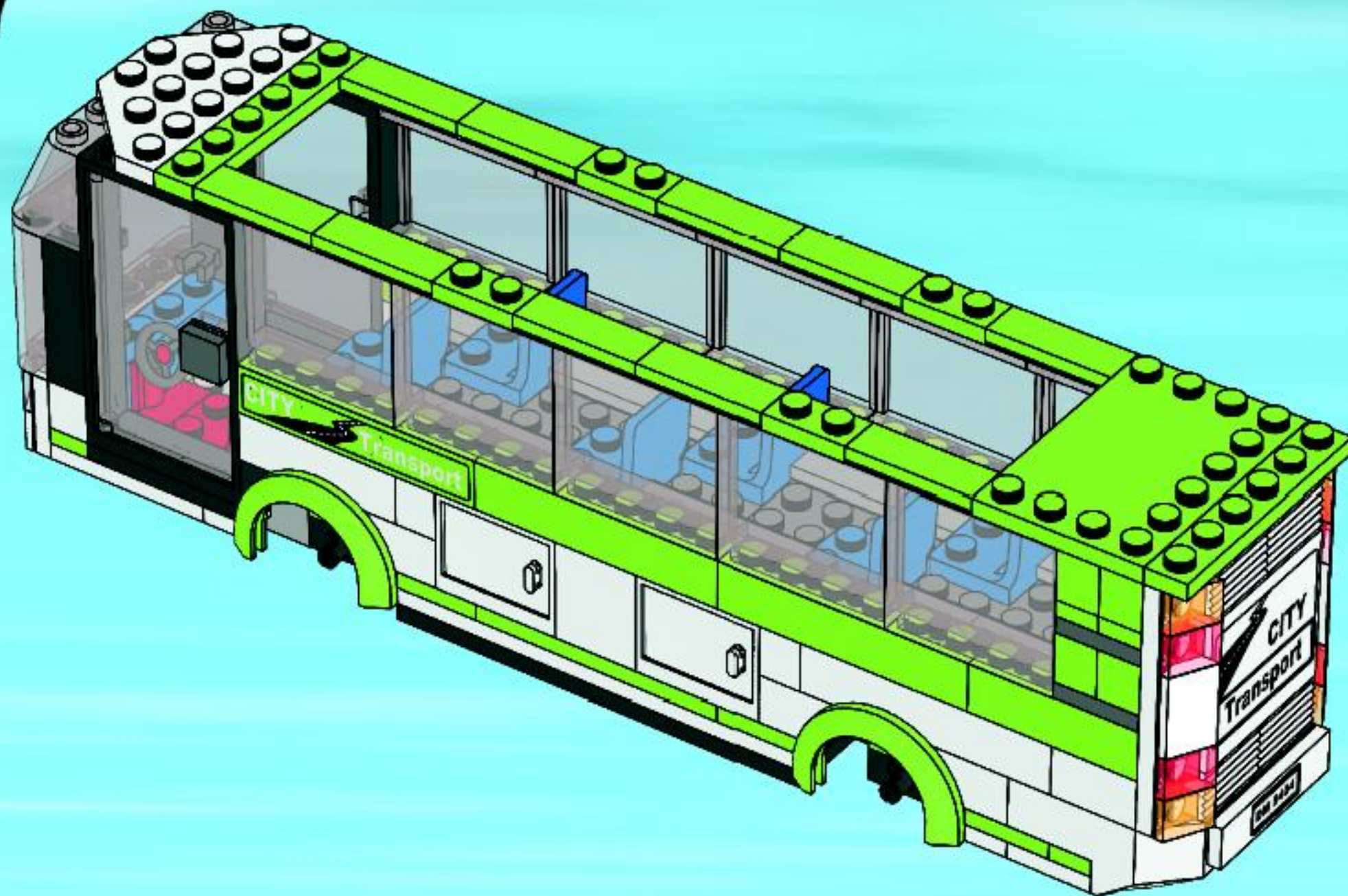

58

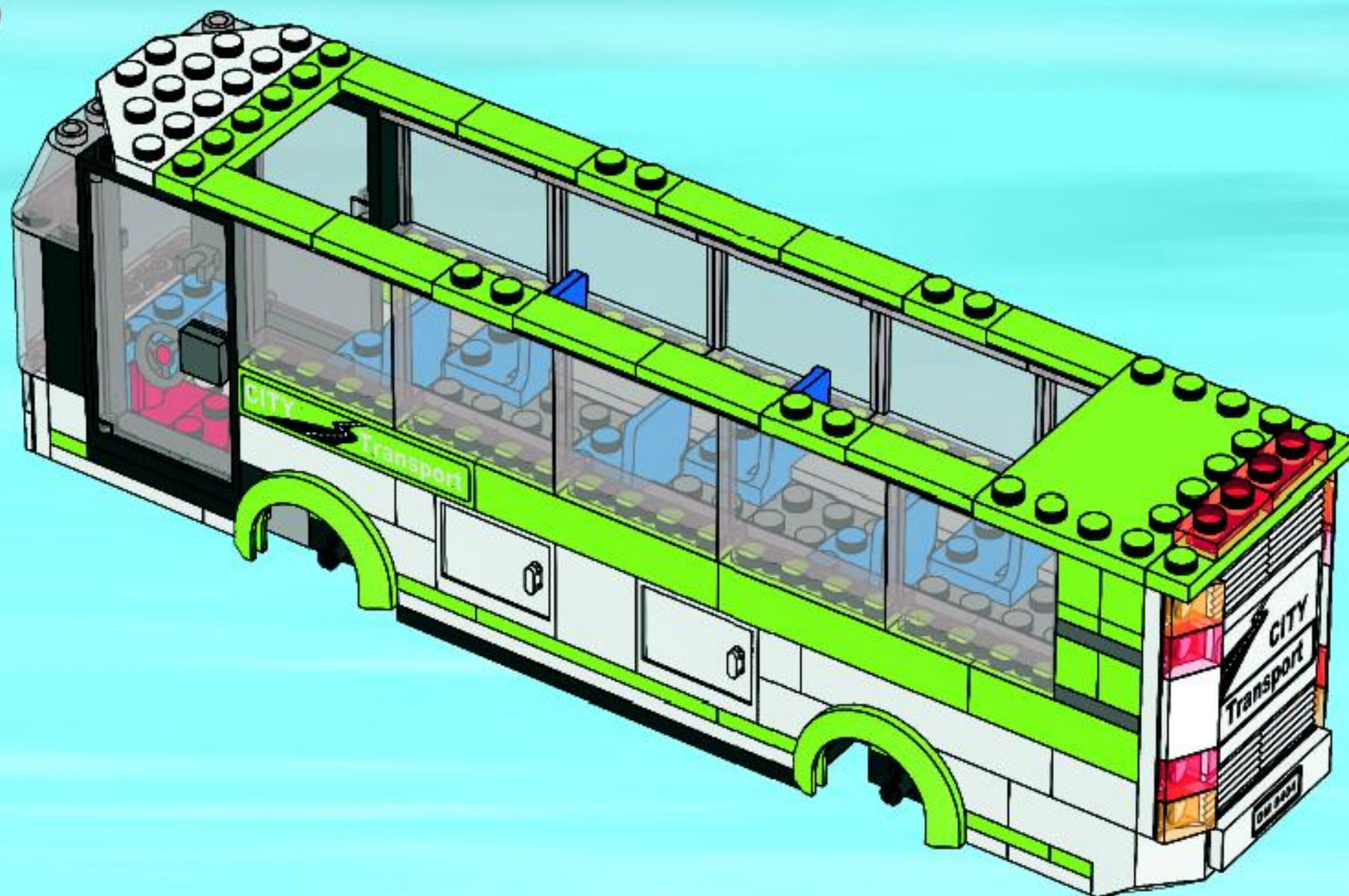

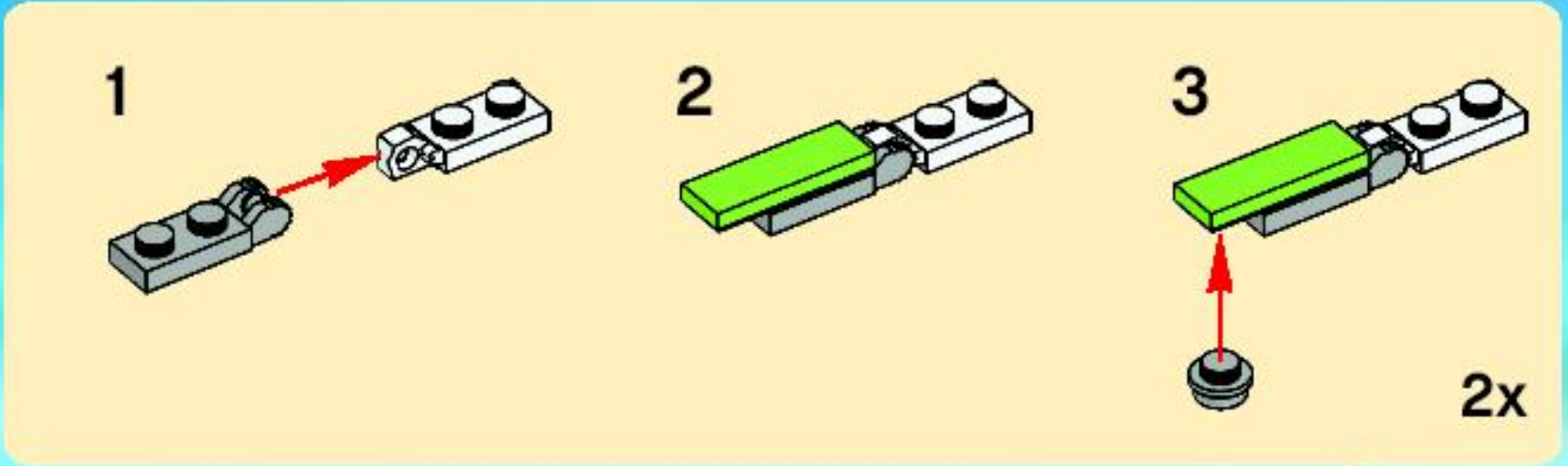

59

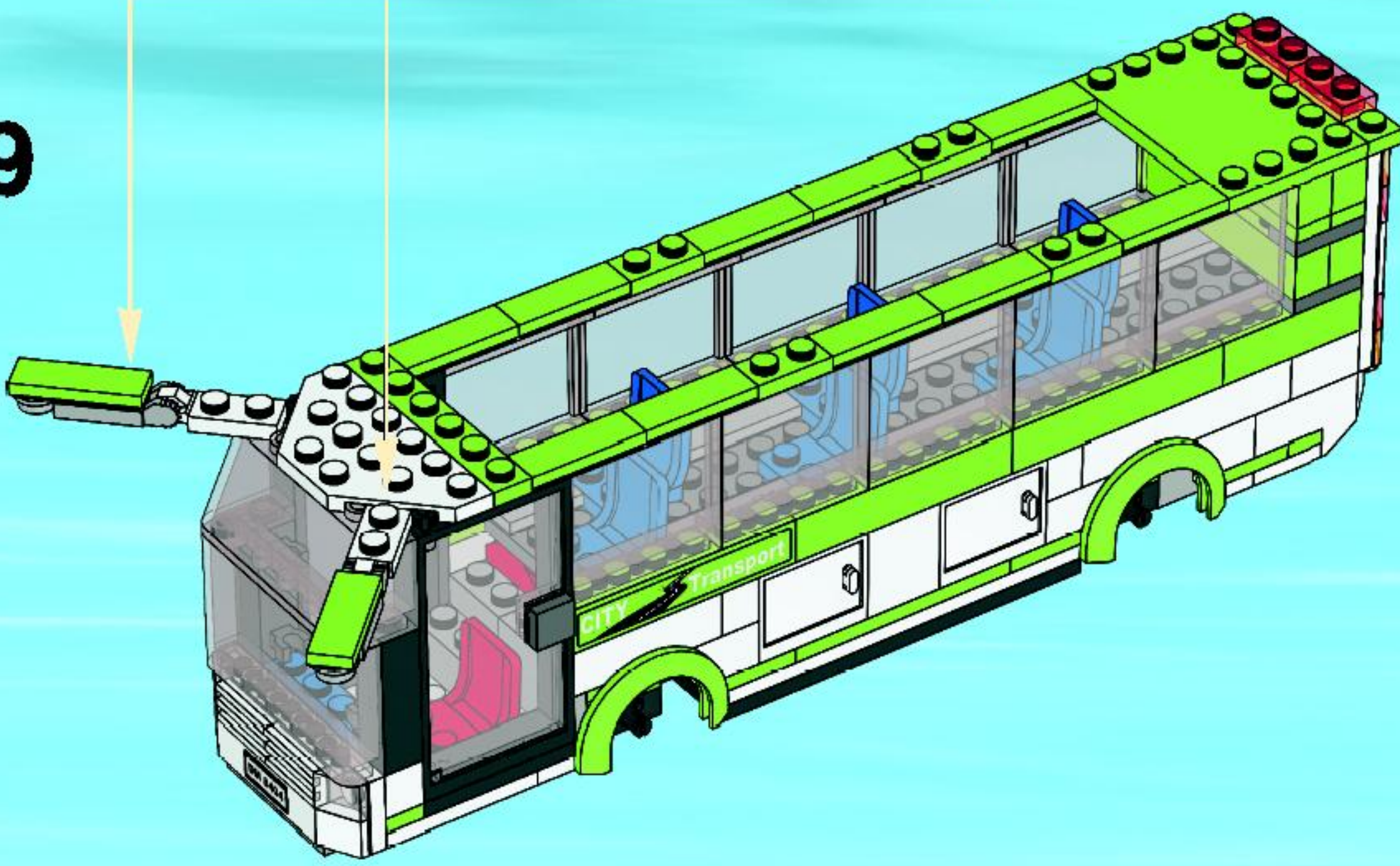

60

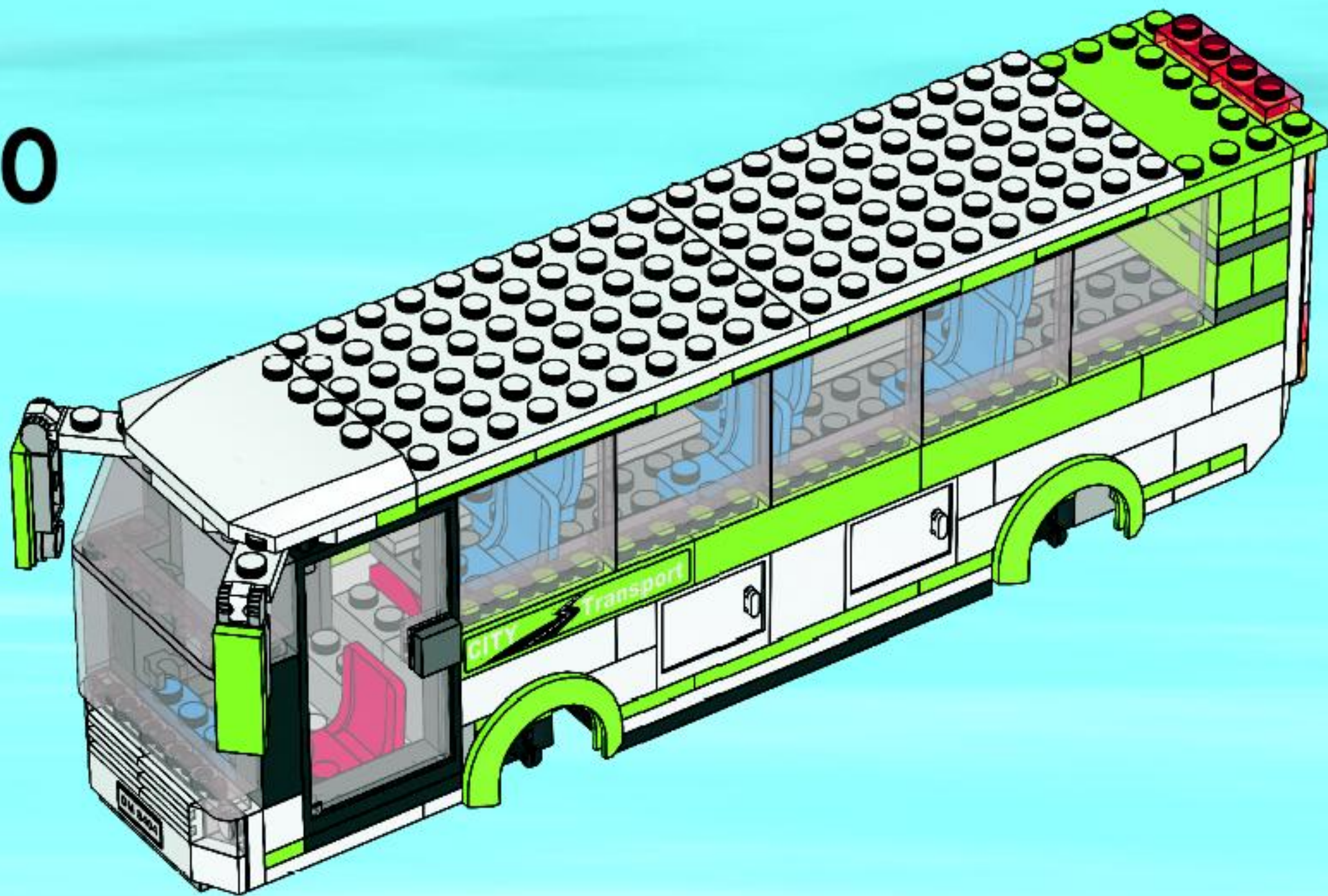

61

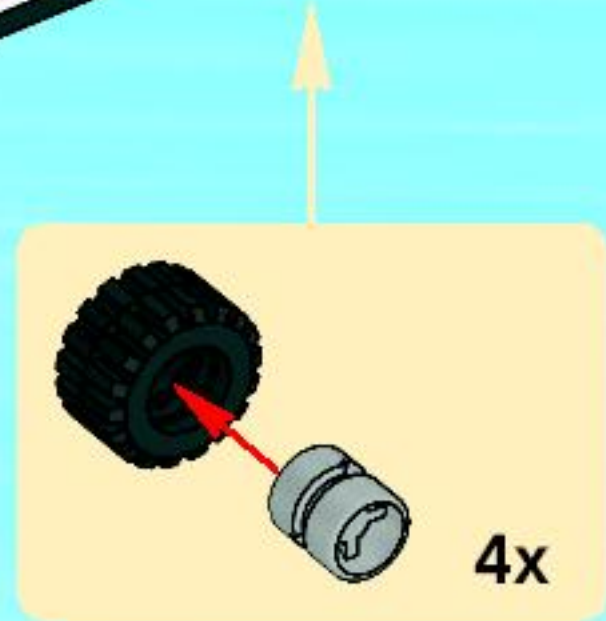
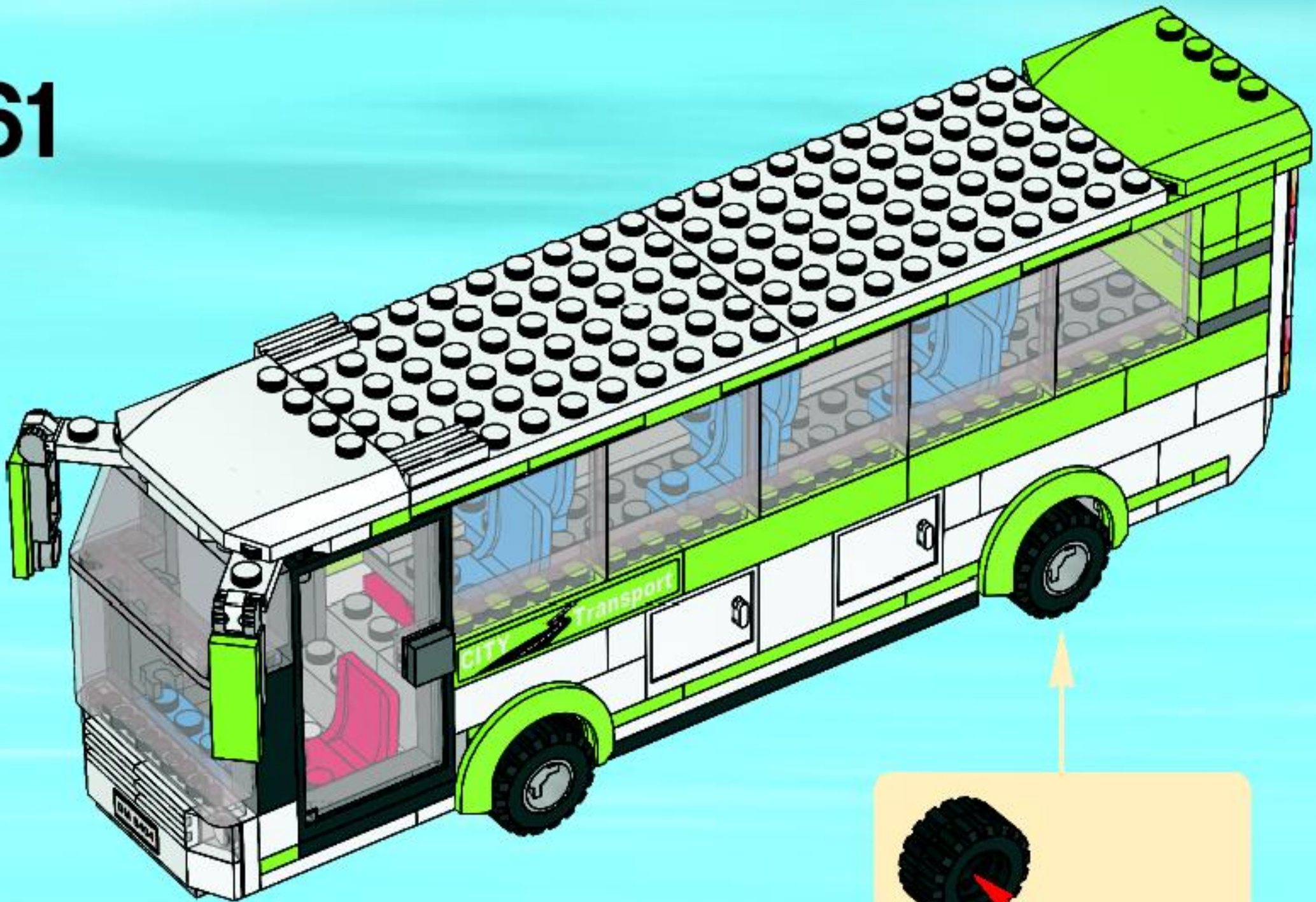

62



LEGO CITY



7241



7942



7239



7207



7208

LEGO CITY



3177



3178



3179



3180



3181



3182

LEGO

CITY



7895



7896



7936



7937



7938



7939

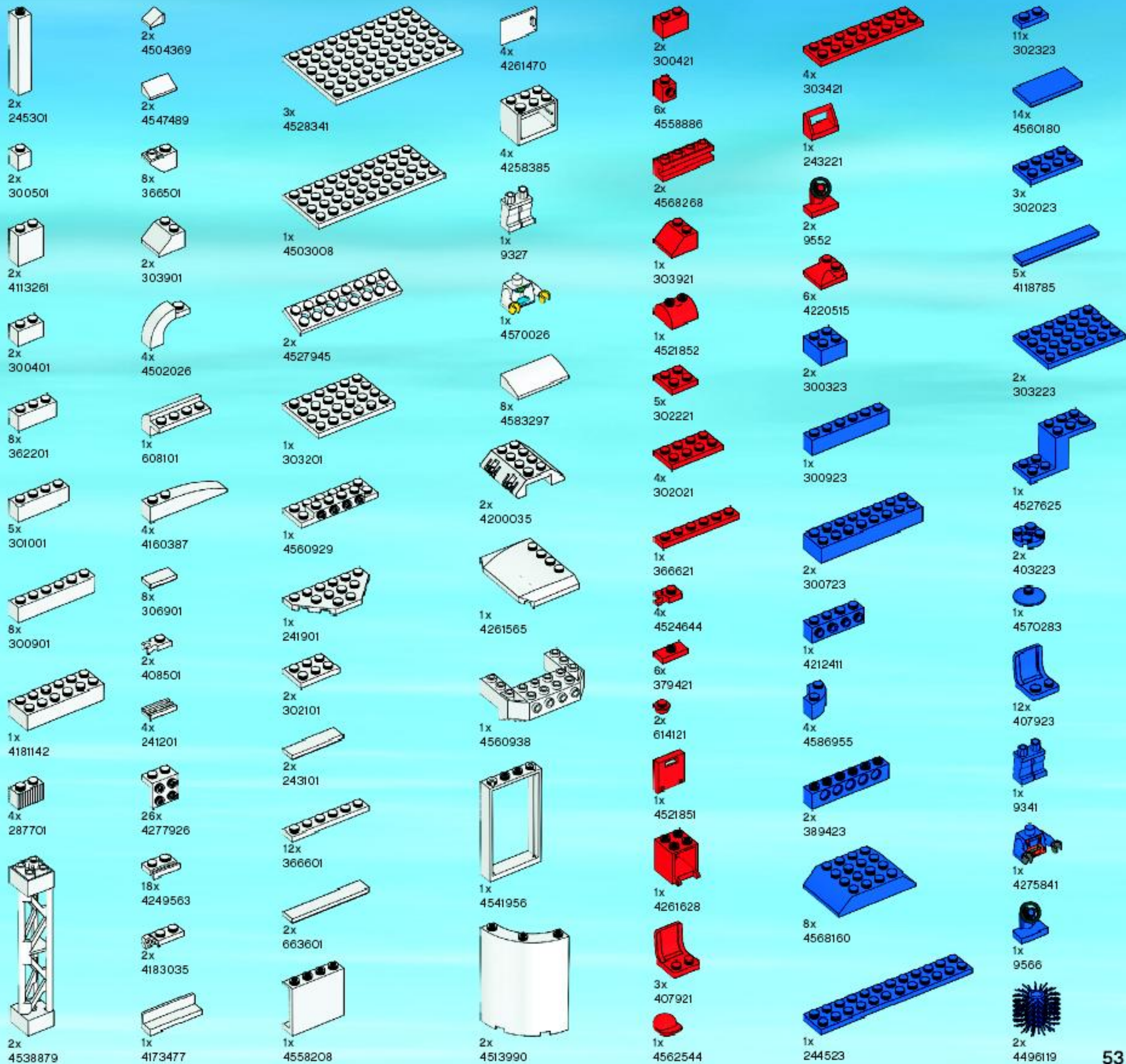

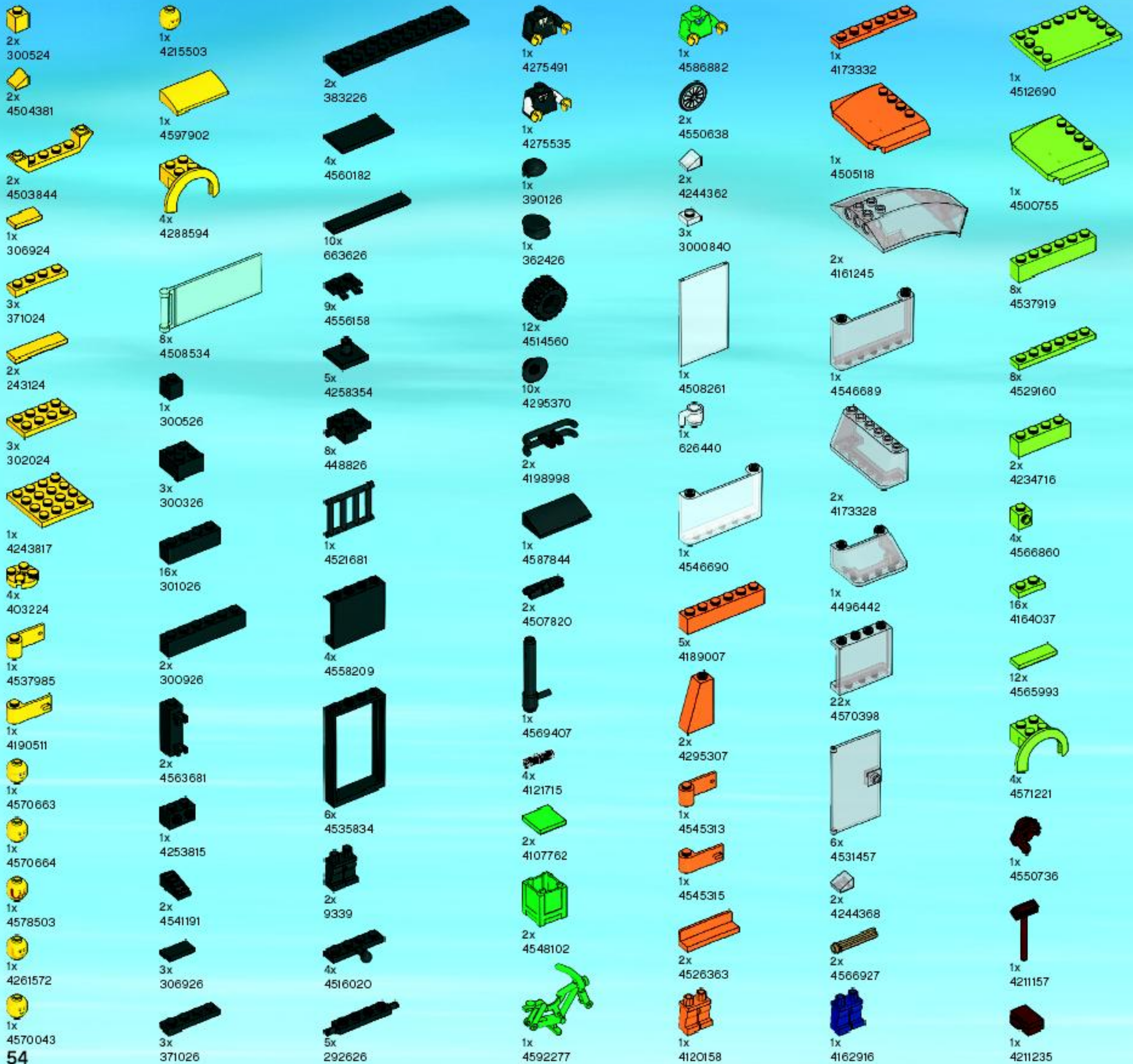



Customer Service

Kundenservice

Service Consommateurs

Servicio Al Consumidor

www.lego.com/service or dial



: 00800 5346 5555

: 1-800-422-5346



WIN!

Go to www.nielsen.com/LEGO to fill out a survey for a chance to win a cool LEGO® Product.

No purchase necessary.

Open to all residents where not prohibited.



www.nielsen.com/LEGO

GEWINNE! WIN!

Nimm an der Umfrage auf www.nielsen.com/LEGO teil und hab die Chance ein cooles LEGO® Produkt zu gewinnen!

Die Teilnahme am Gewinnspiel führt zu keinerlei Kaufverpflichtungen. Teilnahme in allen nicht ausgeschlossenen Ländern möglich.

Ga naar www.nielsen.com/LEGO, vul een enquêteformulier in en maak kans op een cool LEGO® product.

Geen aankoopverplichting. Iedereen mag deelnemen, uitgezonderd ingezetenden van landen waar een enquêteverbod geldt.

GAGNE! 当てよう!

Visite www.nielsen.com/LEGO pour répondre à un questionnaire et avoir une chance de gagner un produit LEGO® très cool!

Aucune obligation d'achat. Ouvert à tous les résidents des pays autorisés.

www.nielsen.com/LEGOにアクセスして、アンケートにご記入ください。当選者にはレゴ製品を差し上げます。

お買い上げの必要はありません。

禁止されていない限り、すべての国でご利用いただけます。