

BIONICLE®

TOA HORDIKA
NUJU



8741





1

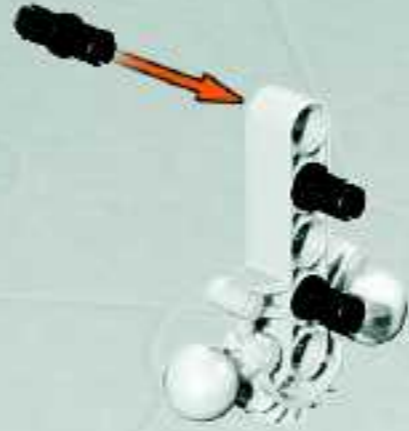

2



3



4

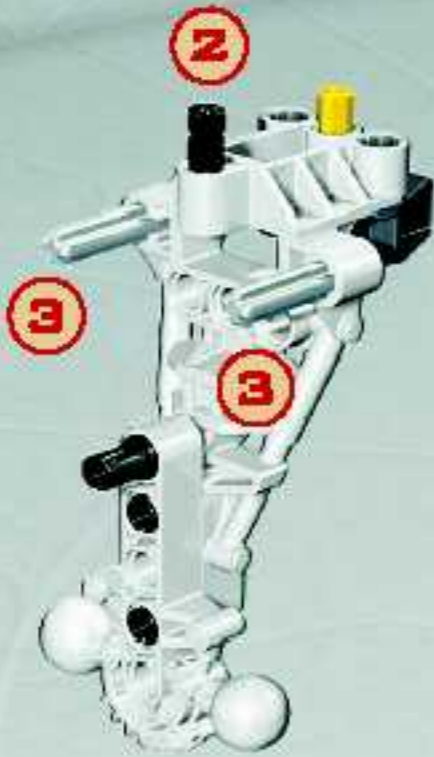

5



6



1

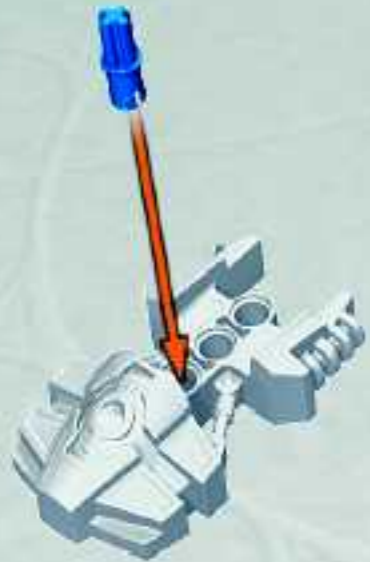

2

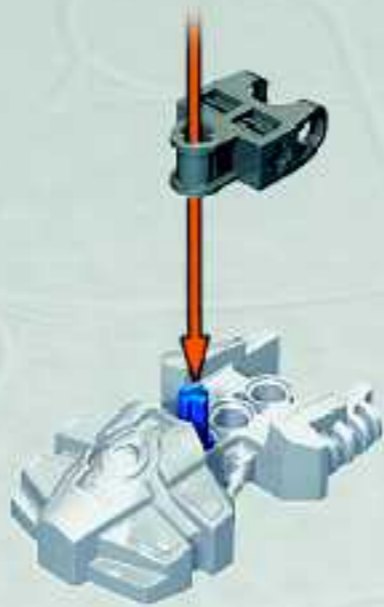

3

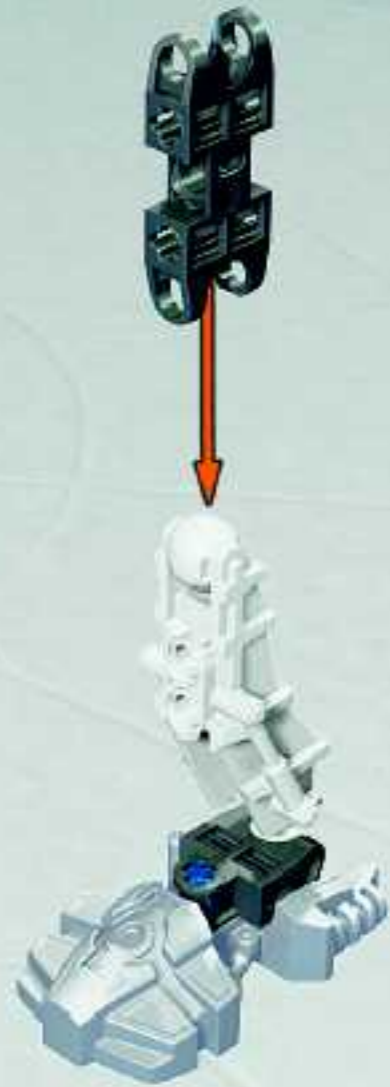

4



5



2x

7



1



2



3



4



8



9

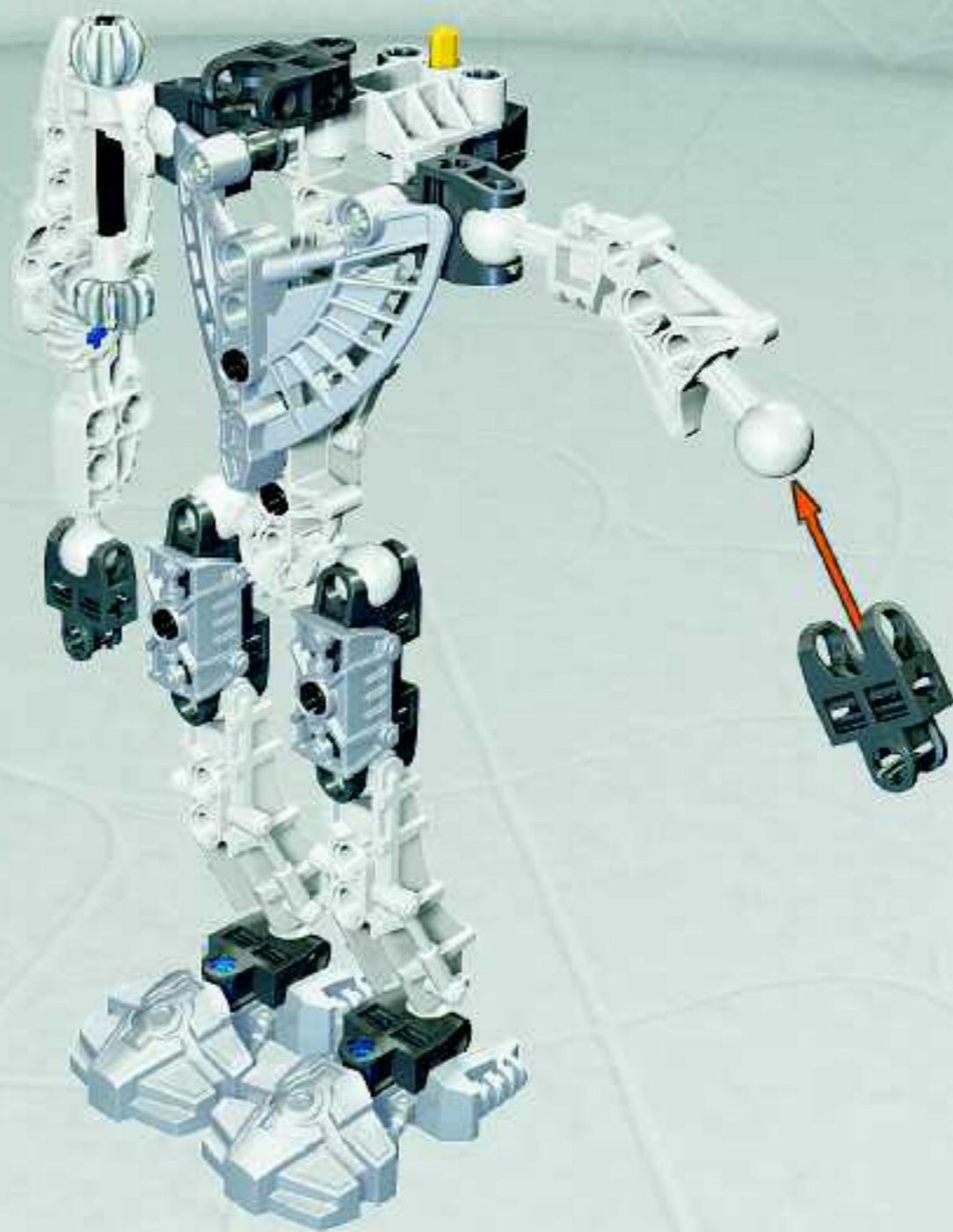

10

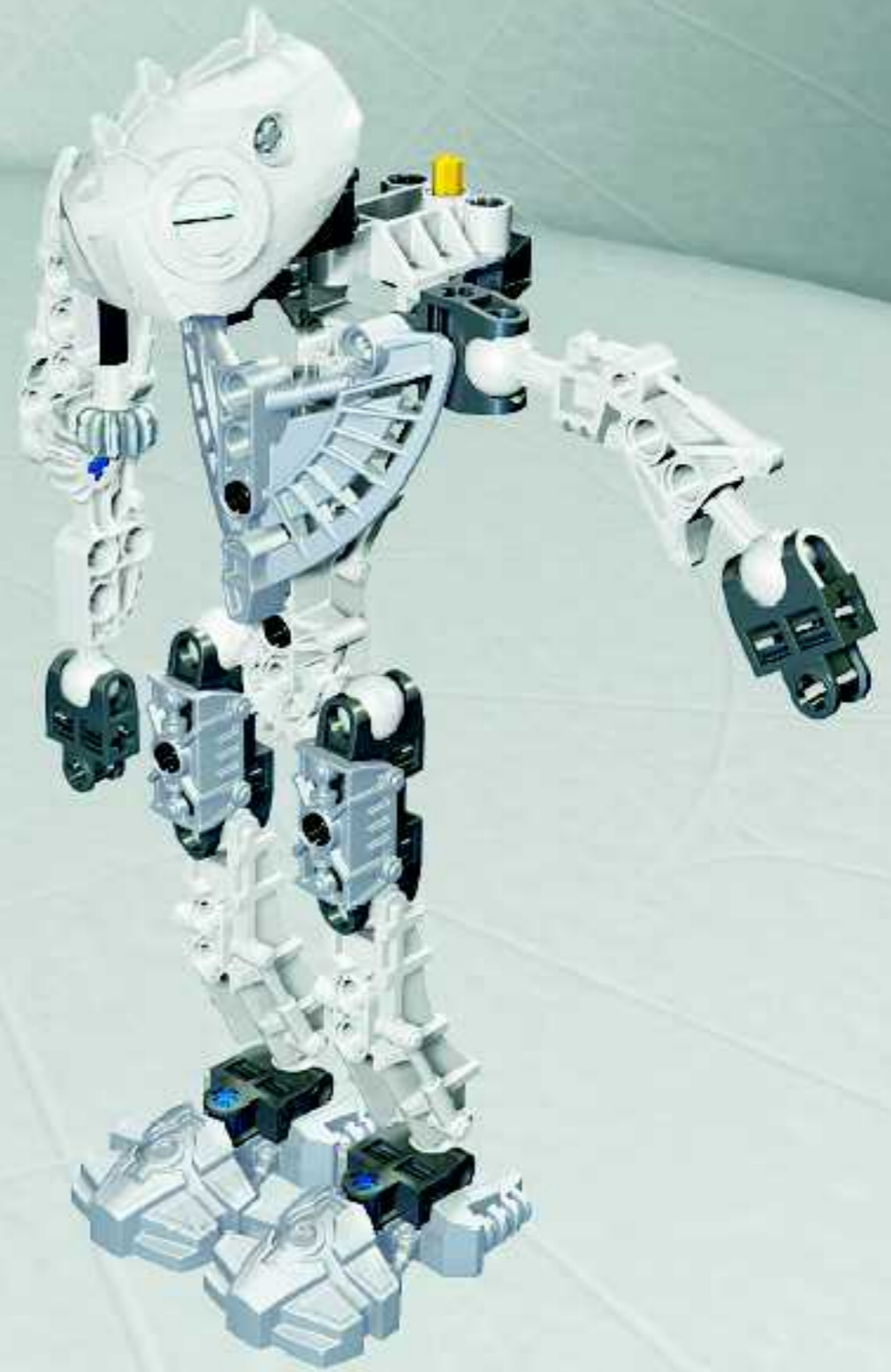
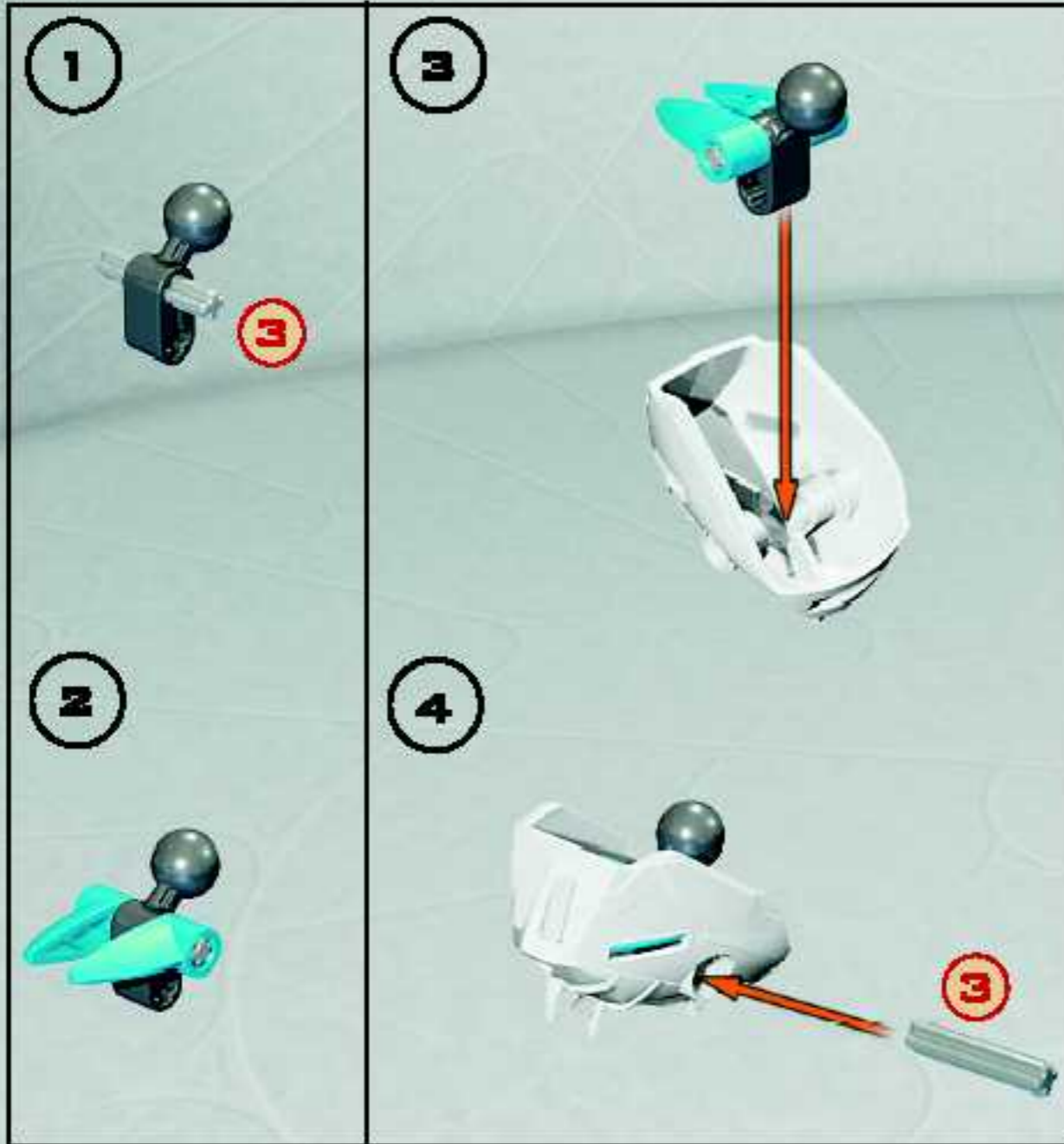

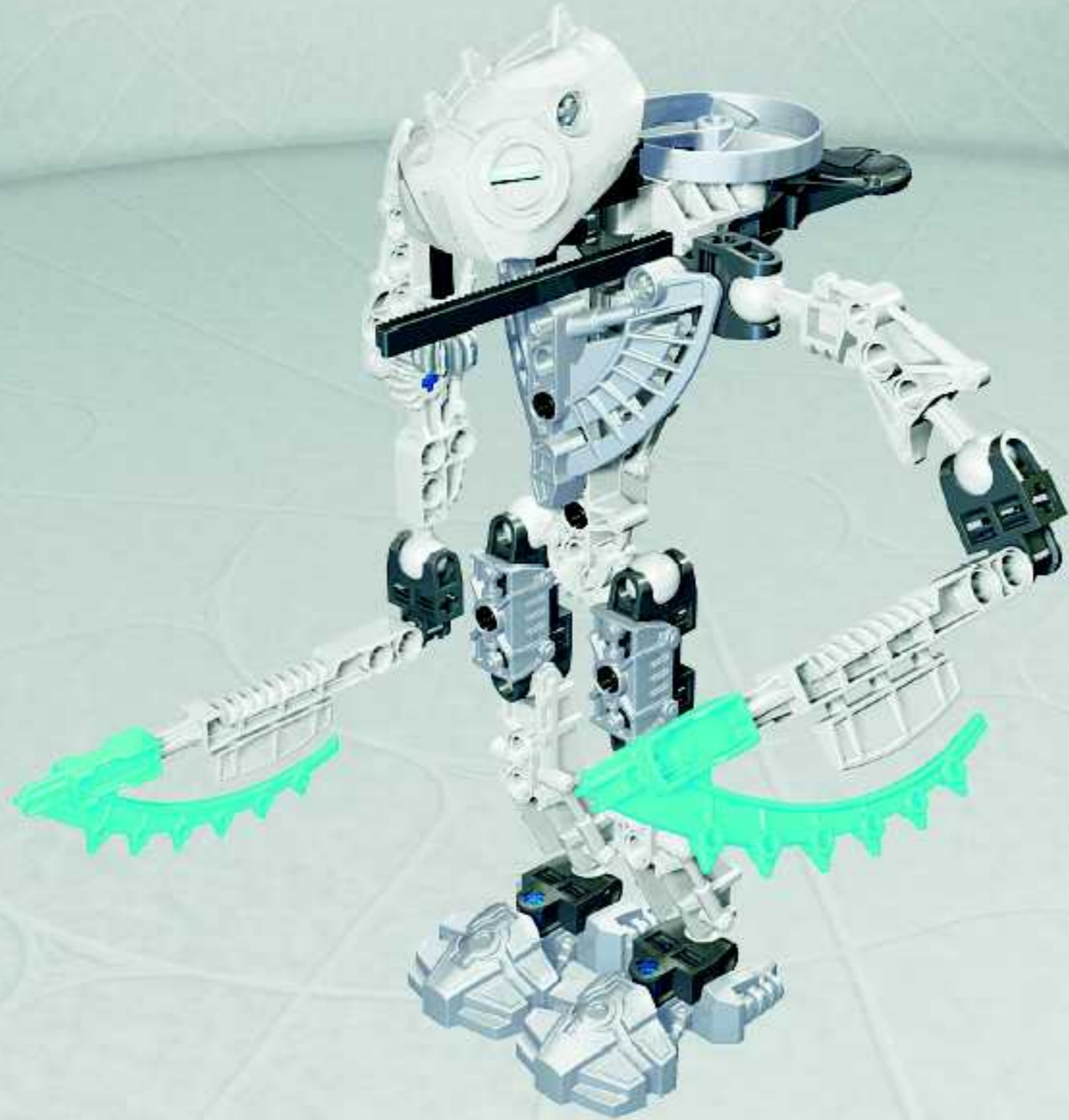



8737



8741



6

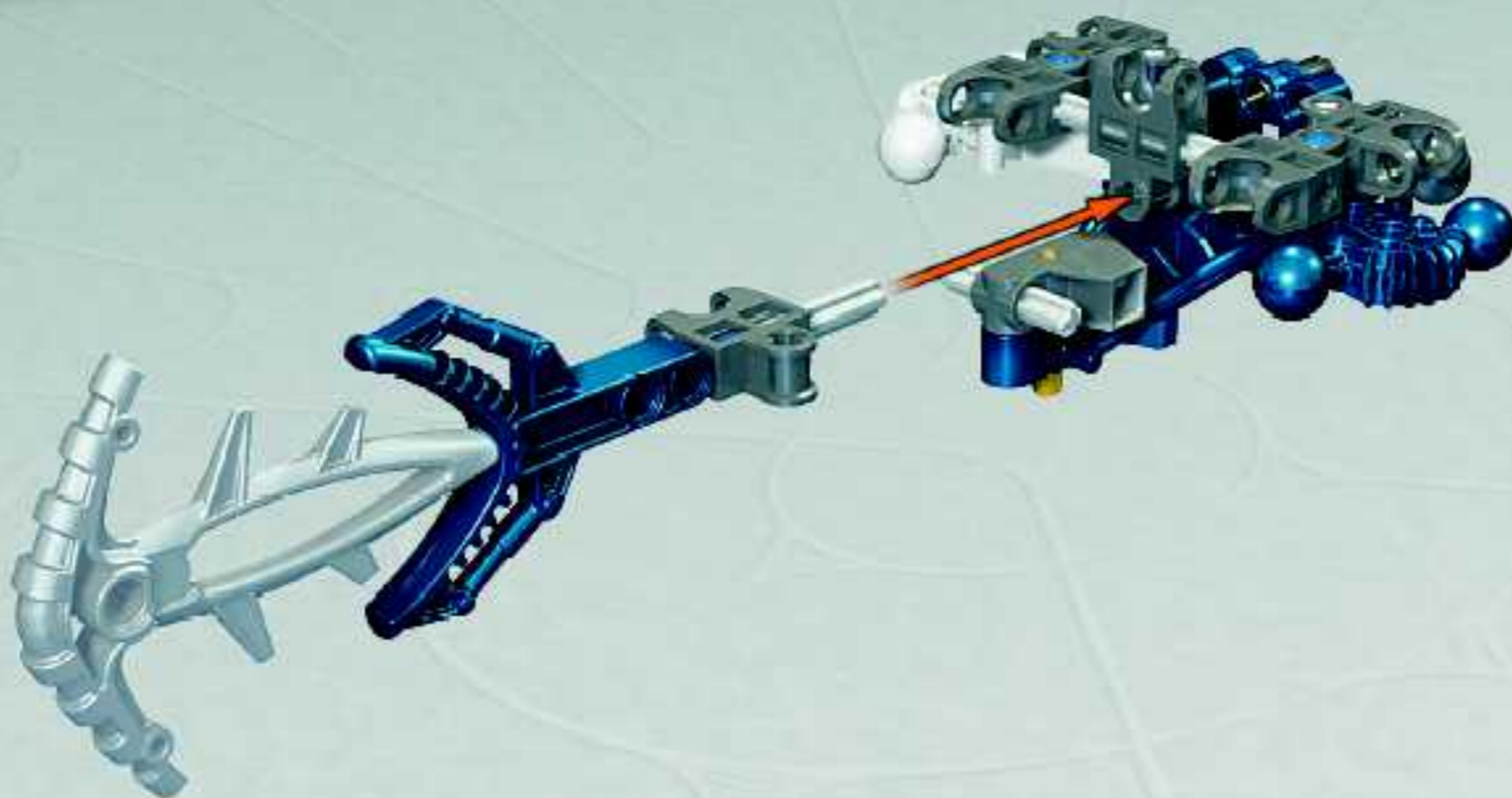

7

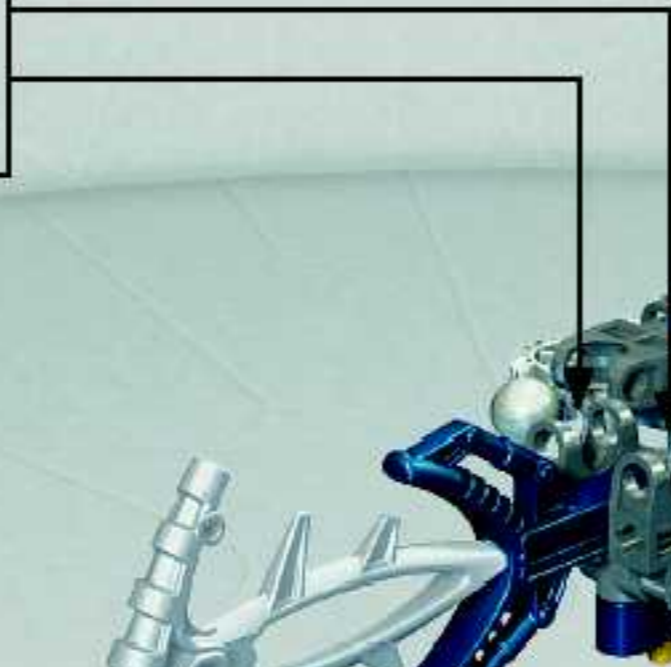

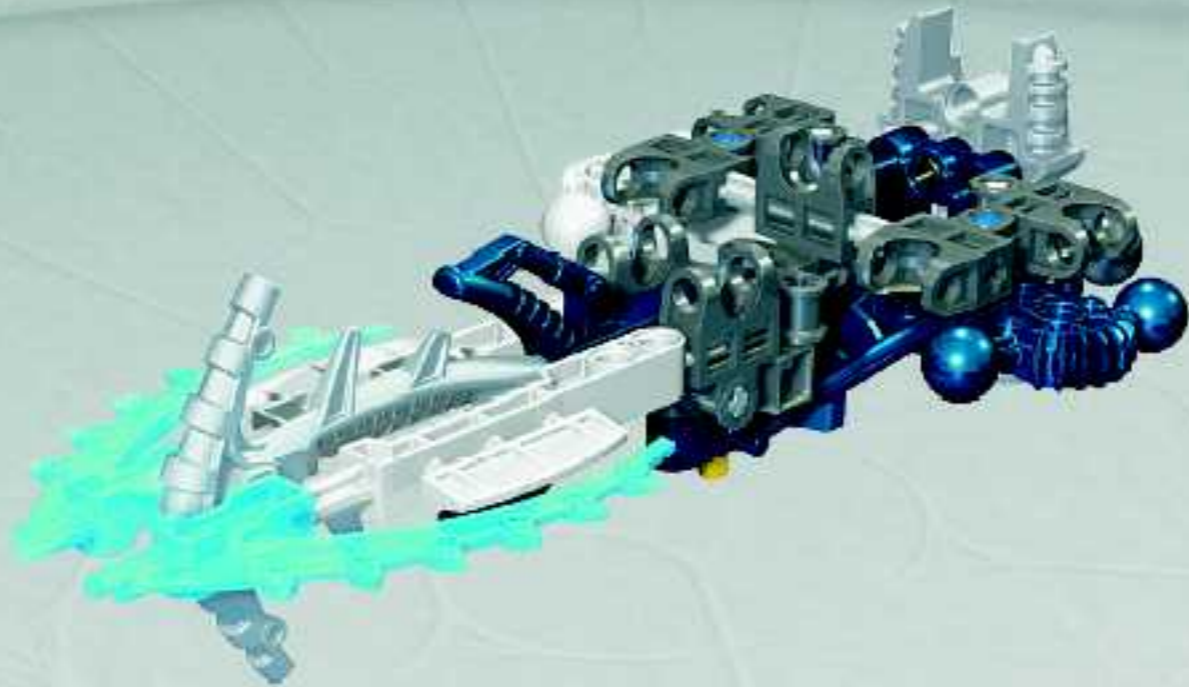

1

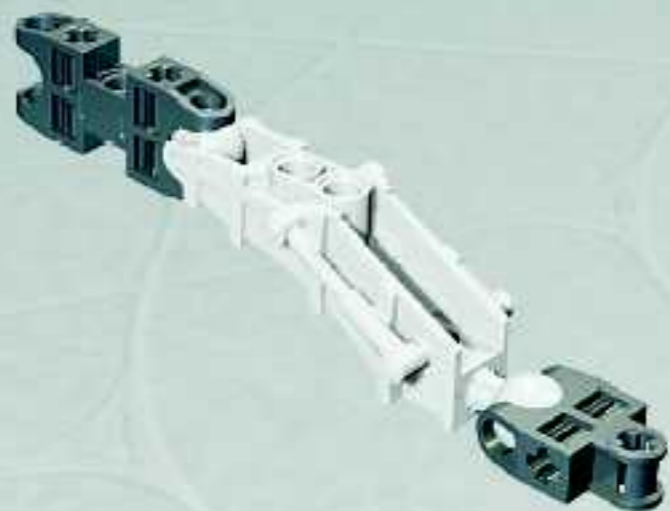

2



3

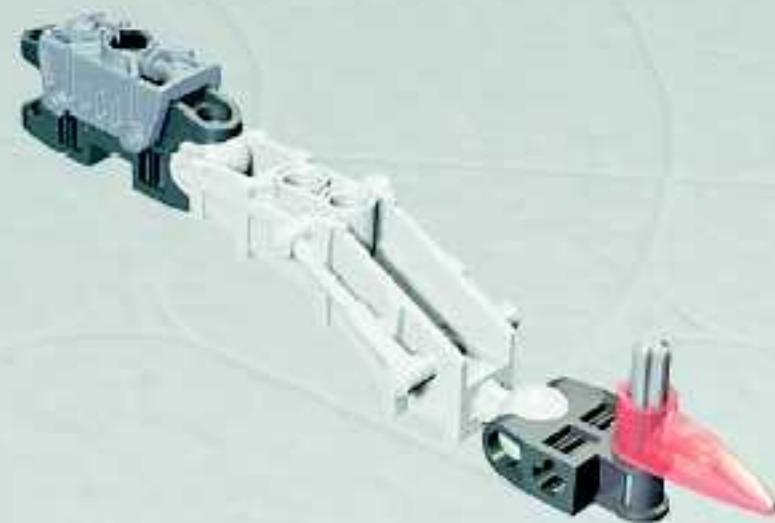

2x



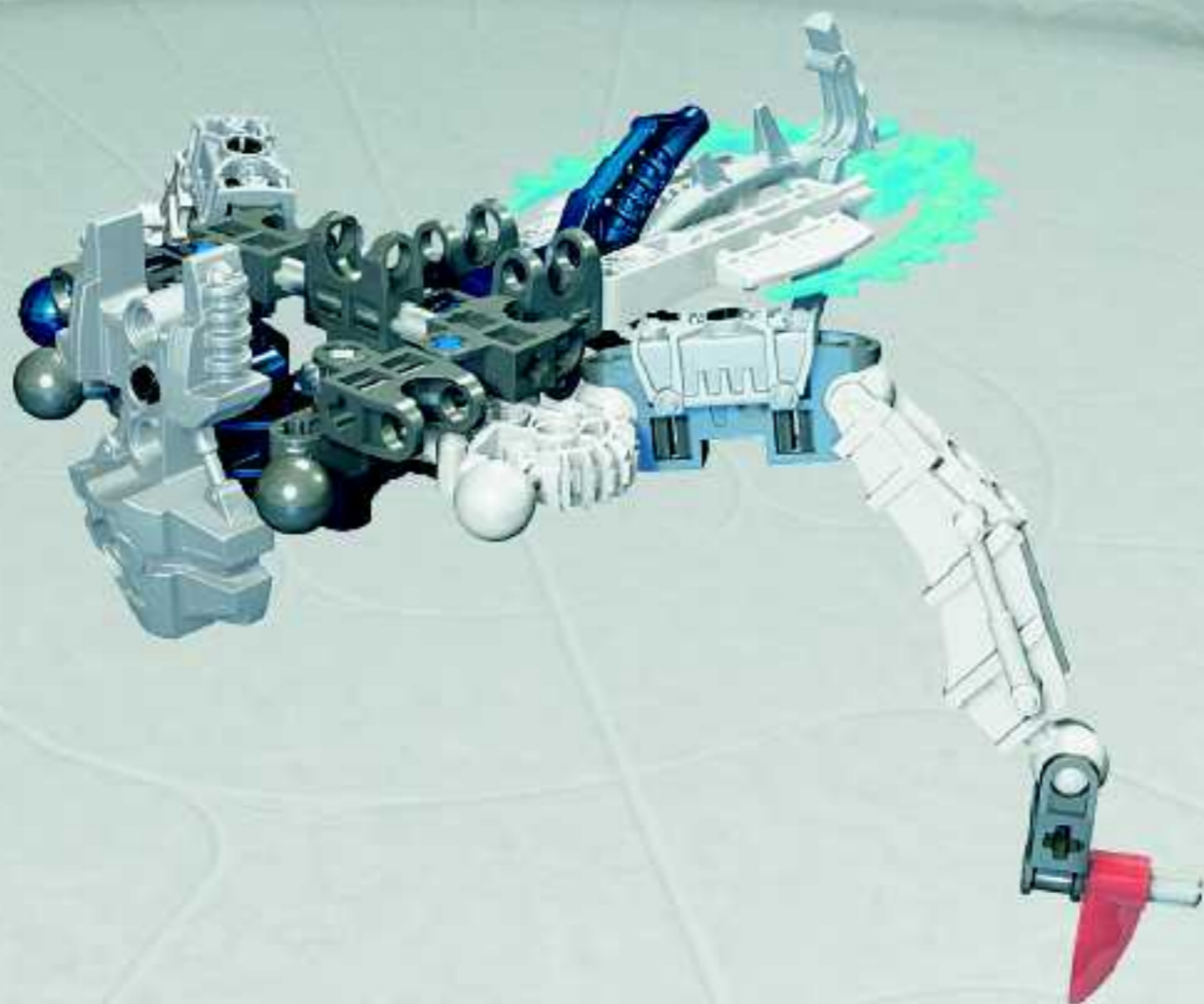

1

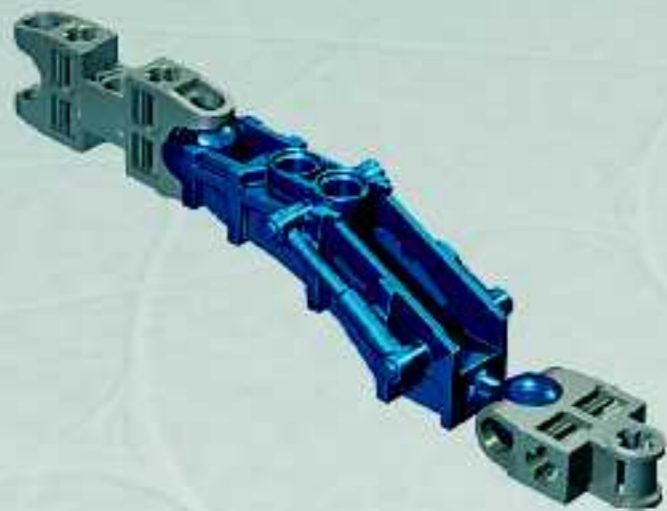

2



3

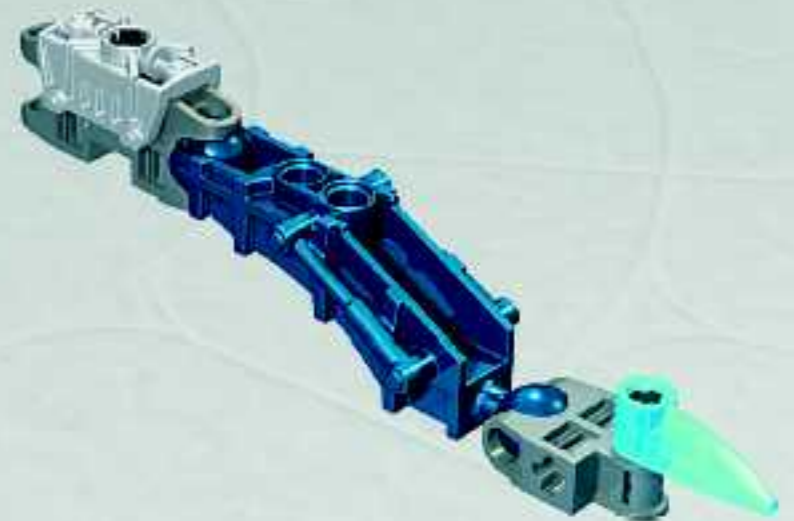

2x







Kanoka Club Code
www.bionicle.com

K04 +





TOA HORDIKA
ΒΑΚΑΜΑ
8736



TOA HORDIKA
ΝΟΚΑΜΑ
8737



TOA HORDIKA
WHENUA
8738

TOA HORDIKA
ONEWA
8739



TOA HORDIKA
MATAU
8740

TOA HORDIKA
NUJU
8741



VAHKI
KEERAKH
8619



VAHKI
VORZAKH
8616

VAHKI
PUURAKH
8614



VAHKI
RORZAKH
8618

VAHKI
BORDAKH
8615

VAHKI
ZADAKH
8617



RAHAGA
POUKS
4869



RAHAGA
IRUINI
4879



RAHAGA
BOMONGA
4878



RAHAGA
KUALUS
4870



RAHAGA
GAAKI
4868



RAHAGA
NORIK
4877



Win! Gagne! Gewinne! 当たります



WIN LEGO® PRODUCTS

We would like to know what you think about our new LEGO® product. If you could help us by answering a few questions you are in with a chance of winning an exciting LEGO prize. It will only take you about 3 minutes! Log on to the web address below for further instructions.

We would really like to hear what you think about your new LEGO product. If you'd like to help us, go to the web address below for further instructions.



Estimado usuario LEGO®

Al contestar algunas preguntas en inglés, francés, alemán o japonés, en el sitio www.acnielsen.aim.dk/lego, podrás participar en el sorteo de algunos valiosos premios LEGO®.



英語でレゴ®製品が当たります

私たちは、皆さんが新しいレゴ®製品についてどんな感想をお持ちか、知りたく思っています。質問に答えて、新しいレゴ®製品の抽選に参加できるチャンス。アンケートの回答では、皆さんの名前とレゴ®の住所は、決して、以下ウェブアドレスまでアクセスしていただき、



GAGNE DES PRODUITS LEGO®

Nous aimerions savoir ce que tu penses de ton nouveau produit LEGO®. Si tu veux bien nous aider en répondant à quelques questions, tu recevras peut-être bientôt un fantastique prix LEGO. Et cela ne te prendra que 3 minutes environ ! Tu obtiendras davantage d'informations en visitant le site Internet indiqué ci-dessous.

Nous aimerions savoir ce que tu penses de ton nouveau produit LEGO. Si tu souhaites nous aider, rends-toi à l'adresse Internet ci-dessous où tu trouveras des instructions supplémentaires.



Caro Consumidor da LEGO®

Ao responder a algumas perguntas em Inglês, Francês, Alemão ou Japonês no endereço www.acnielsen.aim.dk/lego irá participar num concurso para ganhar valiosos prémios da LEGO®.



GEWINNE LEGO® PRODUKTE

Wir sind sehr an deiner Meinung über dein neues LEGO® Produkt interessiert. Wenn du uns den Gefallen tust und ein paar Fragen beantwortest, kannst du einen tollen LEGO Preis gewinnen. Das Ganze dauert nur etwa 3 Minuten! Gehe einfach zu der unten angegebenen Webadresse - dort findest du weitere Informationen.

Wir möchten gerne wissen, was Sie von Ihrem neuen LEGO Produkt halten. Wenn Sie uns helfen möchten, besuchen Sie bitte die u.a. Website, auf der Sie alles Weitere erfahren.



Kedves Új LEGO® Vásárló

Ha ellátogat az www.acnielsen.aim.dk/lego honlapra és ott angol, francia, német vagy japán nyelven megválaszol az néhány kérdést, akkor részt vehet egy versenyben, amelyben értékes LEGO® díjakat nyerhetsz.

www.acnielsen.aim.dk/LEGO



LEGO, the LEGO logo, the CLICKITS logo and BIONICLE are trademarks of the LEGO Group.
©2005 The LEGO Group.
Ferrari, all associated logos and the distinctive designs are trademarks of Ferrari S.p.A.
The body of the Ferrari car is protected as Ferrari property under trade dress and/or design regulations.



NIDHIKI
8622



TURAGA DUME
& NIVAWK
8621



KREKKA
8623

©2005 The LEGO Group 4275692



www.bionicle.com

