



World Racers

8898



LEGO 3

1

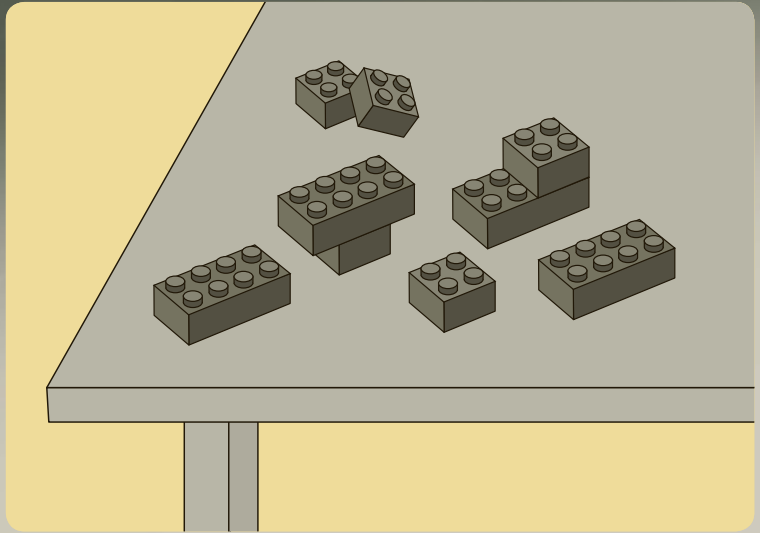
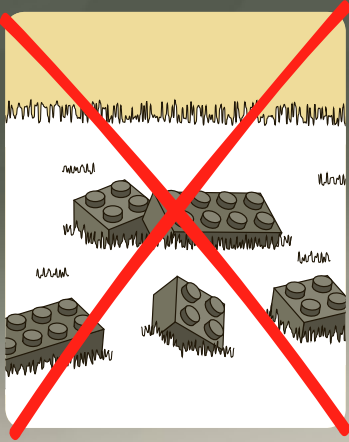

2

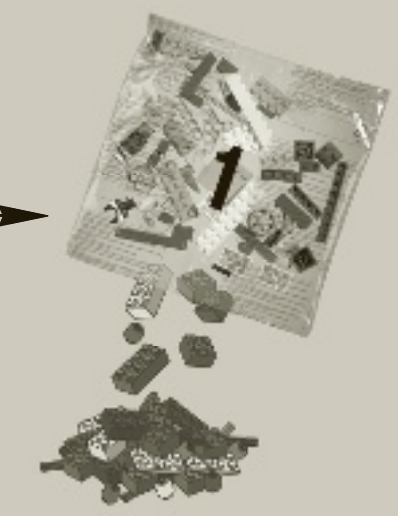

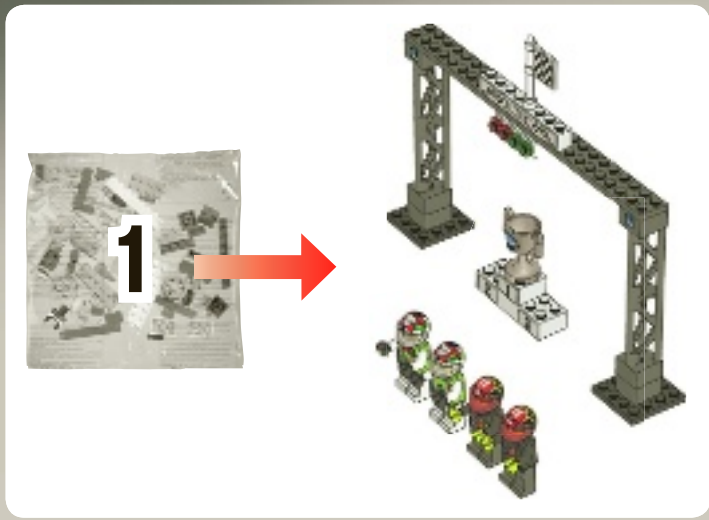

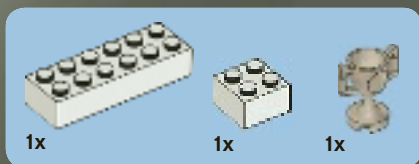

1

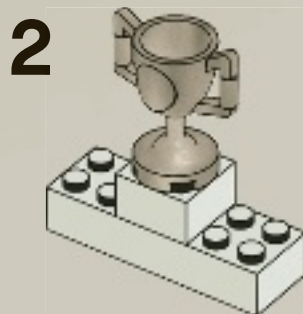
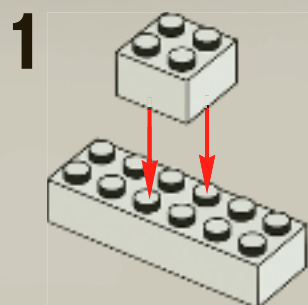

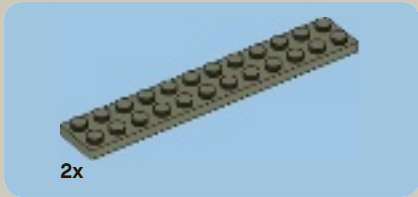
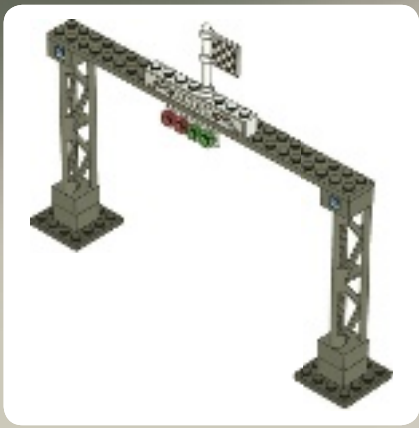

1

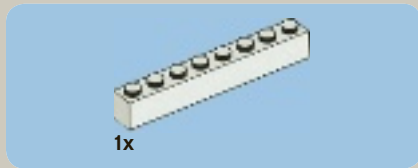
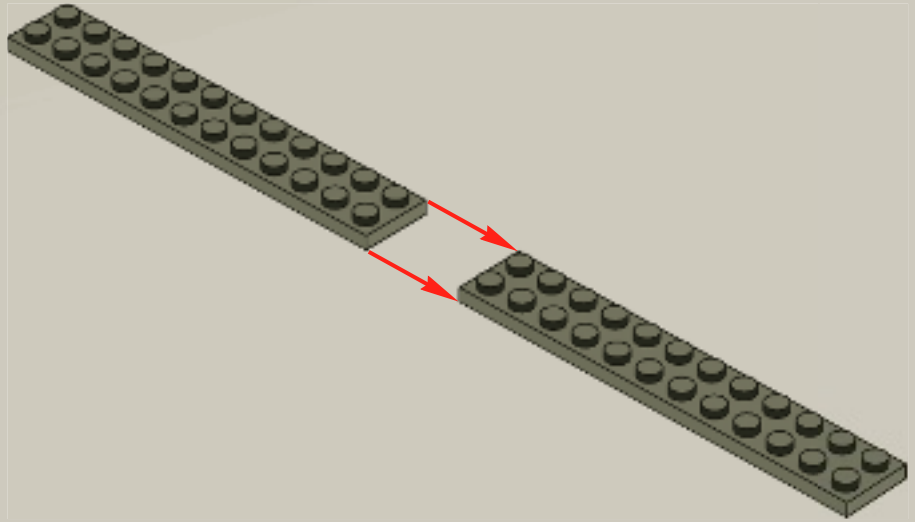

2

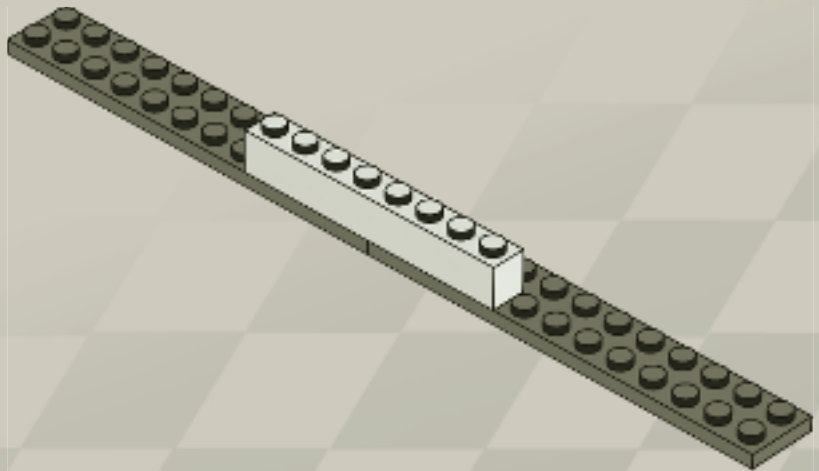

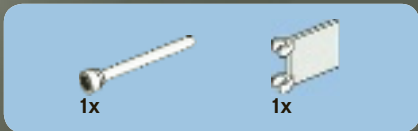

3

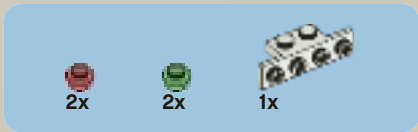
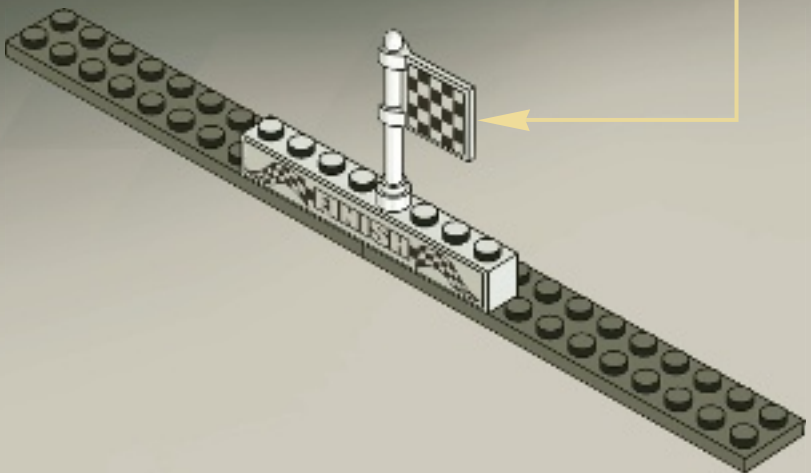
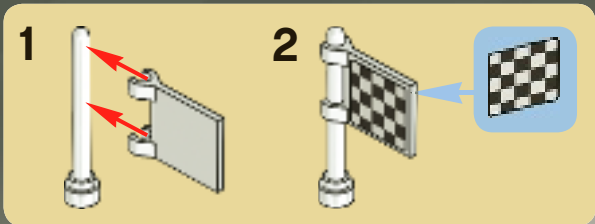

4

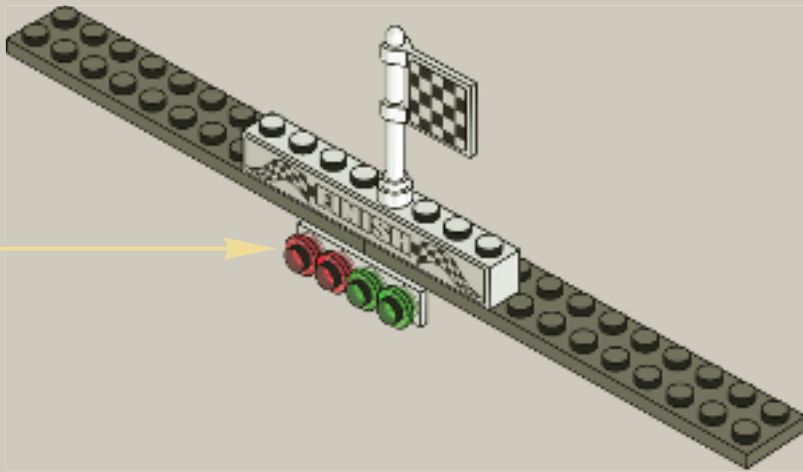

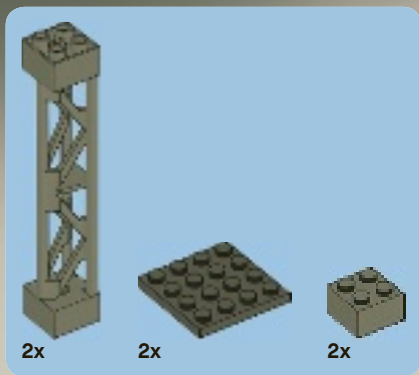

5

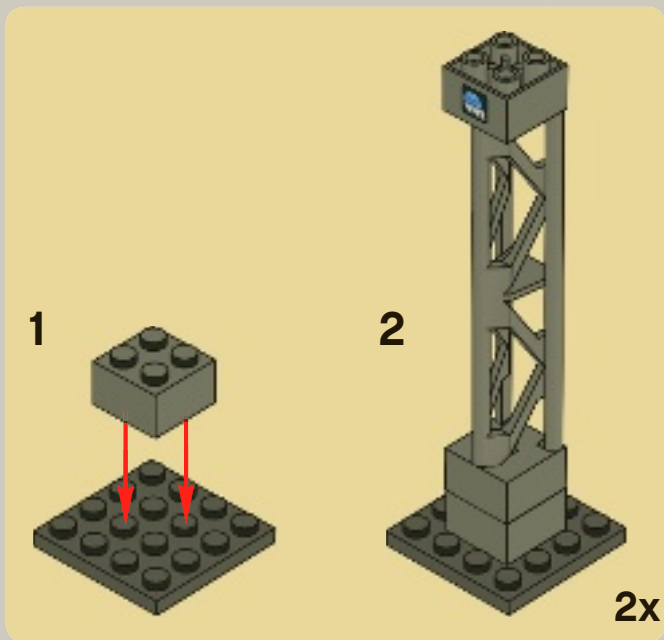
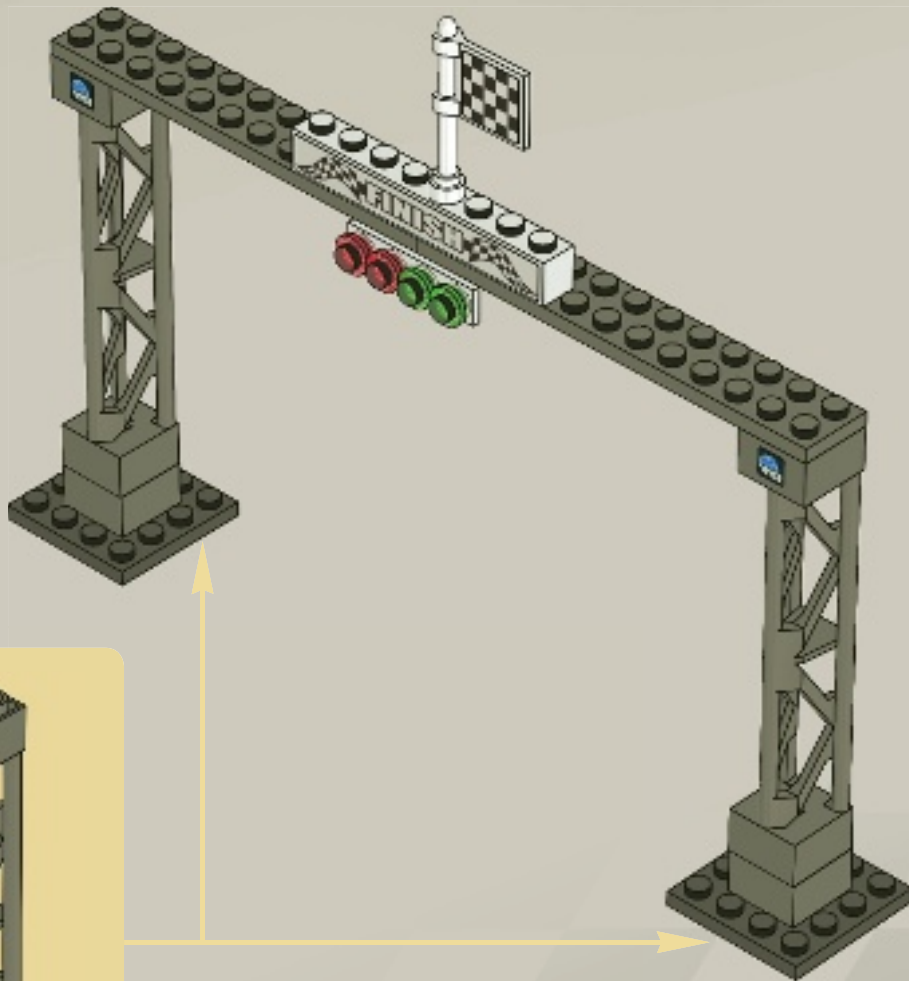

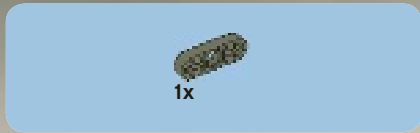

1



2

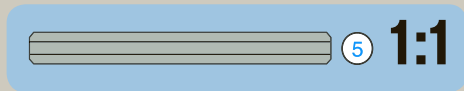
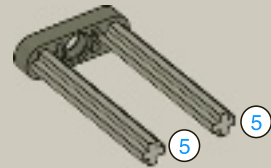



3

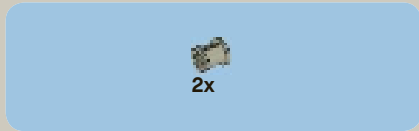
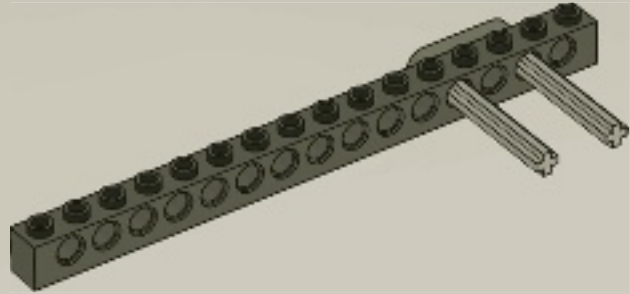

4





5

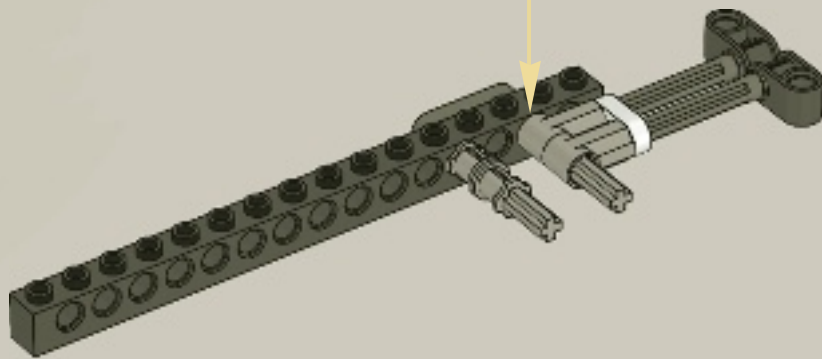
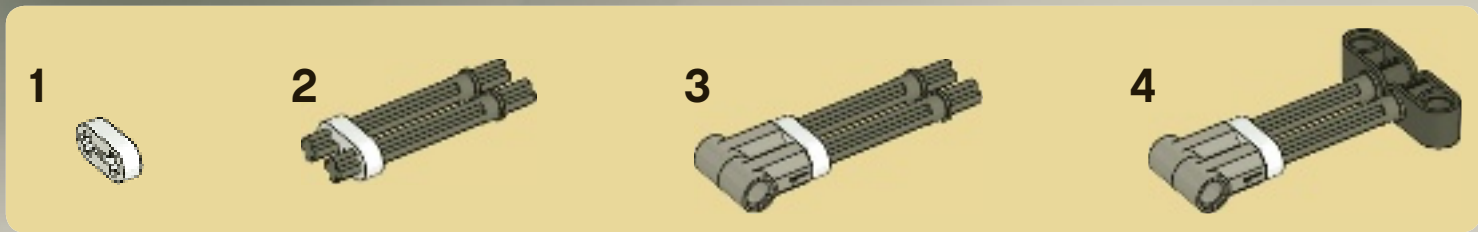

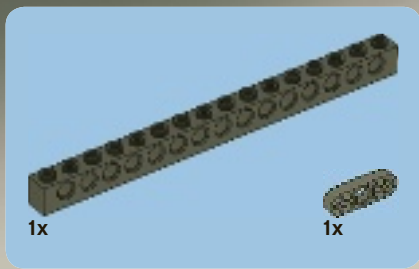

6

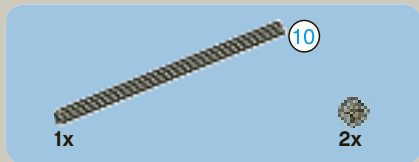
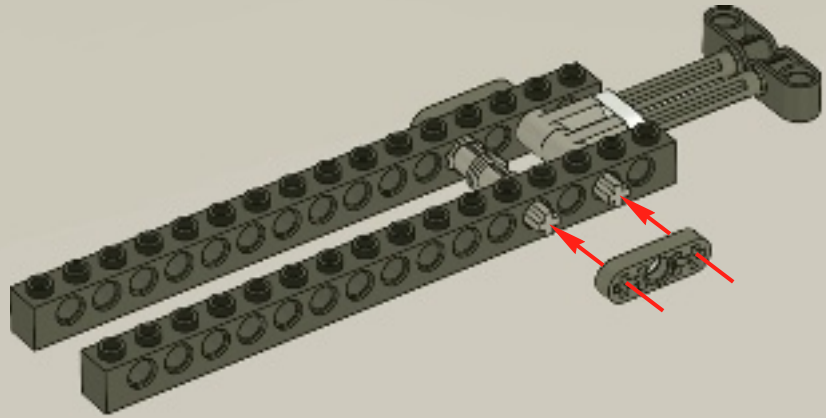

7

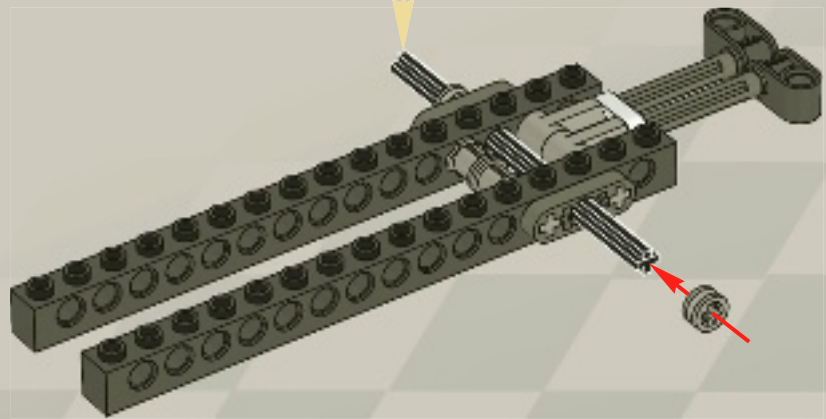
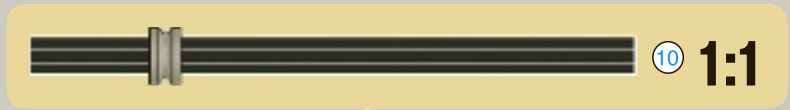

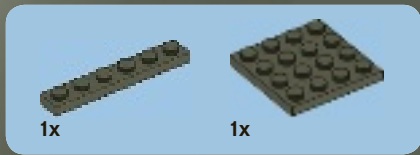

8

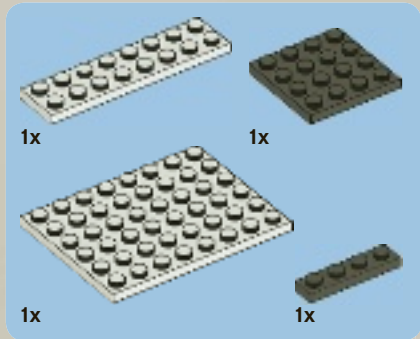
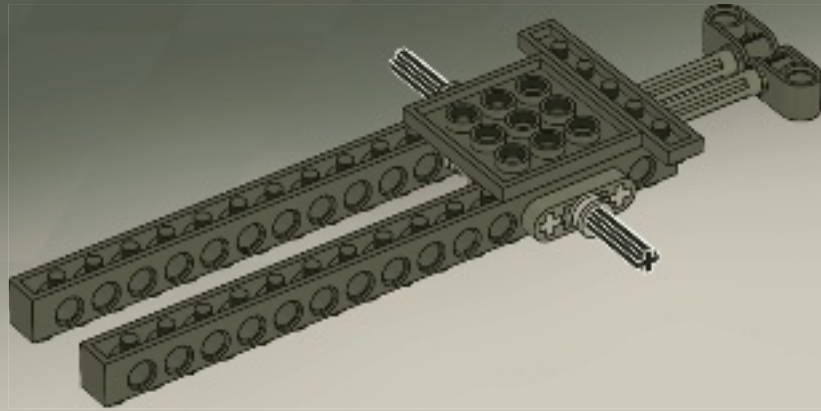

9

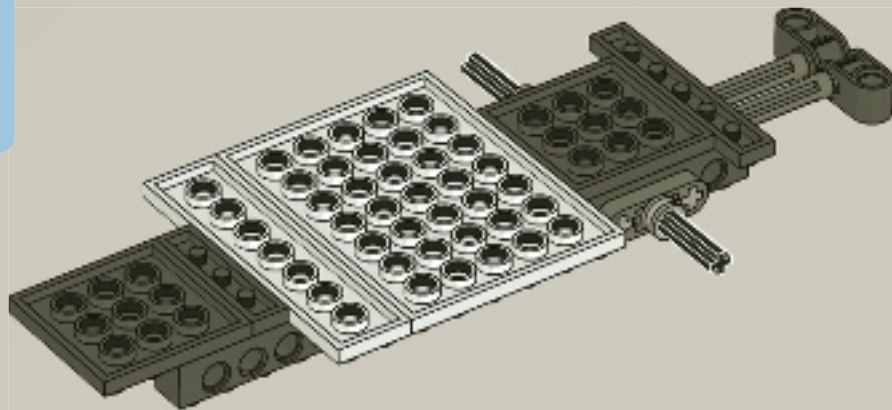

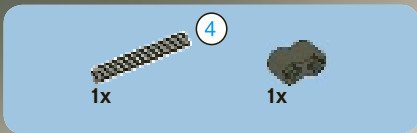

10

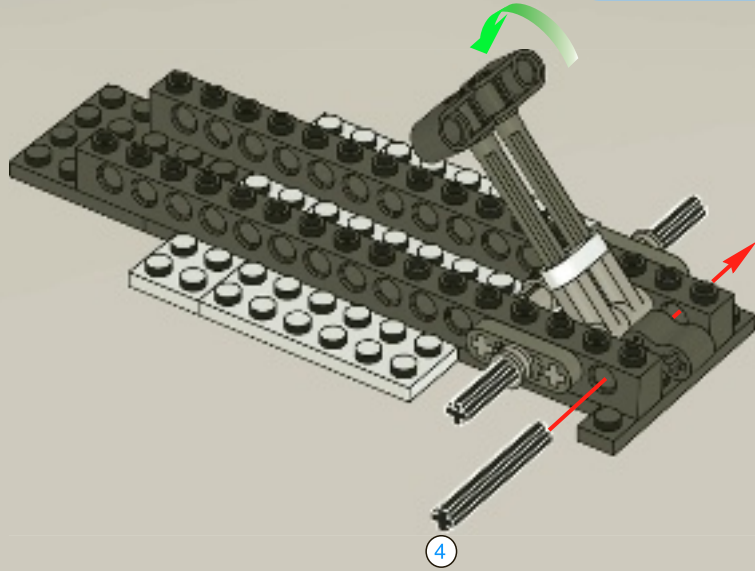

11

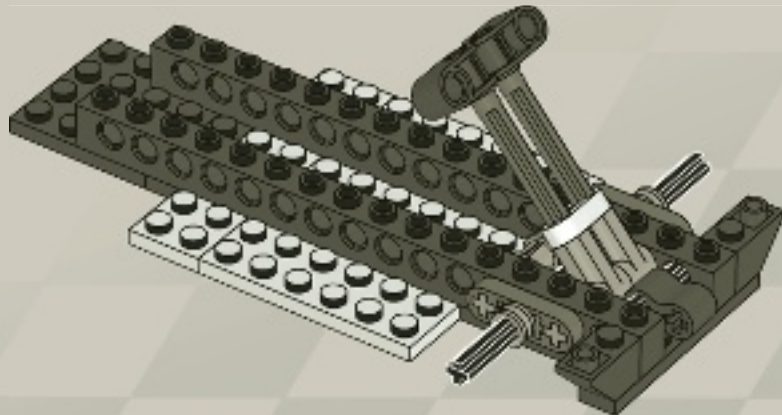



2x



1x

12

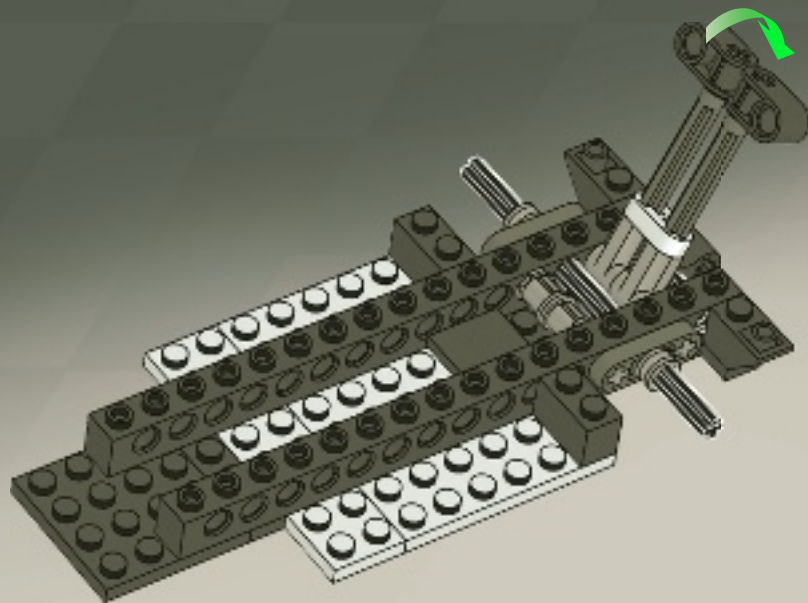

1x



2x



2x

13

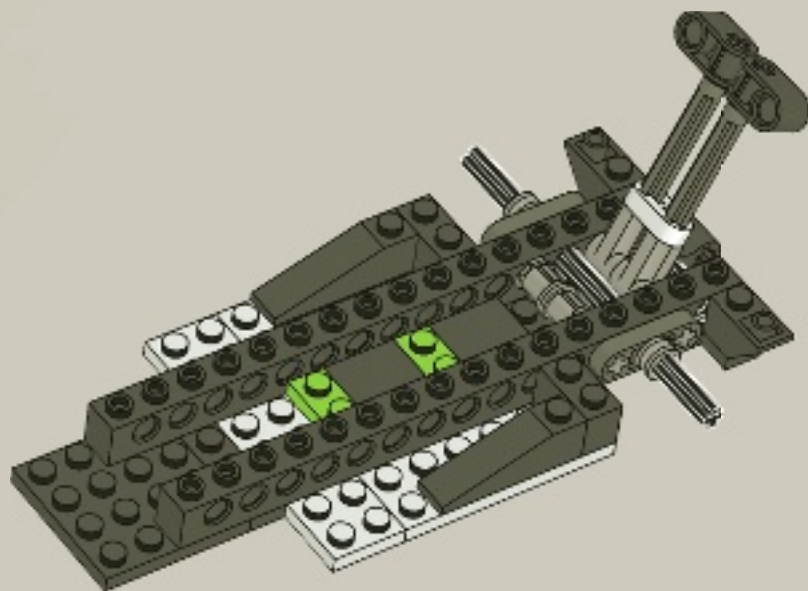



1x



1x

14

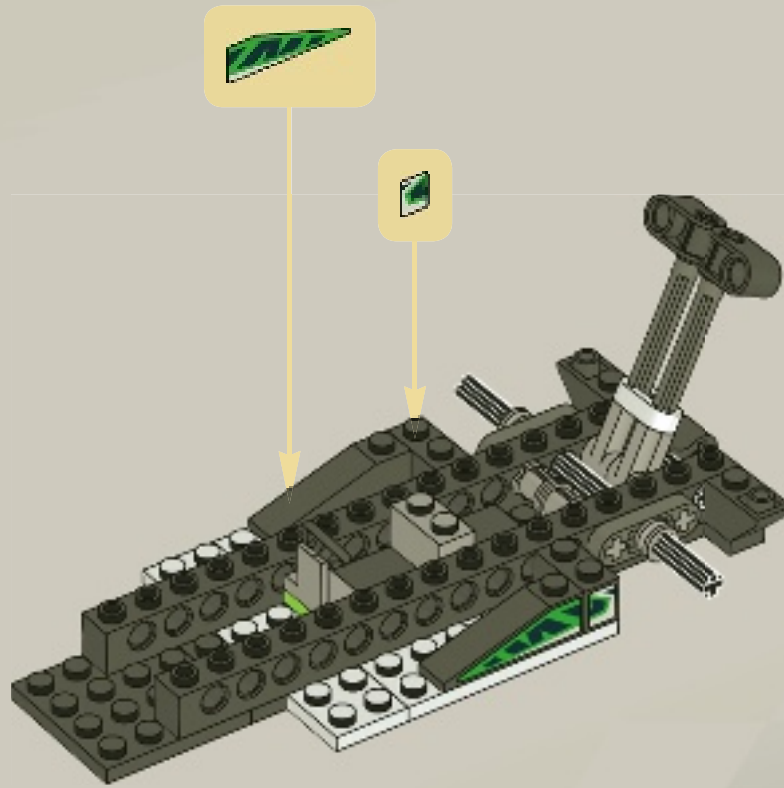



4x



1x



1x

15

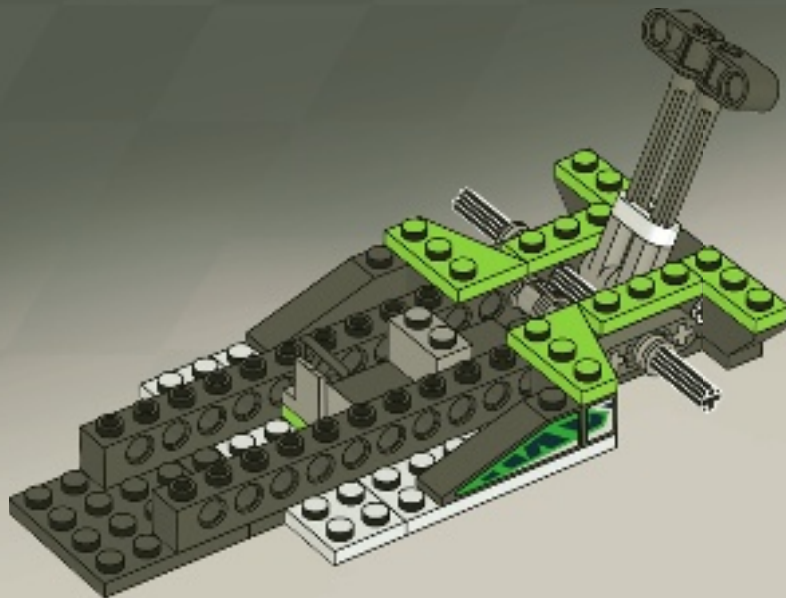





2x

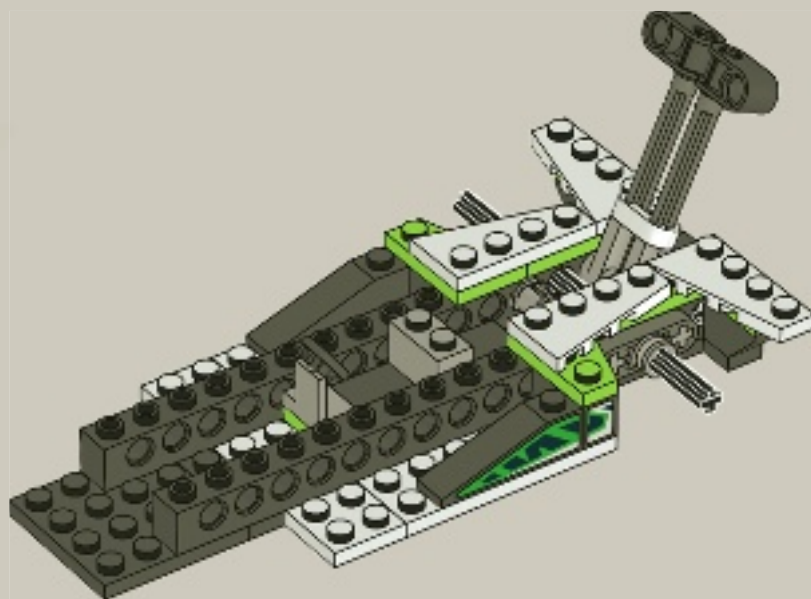

2x





16



 2x
 2x
 2x

 3
1:1

19

1  
 2  
 2x

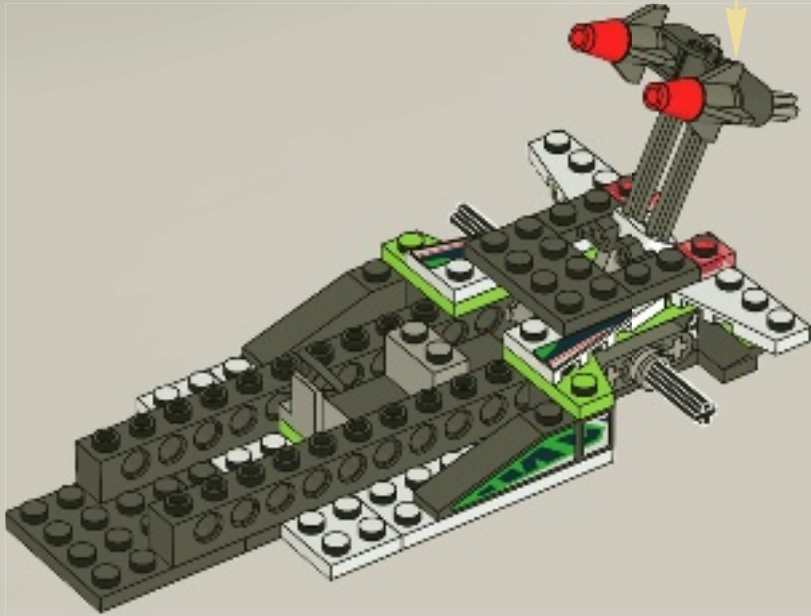



20

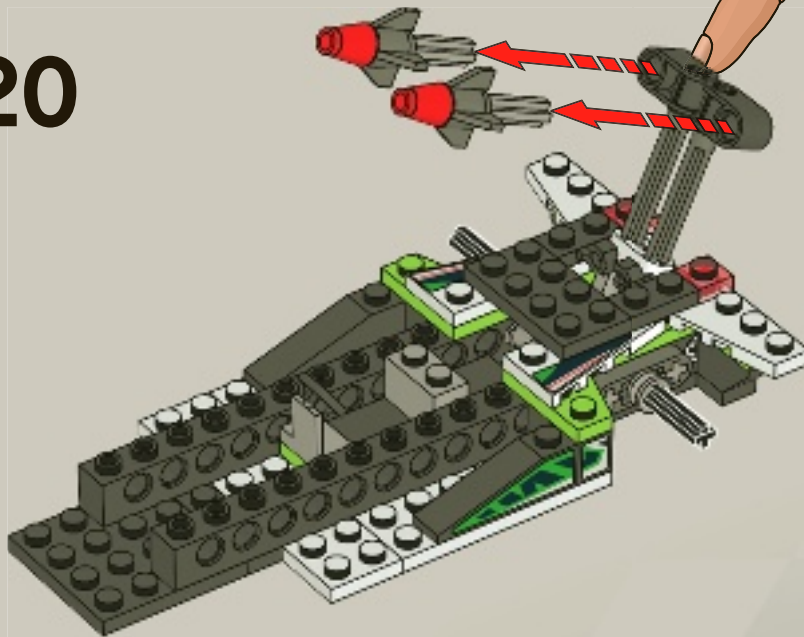



2x



1x

21

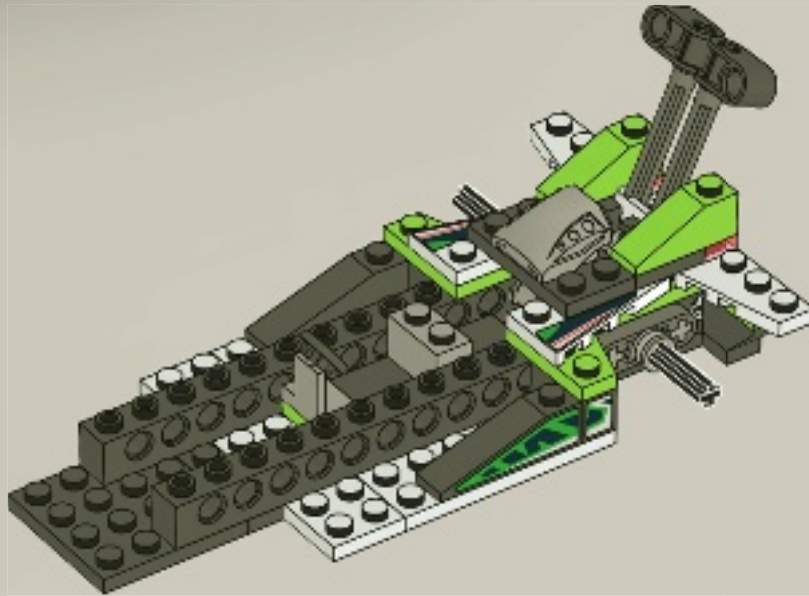



2x



2x

22



2x

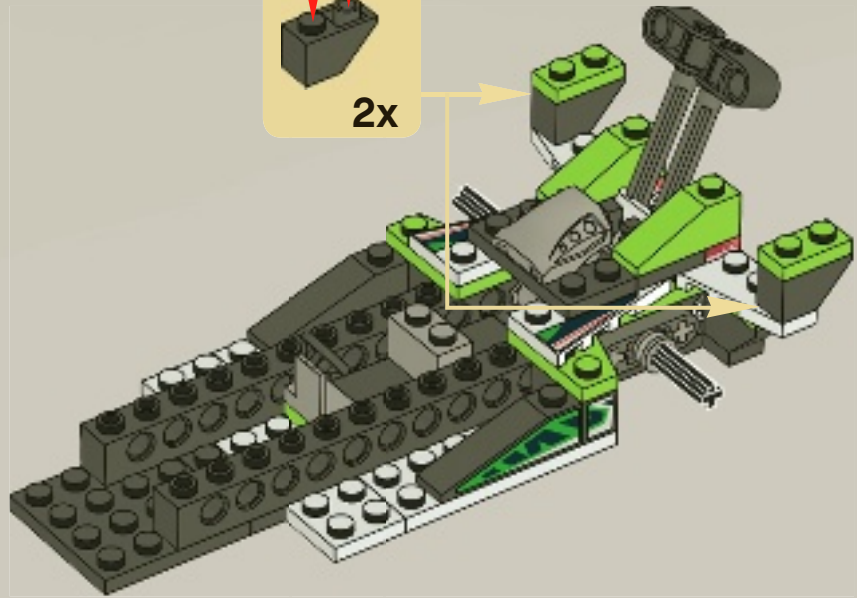

1x



1x

23

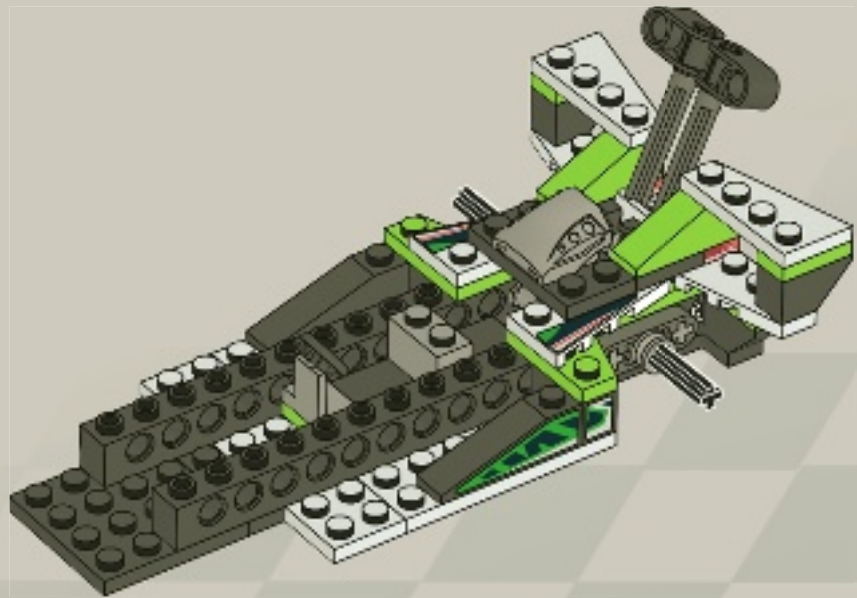

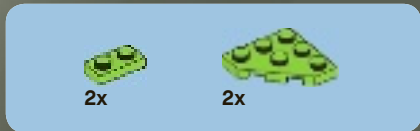

24

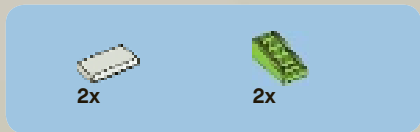
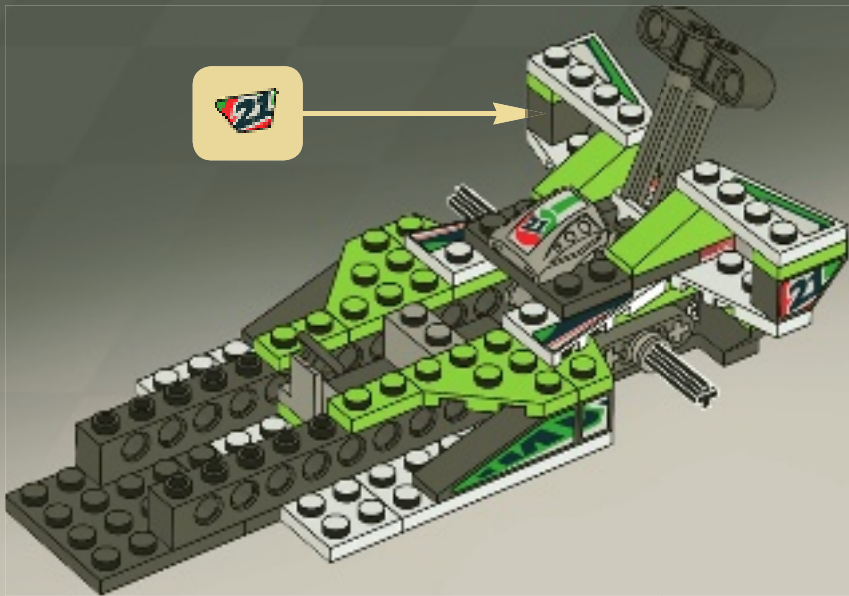

25

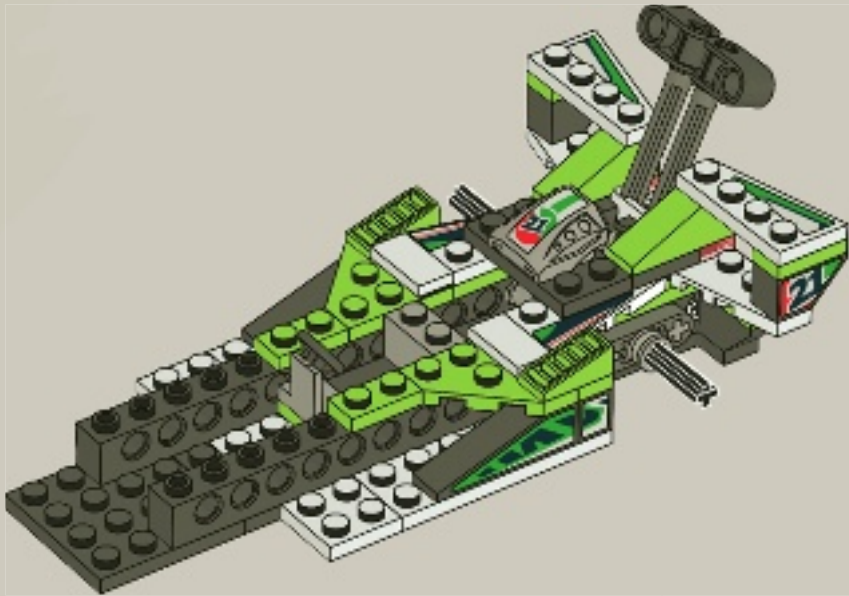



2x



1x

26

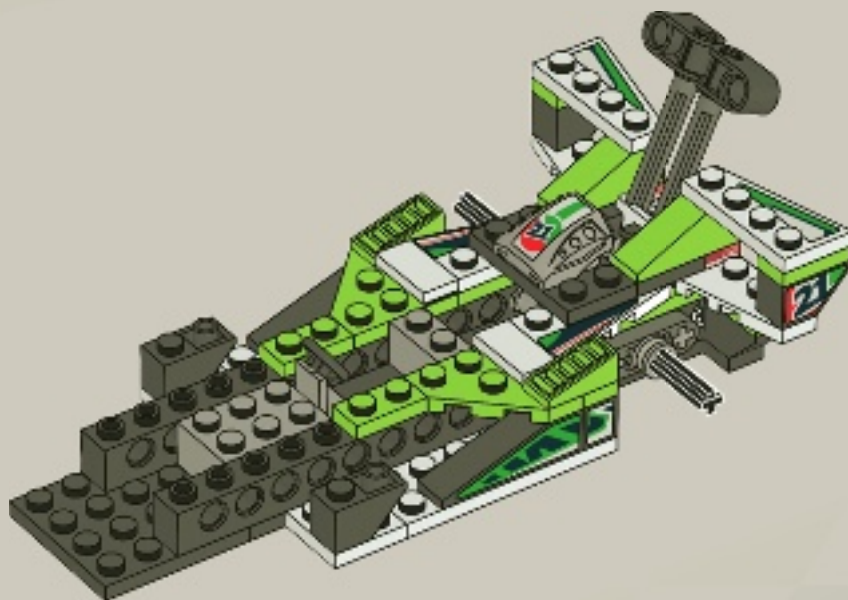

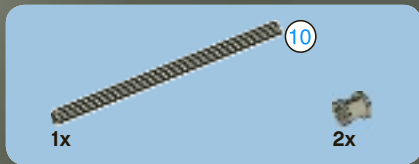

27

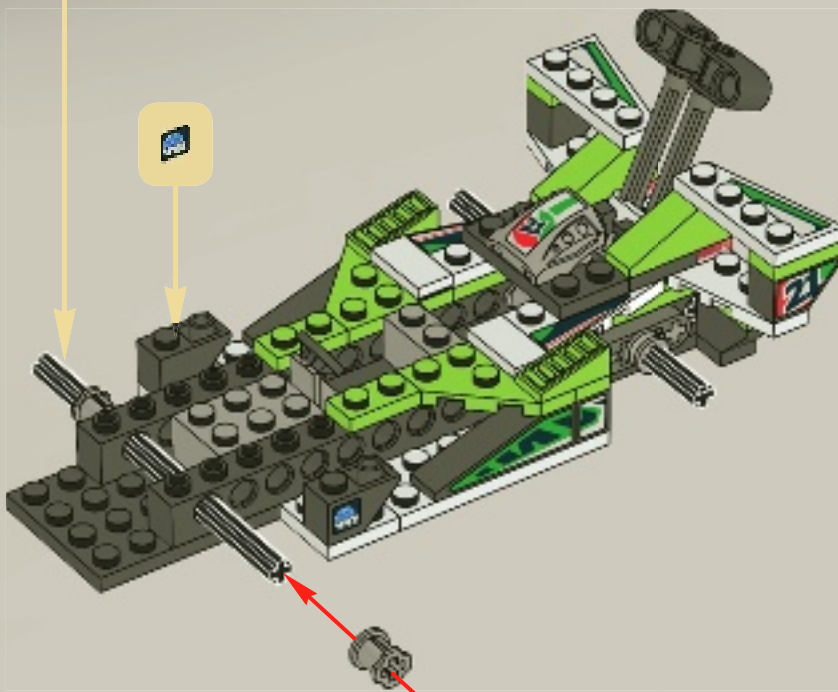
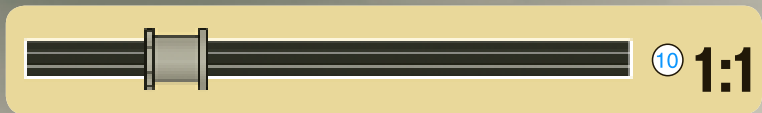

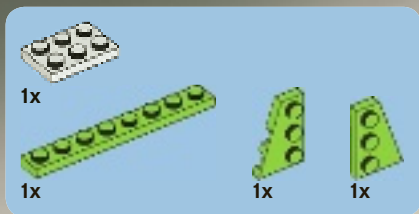

28

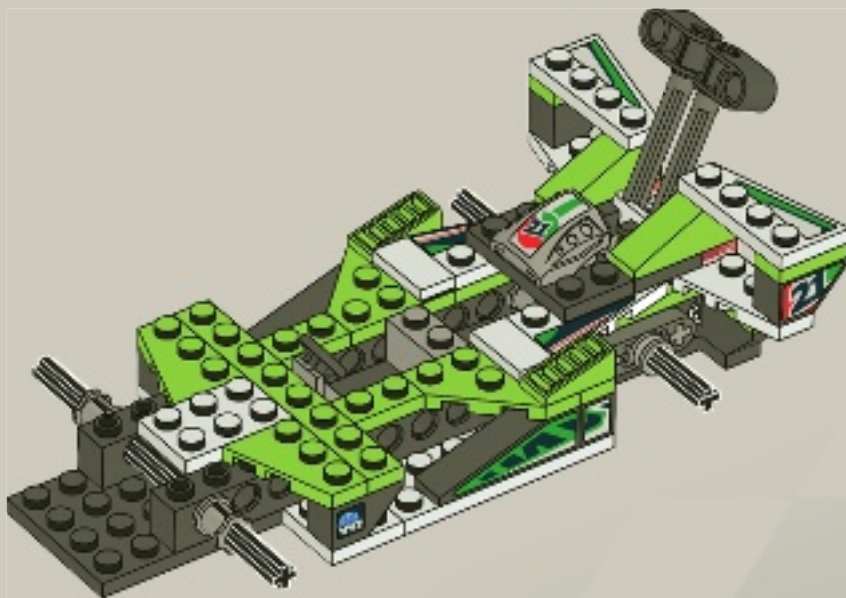

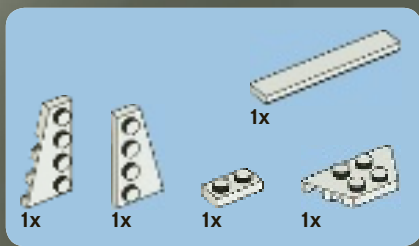

29

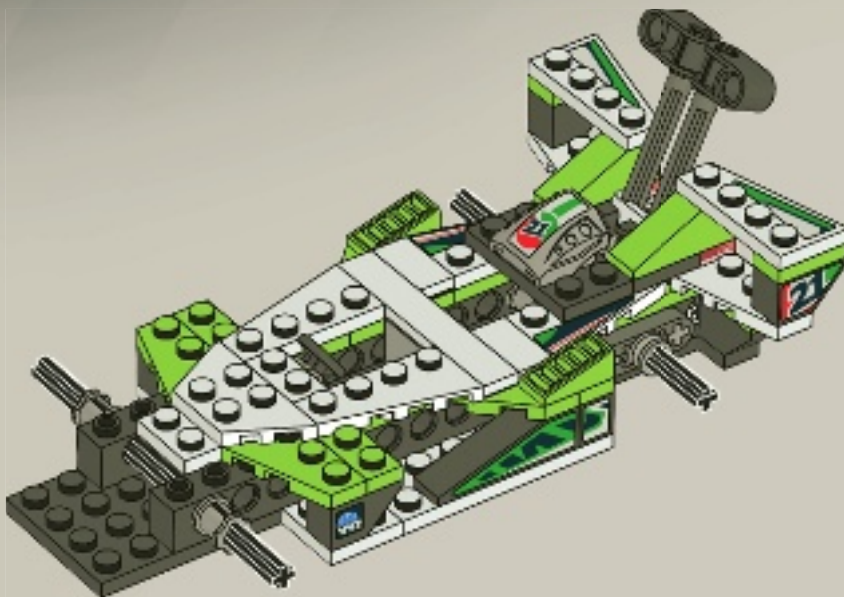



1x



2x

30

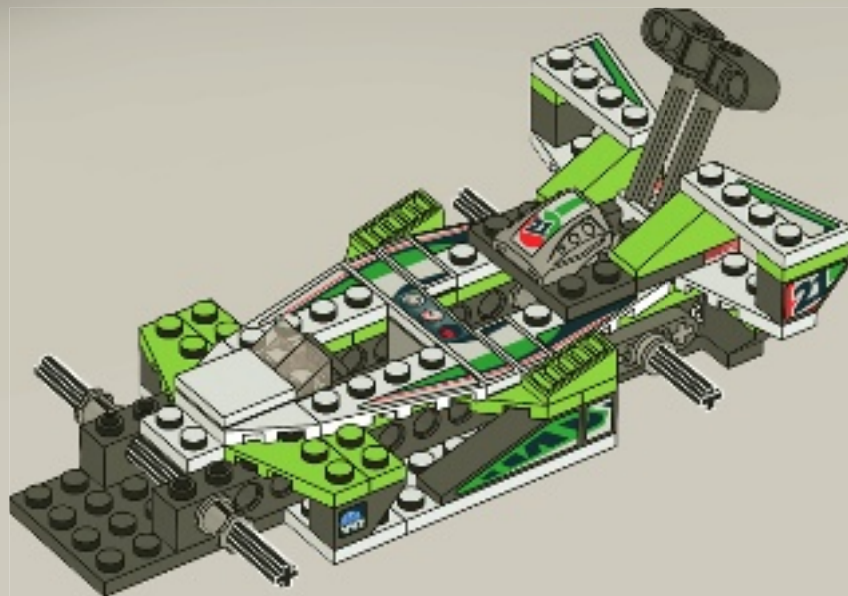

1x



1x



1x

31

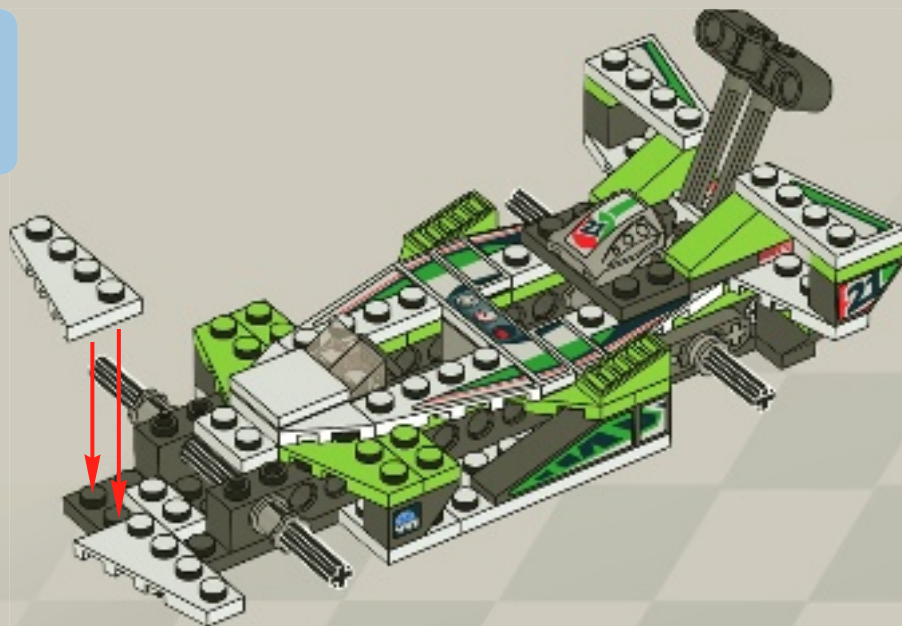



1x

32

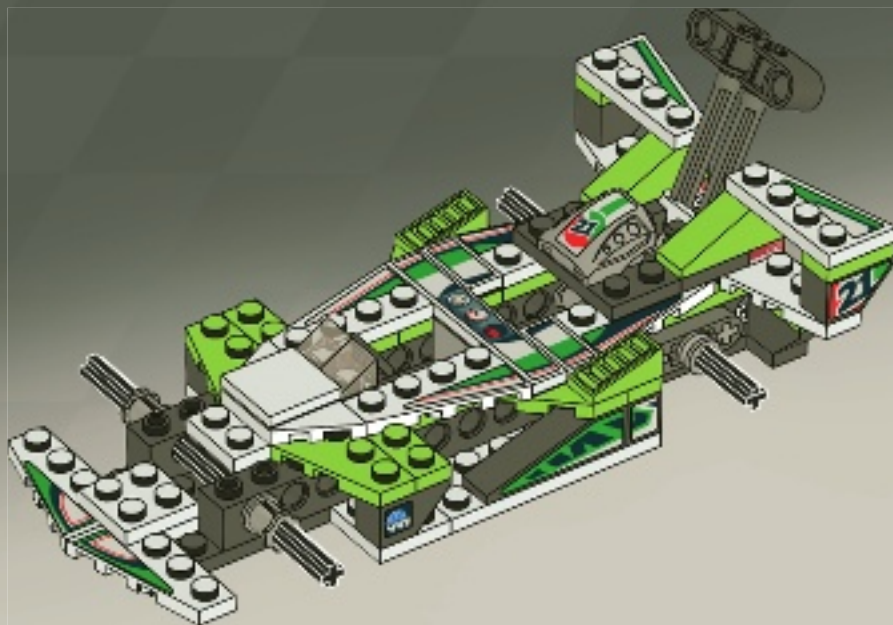

2x

33

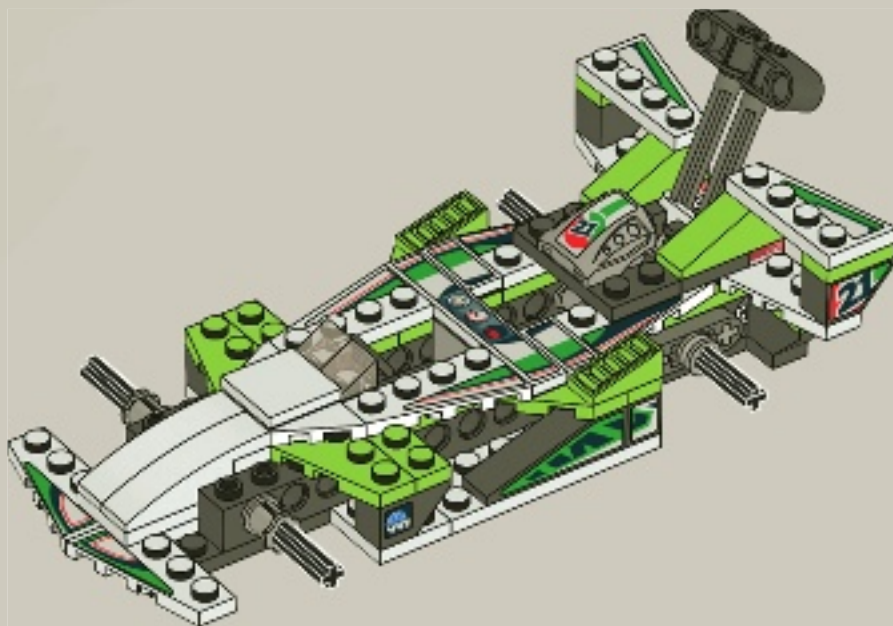



4x



4x

34

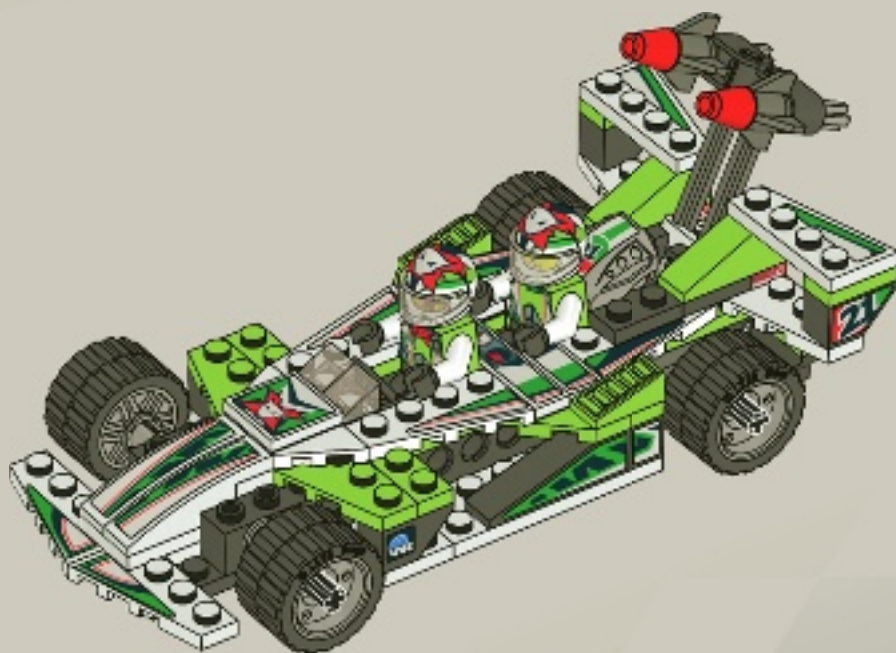



3



1x

1

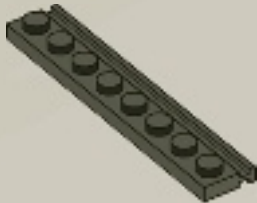

2x



1x

2

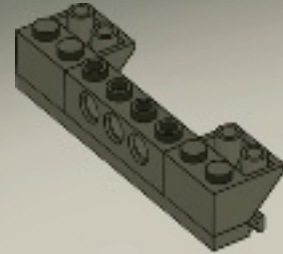

3





2x

4

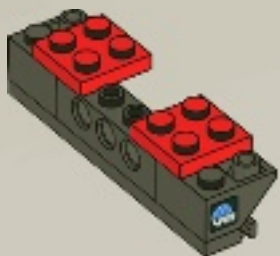

2x

5



2x

6

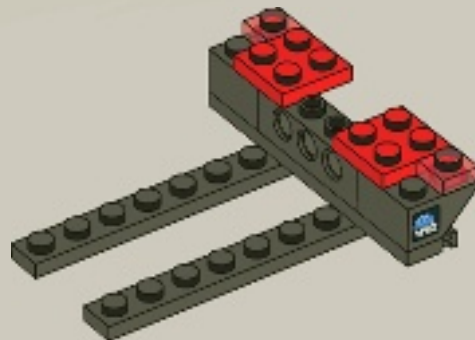

2x

7

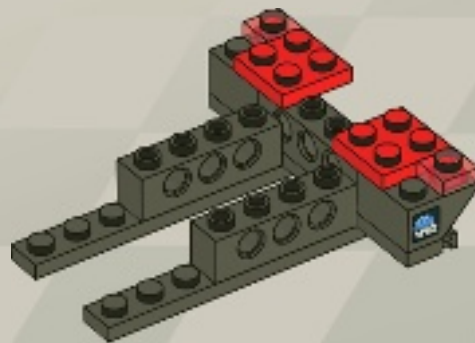

1x  2x 

8

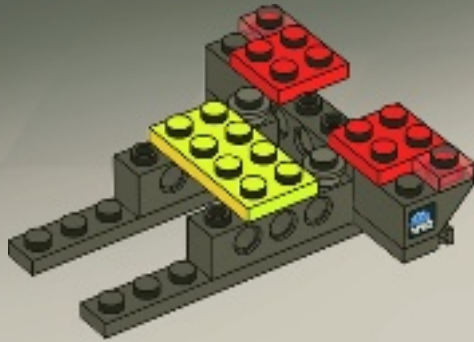

1x  2x 

9

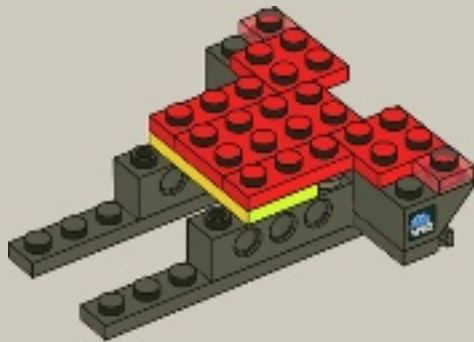

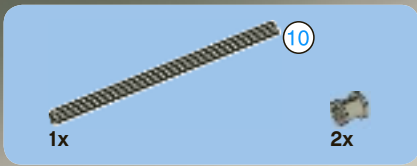

10

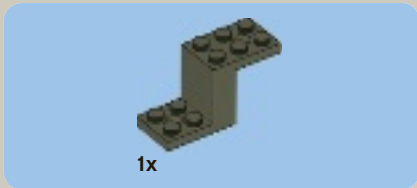
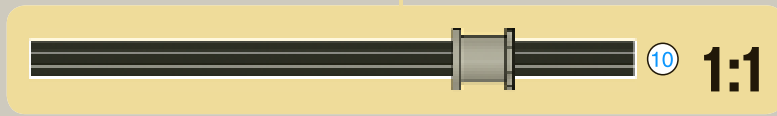
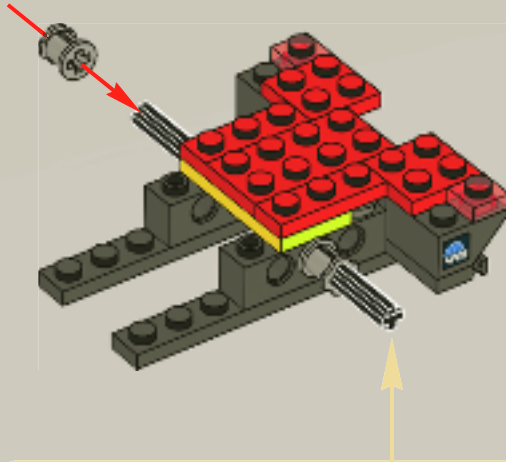

11

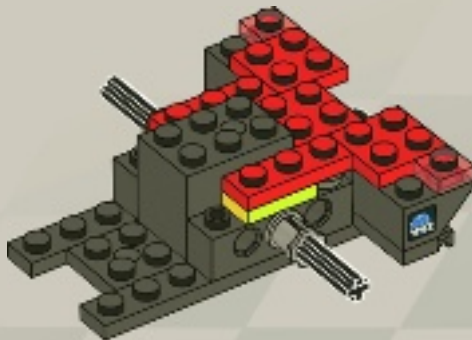

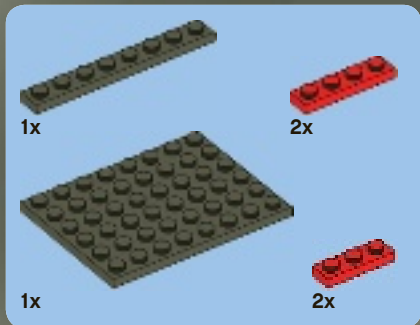

12

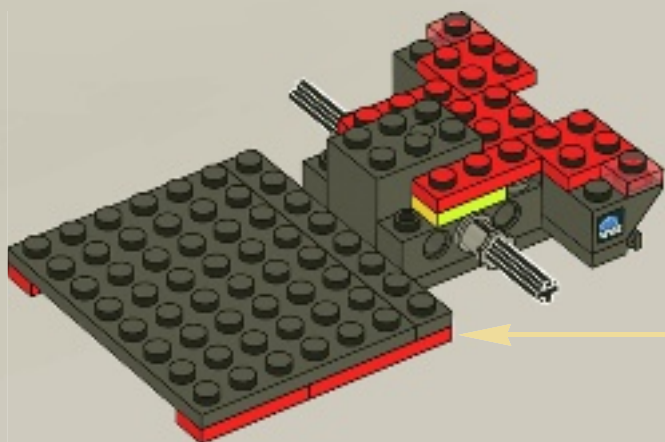

1

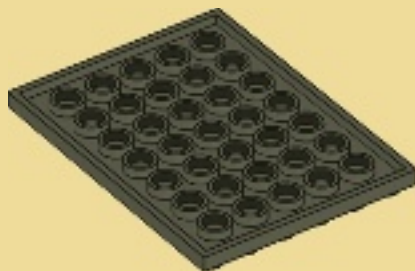

2

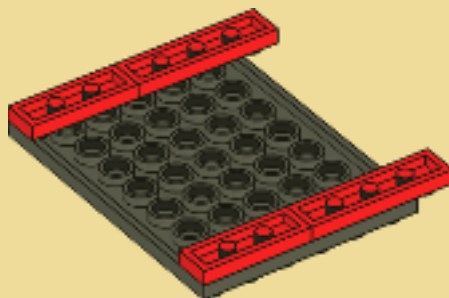

3

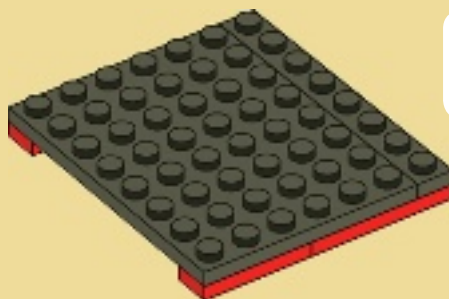



4x

13

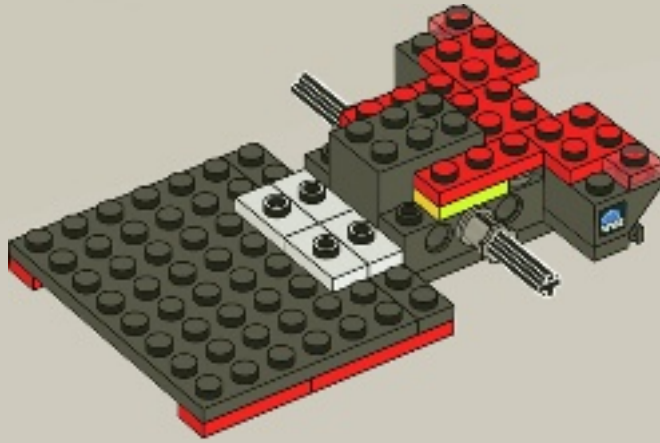

1x



2x

14

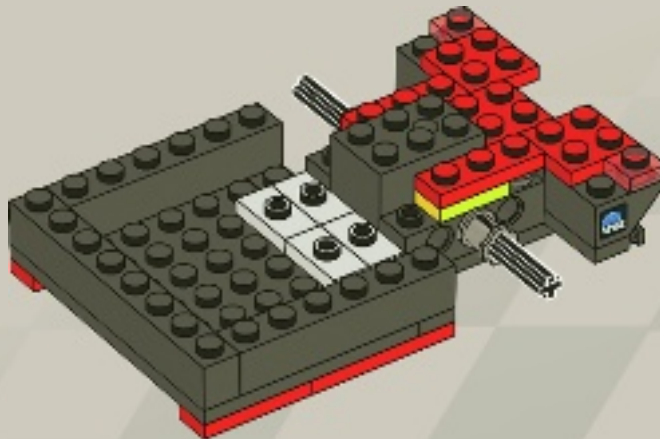



1x



1x

15

1



2

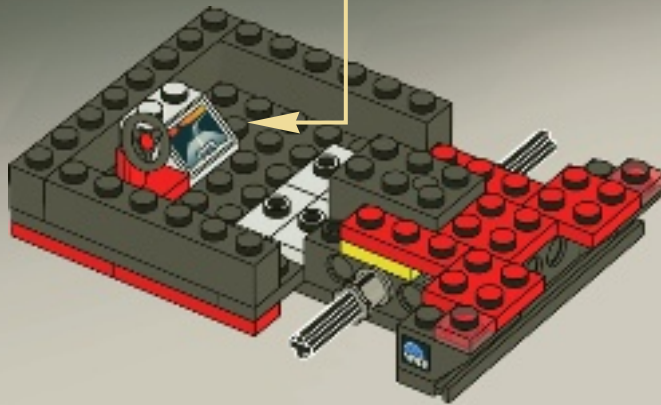

2x



2x

16

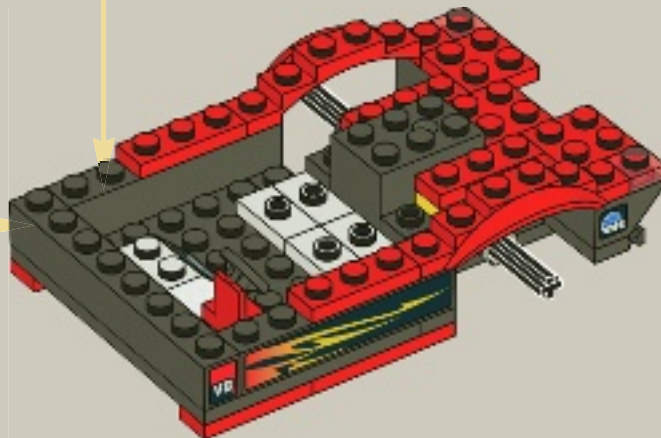



1x



4x

17

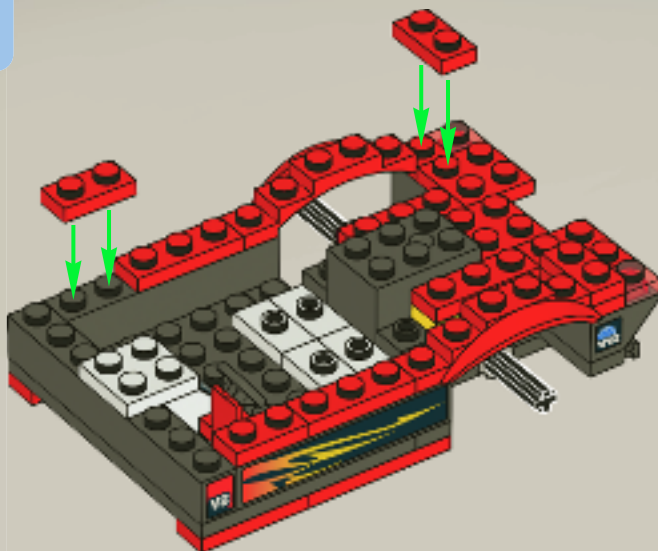

2x



2x



2x

18

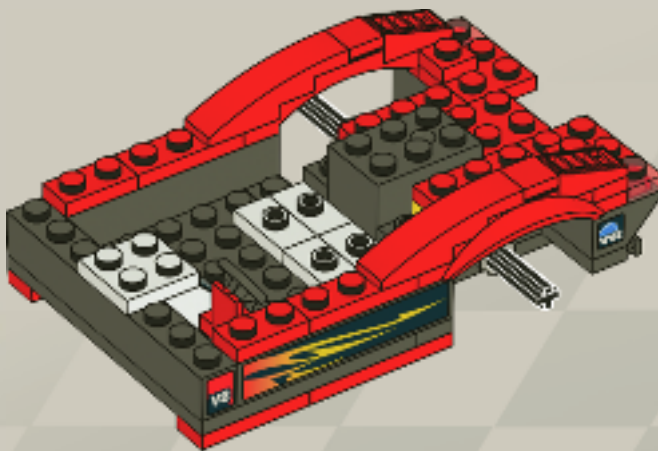



2x

19

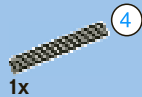
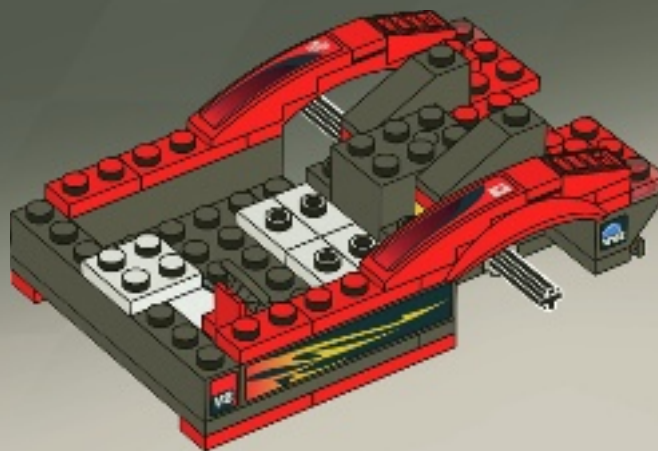

1x



1x

1



1:1



1x

2



1x

3



1x



1x

4

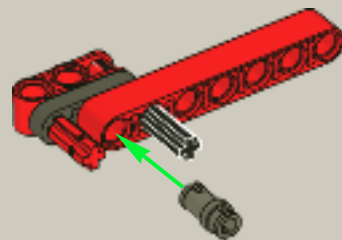

1x

5





6

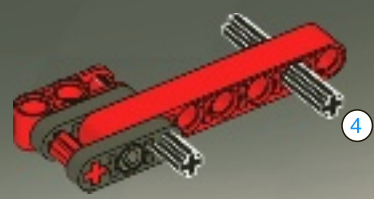

7

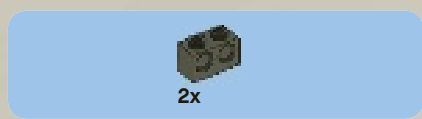
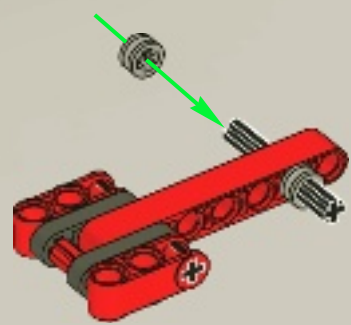

8

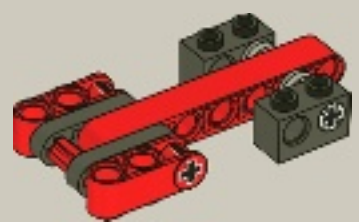

20

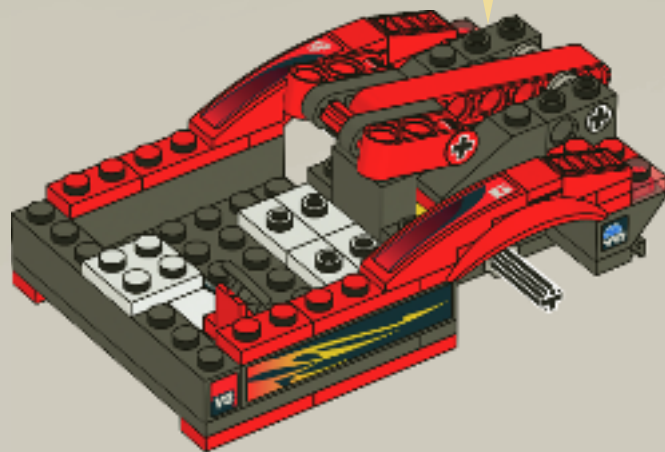

2x

21

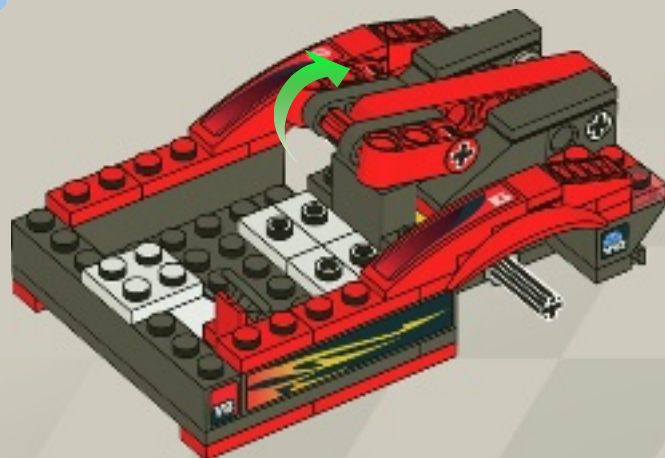



22

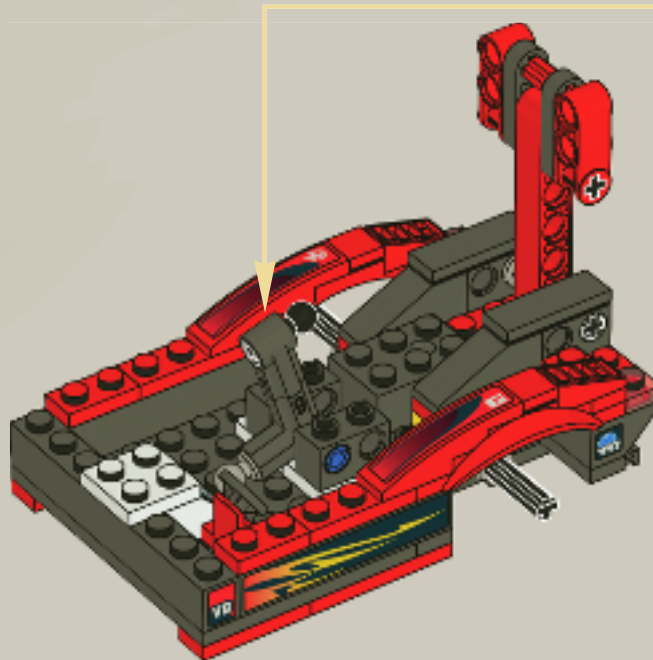
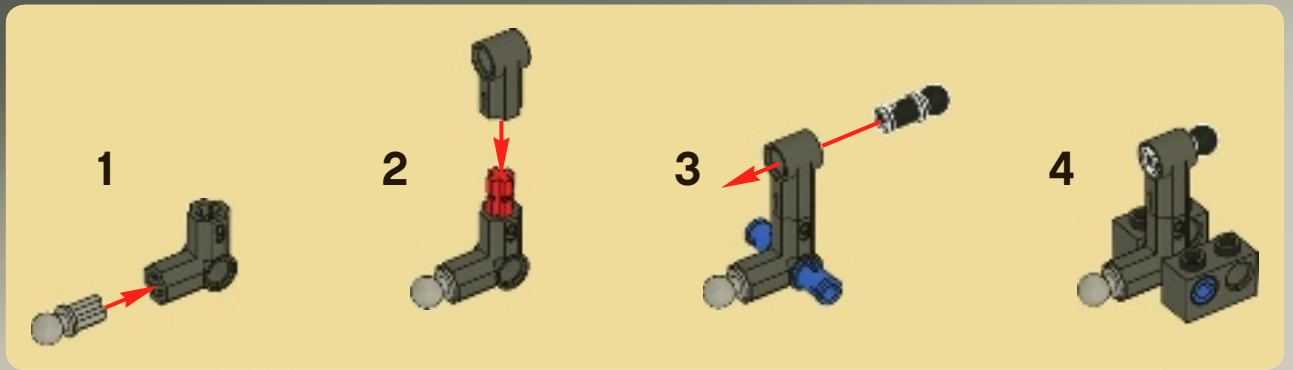

23

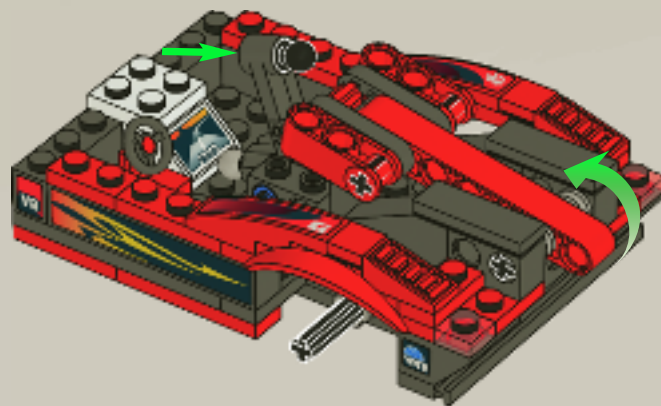

2x

24

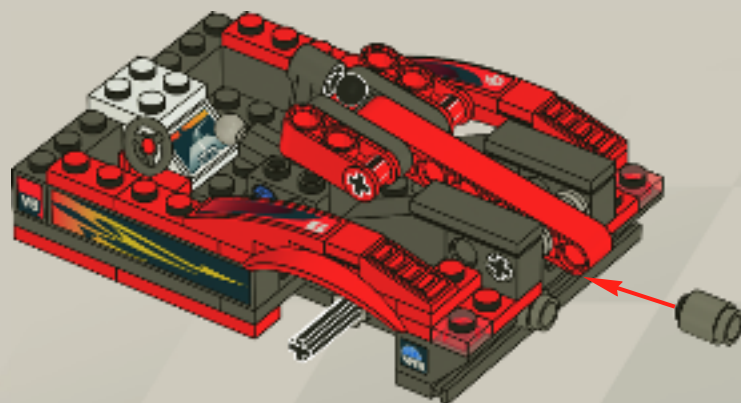



2x

25

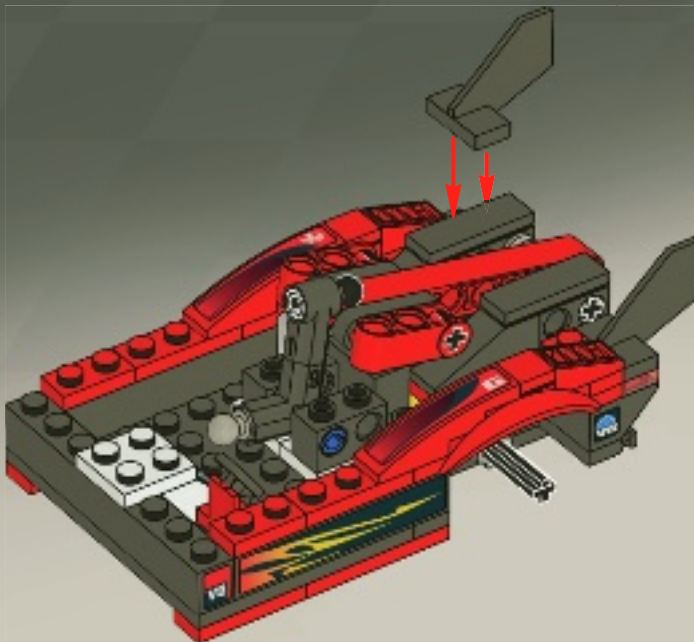

4x

26

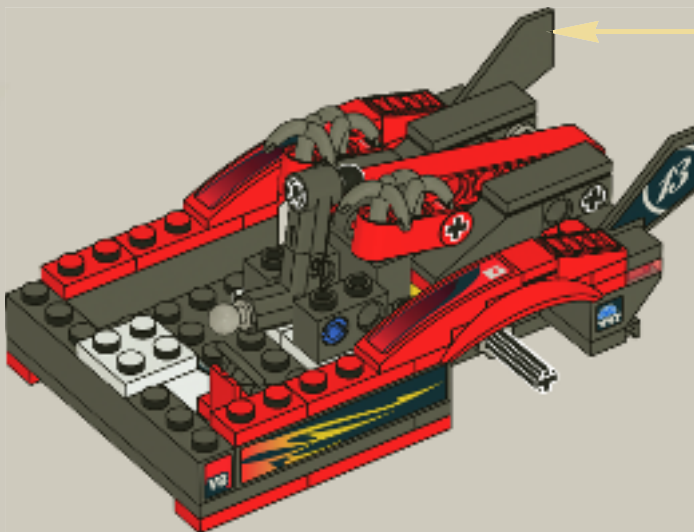

27

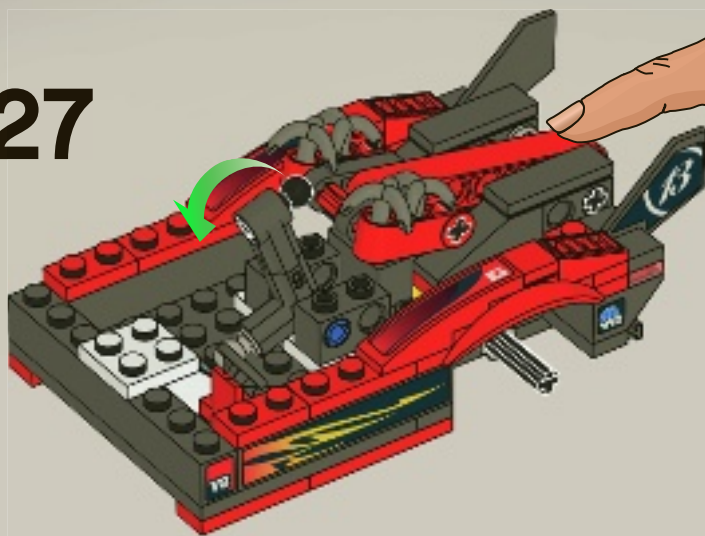

28

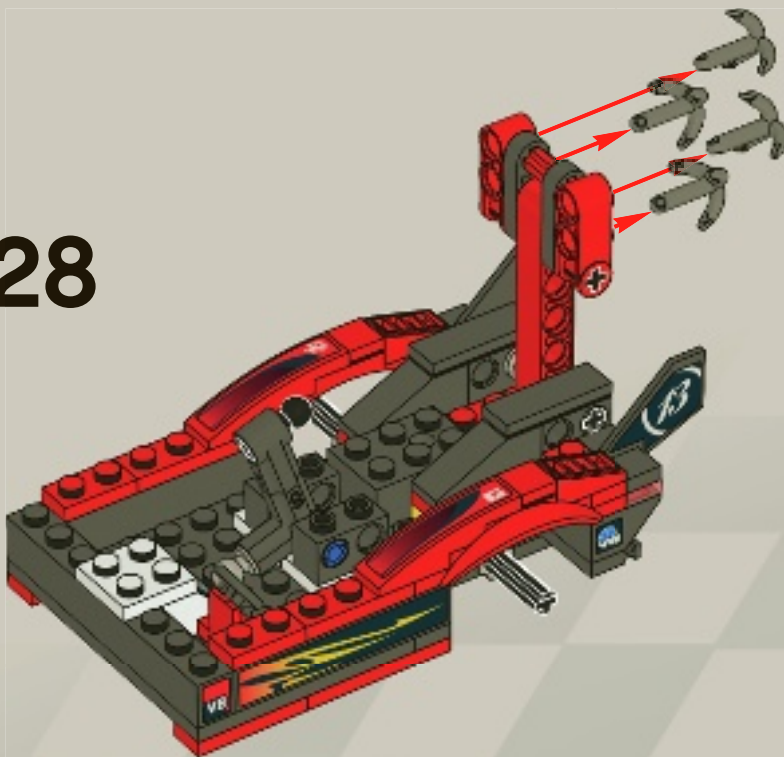



1x

1



2x

2



2x

3

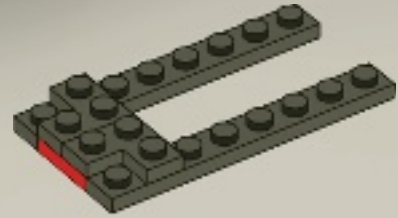

2x

4

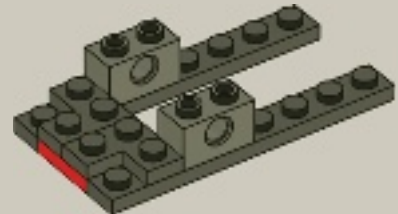



5

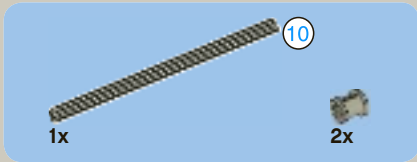
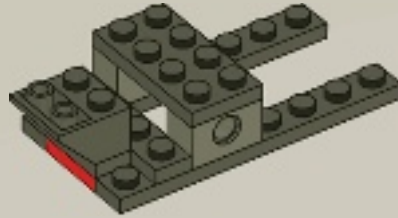

6

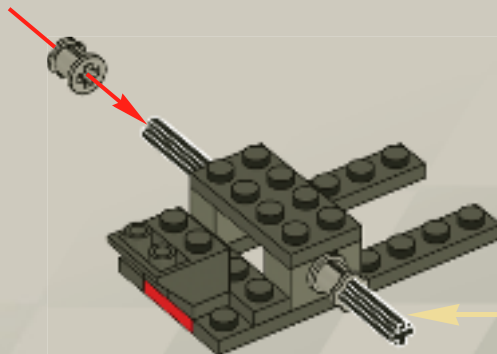
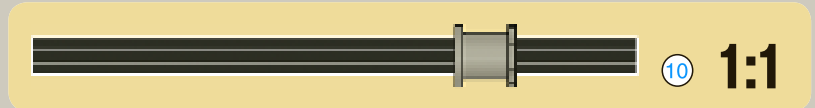



1x

7

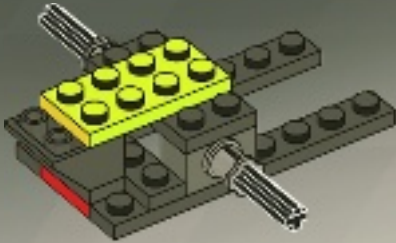

1x

8

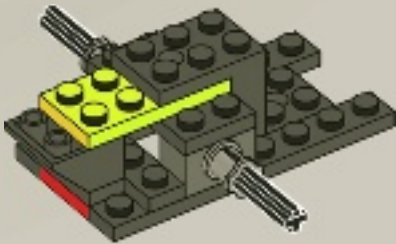

29

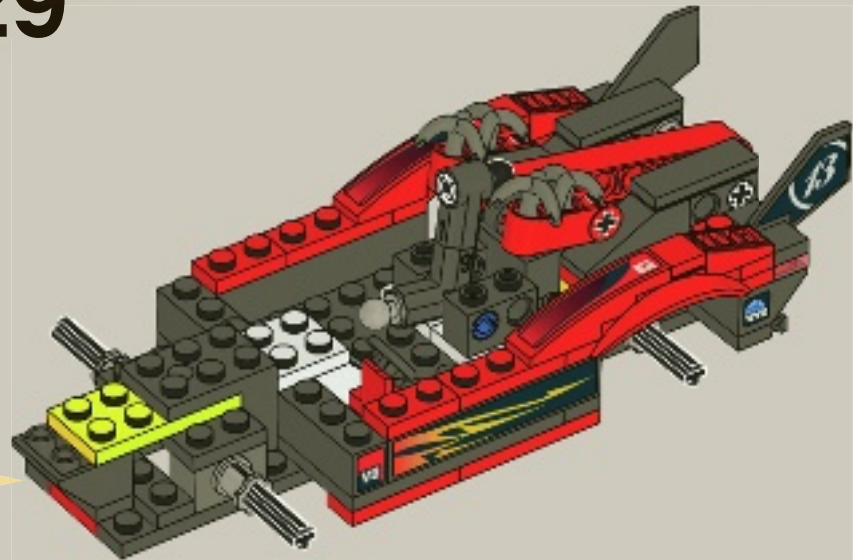

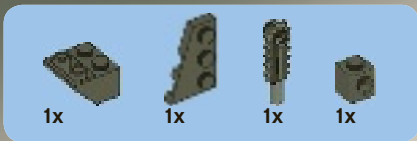

30

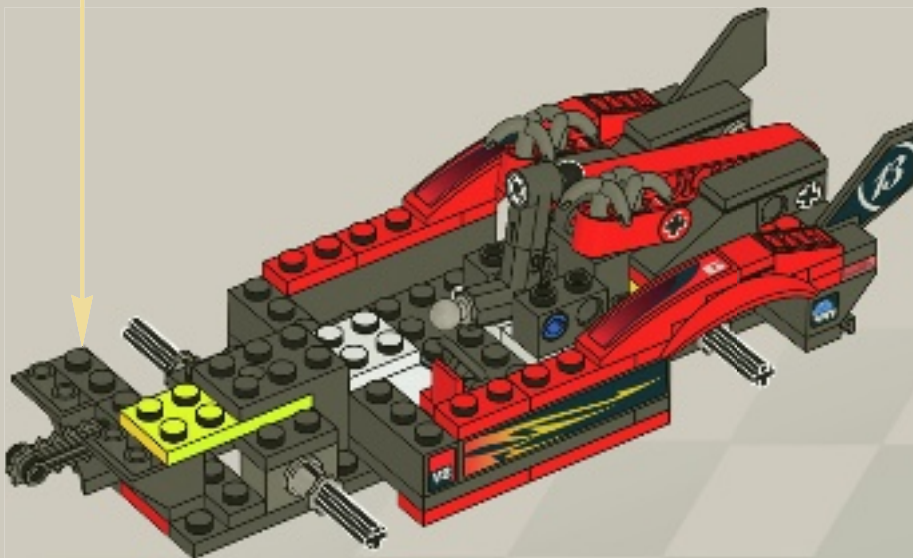
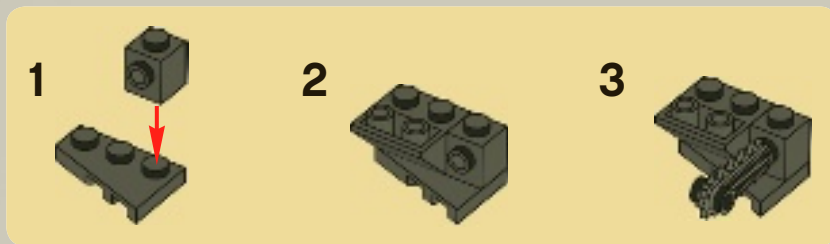

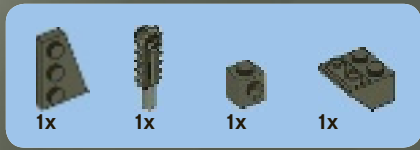

31

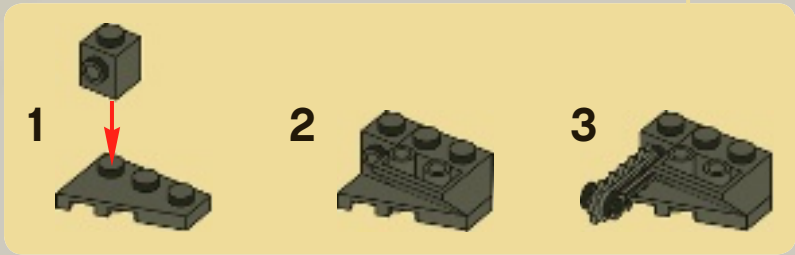
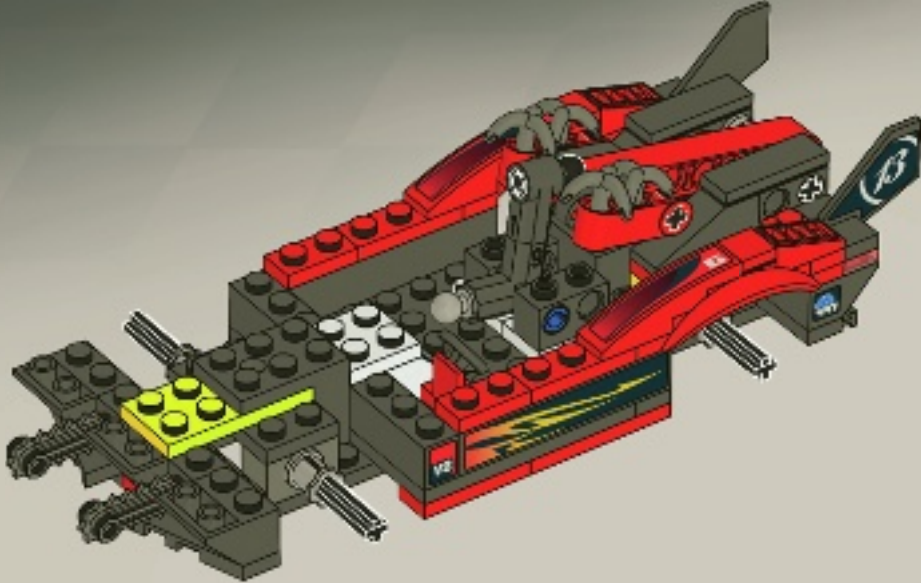



2x

32



2x



1x



1x

33





34

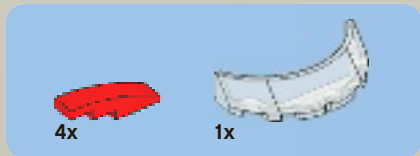

35





4x

36

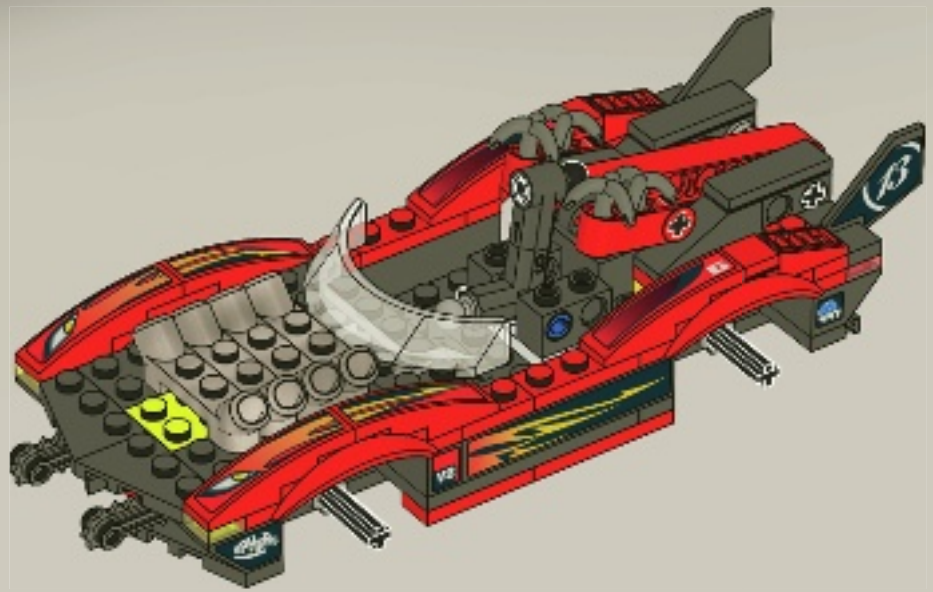

2x



1x

37



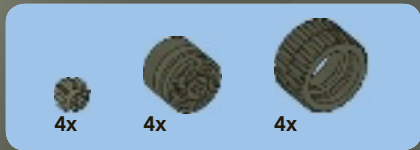

38

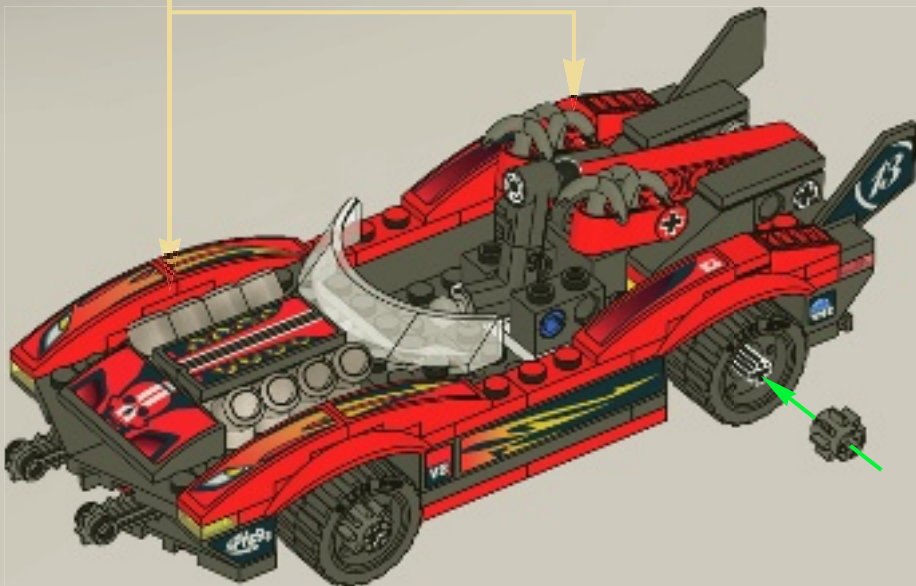

39



- EN IMPORTANT: Never modify the elements or use other projectiles than provided with this toy.
- DE WICHTIG: Die Elemente dürfen nicht verändert werden. Es dürfen ausschließlich die mit dem Spielzeug mitgelieferten Geschosse verwendet werden.
- FR IMPORTANT : Ne jamais modifier les éléments ni utiliser d'autres projectiles que ceux fournis avec ce jouet.
- IT IMPORTANTE: non modificare gli elementi o utilizzare proiettili non forniti con questo prodotto.
- NL BELANGRIJK! Verander niets aan de elementen en gebruik geen andere projectielen dan de bij het speelgoed geleverde.
- ES IMPORTANTE: No modifique los elementos ni utilice otros proyectiles diferentes a los suministrados junto con este juguete.
- DA VIGTIGT: Elementerne må ikke ændres, og der må ikke bruges andre projektiler end dem, der følger med legetøjet.
- FI TÄRKEÄÄ: Älä koskaan tee osiin muutoksia tai käytä lelussa muita kuin sen sisältämiä ammuksia.
- SV VIKTIGT: Modifera aldrig delarna och använd aldrig andra projektiler än de som medföljer denna leksak.
- PT IMPORTANTE: Nunca modifique os elementos nem utilize projecteis que não tenham sido fornecidos com este brinquedo.
- EL ΣΗΜΑΝΤΙΚΟ: Ποτέ μην τροποποιείτε τα στοιχεία του παιχνιδιού και μην χρησιμοποιείτε άλλα βλήματα εκτός από αυτά που συνοδεύουν αυτό το παιχνίδι.
- JA 重要：部品を改造したり、本製品に付属の発射体以外のものを使用しないようにしてください。
- ZH 重要提示：切勿更改组件或使用并非由本玩具附带的弹丸。
- KO 중요함: 이들 부품을 수정하거나 이 완구와 함께 제공된 것이 아닌 발사체는 결코 사용하지 마십시오.
- RU ВАЖНО: запрещается вносить изменения в элементы или использовать другие снаряды, отличные от тех, которые поставляются с данной игрушкой.
- PL WAŻNE: Nigdy nie modyfikować elementów zabawki ani nie używać pocisków innych niż dostarczone z zabawką.
- CZ UPOZORNĚNÍ: Nikdy neupravujte součástky a nepoužívejte jiné projektily než ty, které jsou dodávány s touto hračkou.
- SK UPOZORNENIE: Nikdy neupravujte súčasti a nepoužívajte iné projektily než tie, ktoré sú dodávané s touto hračkou.
- HU FONTOS: Az elemeket nem szabad módosítani, és a játékhöz adott lövedékek helyett sem szabad mást használni.
- UA ВАЖЛИВО: забороняється вносити зміни до елементів або використовувати інші снаряди на відміну від тих, що поставляються з цією іграшкою.
- HR VAŽNO: Nemojte nikad mijenjati elemente ili koristiti druge projektile osim onih koji su bili priloženi uz ovu igračku prilikom kupnje.
- SR Важно: Немојте да модификујете елементе и не користите друге пројектиле осим оних који долазе уз ову играчку.
- SL POMEMBNO: Nikoli ne spreminjajte elementov in uporabljajte le izstrelke, ki so bili priloženi tej igrački.
- RO IMPORTANT: Nu modificați niciodată elementele și nu utilizați alte proiectile decât cele furnizate cu această jucărie.
- BG ВАЖНО: Не видоизменяйте елементите и не използвайте други снаряди освен приложените към тази играчка.
- LV SVARĪGĪ! Nekad nepārveidojiet rotālietas elementus, vienmēr izmantojiet tikai tās komplektā iekļautās lodītes.
- ET OLULINE: Mänguasja osi ei tohi teistega asendada, kasutada võib ainult kaasasolevat heitkeha.
- LT DĖMESIO! Niekuomet nekeiskite elementų ir naudokite tik tuos šovinius, kurie yra pridėti prie šio žaislo.
- TR ÖNEMLİ: Hiçbir zaman parçalarda değişiklik yapmayın veya bu oyuncakla sağlananlar dışında mermiler kullanmayın.

LEGO

World Racers



3



1x
300301



1x
4181142



1x
300801



1x
303901



2x
4518992



2x
306901



2x
302301



1x
306801



2x
302201



1x
302101



1x
663601



1x
303401



1x
303601



4x
379401



1x
4282737



5x
4161326



5x
4160857



1x
4249506



1x
4523403



1x
395701



2x
4582480



2x
4583826



1x
4163533



2x
4529234



2x
4540382



6x
4520782



2x
307021



4x
302321



3x
302221



6x
362321



2x
371021



1x
302021



1x
9552



4x
4525791



1x
4495933



2x
4175442



2x
4142865



2x
302024



2x
302024



2x
302024



1x
4582369



1x
4582874



1x
4583827



1x
4582370



2x
300426



2x
300926



1x
300826



4x
3200026



3x
370126



6x
366526



5x
366026



2x
370326



2x
370326



2x
370326



2x
428626



2x
4515362



2x
306826



2x
242026



2x
243126



1x
371026



2x
302026



1x
366626



4x
4243819



3x
379526



2x
4286009



2x
4180508



2x
4180536



5x
346026

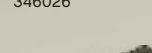

1x
303626



2x
4100423



2x
4558954

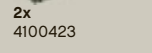

2x
4185620

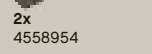

1x
4286009

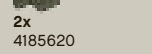

2x
4180508



2x
4180536



2x
4180508

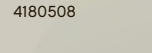

2x
4180536

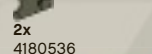

2x
4180536



2x
4180536

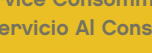

2x
4180536

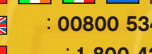

2x
4180536



Customer Service

Kundenservice

Service Consommateurs

Servicio Al Consumidor

www.lego.com/service or dial



: 00800 5346 5555

: 1-800-422-5346



FREE! GRATIS! GRATUIT!



club
MAGAZINE™

www.LEGOclub.com



00800 5346 5555*

1-866-534-6258 • 1-877-518-5346

US & Canada only

Canada seule ment



VISIT THE WORLD'S
BIGGEST LEGO® SHOP!

www.LEGOshop.com

* Freephone. Mobile charges may apply. * Numéro sans Frais. Des Frais peuvent s'appliquer avec les téléphones cellulaires. * Gebührenfrei, Kosten für Anrufe aus Mobilfunknetzen können abweichen.
* Gratis telefonnummer vanaf vaste lijn. * Det er ett gratis nummer, när du ringer från Fasttelefon. * Det är gratis, när du ringer från en Fast telefon.



WIN!

Go to www.nielsen.com/LEGO to fill out a survey for a chance to win a cool LEGO® Product. No purchase necessary. Open to all residents where not prohibited.



www.nielsen.com/LEGO

GEWINNE! WIN!

Nimm an der Umfrage auf www.nielsen.com/LEGO teil und hab die Chance ein cooles LEGO® Produkt zu gewinnen!

Die Teilnahme am Gewinnspiel führt zu keinerlei Kaufverpflichtungen. Teilnahme in allen nicht ausgeschlossenen Ländern möglich.

Ga naar www.nielsen.com/LEGO, vul een enquêteformulier in en maak kans op een cool LEGO® product.

Geen aankoopverplichting. Iedereen mag deelnemen, uitgezonderd ingezetenden van landen waar een enquêteverbod geldt.

GAGNE! 当てよう!

Visite www.nielsen.com/LEGO pour répondre à un questionnaire et avoir une chance de gagner un produit LEGO® très cool!

Aucune obligation d'achat. Ouvert à tous les résidents des pays autorisés.

www.nielsen.com/LEGOにアクセスして、アンケートにご記入ください。当選者にはレゴ®製品を差し上げます。

お買い上げの必要はありません。

禁止されていない限り、すべての皆様にご利用いただけます。