

BIONICLE

MALUM



WARNING: CHOKING HAZARD.
Toy contains small parts and a small ball.
Not for children under 3 years.



8979

GLATORIAN

LEGO

1

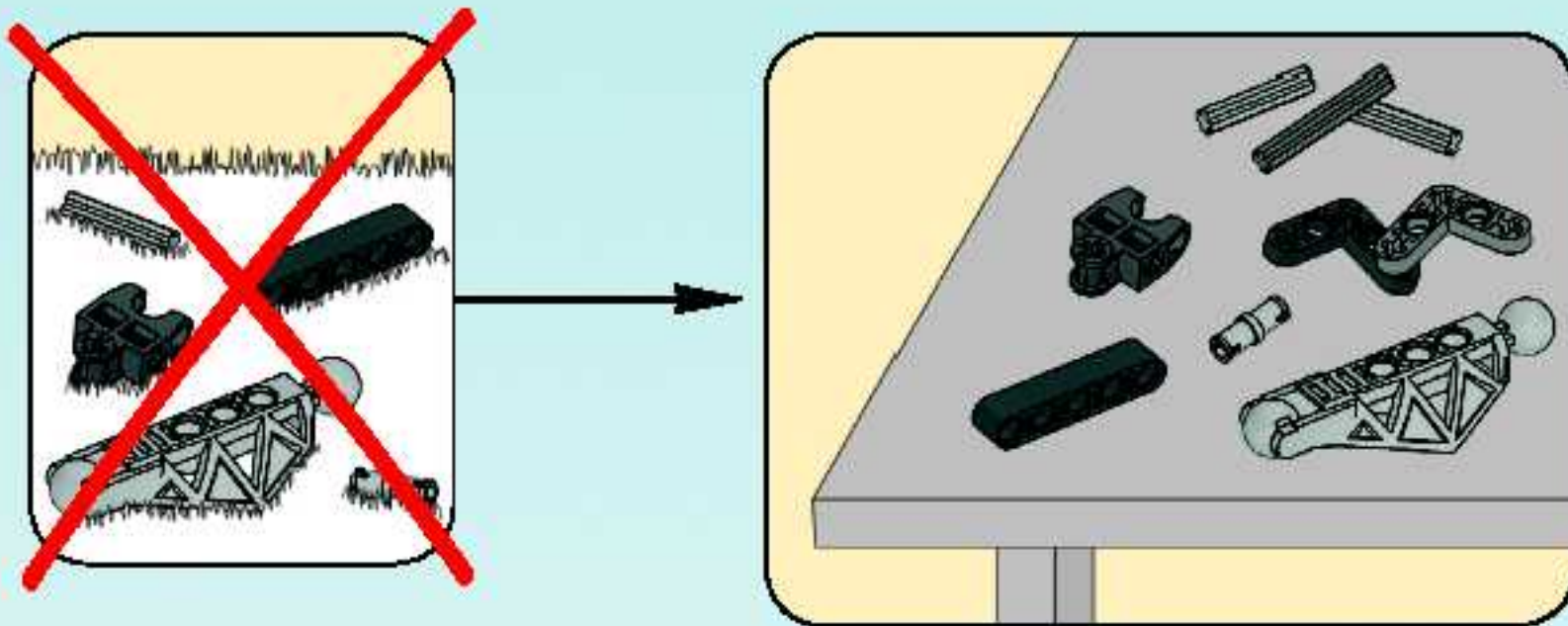

2

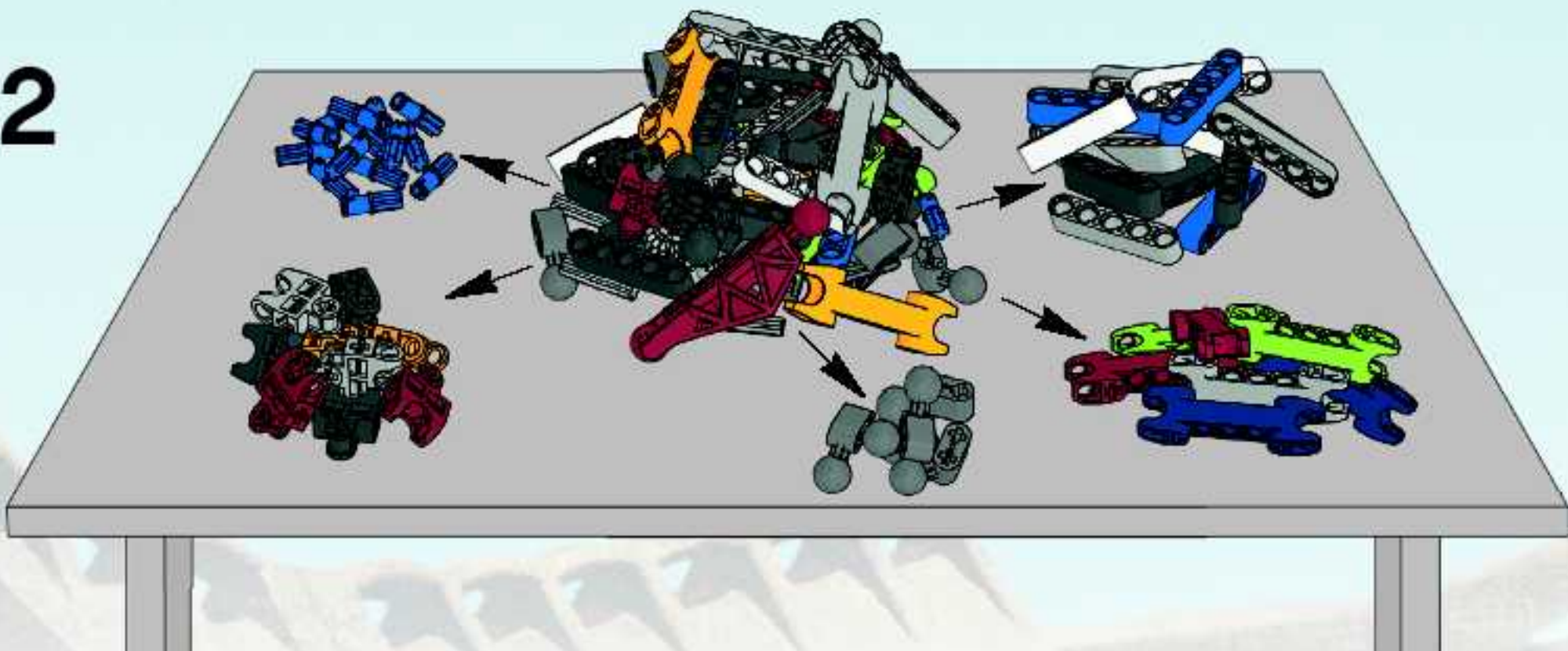

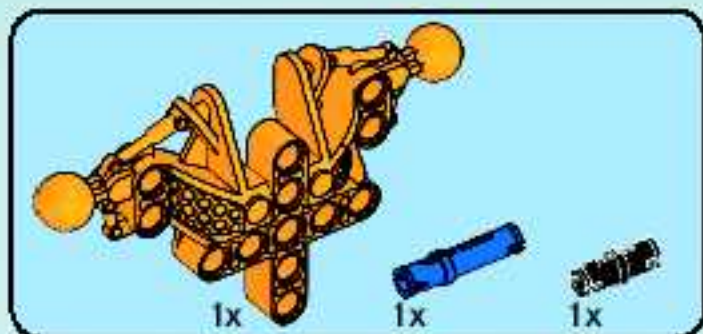

1

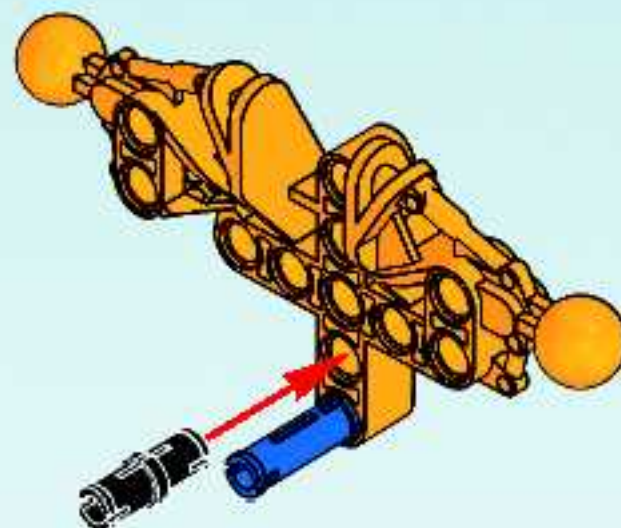

AVERTISSEMENT : RISQUE D'ÉTOUFFEMENT.

Le jouet contient des petites pièces ainsi qu'une petite boule.
Il ne convient pas aux enfants de moins de 3 ans.



ADVERTENCIA: PELIGRO DE ASFIXIA.

Juguete que contiene partes pequeñas y una pelota pequeña.
No recomendado para niños menores de 3 años.

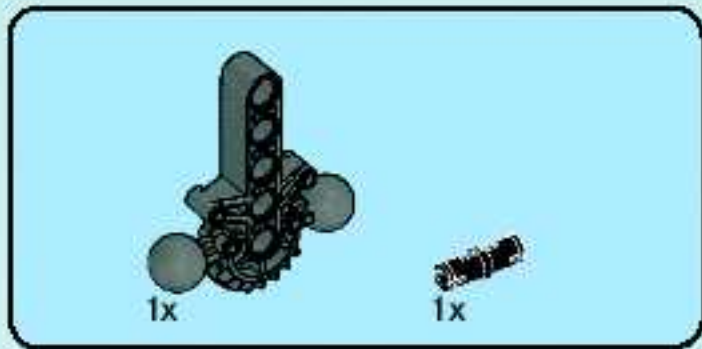

2

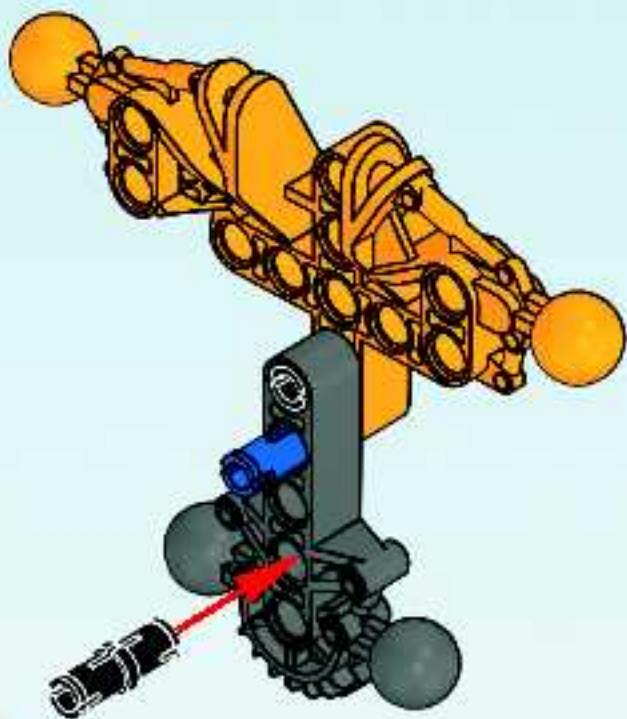

3

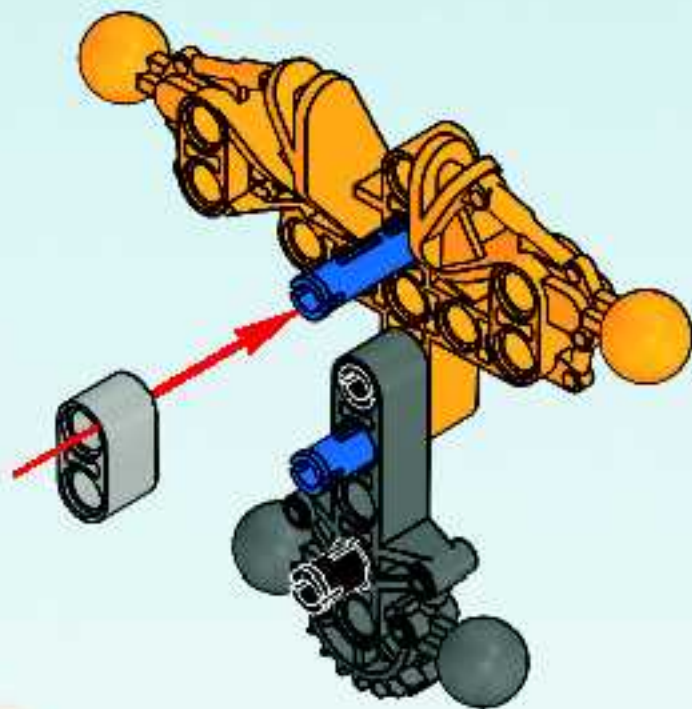

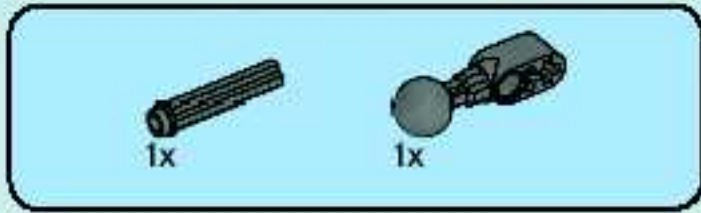

4

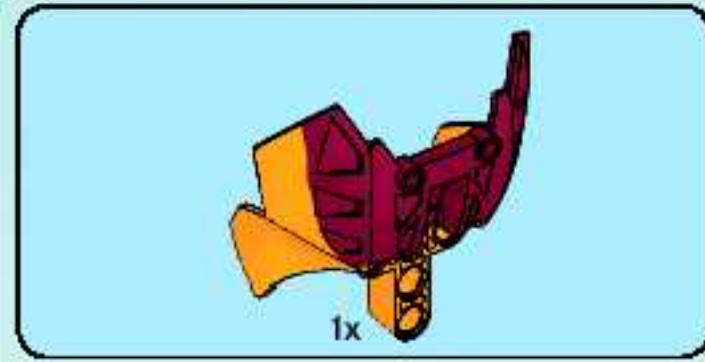
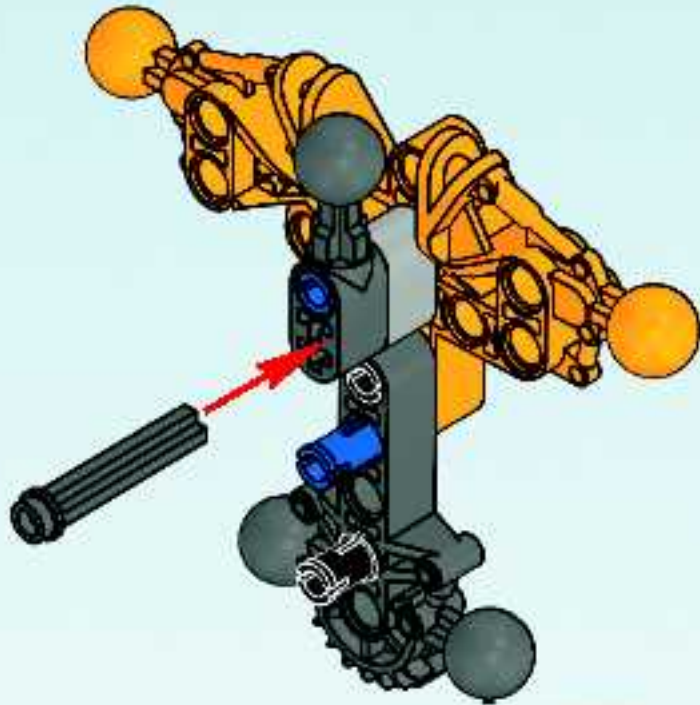

5

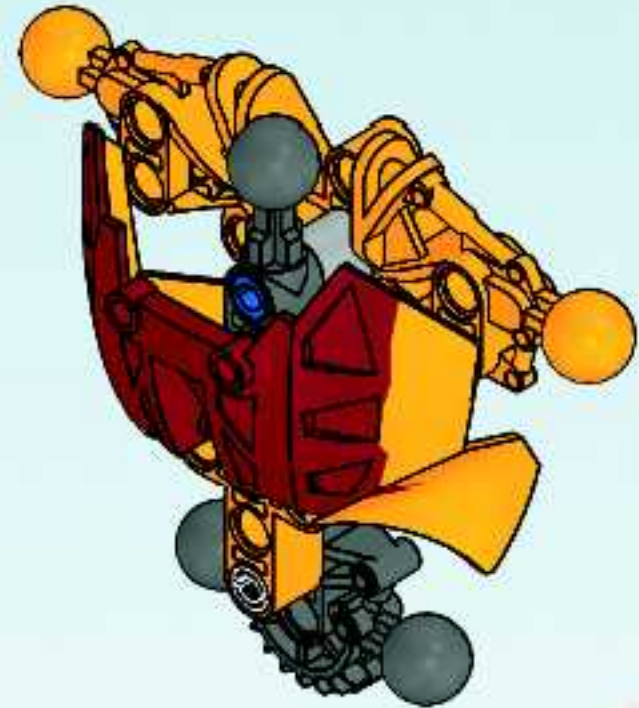

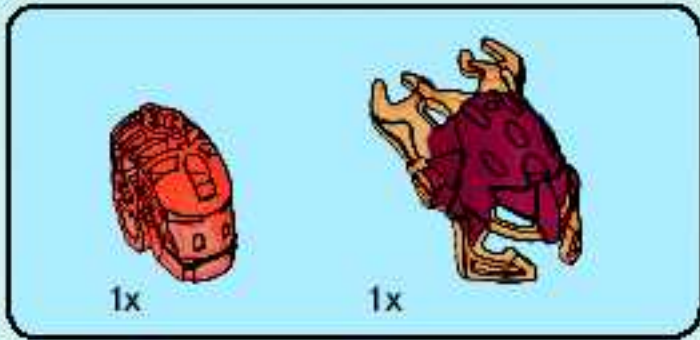

6

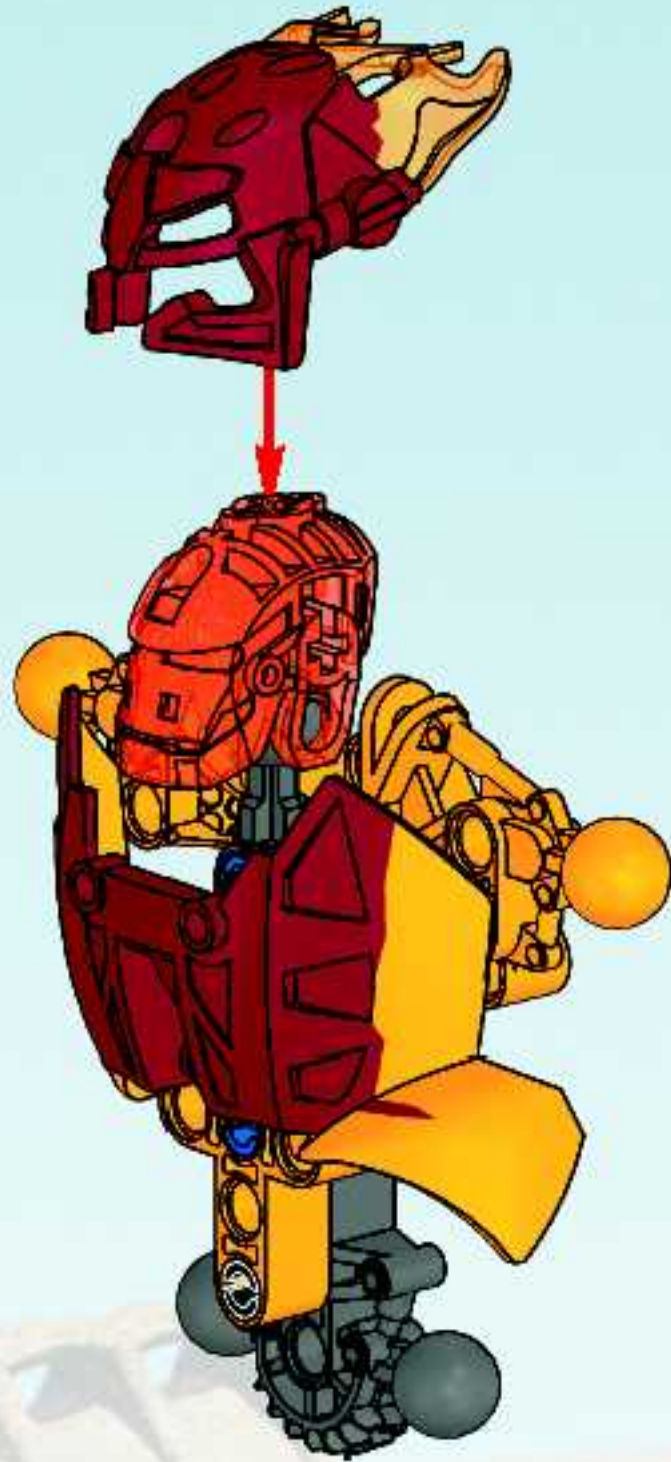

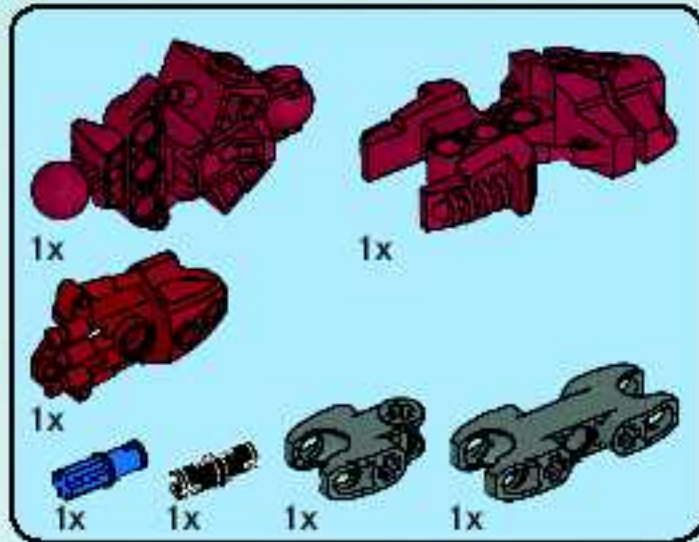
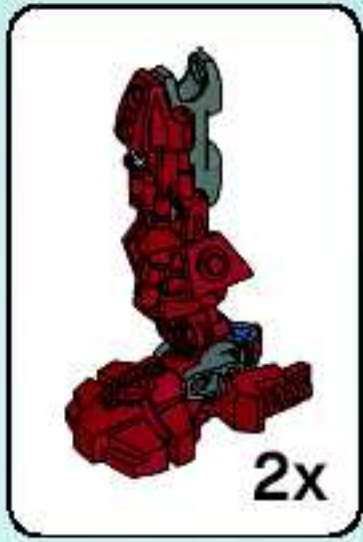

7

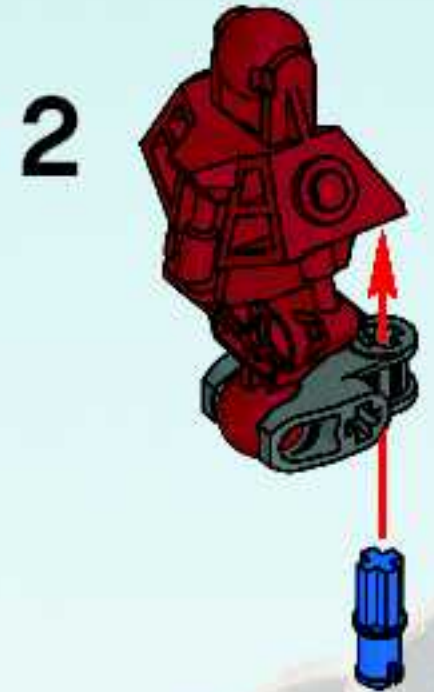

3

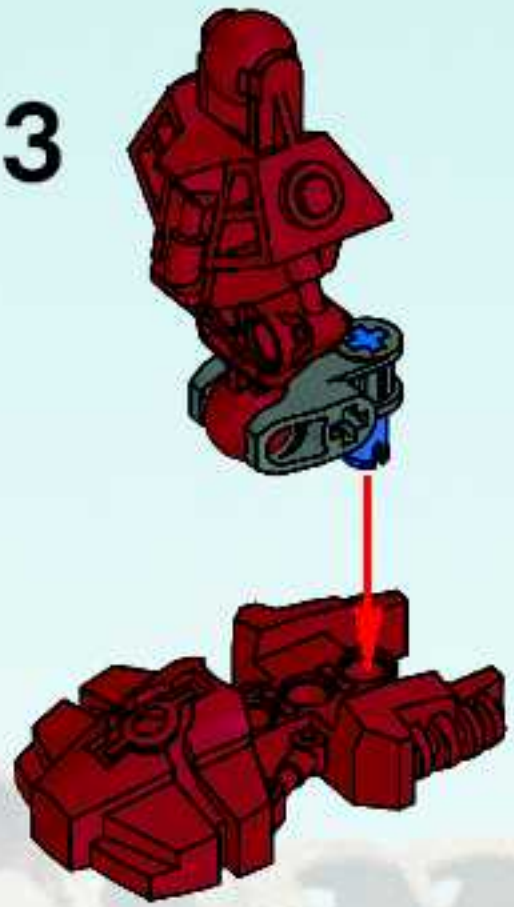

4

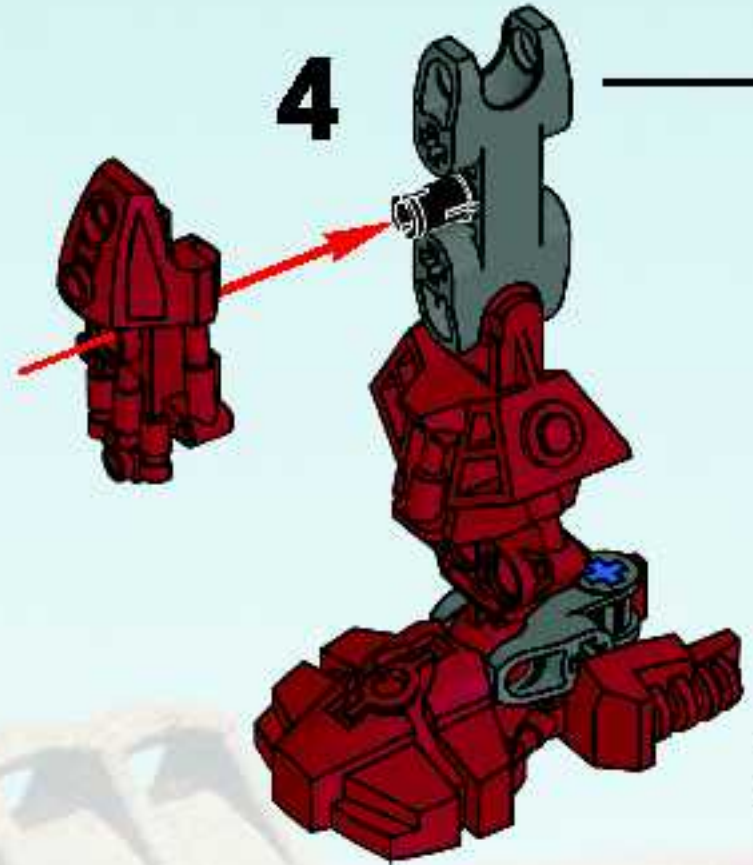

2x

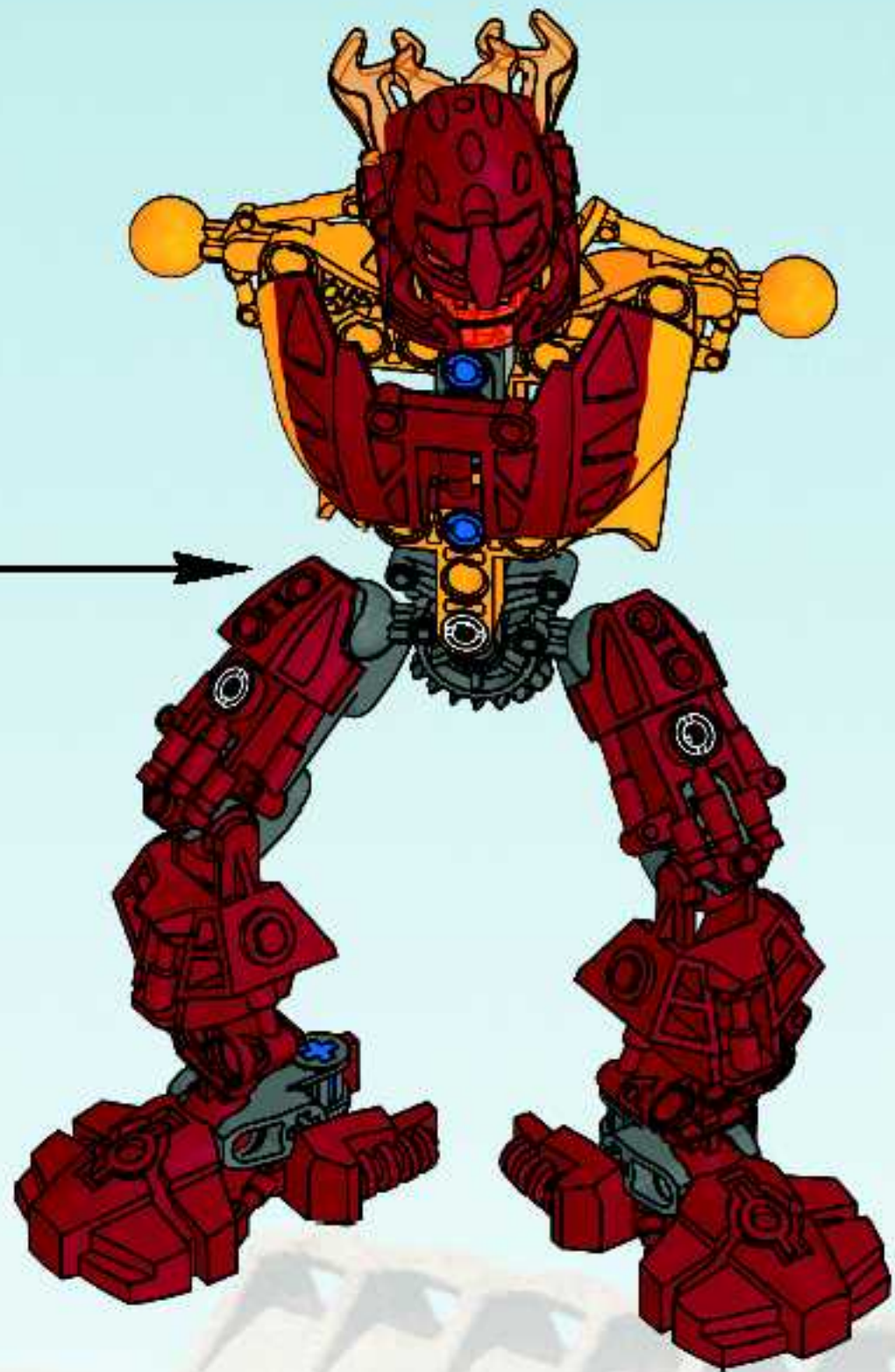

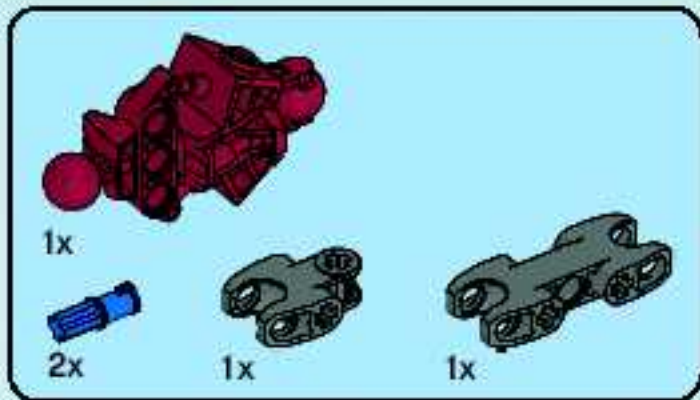
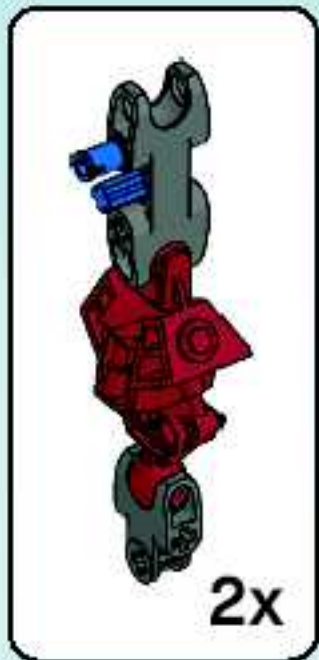

8

1

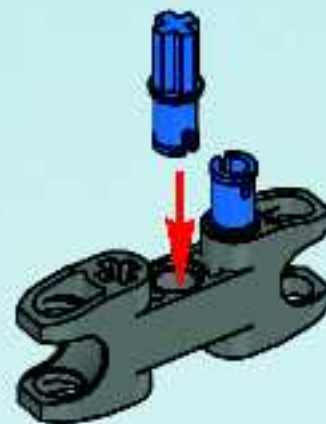

2

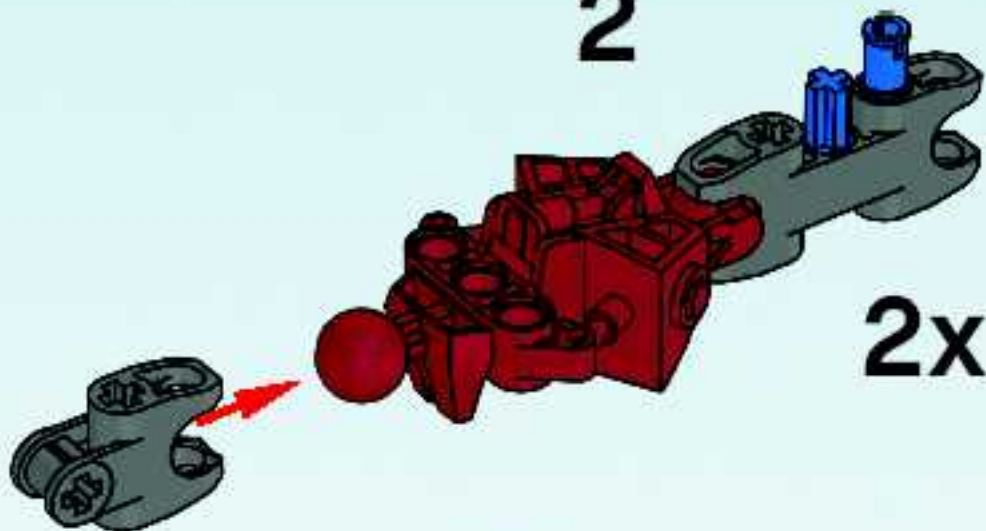

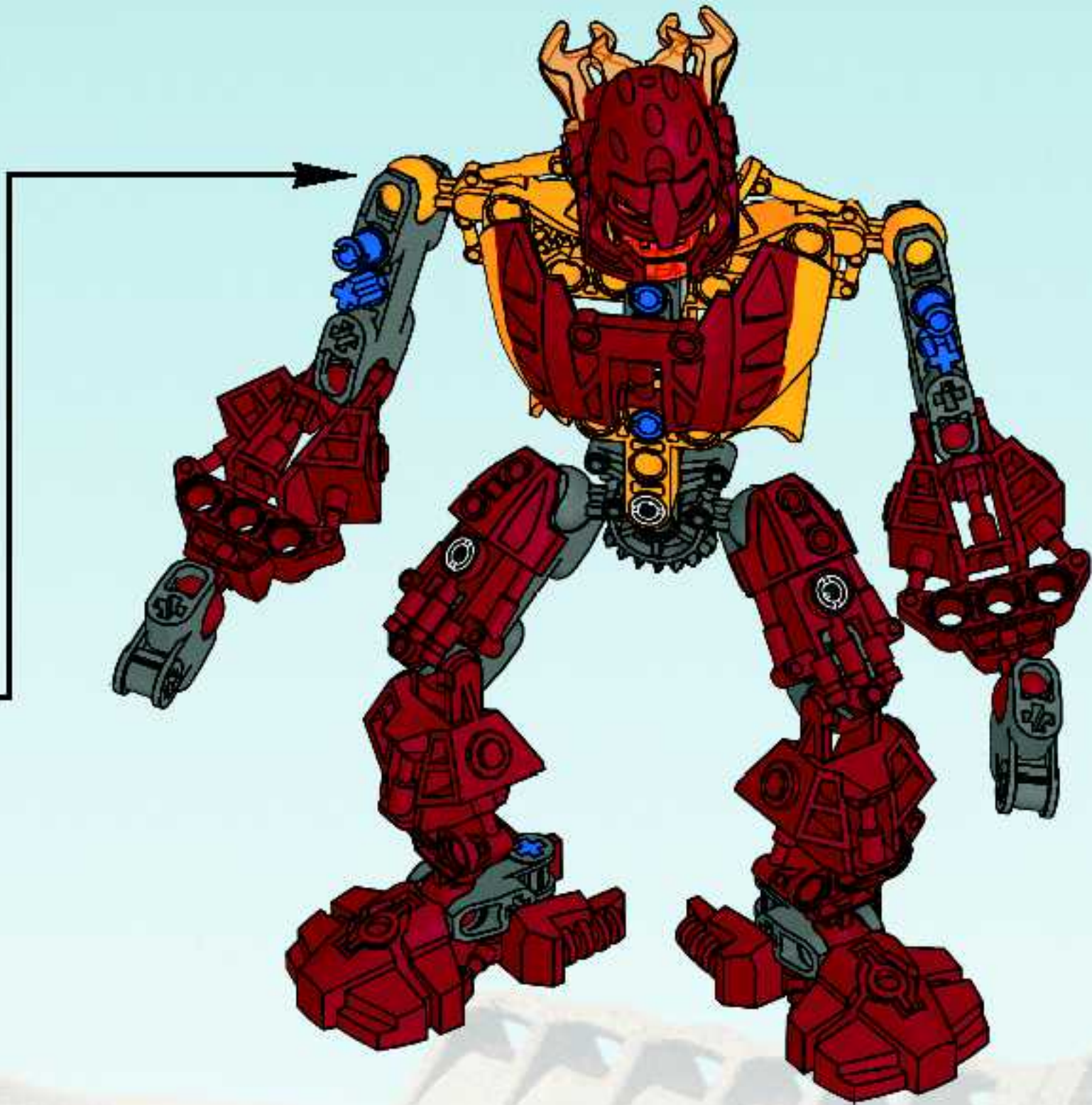

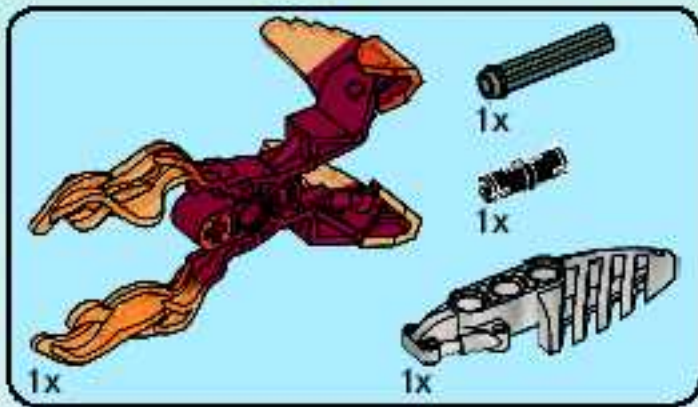
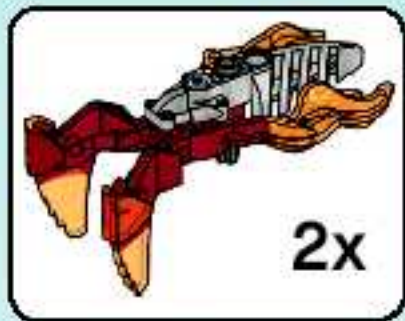

9

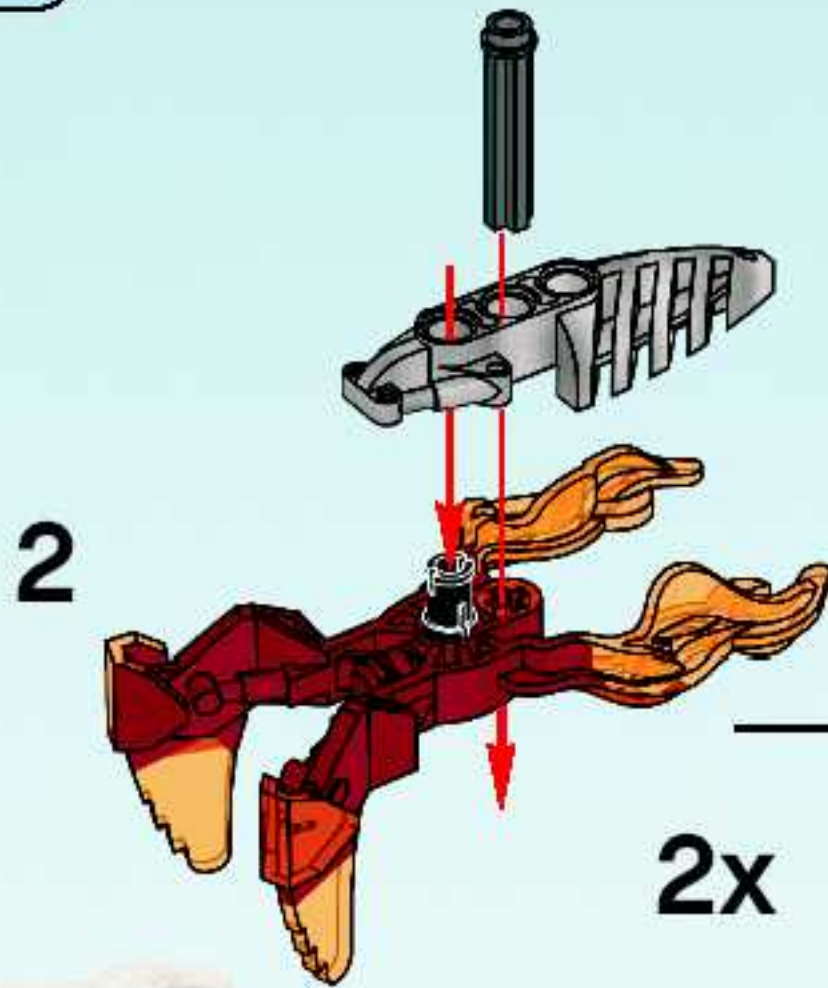
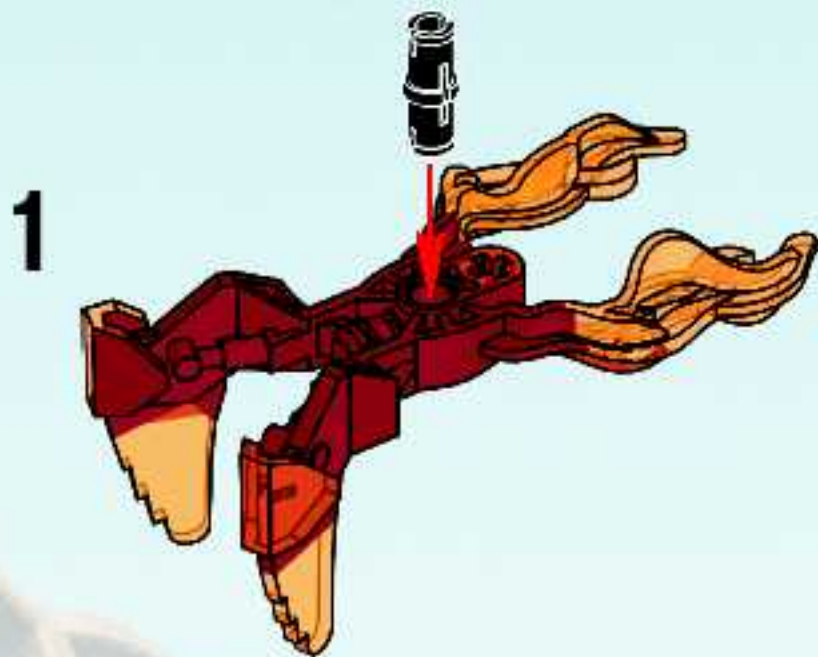

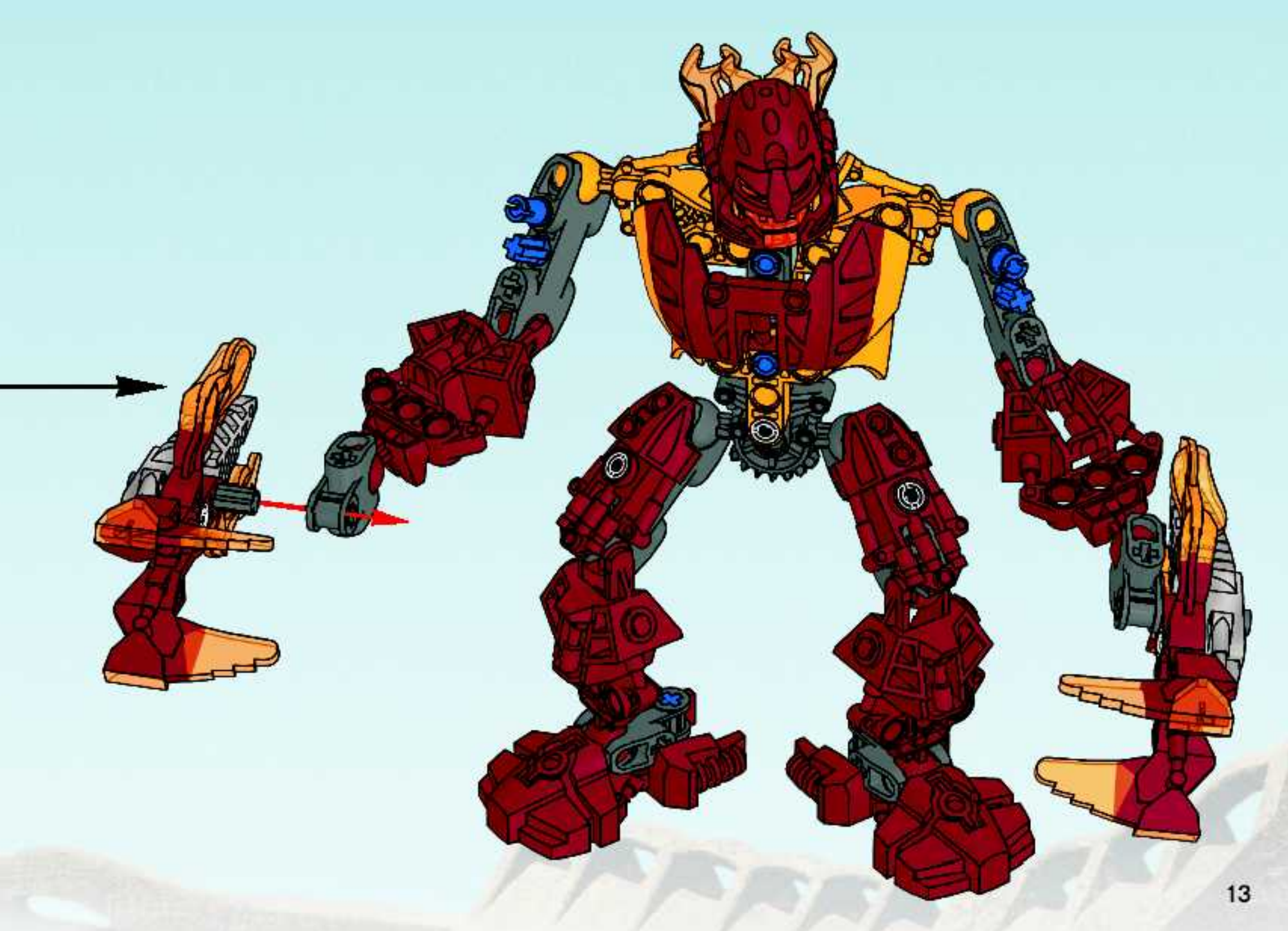

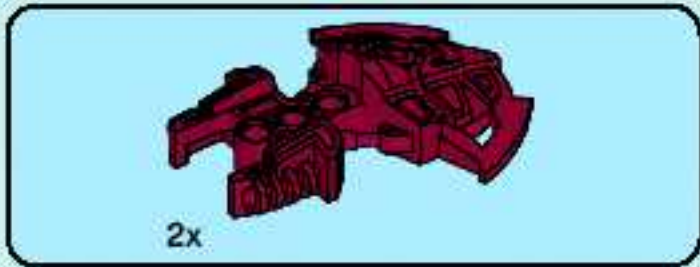

10

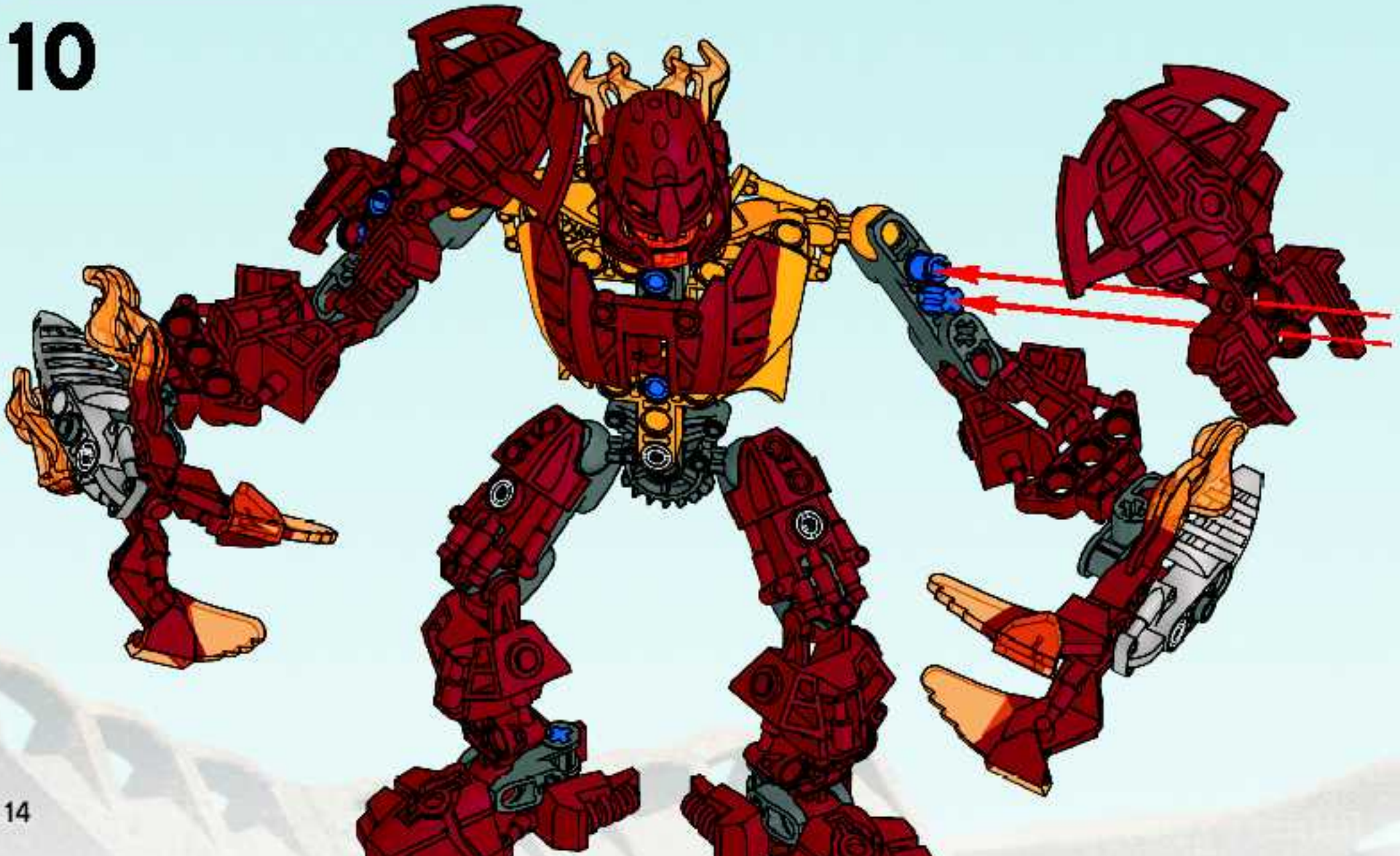

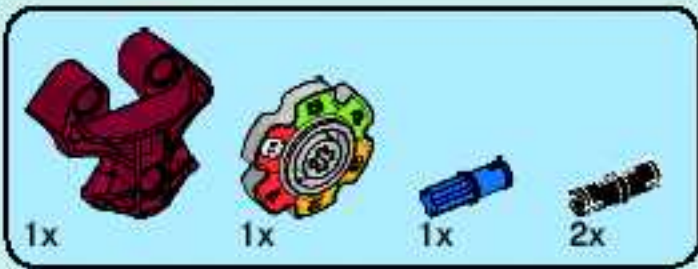

11

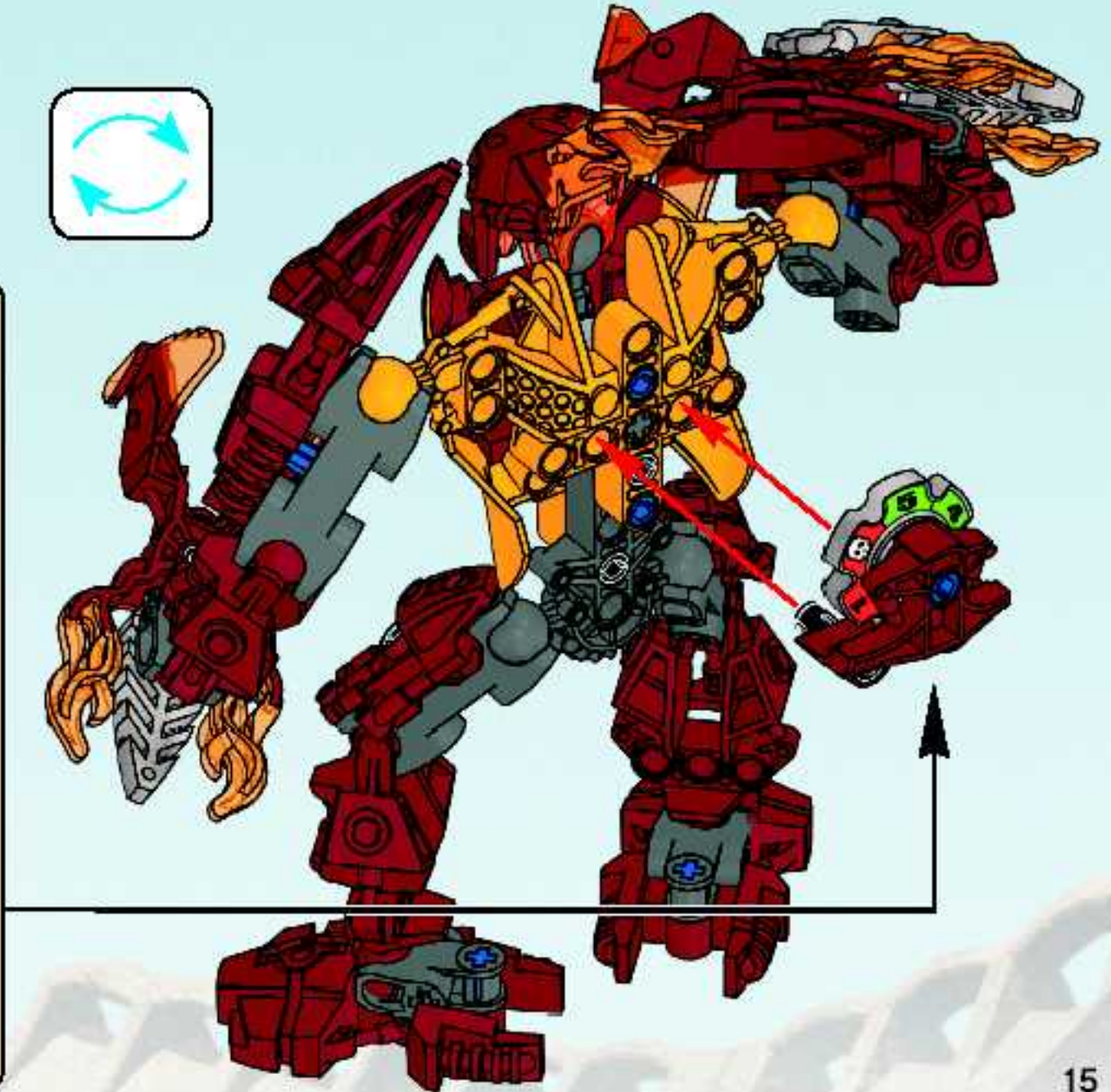
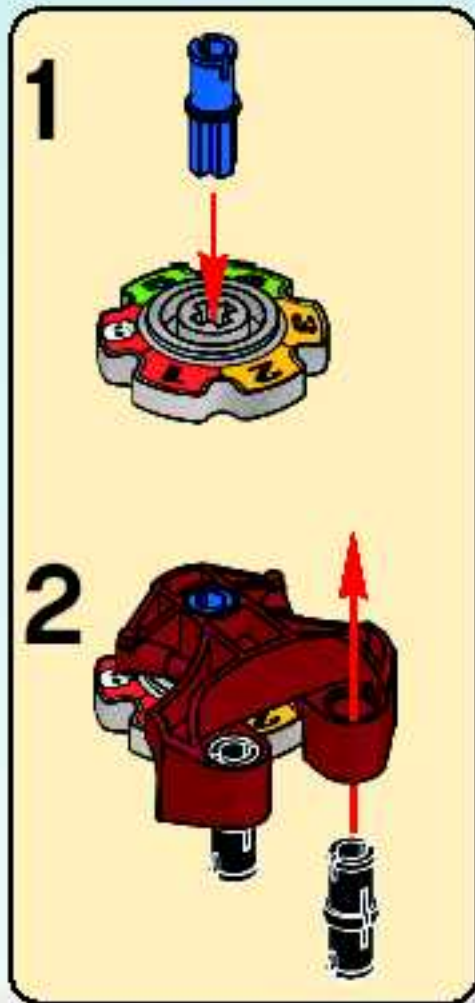

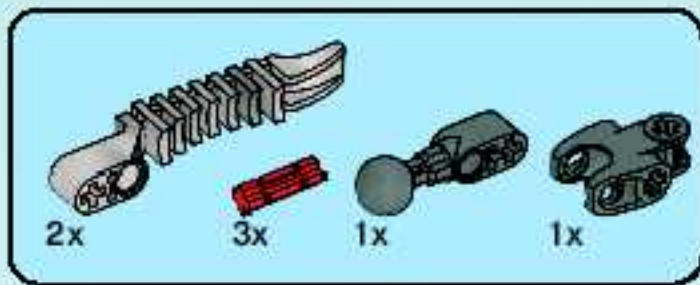

12

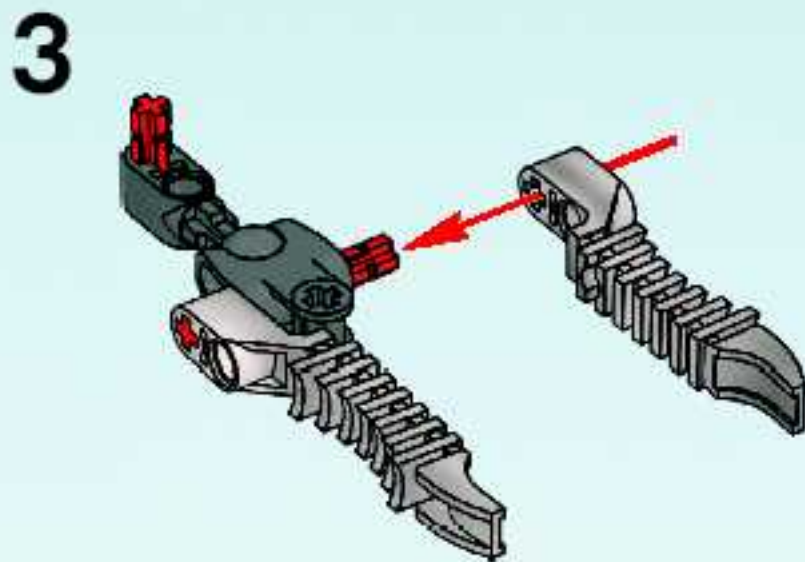
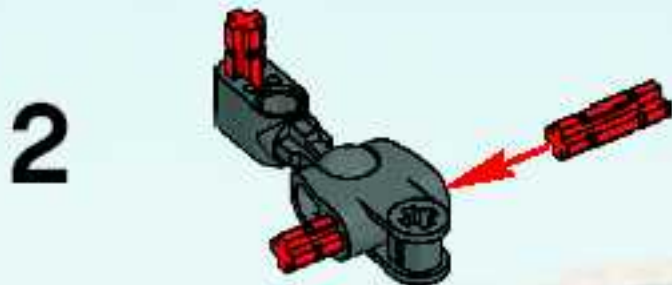
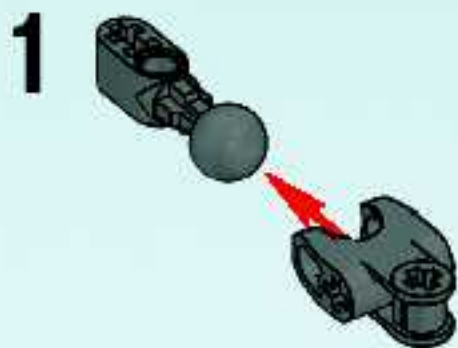

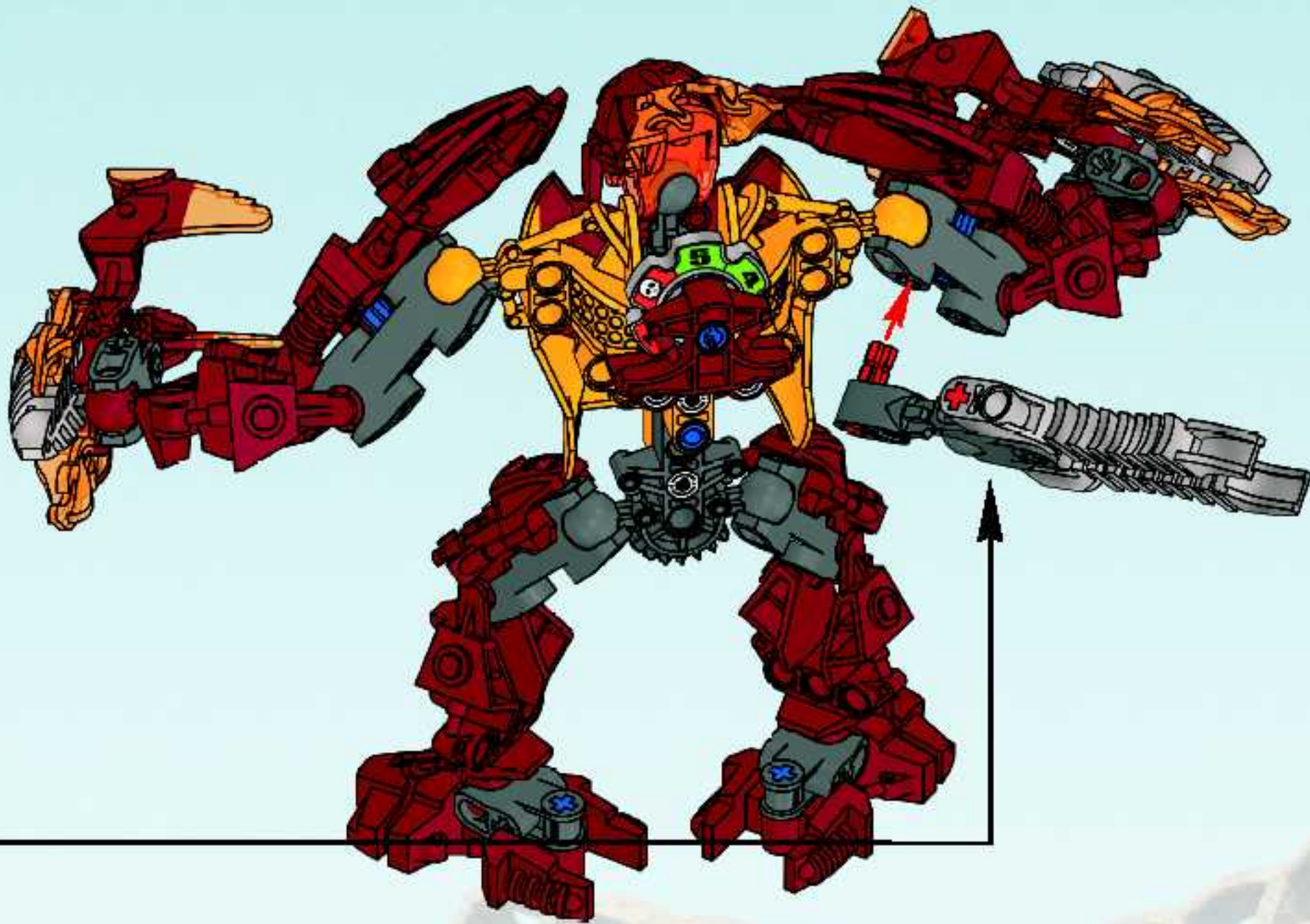



13

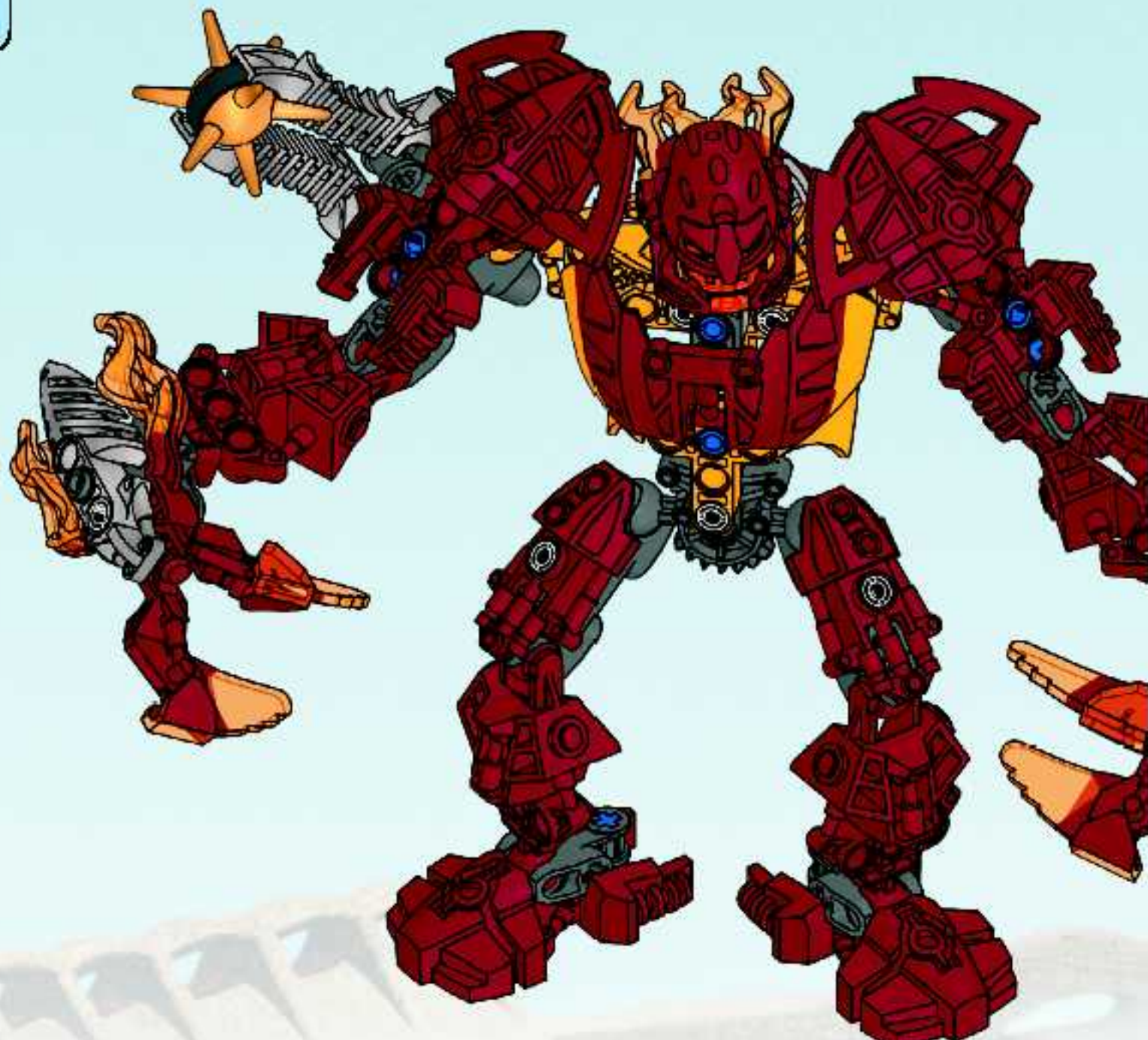
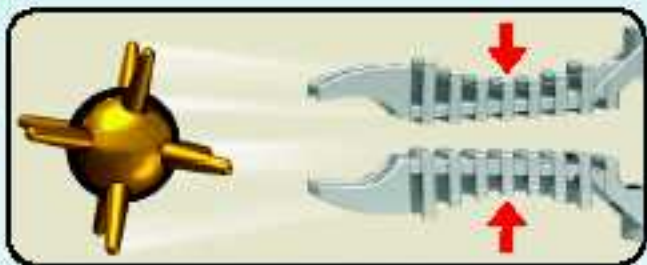
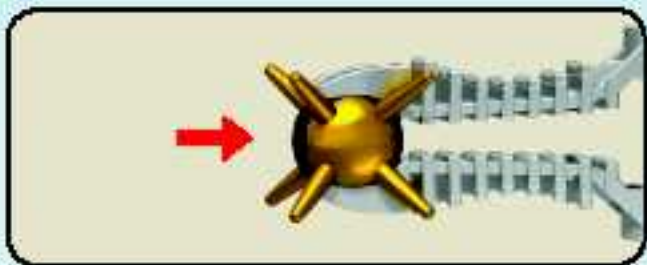

2x
4540566

3x
4211086

1x
4537500

1x
4540702

7x
4206482

1x
4540739

4x
4519254

1x
4541820

1x
4211862

2x
4514553

2x
4542878



5x
4519225

2x
4537506

2x
4256503

3x
4142865

4x
4543192

1x
4287086

2x
4546416

1x
4546585

2x
4540567

2x
4542563

1x
4543193



Customer Service

Kundenservice

Service Consommateurs

Servicio Al Consumidor

www.lego.com/service or dial

								
								: 00800 5346 5555
								: 1-800-422-5346



BIONICLE ACTION FIGURE
GAME



Setting Up Préparer le jeu

Prepara el juego

This game is about taking the life of your opponent before he takes yours!

1. Set up the game using 2 cans & 2 figures
2. Set the dial to 5
3. Decide who goes first

Pour gagner, il faut que tu t'empares de la vie de ton adversaire avant qu'il ne s'empare de la tienne !

1. Installe le jeu en utilisant 2 boîtes et 2 figurines
2. Positionne le cadran sur 5
3. Décide qui commence

¡El objetivo de este juego es ganar la vida de tu oponente antes que él gane la tuya!

1. Prepara el juego utilizando 2 latas y 2 figuras
2. Coloca el marcador en 5
3. Decide quién empezará



Playing the game: **POINTS**

Jouer au jeu : **POINTS**

Cómo jugar: **PUNTOS**

1. Hit can and opponent loses 1 life point or hit figure and opponent loses 2 points.

1. Si tu touches la boîte, ton adversaire perd 1 point de vie et si tu touches la figurine, ton adversaire perd 2 points.

1. Golpea la lata para que tu oponente pierda 1 punto de vida, o golpea la figura para que pierda 2 puntos de vida.



Playing the game: **MOVE**
Jouer au jeu : **AVANCE**

Cómo jugar: **AVANZA**

1. After shooting move figure to where ball lands.

1. Après avoir tiré, déplace la figurine à l'endroit où la balle a atterri.

1. Después de disparar, mueve la figura hasta el lugar en el que haya caído la bola.



Gana el Juego

Winning the game
Gagner la partie

1. The first player to take all the opponent's life points wins!

1. Le premier joueur qui s'empare de tous les points de vie de son adversaire gagne !

1. El primer jugador que junte todos los puntos de vida de su oponente ganará!

Team up
Fais équipe

Agranda tu equipo

8983



8981



8982



8976



8980



8988



For more rules on advanced multi-figure game play

Pour plus d'information concernant les règles des jeux de niveau avancé avec plusieurs figurines, visitez

Para más información sobre instrucciones de juego avanzado con varias figuras, consulta

www.BIONICLE.com

8974



8979



8978



8991



8972

8973

GLATORIAN BIONICLE®

FOR VICTORY - FOR GLORY - FOR POWER





8972



8973



8974

www.BIONICLE.com



8975



8977



8976



8978



8979



8980



8981



8983



8982

www.BIONICLE.com

FERO &
SKIRMIX

TUMA

8990

8991

www.BIONICLE.com



WWW.BIONICLE.COM



FREE! GRATIS! GRATUIT!



club
MAGAZINE™

www.LEGOclub.com



00800 5346 5555*        

  **1-866-534-6258 • 1-877-518-5346**

US & Canada only

Canada seulement

* Free phone. Mobile charges may apply. * Numéro sans frais. Les frais peuvent s'appliquer avec les téléphones cellulaires.
* Gebührenfrei. Kosten für Anrufe aus Mobilfunknetzen können abweichen. * Gratis telefonnummer van PostNet lijn. * Det er et gratis nummer, når du ringer fra PostNet telefon.
* Débit gratuit, når du ringer fra PostNet telefon.



VISIT THE WORLD'S
BIGGEST LEGO® SHOP!

www.LEGOshop.com



**YES! I want to join the LEGO® Club FREE! OUI! Je veux m'abonner au Club LEGO® GRATUITEMENT! Ja! Ich möchte Mitglied im kostenlosen LEGO® Club werden.
Ja! Ik wil graag GRATIS lid worden van de LEGO® Club. Ja! Jeg ønsker å melde meg inn i LEGO® Club gratis! Ja! Jag vill gå med i LEGO® Club GRATIS!**

First name - Prenom
Vernam - Voornaam
Forenam - Forenam

Last name - Nom de Famille
Name - Achternaam
Efternavn - Efternavn

Date of Birth - Date de naissance
Geburtsdag - Geboortedatum
Fødselsdato - Fødselsdato

Boy - Garçon
Junge - Jungen
Gutt - Pojke

Girl - Fille
Mädchen - Meisje
Jente - Flicka

Street - Adresse
Straße, Hausnr.
Straat, huisnr. - Adress

City - Ville
Ort - Woonplaats
Poststed - Postort

State
Prov.
County

Zip/Postcode - Code Postal
PLZ - Postcode - Postnummer

Country
Pays - Land

Please tick below if you would like to receive other communication from the LEGO Group. Si vous aimeriez recevoir d'autres communications de la part de la compagnie LEGO, veuillez sv.p. cocher ici. Als u graag verdere informatie van de LEGO Groep wilt ontvangen, kruis dan o.a.b. dit veldje aan. Ich möchte über Produkte, Angebote, Aktionen und weitere interessante Themen von der LEGO Gruppe informiert werden* (bitte ankreuzen). Om å vil få annen informasjon fra LEGO Gruppen, sett kryss her. Hvis du ønsker å motta annen informasjon fra LEGO Gruppen, merker du av her.

Post - Poste
Per Post

Email - Courriel
Per E-Mail
E-Mail

Ich möchte über Produkte, Angebote, Aktionen und weitere interessante Themen von der LEGO Gruppe informiert werden* (bitte ankreuzen). Per Post Per E-Mail

The English language version of the magazine can only be mailed to addresses in the US, Canada, the UK, and Republic of Ireland. Club membership is valid for two years and includes free copies of the LEGO Club Magazine. In the US and Canada please allow up to 6 weeks for delivery of your first magazine. In the UK and Republic of Ireland please allow six to 14 weeks for delivery of your first magazine. By signing this form you consent the LEGO Club to use your child's data for LEGO mailings. The data will only be used for LEGO mailings and will not be sold, rented or otherwise disclosed to any company outside the LEGO Company except for disclosure to companies acting as our agents to help us provide services requested by the child. This coupon is valid for one free membership per person, group or organisation. Photocopied coupons are accepted. La version française du magazine peut être postée uniquement au Canada. L'abonnement est valide pour 2 ans et inclut des exemplaires gratuits du Magazine LEGO. Aux E.-U. et au Canada, allouer 6 semaines pour la livraison initiale. En remplissant ce formulaire, vous consentez à ce que LEGO utilise les informations de votre enfant pour des envois postaux de LEGO. L'information sera utilisée uniquement pour des envois postaux par LEGO et ne sera en aucun cas, vendue, louée, échangée ou divulguée à d'autres compagnies autres que la compagnie LEGO, à l'exception des compagnies affiliées qui nous procurent des services auxquels l'enfant en a fait la demande. Das deutschsprachige LEGO Club Magazin kann nur an Adressen in Deutschland, Österreich und der Schweiz verschickt werden. Die kostenlose Mitgliedschaft beinhaltet die Zusendung des LEGO Club Magazins und endet nach zwei Jahren. Mit der Anmeldung gehen Sie keine Verpflichtungen ein. Es kann bis zu drei Monate dauern, bis das erste Magazin zugestellt wird. Mit Ihrer Unterschrift erklären Sie sich damit einverstanden, dass die Daten Ihres Kindes zum Zweck einer LEGO Club Mitgliedschaft von der LEGO Gruppe gespeichert und verarbeitet werden. Die Daten werden vertraulich behandelt, nicht an Dritte weitergegeben und nicht veräußert. Externe Dienstleister erhalten Ihre Daten nur, soweit es für die Abwicklung von LEGO Kommunikation erforderlich ist. Wenn Sie von uns nicht mehr kontaktiert werden möchten, können Sie der Verwendung Ihrer Daten für Werbezwecke widersprechen unter: 00800 5346 5555 (Anruf gebührenfrei, Kosten für Anrufe aus Mobilfunknetzen können abweichen). * Die Einwilligungen kann ich jederzeit (insgesamt oder zum Teil) ohne Einfluss auf die LEGO Club Mitgliedschaft bei der LEGO Gruppe widerrufen. Het LEGO Club Magazine kan alleen worden gestuurd naar adressen in Nederland. Het lidmaatschap is 2 jaar geldig en geeft recht op toezending van het gratis LEGO Club Magazine. Het eerste magazine zal na 12 tot 14 weken toegestuurd worden. Het lidmaatschap kan op ieder moment opgezegd worden. Door dit formulier te tekenen geeft u de LEGO Club toestemming om bovenstaande gegevens te gebruiken voor het toesturen van LEGO mailings. Uw gegevens worden uitsluitend gebruikt voor mailings van LEGO en zullen niet worden verkocht, verhuurd of op welke wijze dan ook verstrekt aan derden buiten de LEGO Groep, uitgezonderd de organisatie die namens ons optreden om de service te verlenen waar uw kind om gevraagd heeft. Den norske utgaven av magasinet sendes kun til adresser i Norge. Medlemskap i klubben gjelder i 2 år og inkluderer gratisutgaver av LEGO Magazine. Påregnet opptil seks uker leveringstid for første magasin. Ved å undertegne dette skjemaet, gir du ditt samtykke til at LEGO Club kan bruke opplysningene om barnet ditt i LEGO forsendelser. Dataene vil utelukkende bli brukt i LEGO forsendelser og vil ikke bli solgt, utleid eller på annen måte gjøres tilgjengelig for selskaper utenfor LEGO gruppen, unntatt selskaper som er våre agenter og som hjelper oss å tilby tjenestene barnet etterspør. Dette skjemaet gjelder for ett gratis medlemskap per person, gruppe eller organisasjon. Den svenska versionen av tidningen kan endast skickas till adresser i Sverige. Club-medlemskapet är giltigt i 2 år och innefattar gratis exemplar av LEGO Club Magazine. Vänligen räkna med 6 veckor för leverans av din första tidning. Genom att skicka in det här formuläret godkänner du att LEGO Club använder barnets uppgifter för LEGO utskick. Uppgifterna kommer bara att användas för LEGO utskick och kommer inte att säljas, hyras ut eller vidarebefordras till något företag som inte tillhör LEGO Gruppen, med undantag av företag som agerar som våra ombud för att tillhandahålla tjänster som barnet har begärt. Den här kupongen gäller för ett gratis medlemskap per person, grupp eller organisation.

Parent's signature - Signature of a parent - Anterskrift/Erziehungsrechtige/r
Handtekening ouders - Forældres/Forenes underskrift - Forældres/Forældres underskrift

Date
Datum
Datum

Mail to: / Poster à:

BG29

LEGO® Club
P.O. Box 1157
EnField, CT USA
06083-1157

Mail to:

BIO9U

LEGO® Club
33 Both Road
Slough SL1 3UF
United Kingdom

Per Post an:

BIO9C

LEGO® Club
Postfach 14 15
D-36243 Niederaula

Stuur op naar:

BIO9N

LEGO® Club
Postbus 40250
3504 AB Utrecht

Send til:

BIO9O

LEGO® Club Norge
Postboks 58
1314 Vøyenenga

Skickas till:

BIO9S

LEGO® Club Sverige
Ubox 841
202 29 Malmö



WIN LEGO® PRODUCTS

Fill out a survey and you might WIN a cool LEGO product
NO PURCHASE NECESSARY
Open to all residents where not prohibited
Go to www.nielsen.com/LEGO to fill out a survey for a chance to win a LEGO product

WIN LEGO® PRODUCTEN

Vul een enquêteformulier in en maak kans op een cool LEGO® product!
Kopen niet nodig
Iedereen uit landen waar geen enquêteverbod geldt mag deelnemen.
Ga naar www.nielsen.nl/multimedia/LEGO, vul een enquêteformulier in en maak kans op een LEGO product.

GEWINNE LEGO® PRODUKTE

Nimm an der Umfrage teil und GEWINNE ein tolles LEGO® Produkt!
Die Teilnahme am Gewinnspiel führt zu keinerlei Kaufverpflichtungen
Teilnahme in allen nicht ausgeschlossenen Ländern möglich
Wir verlosen unter allen Teilnehmern der Umfrage auf www.nielsen.nl/multimedia/LEGO LEGO Produkte.

GAGNE DES PRODUITS LEGO®

Réponds à un questionnaire et tu pourrais GAGNER un produit LEGO® très cool !
Aucune obligation d'achat.
Ouvert à tous les résidents des pays autorisés.
Visite www.nielsen.com/LEGO pour répondre à un questionnaire et avoir une chance de gagner un produit LEGO.

レゴ®製品を「当てよう」

アンケートに記入して、かっこいいレゴ®製品を当てよう！
お買い上げの必要はありません。
禁止されていない限り、すべての皆様にご利用いただけます。
www.nielsen.com/LEGOにアクセスして、アンケートにご記入ください。当選者にはレゴ®製品を差し上げます。

