

BIONICLE®

STRAKK



WARNING: CHOKING HAZARD.
Toy contains small parts and a small ball.
Not for children under 3 years.



8982

GLATORIAN



1

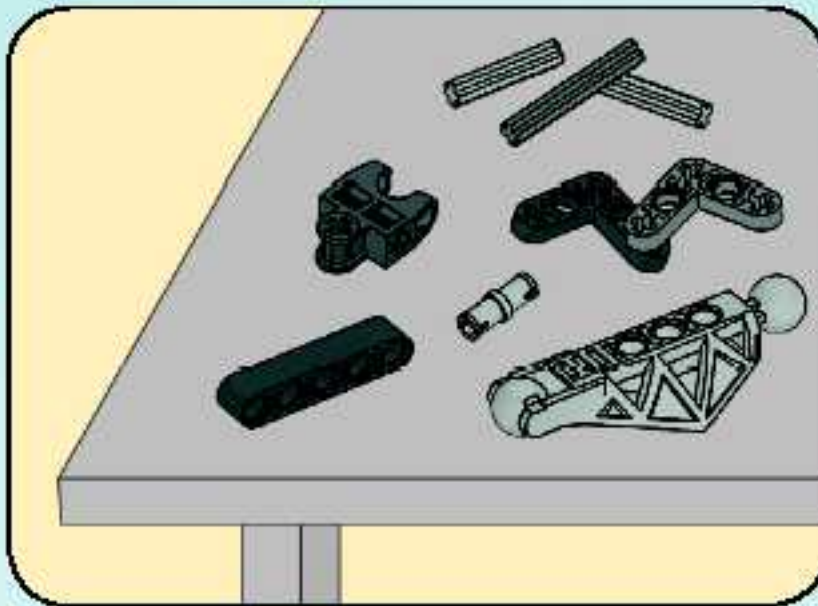

2

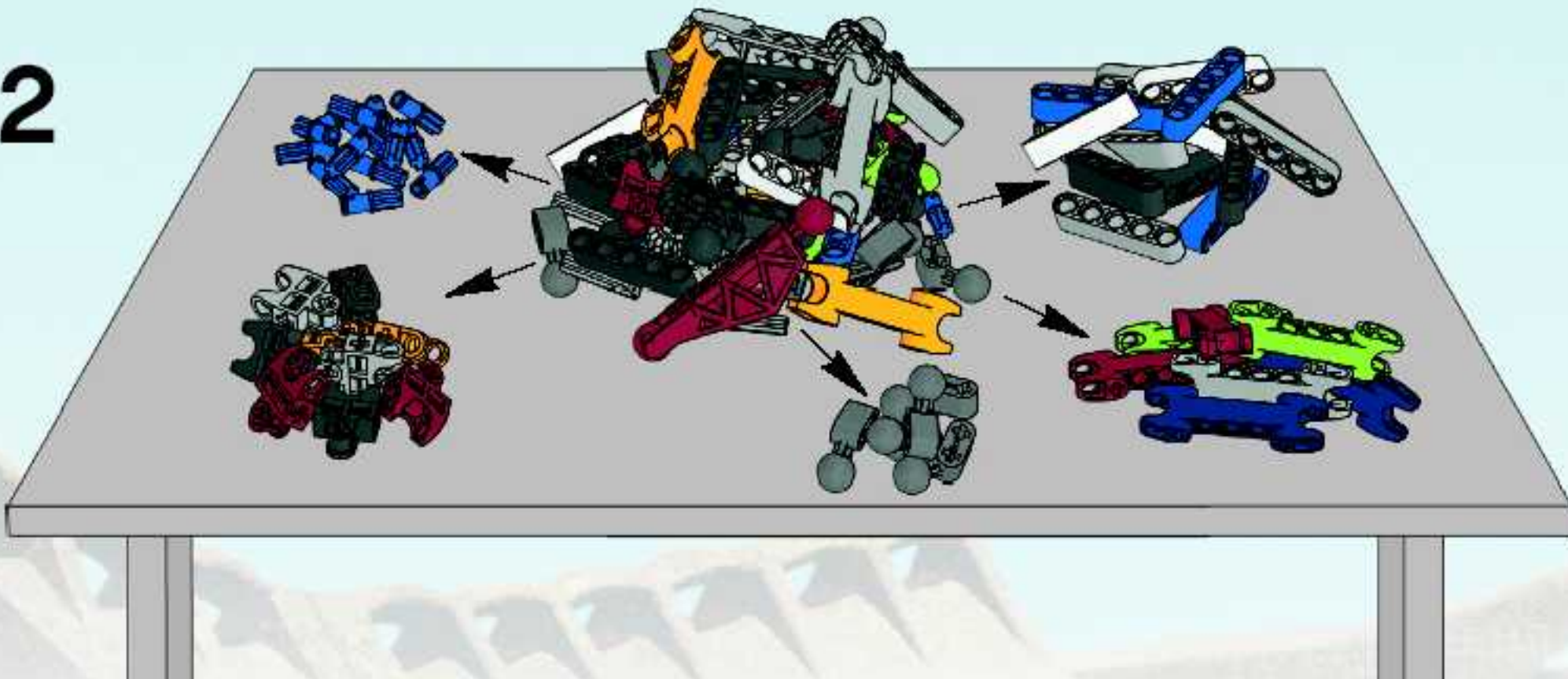

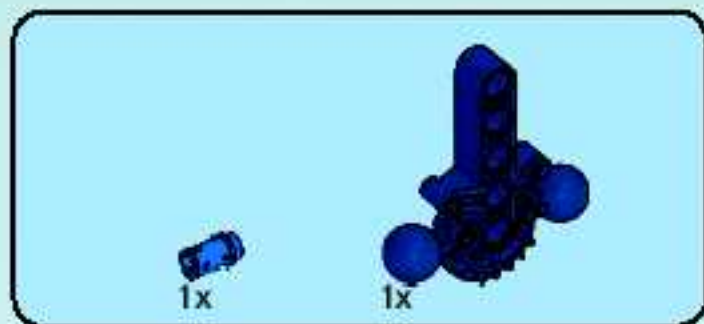

1

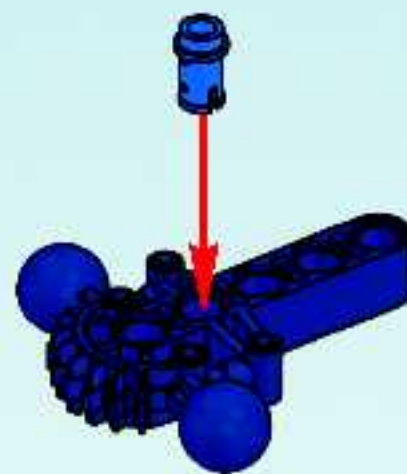

AVERTISSEMENT : RISQUE D'ÉTOUFFEMENT.

Le jouet contient des petites pièces ainsi qu'une petite boule.
Il ne convient pas aux enfants de moins de 3 ans.



ADVERTENCIA: PELIGRO DE ASFIXIA.

Juguete que contiene partes pequeñas y una pelota pequeña.
No recomendado para niños menores de 3 años.

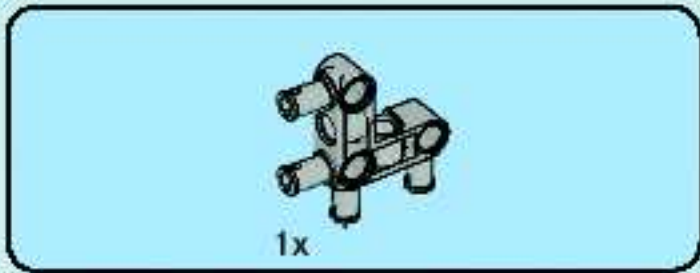

2

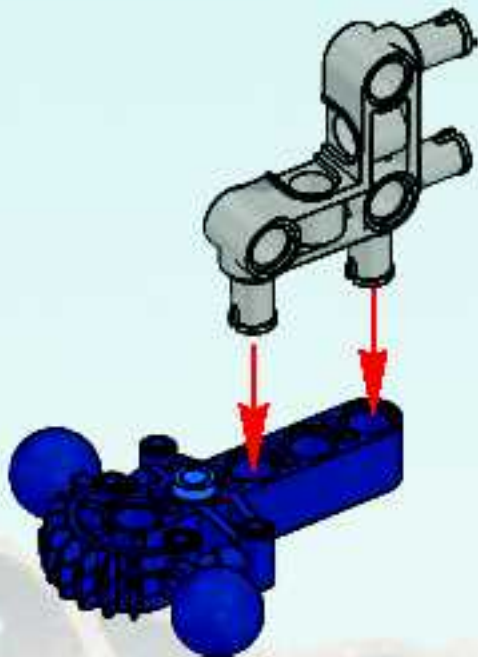

4

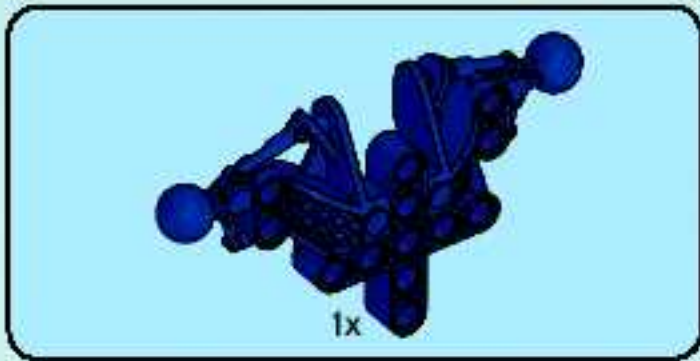

3

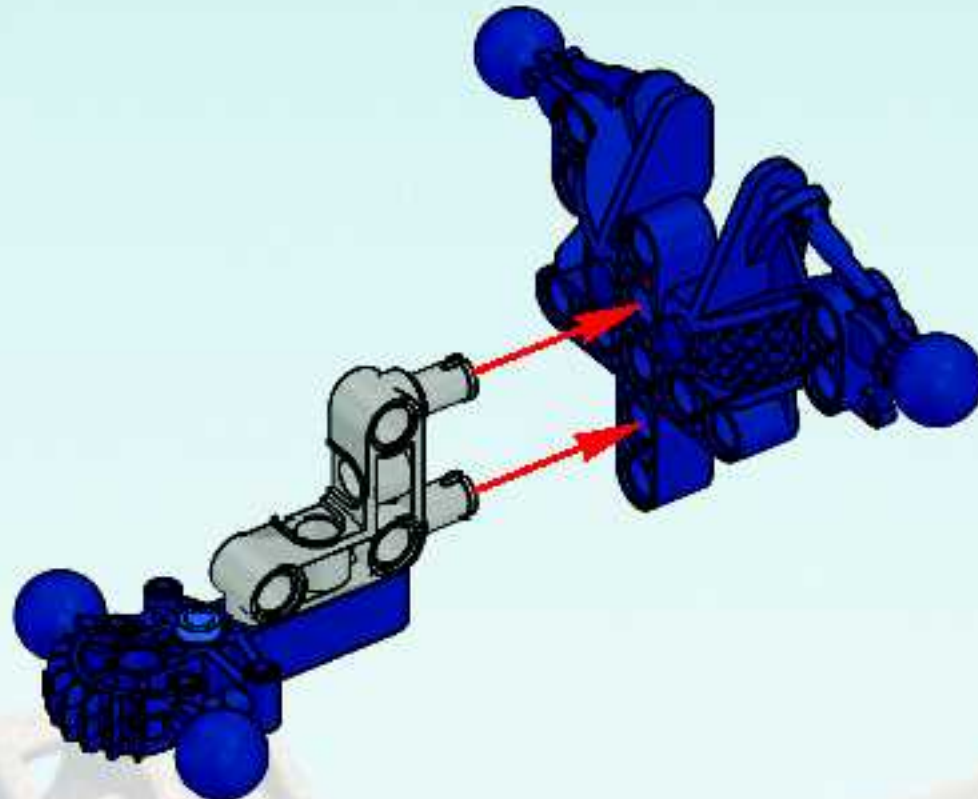

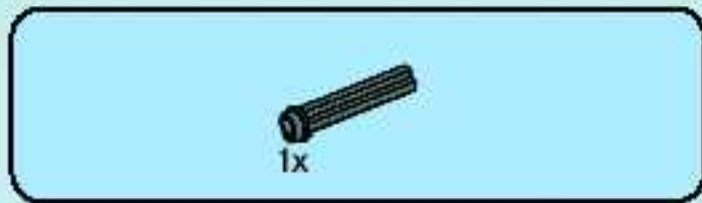

4

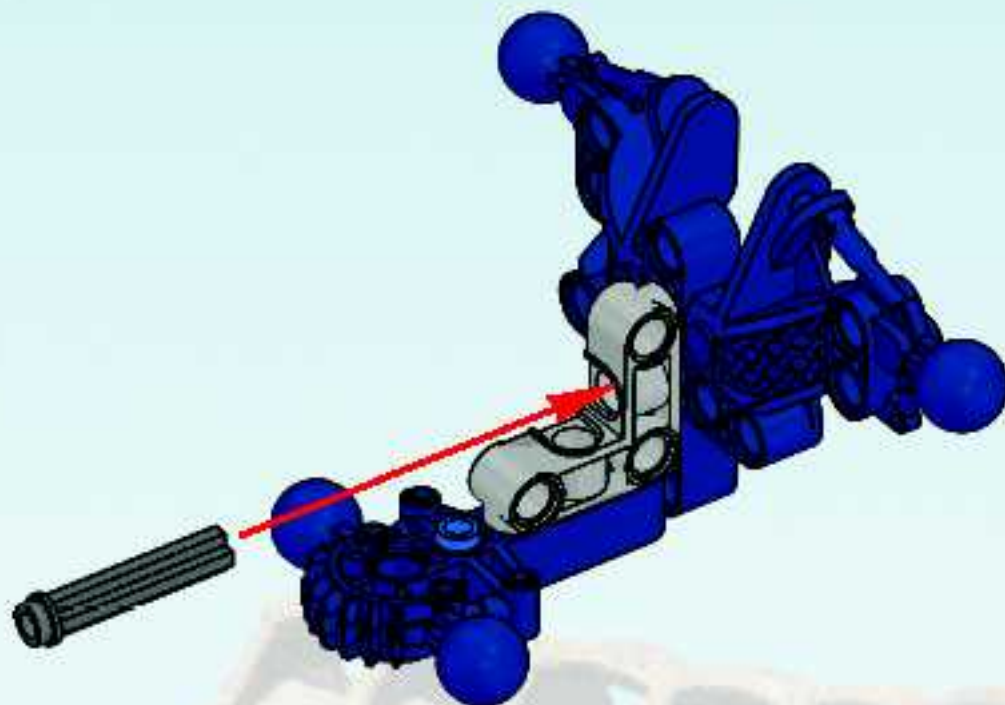

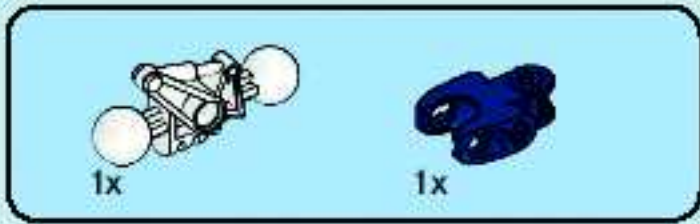

5

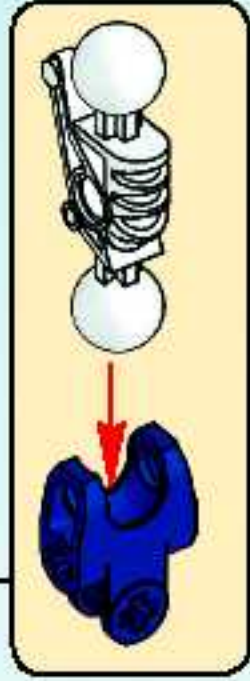
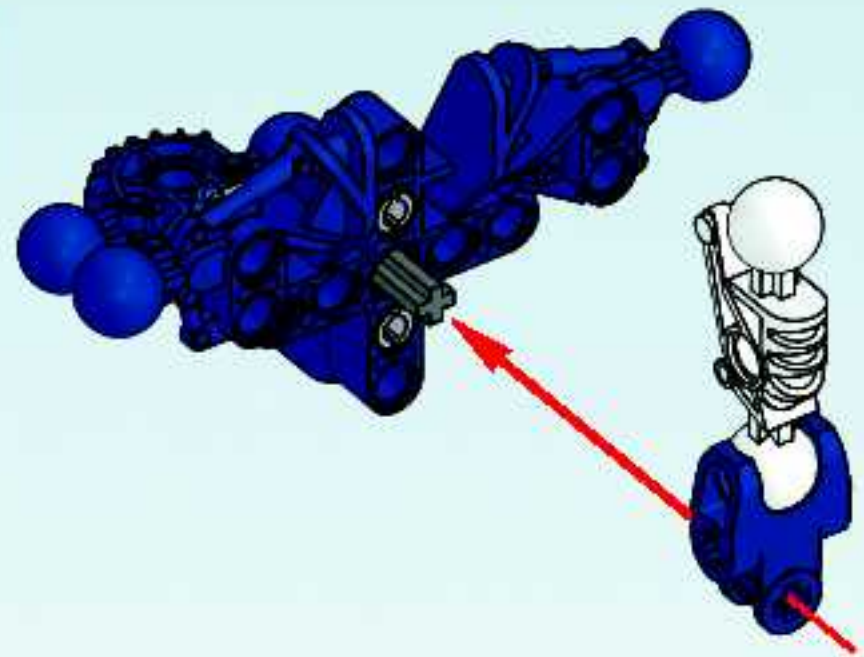

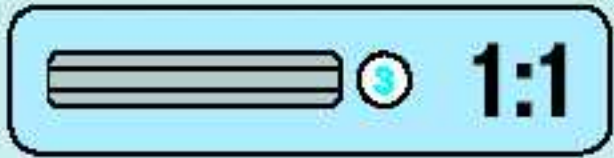
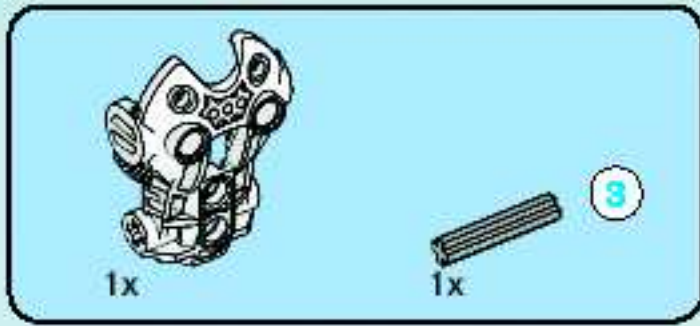

6

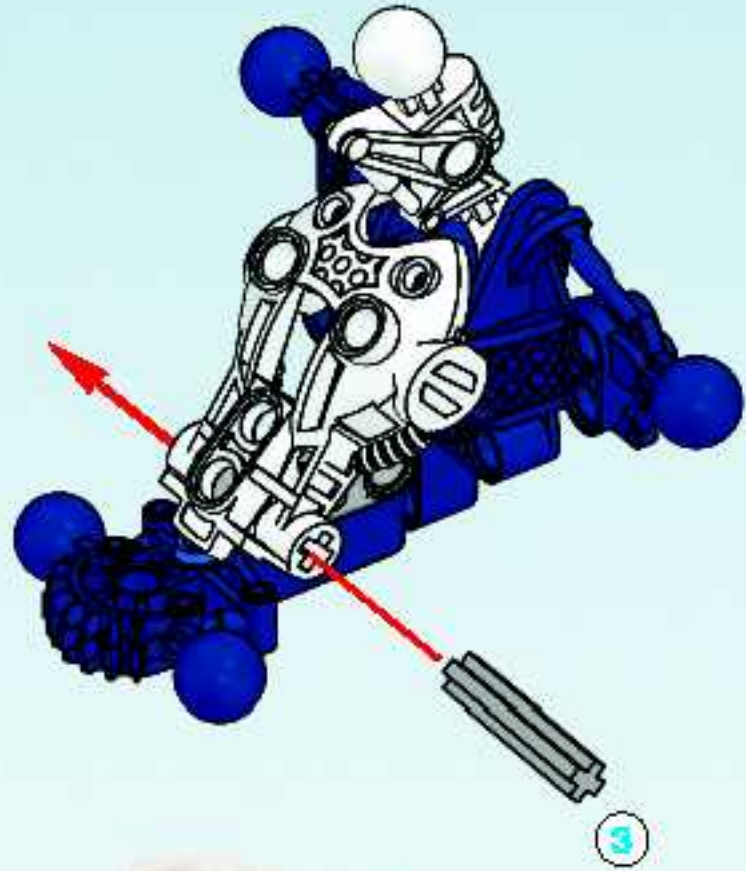

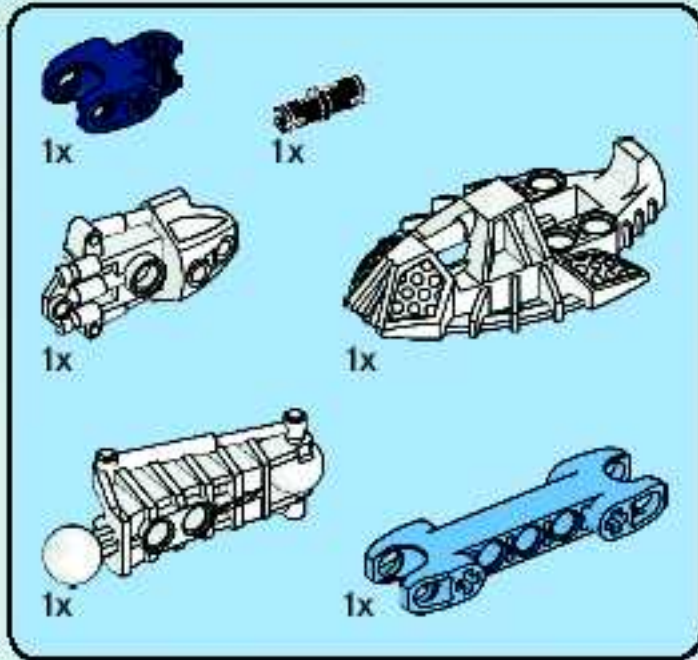
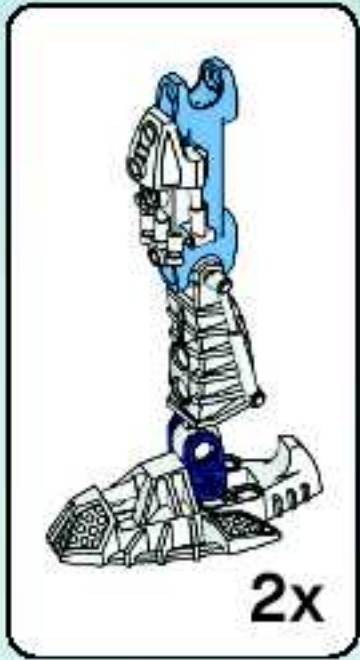

7

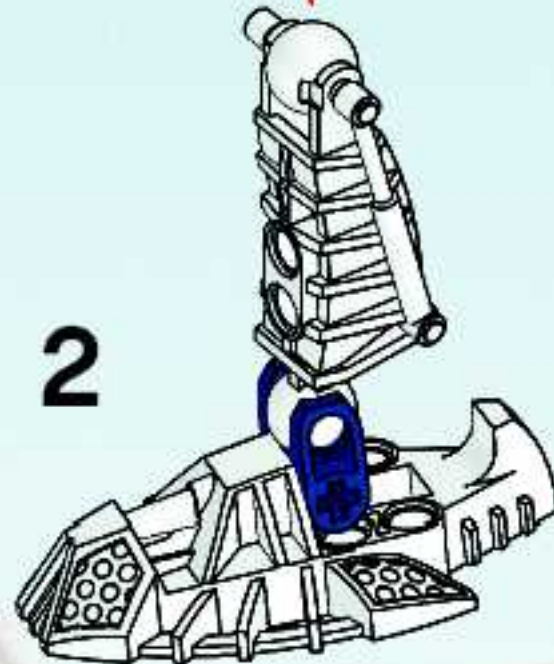

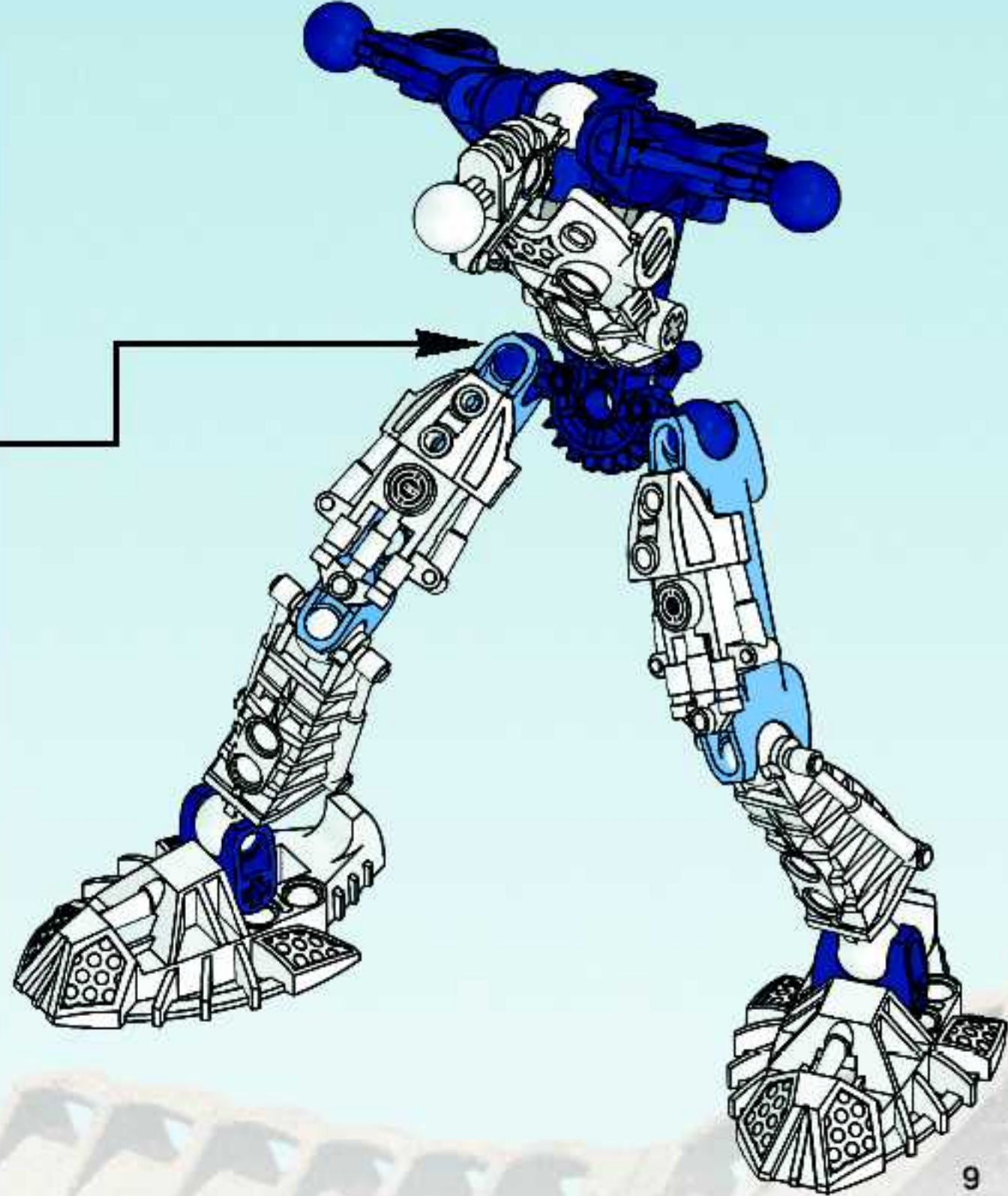
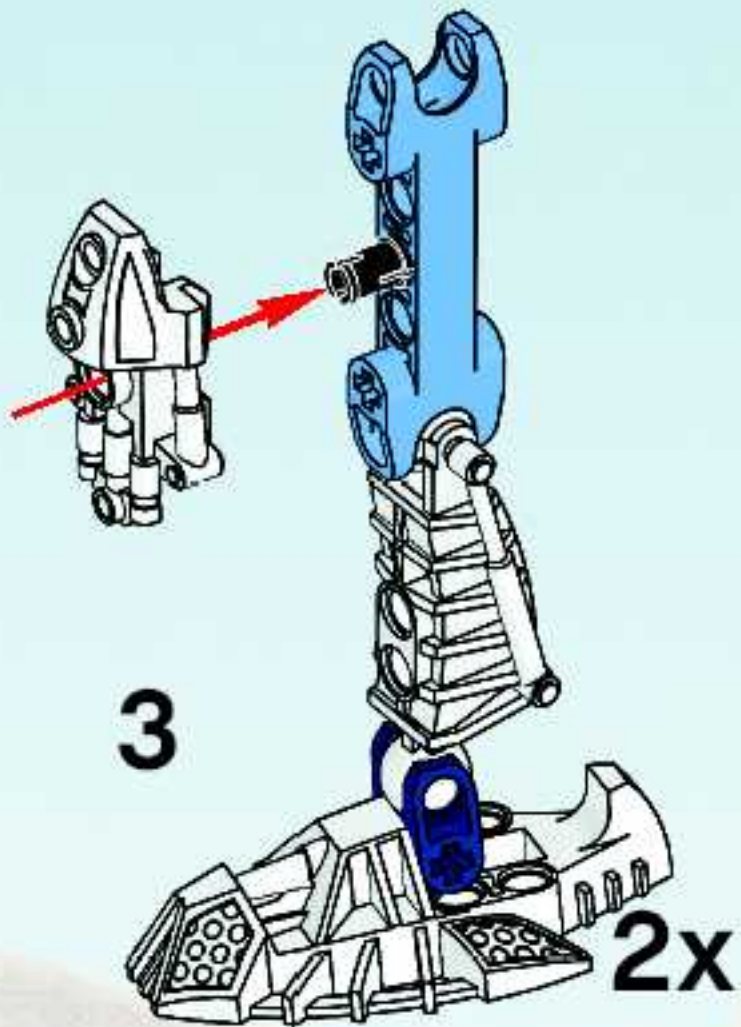

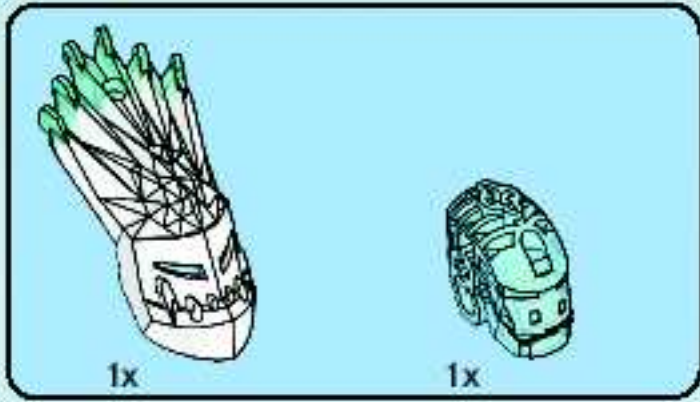

8

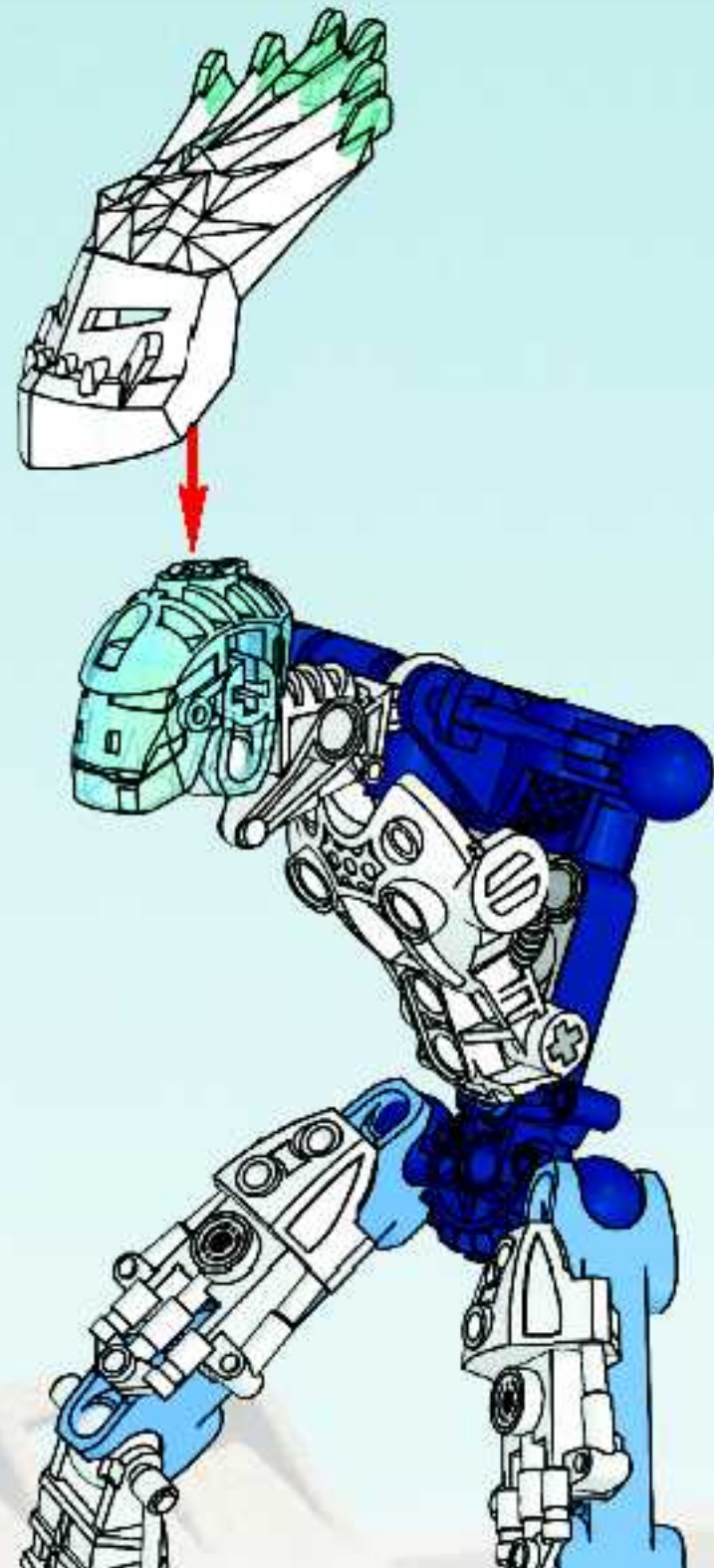

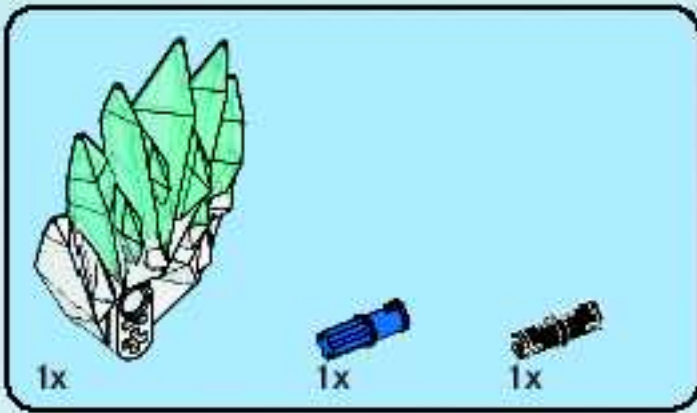

1



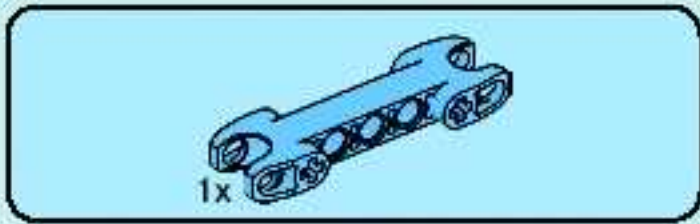

2

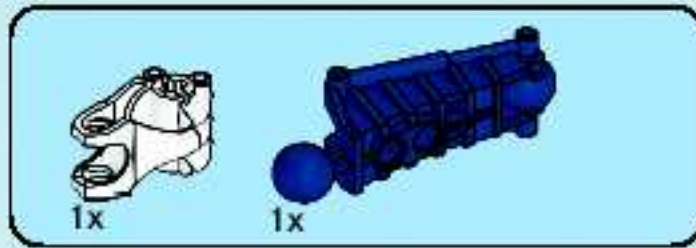
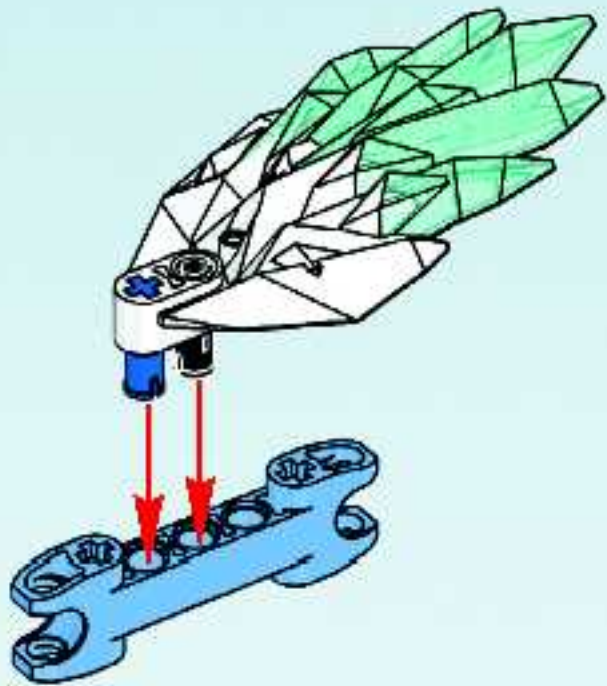

3

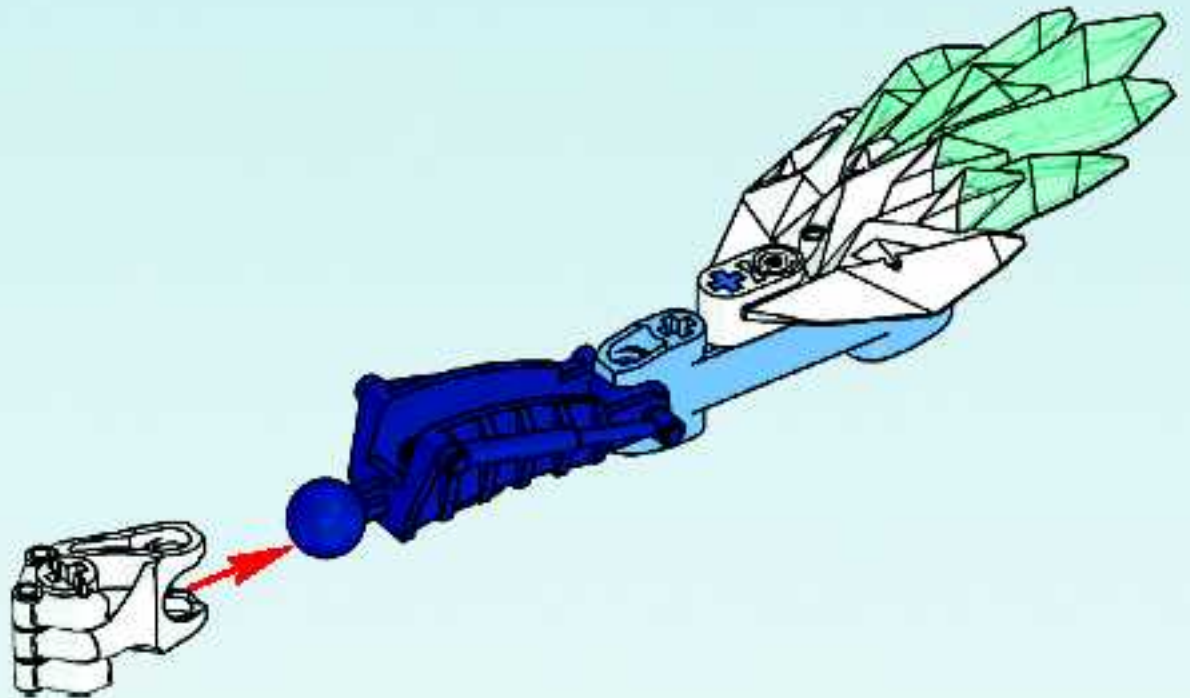

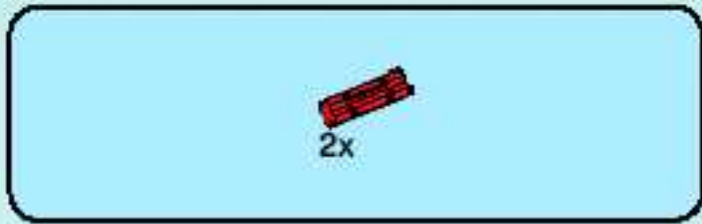

4

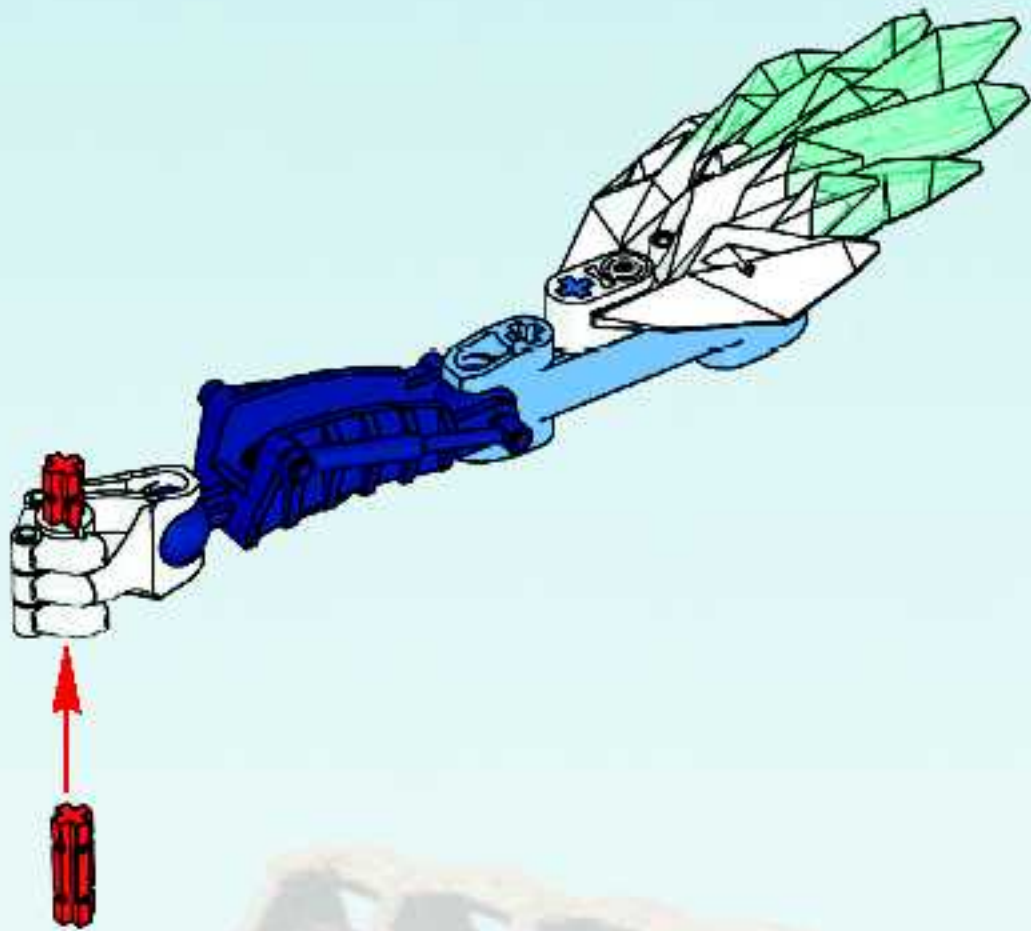

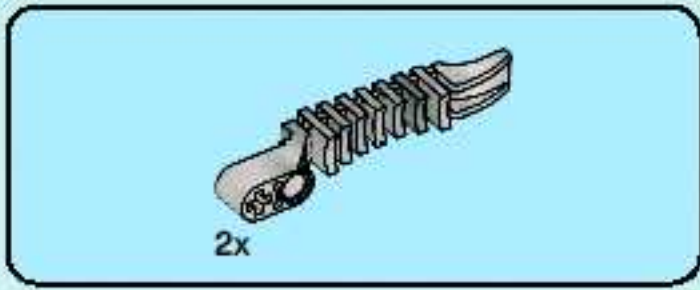

5

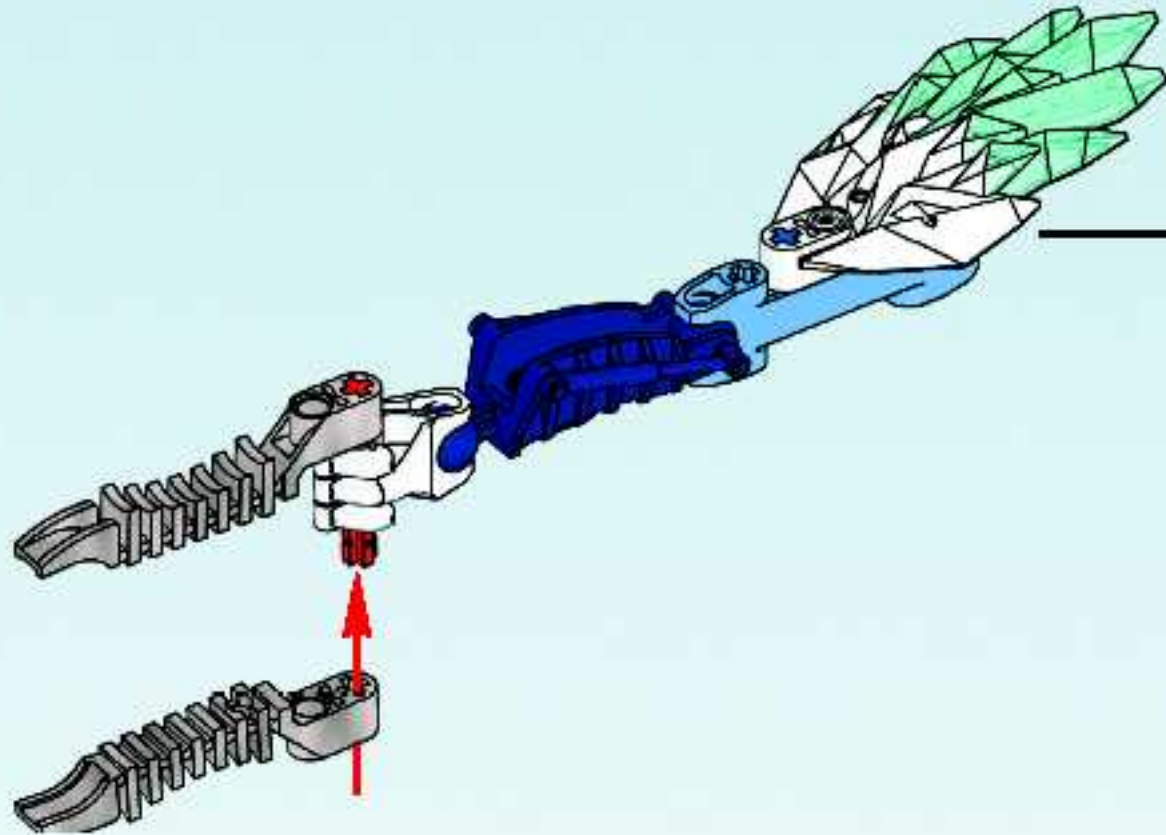

9

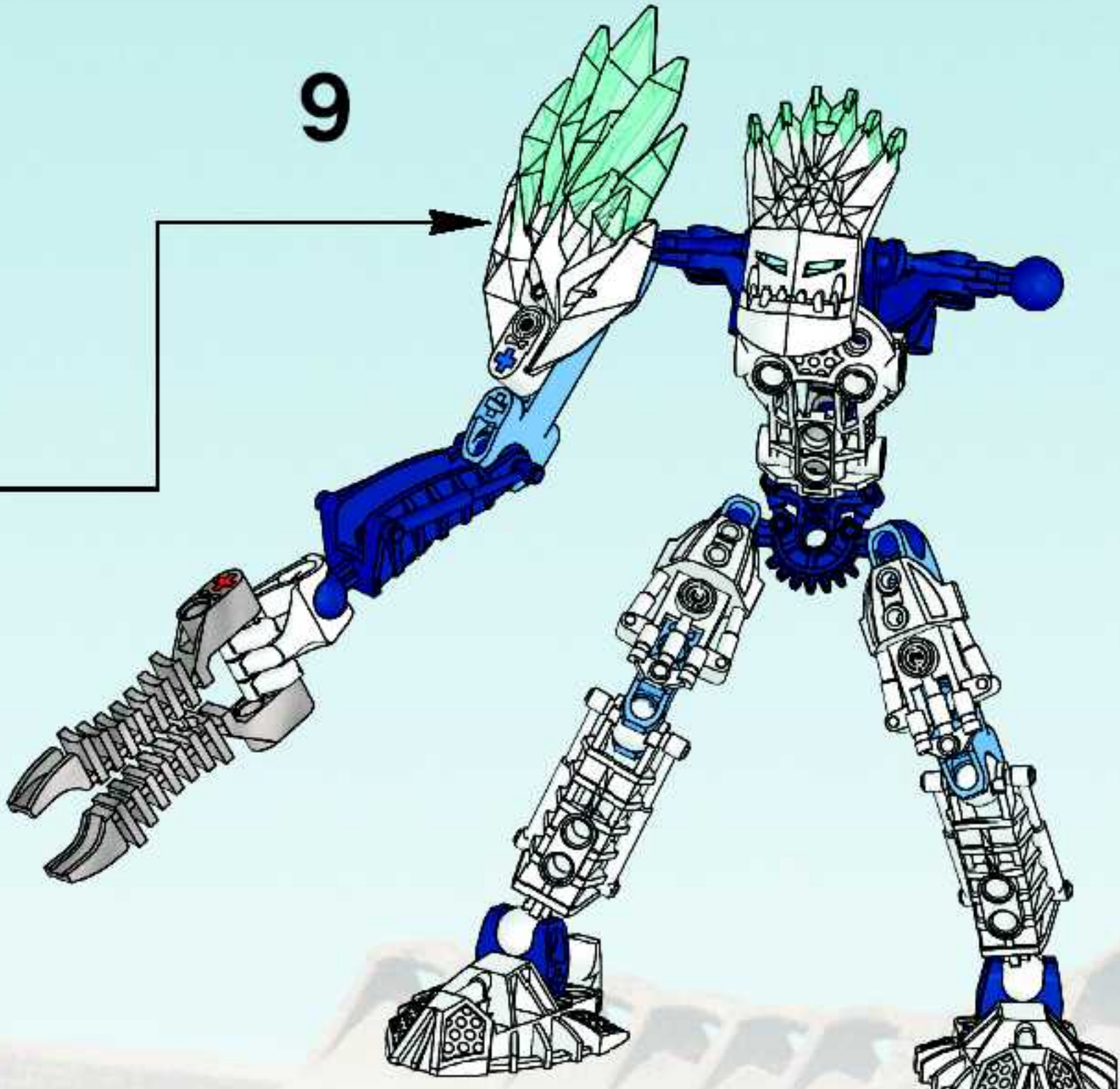

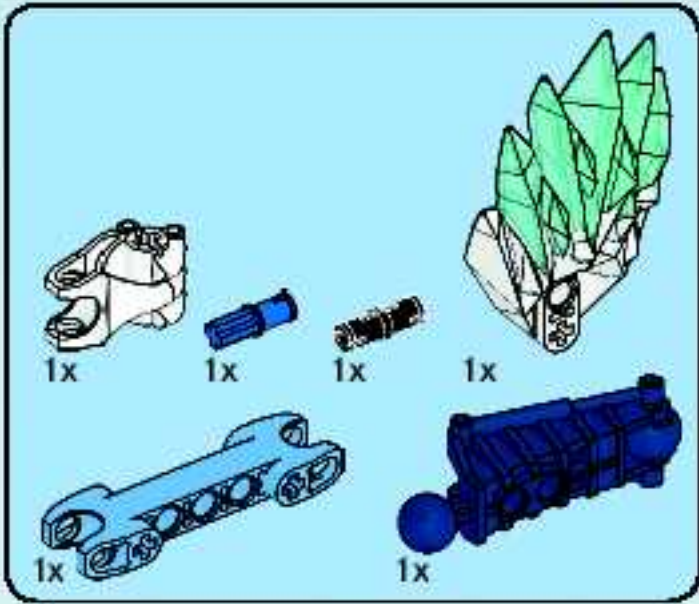

10

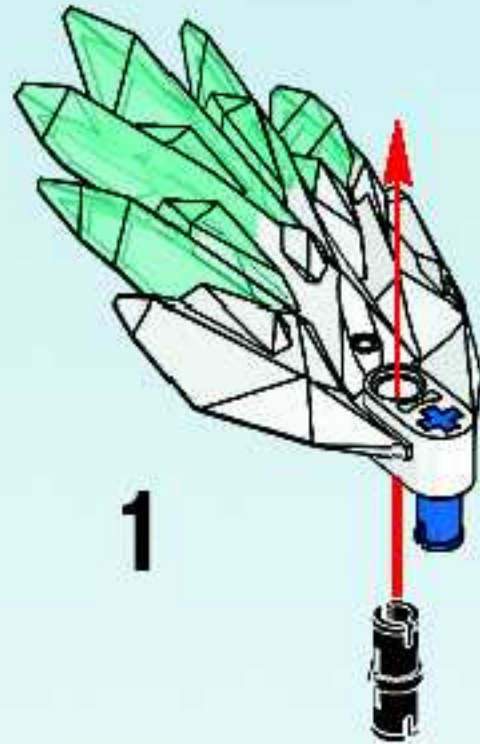

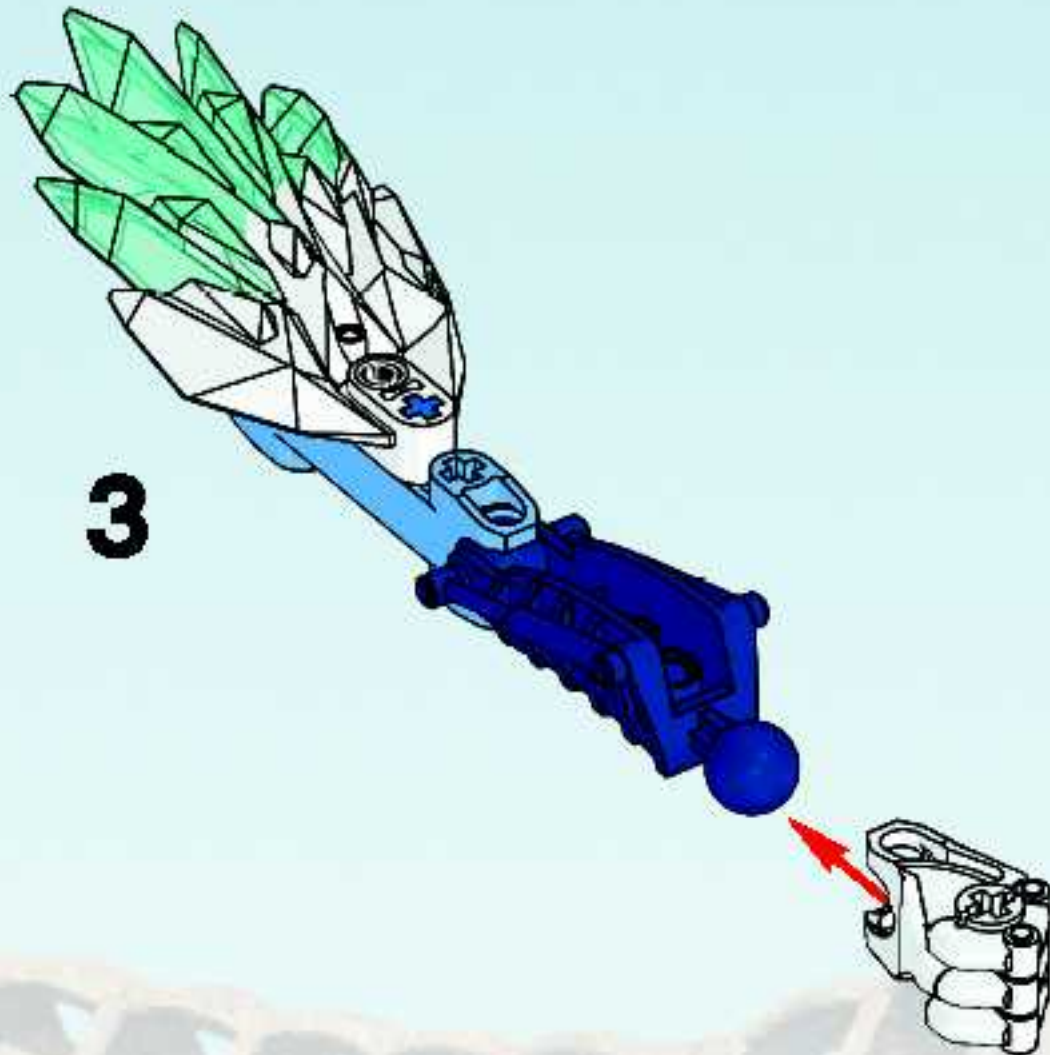
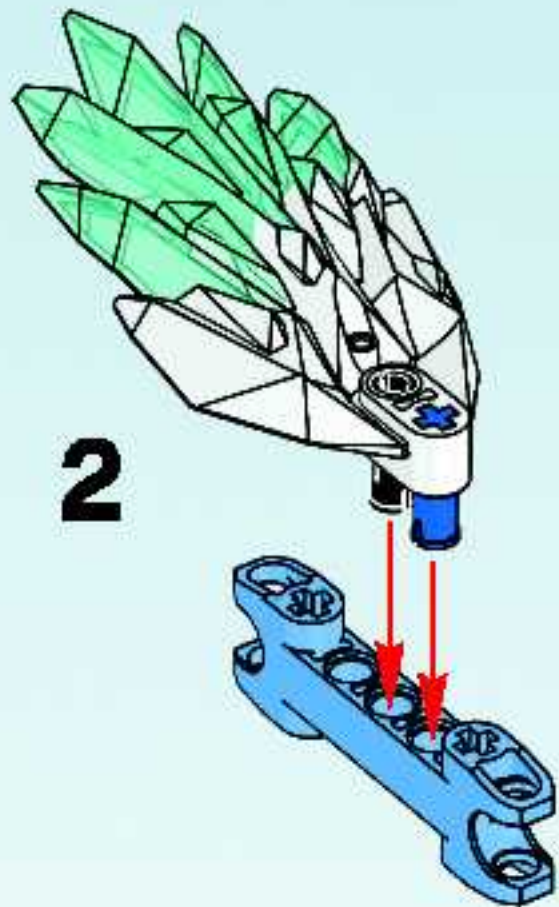

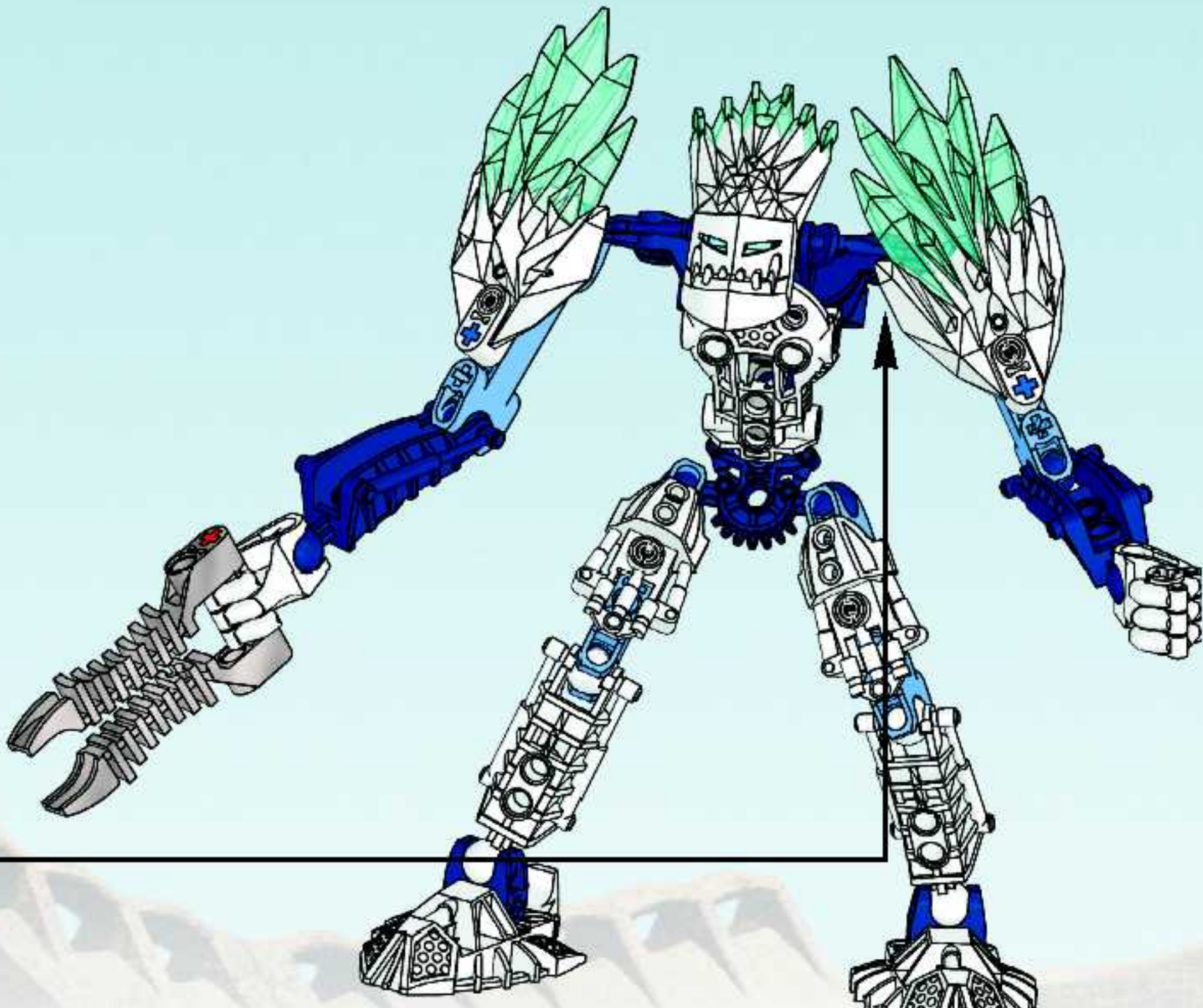

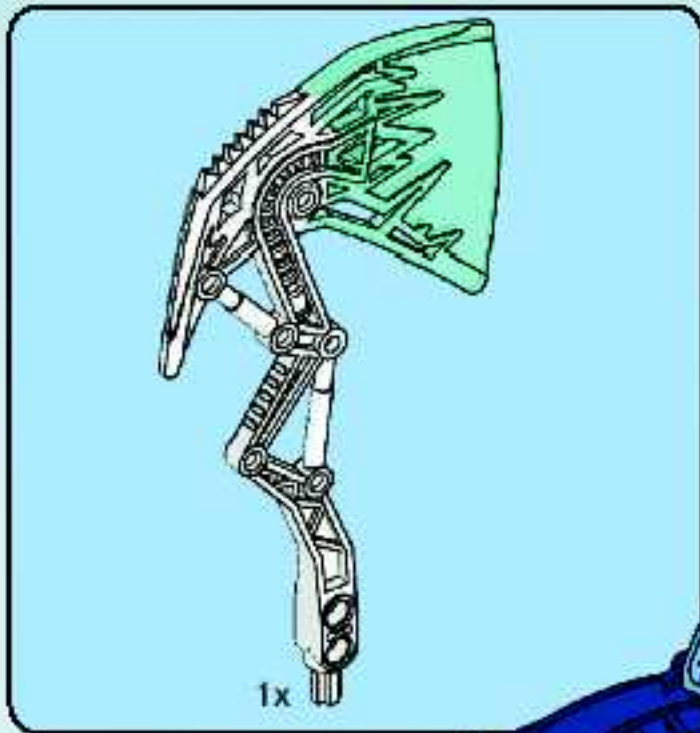

11

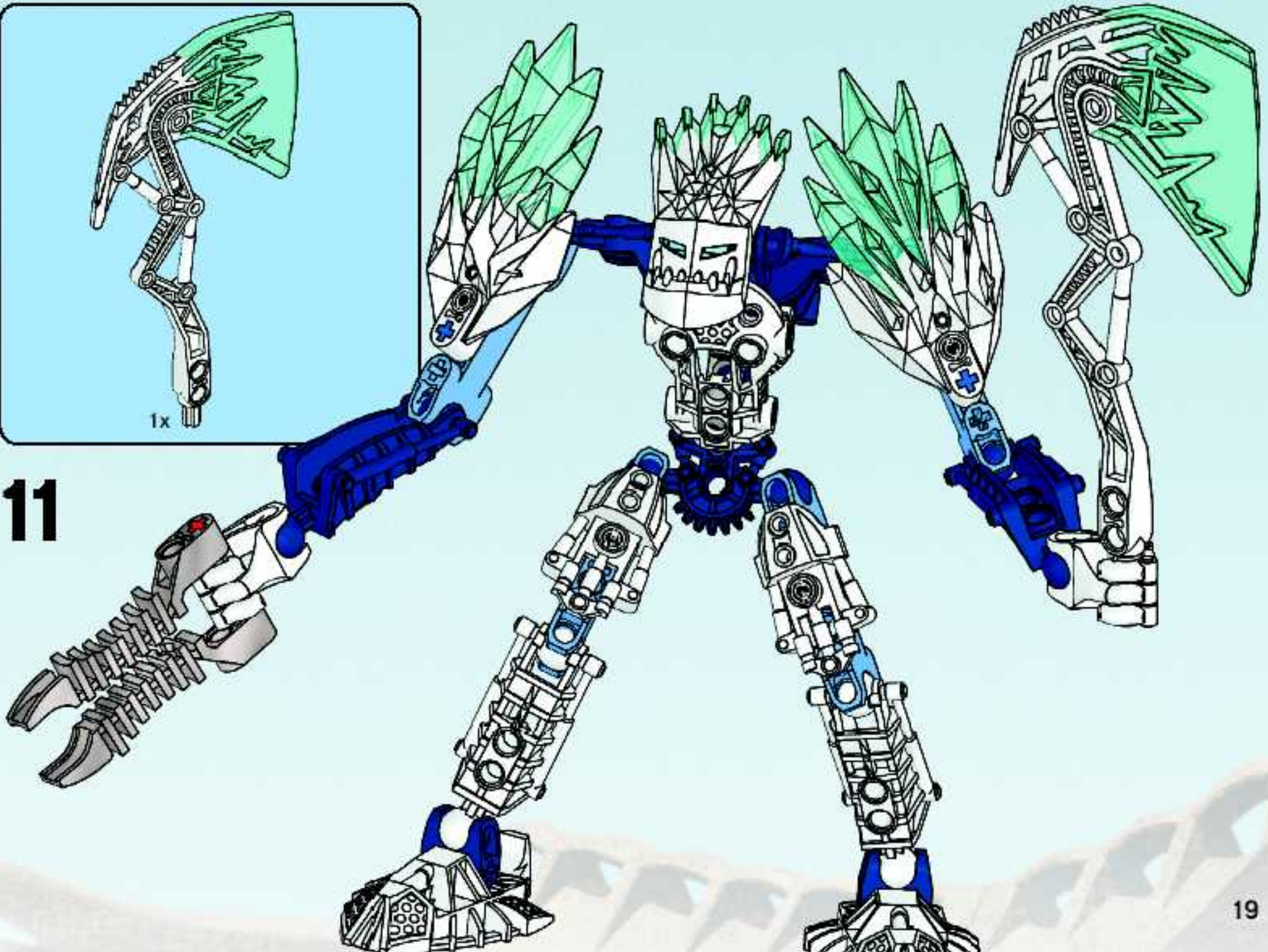

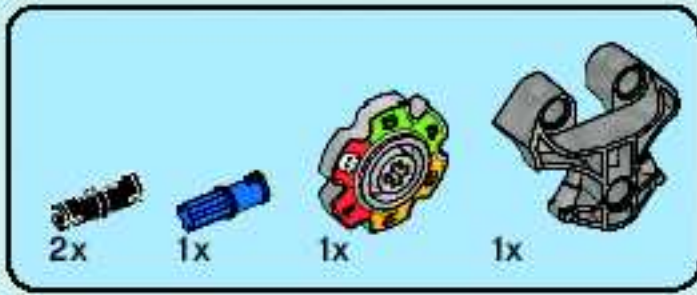

12

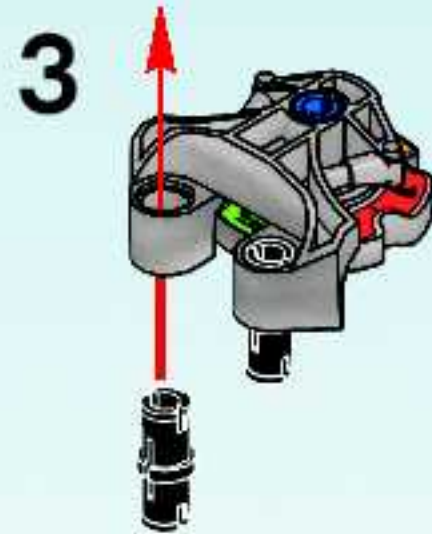
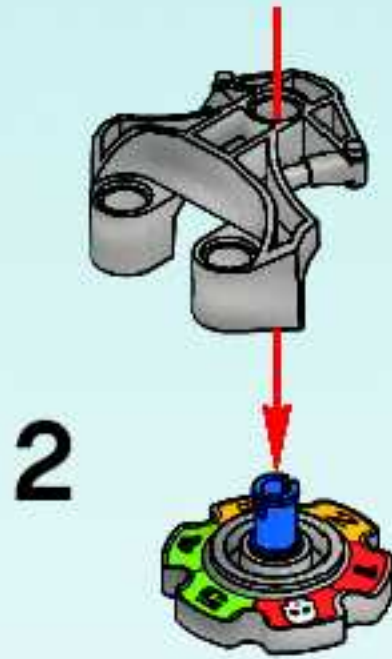
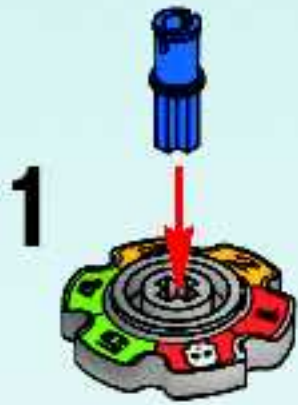

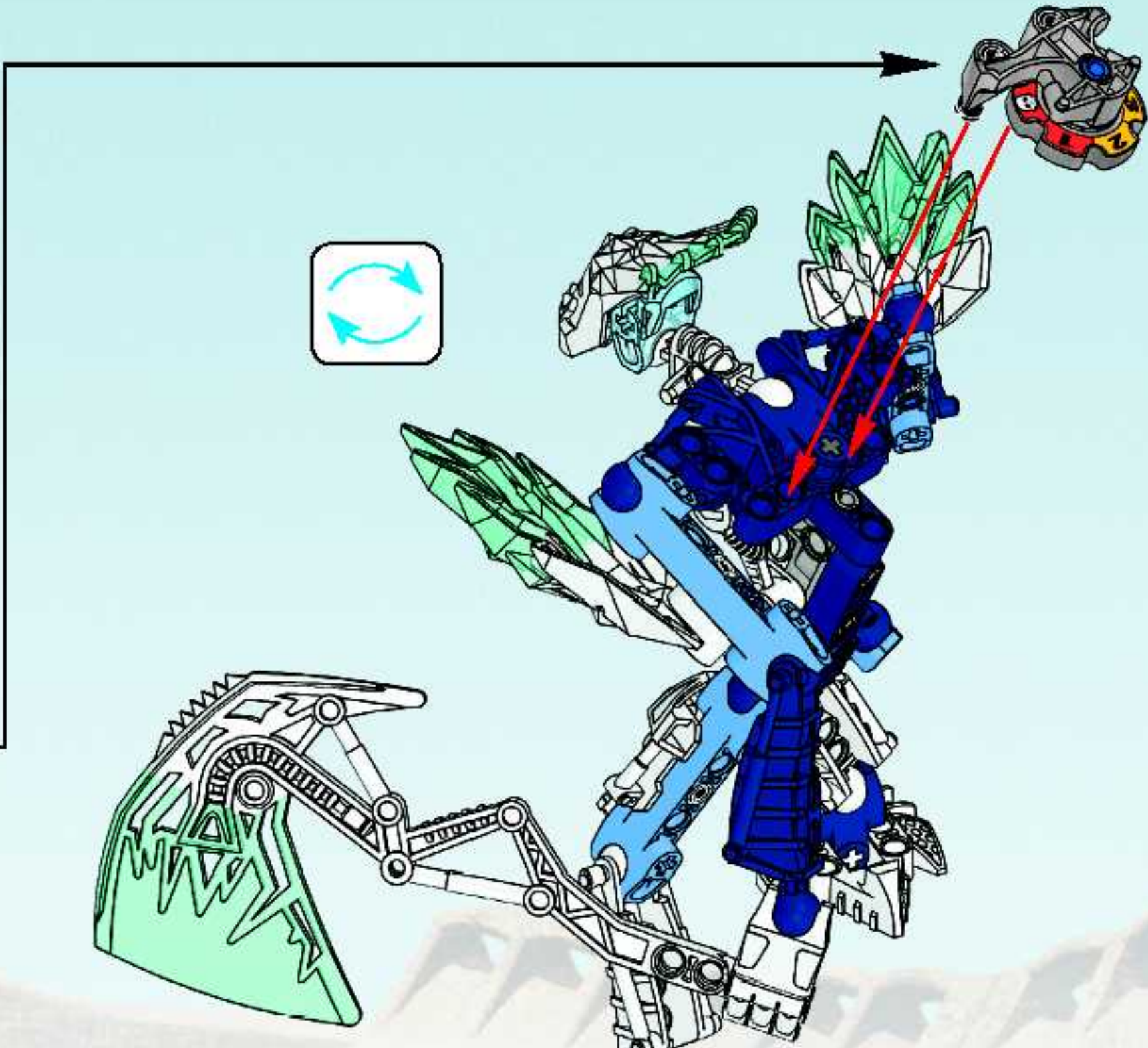



13

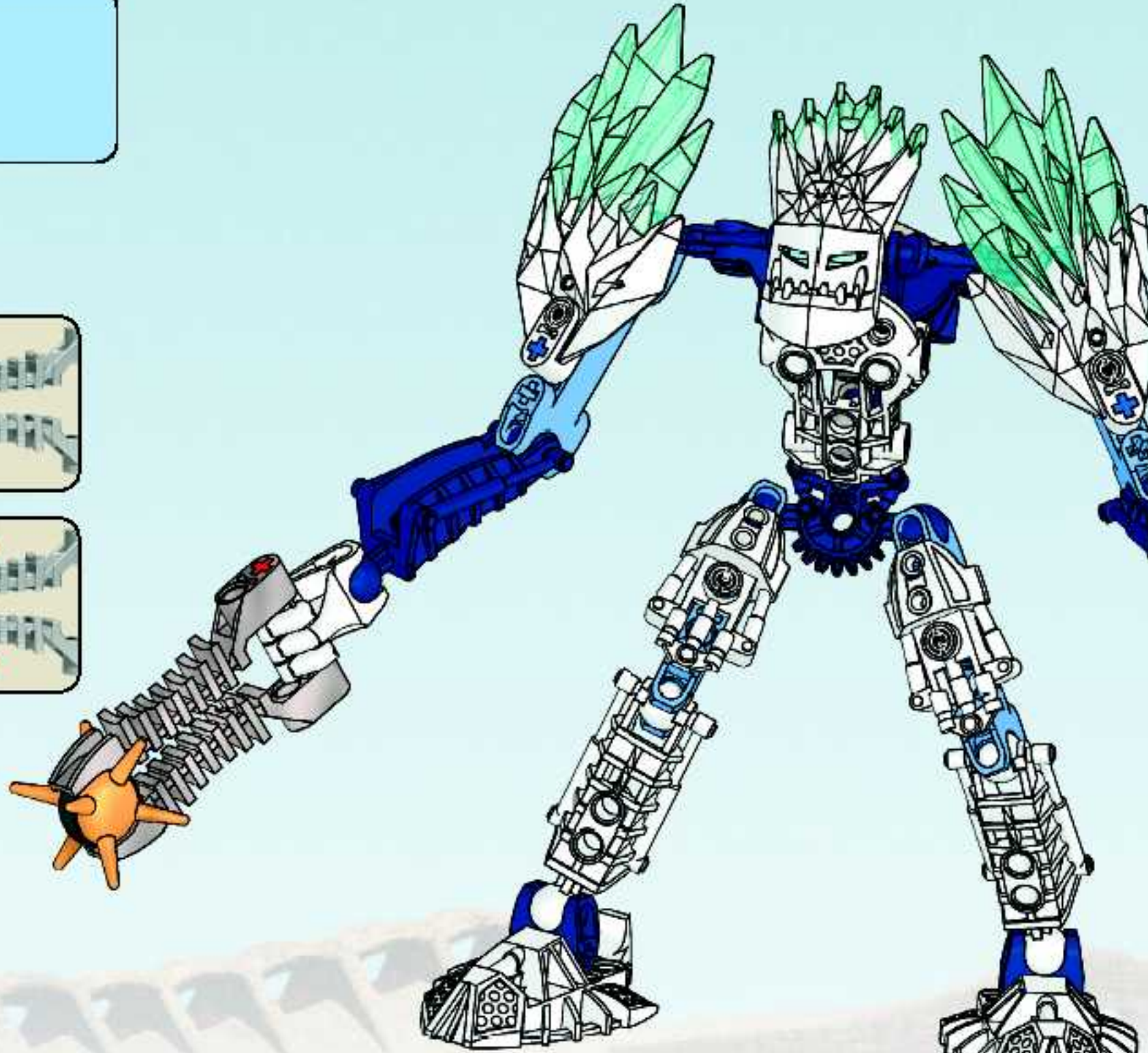
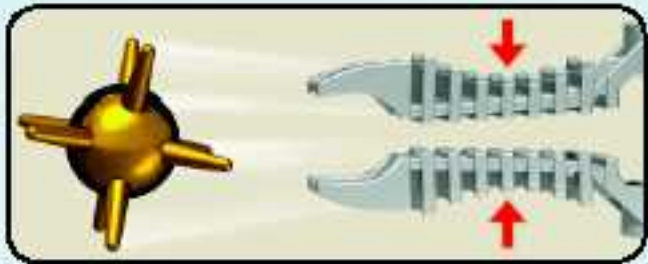
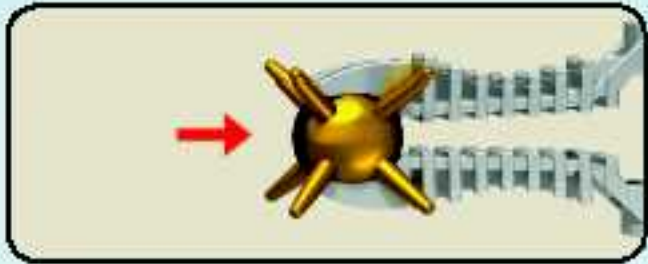

2x
4539157

6x
4121715

3x
4527059

1x
4537508

1x
4546585

1x
4278740

2x
4142865

1x
4278500

1x
4544529

2x
4281240

1x
4211086



2x
4506471

1x
4537501

1x
4537503

1x
4292642

3x
4206482

1x
4297132

2x
4537512

1x
4247224

2x
4278479

1x
4211815

1x
4296059

2x
4292521

4x
4539223

2x
4546416



Customer Service
Kundenservice
Service Consommateurs
Servicio Al Consumidor

www.lego.com/service or dial

: 00800 5346 5555
: 1-800-422-5346

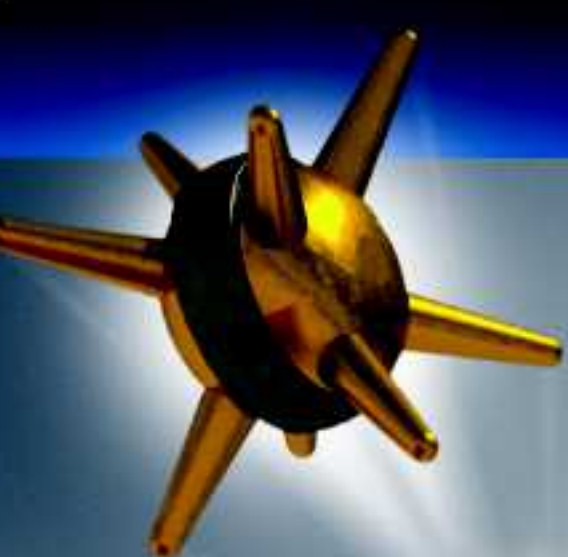

BIONICLE ACTION FIGURE
GAME



Setting Up Préparer le jeu

Prepara el juego

This game is about taking the life of your opponent before he takes yours!

1. Set up the game using 2 cans & 2 figures
2. Set the dial to 5
3. Decide who goes first

Pour gagner, il faut que tu t'empares de la vie de ton adversaire avant qu'il ne s'empare de la tienne !

1. Installe le jeu en utilisant 2 boîtes et 2 figurines
2. Positionne le cadran sur 5
3. Décide qui commence

¡El objetivo de este juego es ganar la vida de tu oponente antes que él gane la tuya!

1. Prepara el juego utilizando 2 latas y 2 figuras
2. Coloca el marcador en 5
3. Decide quién empezará



1. Hit can and opponent loses 1 life point or hit figure and opponent loses 2 points.

1. Si tu touches la boîte, ton adversaire perd 1 point de vie et si tu touches la figurine, ton adversaire perd 2 points.

1. Golpea la lata para que tu oponente pierda 1 punto de vida, o golpea la figura para que pierda 2 puntos de vida.



Playing the game: **MOVE**
Jouer au jeu : **AVANCE**

Cómo jugar: **AVANZA**

1. After shooting move figure to where ball lands.

1. Après avoir tiré, déplace la figurine à l'endroit où la balle a atterri.

1. Después de disparar, mueve la figura hasta el lugar en el que haya caído la bola.



Gana el juego

Winning the game
Gagner la partie

1. The first player to take all the opponent's life points wins!

1. Le premier joueur qui s'empare de tous les points de vie de son adversaire gagne !

1. ¡El primer jugador que junte todos los puntos de vida de su oponente ganará!

Team up
Fais équipe

Agranda tu equipo



For more rules on advanced multi-figure game play

Pour plus d'information concernant les règles des jeux de niveau avancé avec plusieurs figurines, visitez

Para más información sobre instrucciones de juego avanzado con varias figuras, consulta

www.BIONICLE.com



8974



8978



8991

8972



8972



8973



8974

www.BIONICLE.com



8975



8977



8976

FREE! GRATIS! GRATUIT!



club
MAGAZINE™

www.LEGOclub.com



00800 5346 5555*        

  **1-866-534-6258 • 1-877-518-5346**

US & Canada only

Canada seulement

* Free phone. Mobile charges may apply. * Numéro sans frais. Les frais peuvent s'appliquer avec les téléphones cellulaires.

* Gebührenfrei. Kosten für Anrufe aus Mobilfunknetzen können anfallen. * Gratis telefonnummer i landtелефon. * Telefonnummer gratis nummer, når du ringer fra fasttelefon.

* Tel gratuit, sur du ringer frais en fixe telefon.



VISIT THE WORLD'S
BIGGEST LEGO® SHOP!

www.LEGOshop.com

YES! I want to join the LEGO Club **FREE!** **OU!** Je veux m'abonner au Club LEGO **GRATITEMENT!** **Ja!** Ich möchte Mitglied im kostenlosen LEGO Club werden.
Ja! Ik wil graag **GRATIS** lid worden van de LEGO Club. **Ja!** Jeg ønsker å melde meg inn i LEGO Club gratis! **Ja!** Jag vill gå med i LEGO Club **GRATIS!**

First name - Prénom
Vorname - Voornaam
Fornavn - Firnenn

--	--	--	--	--	--	--	--	--	--	--	--	--	--	--	--	--	--	--	--	--

Last name - Nom de Famille
Name - Achternam
Etternavn - Efternavn

--	--	--	--	--	--	--	--	--	--	--	--	--	--	--	--	--	--	--	--	--

Date of Birth - Date de naissance
Geburtsdag - Geboortedatum
Fødselsdato - Fødselsdato

--	--	--	--	--	--	--	--

Boy - Garçon
Junge - Jongen
Gutt - Pojke

Girl - fille
Mädchen - Meisje
Jente - Flicka

Street - Adresse
Strafte, Housnr.
Straot huisnr. - Adress

--	--	--	--	--	--	--	--	--	--	--	--	--	--	--	--	--	--	--	--	--

City - Ville
Ort - Woonplaats
Poststad - Postort

--	--	--	--	--	--	--	--	--	--	--	--	--	--	--	--	--	--	--	--	--

State
Prov.
County

--	--	--	--	--	--	--	--	--	--	--	--	--	--	--	--	--	--	--	--	--

Zip/Postcode - Code Postal
PLZ - Postcode - Postnummer

--	--	--	--	--	--	--	--	--	--	--	--	--	--	--	--	--	--	--	--	--

Country
Pays - Land

--	--	--	--	--	--	--	--	--	--	--	--	--	--	--	--	--	--	--	--	--

Please tick below if you would like to receive other communication from the LEGO Group. Si vous aimeriez recevoir d'autres communications de la part de la compagnie LEGO, veuillez s.v.p. cocher ici. Als u graag verdere informatie van de LEGO Groep wilt ontvangen, kruis dan o.v.b. dit veldje aan. Ich möchte über Produkte, Angebote, Aktionen und weitere interessante Themen von der LEGO Gruppe informiert werden* (bitte ankreuzen). Om du vill få annen informasjon fra LEGO Gruppen, sett kryss her. Hvis du ønsker å motta annen informasjon fra LEGO Gruppen, merker du av her.

Post - Poste
Per Post Email - Courriel
Per E-Mail
E-Mail

--	--	--	--	--	--	--	--	--	--	--	--	--	--	--	--	--	--	--	--	--

Ich möchte über Produkte, Angebote, Aktionen und weitere interessante Themen von sonstigen LEGO Partnerunternehmen informiert werden* (bitte ankreuzen). Per Post Per E-Mail

The English language version of the magazine can only be mailed to addresses in the US, Canada, the UK, and Republic of Ireland. Club membership is valid for two years and includes free copies of the LEGO Club Magazine. In the US and Canada please allow up to 6 weeks for delivery of your first magazine. In the UK and Republic of Ireland please allow six to 14 weeks for delivery of your first magazine. By signing this form you consent the LEGO Club to use your child's data for LEGO mailings. The data will only be used for LEGO mailings and will not be sold, rented or otherwise disclosed to any company outside the LEGO Company except for disclosure to companies acting as our agents to help us provide services requested by the child. This coupon is valid for one free membership per person, group or organisation. Photocopied coupons are accepted. La version française du magazine peut être postée uniquement au Canada. L'abonnement est valide pour 2 ans et inclut des exemplaires gratuits du Magazine LEGO. Aux E.-U. et au Canada, allouer 6 semaines pour la livraison initiale. En remplissant ce formulaire, vous consentez à ce que LEGO utilise les informations de votre enfant pour des envois postaux de LEGO. L'information sera utilisée uniquement pour des envois postaux par LEGO et ne sera en aucun cas, vendue, louée, échangée ou divulguée à d'autres compagnies autres que la compagnie LEGO, à l'exception des compagnies affiliées qui nous procurent des services auxquels l'enfant en a fait la demande. Das deutschsprachige LEGO Club Magazin kann nur an Adressen in Deutschland, Österreich und der Schweiz verschickt werden. Die kostenlose Mitgliedschaft beinhaltet die Zusendung des LEGO Club Magazines und endet nach zwei Jahren. Mit der Anmeldung gehen Sie keine Verpflichtungen ein. Es kann bis zu drei Monate dauern, bis das erste Magazin zugestellt wird. Mit Ihrer Unterschrift erklären Sie sich damit einverstanden, dass die Daten Ihres Kindes zum Zweck einer LEGO Club Mitgliedschaft von der LEGO Gruppe gespeichert und verarbeitet werden. Die Daten werden vertraulich behandelt, nicht an Dritte weitergegeben und nicht veräußert. Externe Dienstleister erhalten Ihre Daten nur, soweit es für die Abwicklung von LEGO Kommunikation erforderlich ist. Wenn Sie von uns nicht mehr kontaktiert werden möchten, können Sie der Verwendung Ihrer Daten für Werbezwecke widersprechen unter: 00800 5346 5555 (Anruf gebührenfrei, Kosten für Anrufe aus Mobilfunknetzen können abweichen). * Die Einwilligungen kann ich jederzeit (insgesamt oder zum Teil) ohne Einfluss auf die LEGO Club Mitgliedschaft bei der LEGO Gruppe widerrufen. Het LEGO Club Magazine kan alleen worden gestuurd naar adressen in Nederland. Het lidmaatschap is 2 jaar geldig en geeft recht op toezending van het gratis LEGO Club Magazine. Het eerste magazine zal na 2 tot 14 weken toegezonden worden. Het lidmaatschap kan op ieder moment opgezegd worden. Door dit formulier te tekenen geeft u de LEGO Club toestemming om bovenstaande gegevens te gebruiken voor het toesturen van LEGO mailings. Uw gegevens worden uitsluitend gebruikt voor mailings van LEGO en zullen niet worden verkocht, verhuurd of op welke wijze dan ook verstrekt aan derden buiten de LEGO Groep, uitgezonderd de organisaties die namens ons optreden om de service te verlenen waar uw kind om gevraagd heeft. Den norske utgaven av magasinet sendes kun til adresser i Norge. Medlemskap i klubben gjelder i 2 år og inkluderer gratisutgaver av LEGO Magazine. Påregn opp til seks uker leveringstid for første magasin. Ved å undertegne dette skjemaet, gir du ditt samtykke til at LEGO Club kan bruke opplysningene om barnet ditt i LEGO forsendelser. Dataene vil uetukkende bli brukt i LEGO forsendelser og vil ikke bli solgt, utleid eller på annen måte gjøres tilgjengelig for selskaper utenfor LEGO gruppen, unntatt selskaper som er våre agenter og som hjelper oss å tilby tjenestene barnet etterspur. Dette skjemaet gjelder for ett gratis medlemskap per person, gruppe eller organisasjon. Den svenska versionen av tidsningen kan endast skickas till adresser i Sverige. Club-medlemskapet är giltigt i 2 år och innefattar gratis exemplar av LEGO Club Magazine. Vänligen räkna med 6 veckor för leverans av din första tidning. Genom att skicka in det här formuläret godkänner du att LEGO Club använder barnets uppgifter för LEGO utskick. Uppgifterna kommer bara att användas för LEGO utskick och kommer inte att säljas, hyras ut eller vidarebefordras till något företag som inte tillhör LEGO Gruppen, med undantag av företag som agerar som våra ombud för att tillhandahålla tjänster som barnet har begärt. Den här kupongen gäller för ett gratis medlemskap per person, grupp eller organisation.

Mail to: / Poster à:



BG29

LEGO Club
P.O. Box 1157
EnField, CT USA
06083-1157

Mail to:



B109U

LEGO Club
33 Bath Road
Slough SL1 3UF
United Kingdom

Per Post on:



B109C

LEGO Club
Postfach 14 15
D-36243 Niederrhein

Stuur op naar:



B109N

LEGO Club
Postbus 40250
3504 AB Utrecht

Send til:



B109O

LEGO Club Norge
Postboks 58
1314 Vøyeneng

Skicka till:



B109S

LEGO Club Sverige
Ubox 841
202 29 Malmö

Parent's signature - Signature d'un parent - Unterschrift Beziehungsberechtigte/r
Bambekening underskrift - Forældre/Forettes underskrift - Forælders/Forældernes underskrift

Date
Datum
Date



WIN LEGO® PRODUCTS

Fill out a survey and you might WIN a cool LEGO product!
NO PURCHASE NECESSARY

Open to all residents where not prohibited
Go to www.nielsenaim.dk/LEGO to fill out a survey for a chance to win a LEGO product.

WIN LEGO® PRODUCTEN

Vul een enquêteformulier in en maak kans op een cool LEGO® product!

Kopen niet nodig
Iedereen uit landen waar geen enquêteverbod geldt mag deelnemen.

Ga naar www.nielsenaim.dk/LEGO, vul een enquêteformulier in en maak kans op een LEGO product.

GEWINNE LEGO® PRODUKTE

Nimm an der Umfrage teil und GEWINNE ein tolles LEGO® Produkt!
Die Teilnahme am Gewinnspiel führt zu keinerlei Kaufverpflichtungen

Teilnahme in allen nicht ausgeschlossenen Ländern möglich
Wir verlosen unter allen Teilnehmern der Umfrage auf www.nielsenaim.dk/LEGO LEGO Produkte.

GAGNE DES PRODUITS LEGO®

Réponds à un questionnaire et tu pourrais GAGNER un produit LEGO® très cool !

Aucune obligation d'achat.
Ouvert à tous les résidents des pays autorisés.
Visite www.nielsenaim.dk/LEGO pour répondre à un questionnaire et avoir une chance de gagner un produit LEGO.

レゴ®製品を「当てよう」

アンケートに記入して、かっこいいレゴ®製品を当てよう！

お買い上げの必要はありません。
禁止されていない限り、すべての皆様にご利用いただけます。

www.nielsenaim.dk/LEGOにアクセスして、アンケートにご記入ください。当選者にはレゴ®製品を差し上げます。

