



# NINJAGO

Masters of Spinjitzu



9445



**FANGDAM INCLUDED**



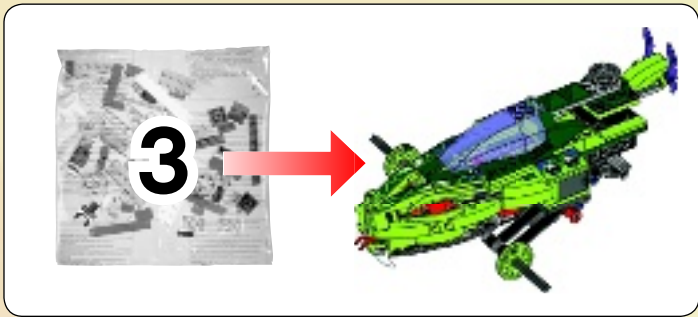

**FANGDAM INCLUDED  
FANGDAM INCLUS  
INCLUYE A FANGDAM**

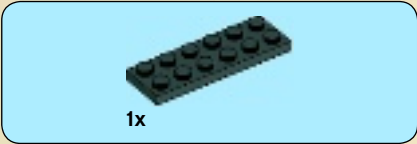

**1**



**2**



**3**

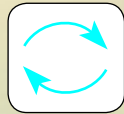



4



5



6

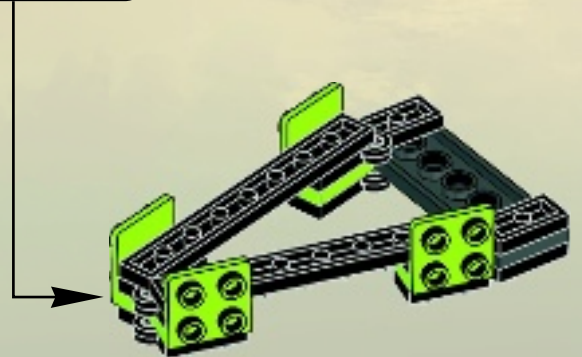
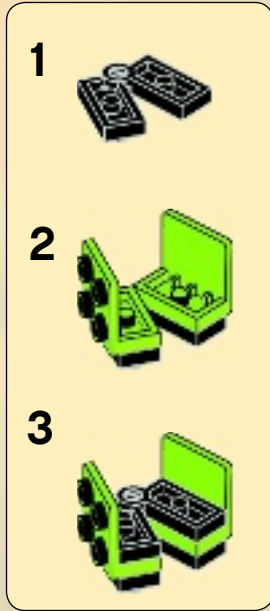



4x

7

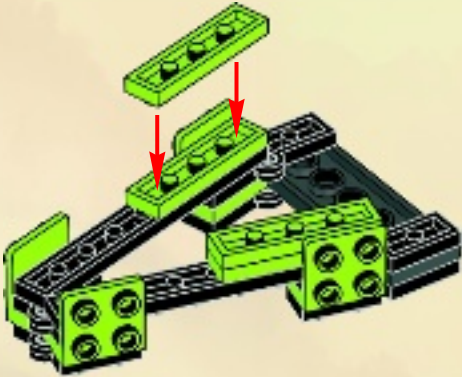

2x

8



2x



2x

9



2x

10

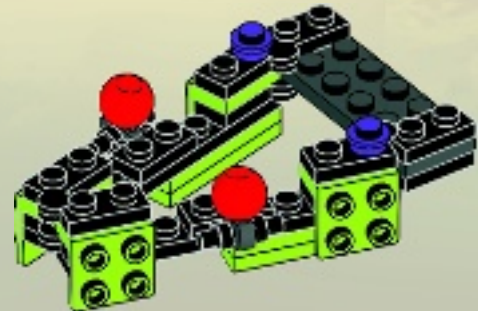



# 11

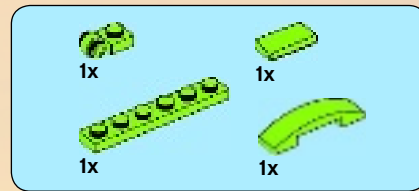

# 12

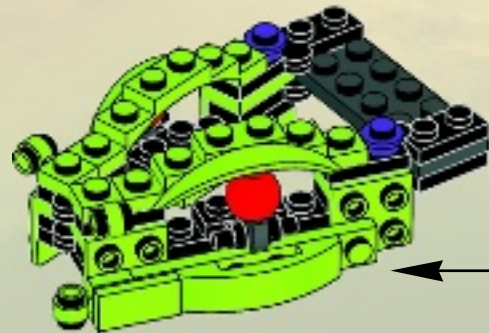
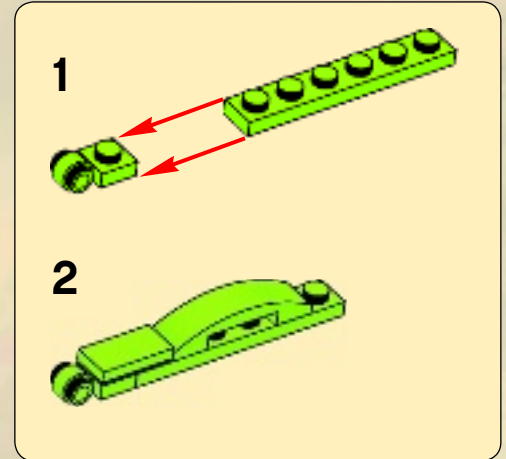

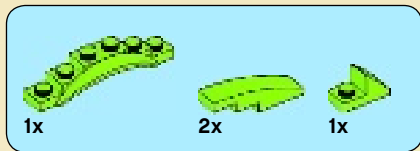

# 13

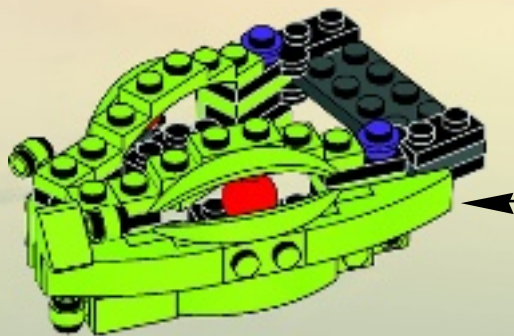
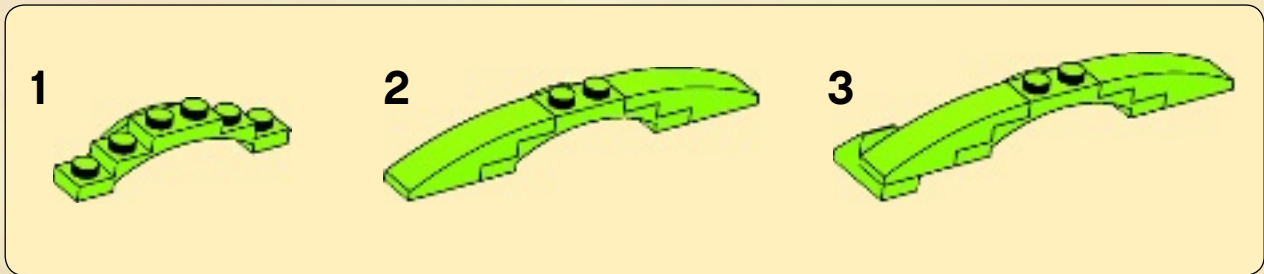

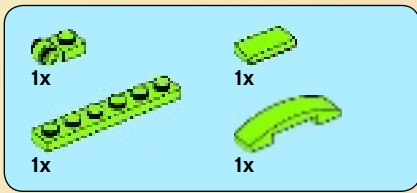

# 14

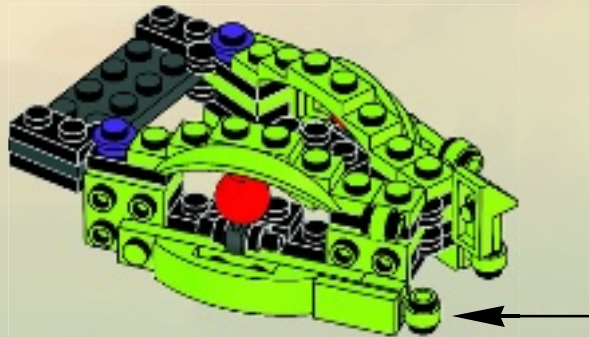
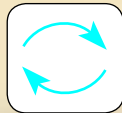
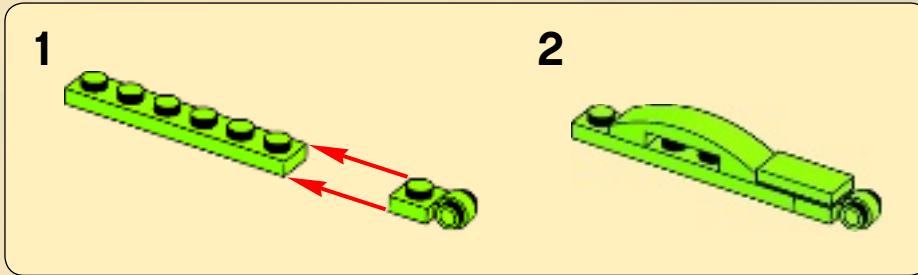

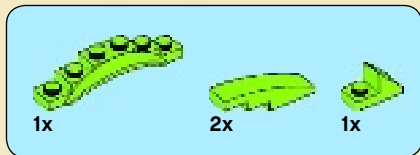

# 15

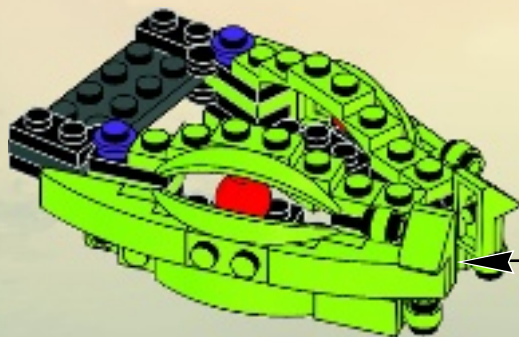
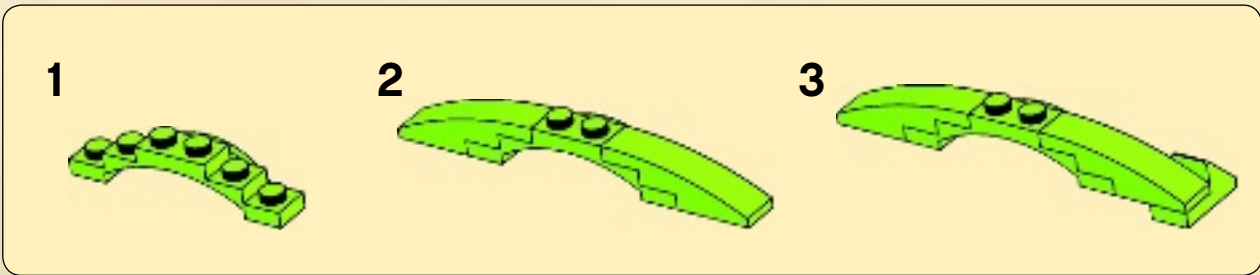





2x

# 16

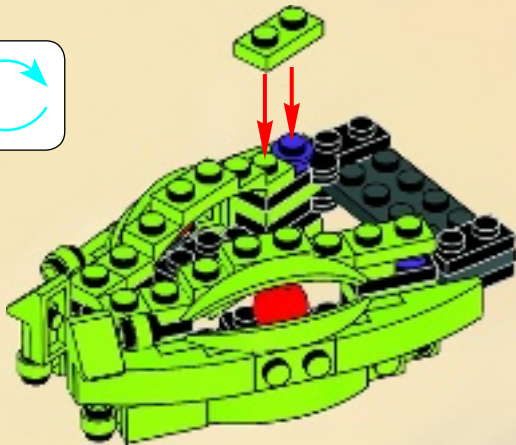

2x



2x

# 17

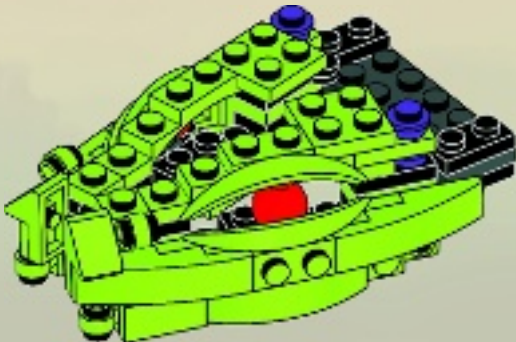

2x

# 18

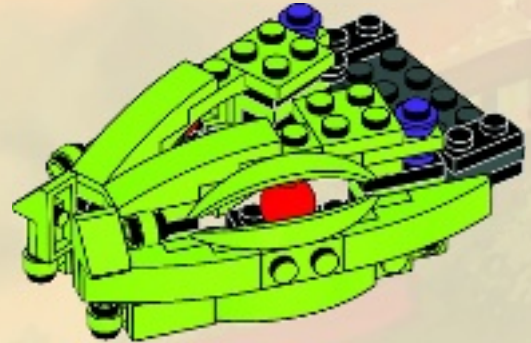

2x

# 19

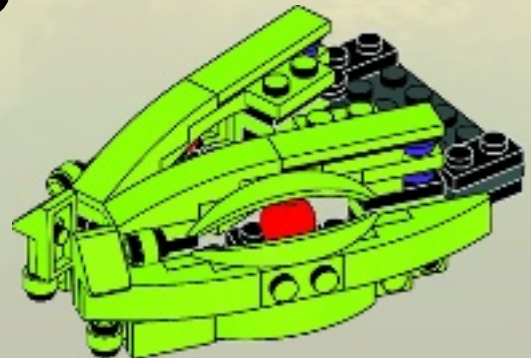

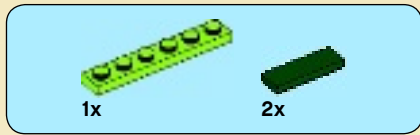

20

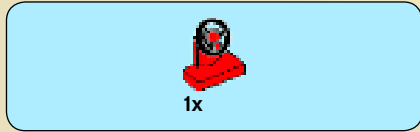
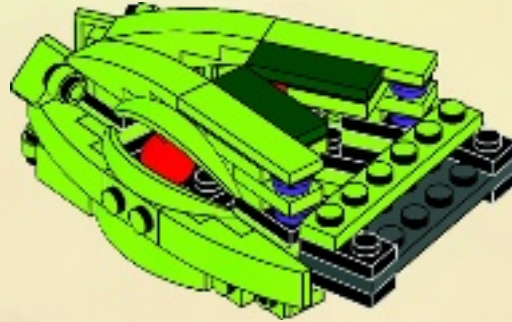

21

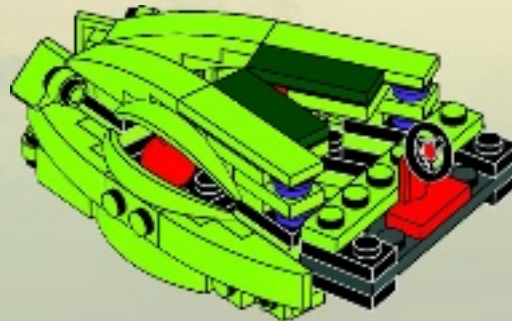



22

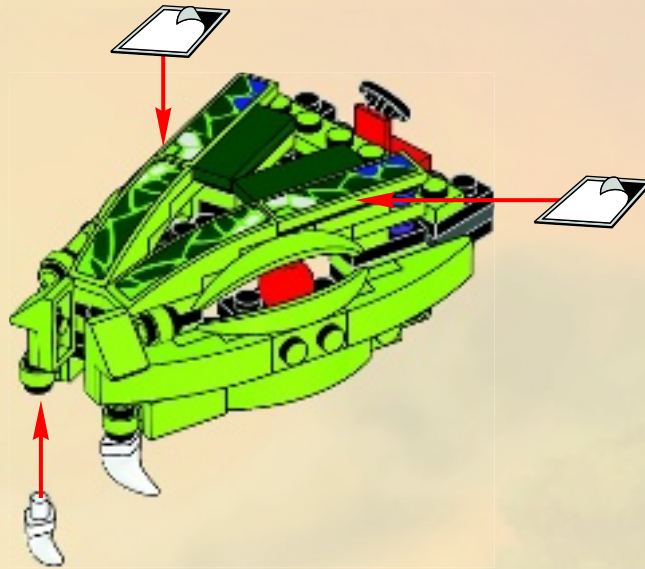

23

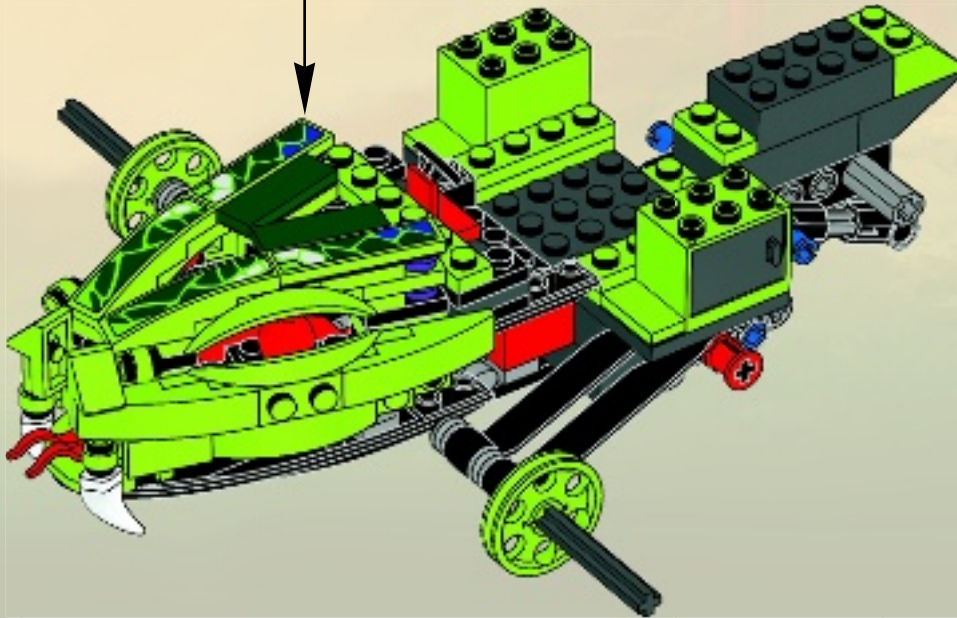

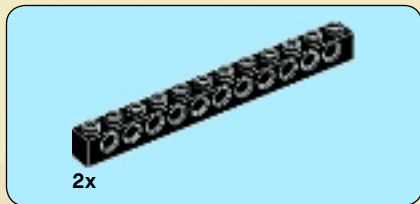

24





2x

# 25

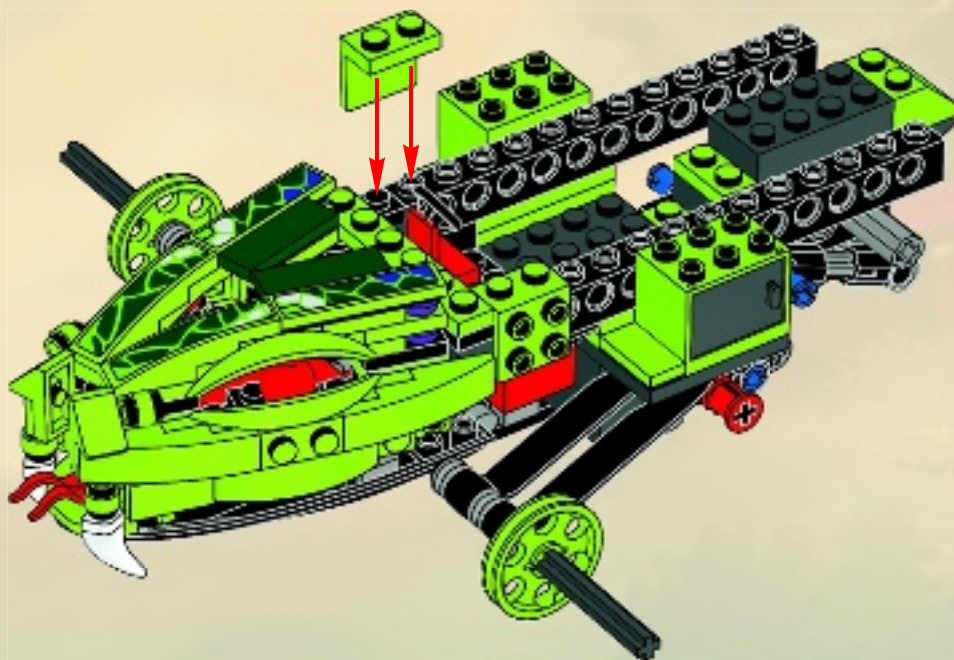

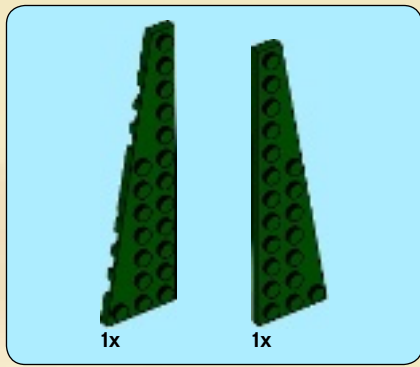

26

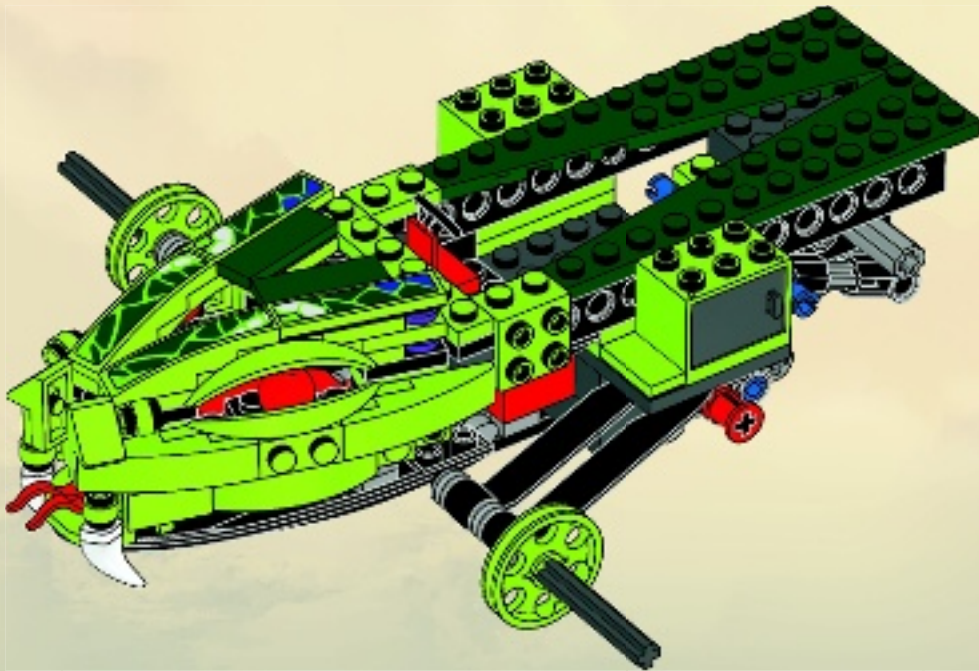



4x

# 27

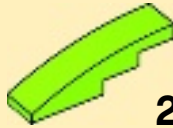

2x

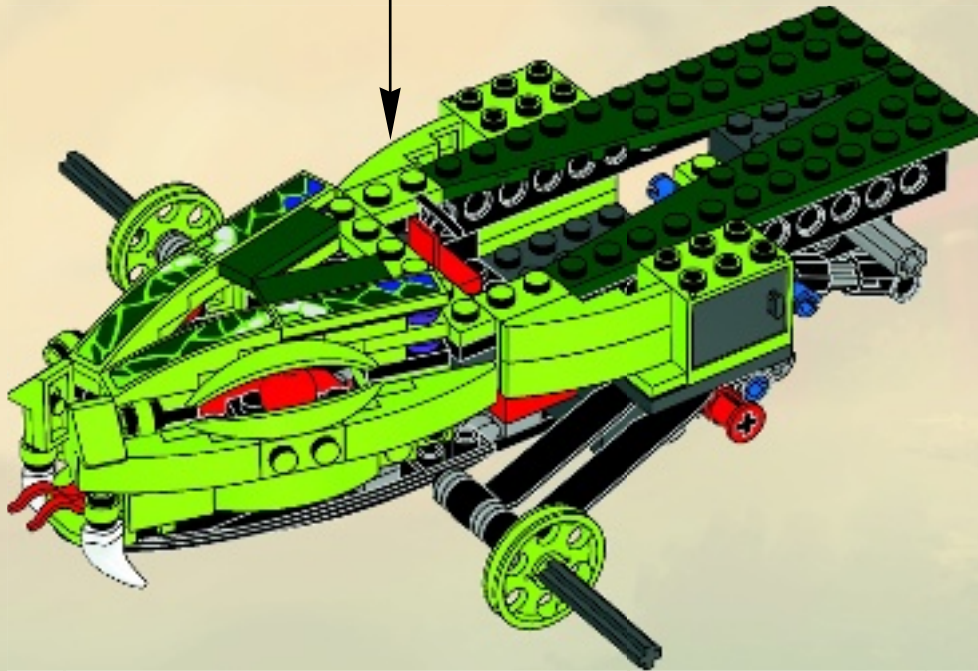



4x

28

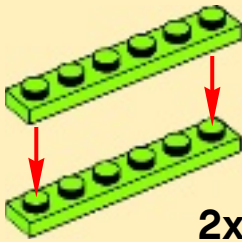

2x

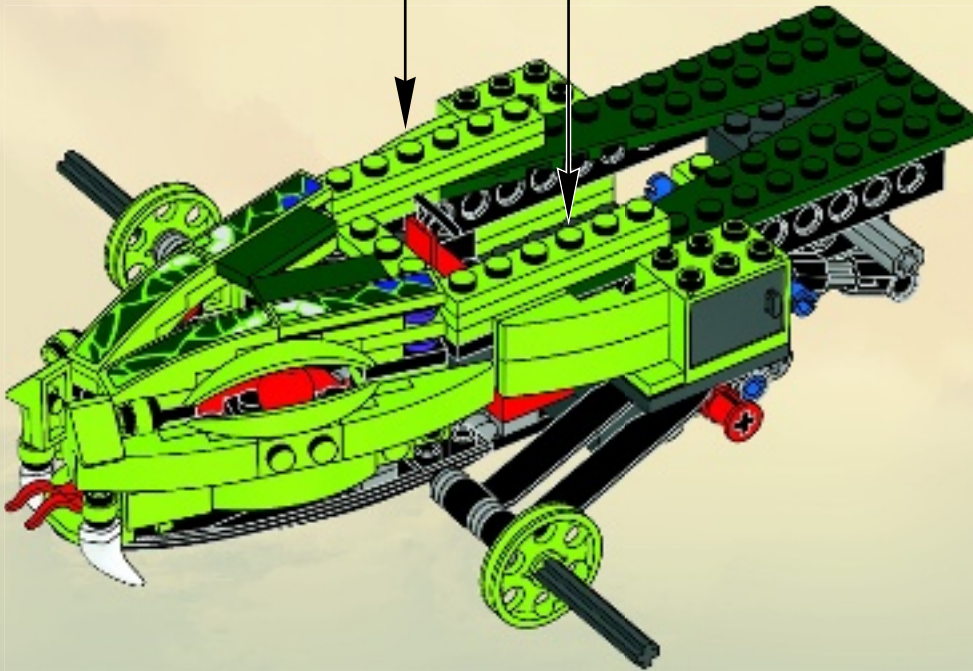





3x

# 29

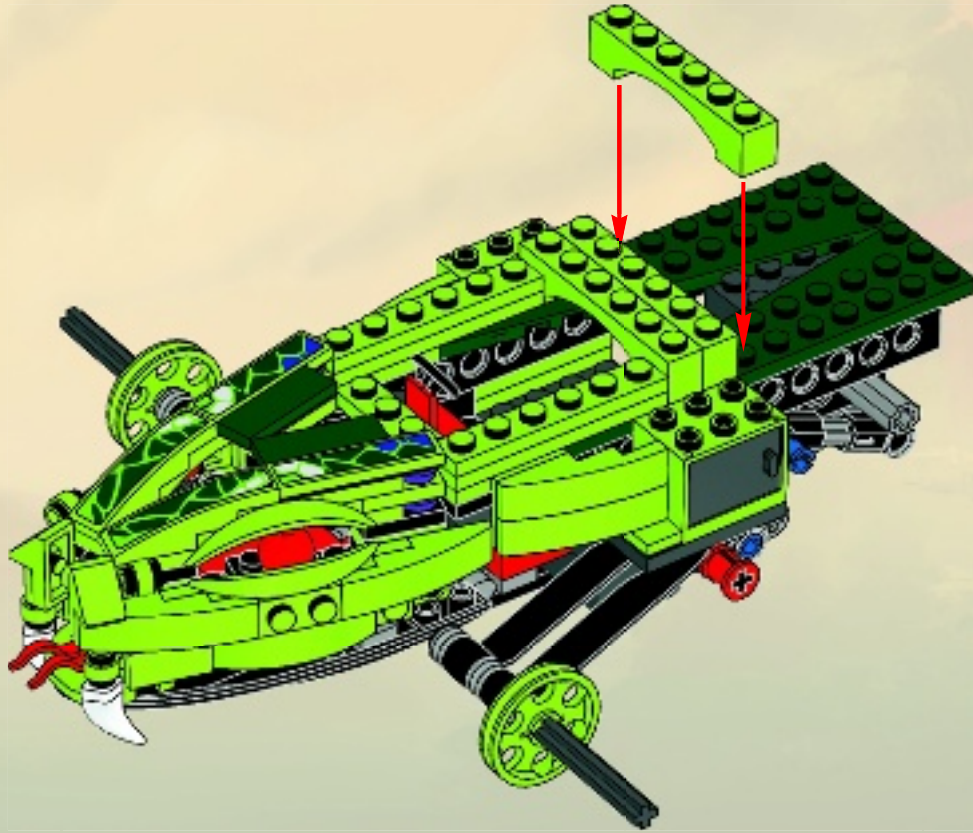



30

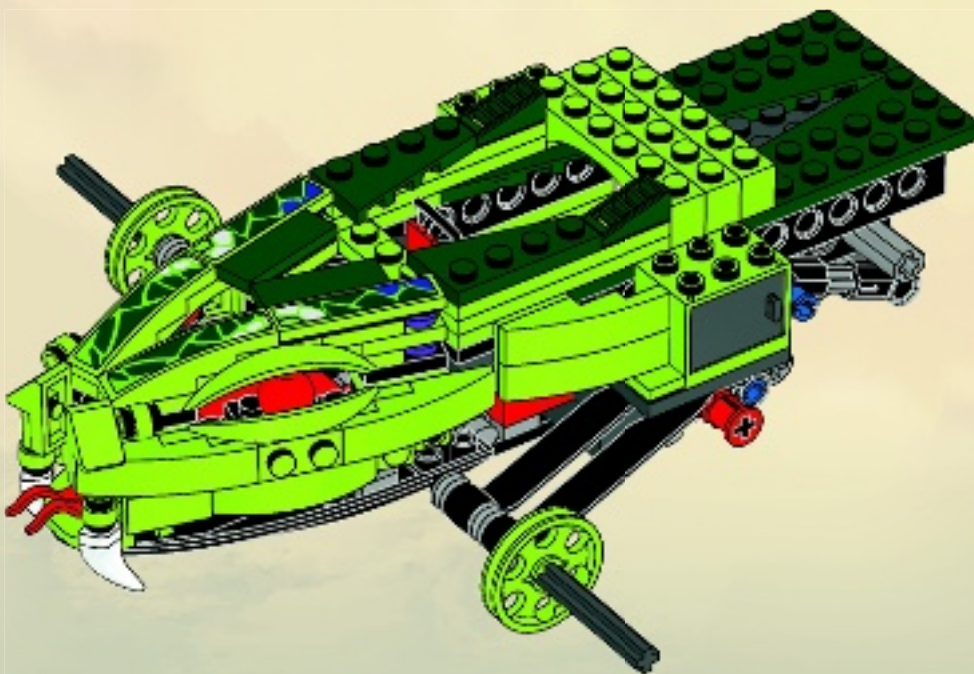

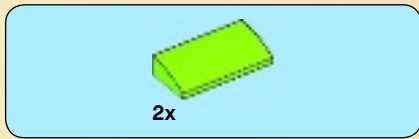

# 31

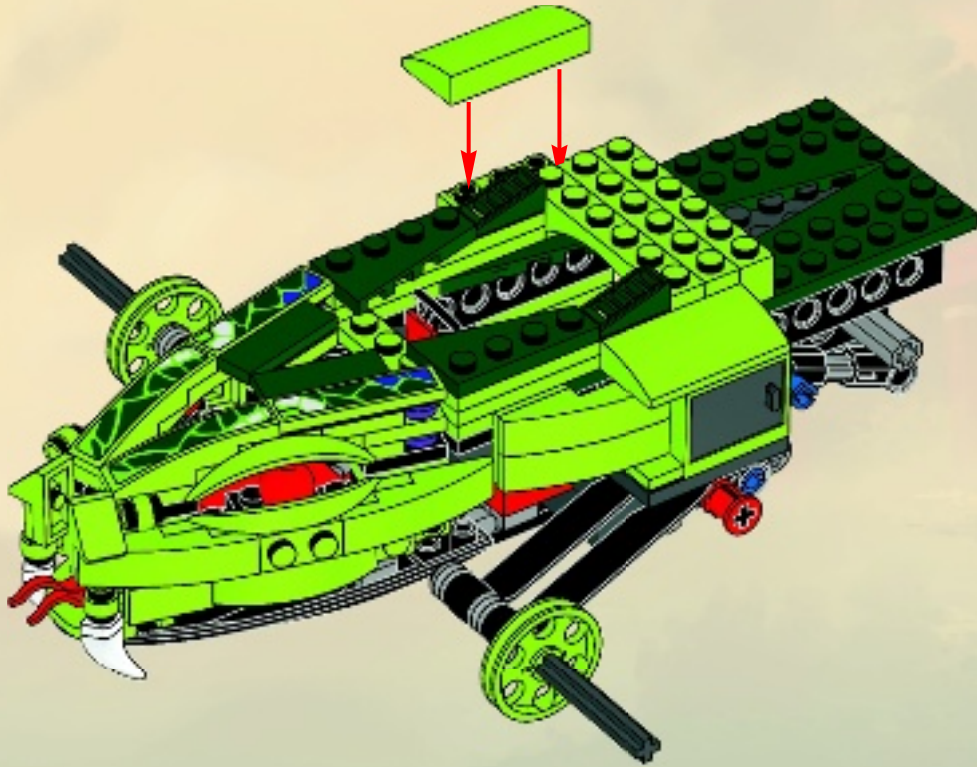

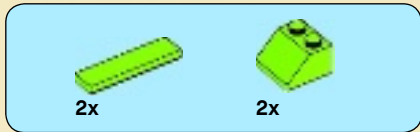

# 32

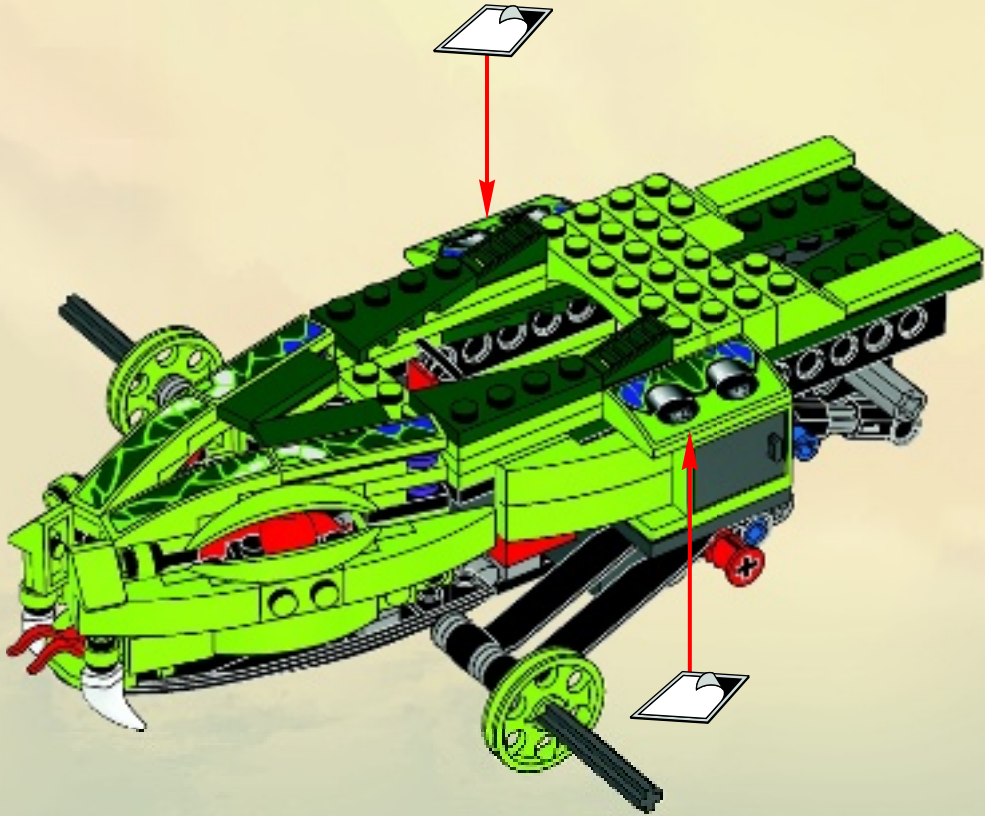

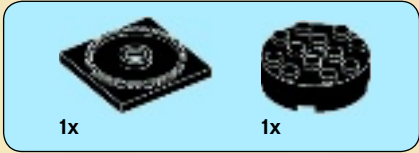

1

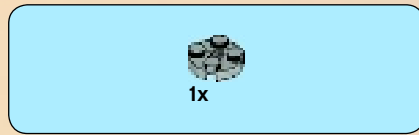
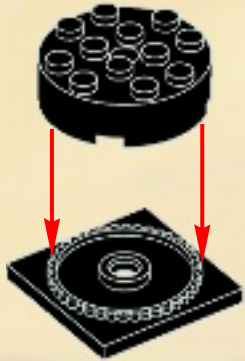

2



3



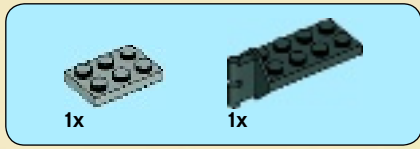

4

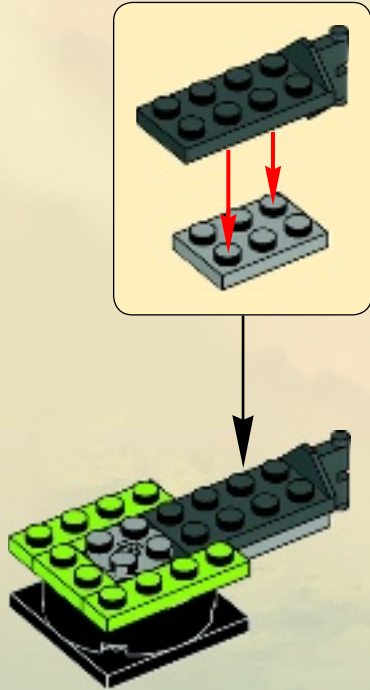

5



6

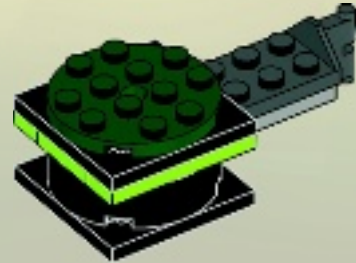



2x

7



2x

8

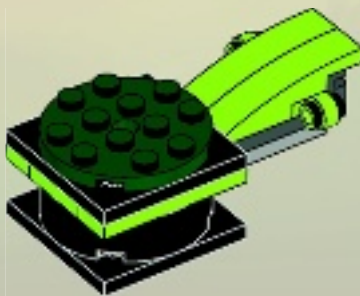



2x

9



33

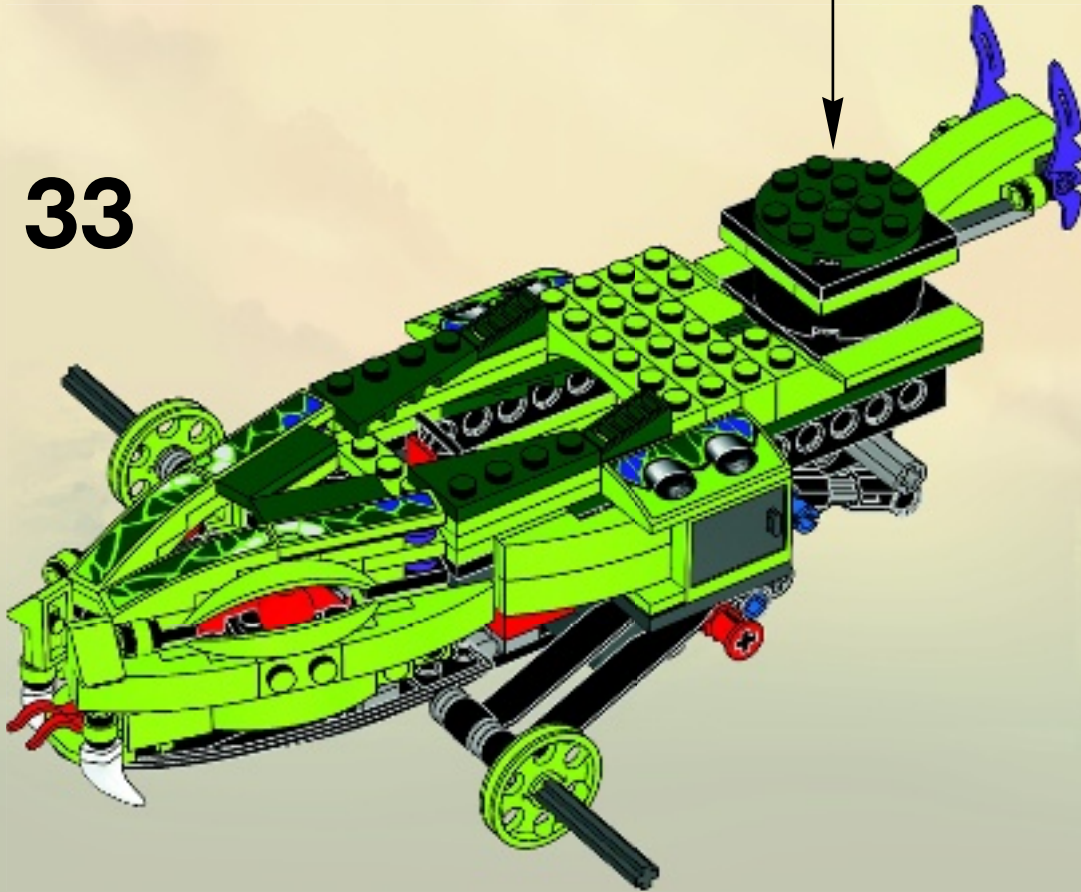





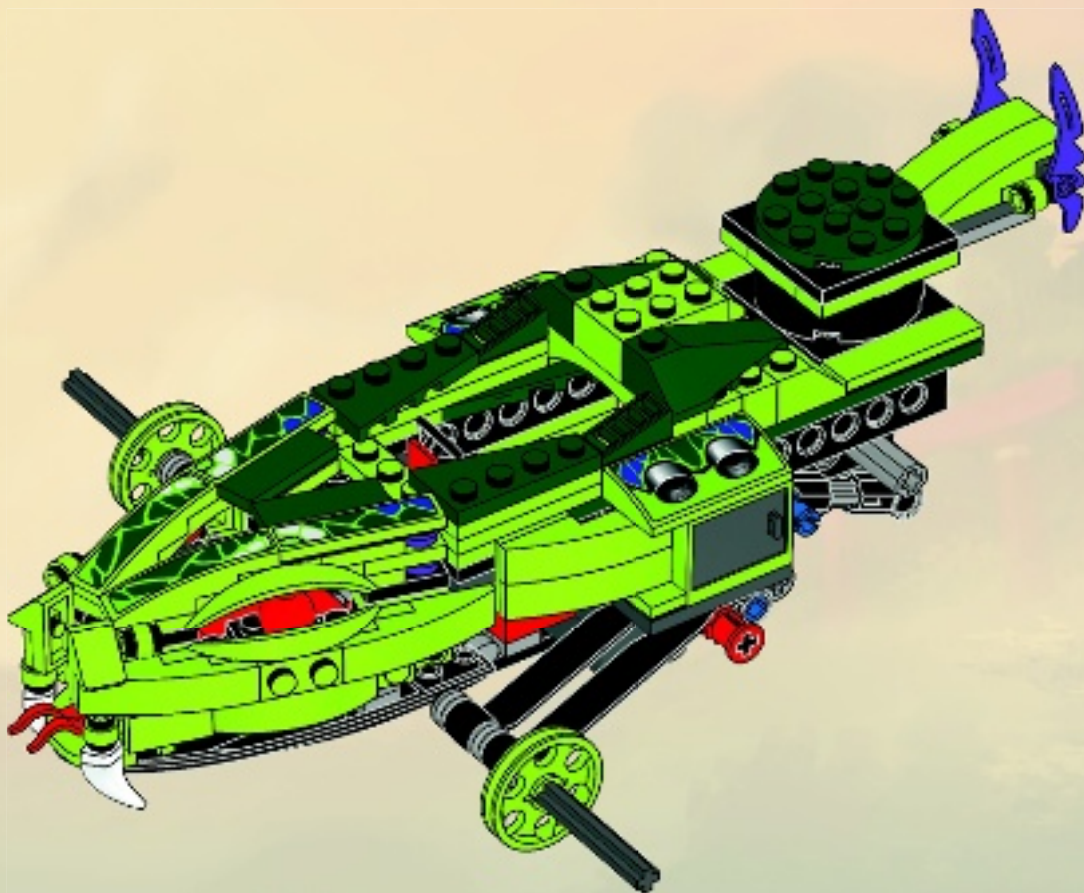

34



1x  2x 

# 35



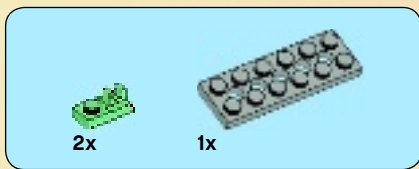

36

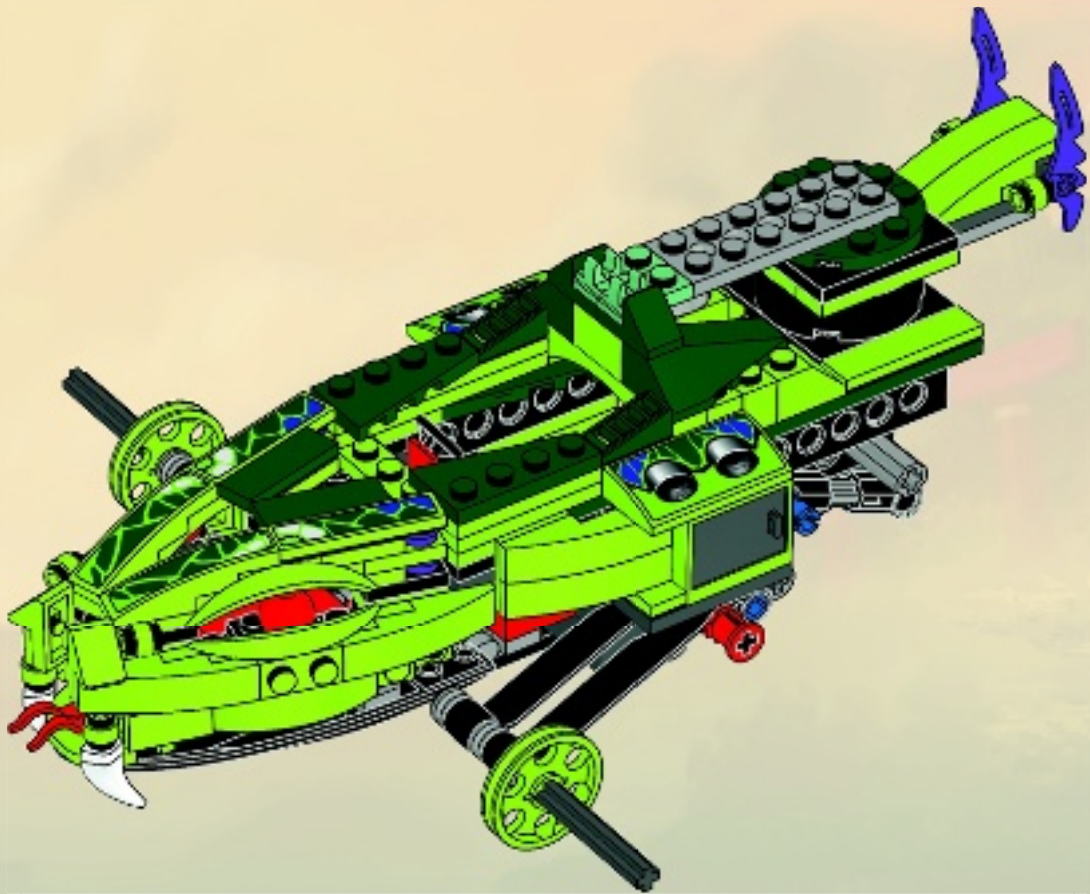



4x

# 37



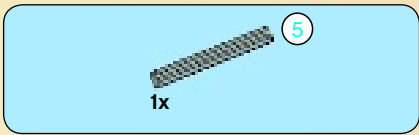

38

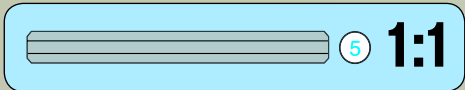



1x

# 39

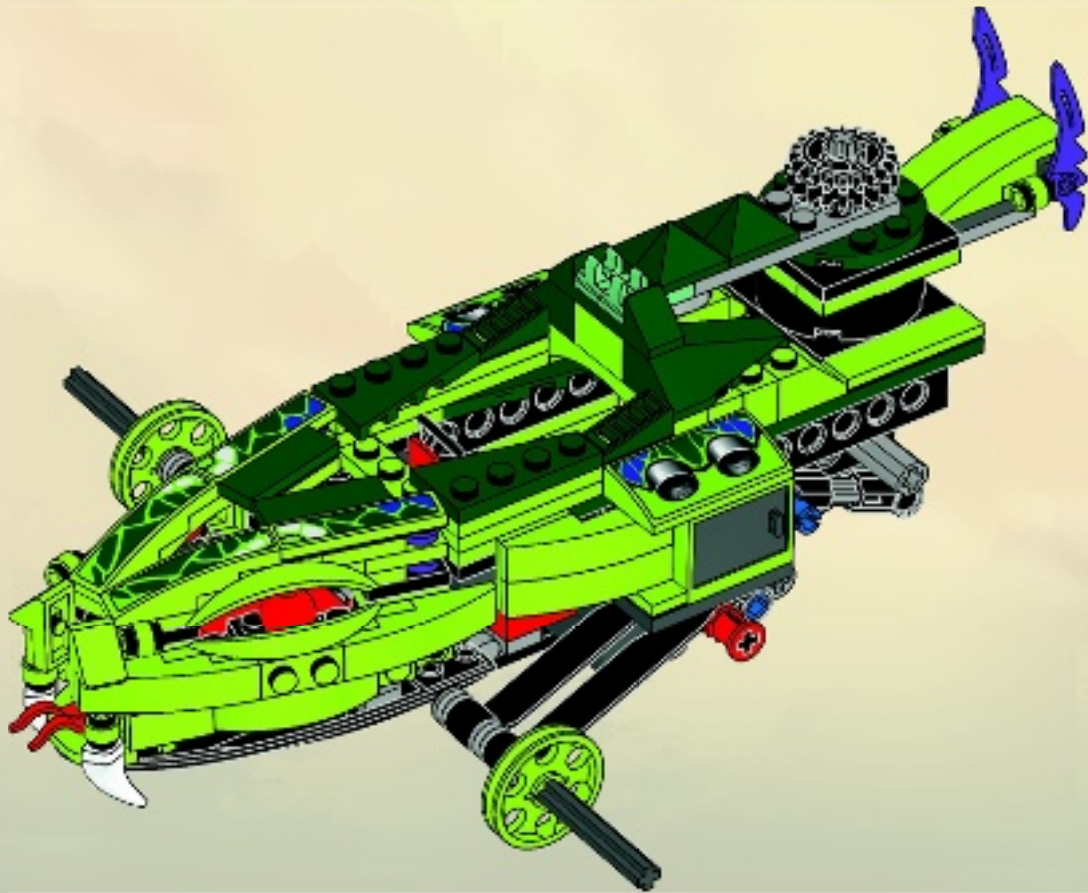

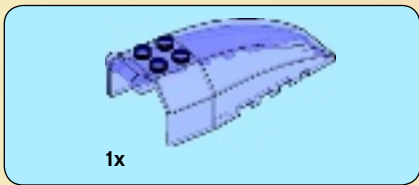

40

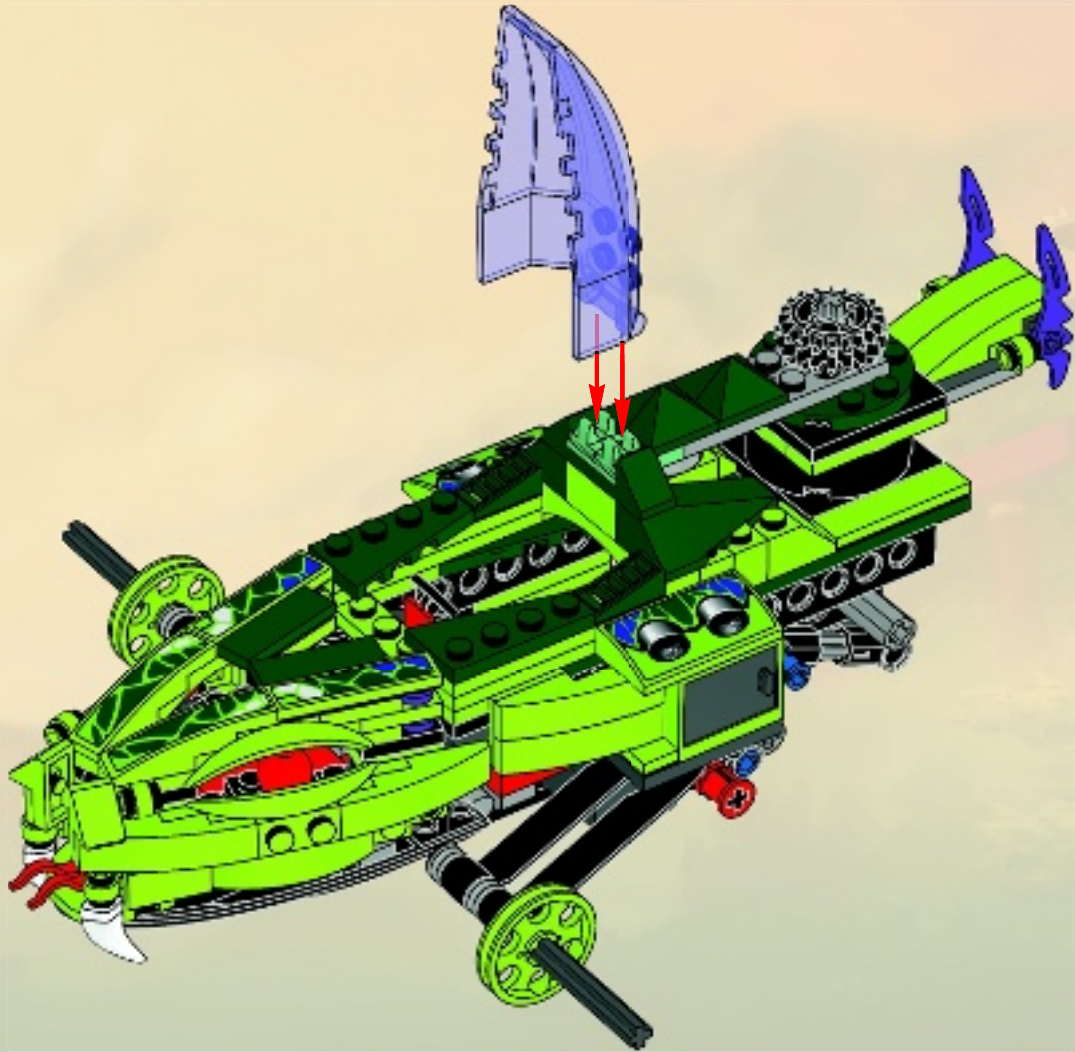

4



1x



1x



1x

1

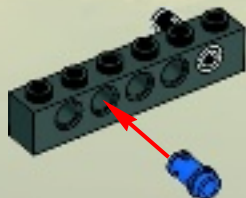

2x

2



1x

3





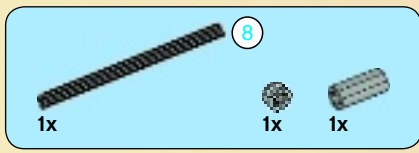

4

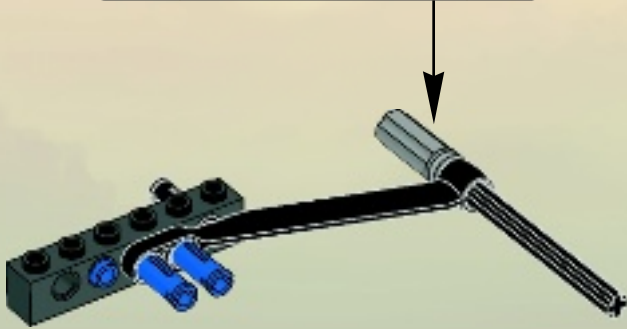
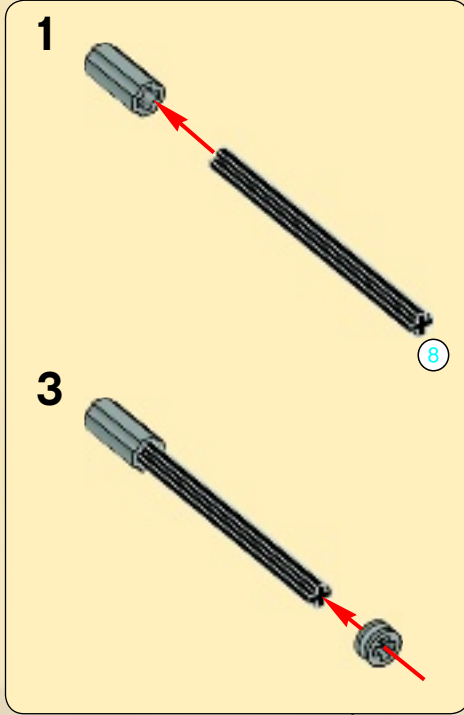

5



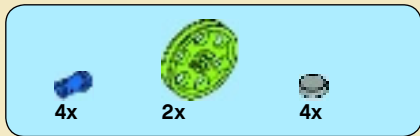

6

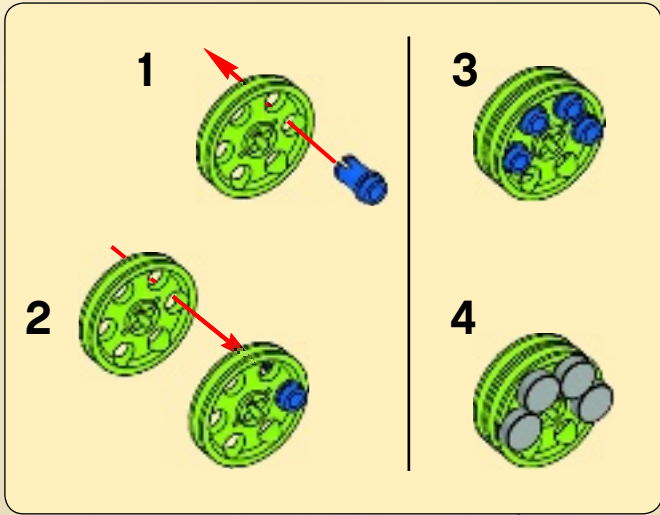

7

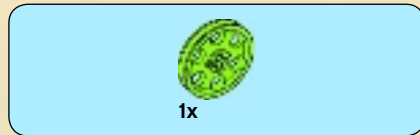
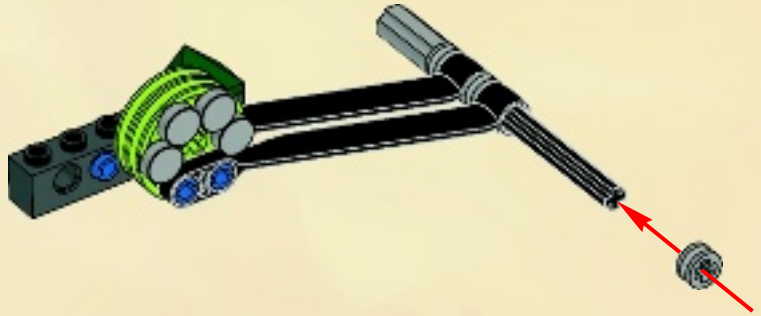

8

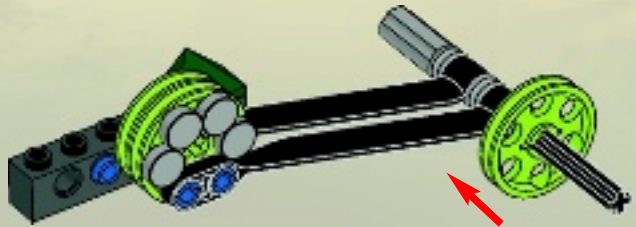

41

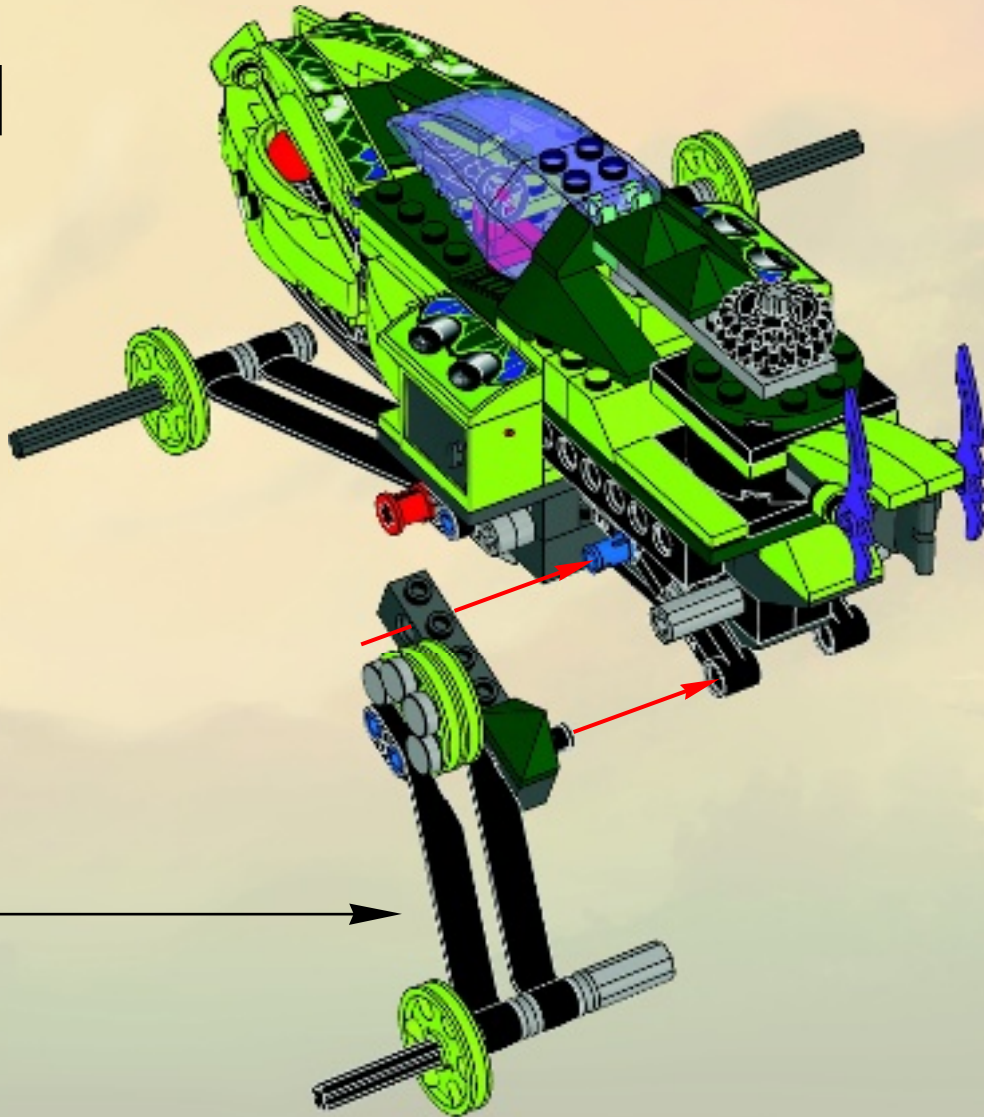



42

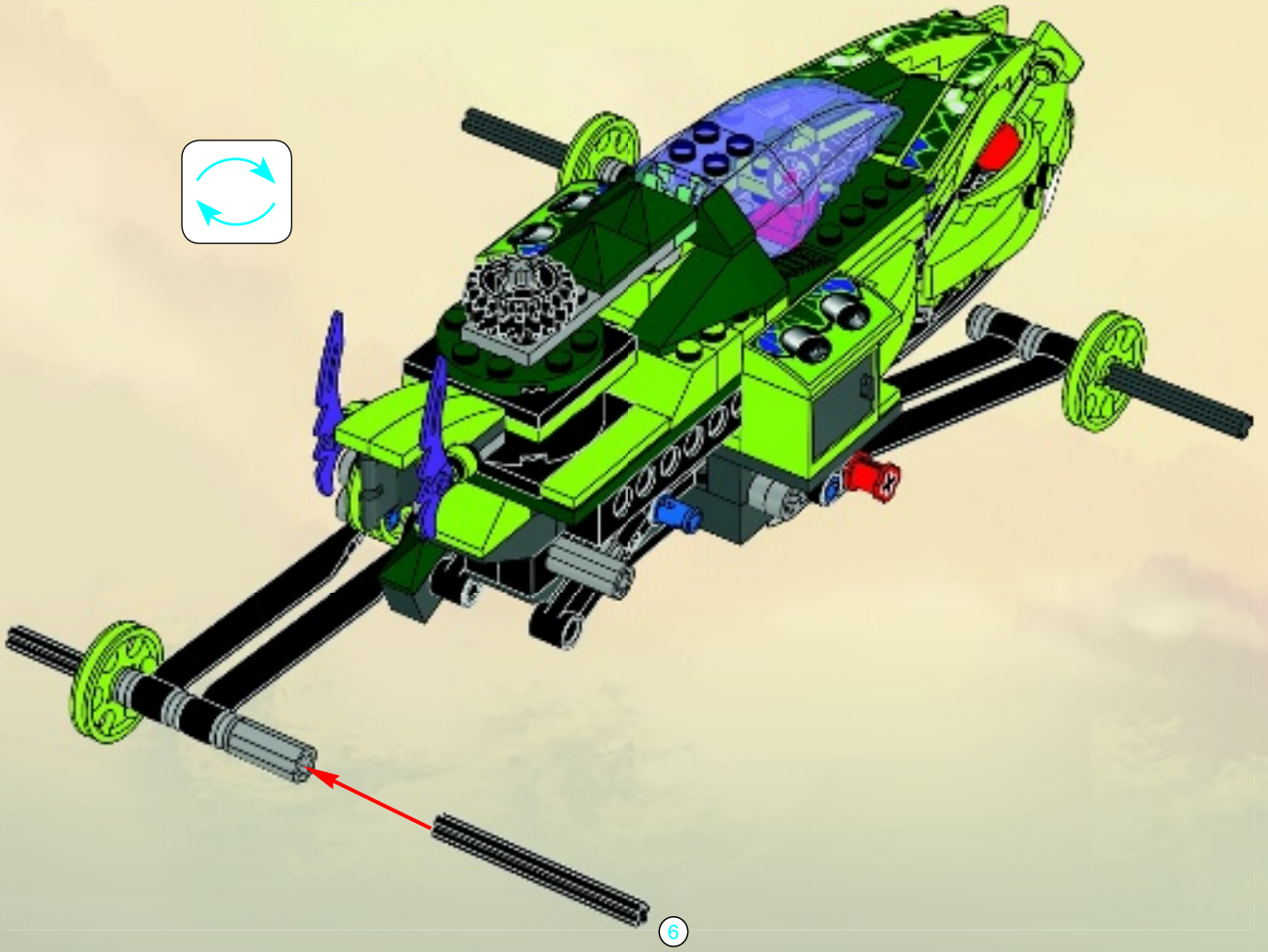



# NINJAGO

Masters of Spinjitzu



[NINJAGO.COM](http://NINJAGO.COM)



9445

9442

9443

9446

9567  
9552

9564

9563

9561

9552

9566

9566

9441  
9558  
9579



9444

9441  
9558

9441  
9444  
9446

9579

9562  
9440

9444  
9566

9551

9440  
9445  
9446  
9553  
9558

9562

9558

9563  
9567

9564



- 9551
- 9443
- 9446
- 9446
- 9443
- 9446
- 9552
- 9444  
 9579
- 9561  
 9553
- 9442  
 9558
- 9579  
 9558



- 9562
- 9564
- 9443
- 9442  
 9445
- 9446
- 9446  
 9551  
 9558  
 9561
- 9558  
 9579
- 9579
- 9567
- 9553
- 9440
- 9445



# NINJAGO

Masters of Spinjitzu



9446



9445



9444



9443



9442



9441



9440





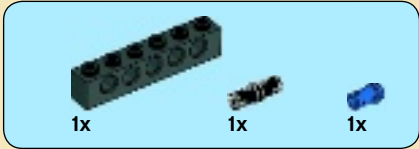

1



2



3



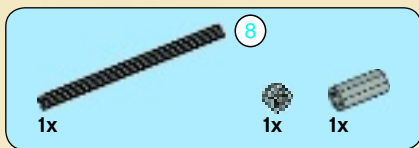

4

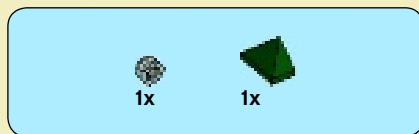
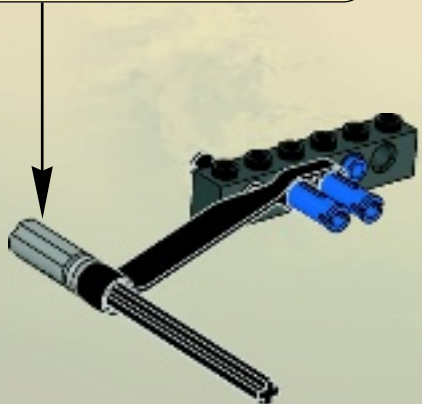
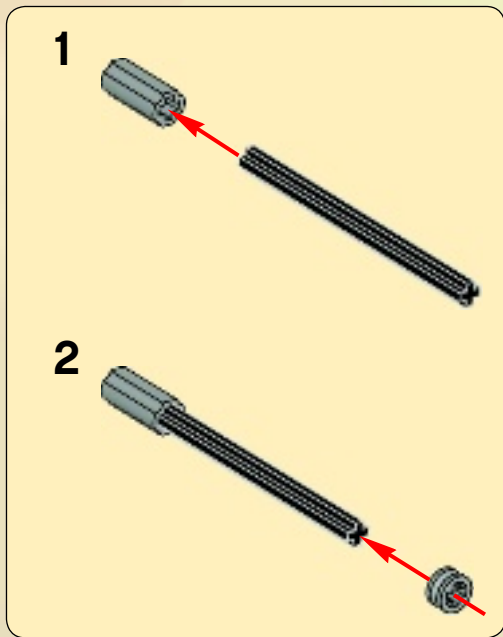

5

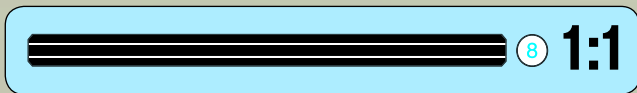
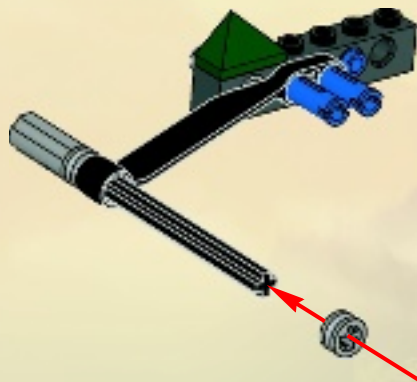

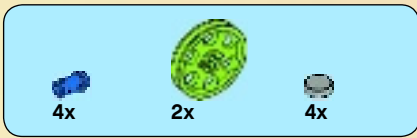

6

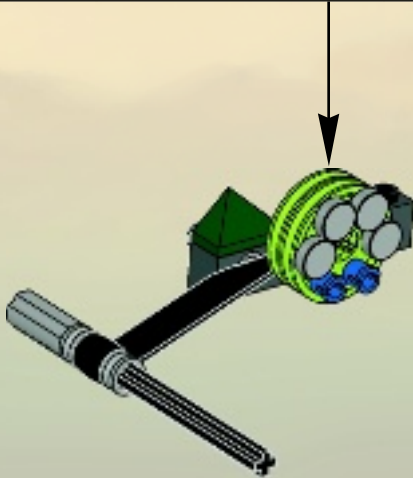
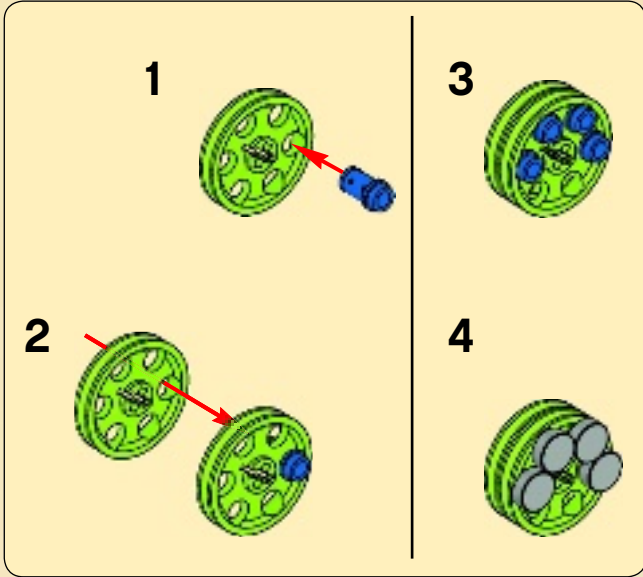

7

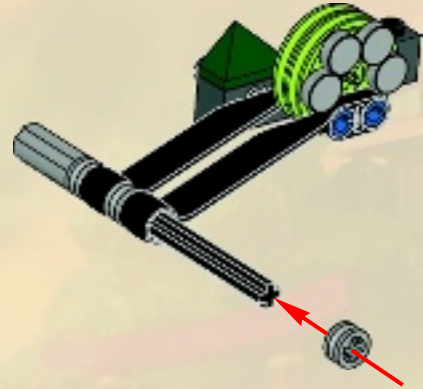

8

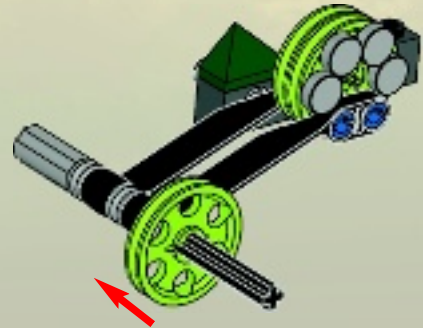

43



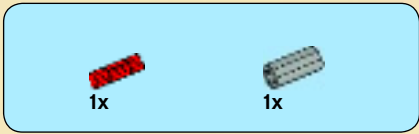

1

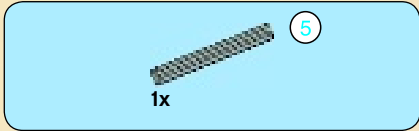
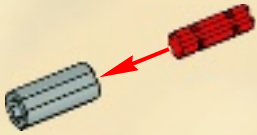

2

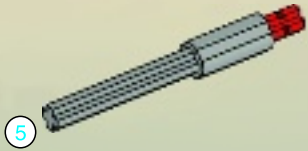

3

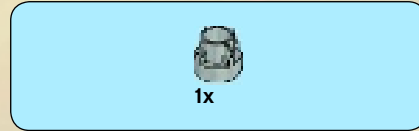
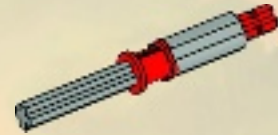

4

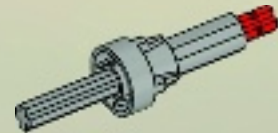



1x

5

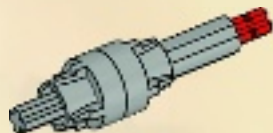

1x

6

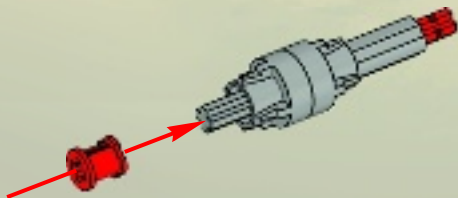

1x

7

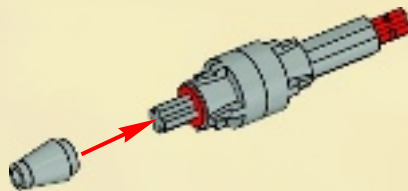

1x

8

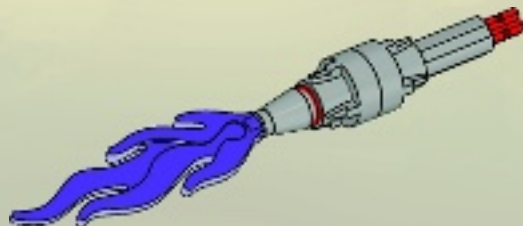



1x

9

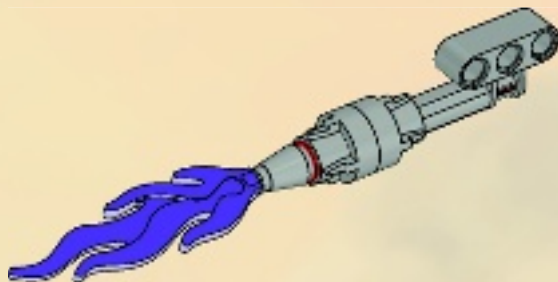

2x



1x

10

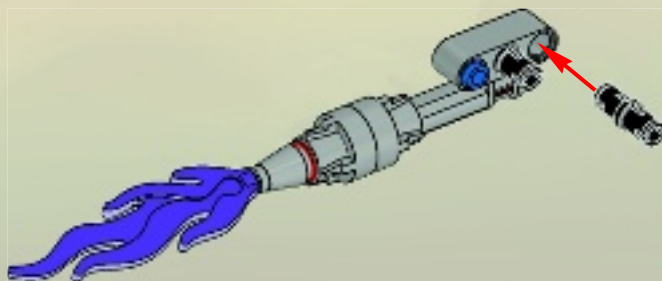



1x

11

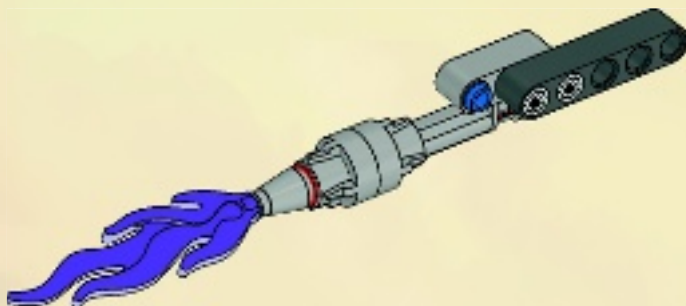

2x

12

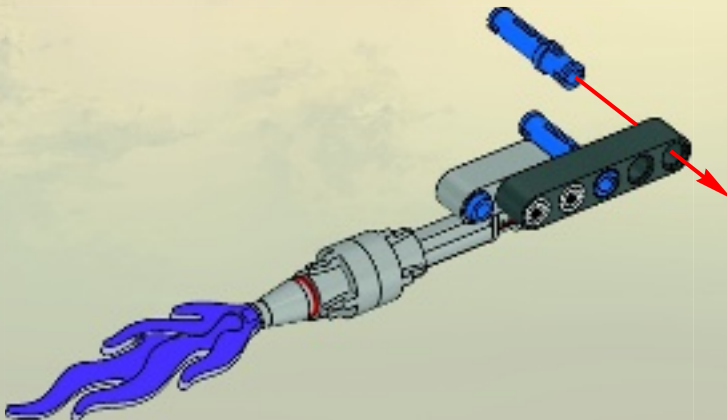



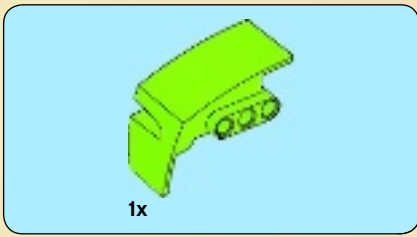

13

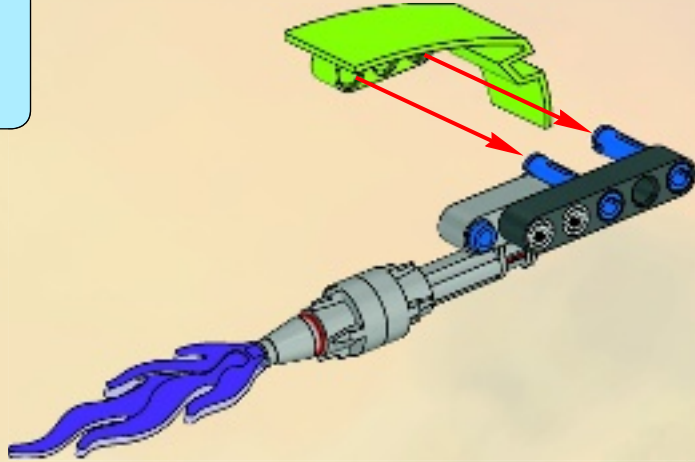

14

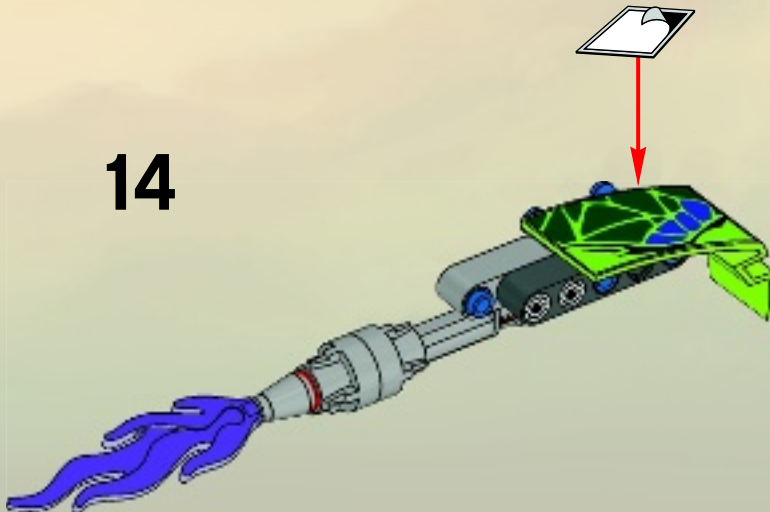

44

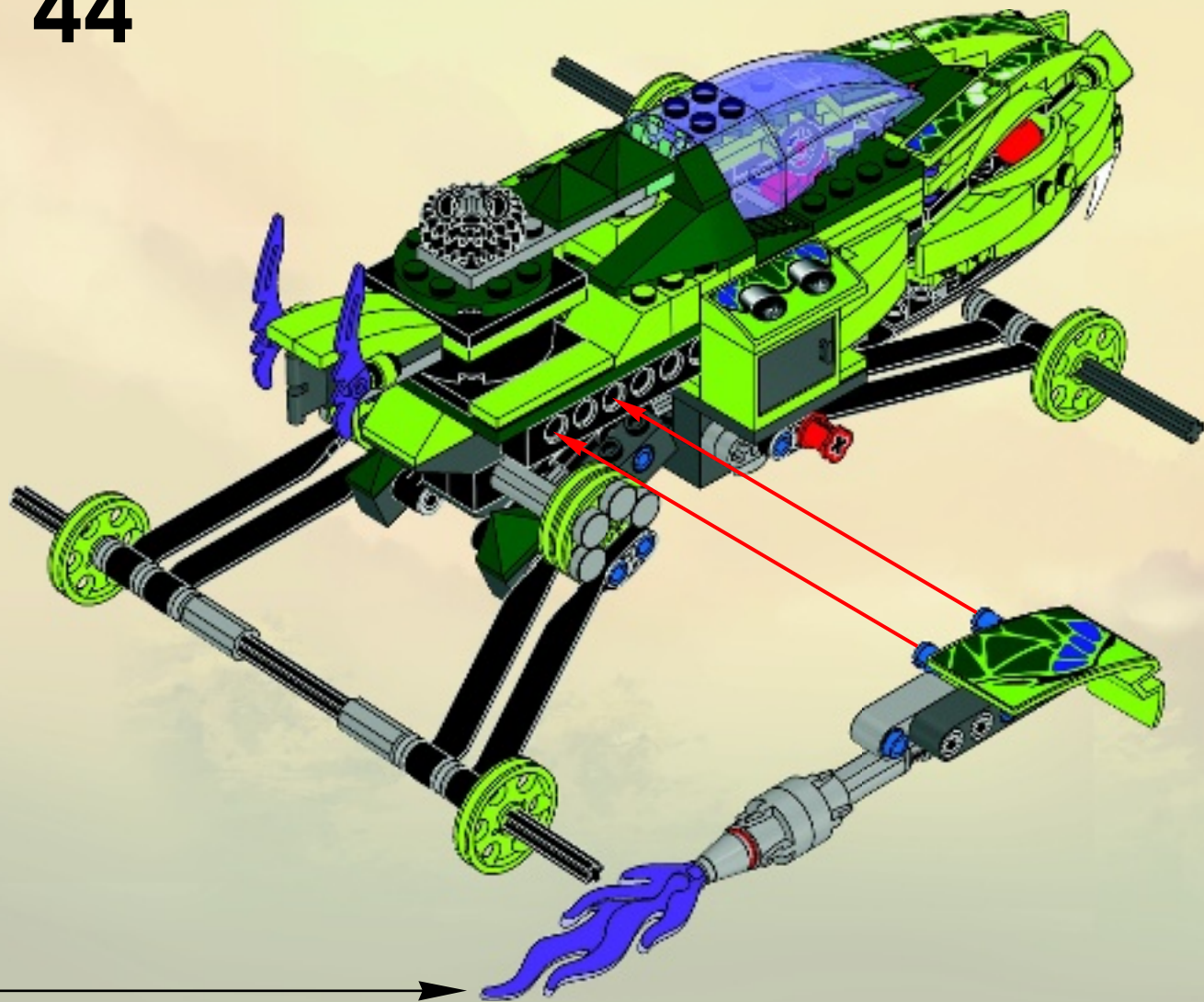

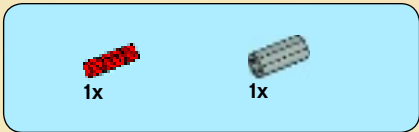
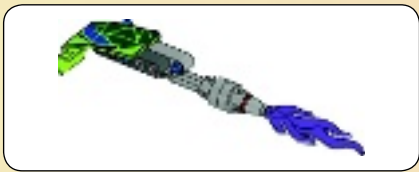

1

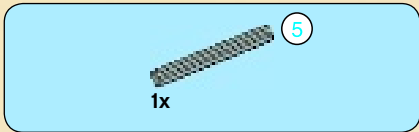
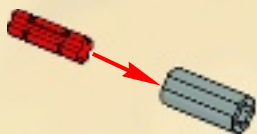

2

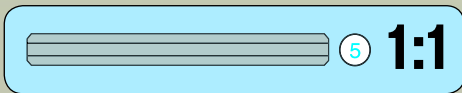
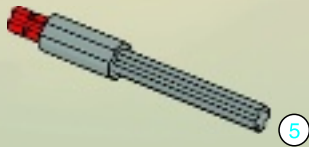

3

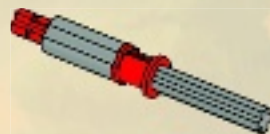

4

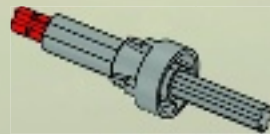



1x

5

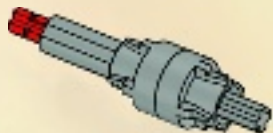

1x

6

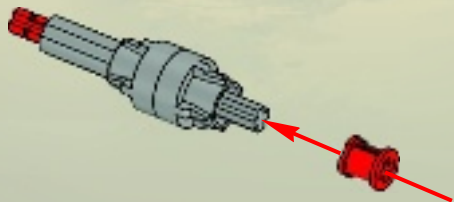

1x

7

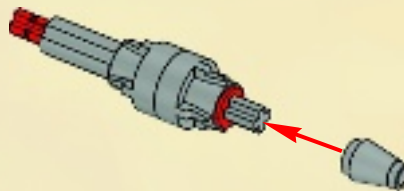

1x

8

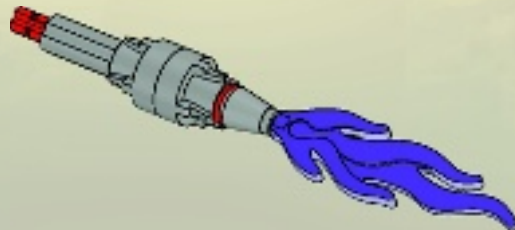



1x

9

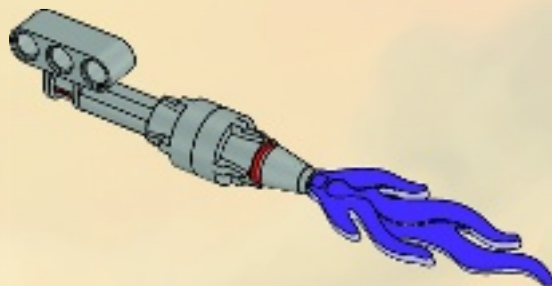

2x



1x

10

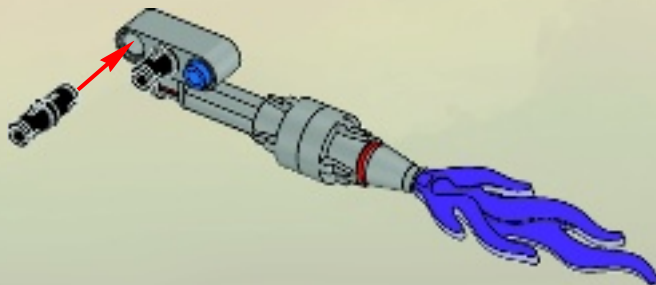



1x

11

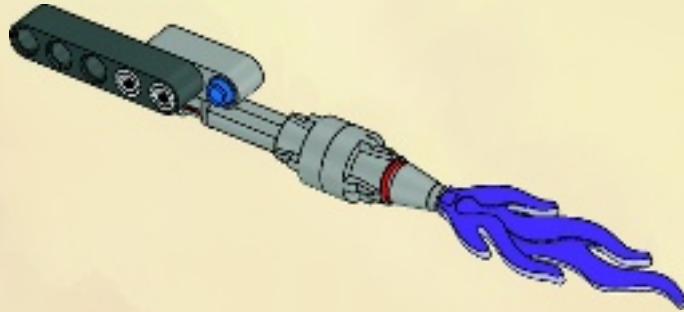

2x

12

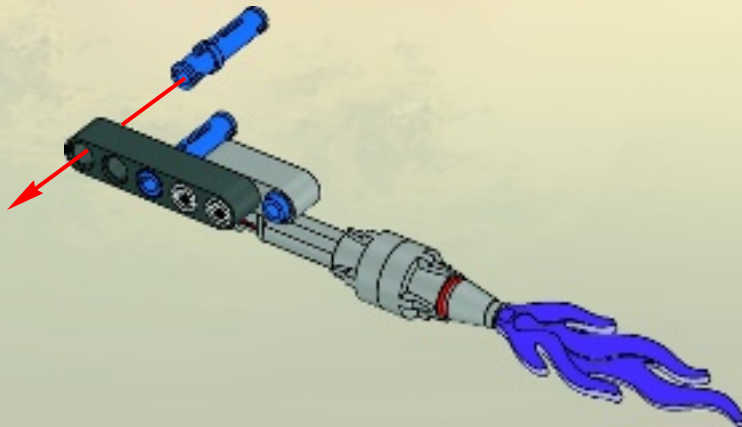

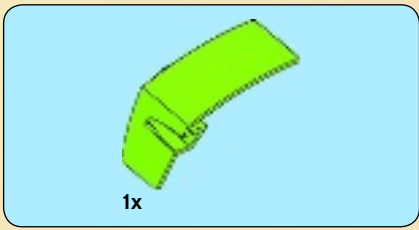

13

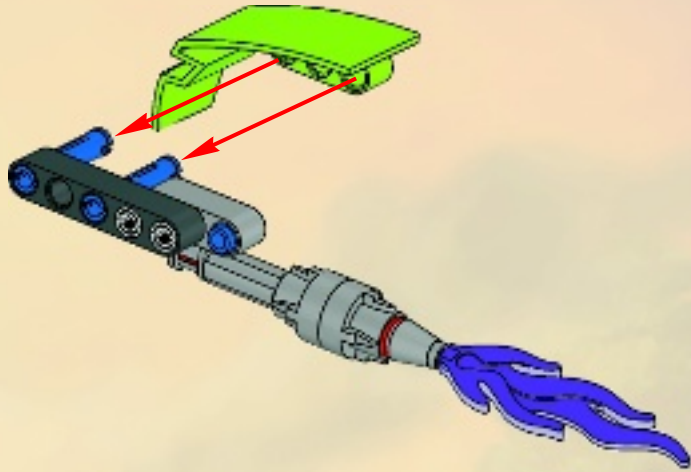

14

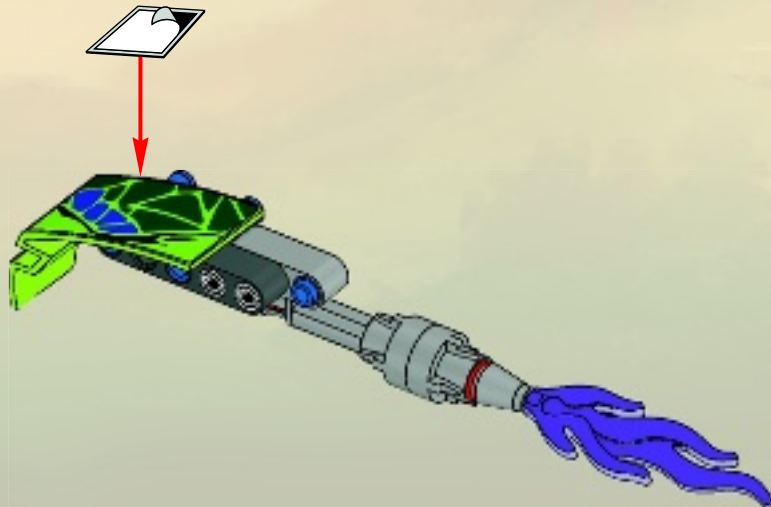

45

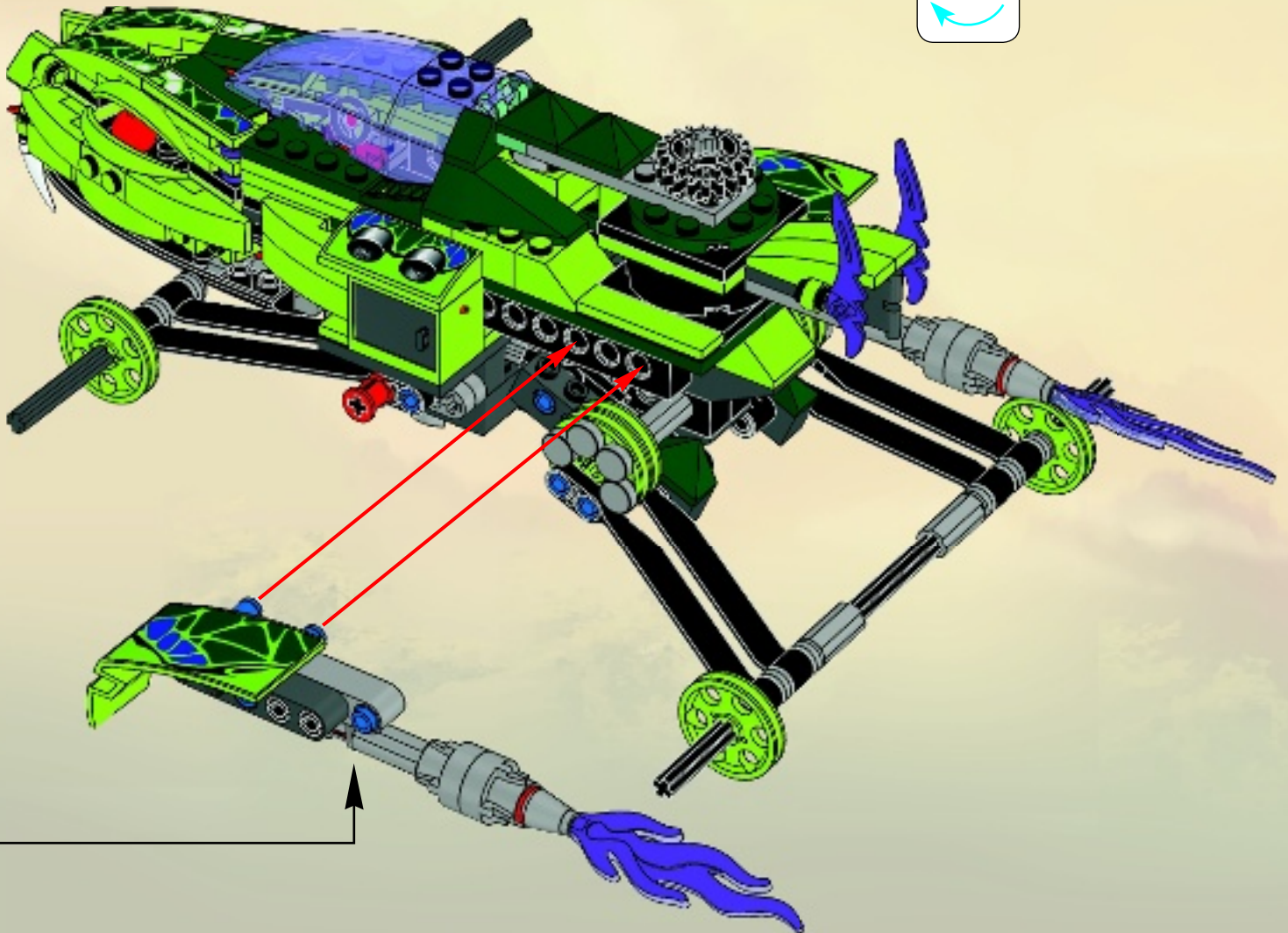
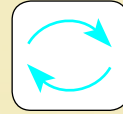





3x



1x

1



1x

2



1x

3



1x

4





1x

5



1x

6



1x

7

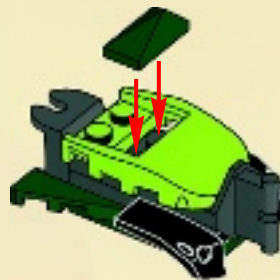

1x

8



3x

46

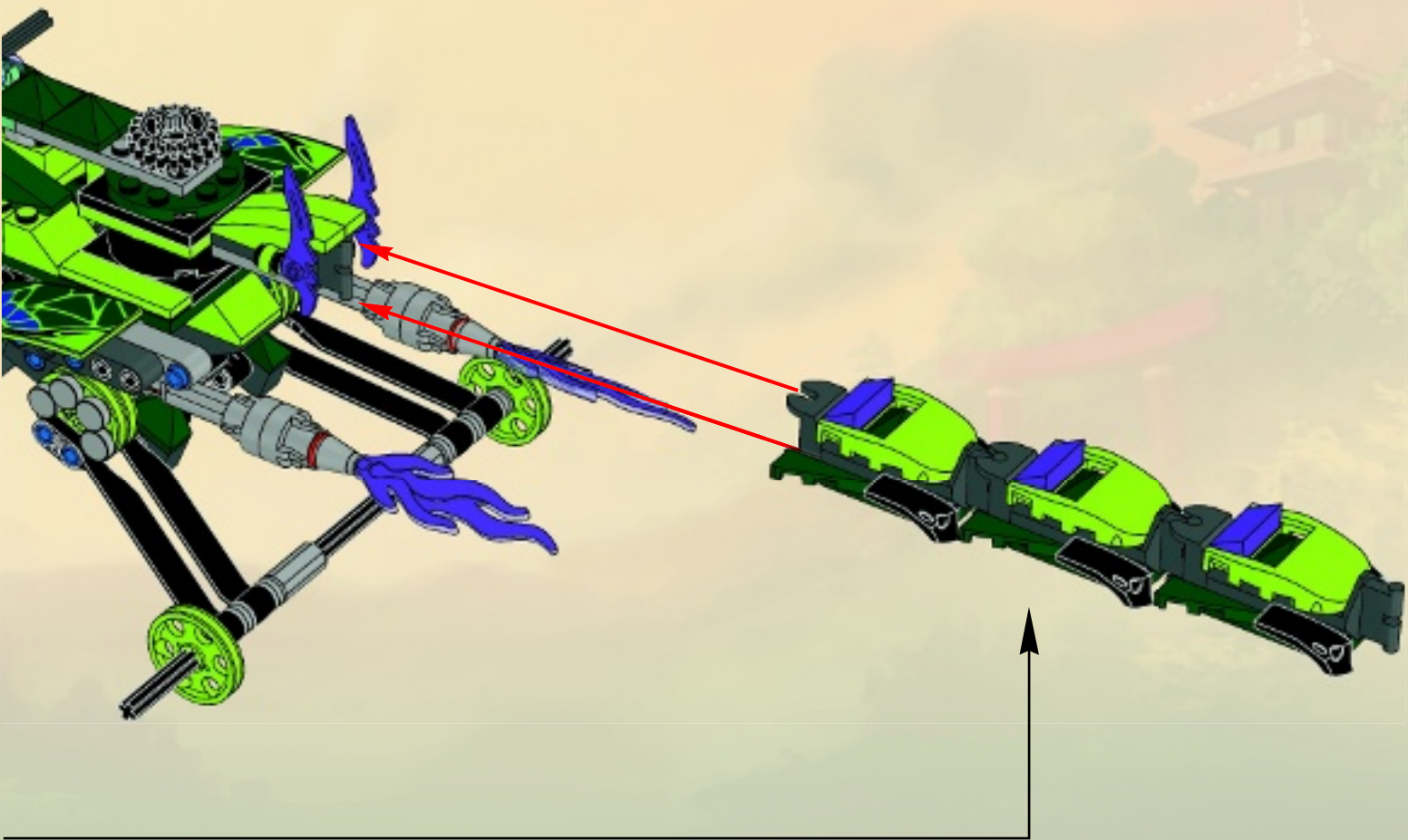

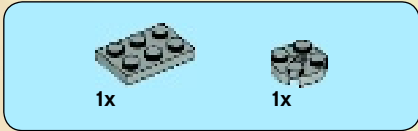

**1**

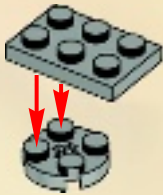

**2**



**3**



**4**





5



6

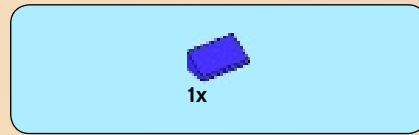
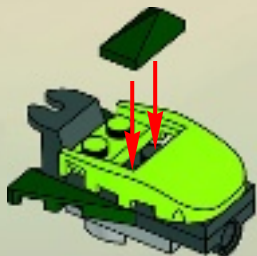

7

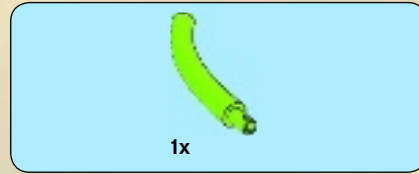
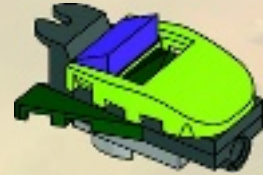

8

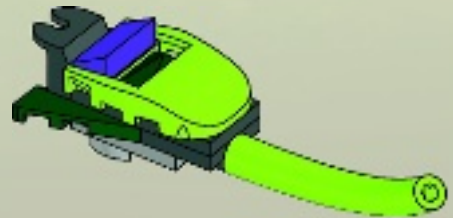

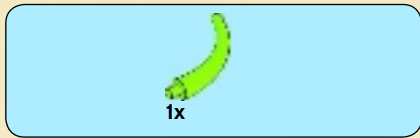

9

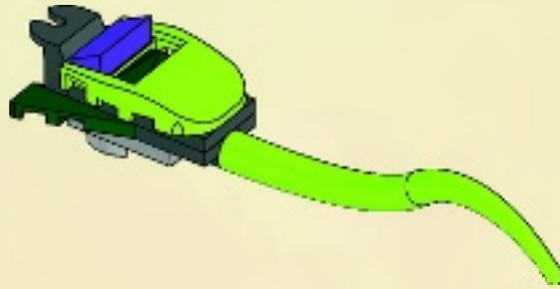

47

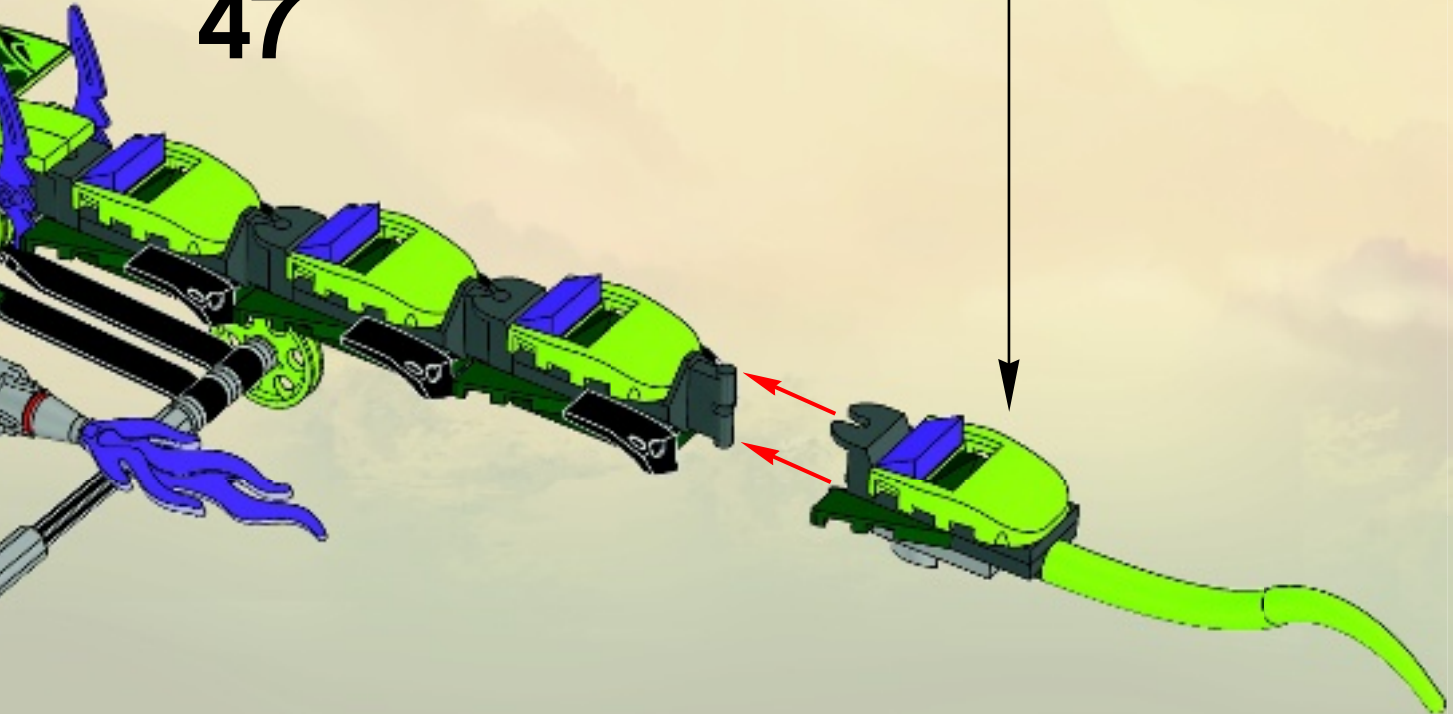

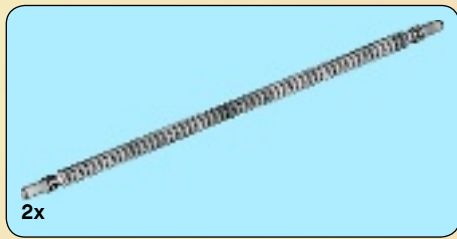

48

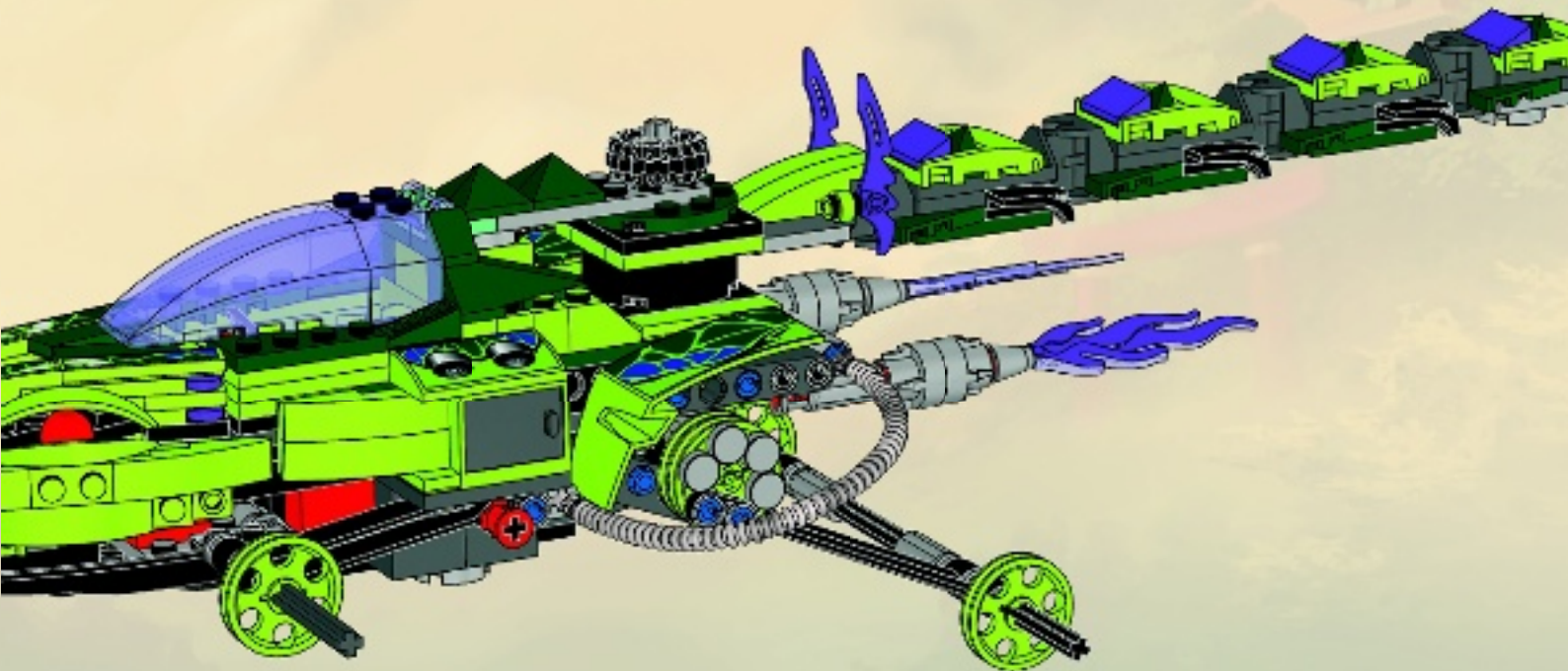



49





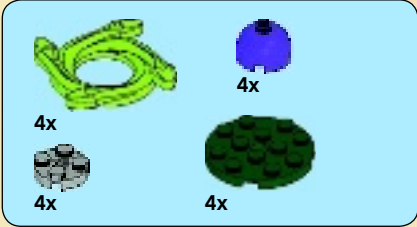

50

1



2



3





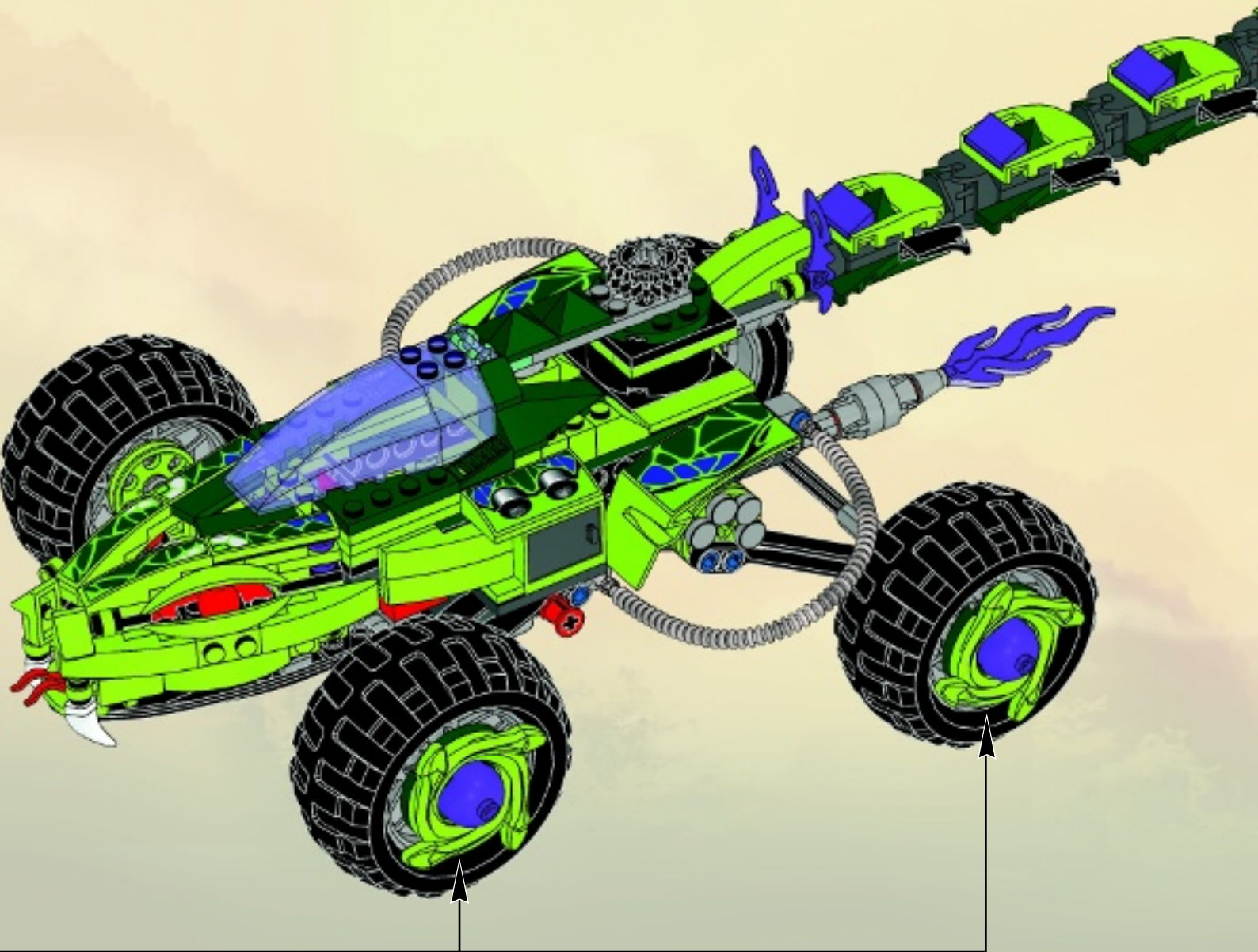

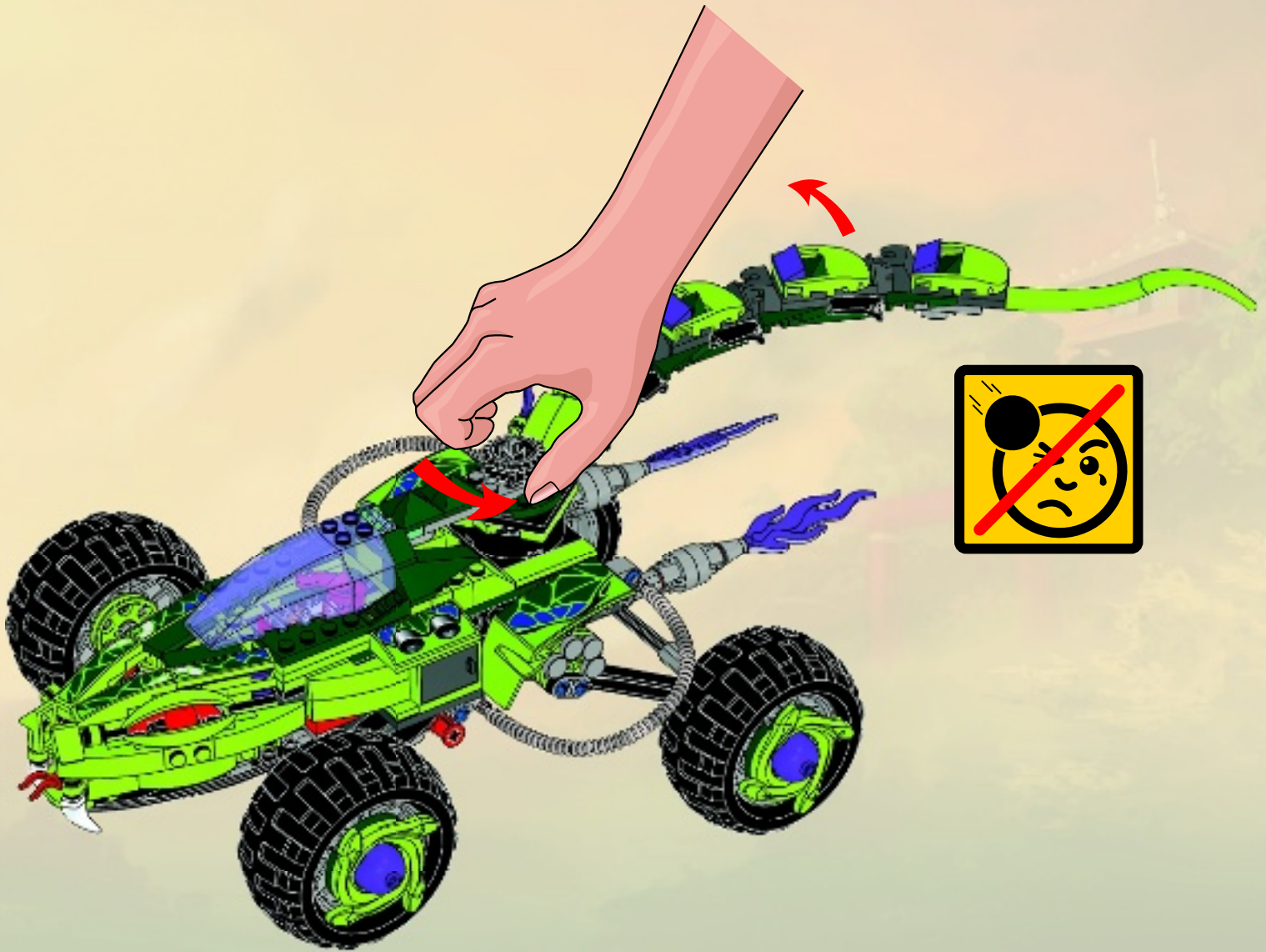



































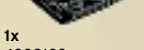











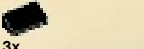
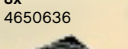





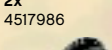





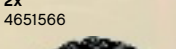













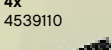

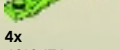



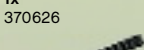

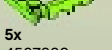



4x







 3x 4249112	 1x 4613174	 6x 4227155	 2x 4140588	 1x 393726	 4x 4107085	 2x 4537937
 2x 302301	 2x 302221	 2x 4142865	 1x 4225201	 6x 74011	 2x 4107082	 10x 4187743
 1x 371001	 2x 4588003	 4x 370023	 2x 4183043	 1x 4140670	 10x 4121715	 7x 4529160
 3x 302001	 1x 4140585	 2x 302223	 3x 4298011	 1x 4603189	 1x 4278359	 6x 4632576
 3x 255501	 1x 449521	 1x 379423	 1x 4558957	 8x 4650636	 1x 3003126	 4x 4500125
 2x 4535737	 1x 4648092	 2x 4505907	 2x 3200026	 3x 4548180	 1x 4177430	 6x 4569452
 1x 4650588	 1x 4647306	 1x 4650492	 1x 4541984	 2x 4517986	 1x 4653402	 4x 4164021
 1x 4650494	 1x 4647443	 1x 4650129	 1x 4541984	 2x 4651566	 1x 4220631	 2x 4625623
 1x 4650130	 1x 4648354	 1x 4650118	 1x 4180469	 4x 4539110	 3x 4650630	 1x 4650634
 1x 4650119	 1x 4648360	 2x 4597338	 2x 4162443	 1x 370626	 2x 4648274	 1x 4650635
 2x 4566256	 1x 4538780	 12x 4143005	 2x 346026	 1x 370626	 12x 4537927	 4x 4610474
 1x 4195869	 1x 9552	 2x 4206482	 1x 303426	 2x 370726	 2x 4617069	 5x 4567882
 1x 4612342	 1x 4648351	 12x 4514553	 4x 389526	 1x 370826	 3x 4625474	 2x 4597561
 2x 362221	 2x 4290714	 1x 4611427	 1x 4611429		 6x 4164037	 4x 4647108



8x  
4494219



1x  
4518814



1x  
4518816



1x  
4651579



10x  
4266666



2x  
4650622



2x  
4648467



3x  
4586057



1x  
4500060



1x  
4500059



1x  
4293614



1x  
4293615



1x  
4648340



1x  
4648342



4x  
4649051



5x  
4612728



2x  
4651834



2x  
4211396



2x  
4211804



1x  
4211840



1x  
4211841



1x  
4211542



12x  
4211475



8x  
4650260



1x  
4299119



2x  
4538007



1x  
4646815



4x  
4634091



2x  
4600448



2x  
4625236



2x  
4529241



4x  
4211566



12x  
4211573



6x  
4211807



6x  
4512360



4x  
4211815



3x  
4211639



1x  
4612900



4x  
4278756



2x  
4210875



2x  
4213607



2x  
4210917



1x  
4211064



2x  
4210779



2x  
4211085



1x  
4211065



1x  
4211002



1x  
4211122



2x  
4615232



2x  
4210686



2x  
4499858



1x  
4211043



1x  
4210892



2x  
4210811



4x  
4265486



4x  
4264952



1x  
4196768



1x  
4278274



2x  
4289542



4x  
4529247



4x  
4490599



3x  
4523159



4x  
4649422



2x  
4600519



1x  
4646828



2x  
4646871



1x  
4646814



4x  
4595891



4x  
4566607



4x  
4566522



2x  
4651825



2x  
4651591



Customer Service

Kundenservice

Service Consommateurs

Servicio Al Consumidor

[www.lego.com/service](http://www.lego.com/service) or dial



00800 5346 5555 :



1-800-422-5346 :



**LEGO** **NINJAGO**  
Masters of Spinjitzu

**CUSTOMIZE YOUR SPINNERS**  
**PERSONNALISE TES TOUPIES**  
**PERSONALIZA TUS SPINNERS**

**RATTLA**

**COLE ZX**

**9579**

**ARENA INCLUDED**  
**ARÈNE INCLUSE**  
**ARENA INCLUIDA**

**+**

**9551**

**9552**

**9553**

**CUSTOMIZE WITH BOOSTER PACKS**

**PERSONNALISE GRÂCE AUX BOOSTERS**

**PERSONALÍZALO CON PACKS DE REFUERZO**

**NINJAGO.COM**

**COLE ZX VS RATTLA**

**LASHA**

**KENDO ZANE**

**SNARPA**

**SAMIRAT X**

**HAI ZX**

**FANG-SUI**

**9579**

**9562**

**9563**

**9564**

**9566**

**9561**

**9567**



**KENDO ZANE**  
9563 - 9446



**KENDO KAI**  
9558



**KENDO COLE**  
9551



**COLE ZX**  
9579 - 9444



**ZANE ZX**  
9440  
9445



**JAY ZX**  
9553  
9442  
9445



**SAMURAI X**  
9566



**LLOYD GARMADON**  
9552 - 9443



**FANG-SUEI**  
9567 - 9443



**FANGDAM**  
9445



**LASHA**  
9562



**RATTLA**  
9579 - 9441



**SNAPPA**  
9564 - 9442







# NINJAGO

Masters of Spinjitzu



[NINJAGO.COM](http://NINJAGO.COM)



# NINJAGO

Masters of Spinjitzu



**CUSTOMIZE YOUR SPINNERS  
PERSONNALISE TES TOUPIES  
PERSONALIZABLE TUS SPINNERS**





# NINJAGO

Masters of Spinjitzu



NINJAGO.COM



# WIN!

Go to [www.LEGOsurvey.com/product](http://www.LEGOsurvey.com/product) to fill out a survey for a chance to win a cool LEGO® Product.  
No purchase necessary.  
Open to all residents where not prohibited.

 [www.LEGO.com](http://www.LEGO.com)



## [www.LEGOsurvey.com/product](http://www.LEGOsurvey.com/product)

### GEWINNE! WIN!

Nimm an der Umfrage auf [www.LEGOsurvey.com/product](http://www.LEGOsurvey.com/product) teil und hab die Chance ein cooles LEGO® Produkt zu gewinnen!  
Die Teilnahme am Gewinnspiel führt zu keinerlei Kaufverpflichtungen. Teilnahme in allen nicht ausgeschlossenen Ländern möglich.

Ga naar [www.LEGOsurvey.com/product](http://www.LEGOsurvey.com/product), vul een enquêteformulier in en maak kans op een cool LEGO® product.  
Geen aankoopverplichting, iedereen mag deelnemen, uitzonderend ingezetenden van landen waar een enquêteverbod geldt.

### GAGNE! 当てよう!

Visite [www.LEGOsurvey.com/product](http://www.LEGOsurvey.com/product) pour répondre à un questionnaire et avoir une chance de gagner un produit LEGO® très cool!  
Aucune obligation d'achat.  
Ouvert à tous les résidents des pays autorisés.

[www.LEGOsurvey.com/product](http://www.LEGOsurvey.com/product) にアクセスして、アンケートにご記入ください。当選者にはレゴ®製品を差し上げます。  
お買い上げの必要はありません。  
禁止されていない限り、すべての皆様にご利用いただけます。