



NINJAGO

Masters of Spinjitzu

9449



JAY ZX + ZANE ZX
INCLUDED



1

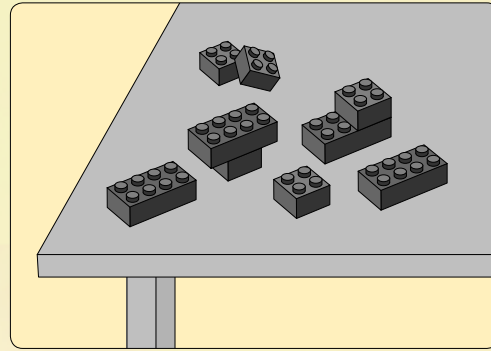
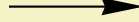
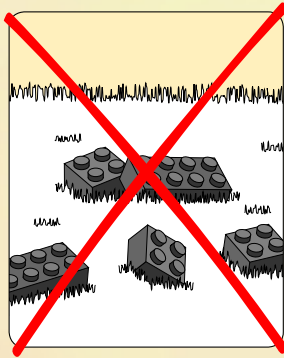

2



<http://lego.com/brickseparator>

2 IN 1
 2 IN EINEM
 2 EN 1
 2 EN 1
 2 EM 1
 2 AZ EGYBEN

JAY ZX + ZANE ZX INCLUDED
 ENTHLÄT JAY ZX + ZANE ZX
 JAY ZX + ZANE ZX INCLUS
 INCLUDE A JAY ZX Y A ZANE ZX
 JAY ZX + ZANE ZX INCLUIDOS
 JAY ZX + ZANE ZX A CSOMAGBAN

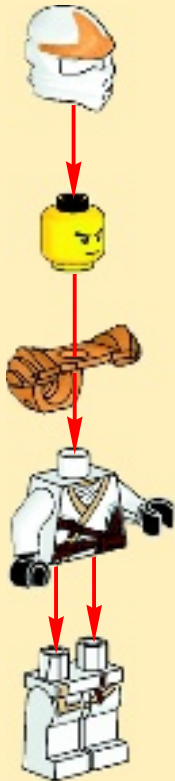

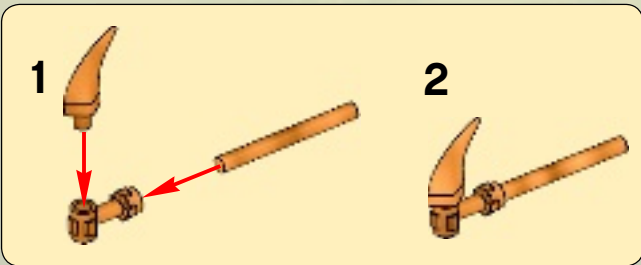
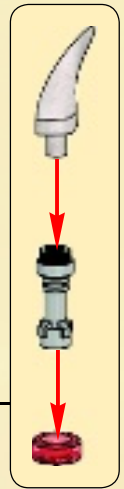
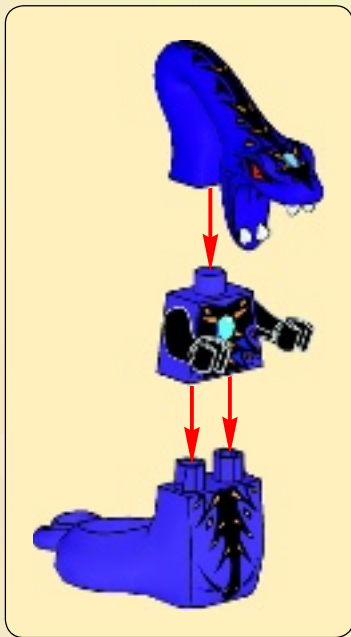

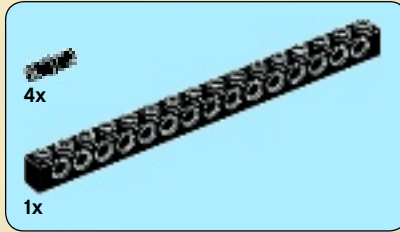
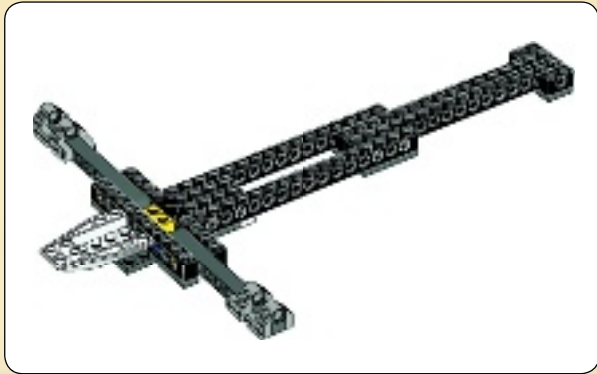
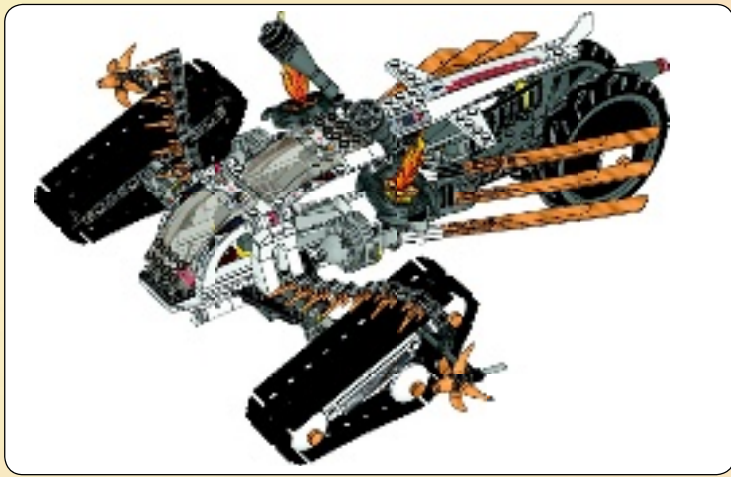

1





2





3

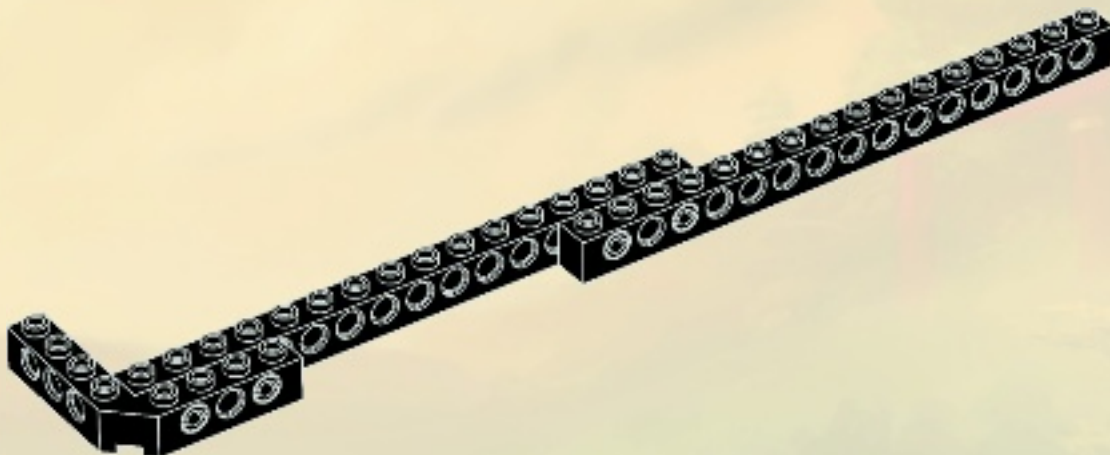



2x

4

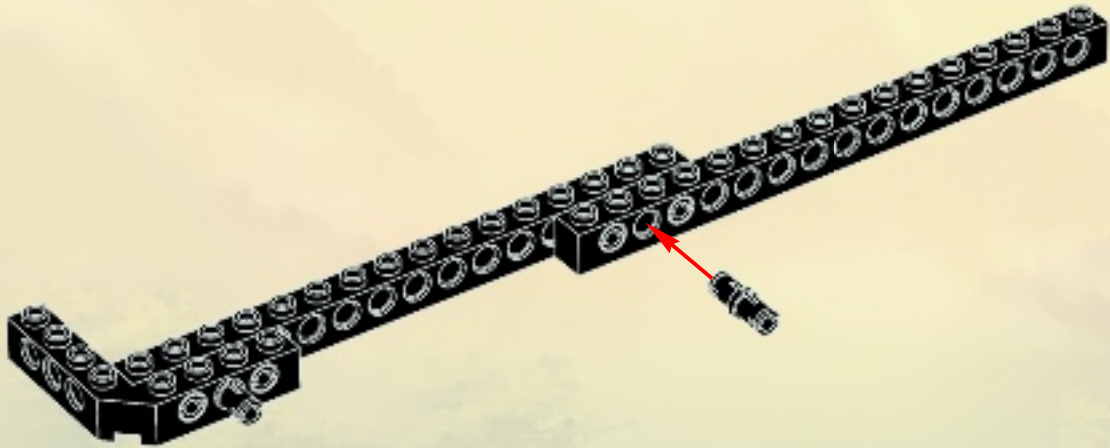

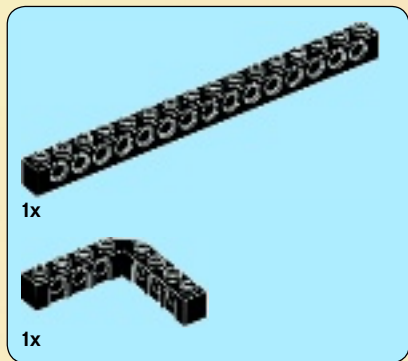

5

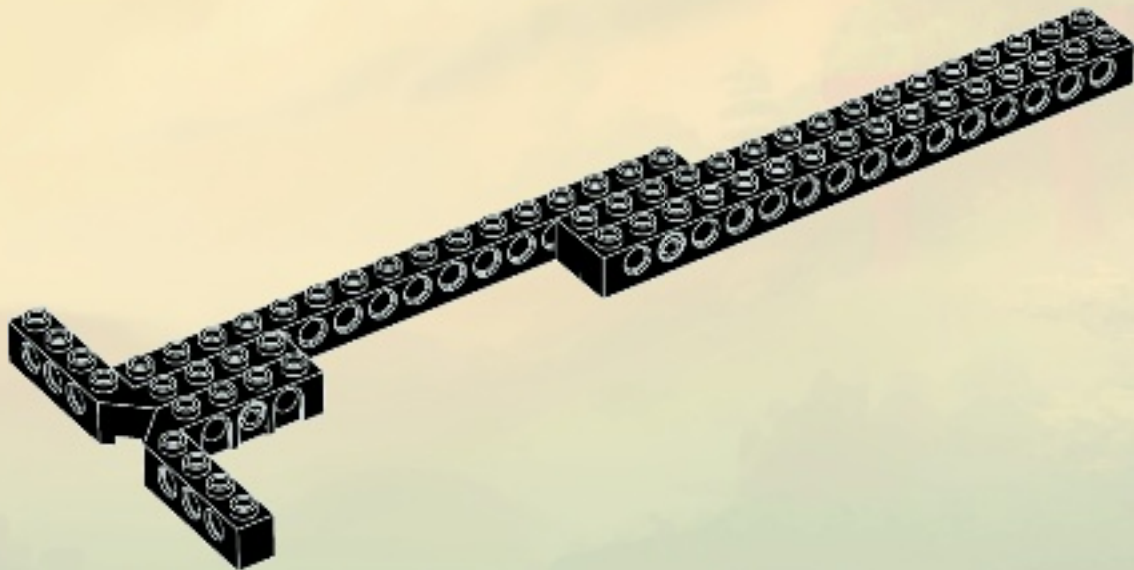



4x

6

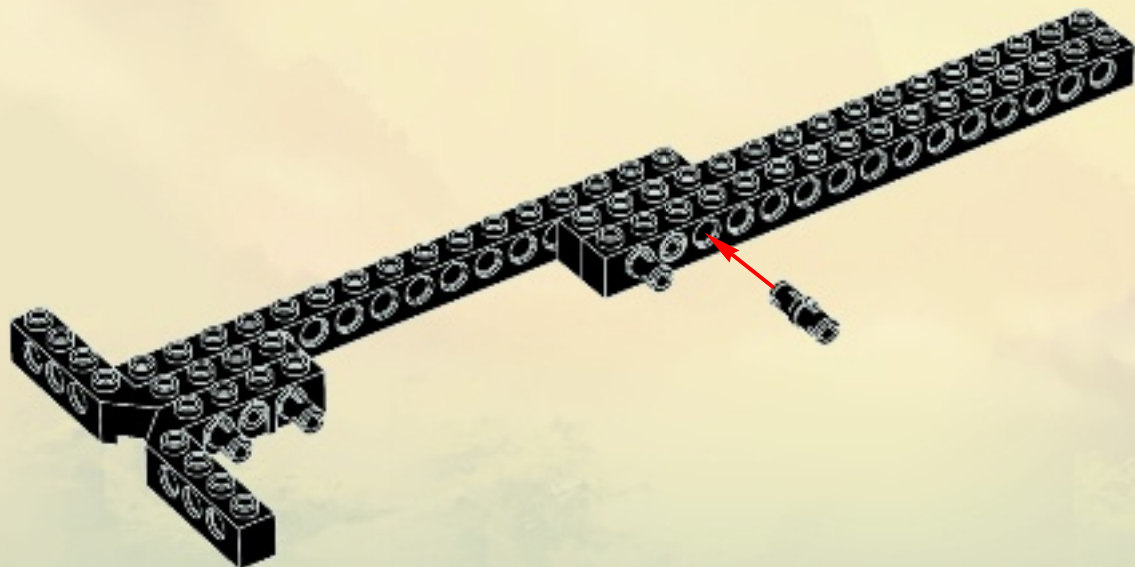

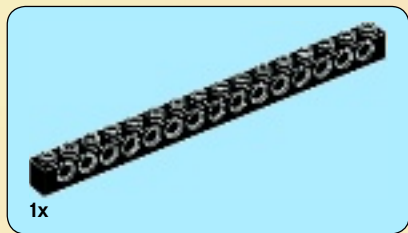

7

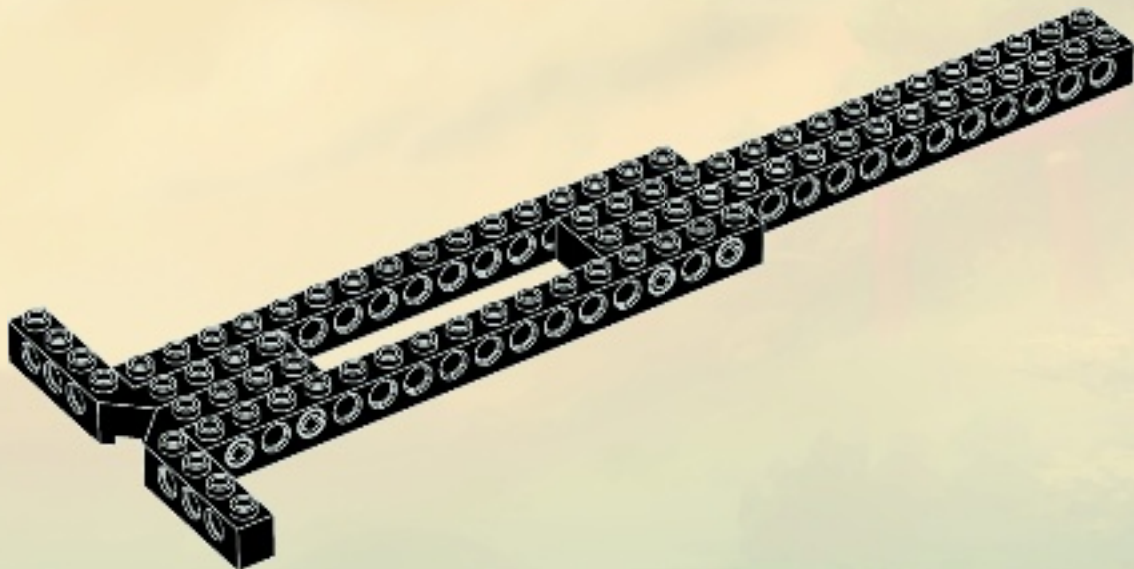

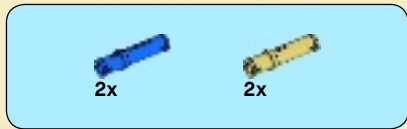

8

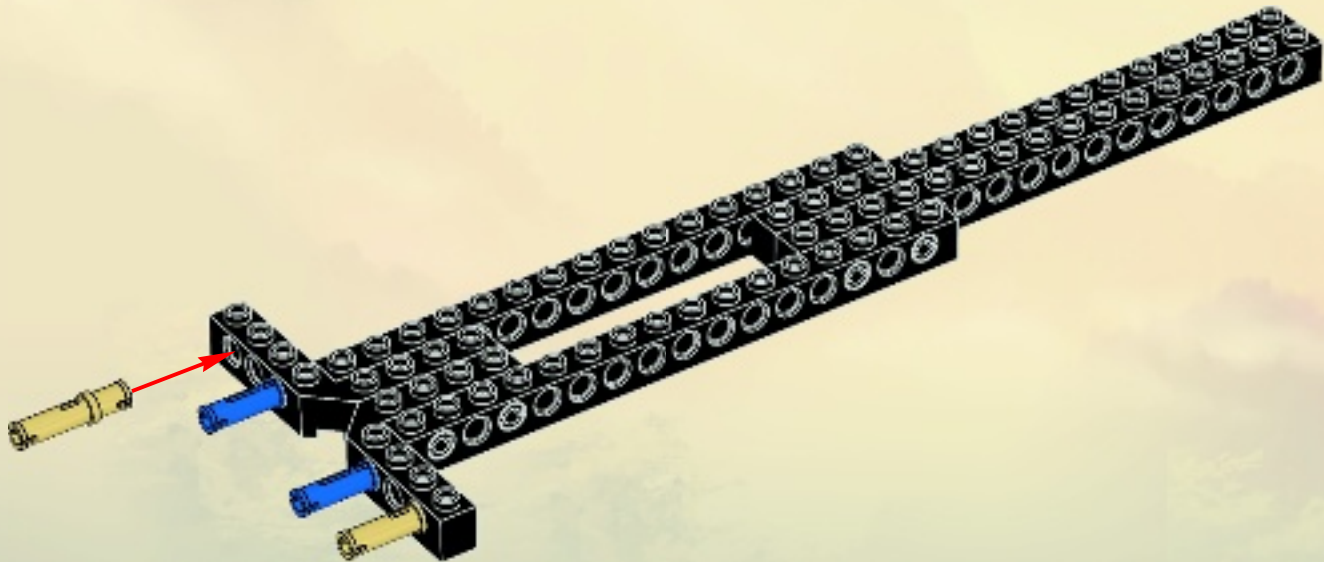

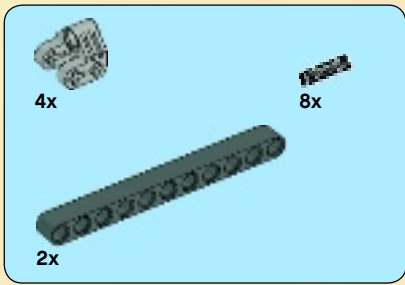

9

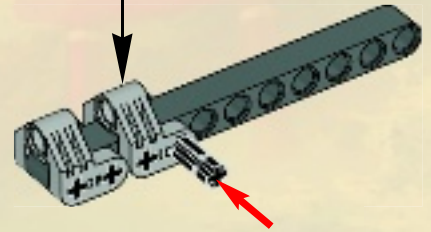
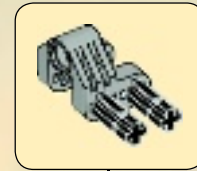
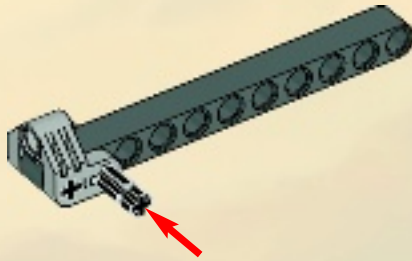

2x

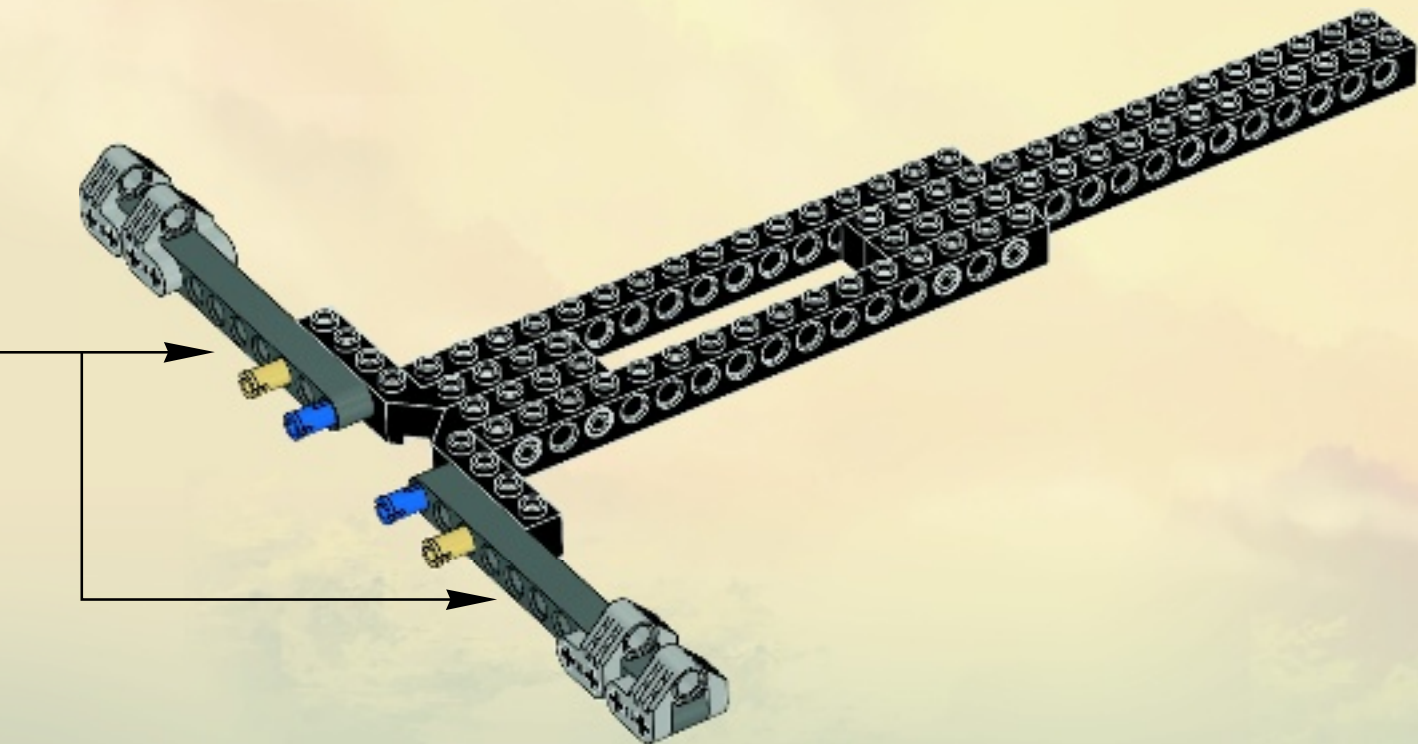



10

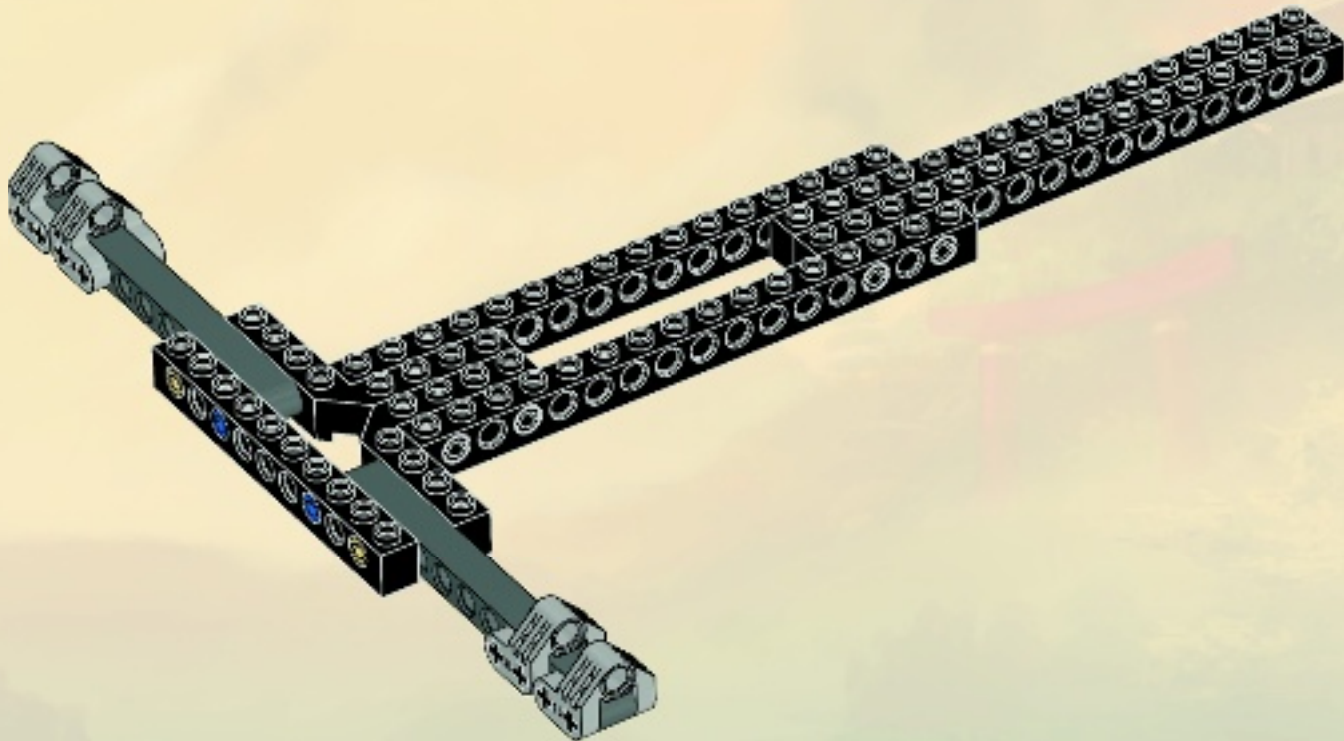

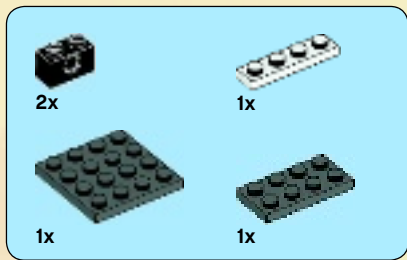

11

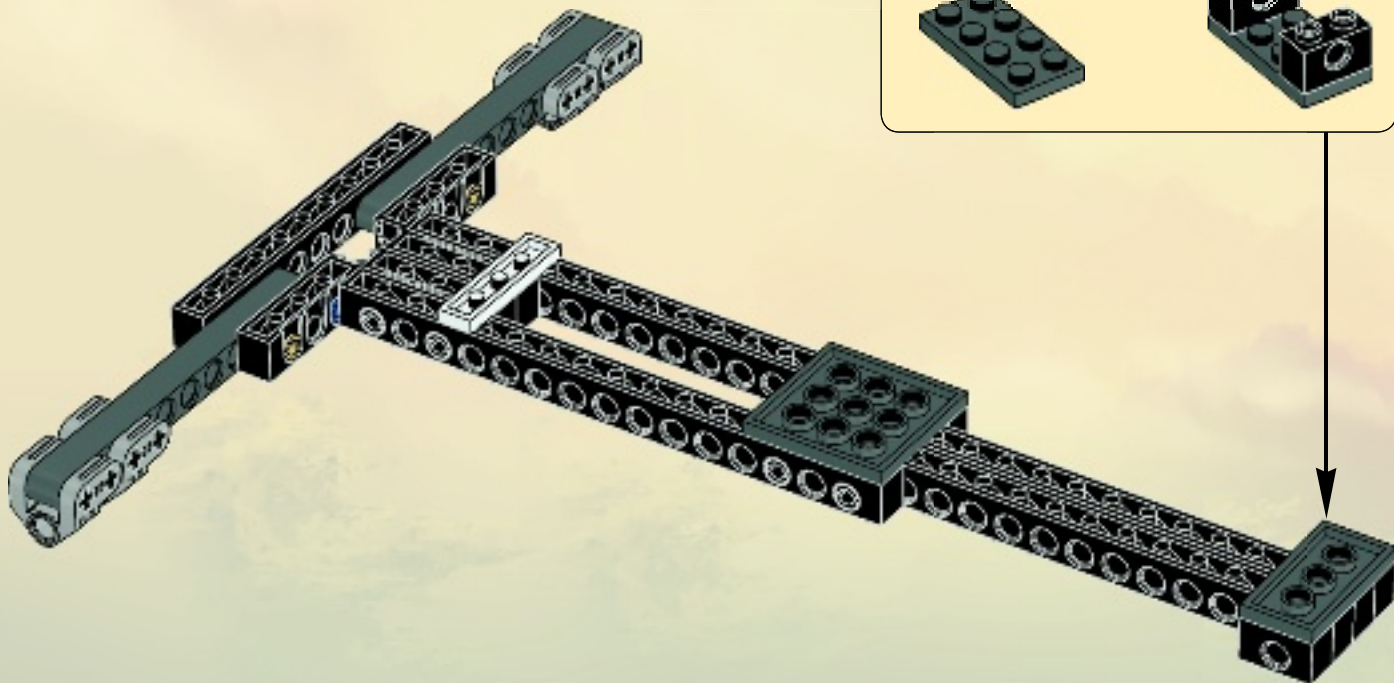
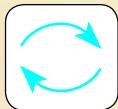



12

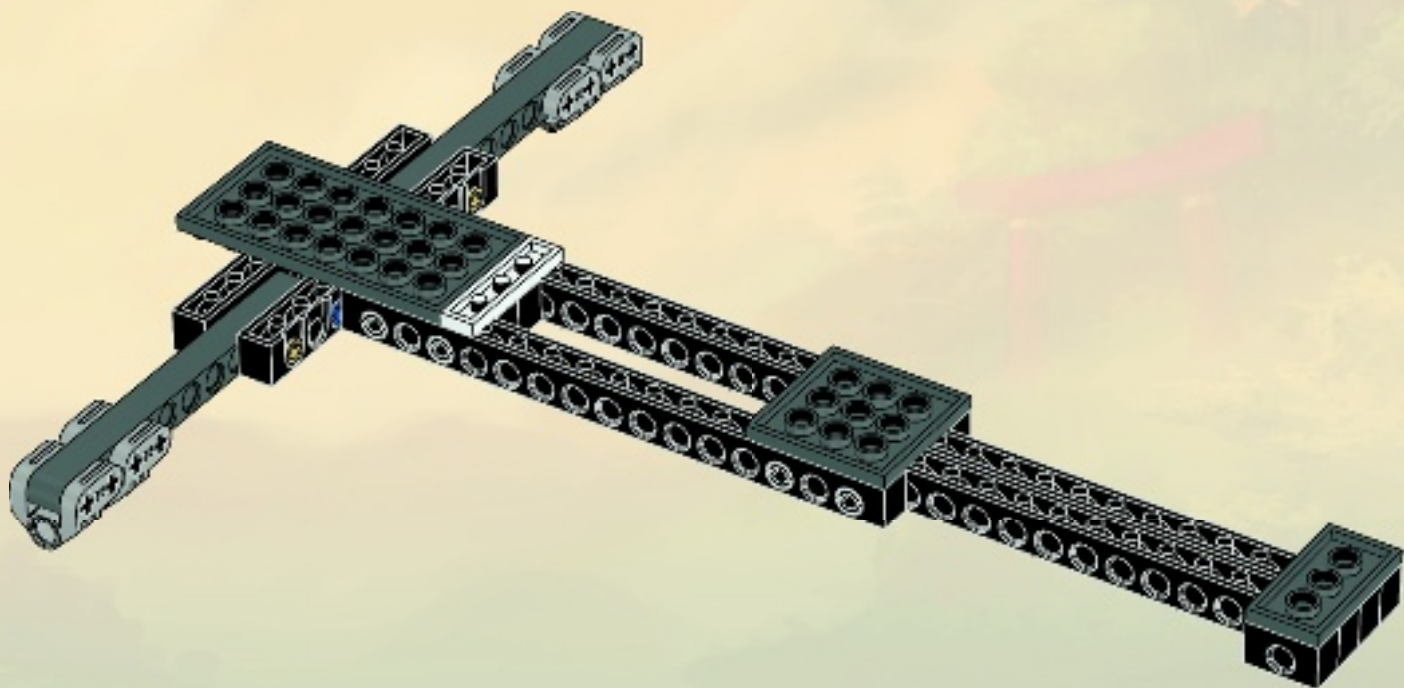



4x

13

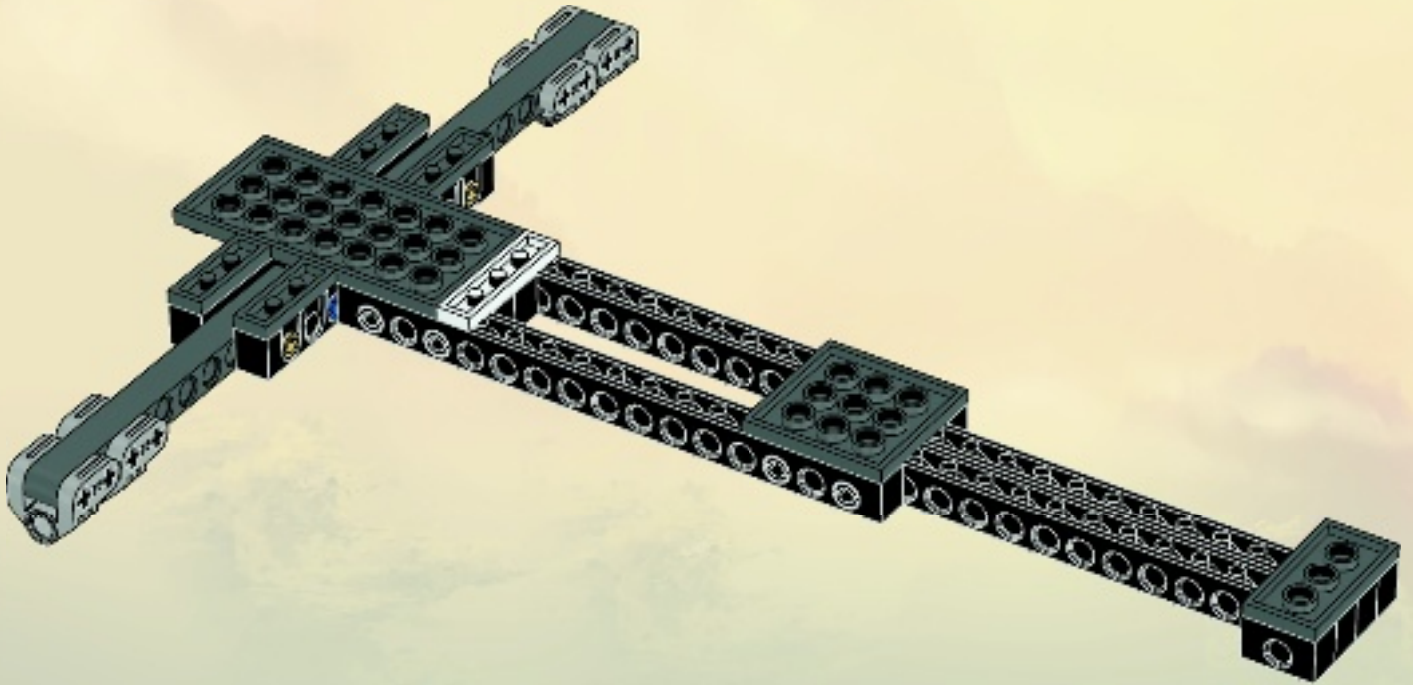

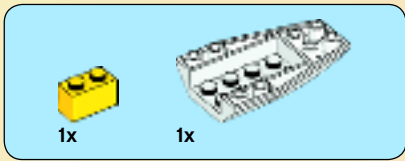

14

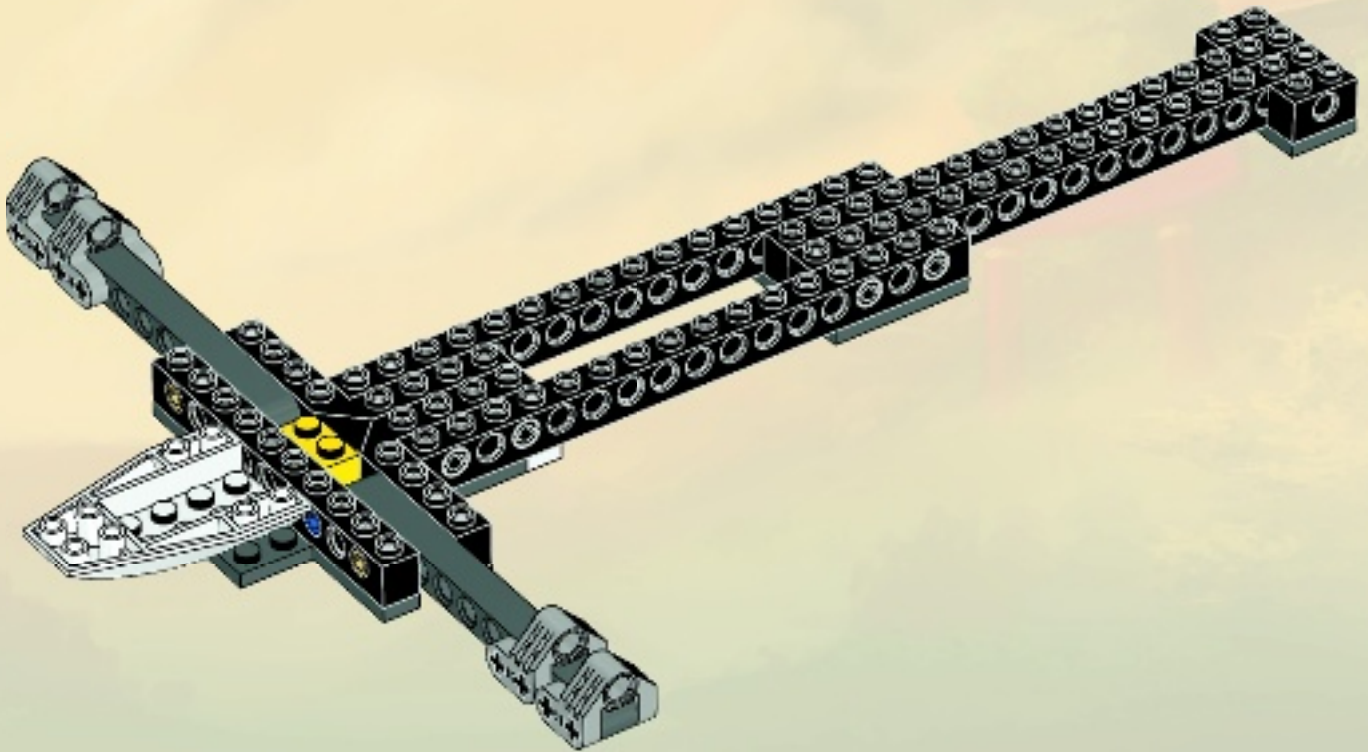
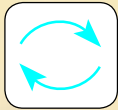

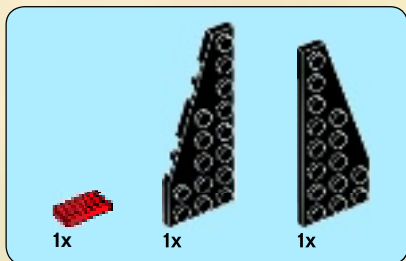

15

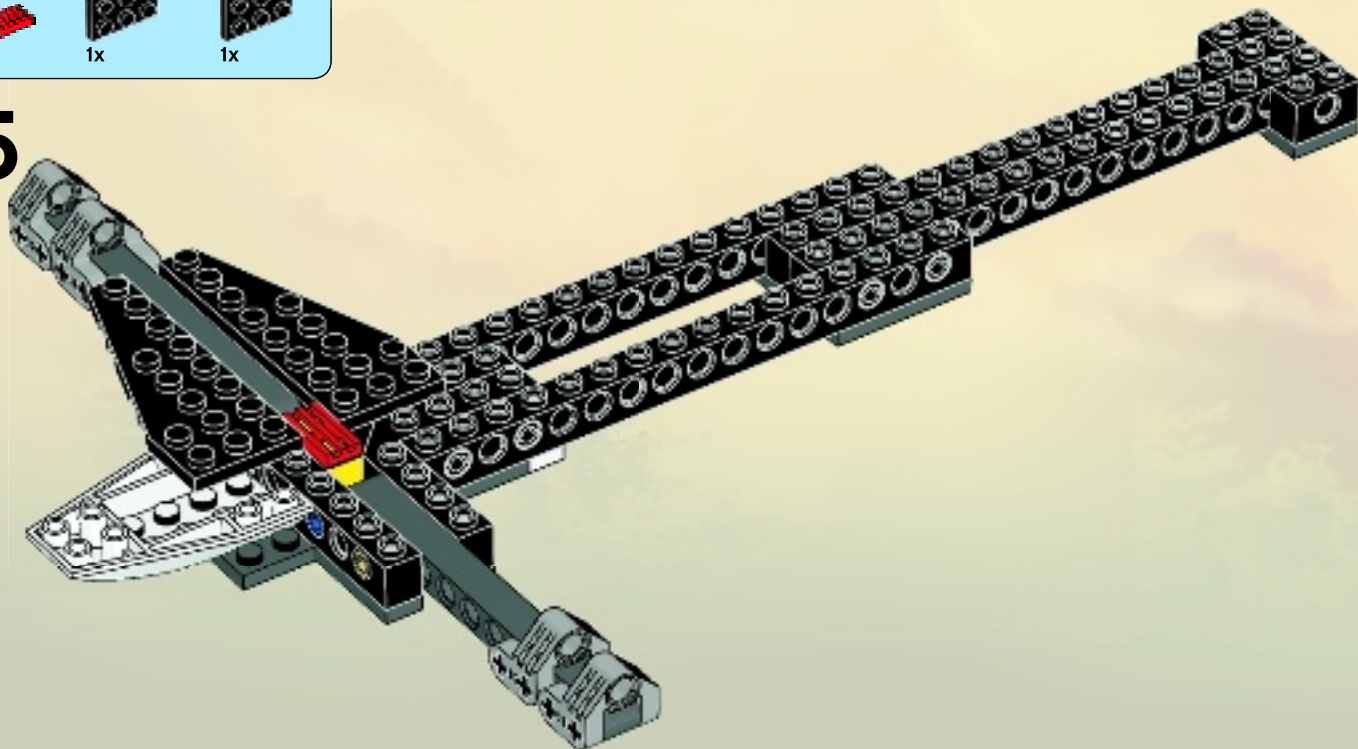

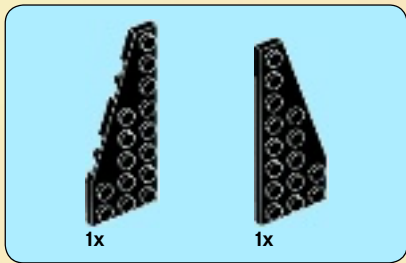

16

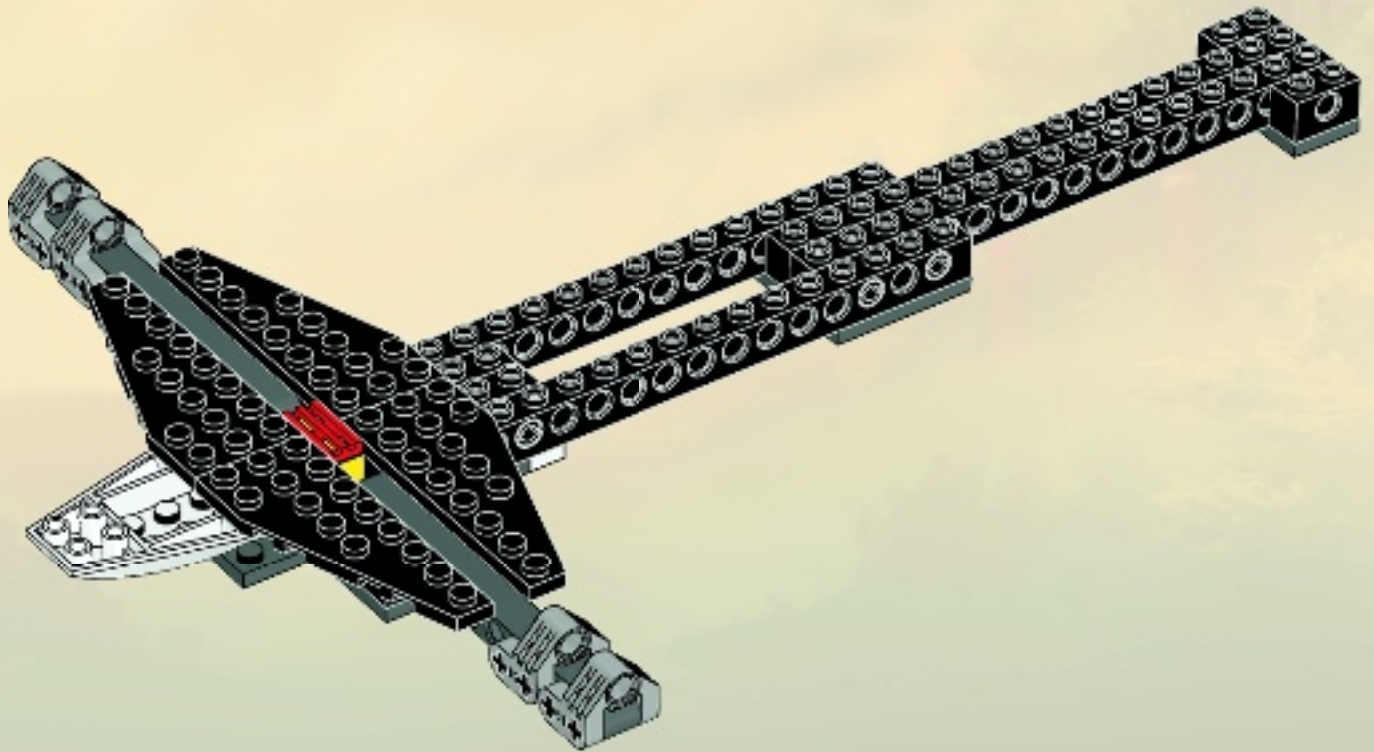

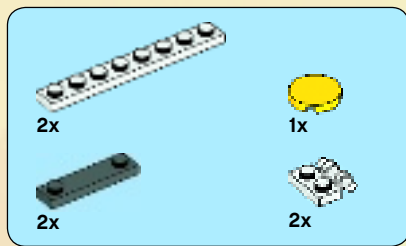

17

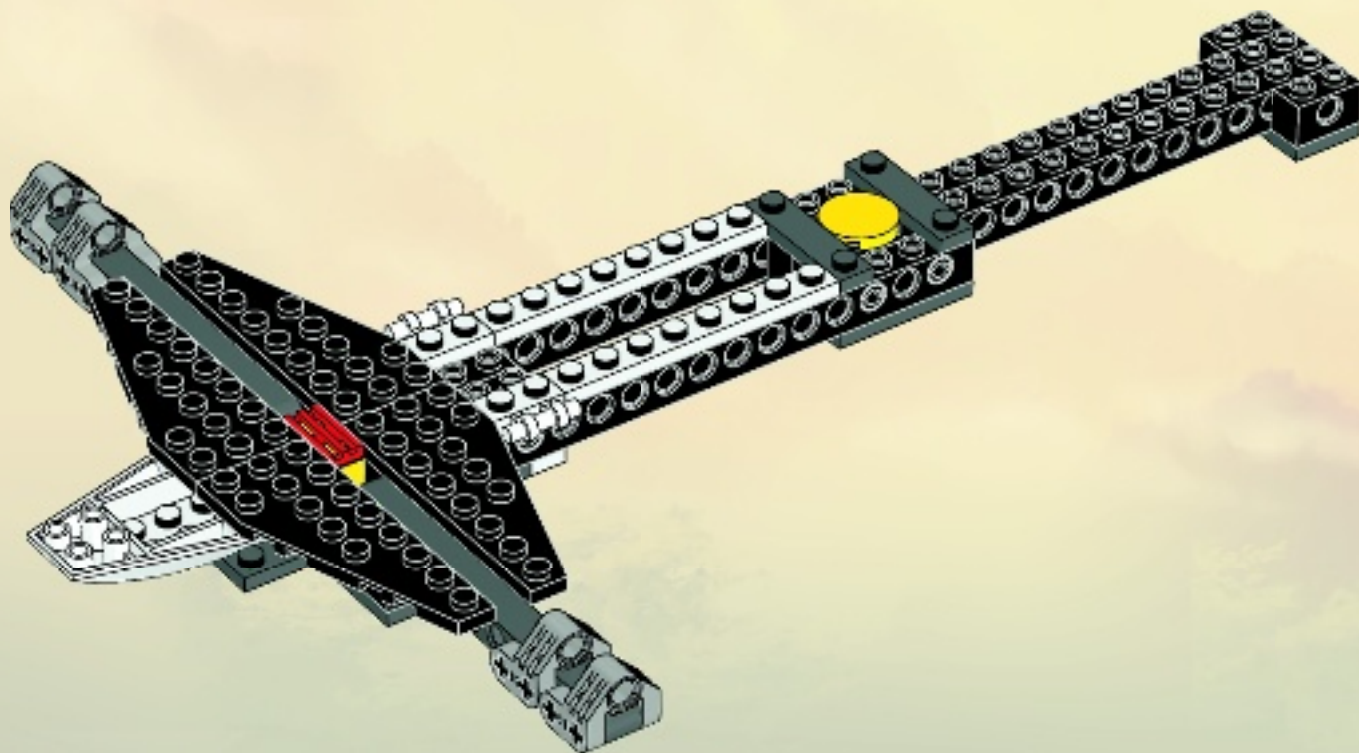

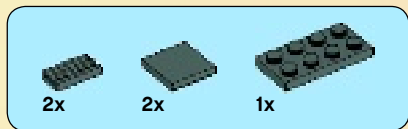

18

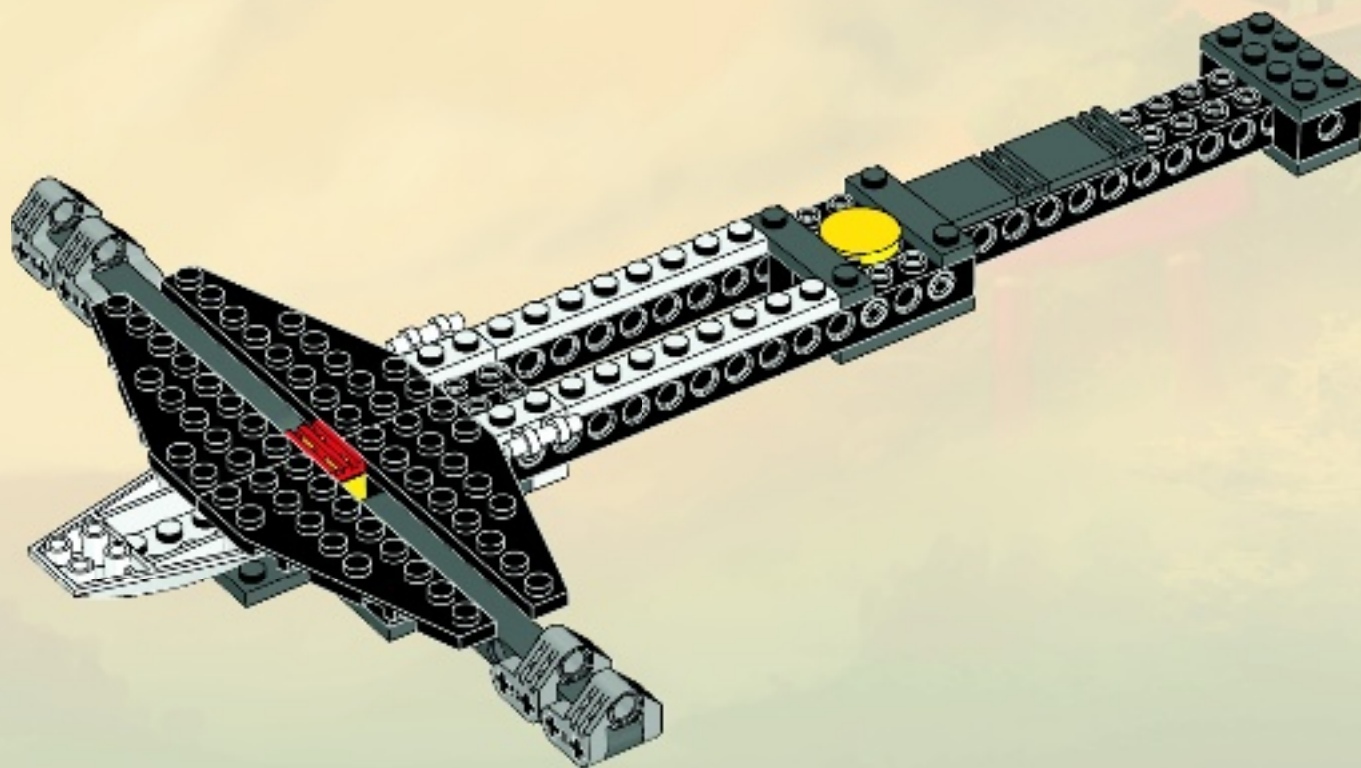



19

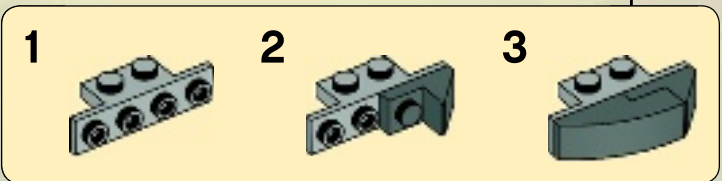
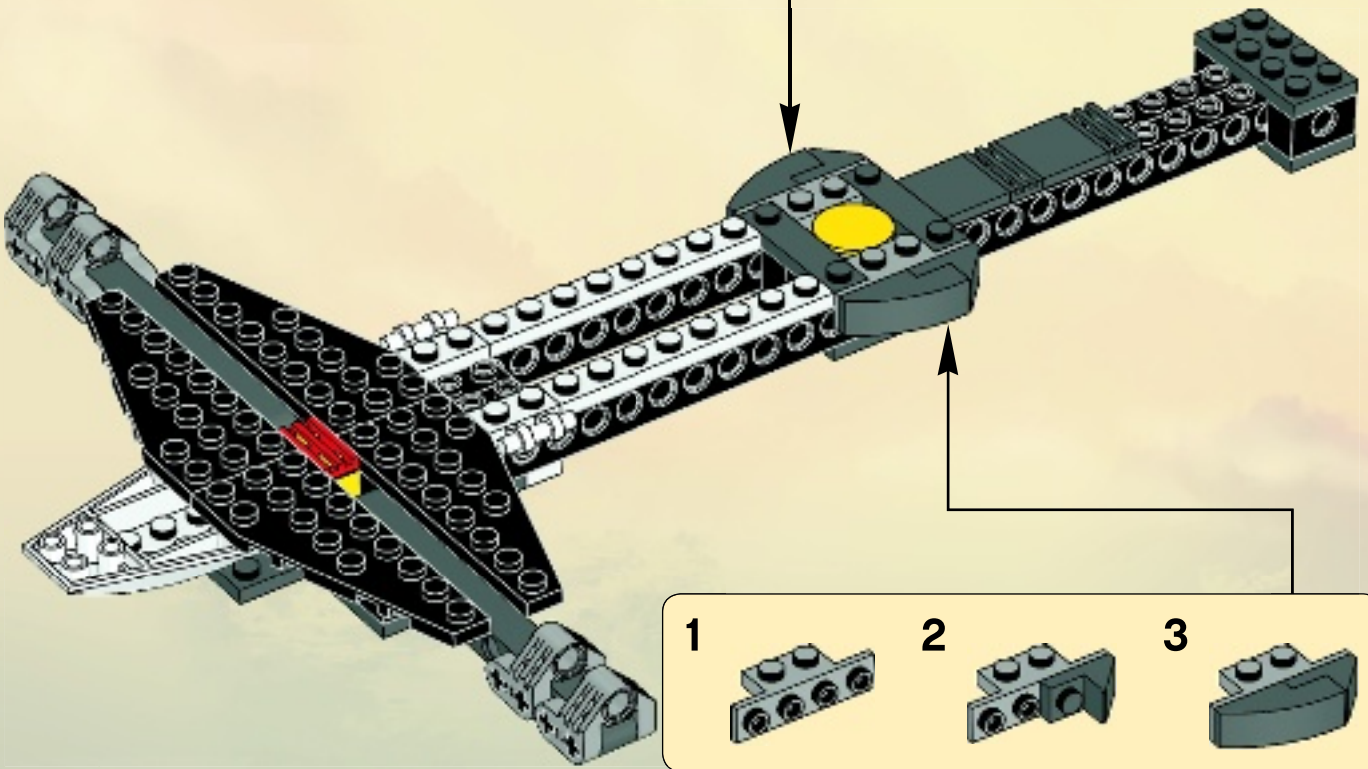
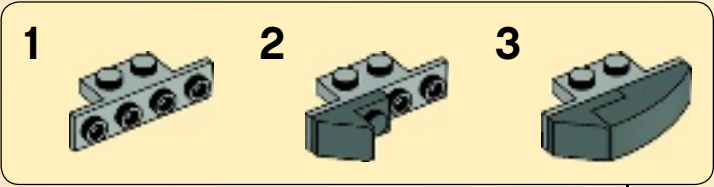

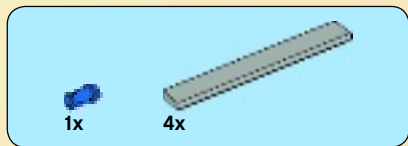

20

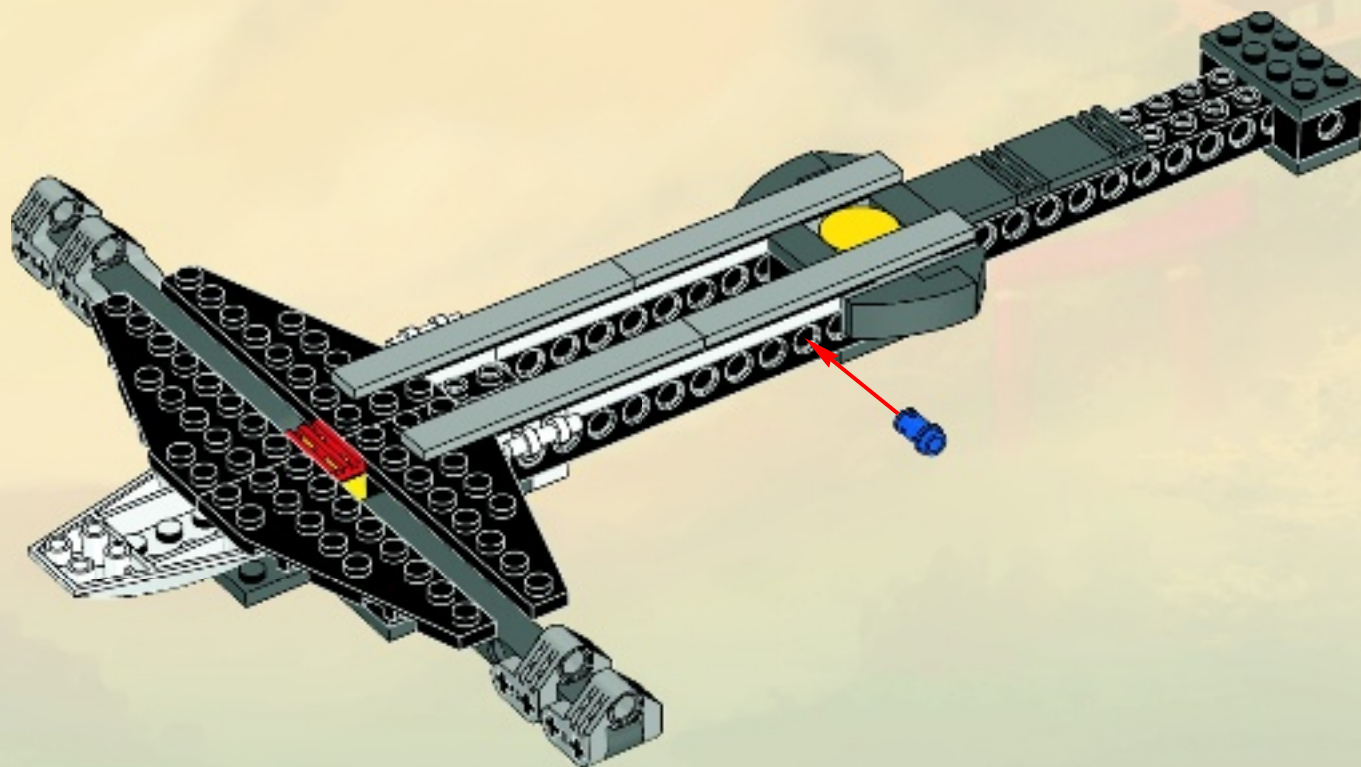



21

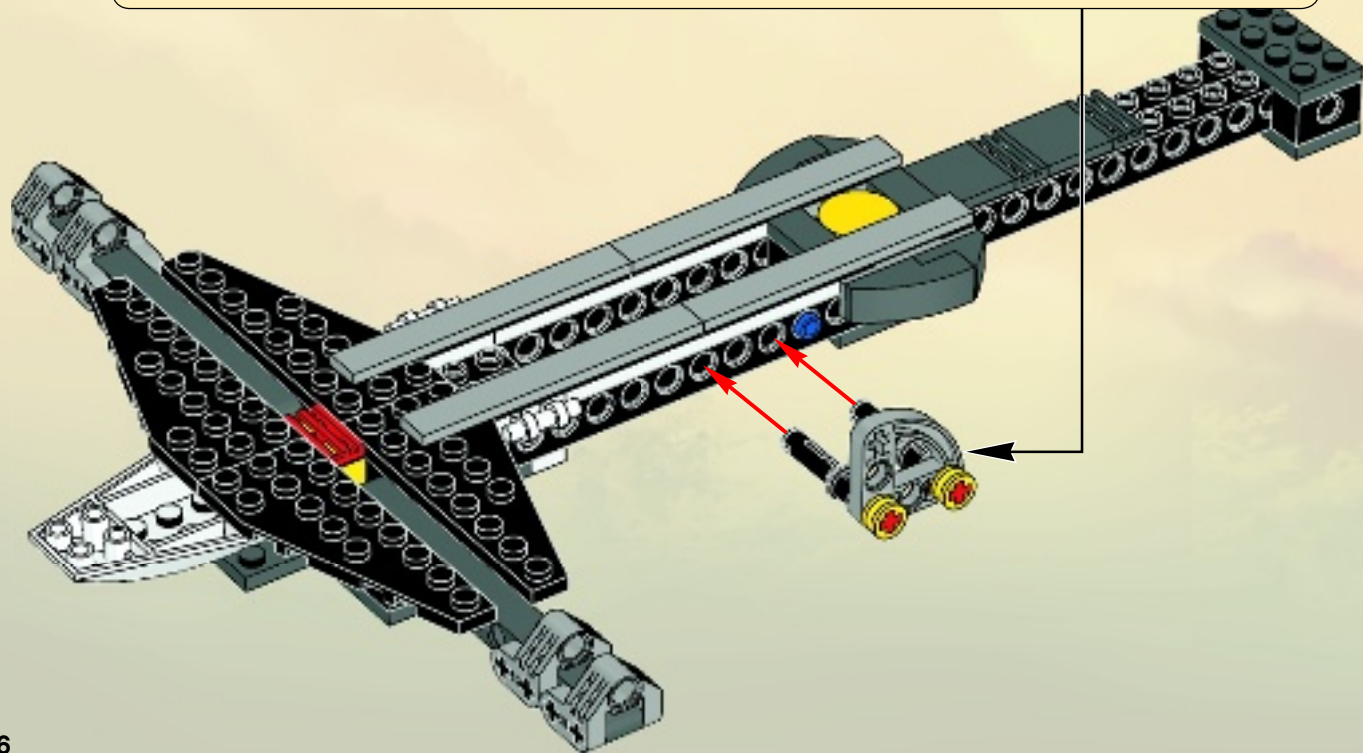
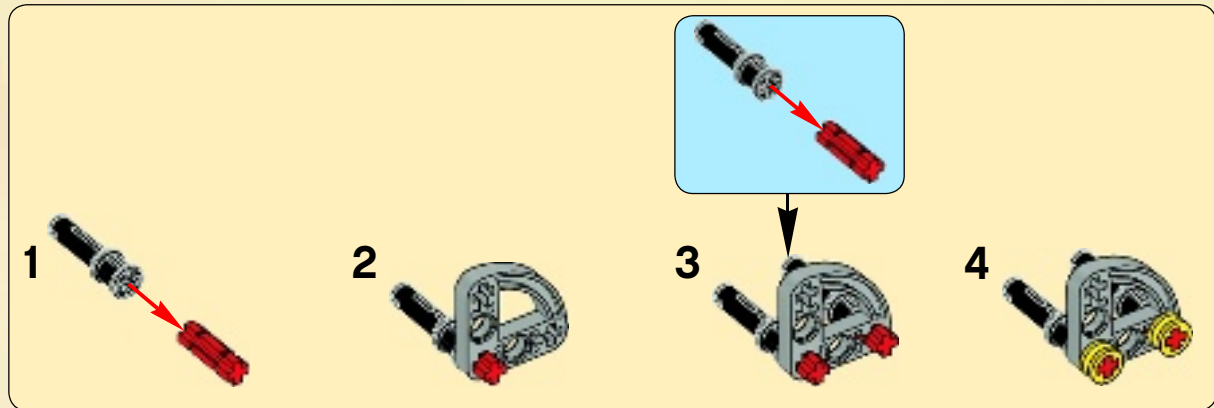



1x

22

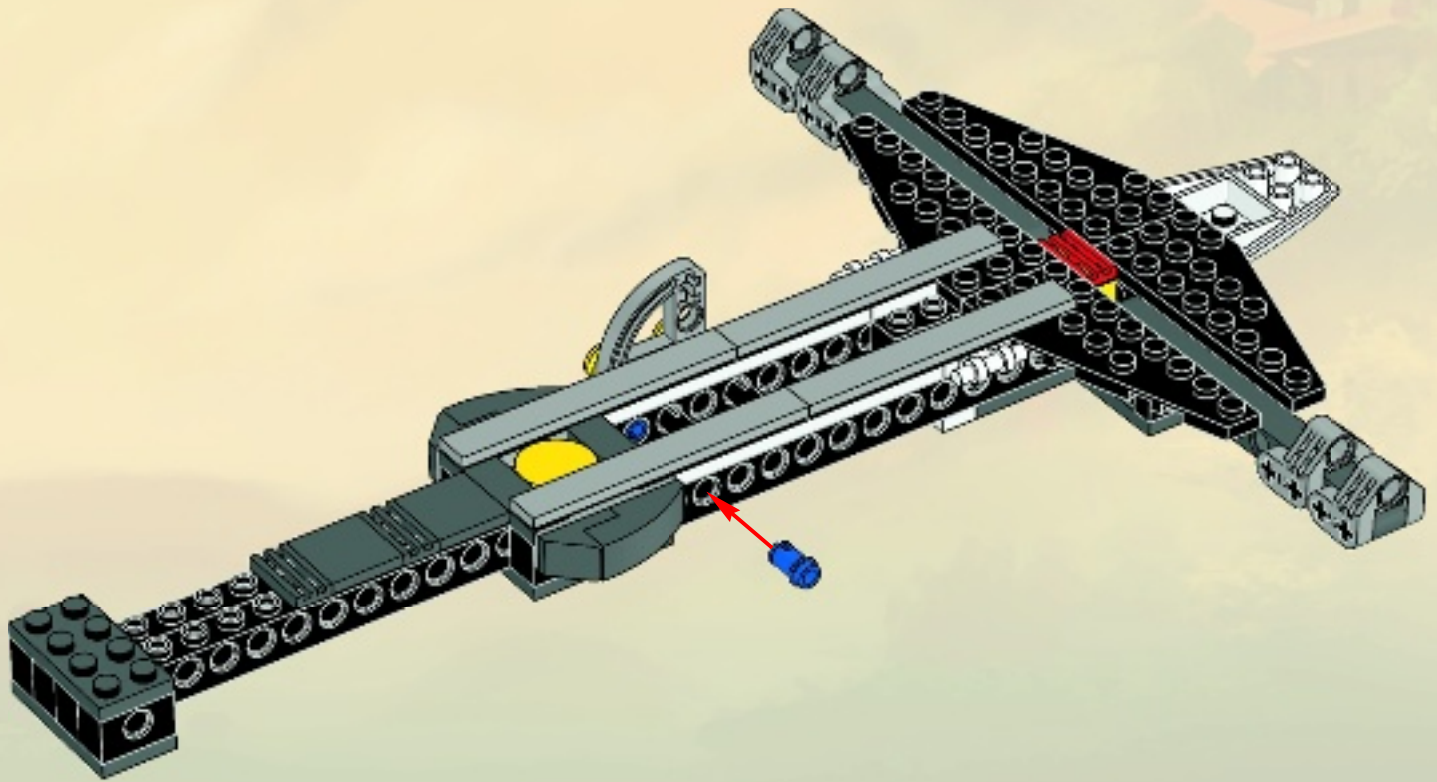
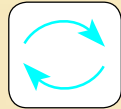



23

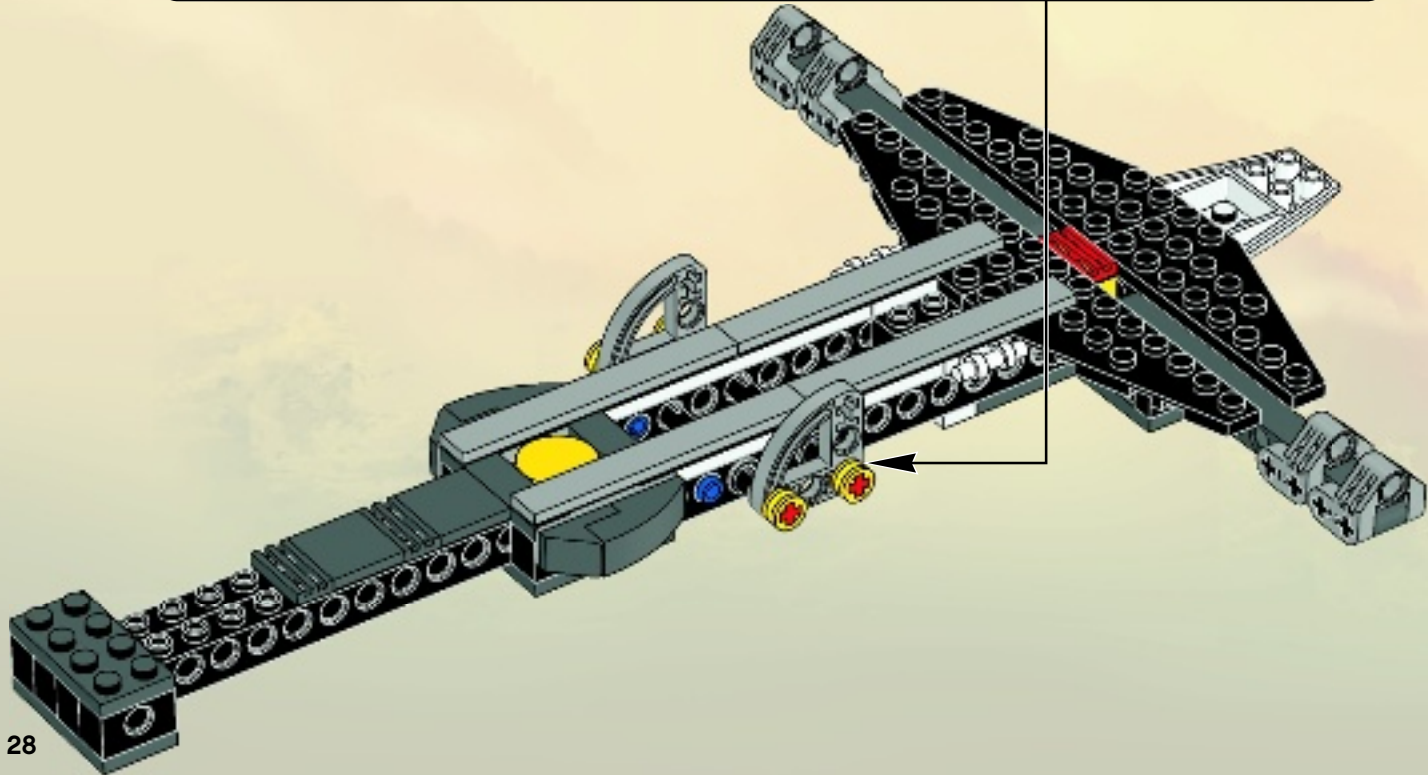
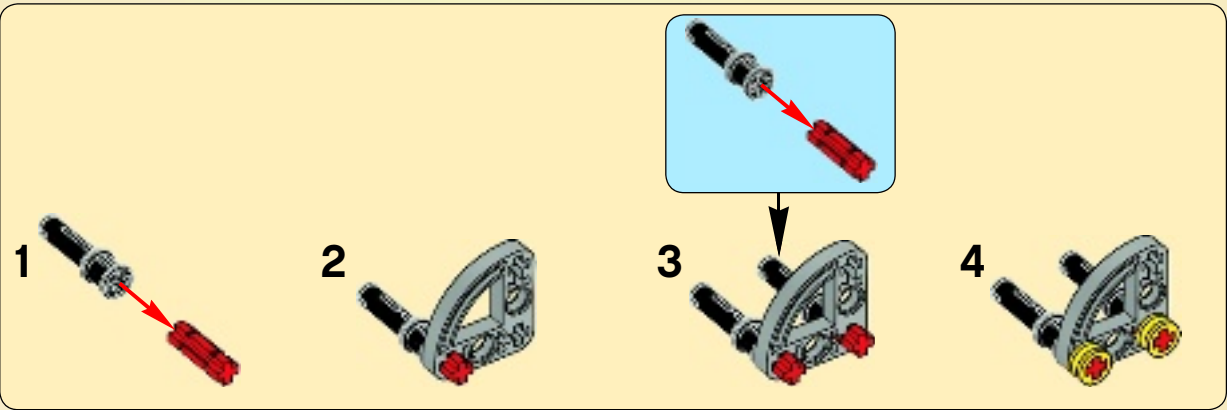



24

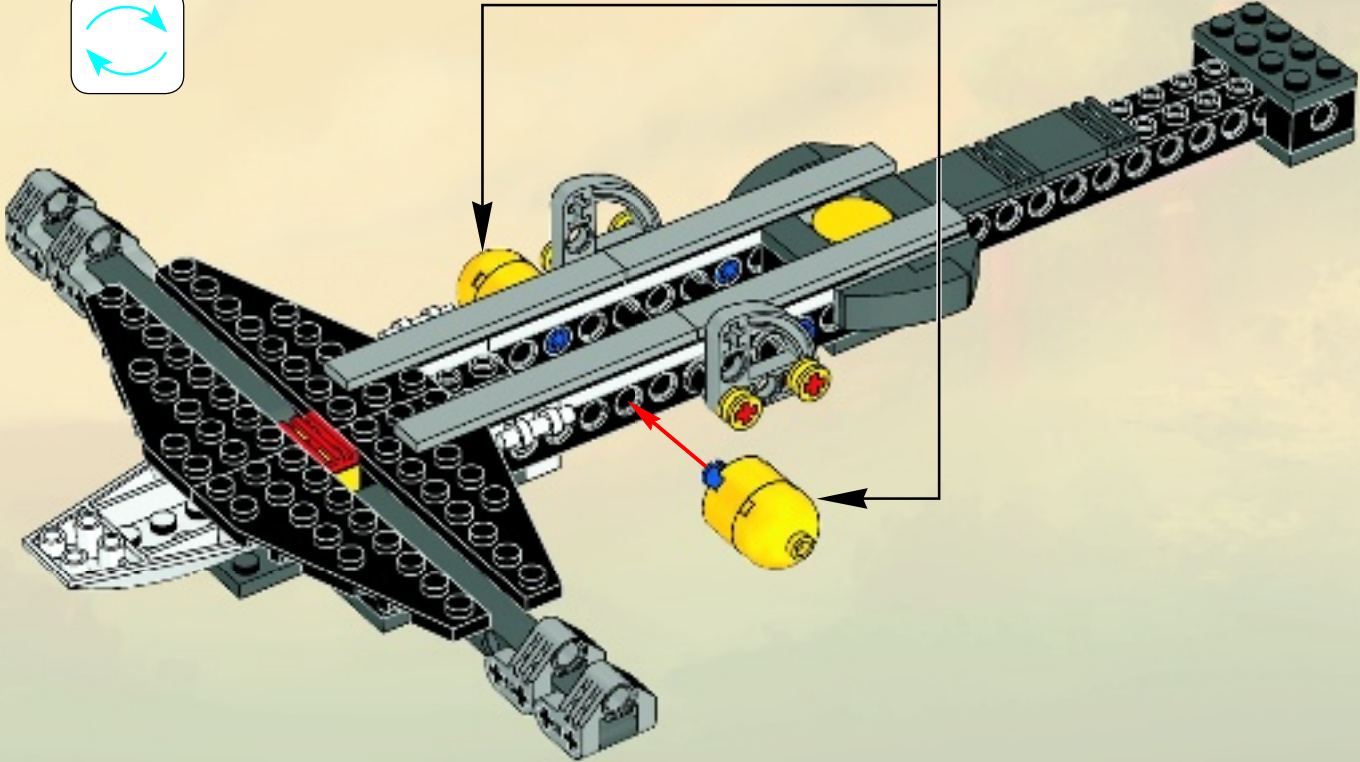
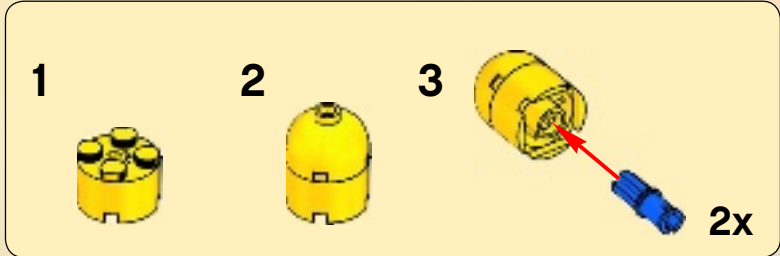

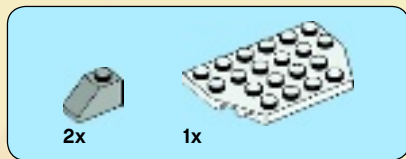

25

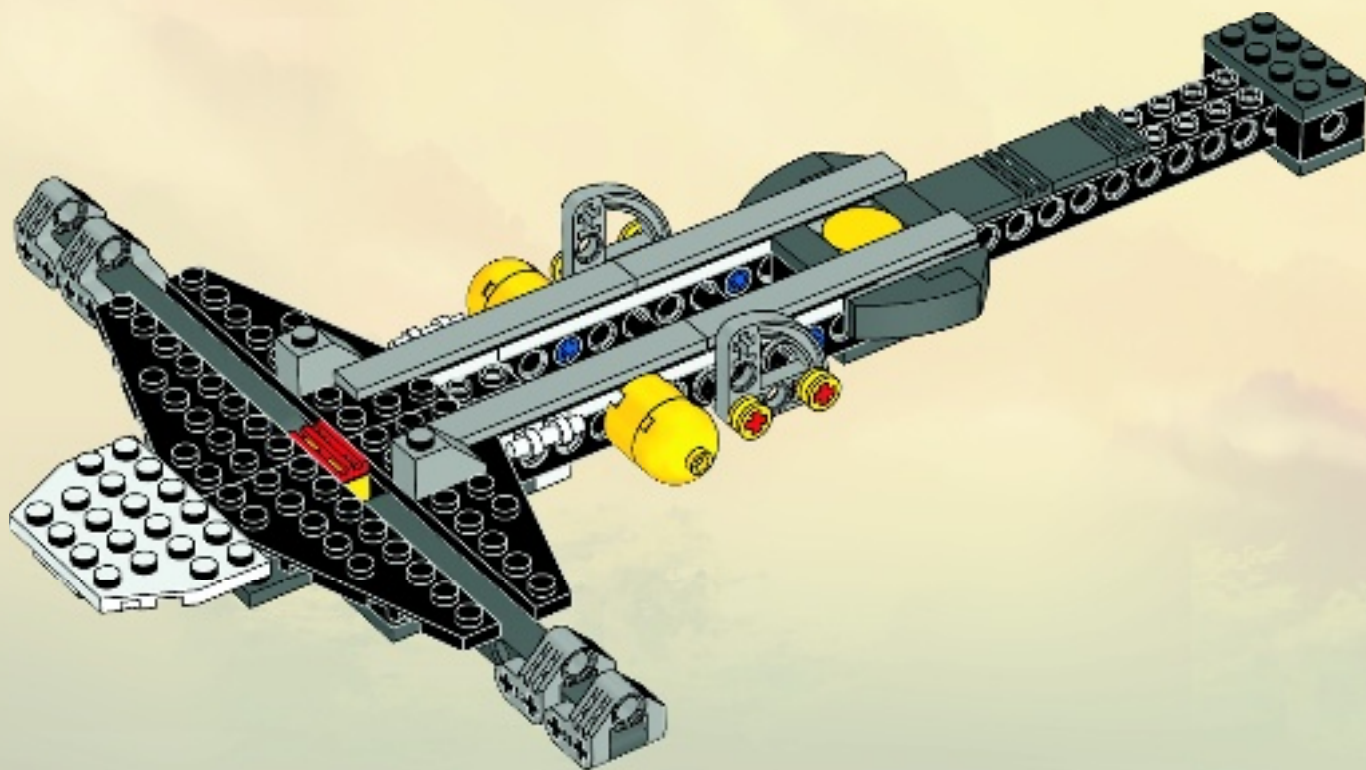



2x

26

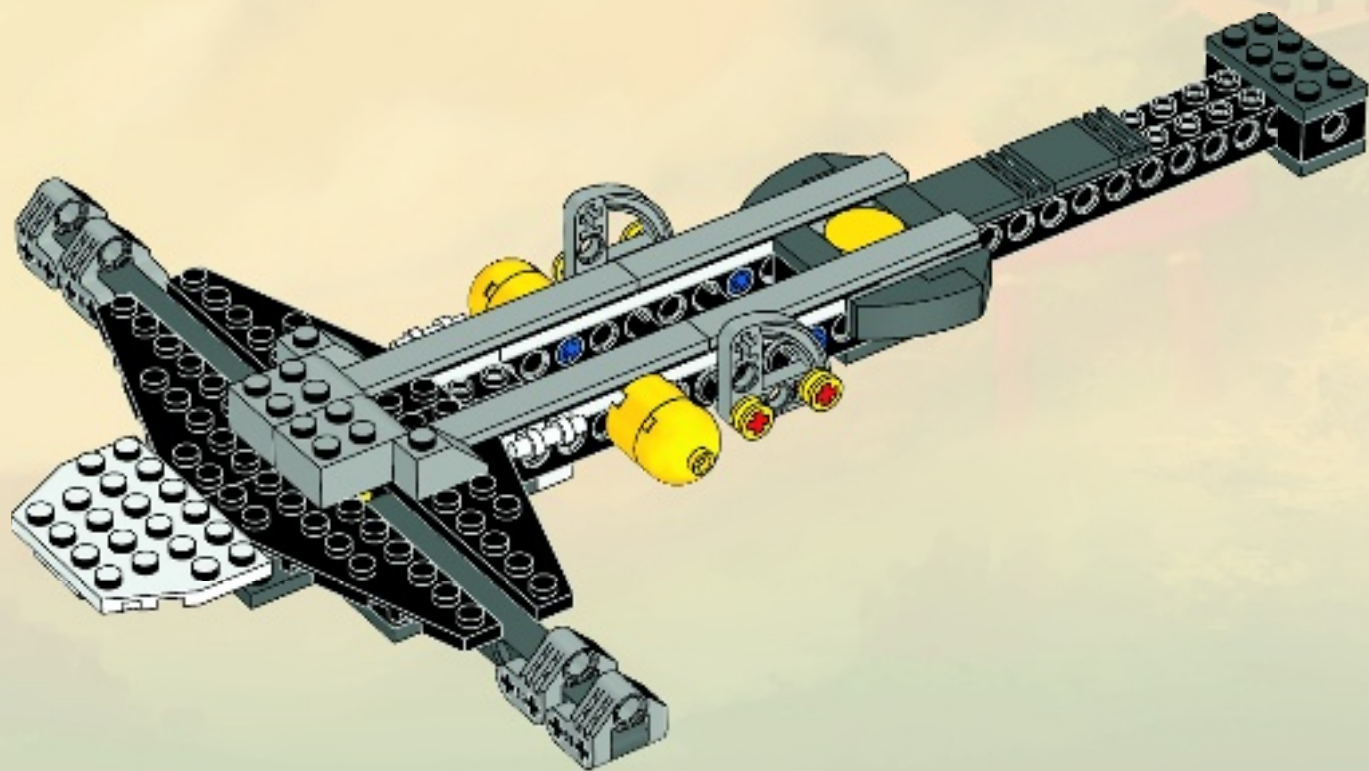

- 2x 
- 2x 
- 2x 

27

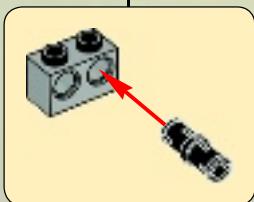
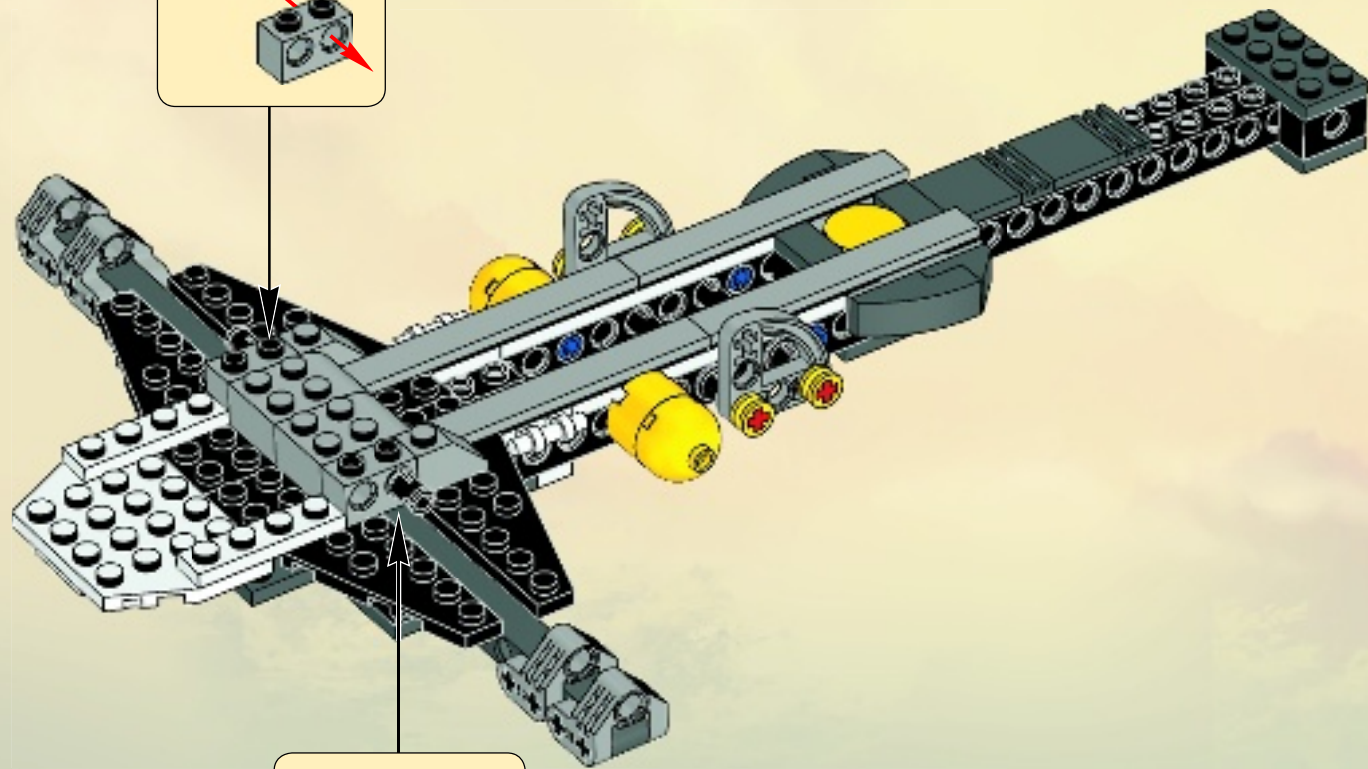
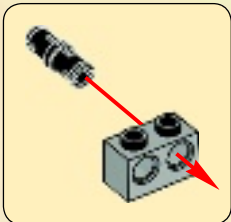



2x



1x



4x

28

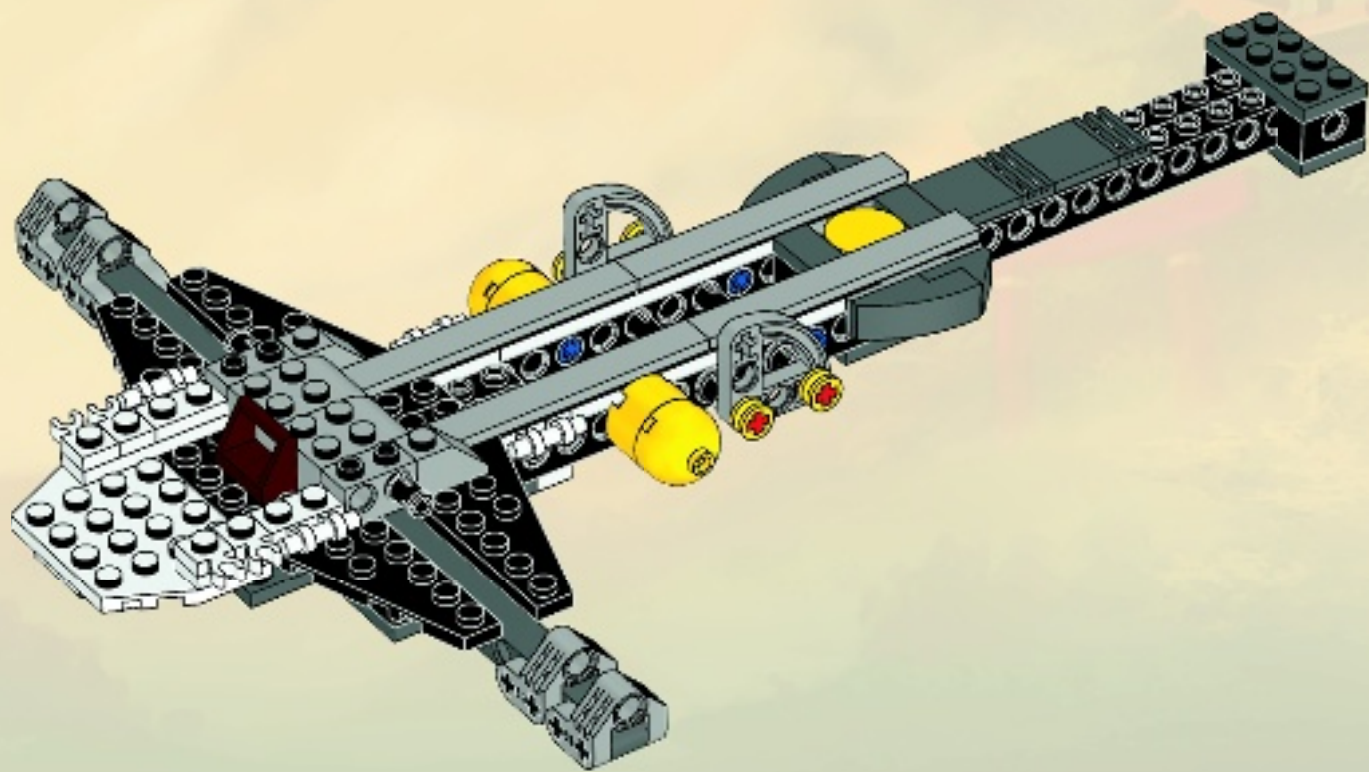



29

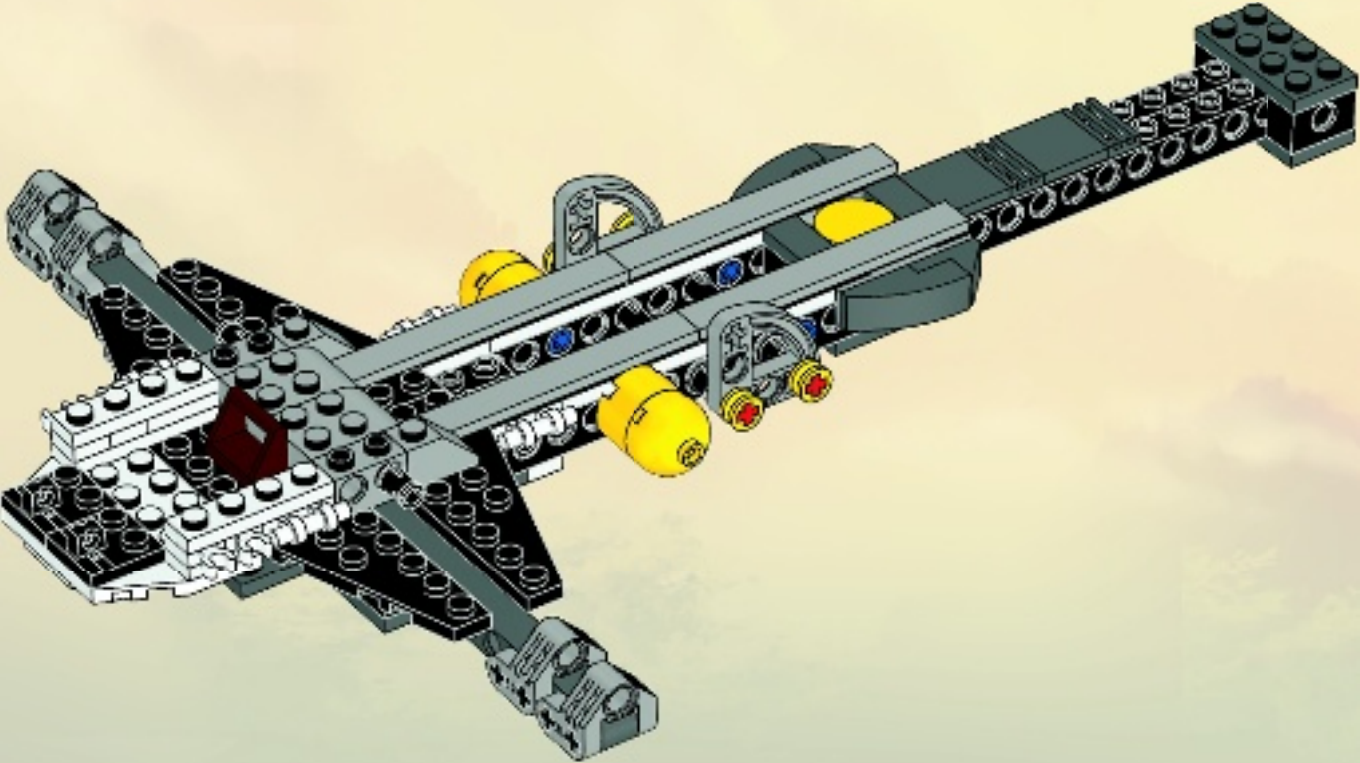



30

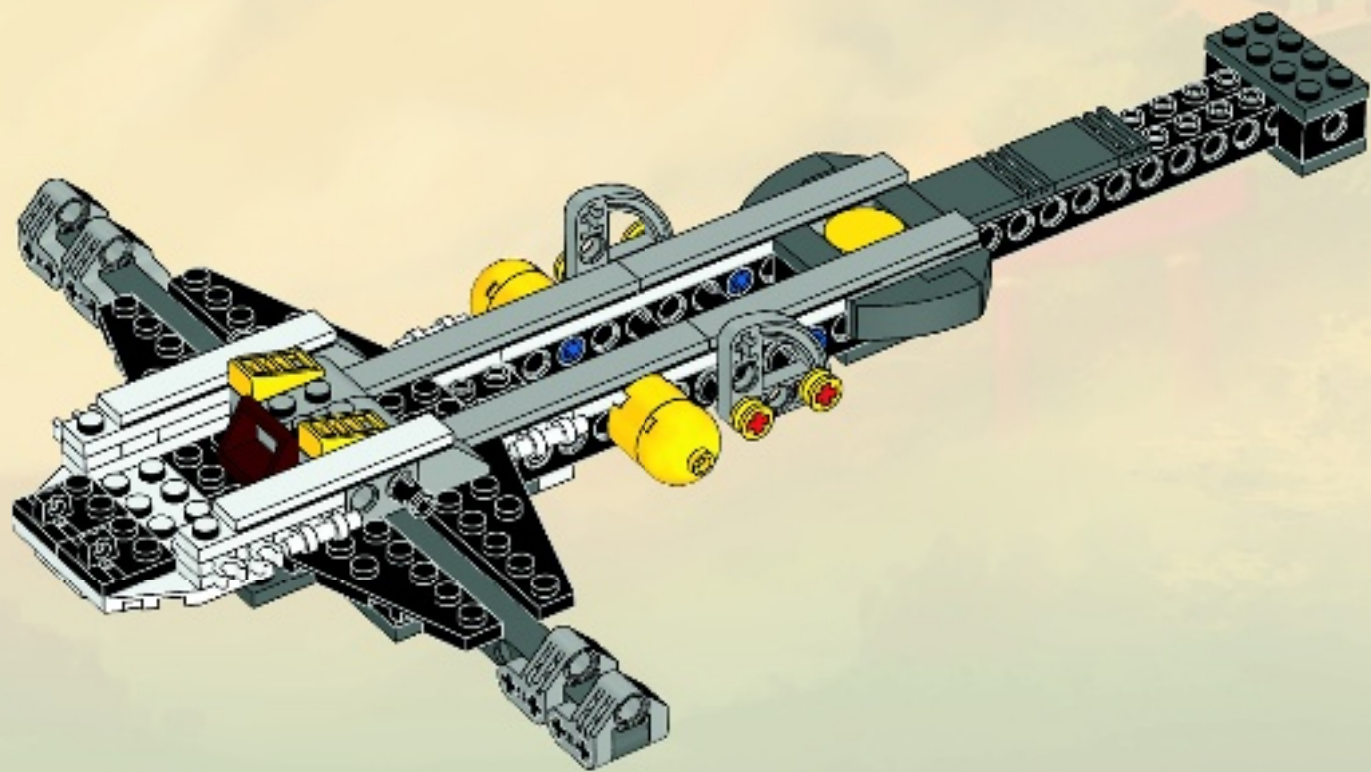



2x



4x

31

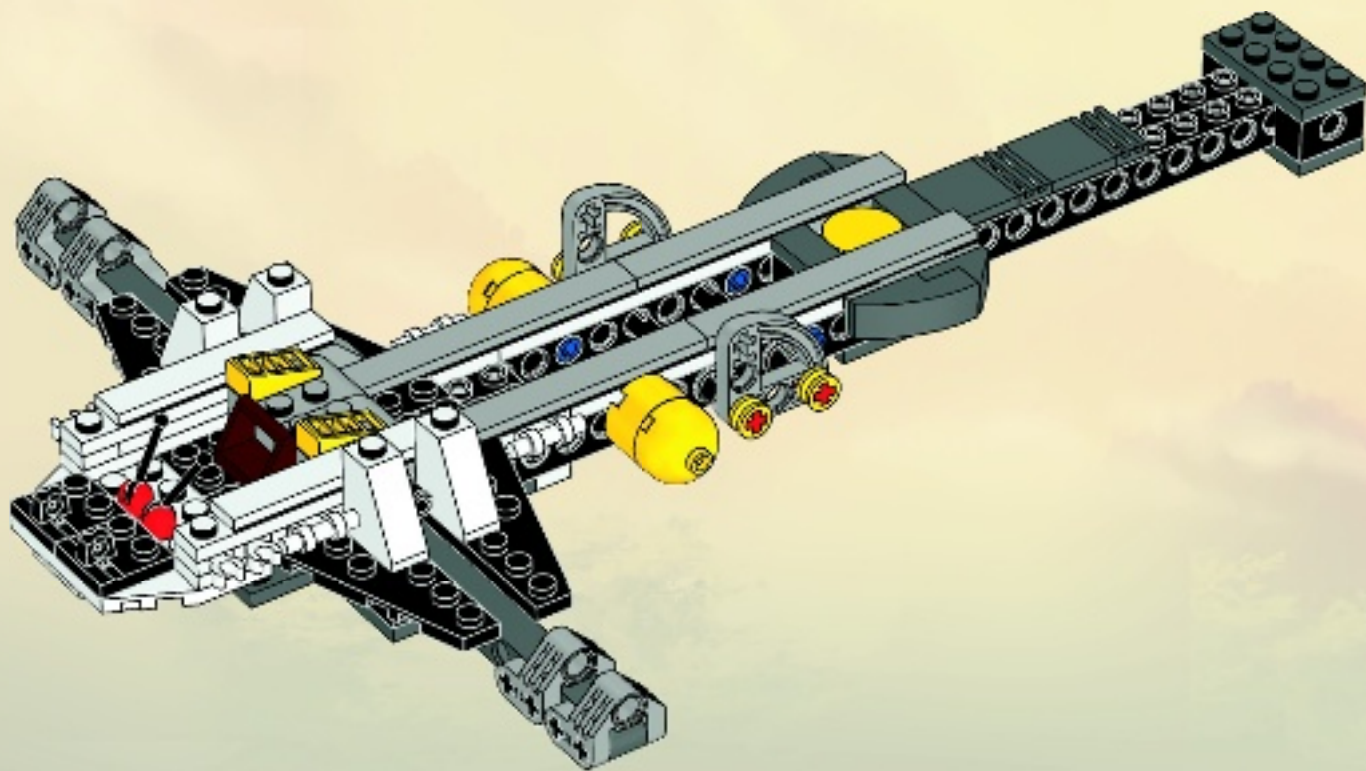



2x



2x

32

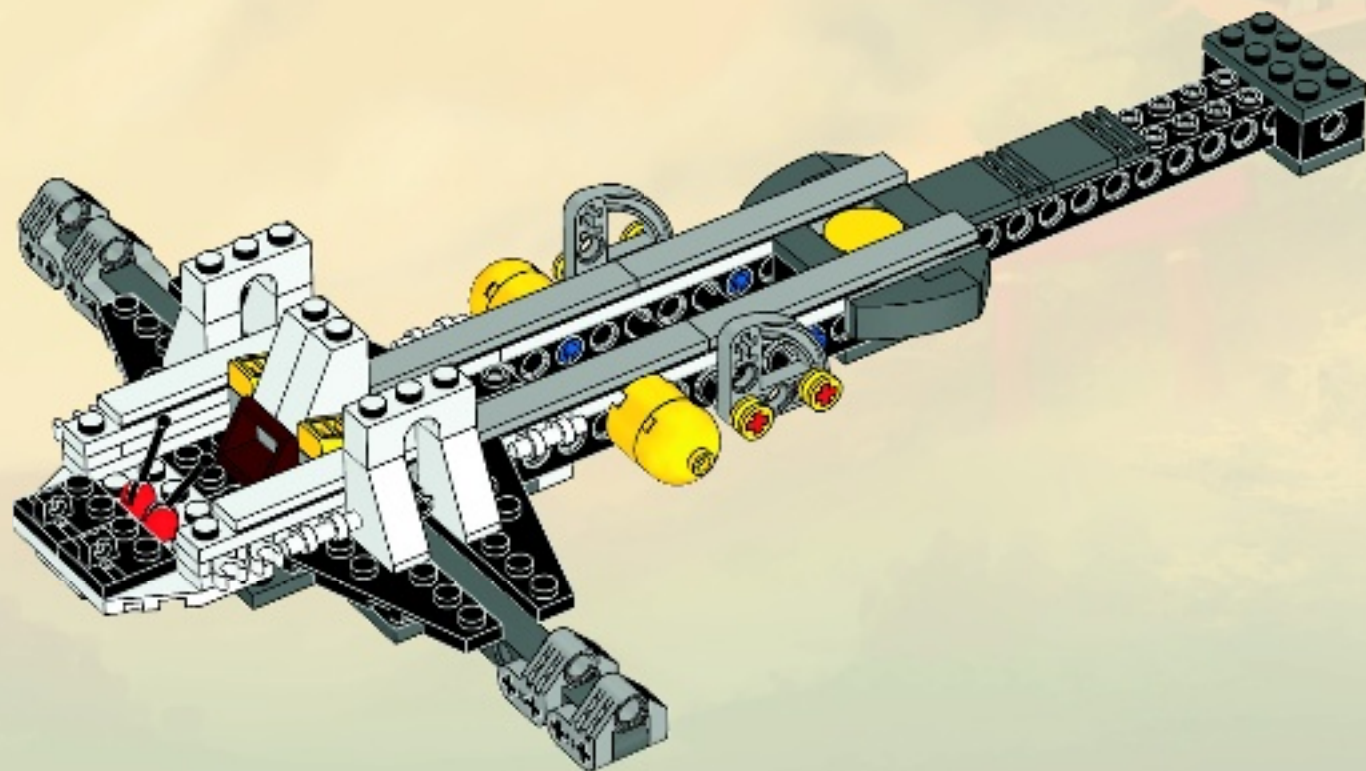

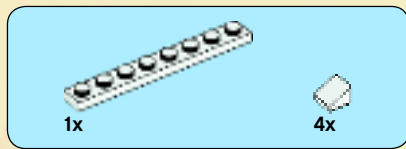

33

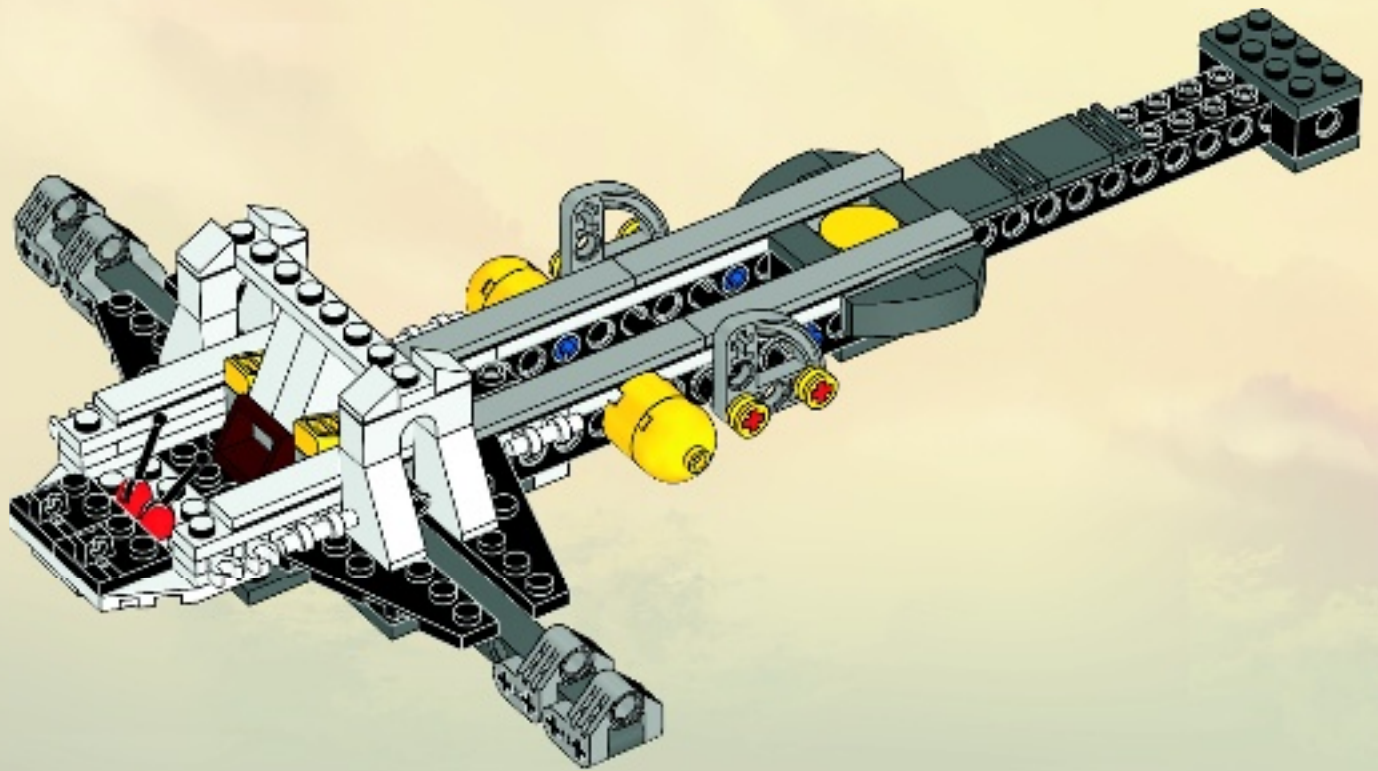



NINJAGO

Masters of Spinjitzu





NINJAGO

Masters of Spinjitzu



9573

9555

9447

9555

9447

9450
9556

9591

9557

9447

9449
9450

9556

9450

9447



9569

9449
9450

9447
9570
9572

9569

9591

9591

9450

9450

9591

9449
9574
9590
9591

9590

9450
9591

9449

9591

9450



9555



9571



9450



9574



9573



9554



9591



9570



9449
9450



9573



9447
9556
9569



9554



9448



9590



9591



9572



9447



9447



9450
9554
9570
9572
9574



9557



9571



9449



9448
9449
9557
9571



9591



9449
9550



9450

LEGO

NINJAGO

Masters of Spinjitzu



LLOYD ZX
9574 • 9450



NRG ZANE
9590



NRG KAI
9591



NRG JAY
9570



NRG COLE
9572



CHOKUN
9591 • 9450



MEZMO
9555



FANGDAM
9571



SPITTA
9569 • 9449



PYTHOR
9449



SLITHRAA
9573



LIZARU
9557



BYTAR
9556 • 9448



2x



2x

34

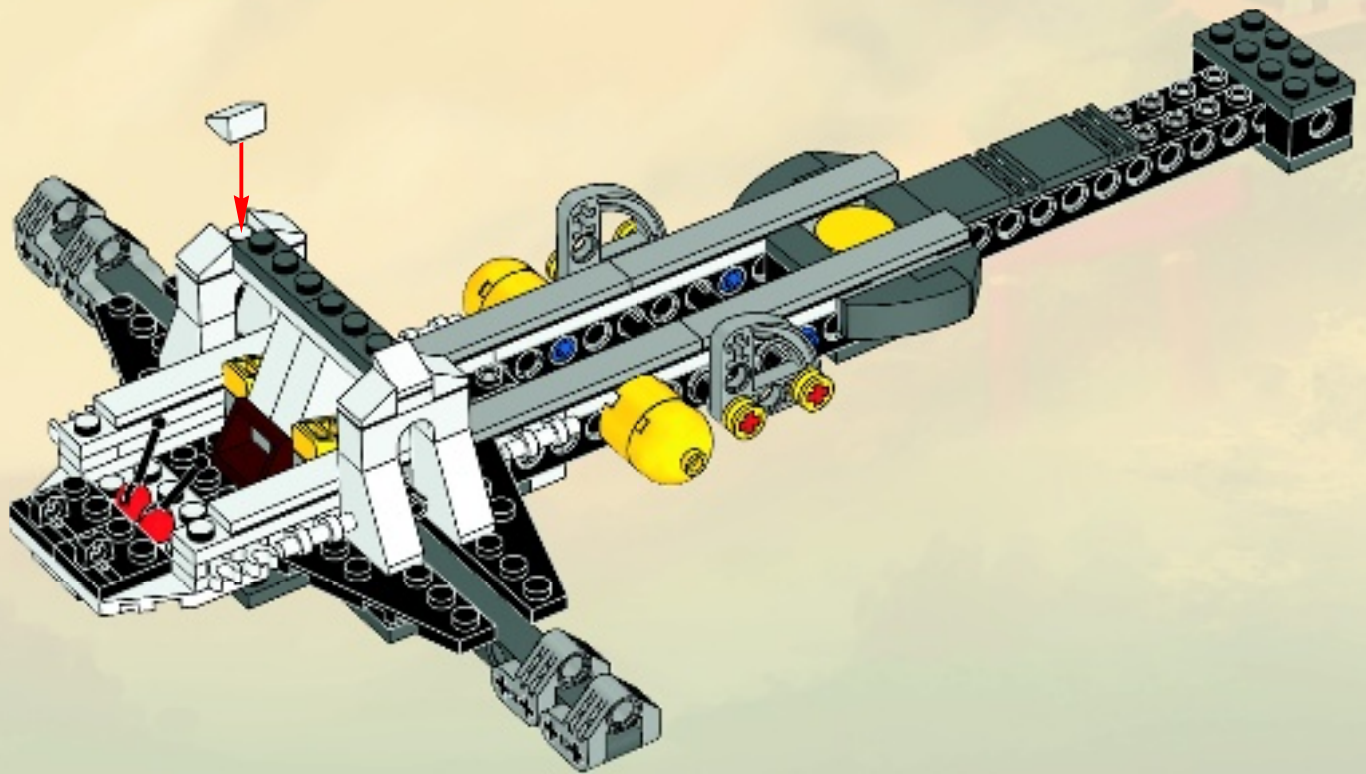

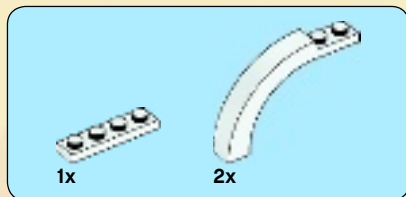

35

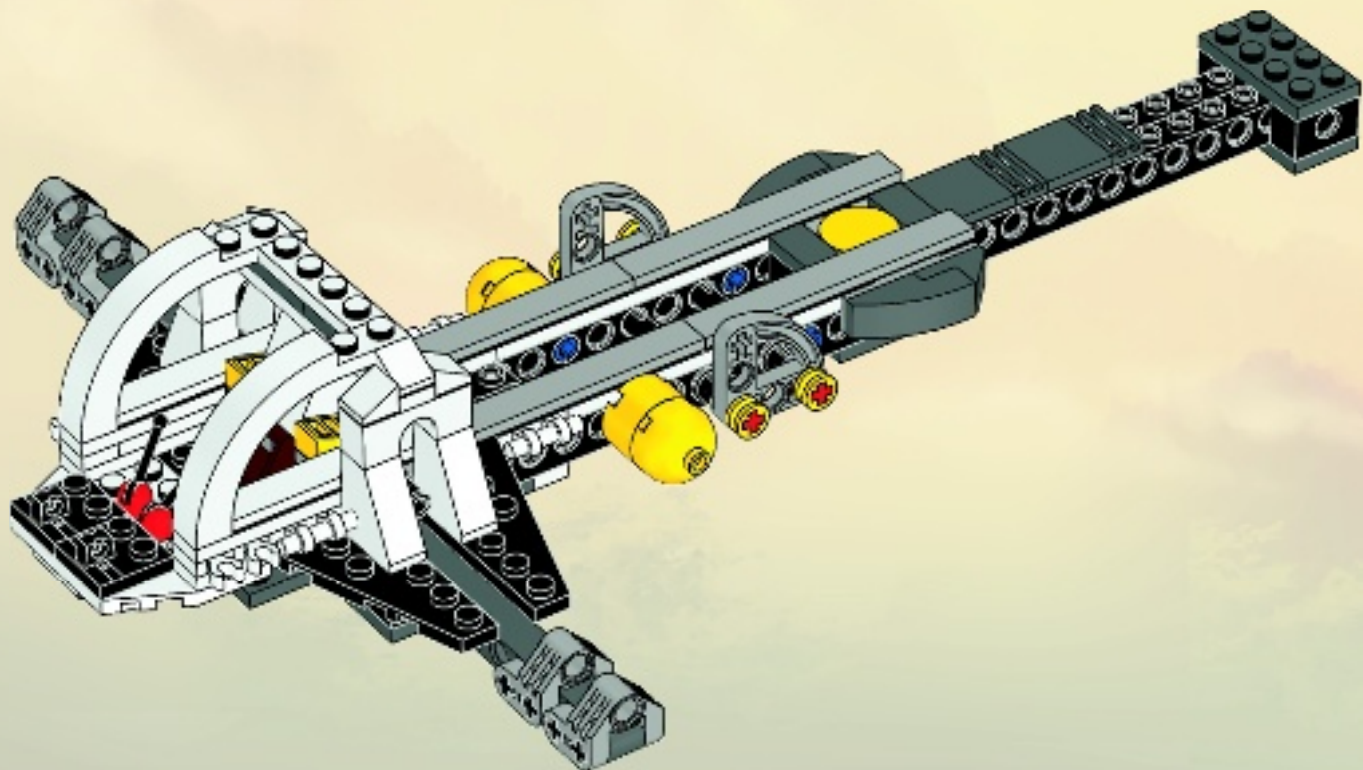

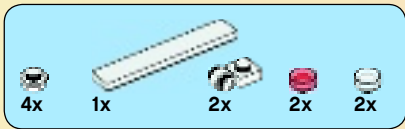

36

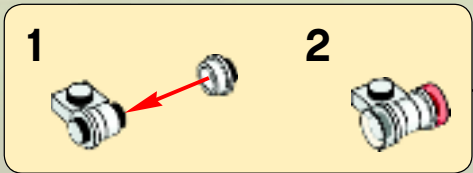
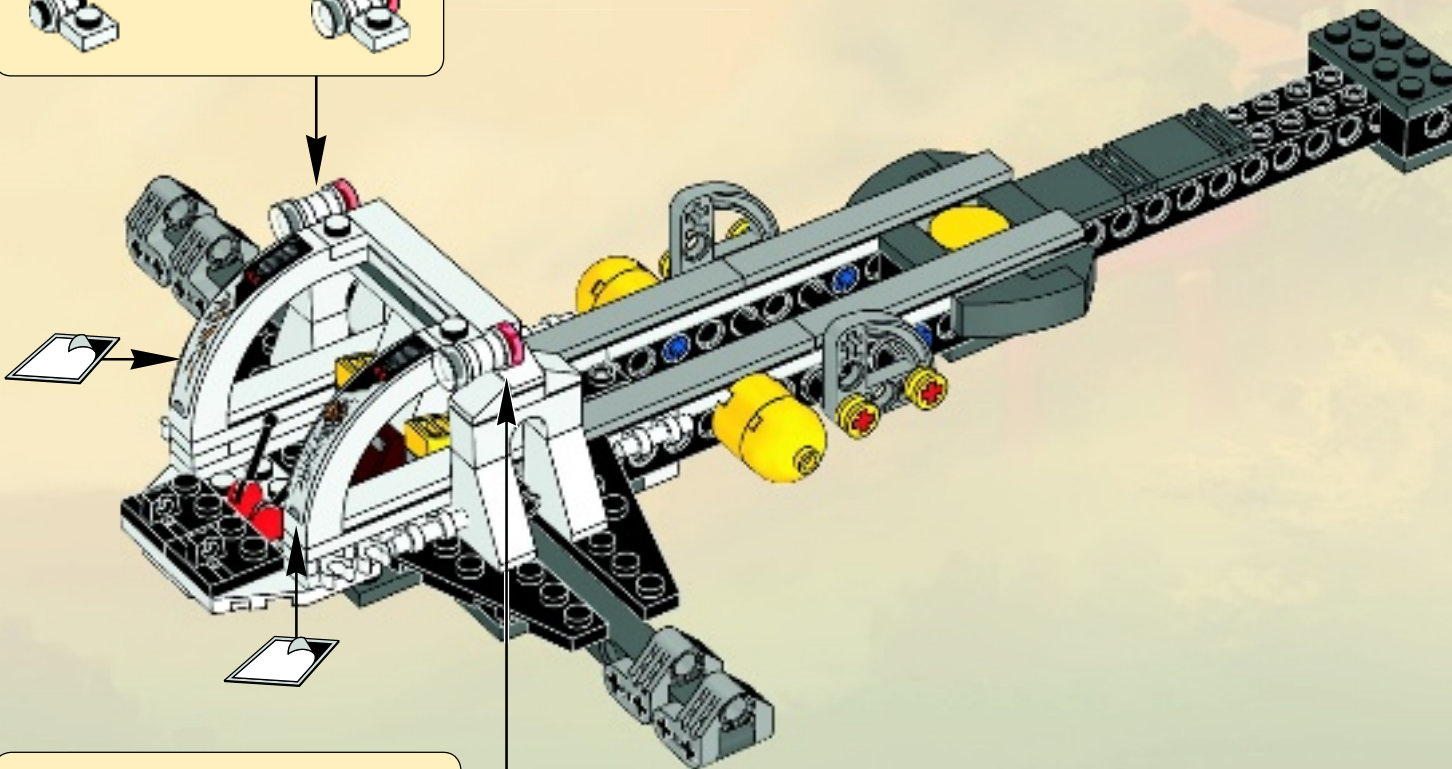
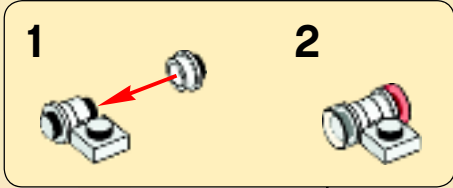

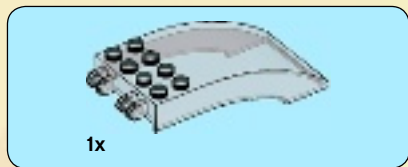

37

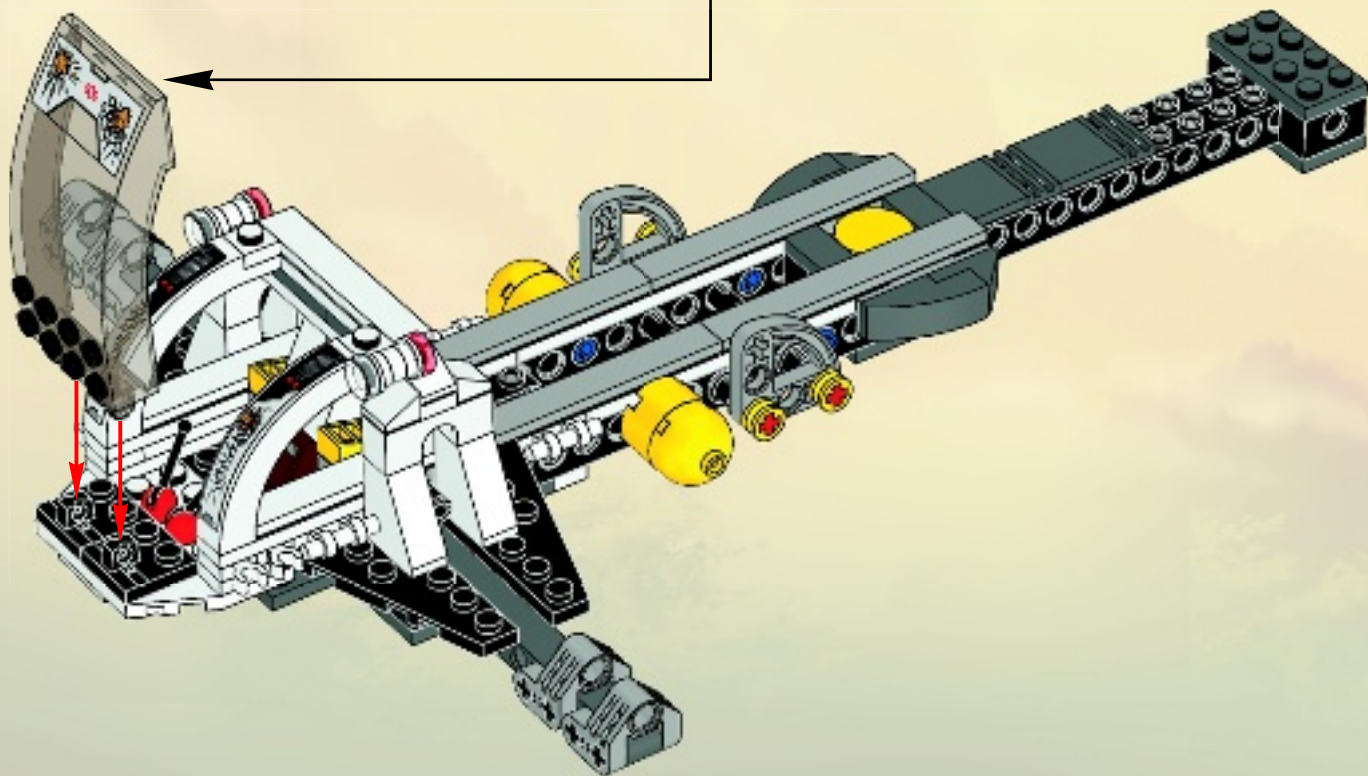
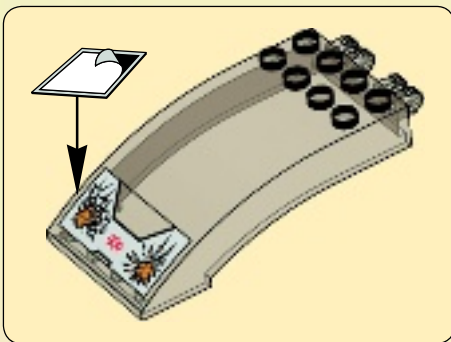
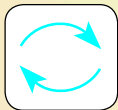

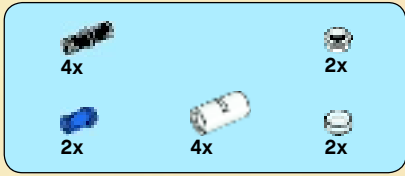

38

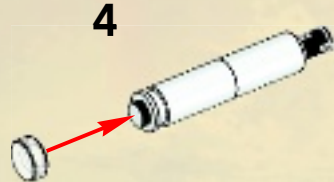
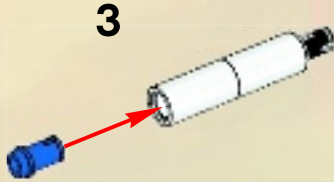
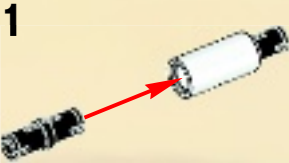

2x

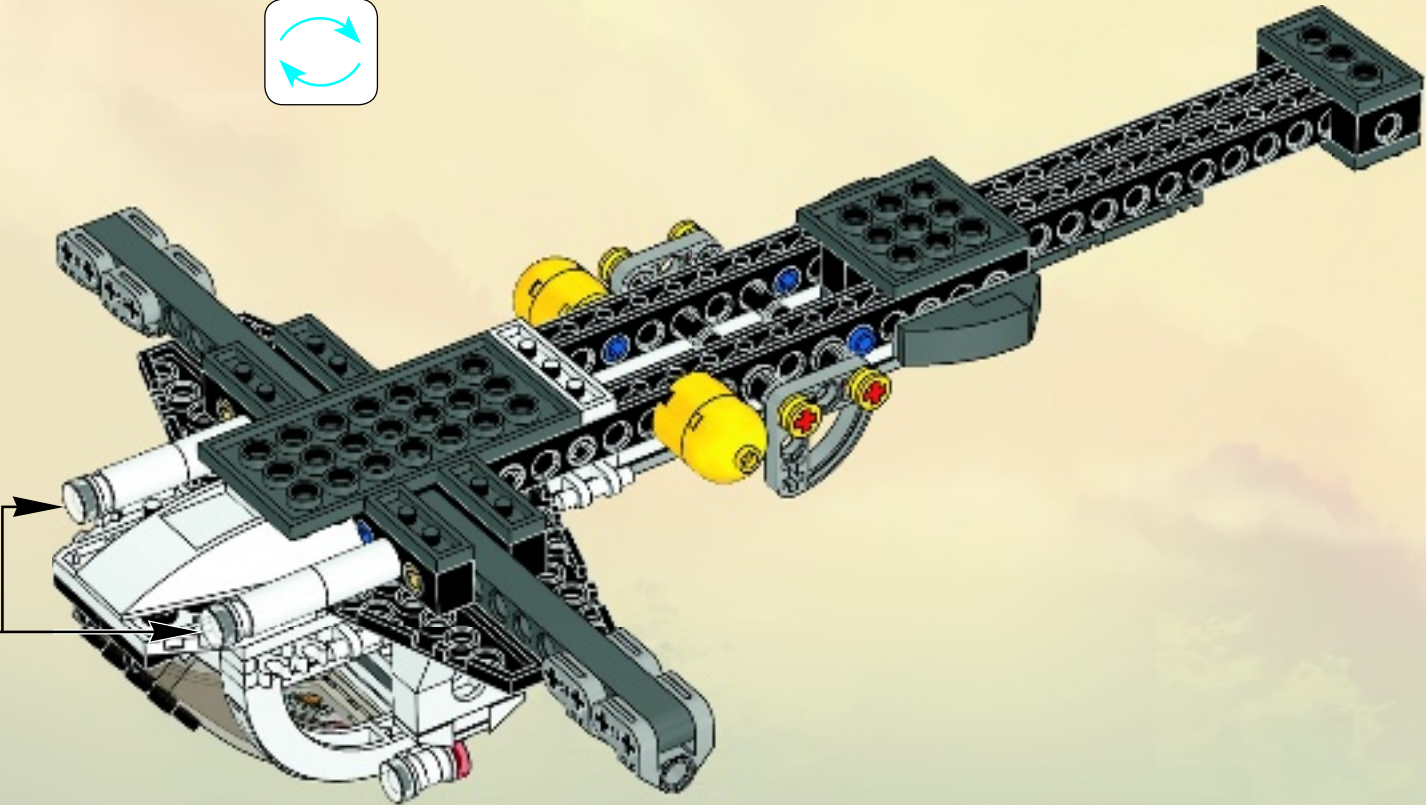
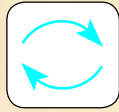

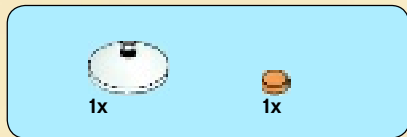
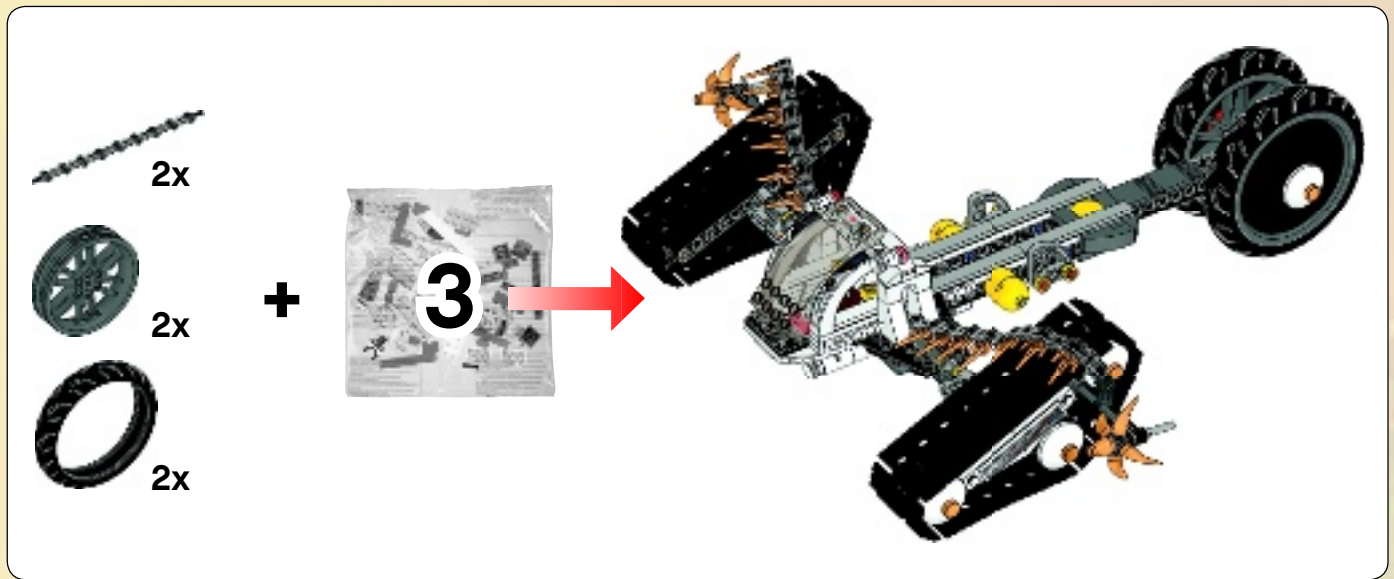

1



2



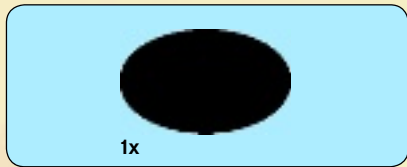

3

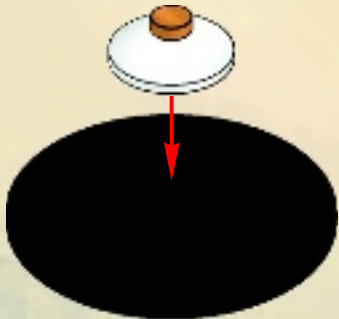

4

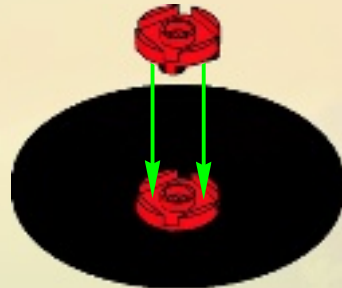
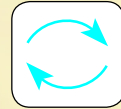

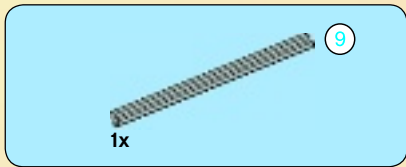

5

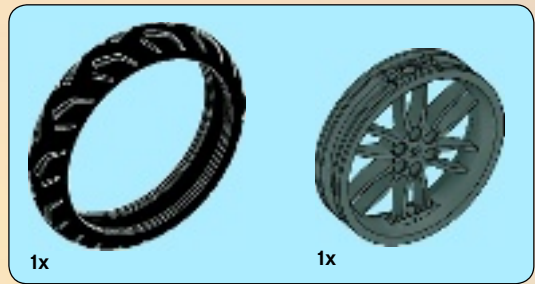
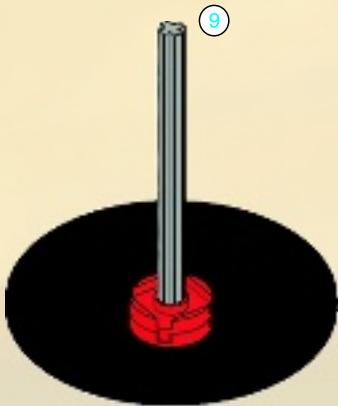
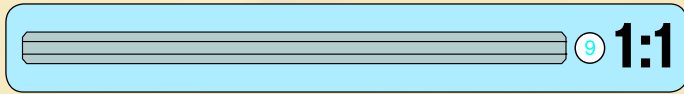

6



39

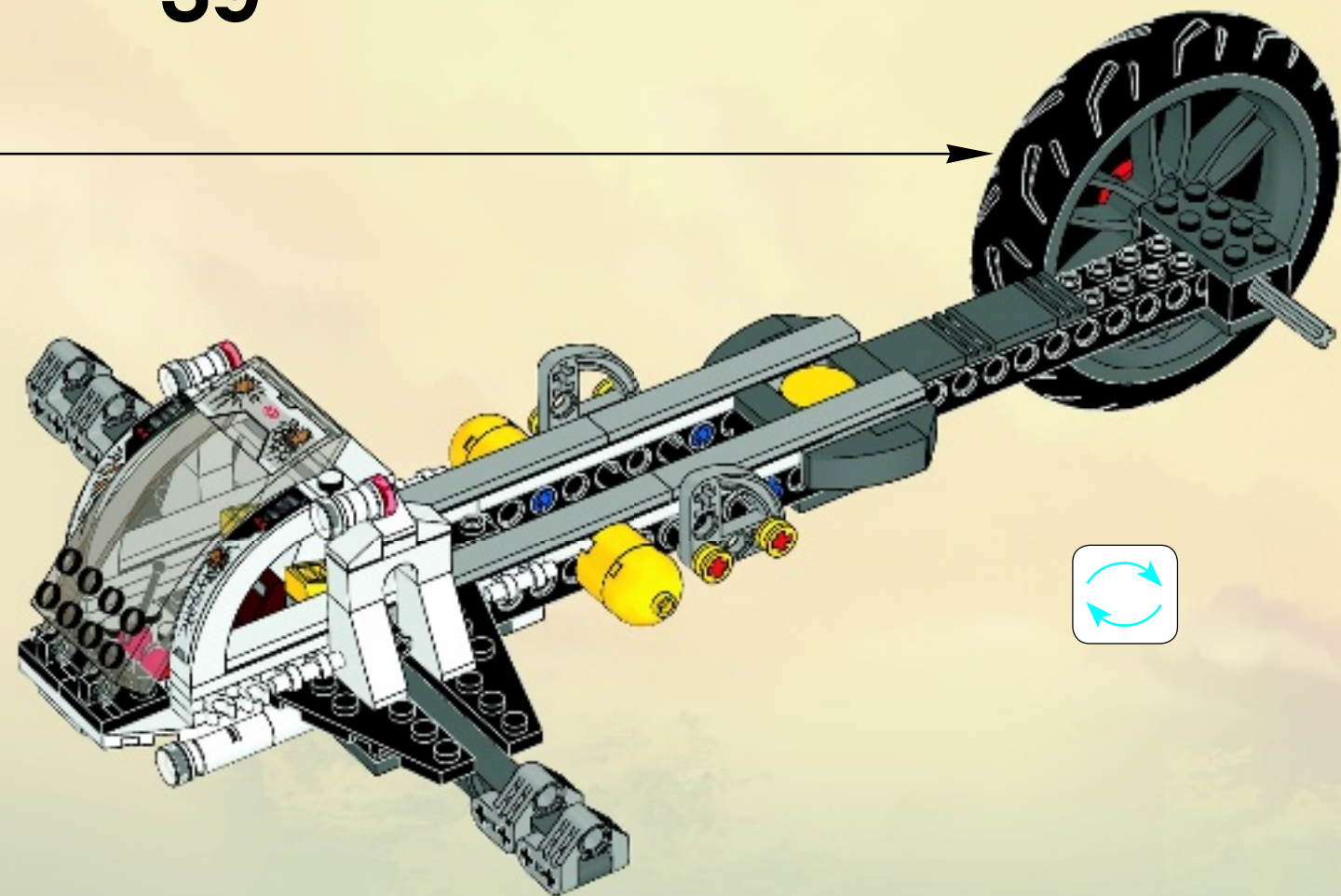

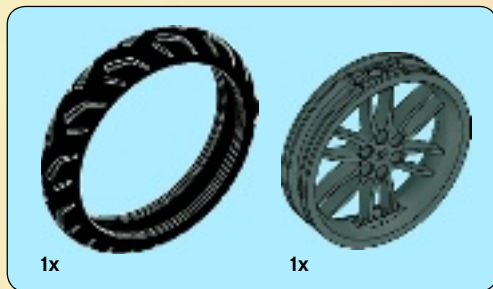

40

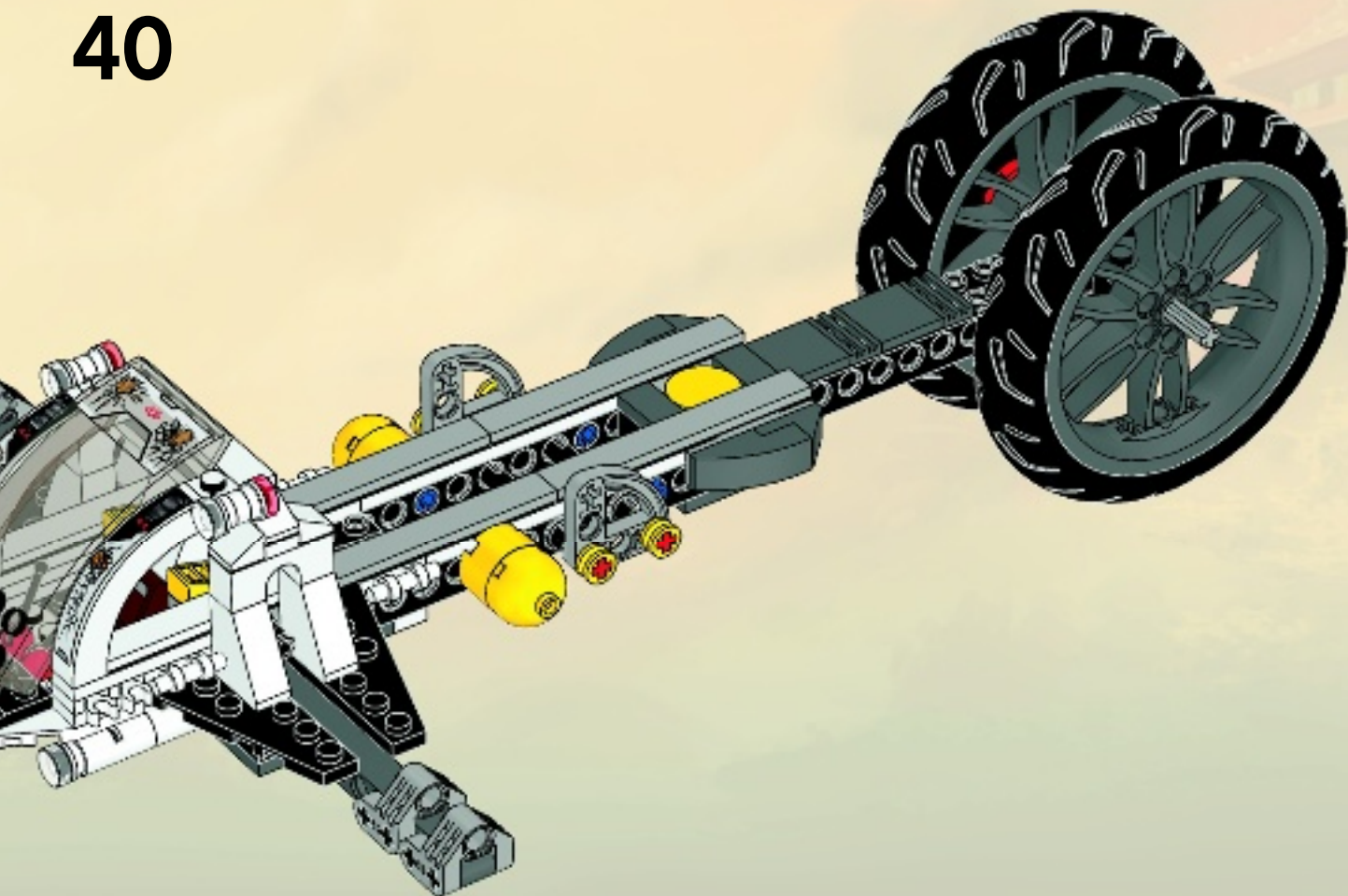

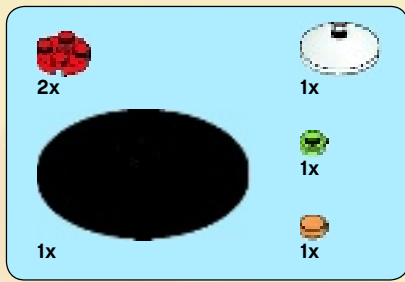

41

1



2



3

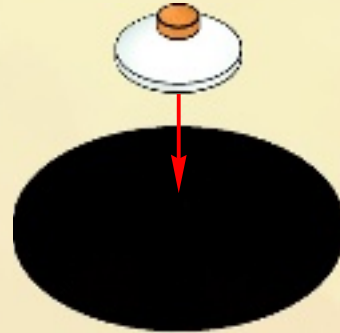

4

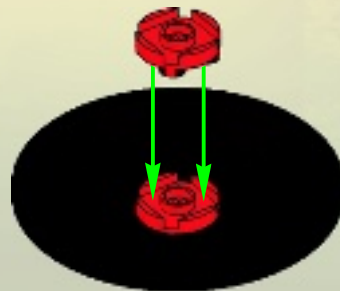
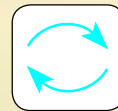

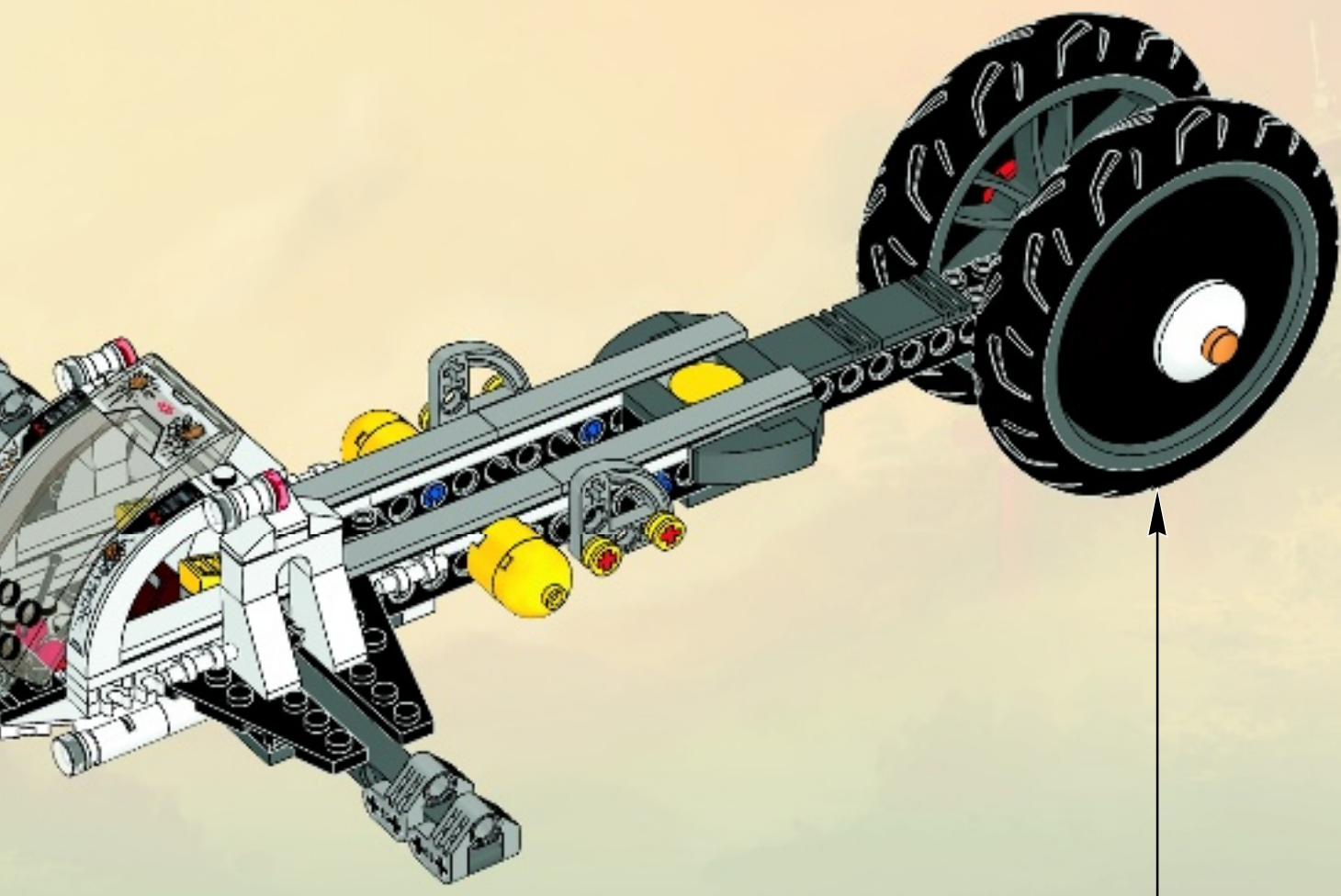

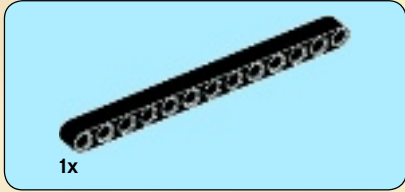
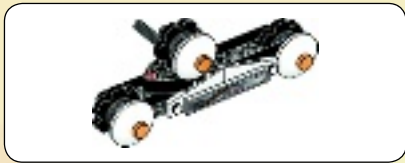

1x

1

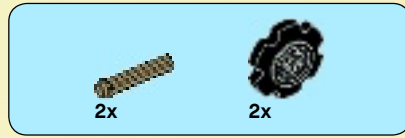

2





2x

3

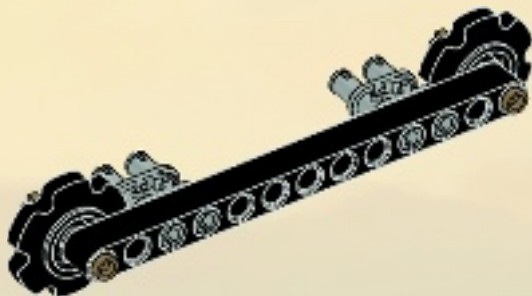

4x

4

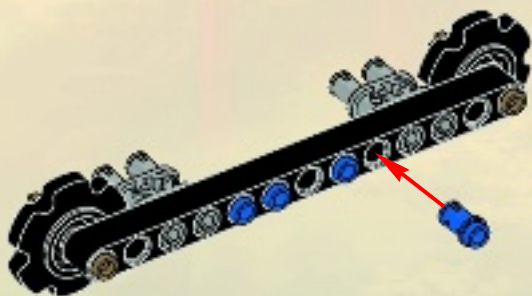

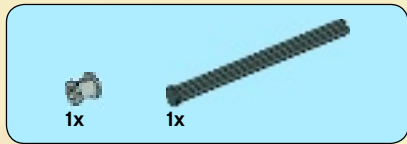

5

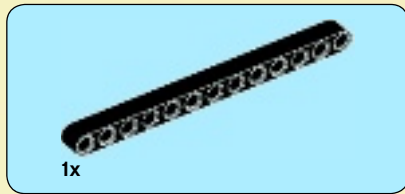
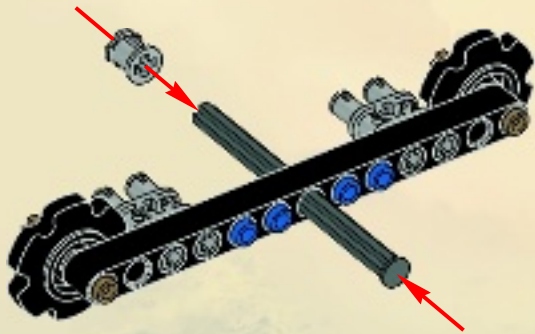

6



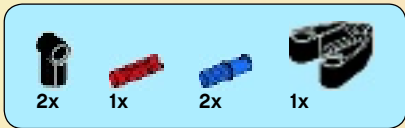

7

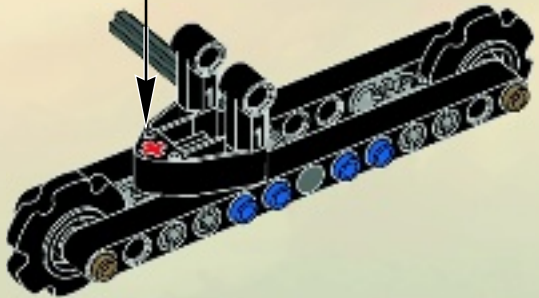
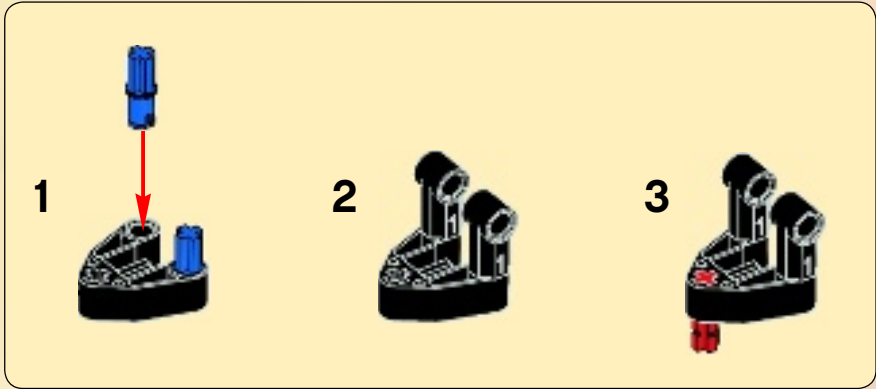



8

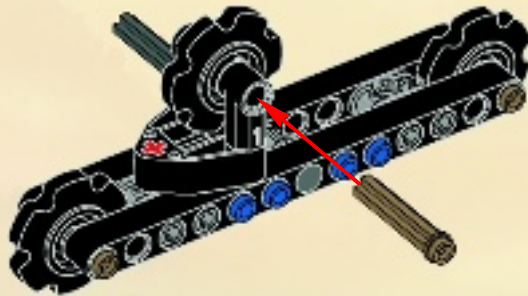

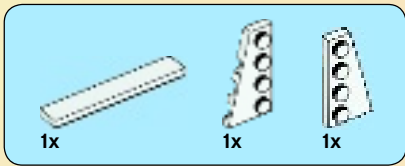

9

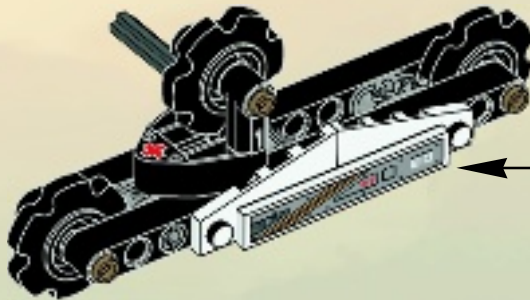
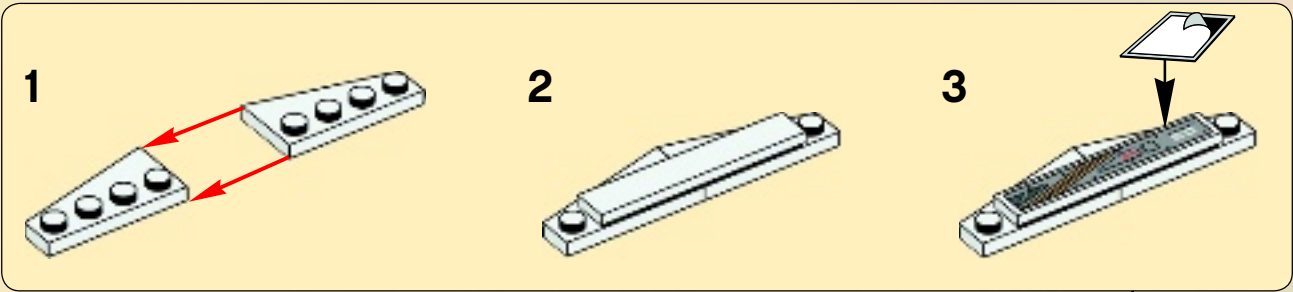

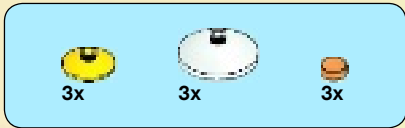

10

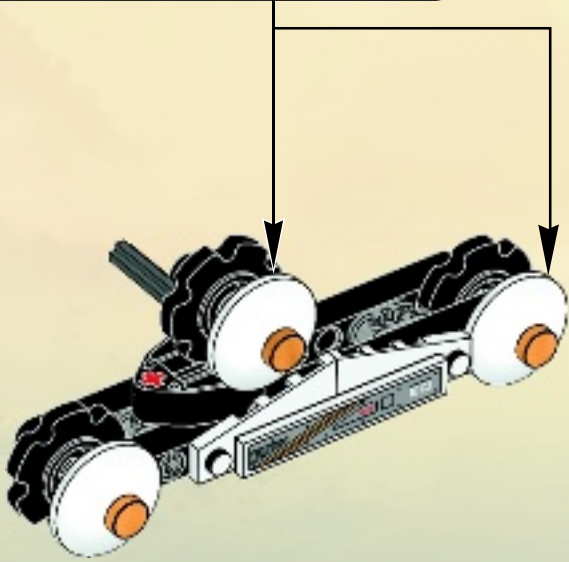
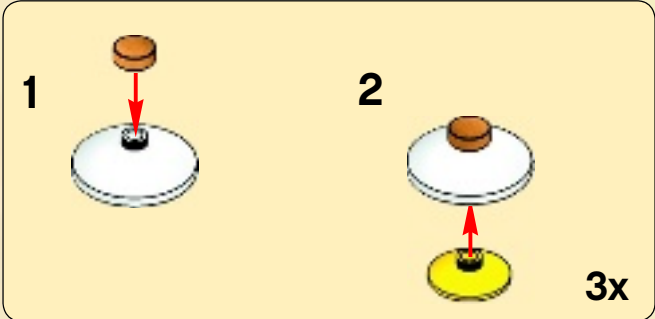

11

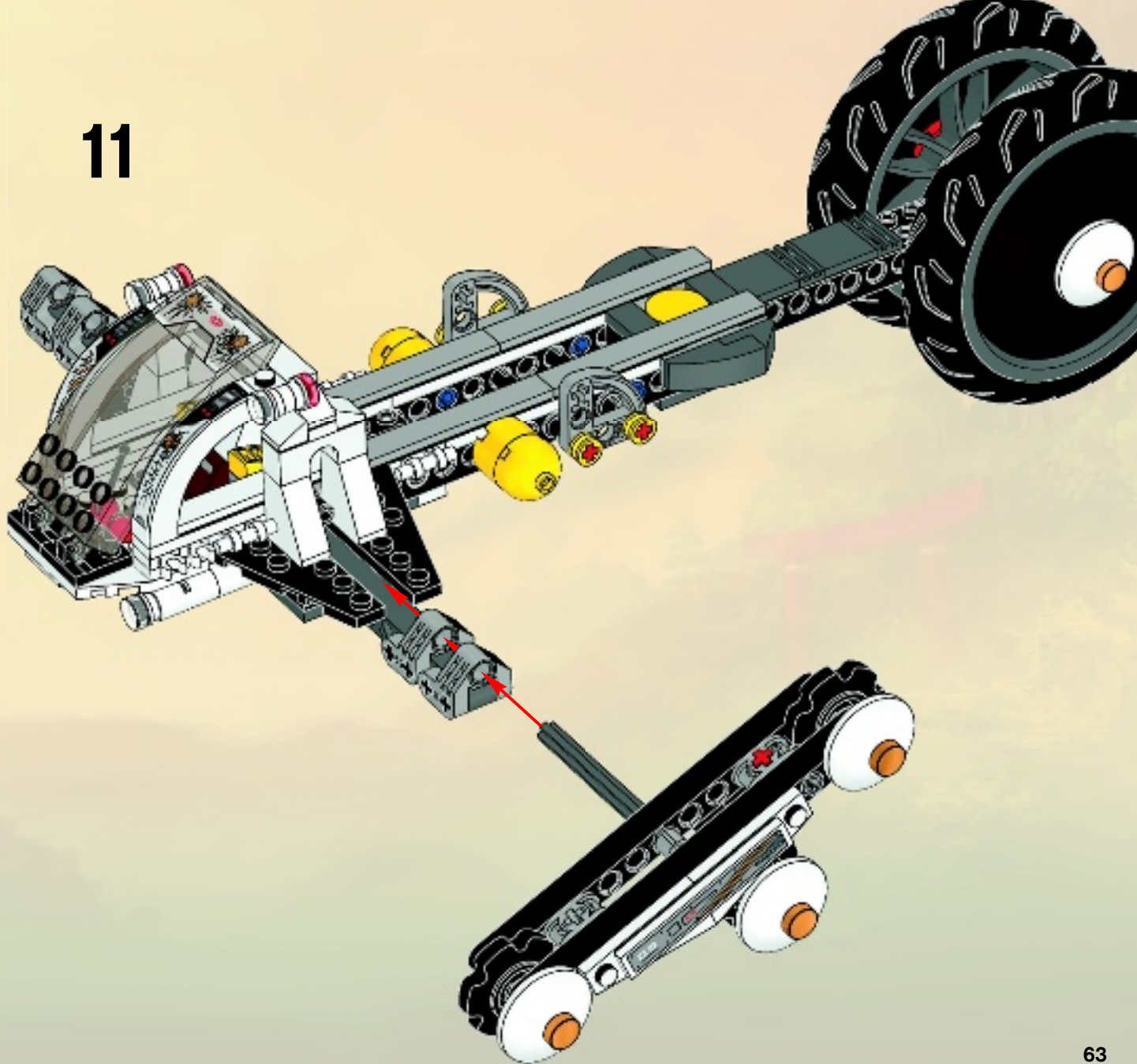



1x



2x

12

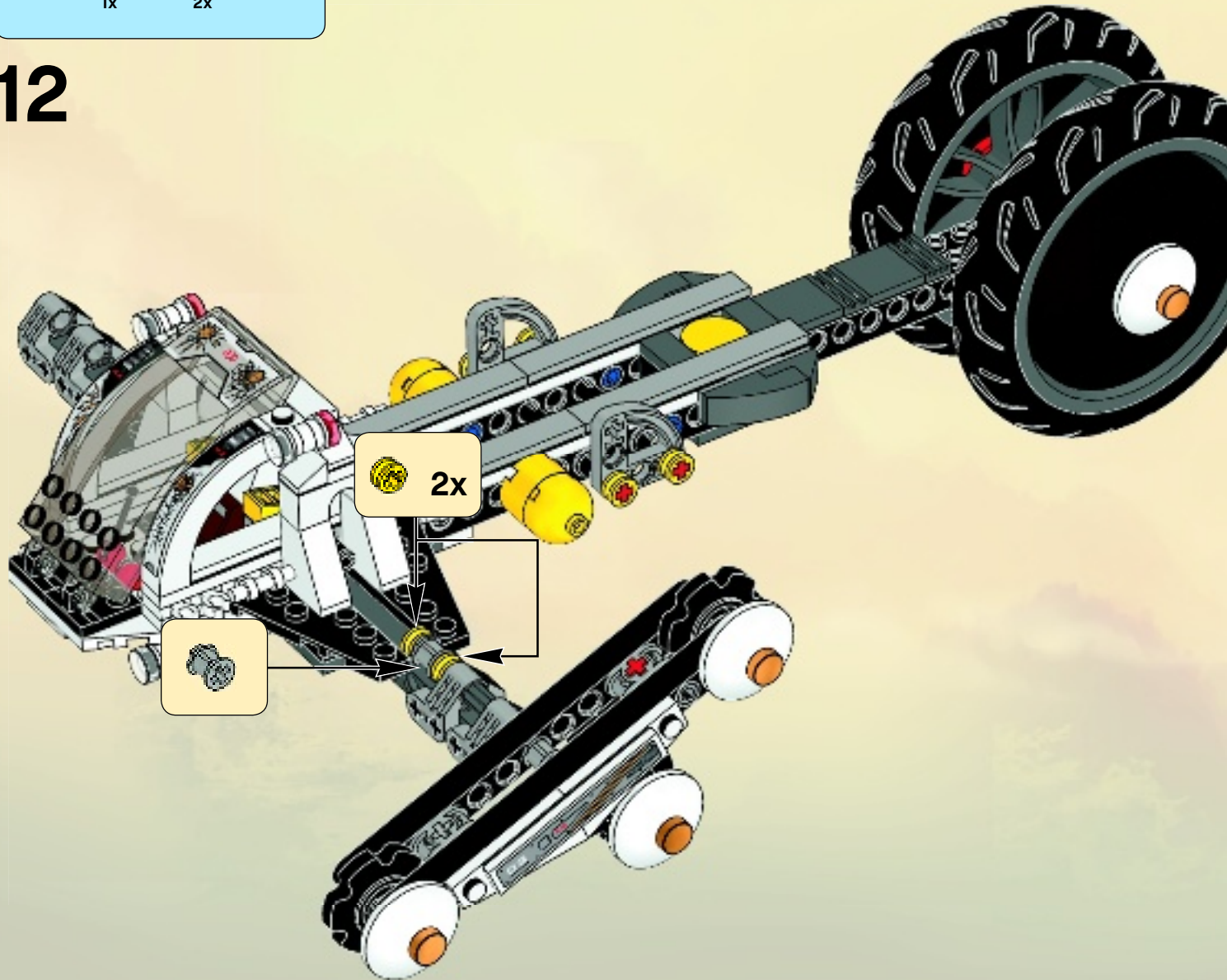

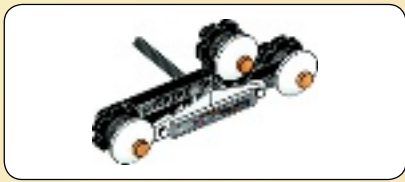

1



2

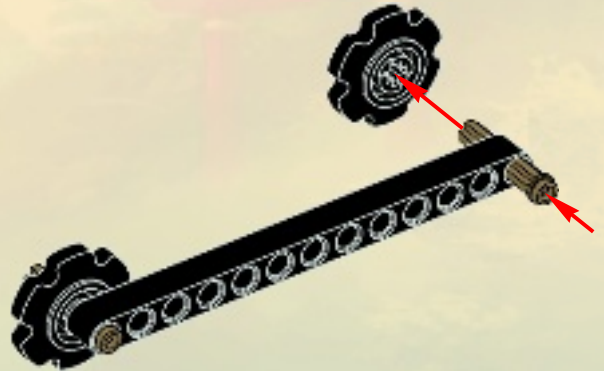



2x

3



4x

4

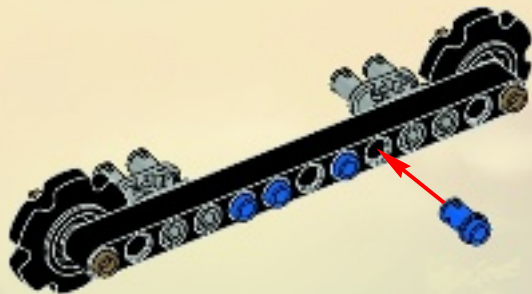

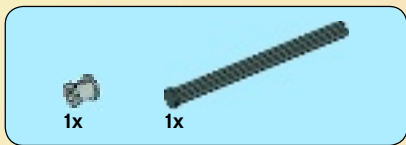

5

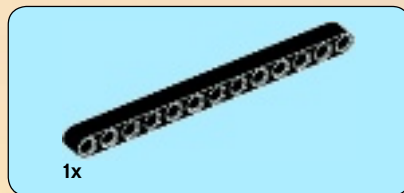
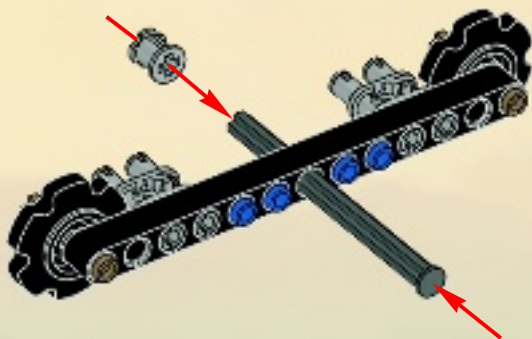

6





7

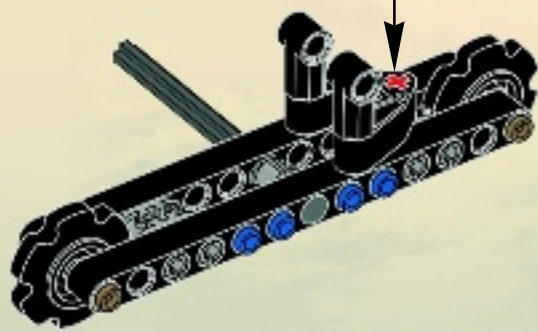
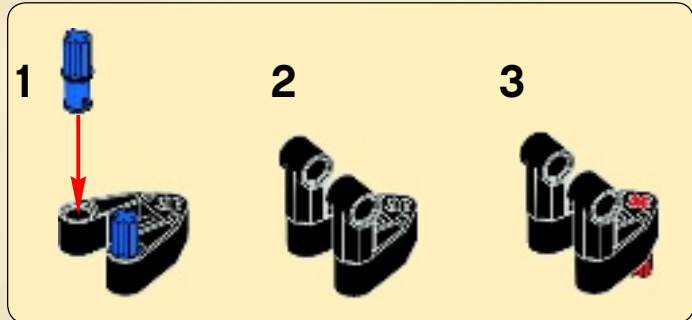

8

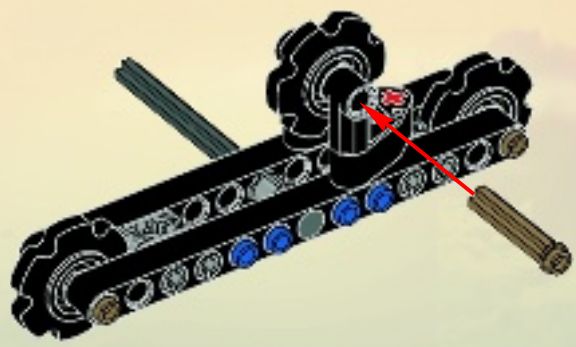

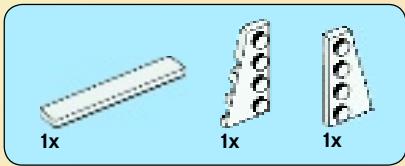

9

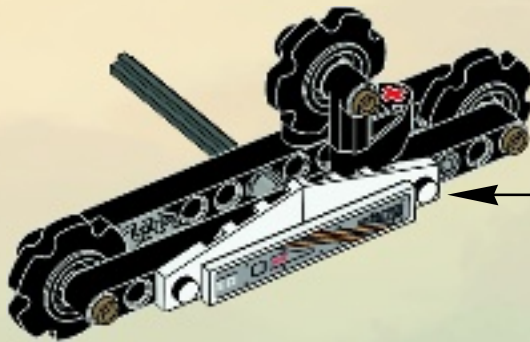
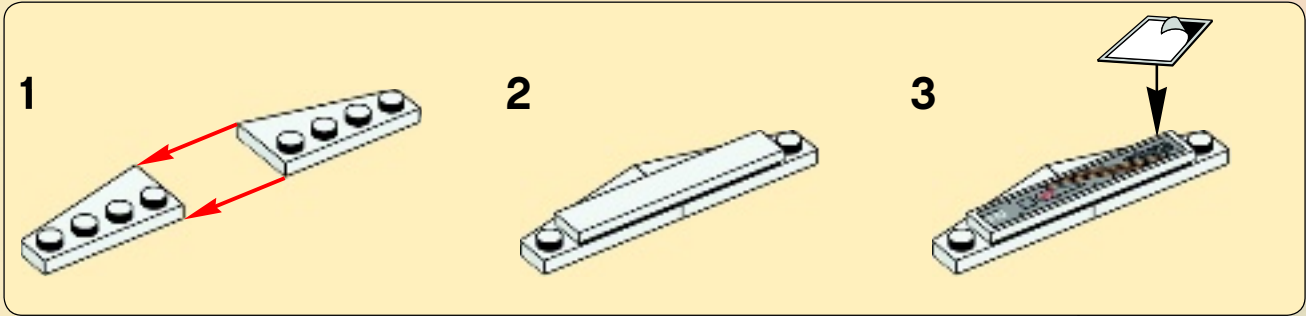

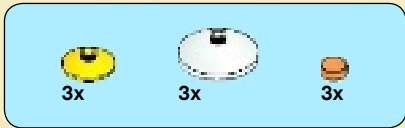

10

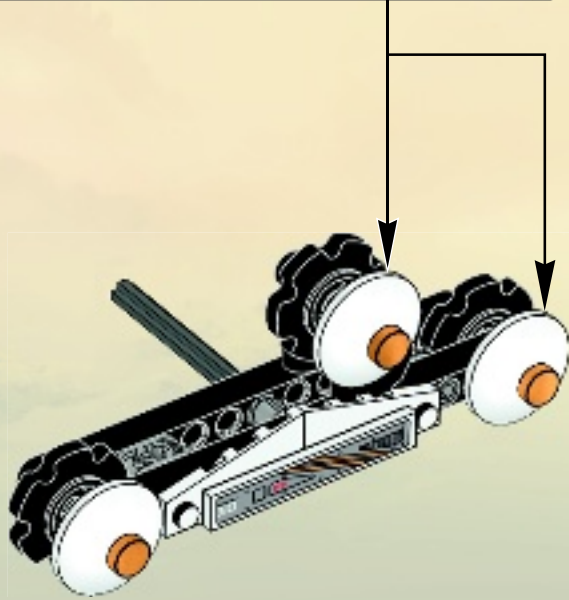
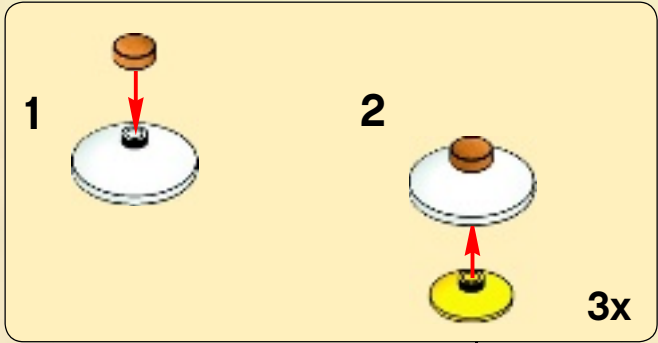

11

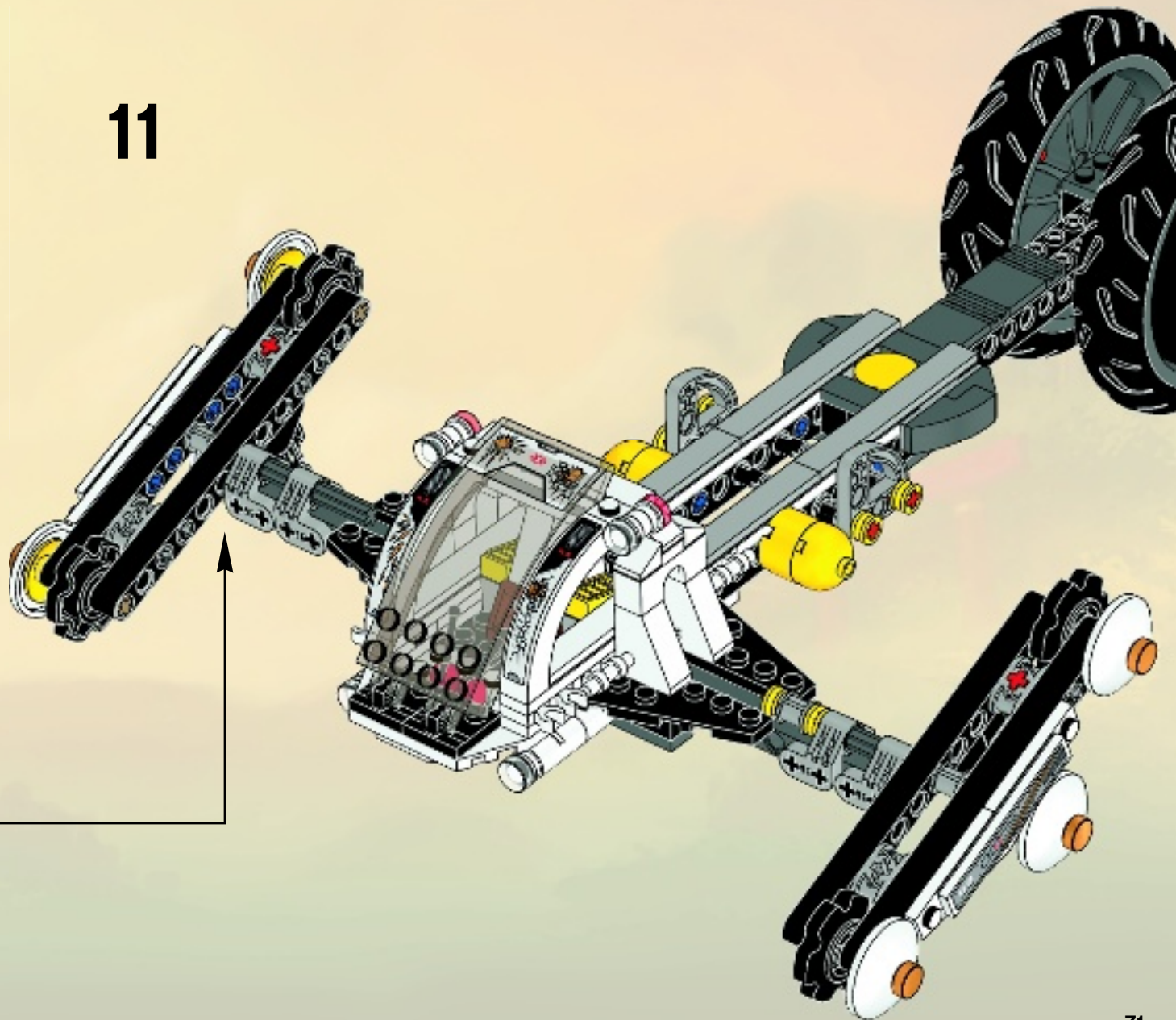



1x



2x

12

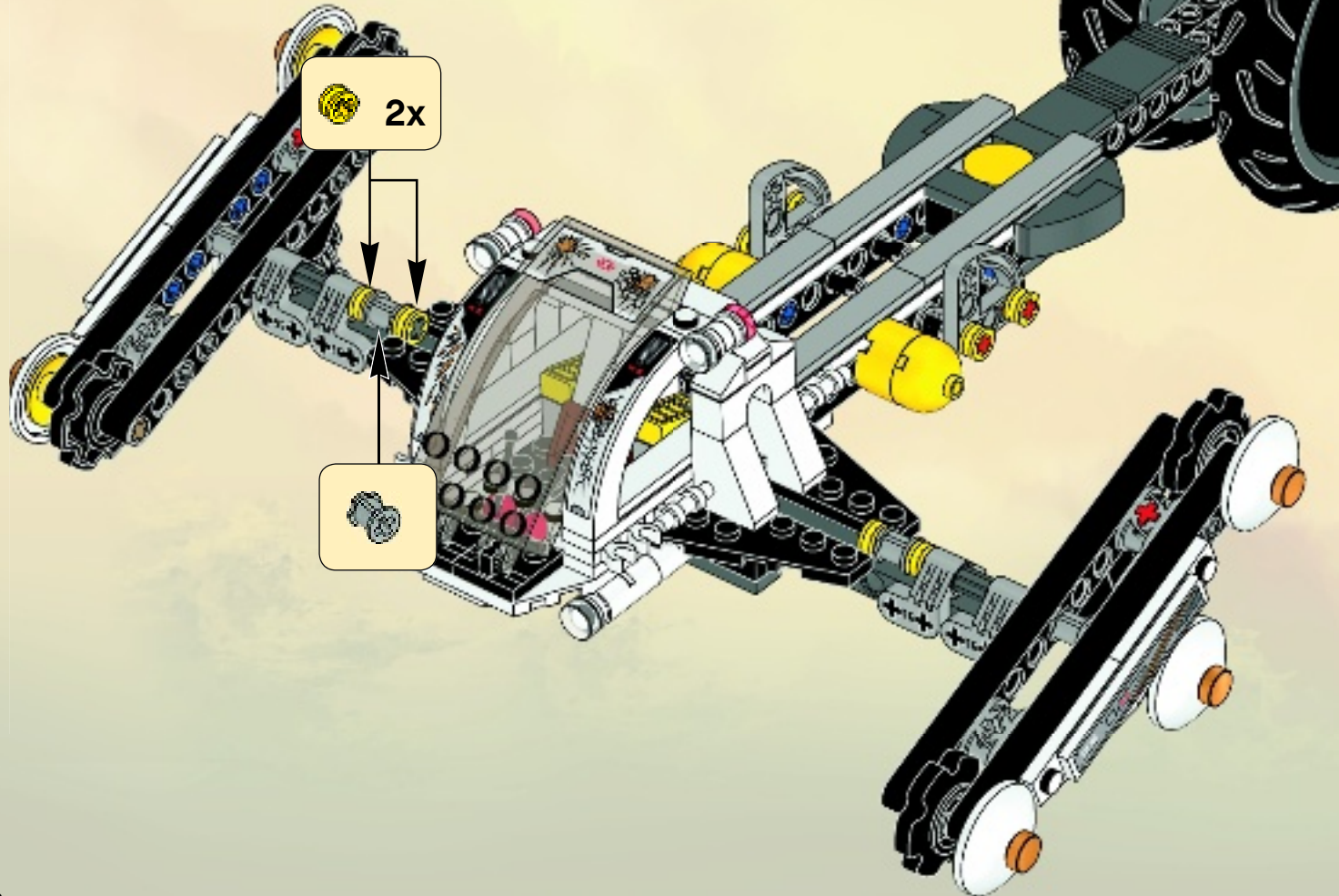

2x



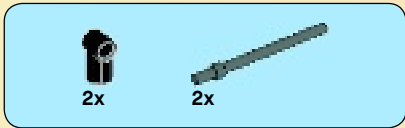

13

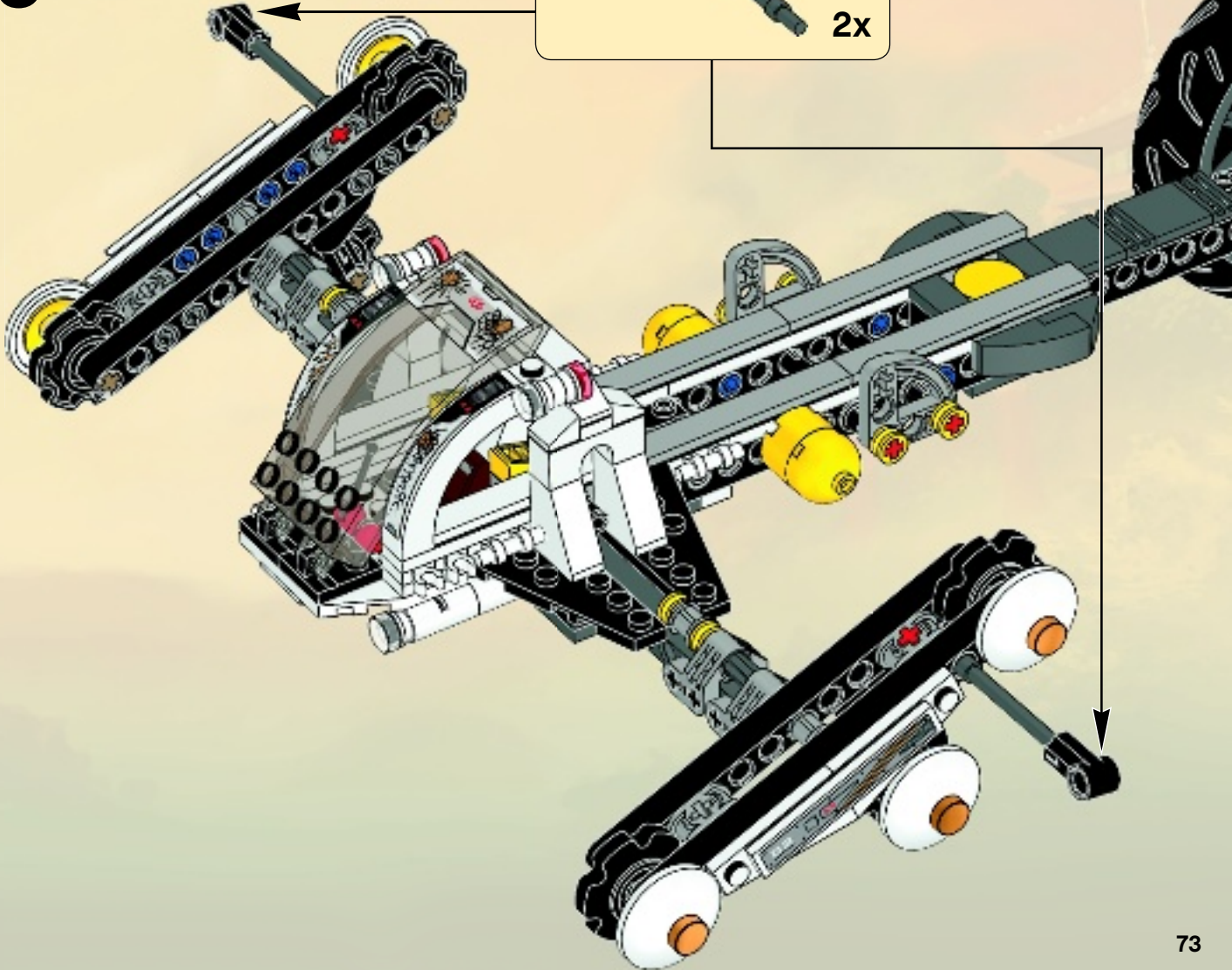
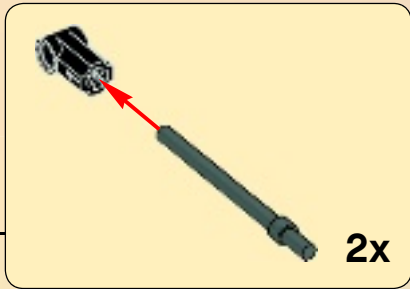



46x

14



23x

2x

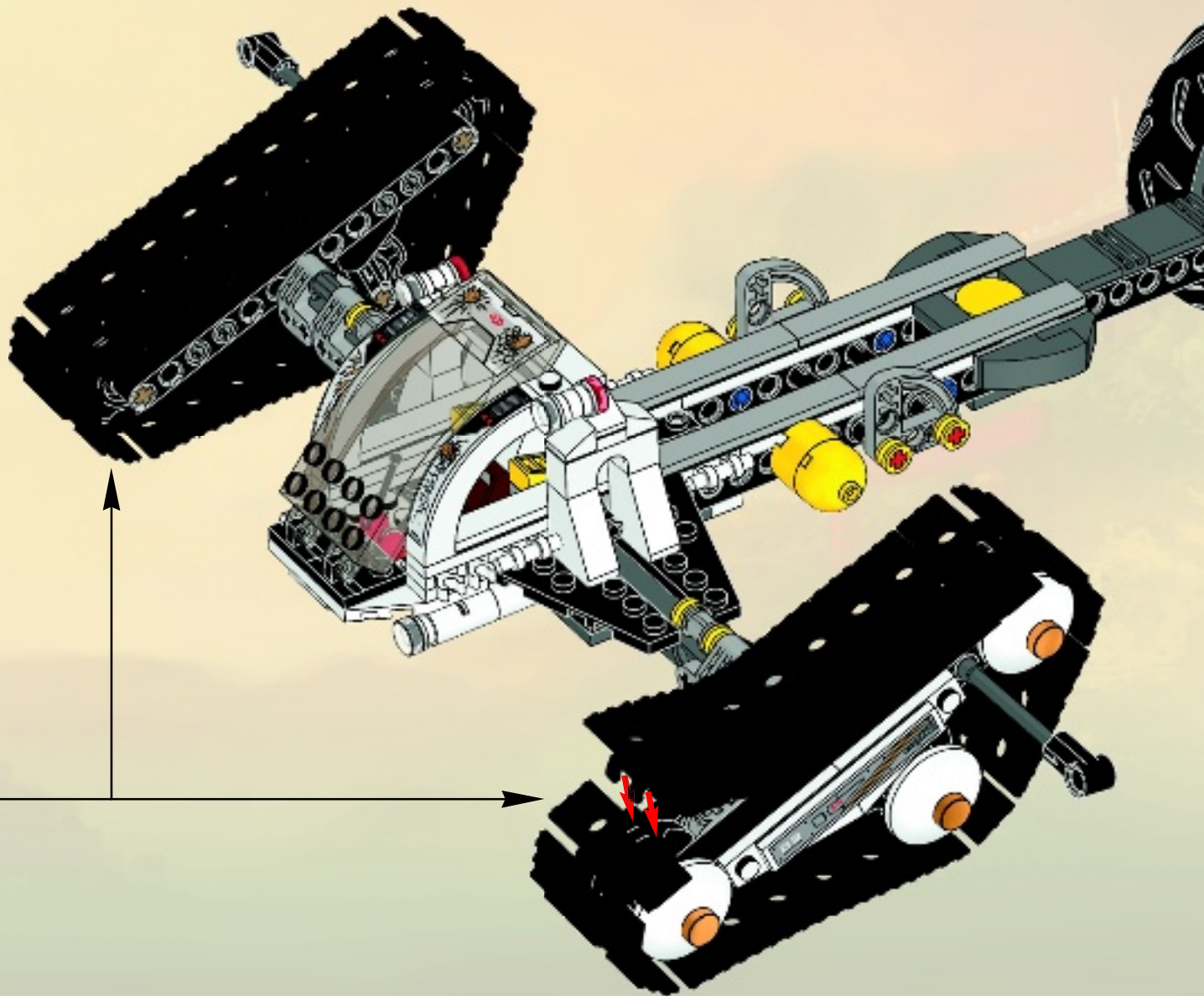



15



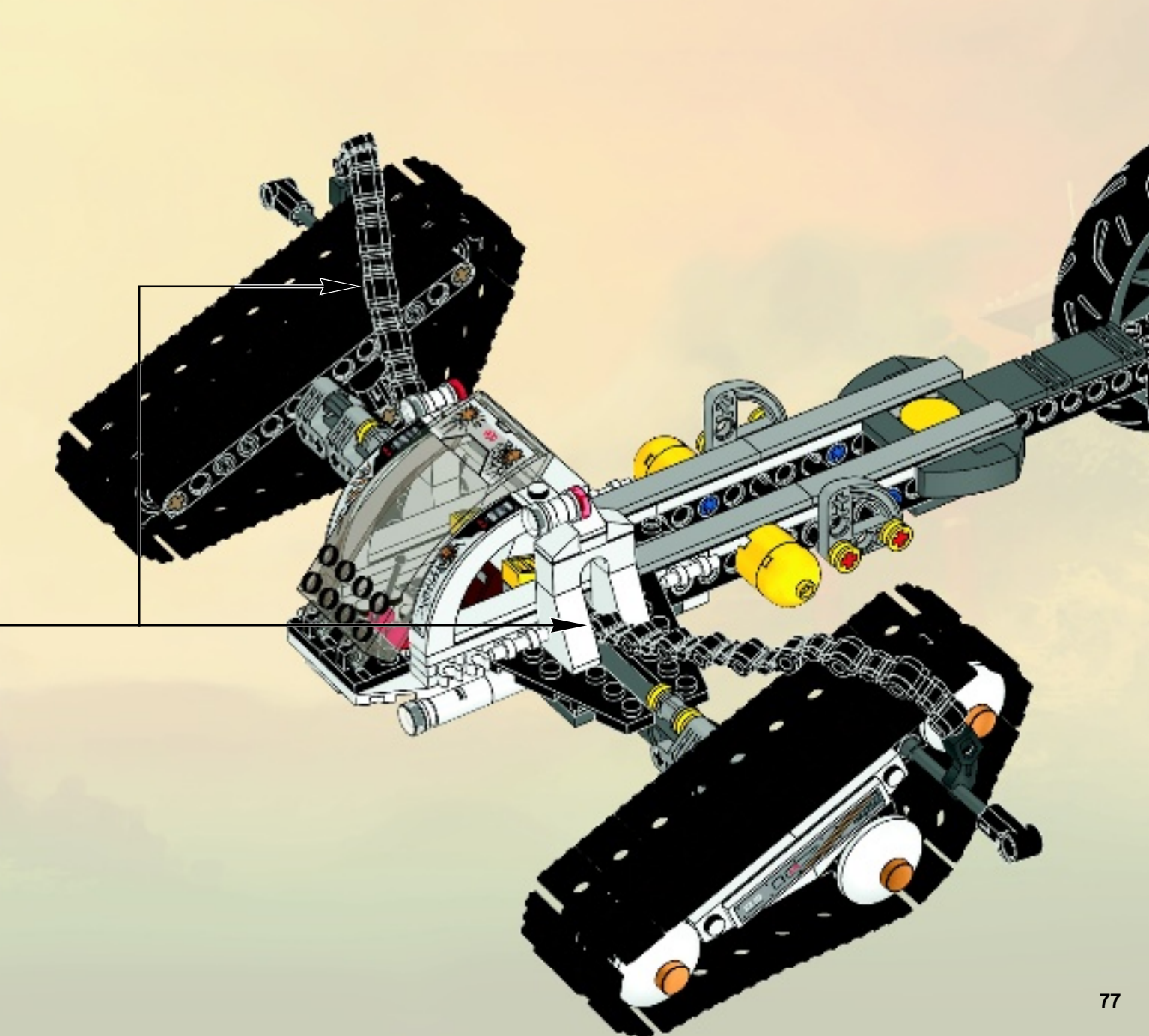

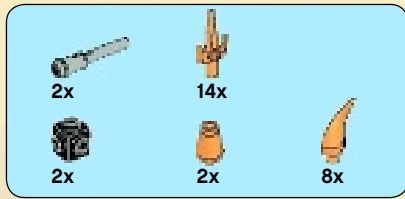

16

1



2



3



2x

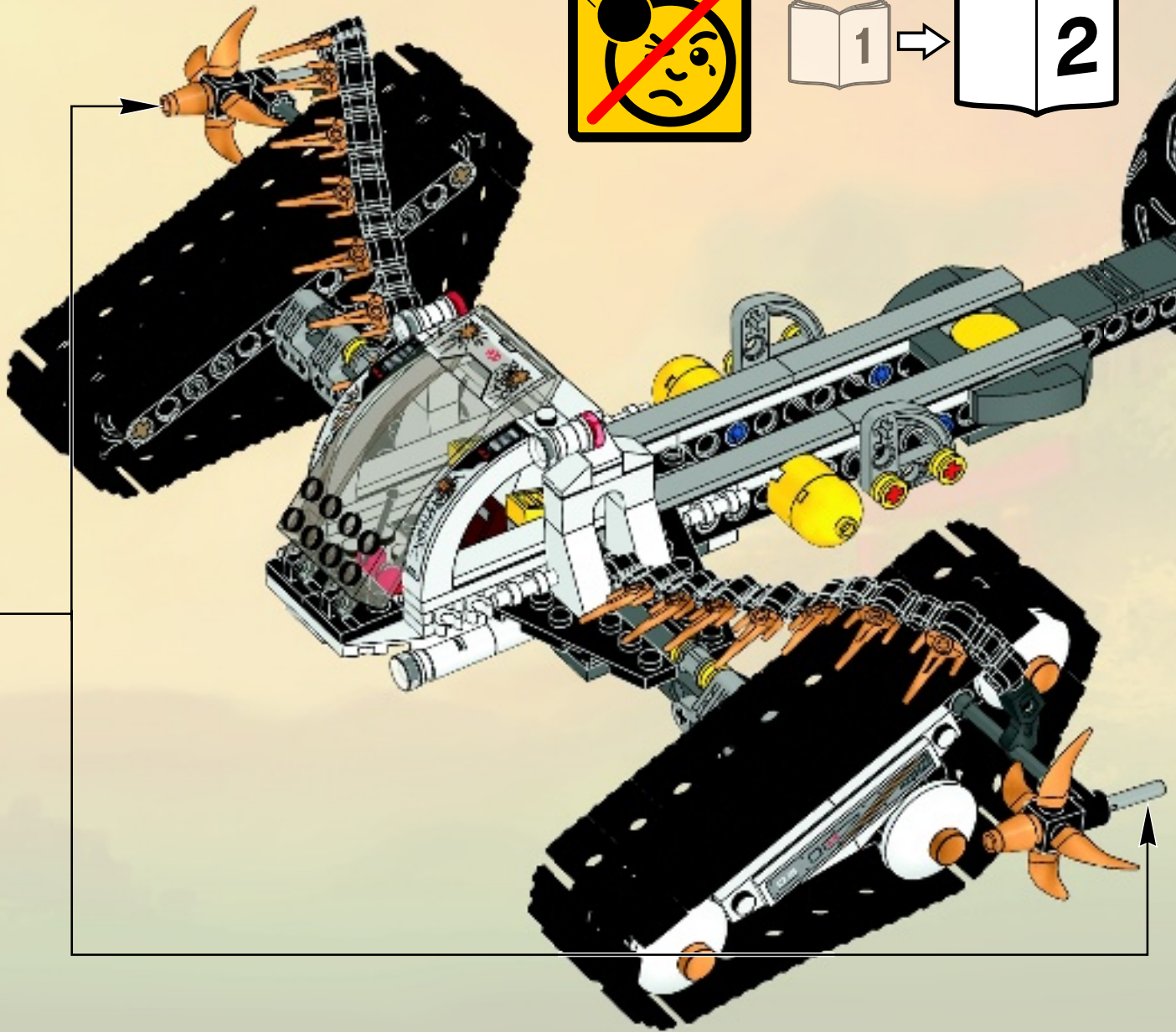



www.LEGOclub.com



LEGO Club Email

LEGO club

FREE! GRATIS! GRATUIT!



LEGO Club Magazine

 LEGO.com

SIGN UP ONLINE!

www.LEGOclub.com

LEGO and the LEGO logo are trademarks of the LEGO Group. ©2012 The LEGO Group. 6045351



00800 5346 5555*



1-866-534-6258 • 1-877-518-5346

US & Canada only

Canada seulement

- * Freephone. Mobile charges may apply.
- * Numéro sans frais. Des frais peuvent s'appliquer avec les téléphones cellulaires.
- * Gebührenfrei. Kosten für Anrufe aus Mobilfunknetzen können abweichen.
- * Gratis telefonnummer vanaf vaste lijn.
- * Det er et gratis nummer, når du ringer fra fasttelefon.
- * Det är gratis, när du ringer från en fast telefon.
- * Numéro sans frais. Des frais peuvent s'appliquer avec les téléphones portables.