



STAR WARS

9498



1

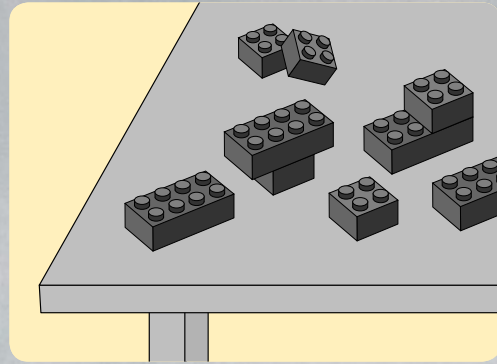
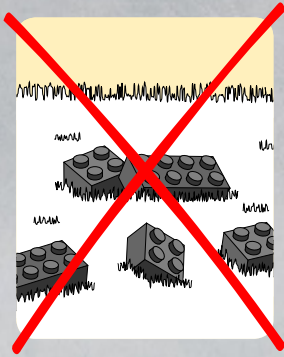

2

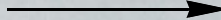

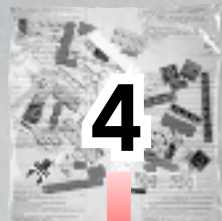
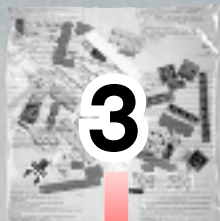
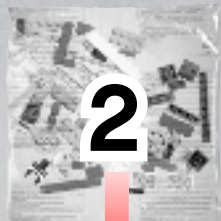



2x



1

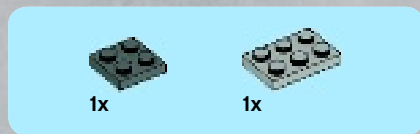
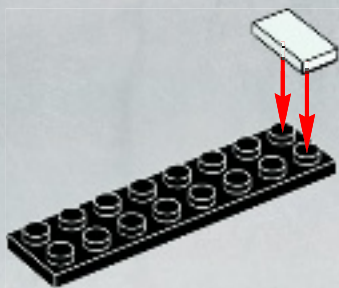

2

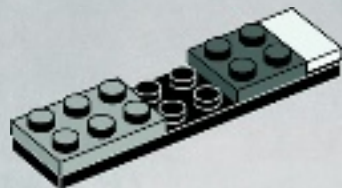



1x



2x

3

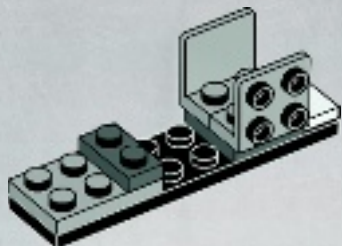

1x



2x

4

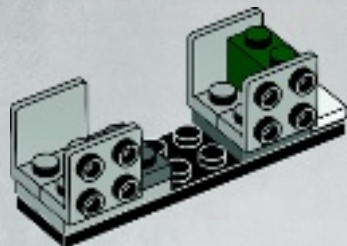



1x



1x



1x

5

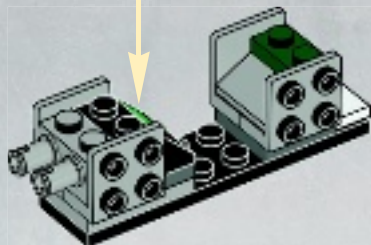

1x



1x

6

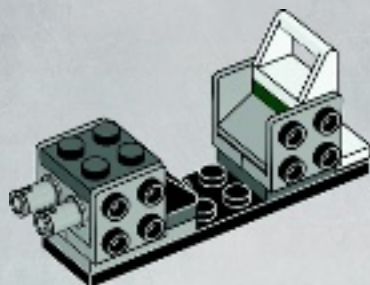

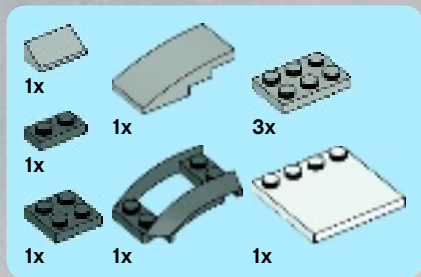

7

1

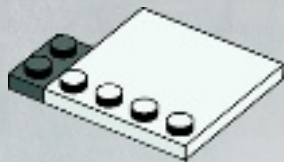

2

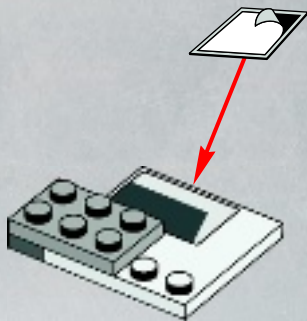

3

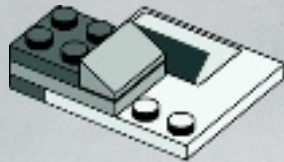

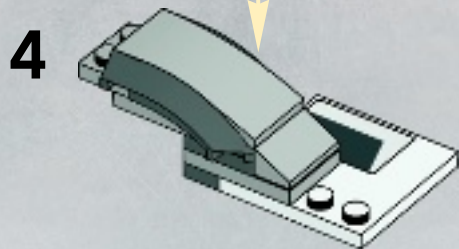
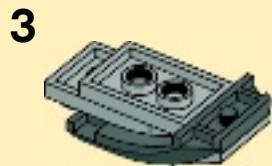
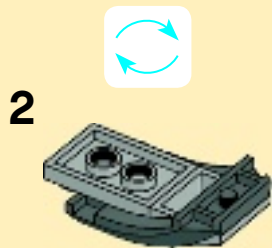
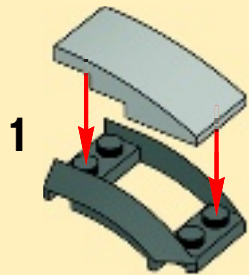

5

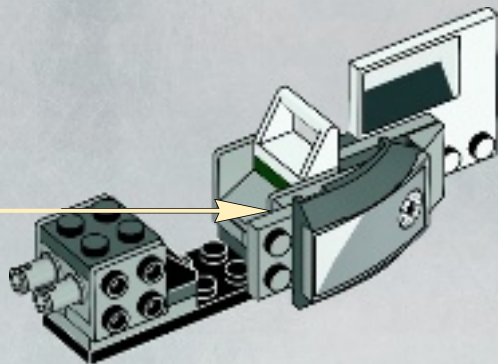
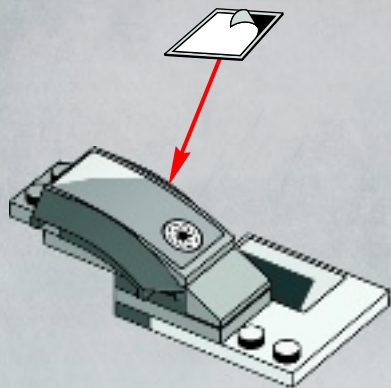

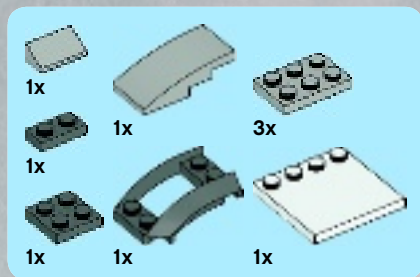

8

1

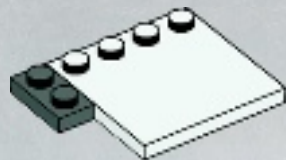

2

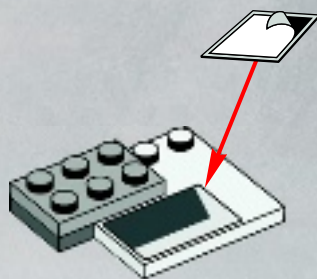

3

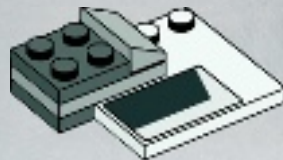

1

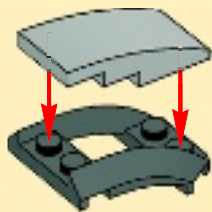

2



3

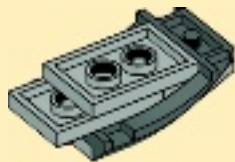

4



5

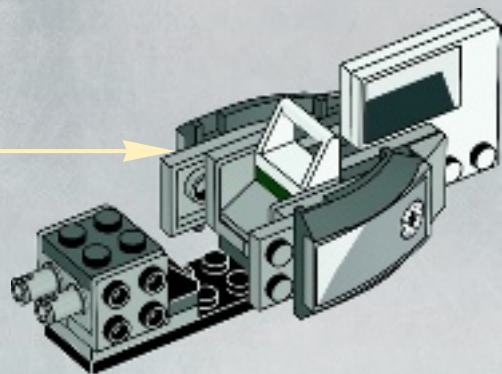
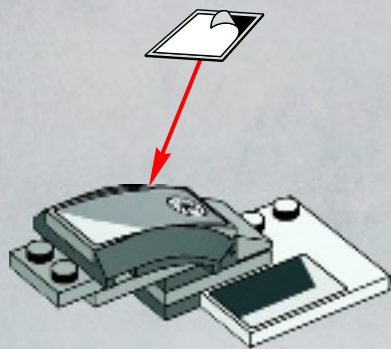



9

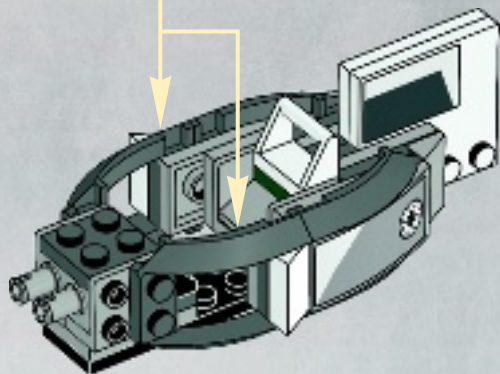
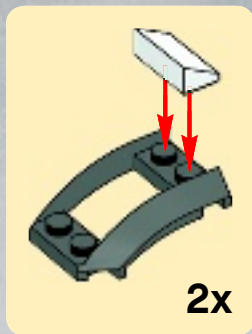



2x

10

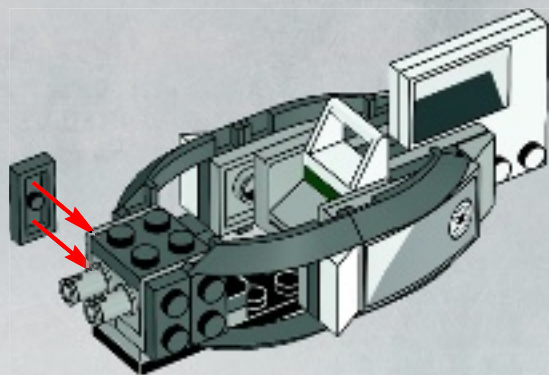

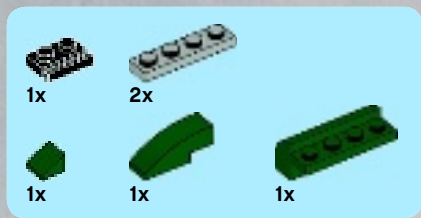

11

1

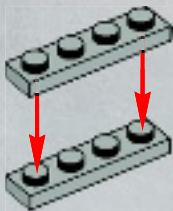

2

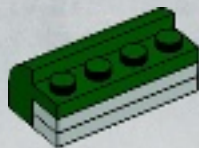

3

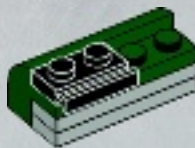

4

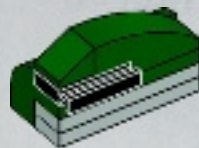

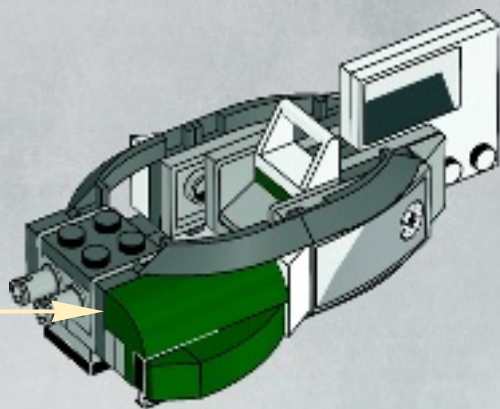

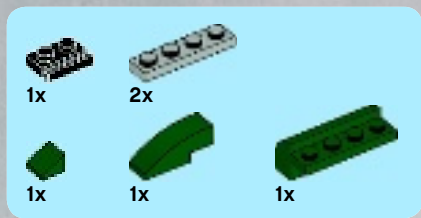

12

1

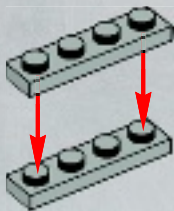

2



3



4



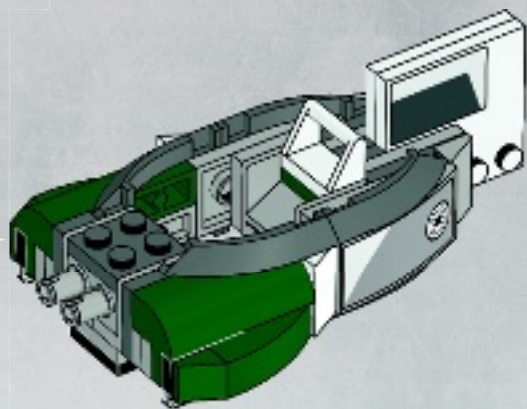



2x

13

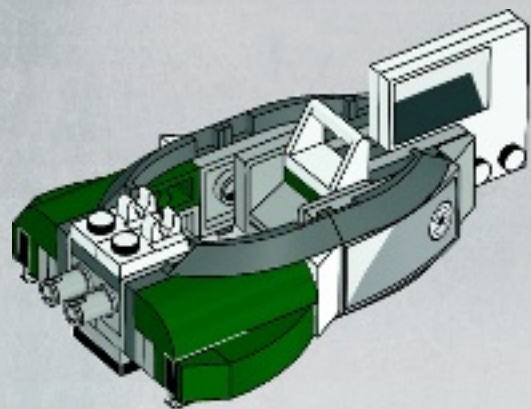

1x



1x

14

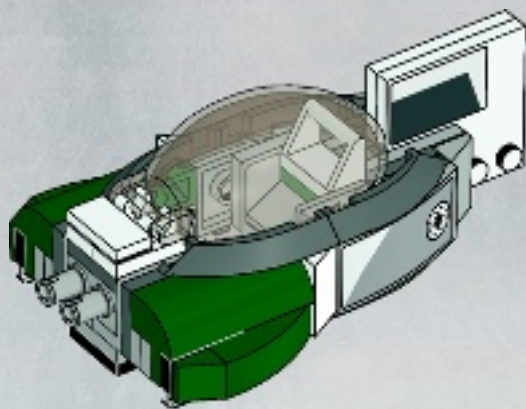



1x



1x

1

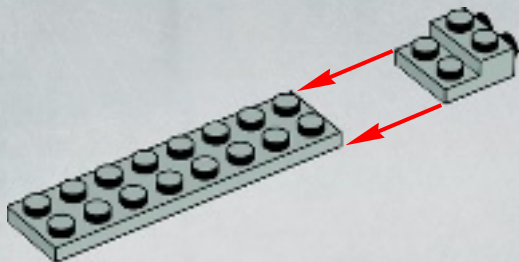

1x



1x

2

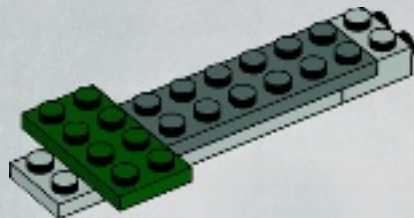



2x



1x

3



2x

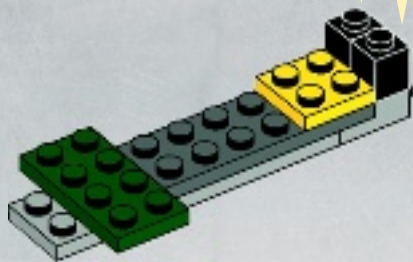

1x



1x

4

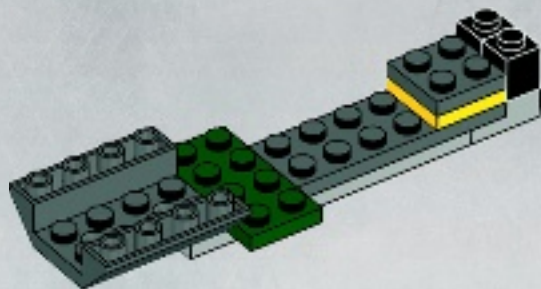

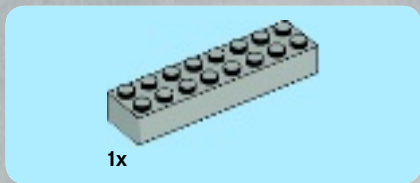

5

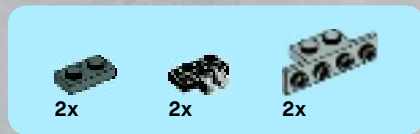
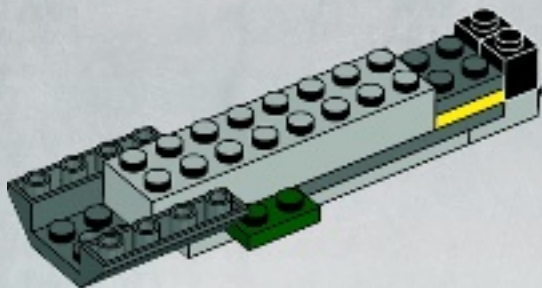

6

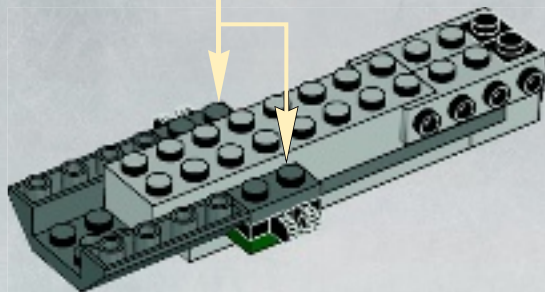
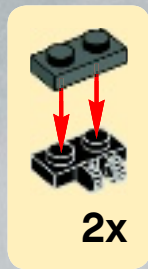



2x



2x

7

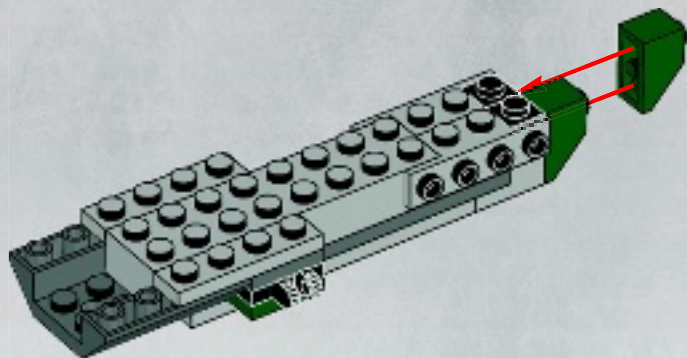



1x



1x

8

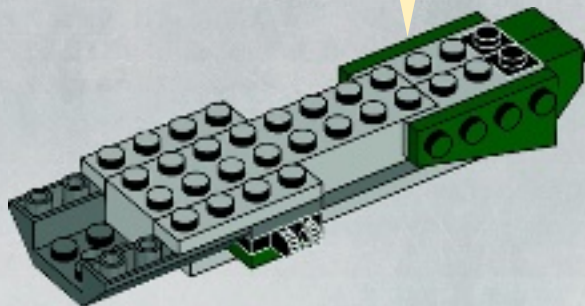



1x



1x



1x

1

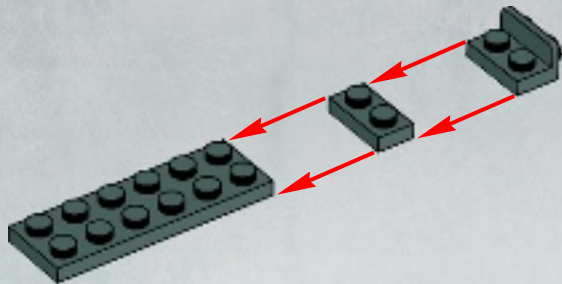

1x

2

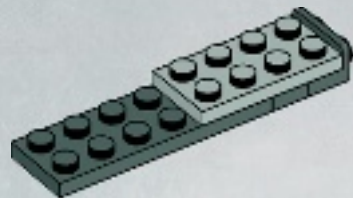



4x

3

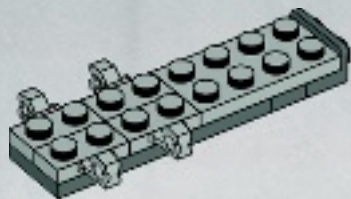

2x

4

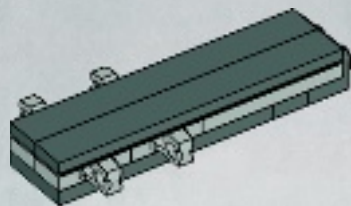

9

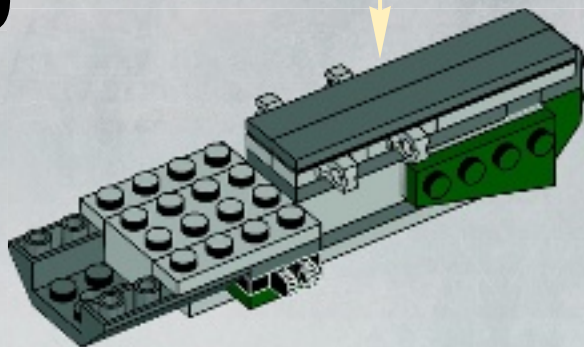



10

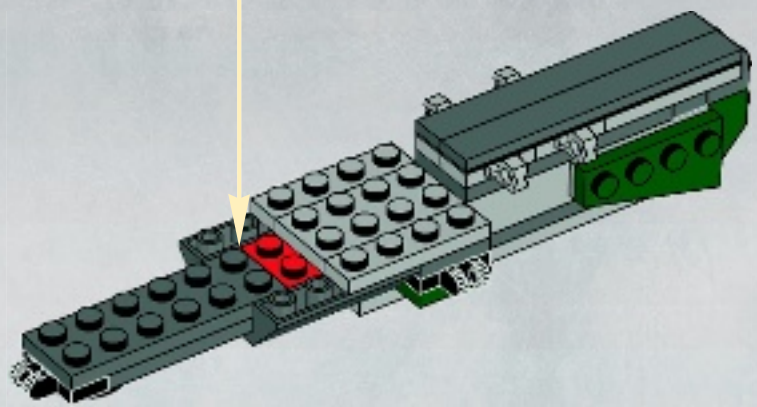

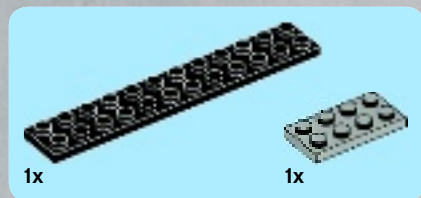

11

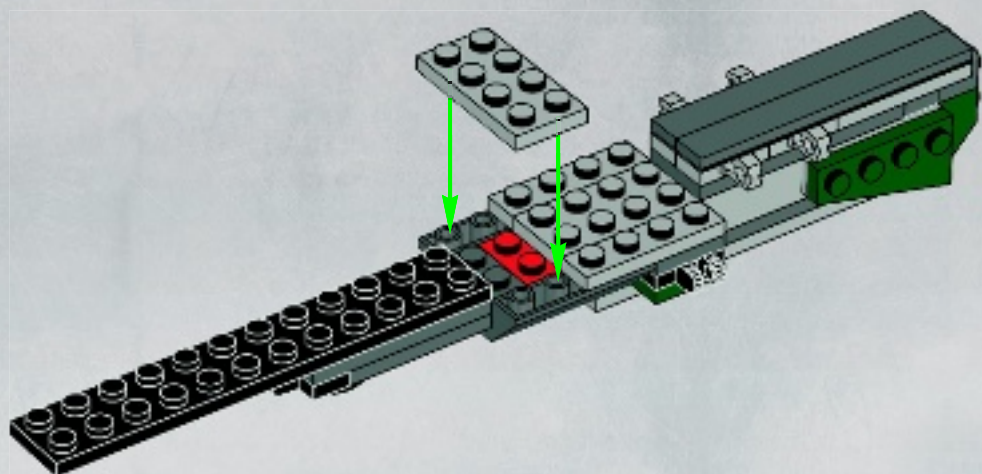



12

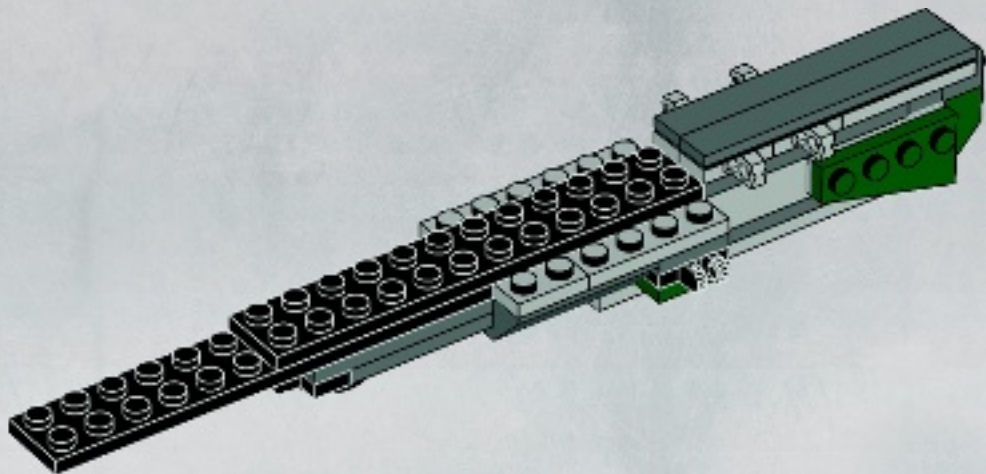



2x



1x



2x

13

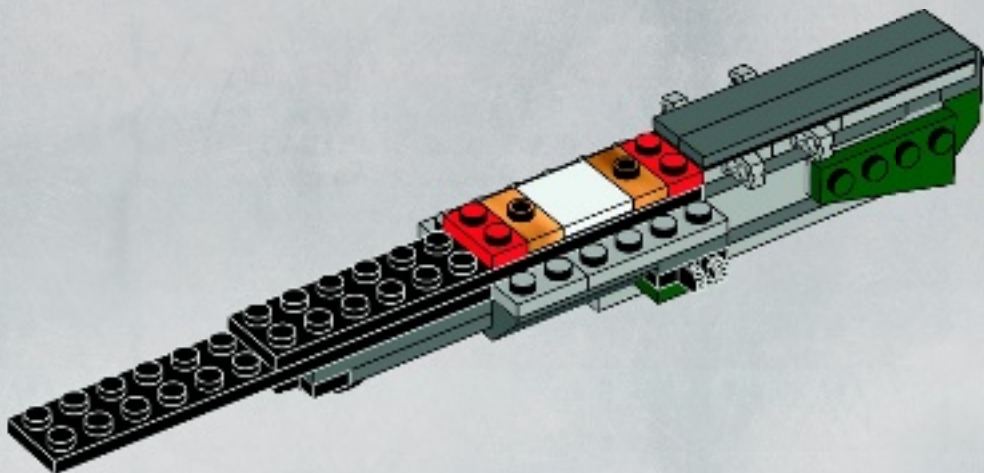



4x

14

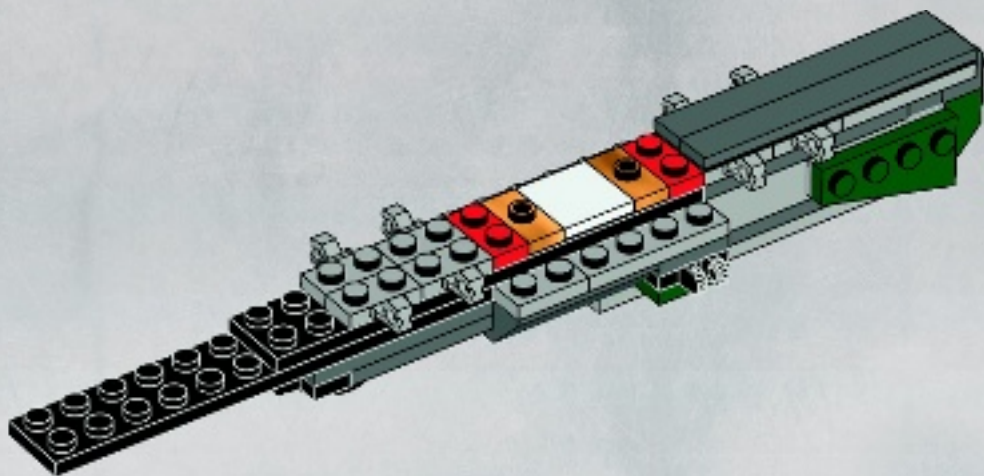



1x



2x

15

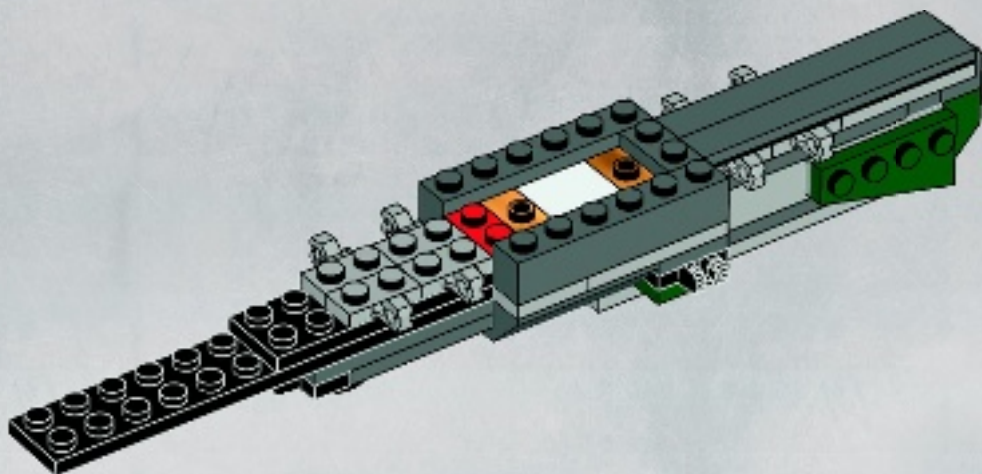

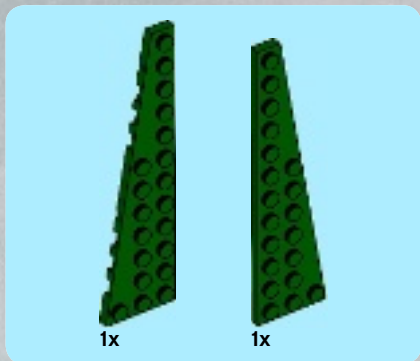

1

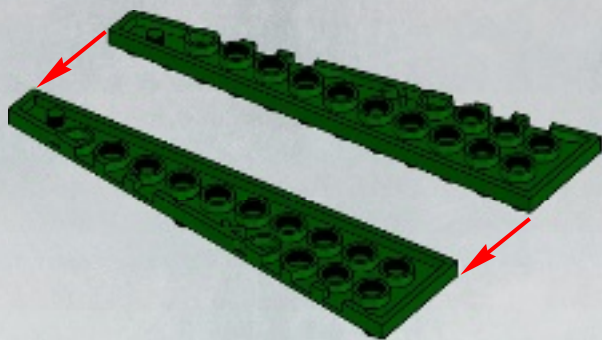



1x



1x

2

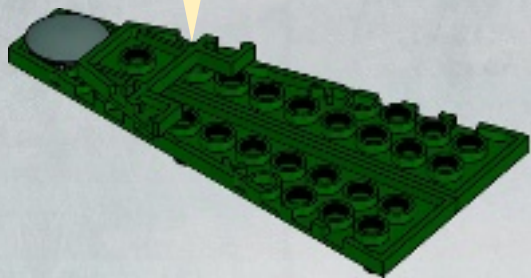

1x



1x



1x

3

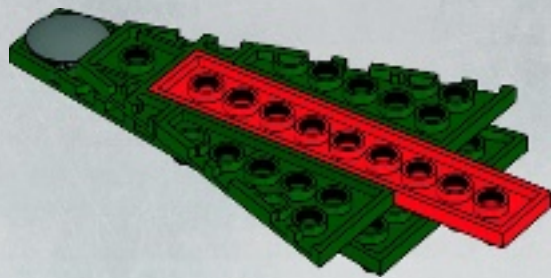



2x

4

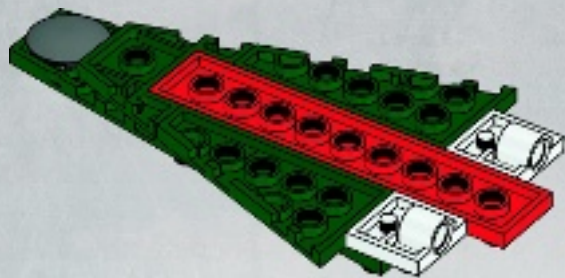

1x



1x

5

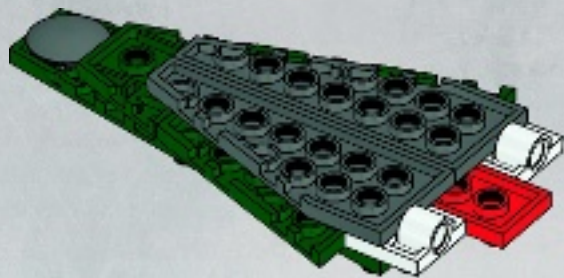



2x

6

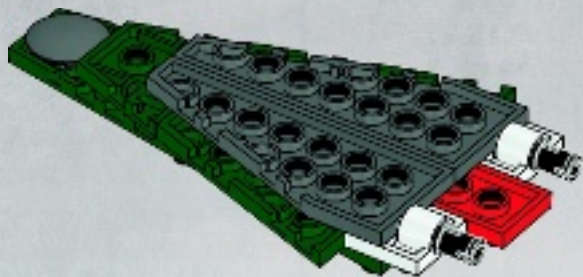

1x

7

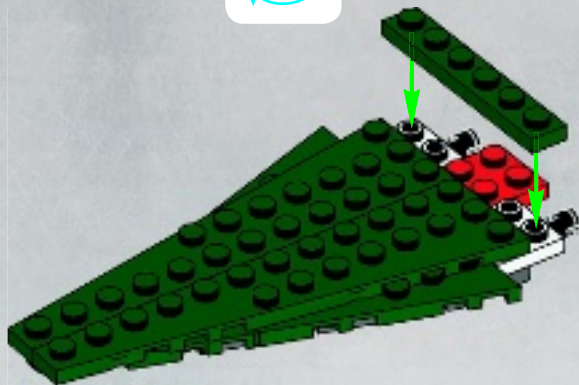

16

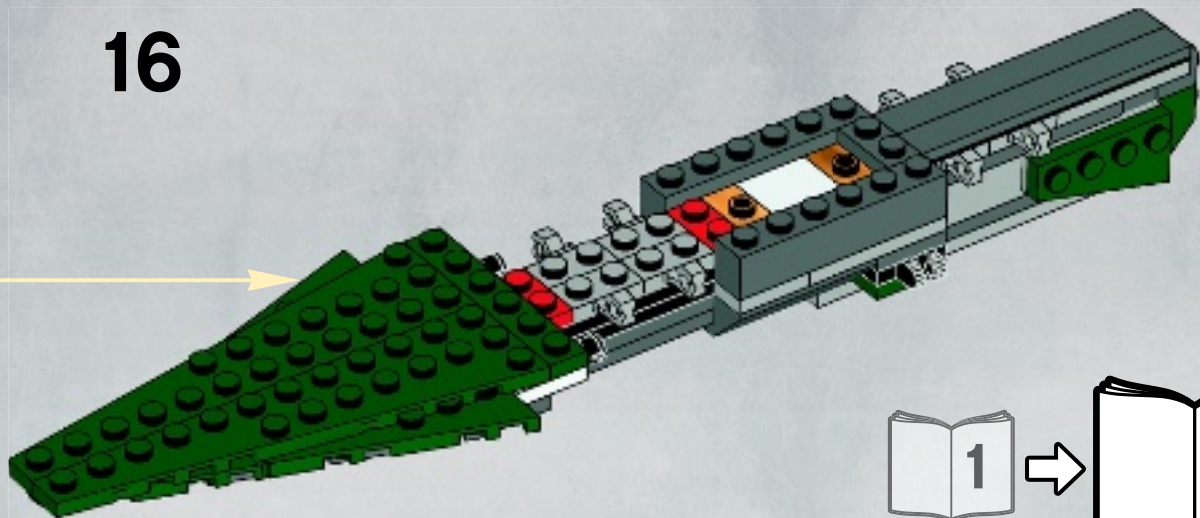



WIN!

Go to www.LEGOsurvey.com/product to fill out a survey for a chance to win a cool LEGO® Product.

No purchase necessary.

Open to all residents where not prohibited.



www.LEGOsurvey.com/product

GEWINNE!

Nimm an der Umfrage auf www.LEGOsurvey.com/product teil und hab die Chance ein cooles LEGO® Produkt zu gewinnen!

Die Teilnahme am Gewinnspiel führt zu keinerlei Kaufverpflichtungen. Teilnahme in allen nicht ausgeschlossenen Ländern möglich.

WIN!

Ga naar www.LEGOsurvey.com/product, vul een enquêteformulier in en maak kans op een cool LEGO® product.

Geen aankoopverplichting. Iedereen mag deelnemen, uitgezonderd ingezetenden van landen waar een enquêteverbod geldt.

GAGNE!

Visite www.LEGOsurvey.com/product pour répondre à un questionnaire et avoir une chance de gagner un produit LEGO® très cool!

Aucune obligation d'achat. Ouvert à tous les résidents des pays autorisés.

当てよう!

www.LEGOsurvey.com/product にアクセスして、アンケートにご記入ください。当選者にはレゴ®製品を差し上げます。

お買い上げの必要はありません。禁止されていない限り、すべての皆様にご利用いただけます。



www.LEGO.com

6016866

LEGO and the LEGO logo are trademarks of the LEGO Group. ©2012 The LEGO Group.
© 2012 Lucasfilm Ltd. & TM. All rights reserved.