

**MEGA
BLOKS**

WORLD WARCRAFT

1



91016 | DEATHWING'S STORMWIND ASSAULT • ASALTO DEATHWING'S STORMWIND • ASSAULT DE DEATHWING SUR STORMWIND
DEATHWING'S STORMWIND ANGRIF • DEATHWING'S STORMWIND-AANVAL • ASSALTO MORTALE A TEMPESTA • ASALTO DEATHWING'S STORMWIND

COLLECT & CUSTOMIZE! / ¡COLECCIONA Y PERSONALIZA! / COLLECTIONNE & PERSONNALISE! / SAMMELN & ÄNDERN! / SPAAR & MAAK ALLES OP JOUW MANIER! / COLETE E PERSONALIZE! / COLLEZIONA E PERSONALIZZA!



TANAVAR
91025



DARKHOWL
91014



FLINT
91018



DRAGATH
91025



SCARBACK
91020



VALOREN
91004



MYTHRIN
91016



GRAVEN
91021



BARTON
91016



RAGEROCK
91003



LIGHTHOOF
91014



SEVERIN
91016



IRNOAK
91002



VARIAN WRYNN
91016



COLTON
91001



ARTHAS
91008



KRAZZLE
91014



PITZ
91019



MARKOV
91026

VOIDWALKER



INCLUDES SECRET LOOT!
¡INCLUYE EL BOTÍN SECRETO!
COMPRENDES TRESORS SECRETS!
(MARKOV GAMING BUSTE! / REKAT DE GAMING BUSTE!
CONTIENE CAVALIERE DELLA MORTE, NON MORTO
INCLUI DISCONDIR SAGHE SECHITO.



CHOOSE YOUR SIDE! / ¡ESCOJE TU LADO! / CHOISIS TON ALLÉGEANCE! / SUCHE DEINE SEITE AUS! / BEPAAL AAN WELKE KANT JIJ STAAT! / SCEGLI LA TUA POSIZIONE! / ESCOLHA SEU LADO!

warcraft.megabloks.com



COLLECT & CUSTOMIZE! / COLECCIONA Y PERSONALIZA!
 COLLECTIONNE & PERSONNALISE! / SAMMELN & ÄNDERN!
 SPAAR & MAAK ALLES OP JOUW MANIER!
 COLLEZIONA E PERSONALIZZA! / COL ETE E PERSONALIZE!





1

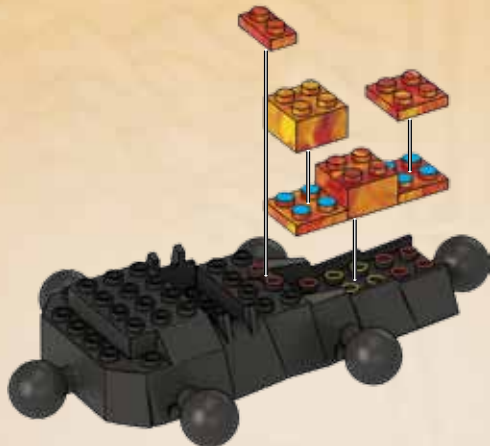

2

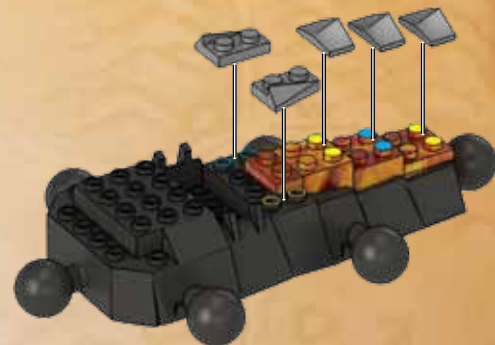

3



4



1x

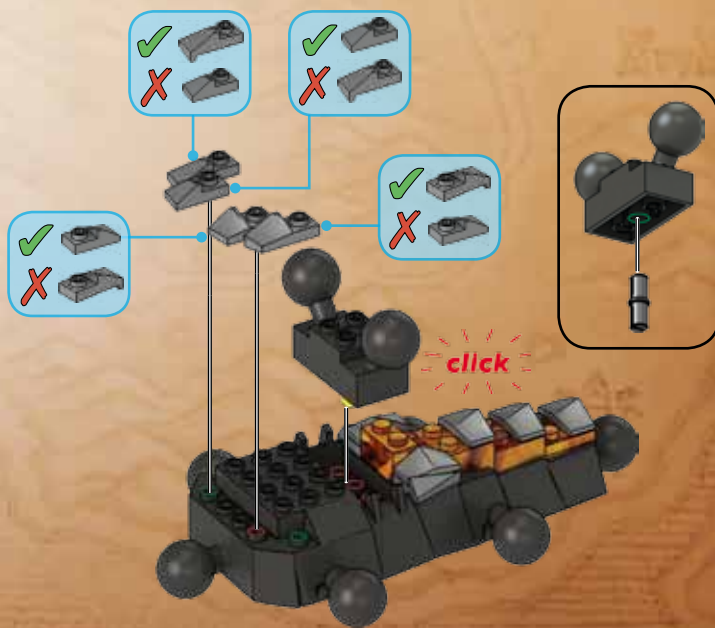

5

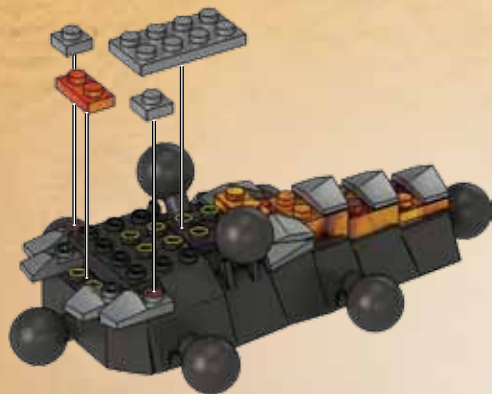

6

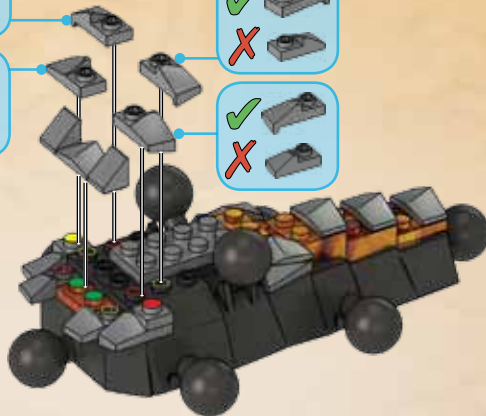
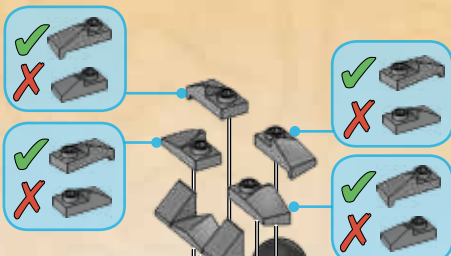

7

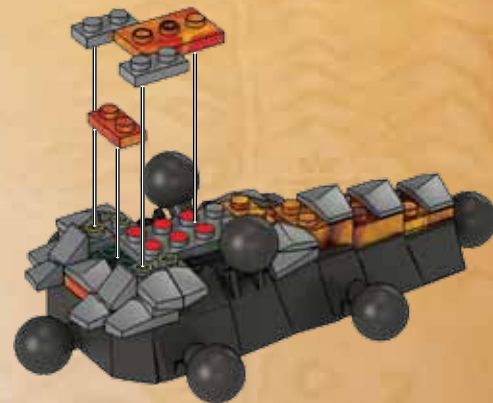

8

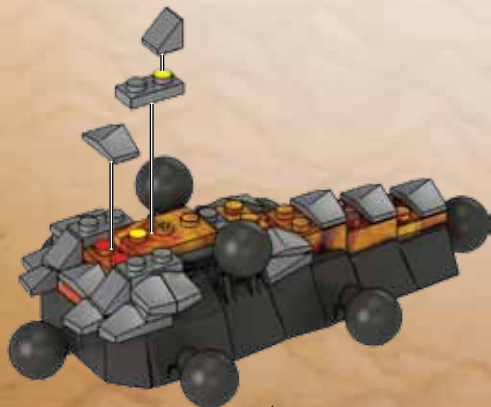

1

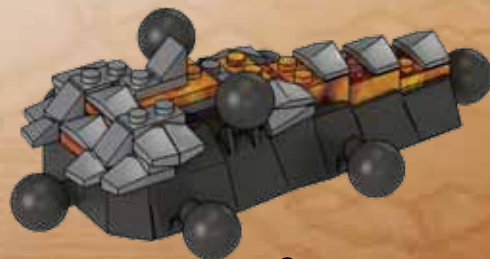

2

9

1x 2x 1x

1x

10

1x 4x

1x 1x

11

2x

1x 4x

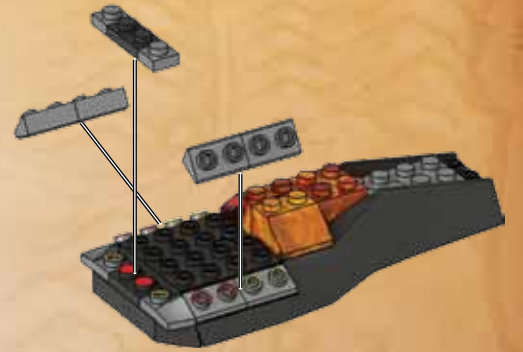
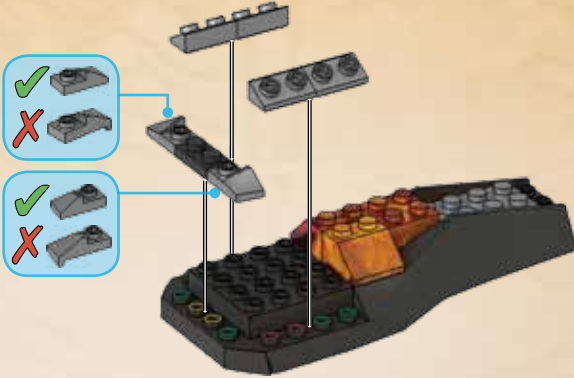
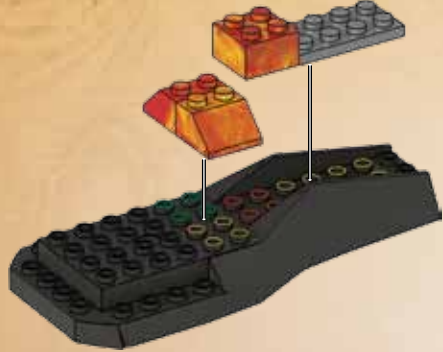

12

1x 1x

4x 2x

13

1x 1x

14

2x 4x 1x 1x 2x

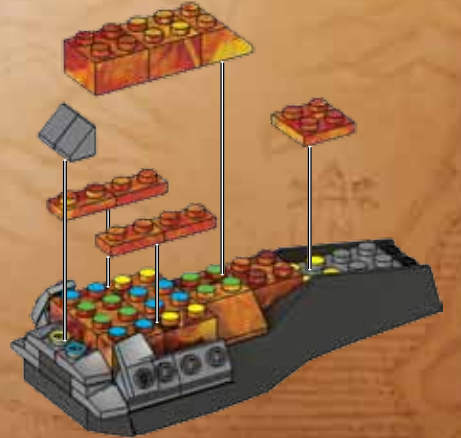
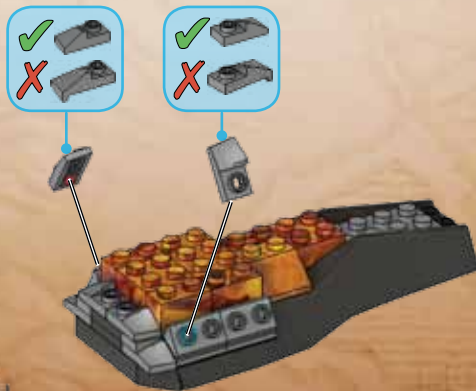
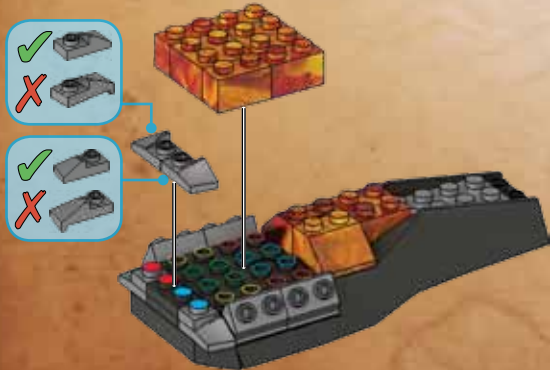

15

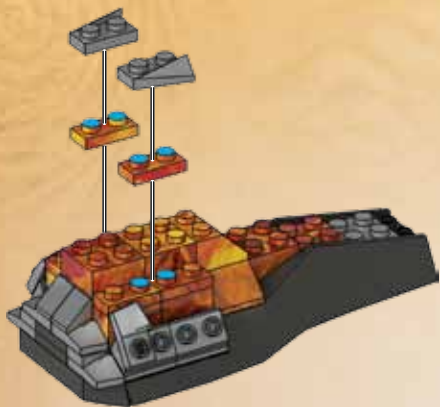

16



1



2

17

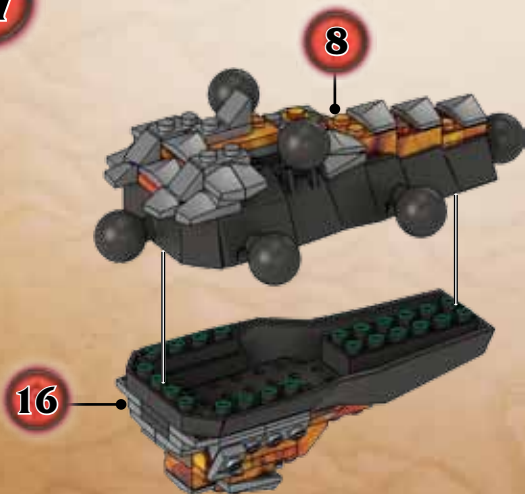

1

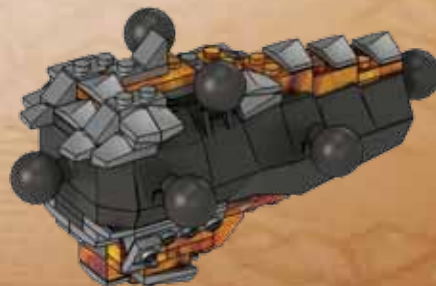

2

18

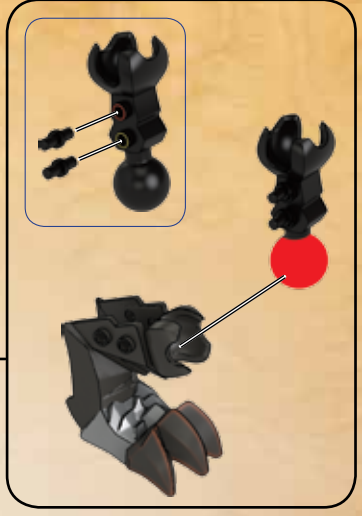
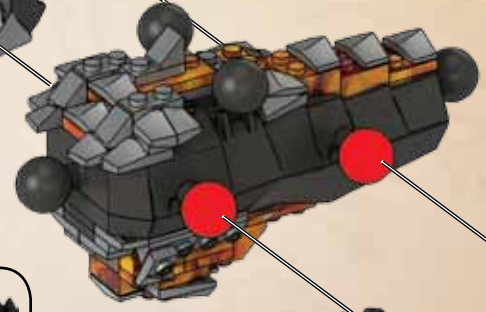
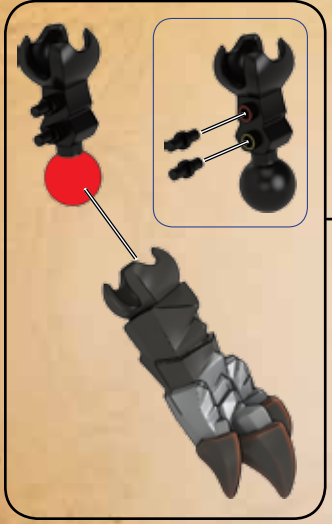

19

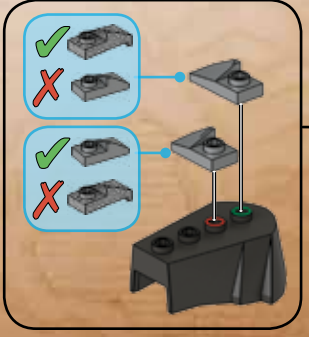
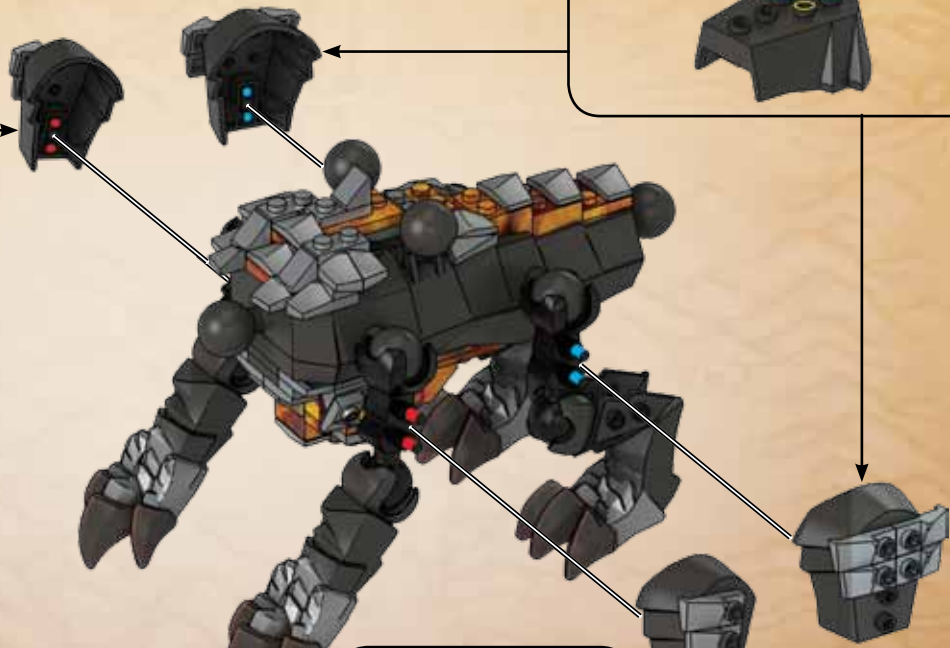
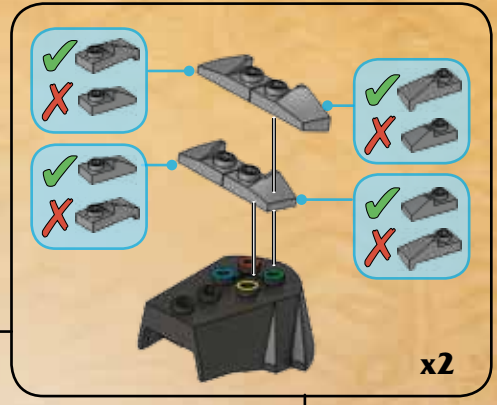
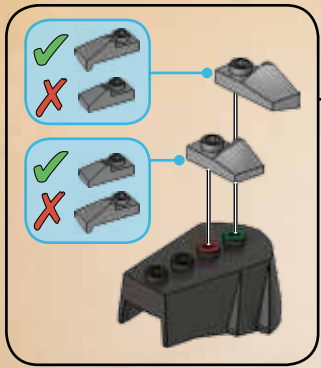

20

2x 1x

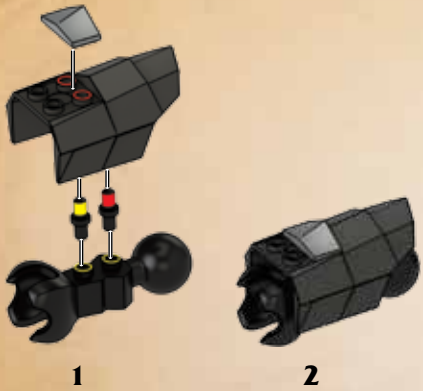

21

1x 2x



22

1x 1x 1x 1x



23

1x



24



25



26

- 2x [Small grey piece]
- 2x [Grey plate]
- 1x [Grey plate]
- 1x [Grey plate]

- 1x [Red and black wing piece]
- 1x [Grey plate]
- 1x [Black and grey piece]

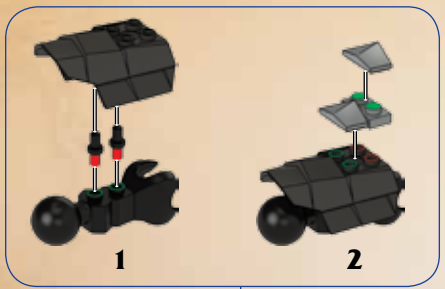





1

3x 2x
2x 1x

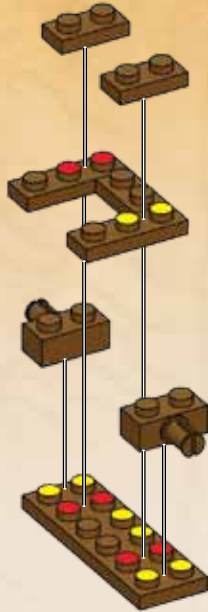

2

2x 2x

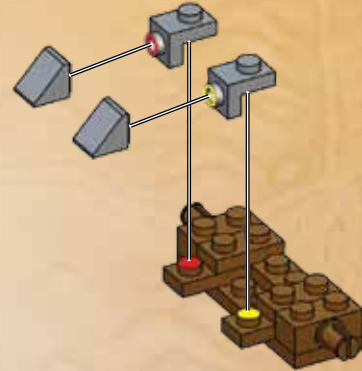

3

2x 1x
1x

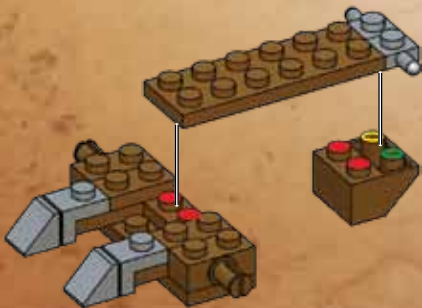

4

1x 1x
1x

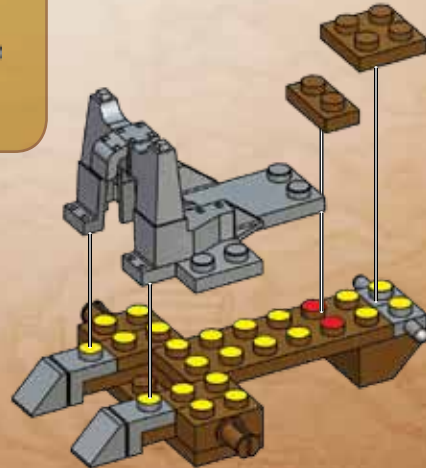

5

2x

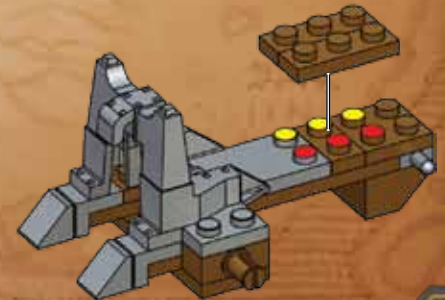

6



2x



1x

click

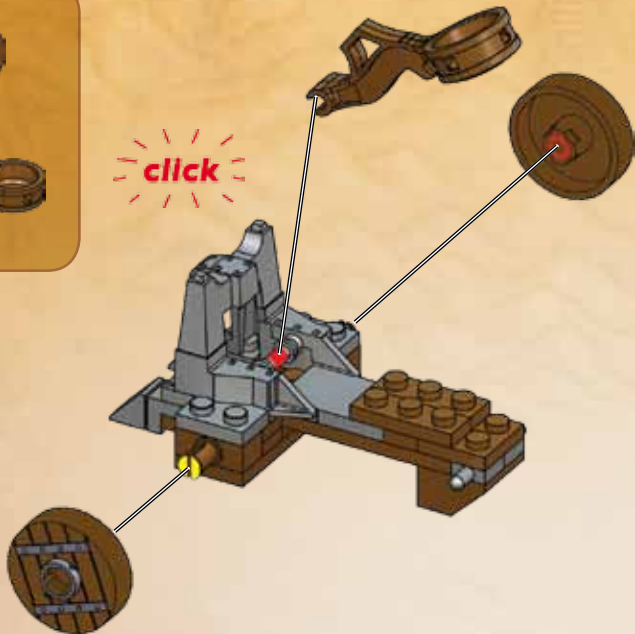

7



1x

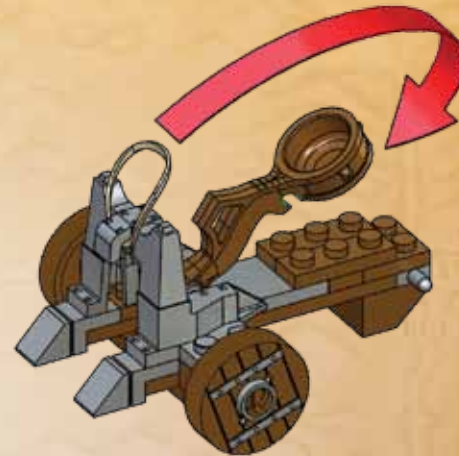

8



1x



EN CAUTION ! Do not aim at eyes or face.

ES ¡ ADVERTENCIA ! NO dirigir nunca los proyectiles hacia los ojos o la cara.

FR ATTENTION ! Ne pas viser les yeux ou le visage.

DE VORSICHT ! Nicht auf das Gesicht oder die Augen richten.

NL LET OP ! Niet op ogen of gezicht richten.

DA ADVARSEL ! Peg ikke i retning af øjne eller ansigt.

EL ΠΡΟΣΟΧΗ ! Να μην σκοπεύετε προς τα μάτια ή το πρόσωπο.

FI VARO ! Älä tähtää silmiin tai kasvoihin.

IT Attenzione ! Non puntare verso gli occhi o il viso.

NO FORSIKTIG ! Sikht ikke mot øyne eller ansikt.

PT ATENÇÃO ! Não apontar para os olhos ou o rosto.

SV VAR FÖRSIKTIG ! Rikta inte med ögon eller ansikte.

JA 注意 ! 目や顔に使用しないで下さい。

ZH 警告 ! 不要对准眼睛或脸。

AR تنبيه ! لا توجه للعينين أو الوجه

Use only the projectile included with this toy.

Utilizar solamente el proyectil incluido con el juguete.

Utiliser seulement le projectile fourni avec le jouet.

Nur das mit dem Spielzeug mitgelieferte Projektil verwenden.

Alleen het met het speelgoed bijgeleverde projectiel gebruiken.

Utilizzare soltanto il proiettile fornito con questo giocattolo.

Usar somente o projétil incluído com este brinquedo.

استخدم فقط القذيفة المرافقة لهذه اللعبة

- | | | | | | | | | |
|------------------|-------------------|-------------------|-------------------|------------------|-------------------|------------------|-------------------|-------------------|
| 10x
M1113ZD | 2x
MA04428AGV | 2x
AM15481AGV | 2x
MA11101AQW | 1x
AM18666MM | 1x
AS9101615 | 4x
AM72386AQW | 1x
MA03773MY | 4x
MA1314MY |
| 4x
AM04637X | 8x
MA04428AQW | 2x
AM15480AGV | 2x
MA11101MY | 1x
AM18665MM | 1x
AS9101618 | 4x
AM03773AMZ | 6x
MA1314AQW | 6x
MA1314AQW |
| 3x
AM19617MM | 4x
MA1086MM | 1x
AM09946KM | 2x
MA1101MM | 12x
MA0948B | 2x
AM16450B | 7x
AM09023AMZ | 4x
AM03329MM | 12x
MA09593MM |
| 14x
AM17003KM | 4x
MA1086AQW | 12x
AM17131AGV | 5x
AM09013AMZ | 8x
MA0948MM | 4x
MA1323MM | 2x
MA09023MM | 11x
MA03773MM | 13x
MA09593AQW |
| 6x
MA03328AQW | 16x
MA1086AQW | 26x
MA09013MM | 1x
MA1154MY | 1x
MA1154MY | 2x
AM16384MM | 10x
AM03157MM | 4x
MA1146AQW | 2x
MA07475MM |
| 2x
MA03328BTN | 1x
AM16680KM | 8x
AM18272AGV | 67x
MA09013AQW | 3x
AM10273AMZ | 4x
MA09023AQW | 4x
MA09023AQW | 10x
MA03773AQW | 2x
MA09292BTN |
| 4x
AM03328KN | 4x
MA09393AGV | 1x
AM17115AGV | 6x
AM17502MM | 12x
AM16641B | 30x
AM16384AQW | 1x
AM17509AMZ | 1x
AM17509AMZ | 4x
MA09292AQW |
| 4x
MA03328AGV | 8x
MA09393AQW | 8x
AM72496AGV | 14x
AM02929MM | 16x
AM16641MM | 15x
AM09621MM | 4x
AM18715MM | 2x
MA03772MM | 3x
MA09292MM |
| 6x
MA03328MM | 25x
MA09393MM | 8x
AM72497GV | 12x
MA1417MM | 1x
MA1154MM | 2x
AM07630MM | 2x
MA03873MM | 14x
MA09493AQW | 4x
MA09292MM |
| 2x
MA1140AGV | 2x
MA09393KM | 8x
AM72494AGV | 2x
MA04430MM | 6x
MA1154AQW | 24x
MA1087AQW | 4x
MA09033AQW | 8x
MA09493MM | 2x
AM18298MM |
| 9x
MA15258AGV | 11x
AM09393AMZ | 8x
AM72495AGV | 2x
MA1322MM | 4x
AM17153MM | 5x
MA1313AQW | 4x
MA1139AQW | 2x
MA09493AGV | 4x
AM18275MM |
| 2x
MA15258AQW | 2x
MA15258MM | 2x
MA09393MY | 12x
MA1417AQW | 2x
AM15968MM | | | | |
| 1x
AM01910BOR | 6x
MA07590B | 4x
MA1322B | | | | | | |



2x
AM18593KN



4x
AM01887KN



1x
AS9101621



1x
AS9101623



1x
AS9101622



2x
AS9101626



1x
AS9101619

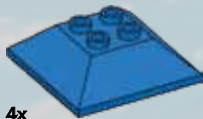

4x
AM72385B



1x
AM09598MY



2x
AS9102516



4x
AM18778MM



8x
AS9102610

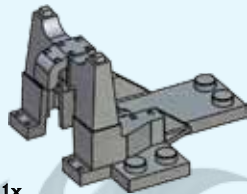

1x
AM09599AGV



2x
MA1480MY



2x
MA1480BTN



5x
MA1480MM



5x
MA08483MM



3x
MA09923BTN



2x
MA1172BTN



1x
AM09924BTN



4x
AM72400MM



4x
AM03861MM



2x
AM03861AQW



1x
AM18566BTN

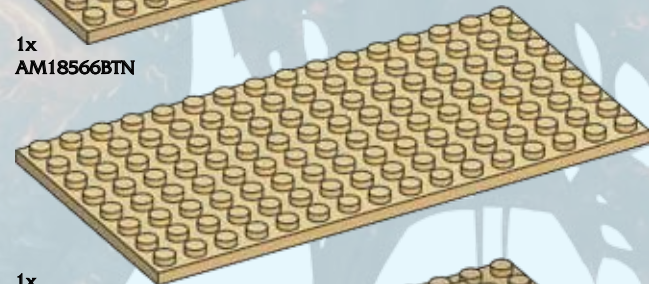

1x
AM18567BTN

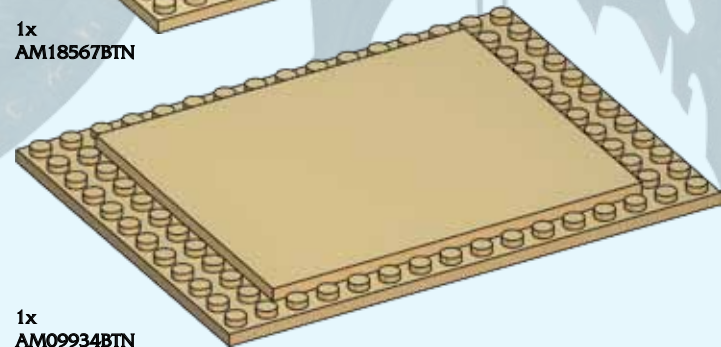

1x
AM09934BTN

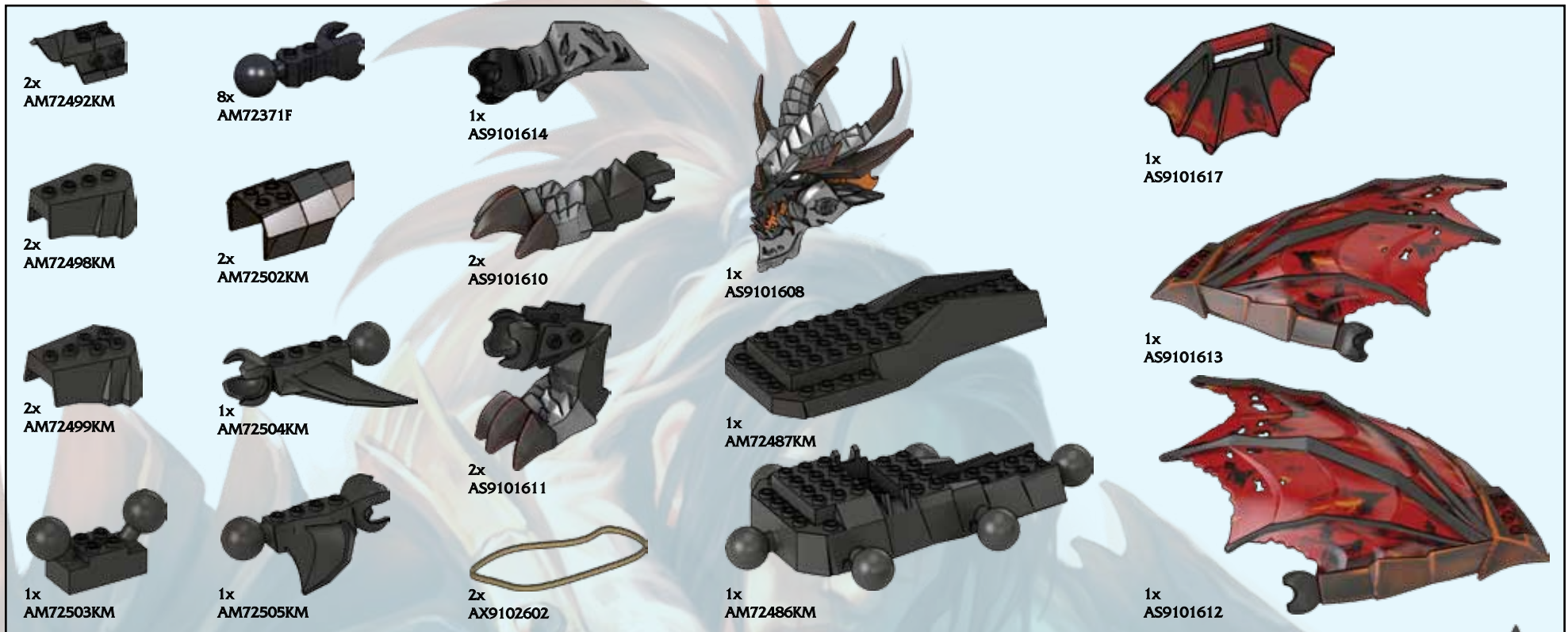

- EN** Please read these instructions carefully before first use and keep them for future reference.
ES Leer estas instrucciones cuidadosamente antes de la primera utilización y guardarlas para referencia futura.
FR Il est recommandé de lire attentivement ce feuillet avant la première utilisation et de le conserver pour référence future.
DE Die Gebrauchsanleitung bitte durchlesen und aufbewahren.
NL Wij raden u aan deze handleiding zorgvuldig te lezen en te bewaren voor eventuele raadpleging op een later tijdstip.
DA Vær venlig at læse disse instruktioner omhyggeligt inden ibrugtagen og opbevar dem til fremtidigt brug.
EL Διαβάστε αυτές τις οδηγίες προσεκτικά πριν χρησιμοποιήσετε το προϊόν για πρώτη φορά και φυλάξτε τις για μελλοντική αναφορά.
FI Lue nämä ohjeet huolellisesti ennen ensimmäistä käyttöä ja säilytä ne myöhempää tarvetta varten.
IT Leggere le istruzioni prima di cominciare ad usare il gioco e conservarle per referenze future.
NO Les disse instruksjonene nøye før første gangs bruk, og ta vare på dem for fremtidige oppslag.
PT Leia as instruções antes do primeiro uso e guarde-as para futura referência.
SV Läs noggrant igenom dessa instruktioner innan du använder produkten för första gången och spara dem för ev. framtida frågor.
JA 初めてご使用前に、この説明書をよくお読みください。また、本書は将来いつでも参照できるように保管してください。
ZH 请在初次使用前仔细阅读这些指示，并保留它们以便未来参考。
AR يرجى قراءة هذه التعليمات بدقة قبل البدء بالاستعمال والاحتفاظ بها كمرجع للمستقبل

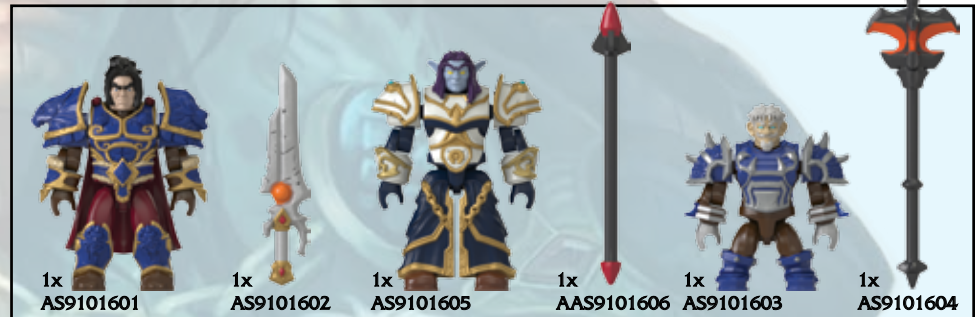

EN ⚠ **WARNING :**
CHOKING HAZARD. - Small parts.
 Not for children under 3 years.

ES ⚠ **ADVERTENCIA :**
RIESGO DE ASFIXIA. - Contiene piezas pequeñas.
 No recomendado para niños menores de 3 años.

FR ⚠ **ATTENTION :**
DANGER D'ÉTOUFFEMENT. - Présence de petits éléments.
 Ne convient pas aux enfants de moins de 3 ans.

DE ⚠ **ACHTUNG :**
ERSTICKUNGSGEFAHR. - Enthält kleine Teile.
 Nicht für Kinder unter 3 Jahren geeignet.

NL ⚠ **WAARSCHUWING :**
VERSTIKKINGSGEVAAR. - Bevat kleine onderdelen.
 Niet geschikt voor kinderen onder de 3 jaar.

DA ⚠ **ADVARSEL :**
FARE FOR KVÆLNING. - Indeholder smådele.
 Ikke til børn under 3 år.

EL ⚠ **ΠΡΟΕΙΔΟΠΟΙΗΣΗ :**
ΚΙΝΔΥΝΟΣ ΠΝΙΓΜΟΥ. - Περιέχει μικρά αντικείμενα.
 Όχι για παιδιά κάτω των 3 ετών.

FI ⚠ **VAROITUS :**
TUKEHTUMISVAARA. - Sisältää pieniä osia.
 Ei alle 3-vuotiaille lapsille.

IT ⚠ **AVVERTENZA :**
PERICOLO DI SOFFOCAMENTO. - Contiene piccole parti.
 Non indicato per bambini sotto i 3 anni.

NO ⚠ **ADVARSEL :**
KVELNINGSFARE. - Inneholder små deler.
 Kun for barn over 3 år.

PT ⚠ **ATENÇÃO :**
PERIGO DE ASFIXIA. - Contém peças pequenas.
 Não é concebido para crianças de menos de 3 anos.

SV ⚠ **VARNING :**
KVÄVNINGSRISK. - Innehåller små delar.
 Inte för barn under 3 år.

JA ⚠ **警告 :**
 のどにつまる危険 小さな部品が含まれています
 3歳以下の子供には与えないで下さい。

ZH ⚠ **警告 :**
 噎住危险 包含有小部件
 不适合3岁以下的小孩玩。

AR ⚠ **تحذير :**
 خطر الاختناق - قطع صغيرة.
 غير صالحة للأطفال أقل من 3 سنوات.

WARNING ! **ACHTUNG !** **VAROITUS !** **ATENÇÃO !** **警告 !**
ATTENTION ! **WAARSCHUWING !** **ΠΡΟΕΙΔΟΠΟΙΗΣΗ !** **ADVARSEL !** **警告 !**
ADVERTENCIA ! **AVVERTENZA !** **ADVARSEL !** **VARNING !** **تحذير !**



MEGA
BLOKS

WORLD WARCRAFT

BUILD THE BATTLE!
¡CONSTRUYE LA BATALLA!
CONSTRUIS LA BATAILLE!

KAMPF AUFBAUEN! / BOUW DE VELDSLAG!
AVVIA IL COMBATTIMENTO!
CONSTRUA A BATALHA!



MYTHRIN



ARIAN WRINN



BARTON



ALLIANCE CATAPULT
CATAPULTA DE LA ALIANZA
CATAPULTE DE L'ALLIANCE
ALLIANZ-KATAPULT / ALLIANTIEKATAPULT
CATAPULTA DELL'ALLEANZA / CATAPULTA DE ALIANÇA

STORWIND CASTLE



DEATHWING



INCLUDES SECRET LOOT!
¡INCLUYE EL BOTÍN SECRETO!
COMPREND DES TRESORS SECRETS!

TRAGLI CUBRIMI BOTTI / BOTIN DE SEGRETE BOTTI
CONTIENE CANTIERE DELLA SEGRETE NON MORTI

CHOOSE YOUR SIDE! / ¡ESCOJE TU LADO! / CHOISIS TON ALLÉGEANCE!
SUCHE DEINE SEITE AUS! / BEPAAL AAN WELKE KANT JIJ STAAT! / SCEGLI LA TUA POSIZIONE! / ESCOLHA SEU LADO!



warcraft.megabloks.com

MEGA

©2012, MEGA Brands Inc.
© &™ MEGA Brands Inc. Printed in Canada D910161

LICENSED
BLIZZARD
PRODUCT

©2012 Blizzard Entertainment, Inc. All rights reserved. Warcraft, World of Warcraft and Blizzard Entertainment are trademarks and/or registered trademarks of Blizzard Entertainment, Inc., in the U.S. and/or other countries. All other trademarks referenced herein are the properties of their respective owners.